

Simple and Precise Calorimetry Method for Evaluation of Losses in Power Electronic Converters

CIPS 2020, Berlin

Nicolas MARY¹, Cyril BUTTAY², Rémi PERRIN¹, Stefan MOLLOV¹

¹Mitsubishi Electric Research Centre Europe, Rennes, France

²Laboratoire Ampère, Lyon, France

24/03/20

Review of Losses Measurement Techniques

Presentation of the Calorimeter

Performance Evaluation

Measurement of Converter Losses

Conclusions

Review of Losses Measurement Techniques

Presentation of the Calorimeter

Performance Evaluation

Measurement of Converter Losses

Conclusions

The problem with measuring losses

- ▶ **Converters are efficient**

- ▶ 98 – 99 % efficiency common
- ▶ $\frac{P_{in}-P_{out}}{P_{in}}$ very inaccurate as $P_{in} \approx P_{out}$
- ▶ P_{in} or P_{out} may be difficult to measure if not dc or if large EMI

- ▶ **They can be complex**

- ▶ The opposition method requires 2 converters
- ▶ This complicates their control

- ▶ **They become smaller and smaller**

- ▶ Power density increases
- ▶ Losses cannot be neglected even though η increases.

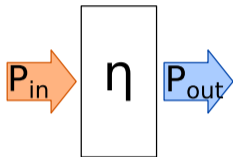

The problem with measuring losses

- ▶ **Converters are efficient**

- ▶ 98 – 99 % efficiency common
- ▶ $\frac{P_{in}-P_{out}}{P_{in}}$ very inaccurate as $P_{in} \approx P_{out}$
- ▶ P_{in} or P_{out} may be difficult to measure if not dc or if large EMI

- ▶ **They can be complex**

- ▶ The opposition method requires 2 converters
- ▶ This complicates their control

- ▶ **They become smaller and smaller**

- ▶ Power density increases
- ▶ Losses cannot be neglected even though η increases.

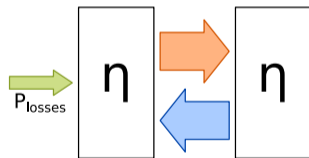
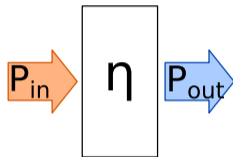

The problem with measuring losses

▶ Converters are efficient

- ▶ 98 – 99 % efficiency common
- ▶ $\frac{P_{in}-P_{out}}{P_{in}}$ very inaccurate as $P_{in} \approx P_{out}$
- ▶ P_{in} or P_{out} may be difficult to measure if not dc or if large EMI

▶ They can be complex

- ▶ The opposition method requires 2 converters
- ▶ This complicates their control

▶ They become smaller and smaller

- ▶ Power density increases
- Losses cannot be neglected even though *eta* increases.

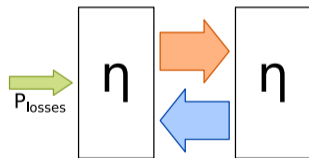
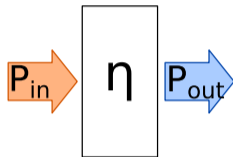

Calorimetry

Flow calorimeter

- + Allow for continuous operation
- monitoring of 2 temperatures, 1 flowrate
- more complicated to design and run

$$P = \Delta T C_p \dot{m}$$

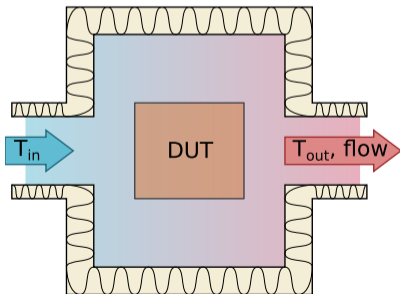

Calorimetry

Flow calorimeter

- + Allow for continuous operation
- monitoring of 2 temperatures, 1 flowrate
- more complicated to design and run

$$P = \Delta TC_p \dot{m}$$

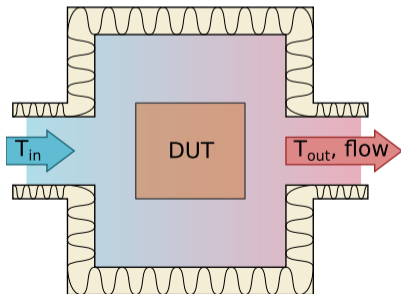

Adiabatic calorimeter

- Only short-time operation
- + Monitoring of a single temperature
- + Very simple detail (in basic version)

$$P = \frac{\Delta TC_{Th}}{t}$$

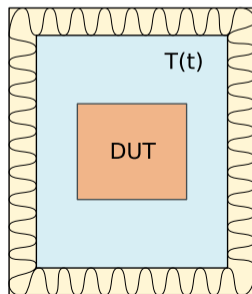

Review of Losses Measurement Techniques

Presentation of the Calorimeter

Performance Evaluation

Measurement of Converter Losses

Conclusions

General view

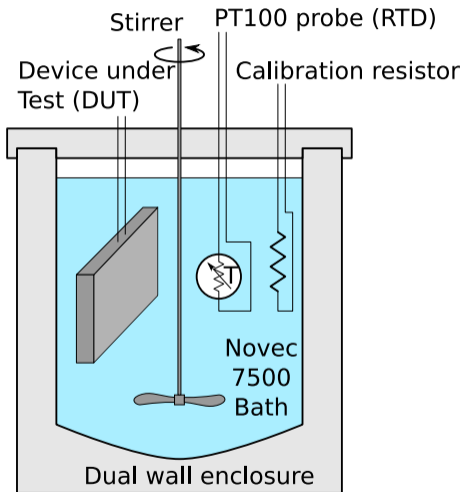

- ▶ Adiabatic calorimeter (simple design)
 - ▶ Dewar jar with plastic lid
 - ▶ Not perfectly adiabatic
- ▶ Heat collected by a liquid
- ▶ external dimensions: $\Phi = 170 \text{ mm}$, $h = 215 \text{ mm}$
- ▶ volume *approx* 700 mL

General view

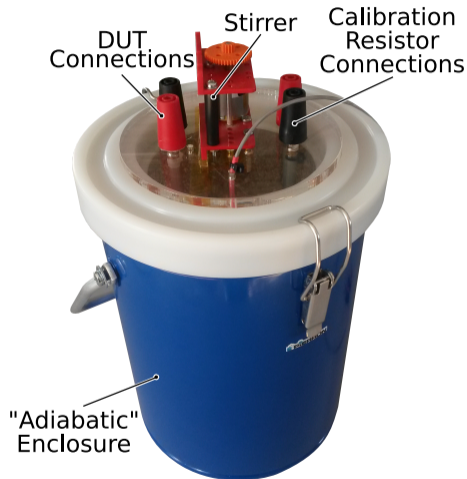

- ▶ Adiabatic calorimeter (simple design)
 - ▶ Dewar jar with plastic lid
 - ▶ Not perfectly adiabatic
- ▶ Heat collected by a liquid
- ▶ external dimensions: $\Phi = 170 \text{ mm}$, $h = 215 \text{ mm}$
- ▶ volume *approx* 700 mL

Selection of the Fluid

	DI Water	Fluorinert FC-40 (3M)	Novec 7500 (3M)
resistivity ($\Omega \cdot \text{cm}$)	1.8×10^7	1×10^{15}	2.2×10^8
GWP	-	> 9000	90
toxicity	none	low	low
residues	none	none	none
spec. heat ($\text{kJ} \cdot \text{kg}^{-1} \cdot \text{K}^{-1}$)	4.2	1.1	1.1
boiling point ($^{\circ}\text{C}$)	100	165	128

- ▶ Many fluids can be used: transformer oil, vegetable oil, fluorinert. . .
- ▶ Novec 7500 is used here because of low toxicity, low GDP
- ▶ Chemically compatible with electronics, dries without residues.

Measurement Principle

- ▶ First stage: no power dissipation
 - ▶ Temp. slope depends on $T_{bath} - T_A$
- ▶ Second stage: power P dissipated
 - ▶ Over set duration t
- ▶ Third stage: no power dissipation
 - ▶ Transient until bath temp. is uniform
 - ▶ Stabilization comparable to first stage
- ▶ ΔT is extracted from measurement

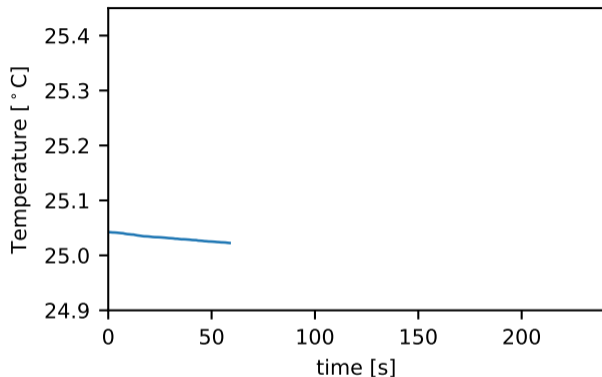

Measurement Principle

- ▶ First stage: no power dissipation
 - ▶ Temp. slope depends on $T_{bath} - T_A$
- ▶ Second stage: power P dissipated
 - ▶ Over set duration t
- ▶ Third stage: no power dissipation
 - ▶ Transient until bath temp. is uniform
 - ▶ Stabilization comparable to first stage
- ▶ ΔT is extracted from measurement

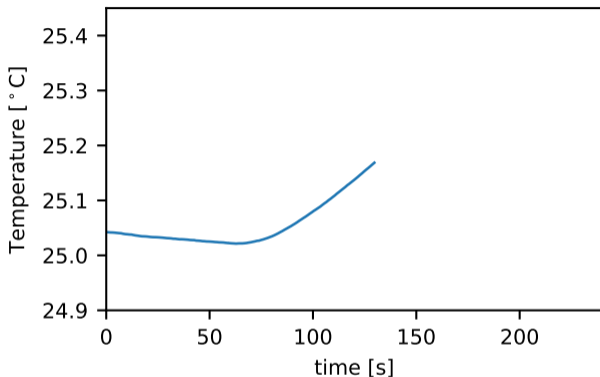

Measurement Principle

- ▶ First stage: no power dissipation
 - ▶ Temp. slope depends on $T_{bath} - T_A$
- ▶ Second stage: power P dissipated
 - ▶ Over set duration t
- ▶ Third stage: no power dissipation
 - ▶ Transient until bath temp. is uniform
 - ▶ Stabilization comparable to first stage
- ▶ ΔT is extracted from measurement

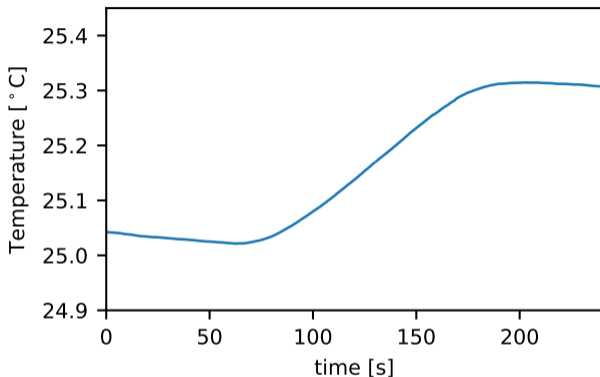

Measurement Principle

- ▶ First stage: no power dissipation
 - ▶ Temp. slope depends on $T_{bath} - T_A$
- ▶ Second stage: power P dissipated
 - ▶ Over set duration t
- ▶ Third stage: no power dissipation
 - ▶ Transient until bath temp. is uniform
 - ▶ Stabilization comparable to first stage
- ▶ ΔT is extracted from measurement

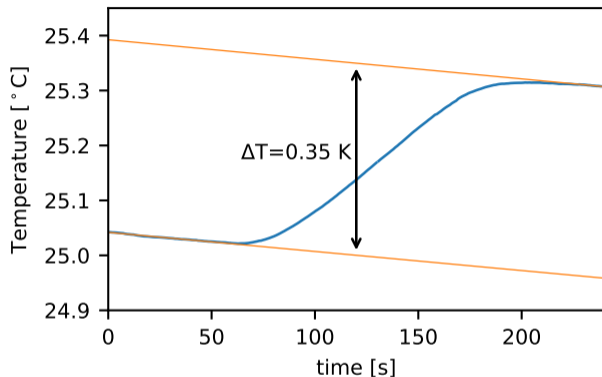

Measurement Principle

- ▶ First stage: no power dissipation
 - ▶ Temp. slope depends on $T_{bath} - T_A$
- ▶ Second stage: power P dissipated
 - ▶ Over set duration t
- ▶ Third stage: no power dissipation
 - ▶ Transient until bath temp. is uniform
 - ▶ Stabilization comparable to first stage
- ▶ ΔT is extracted from measurement

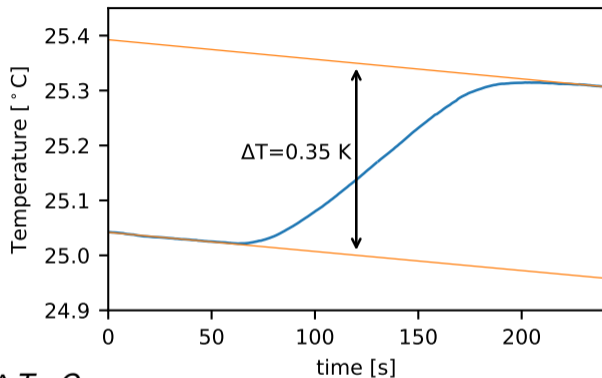

$$P = \frac{\Delta T \cdot C_{Th}}{t} \quad (1)$$

Calibration: P known (dc resistor), C_{Th} calculated

Measurement: C_{Th} known (dc resistor), P calculated

Review of Losses Measurement Techniques

Presentation of the Calorimeter

Performance Evaluation

Measurement of Converter Losses

Conclusions

Temperature Measurement Resolution

Acquisition chain

- ▶ PT100 (platinum resistor) sensor
- ▶ High resolution ohmmeter (Keithley 2100)
- ▶ 4-wire connection
- ▶ Filtering
- ▶ High integration time

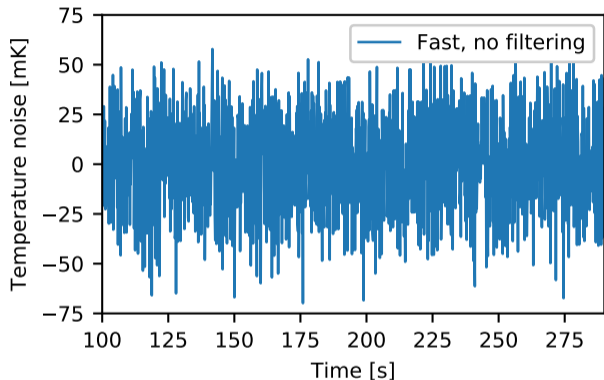

Temperature Measurement Resolution

Acquisition chain

- ▶ PT100 (platinum resistor) sensor
- ▶ High resolution ohmmeter (Keithley 2100)
- ▶ 4-wire connection
- ▶ Filtering
- ▶ High integration time

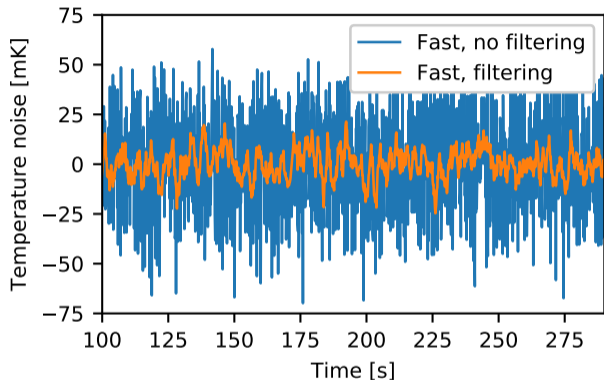

Temperature Measurement Resolution

Acquisition chain

- ▶ PT100 (platinum resistor) sensor
- ▶ High resolution ohmmeter (Keithley 2100)
- ▶ 4-wire connection
- ▶ Filtering
- ▶ High integration time

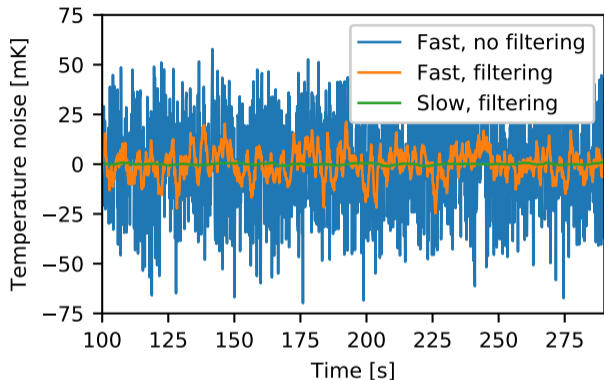

Temperature Measurement Resolution

Acquisition chain

- ▶ PT100 (platinum resistor) sensor
- ▶ High resolution ohmmeter (Keithley 2100)
- ▶ 4-wire connection
- ▶ Filtering
- ▶ High integration time

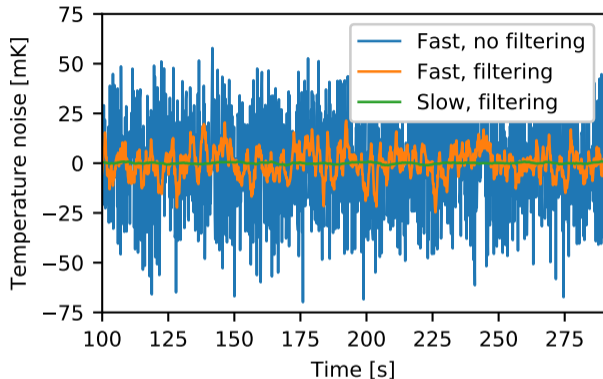

- 0.25 K absolute temperature accuracy
- 1 mK relative temperature accuracy

Effect of stirring

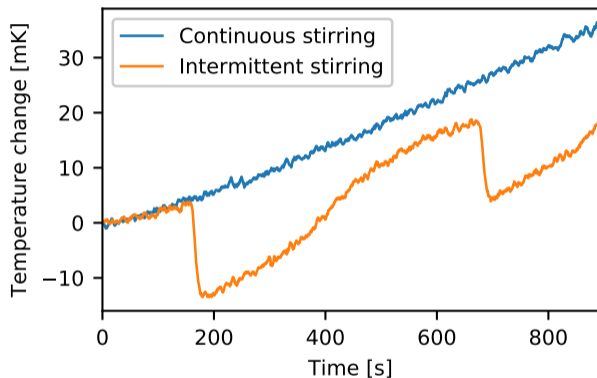

- ▶ Stirring required for bath uniformity
- ▶ Small dc motor attached to stirrer
- ▶ Causes small temperature rise ($2.4 \text{ mK} \cdot \text{min}^{-1}$)
- ➔ Corresponds to a 70 mW power flow

Effect of stirring

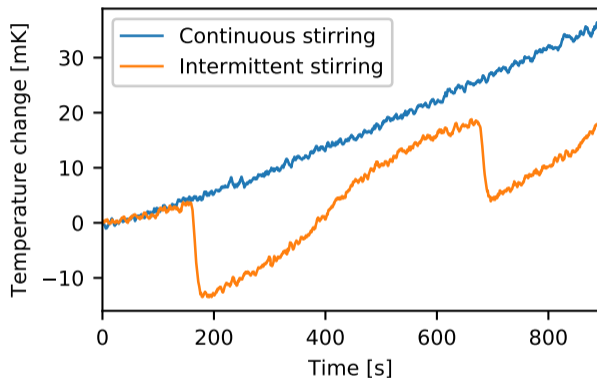

- ▶ Stirring required for bath uniformity
- ▶ Small dc motor attached to stirrer
- ▶ Causes small temperature rise ($2.4 \text{ mK} \cdot \text{min}^{-1}$)
- Corresponds to a 70 mW power flow

→ Negligible effect as it is small and canceled by the ΔT calculation

Effect of Power Level

- ▶ Using a resistor supplied with dc current
 - ▶ Power dissipated for 1 min:
 - ▶ 29.2 W
 - ▶ 18.7 W
 - ▶ 10.5 W
 - ▶ 4.7 W
 - ▶ 1.2 W
- $C_{Th} = (1657 \pm 5) \text{ J} \cdot \text{K}^{-1}$ (0.3 % error)

Effect of Power Level

▶ Using a resistor supplied with dc current

▶ Power dissipated for 1 min:

▶ 29.2 W

▶ 18.7 W

▶ 10.5 W

▶ 4.7 W

▶ 1.2 W

→ $C_{Th} = (1657 \pm 5) \text{ J} \cdot \text{K}^{-1}$ (0.3 % error)

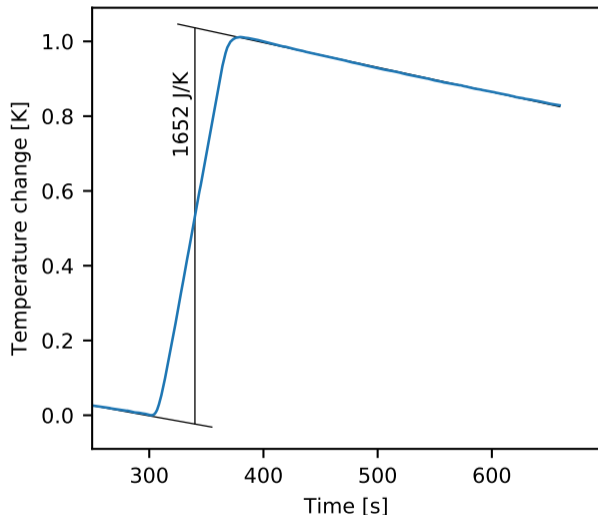

Effect of Power Level

- ▶ Using a resistor supplied with dc current
- ▶ Power dissipated for 1 min:
 - ▶ 29.2 W
 - ▶ 18.7 W
 - ▶ 10.5 W
 - ▶ 4.7 W
 - ▶ 1.2 W

→ $C_{Th} = (1657 \pm 5) \text{ J} \cdot \text{K}^{-1}$ (0.3 % error)

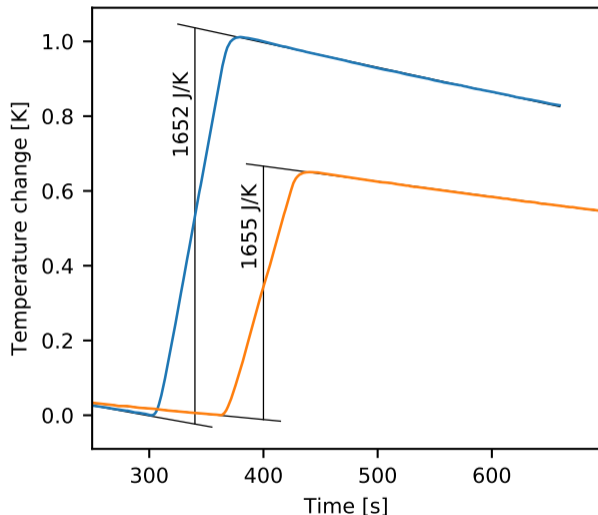

Effect of Power Level

▶ Using a resistor supplied with dc current

▶ Power dissipated for 1 min:

▶ 29.2 W

▶ 18.7 W

▶ 10.5 W

▶ 4.7 W

▶ 1.2 W

→ $C_{Th} = (1657 \pm 5) \text{ J} \cdot \text{K}^{-1}$ (0.3 % error)

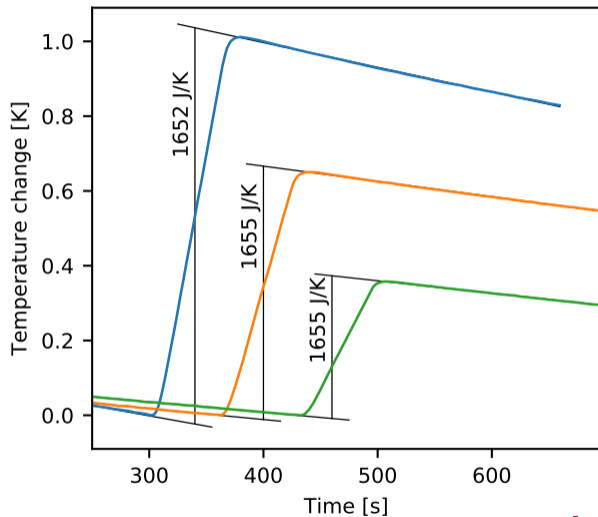

Effect of Power Level

▶ Using a resistor supplied with dc current

▶ Power dissipated for 1 min:

▶ 29.2 W

▶ 18.7 W

▶ 10.5 W

▶ 4.7 W

▶ 1.2 W

→ $C_{Th} = (1657 \pm 5) \text{ J} \cdot \text{K}^{-1}$ (0.3 % error)

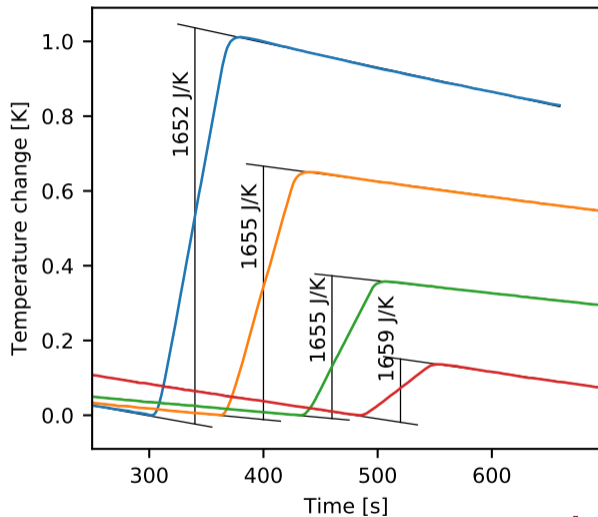

Effect of Power Level

- ▶ Using a resistor supplied with dc current
- ▶ Power dissipated for 1 min:
 - ▶ 29.2 W
 - ▶ 18.7 W
 - ▶ 10.5 W
 - ▶ 4.7 W
 - ▶ 1.2 W

→ $C_{Th} = (1657 \pm 5) \text{ J} \cdot \text{K}^{-1}$ (0.3% error)

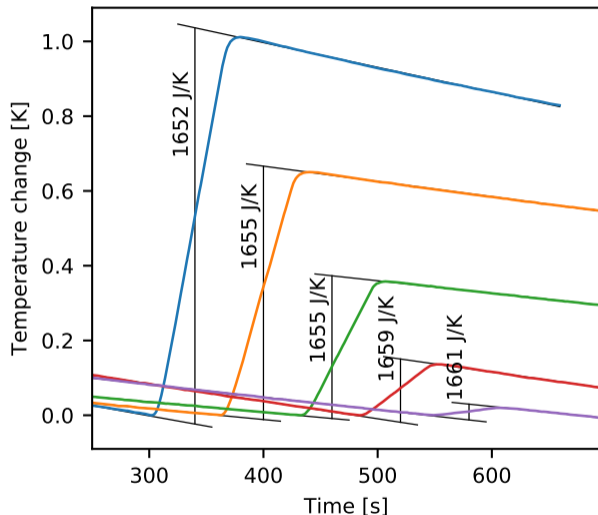

Effect of Power Level

▶ Using a resistor supplied with dc current

▶ Power dissipated for 1 min:

- ▶ 29.2 W
- ▶ 18.7 W
- ▶ 10.5 W
- ▶ 4.7 W
- ▶ 1.2 W

→ $C_{Th} = (1657 \pm 5) \text{ J} \cdot \text{K}^{-1}$ (0.3% error)

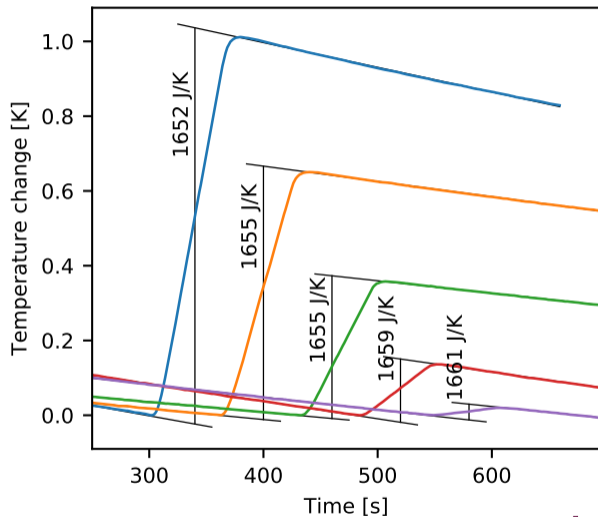

Effect of measurement duration

Dissipation of ≈ 300 J over:

- ▶ 10 s
- ▶ 20 s
- ▶ 30 s
- ▶ 40 s
- ▶ 50 s
- ▶ 60 s

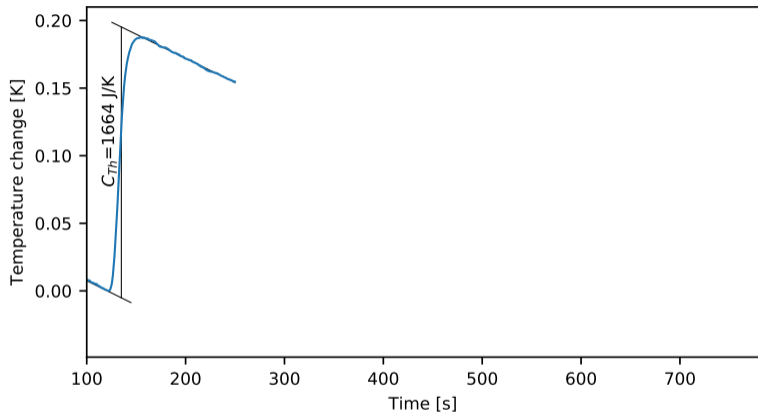

Effect of measurement duration

Dissipation of ≈ 300 J over:

- ▶ 10 s
- ▶ 20 s
- ▶ 30 s
- ▶ 40 s
- ▶ 50 s
- ▶ 60 s

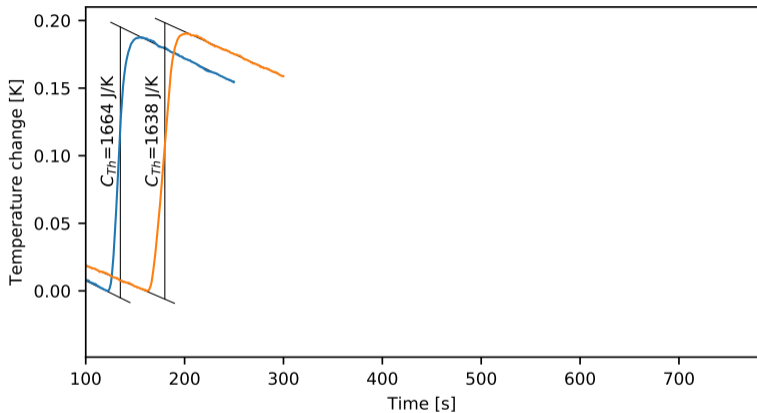

Effect of measurement duration

Dissipation of ≈ 300 J over:

- ▶ 10 s
- ▶ 20 s
- ▶ 30 s
- ▶ 40 s
- ▶ 50 s
- ▶ 60 s

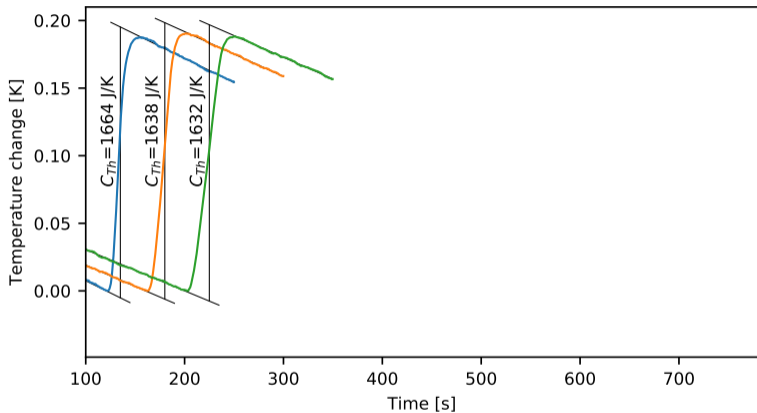

Effect of measurement duration

Dissipation of ≈ 300 J over:

- ▶ 10 s
- ▶ 20 s
- ▶ 30 s
- ▶ 40 s
- ▶ 50 s
- ▶ 60 s

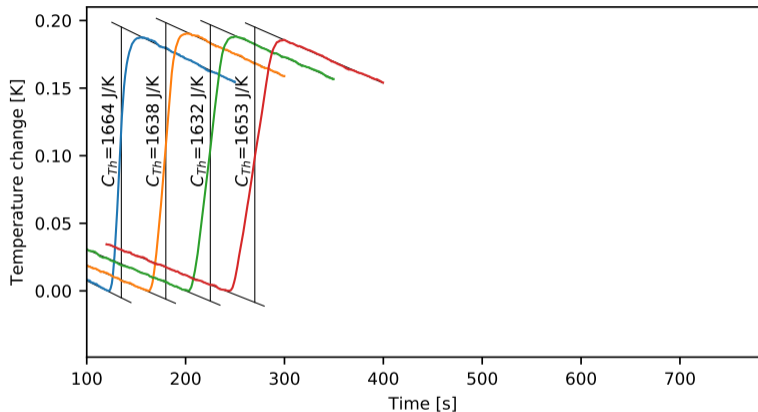

Effect of measurement duration

Dissipation of ≈ 300 J over:

- ▶ 10 s
- ▶ 20 s
- ▶ 30 s
- ▶ 40 s
- ▶ 50 s
- ▶ 60 s

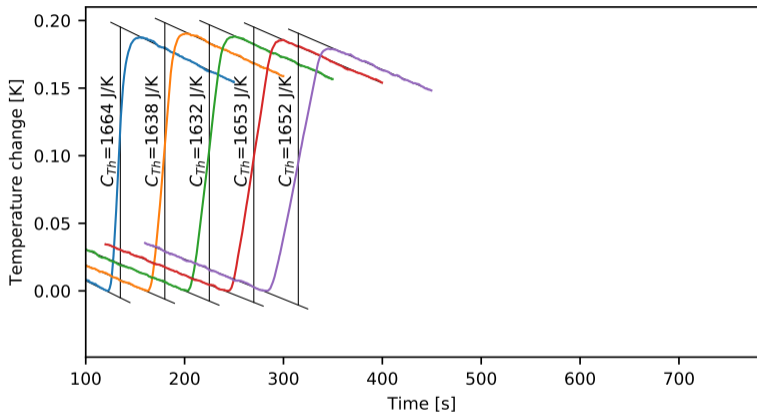

Effect of measurement duration

Dissipation of ≈ 300 J over:

- ▶ 10 s
- ▶ 20 s
- ▶ 30 s
- ▶ 40 s
- ▶ 50 s
- ▶ 60 s

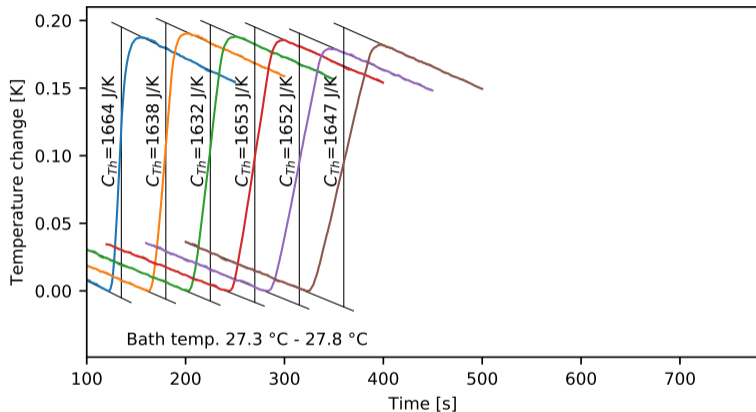

Effect of measurement duration

Dissipation of ≈ 300 J over:

- ▶ 10 s
- ▶ 20 s
- ▶ 30 s
- ▶ 40 s
- ▶ 50 s
- ▶ 60 s

And for different bath temp.

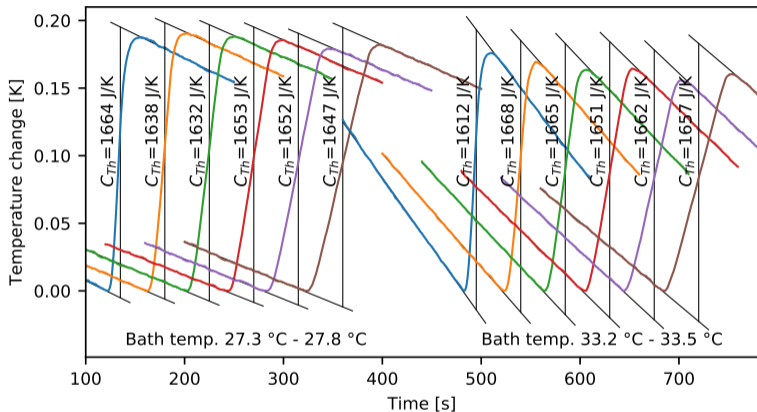

Effect of measurement duration

Dissipation of ≈ 300 J over:

- ▶ 10 s
- ▶ 20 s
- ▶ 30 s
- ▶ 40 s
- ▶ 50 s
- ▶ 60 s

And for different bath temp.

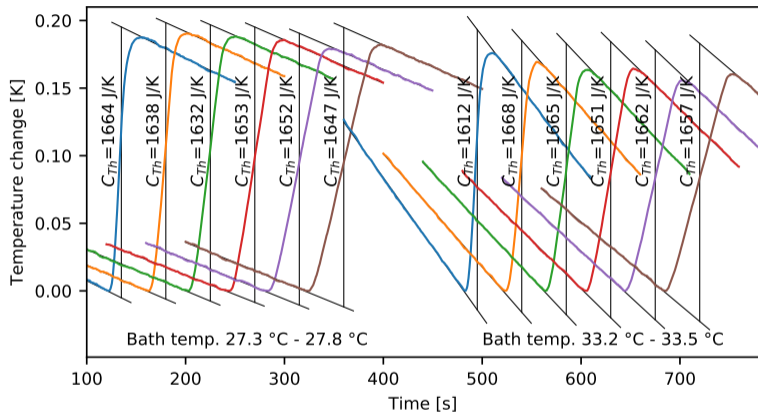

Overall, $C_{Th} = (1670 \pm 59) \text{ J} \cdot \text{K}^{-1}$ (3.5 % error)
Without the "10 s" measurements, error is down to 1.4 %

Sources of error:

- ▶ Relative error on temperature: 1 mK
 - ▶ Estimated error on curve fitting: 2 mK
 - ▶ Estimated error on time: 1 s
- for $\Delta T = 0.2 \text{ K}$ and $t = 60 \text{ s}$, error is 3.2 % (1.7 % for t alone)

Sources of error:

- ▶ Relative error on temperature: 1 mK
 - ▶ Estimated error on curve fitting: 2 mK
 - ▶ Estimated error on time: 1 s
- for $\Delta T = 0.2$ K and $t = 60$ s, error is 3.2 % (1.7 % for t alone)

Possible Mitigation

- ▶ Automatic time control: error on t virtually 0
- ▶ Improved adiabaticity to reduce error on ΔT : may be complex
- ▶ Adjustment of calorimeter bath volume to increase ΔT : easy

Review of Losses Measurement Techniques

Presentation of the Calorimeter

Performance Evaluation

Measurement of Converter Losses

Conclusions

Calibration

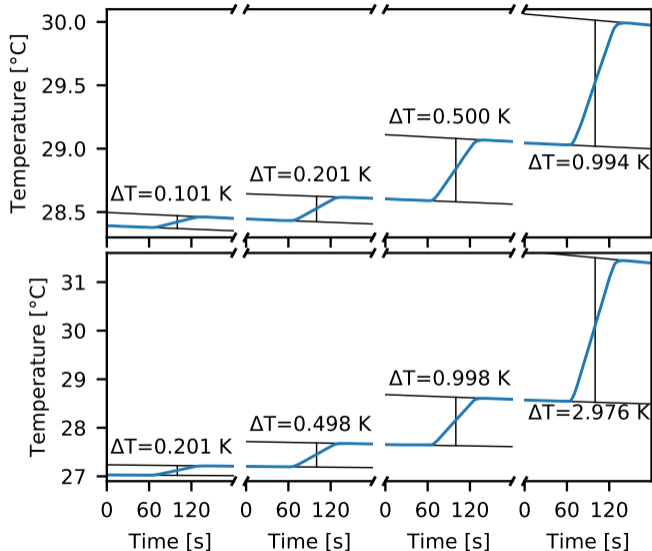

- ▶ One calibration per test series (different quantities of fluid)
- ▶ $\Delta T < 50$ mK discarded
- ▶ ΔT up to 2.9 K considered
- ▶ First series $C_{Th} = 1665 \pm 1 \%$
- ▶ Second series $C_{Th} = 1350 \pm 1 \%$

Test Setup

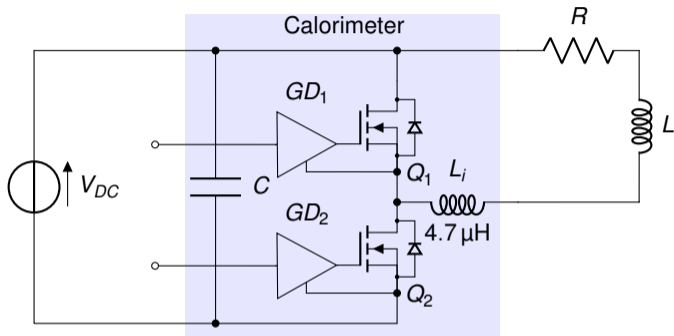

System under test:

- ▶ PCB-integrated converter
- ▶ SiC MOSFETs,
- ▶ output inductor,
- ▶ decoupling capacitor,
- ▶ gate drivers.

Load kept outside of the calorimeter:

- ▶ load resistor
- ▶ additional inductor

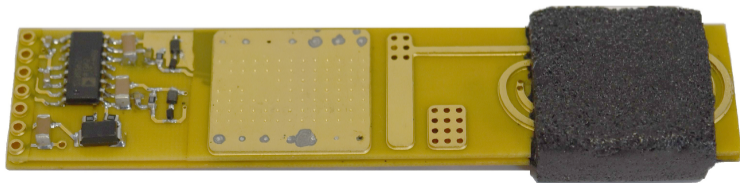

Results

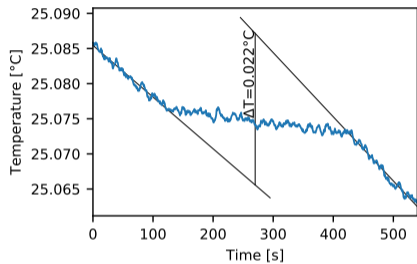

Measurement resolution:

- ▶ gate drive only
- ▶ 33.5 J over 300 s
- 110 mW $\pm 5\%$

Results

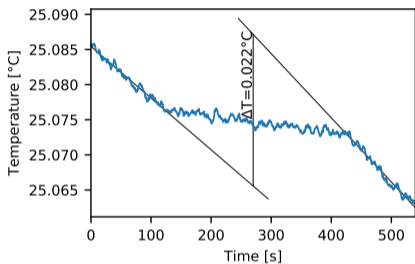

Different test configurations:

- ▶ V_{DC} , load resistor and inductor, load current, f_{sw}
- ▶ Poor accuracy for low losses
- ▶ Large error due to operating time control:

E_1 total error

E_2 without error due to time measurement

	V_{DC} (V)	R (Ω)	L (μH)	I_{max} (A)	f_{sw} (kHz)	P (W)	E1 (%)	E2 (%)
1	100	30.	250	3.3	4	0.73	12.6	11.0
2	60	10.	250	6.	4	1.8	6.1	4.4
3	60	5.	250	12.	2	6.42	2.9	1.2
4	60	3.3	250	18.2	1.2	12.9	2.2	0.6
5	60	10.	0	6.	4	2.35	5.1	3.4
6	60	5.	0	12.	2	9.35	2.5	0.9

Measurement resolution:

- ▶ gate drive only
- ▶ 33.5 J over 300 s
- 110 mW \pm 5%

Review of Losses Measurement Techniques

Presentation of the Calorimeter

Performance Evaluation

Measurement of Converter Losses

Conclusions

A very simple calorimeter has been presented

- ▶ $\approx 500\text{€}$ (excl. ohmeter), easy to implement
- ▶ Fluid with low environmental/safety concerns

A very simple calorimeter has been presented

- ▶ $\approx 500\text{€}$ (excl. ohmeter), easy to implement
- ▶ Fluid with low environmental/safety concerns

Operation over low ΔT (0.2–1 K)

- ▶ No extreme adiabaticity required
- ▶ No problem with non-linearities

A very simple calorimeter has been presented

- ▶ $\approx 500\text{€}$ (excl. ohmeter), easy to implement
- ▶ Fluid with low environmental/safety concerns

Operation over low ΔT (0.2–1 K)

- ▶ No extreme adiabaticity required
- ▶ No problem with non-linearities

Satisfying accuracy/resolution

- ▶ Can detect power consumption of gate drivers
- ▶ Conservative error estimation yields 3.2 %
 - ▶ Can be reduced to 1.6 % with proper timing control
 - ▶ Can be further reduced (adjusted calorimeter volume, improved calibration)

Thank you for your attention.

cyril.buttay@insa-lyon.fr

This work was funded by Mitsubishi Electric Research Centre Europe and the French Agency for Technology and Research (ANRT).