



# Thermosiphon for passive cooling of a MVDC converter

Majed Eddine MOUSTAID, Vincent PLATEL, Cyril BUTTAY, Bruno LEFEBVRE

**iMaps-ATW on Micropackaging and Thermal Management**

# Outline

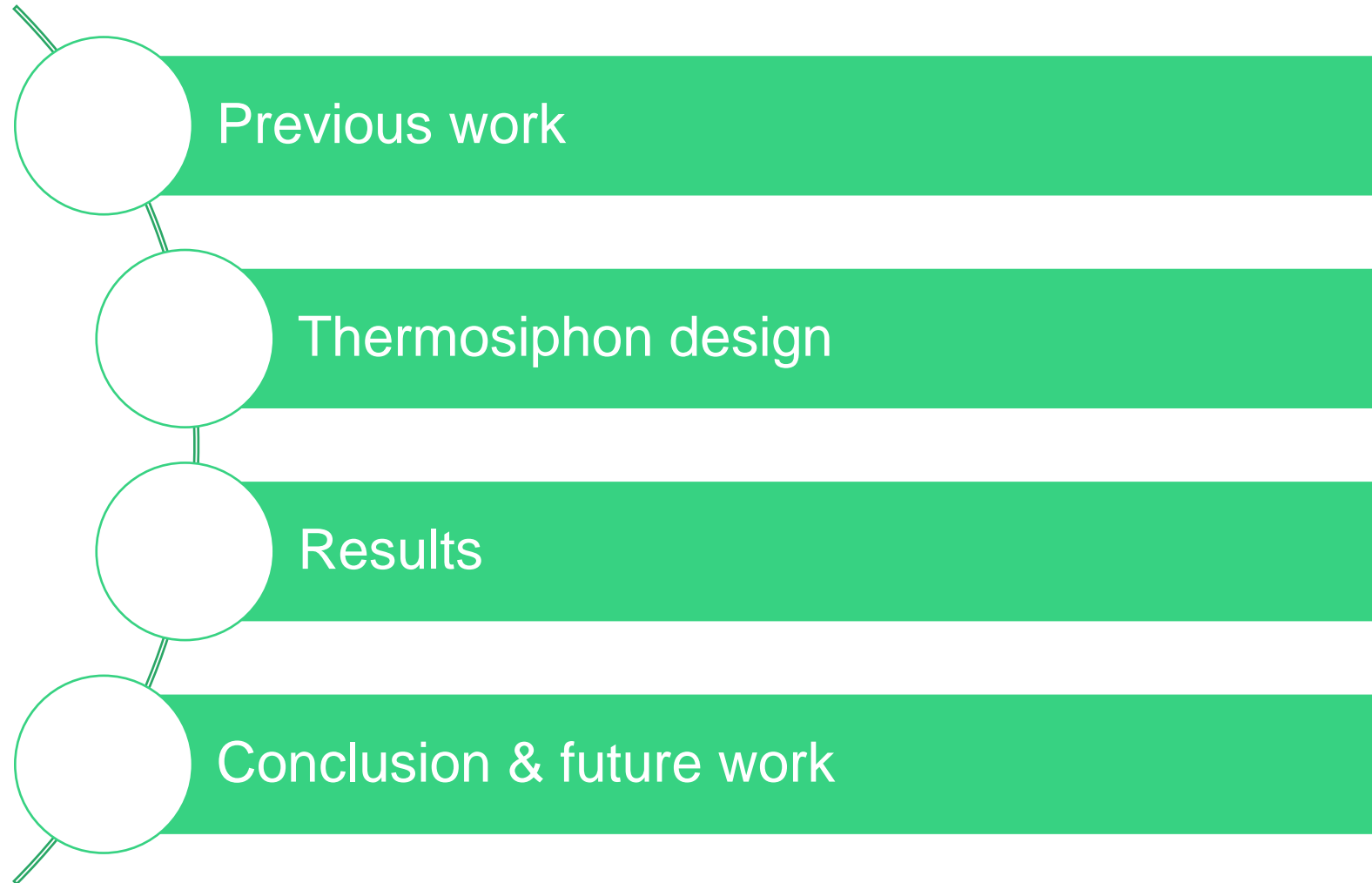

## Previous work : IMAPS 2017

Previous work

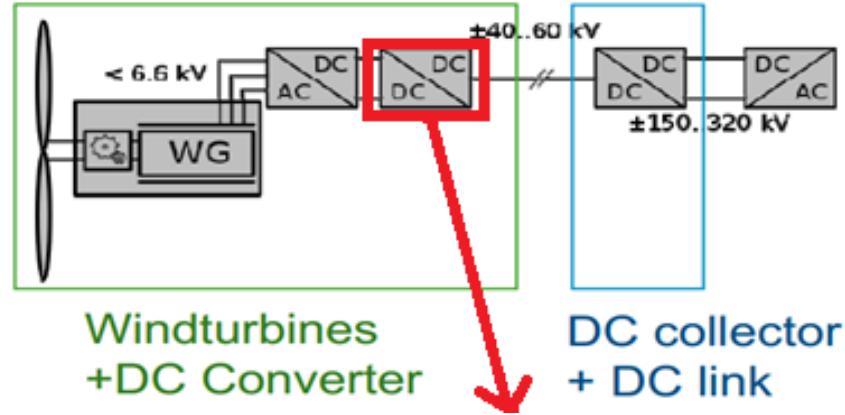

Thermosiphon  
design

Results

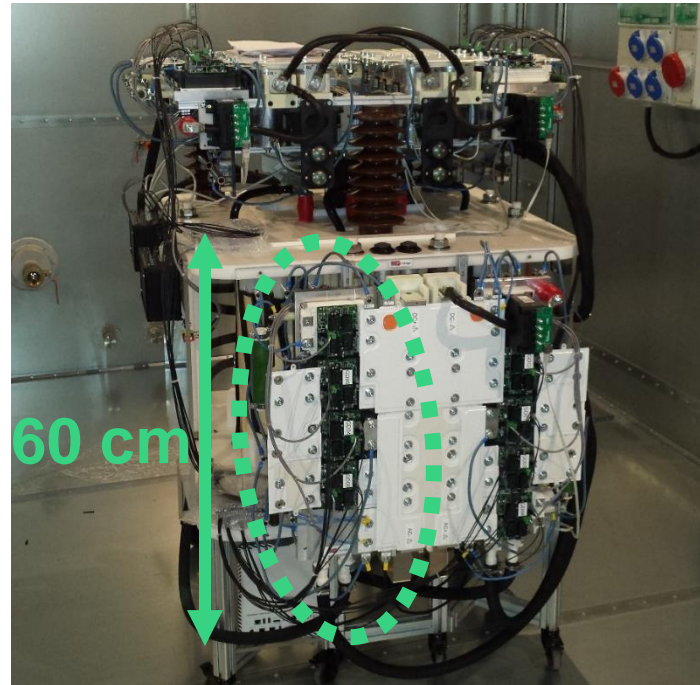

Conclusion &  
future work

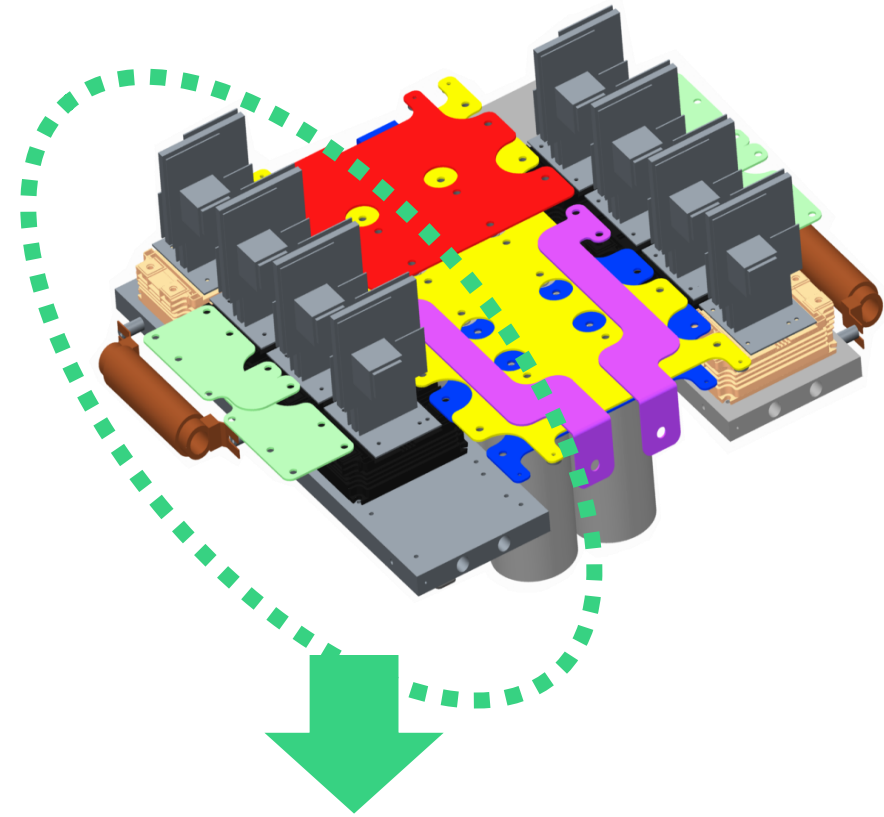

Thermal power per leg (worse case)	1,8 (4 ) kW
Power per module (worse case)	600 (1330) W
Thermal flux (worse case)	4,3 (9) W cm <sup>-2</sup>
Baseplate temperature	70 °C
Ambient temperature	40 °C

## Previous work : IMAPS 2018

Previous work

Thermosiphon  
design

Results

Conclusion &  
future work

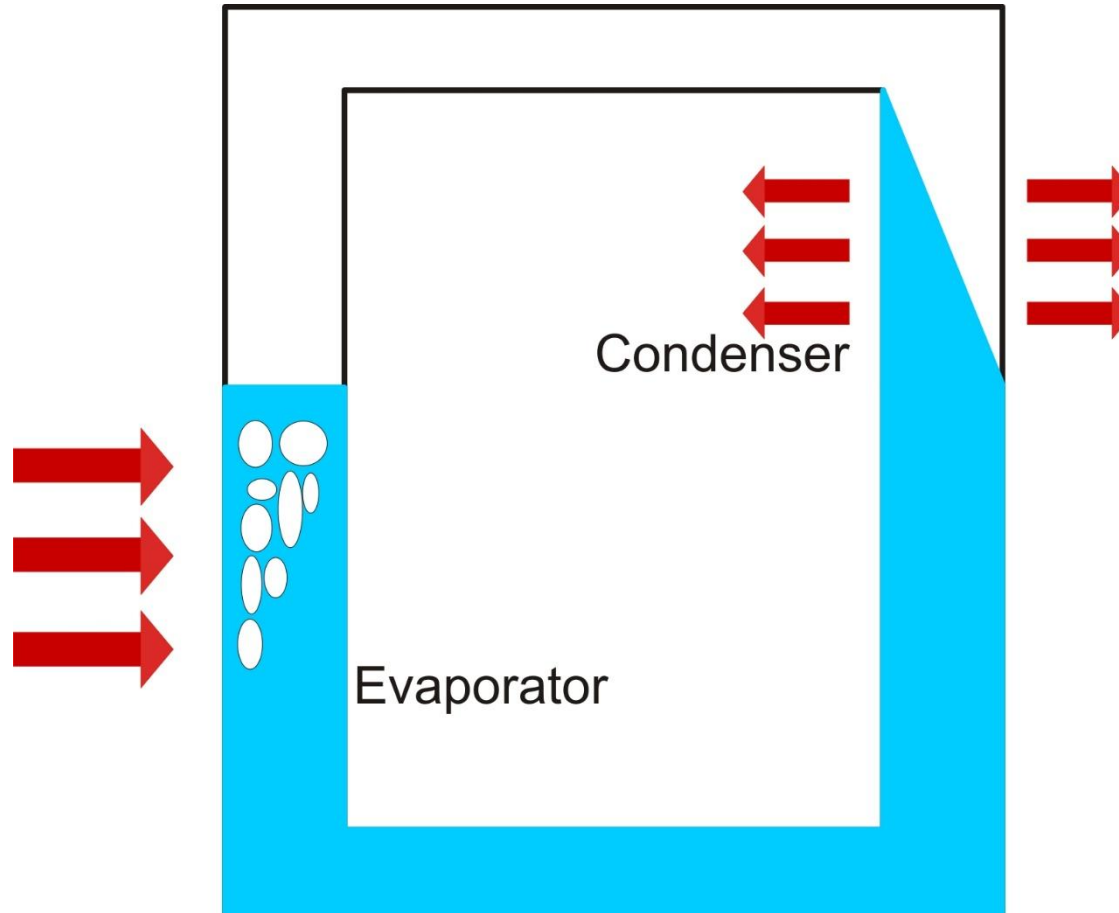

## Novec 649

Boiling temperature °C (1 bar)	49
Liquid density $\rho_L$ (kg m <sup>-3</sup> )	1600
Vapor density $\rho_V$ (kg m <sup>-3</sup> )	5,73
Latent heat $\Delta h_{iv}$ (kJ kg <sup>-1</sup> )	88
Thermal conductivity (W m <sup>-1</sup> K <sup>-1</sup> )	0,059
Surface tension (mN m <sup>-1</sup> )	10,8
ODP (ozone depletion potential)	0
GWP (global warming potential)	1
Flammability	✓
Melting temperature (°C)	-100
Price (€/kg)	55

# Thermosiphon design

Previous work

Thermosiphon  
design

Results

Conclusion &  
future work

- Evaporator  
[0° , 90°]  
Power : 4 x 1100 W

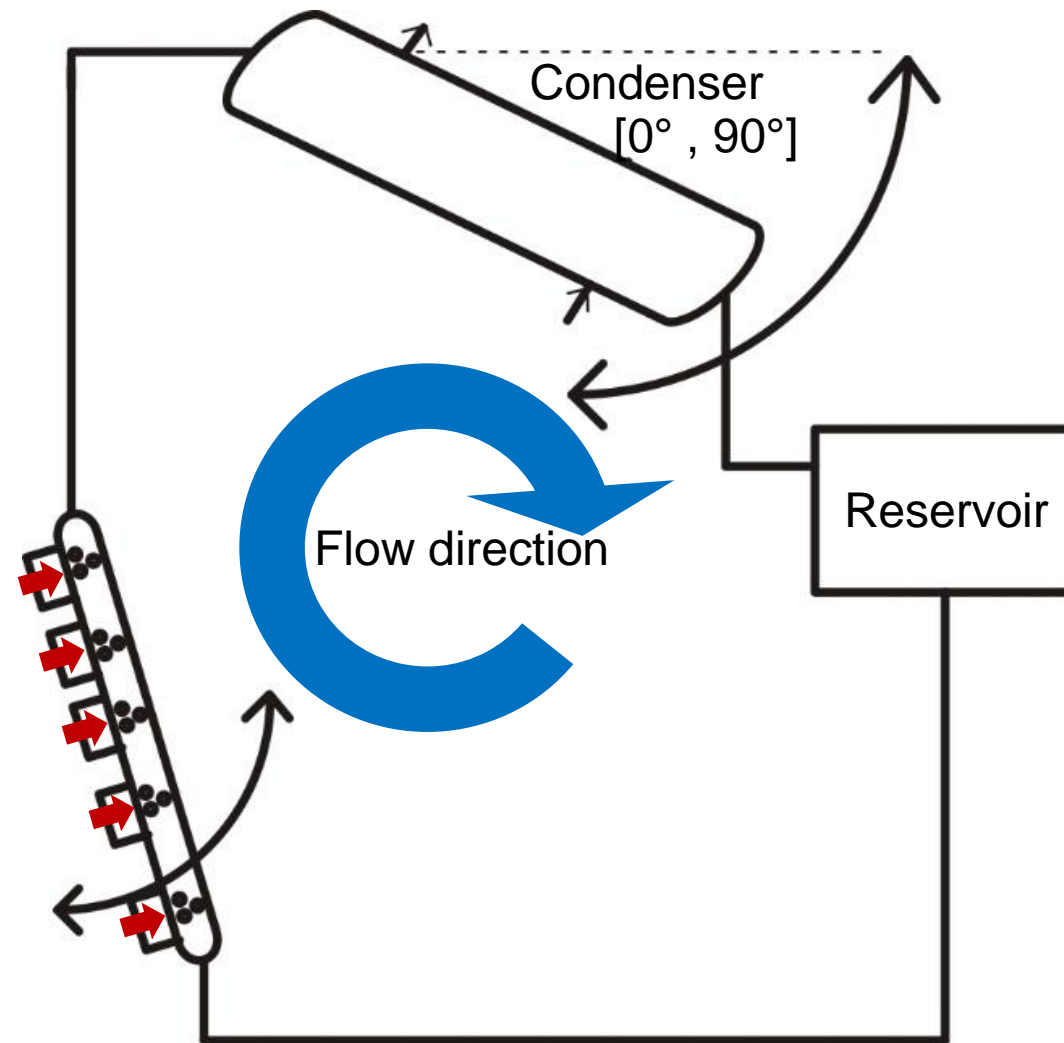



# Thermosiphon design : evaporator

**Material : aluminum**

**Hot plates : 1100 W each**

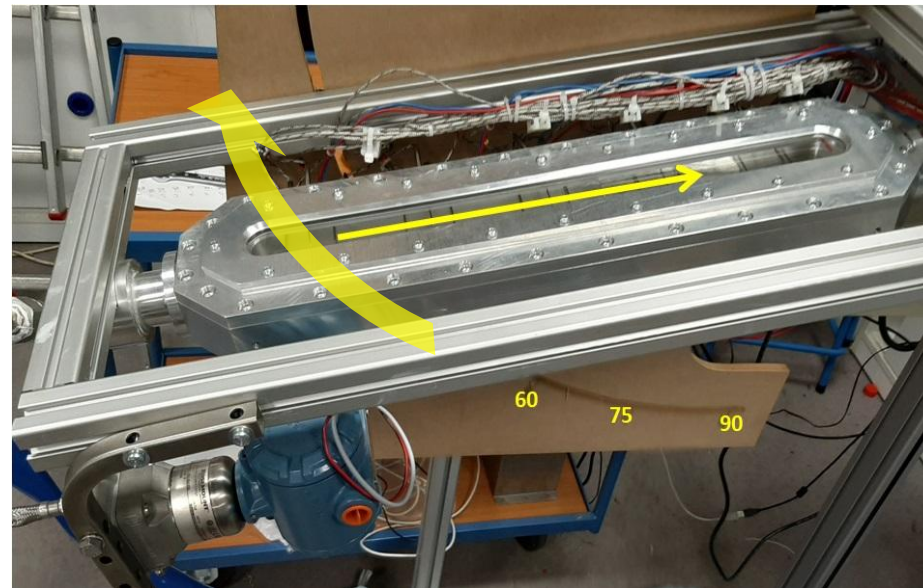
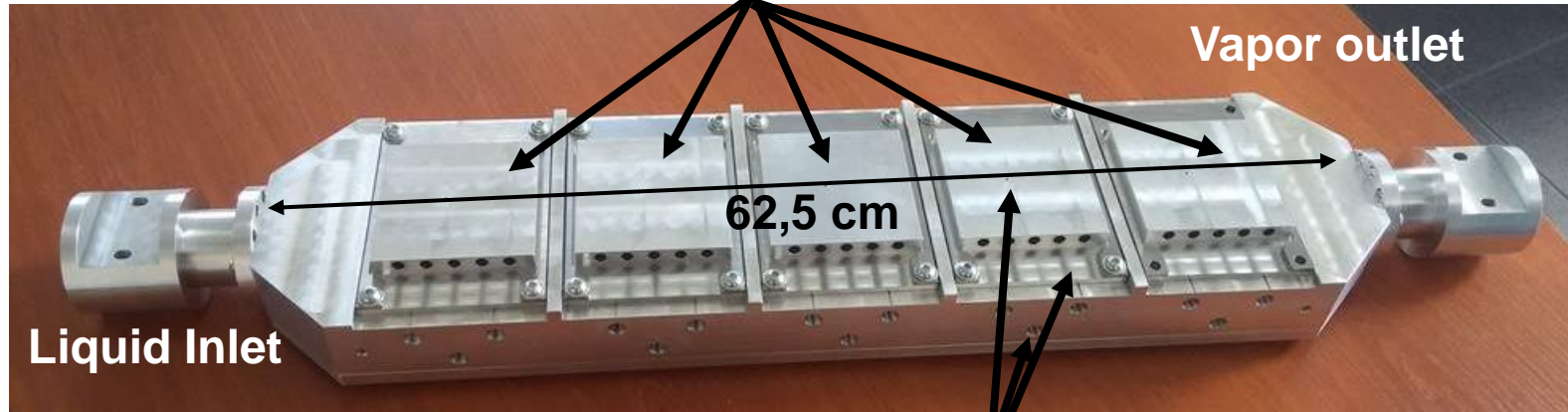

**Thermocouple entry**

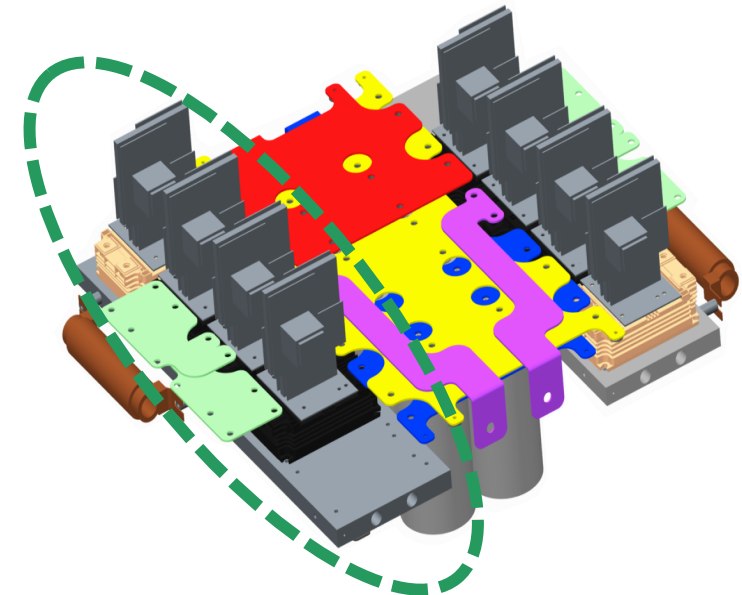

Previous work

Thermosiphon design

Results

Conclusion & future work

# Thermosiphon design : condenser

Previous work

Thermosiphon design

Results

Conclusion & future work

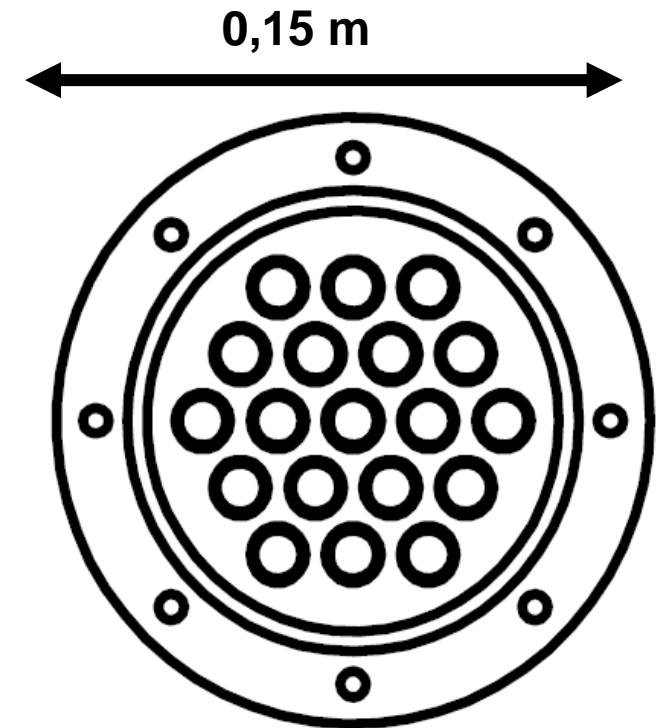
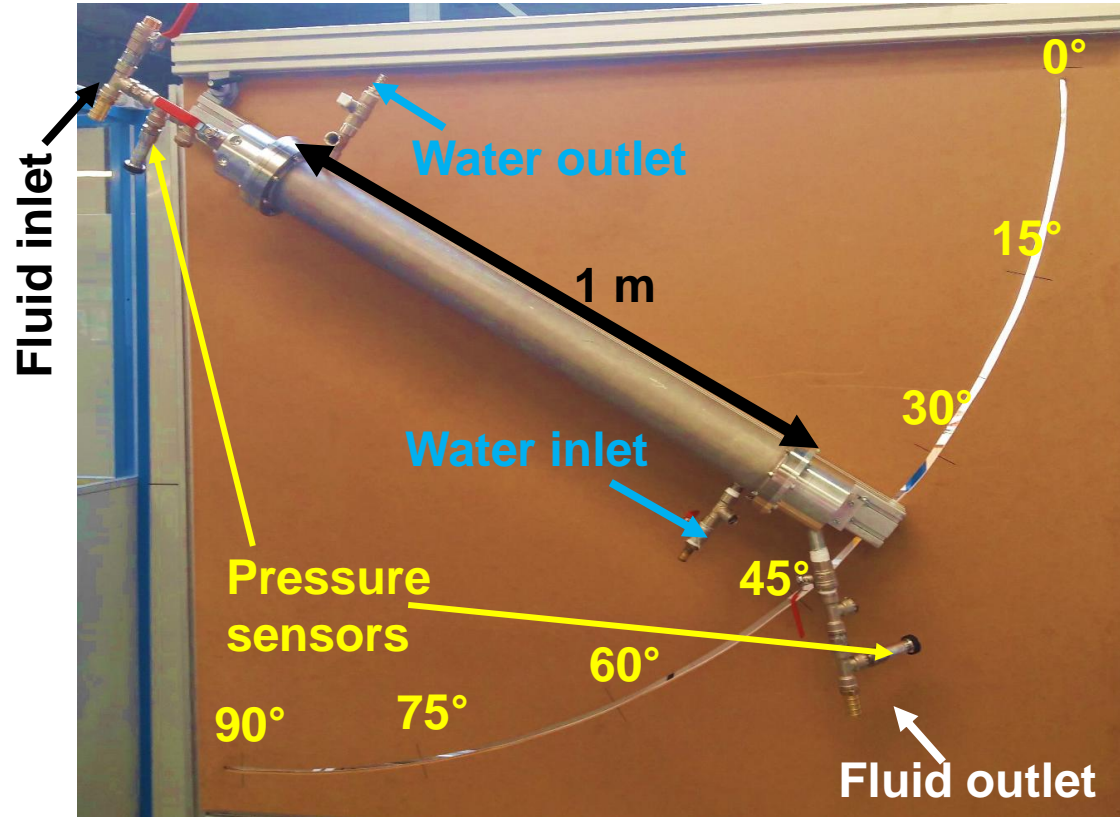

**Material : stainless steel**





## Thermosiphon design : reservoir

Previous work



Thermosiphon  
design



Results



Conclusion &  
future work

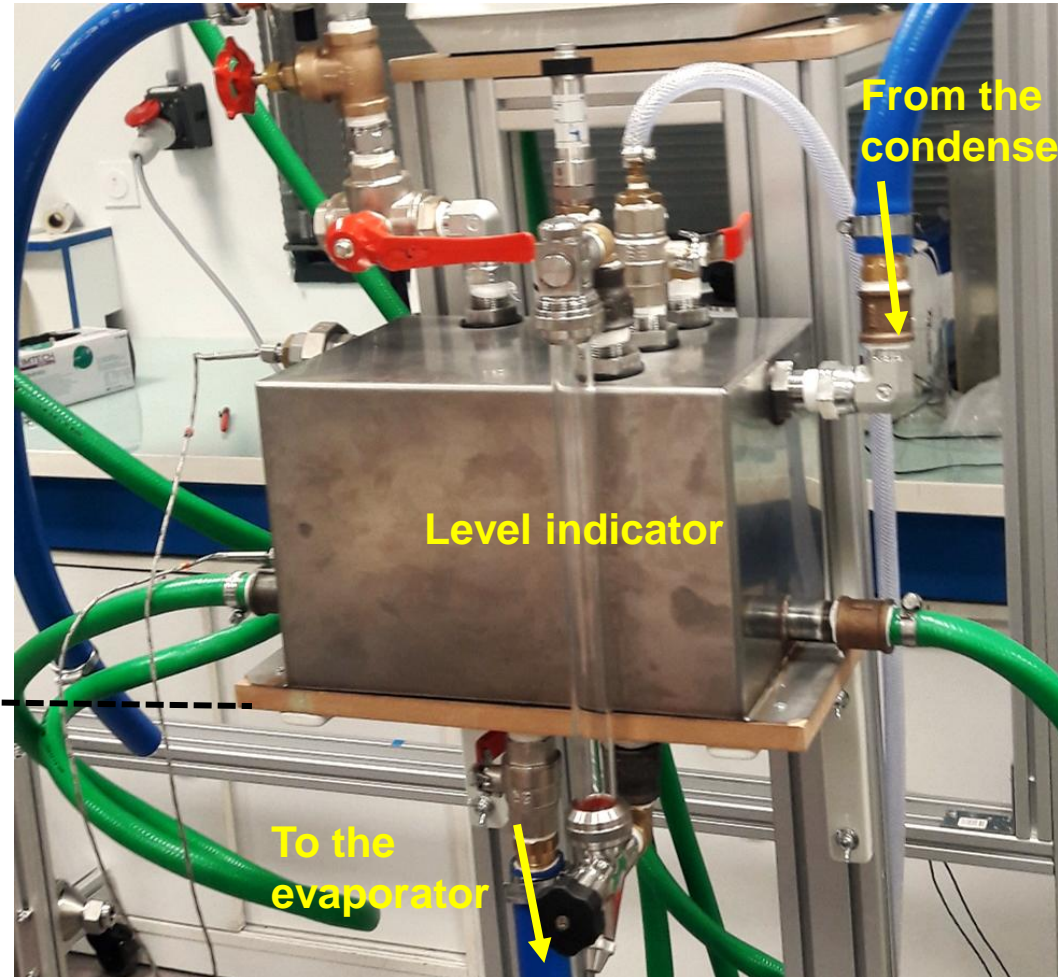



# Thermosiphon

Previous work



Thermosiphon  
design



Results



Conclusion &  
future work

Condenser

Reservoir

Chiller

Evaporator

Flowmeter

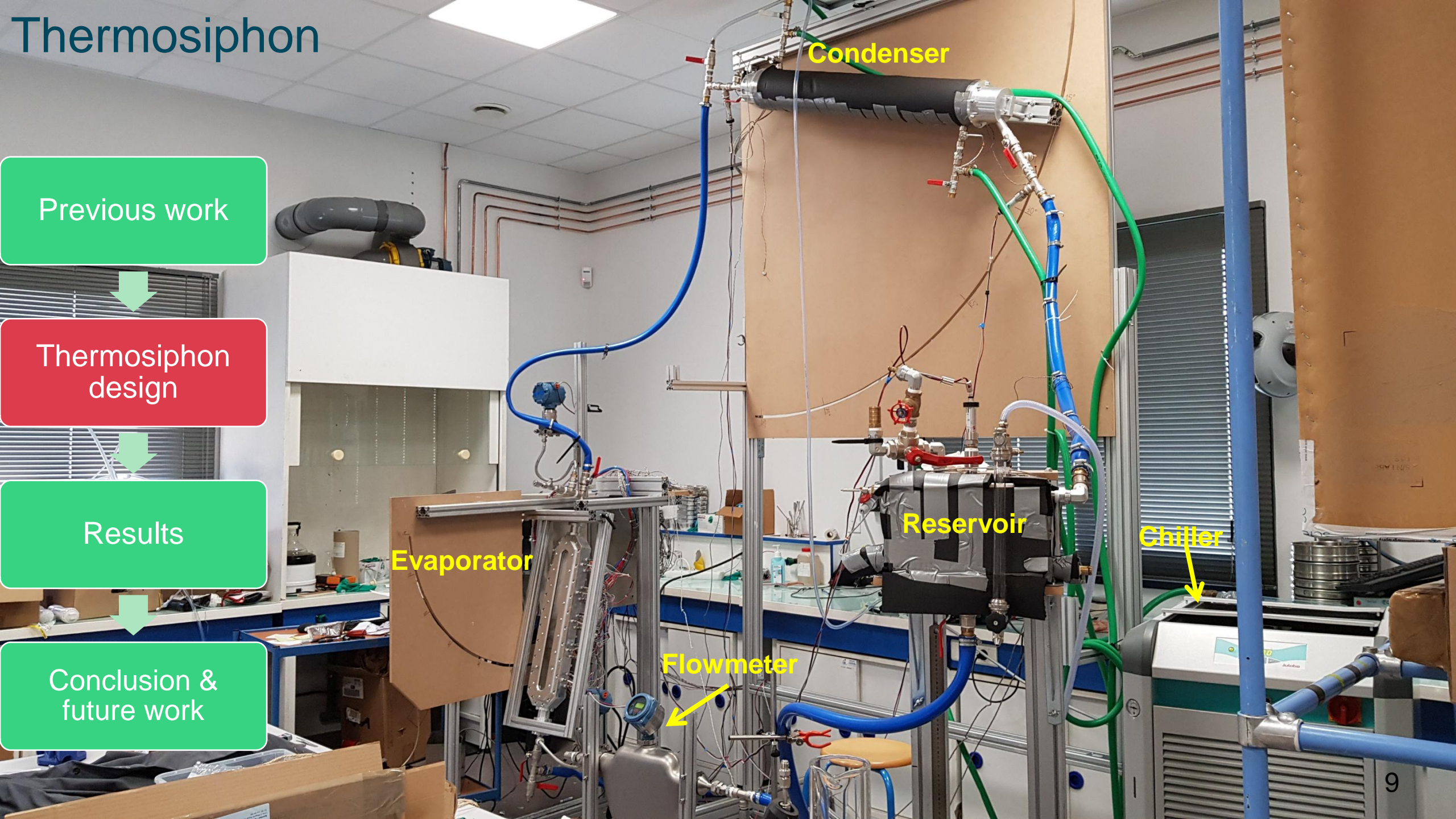



## Results : configuration

Previous work

Thermosiphon  
design

Results

Conclusion &  
future work

Module n°4

Module n°3

Module n°2

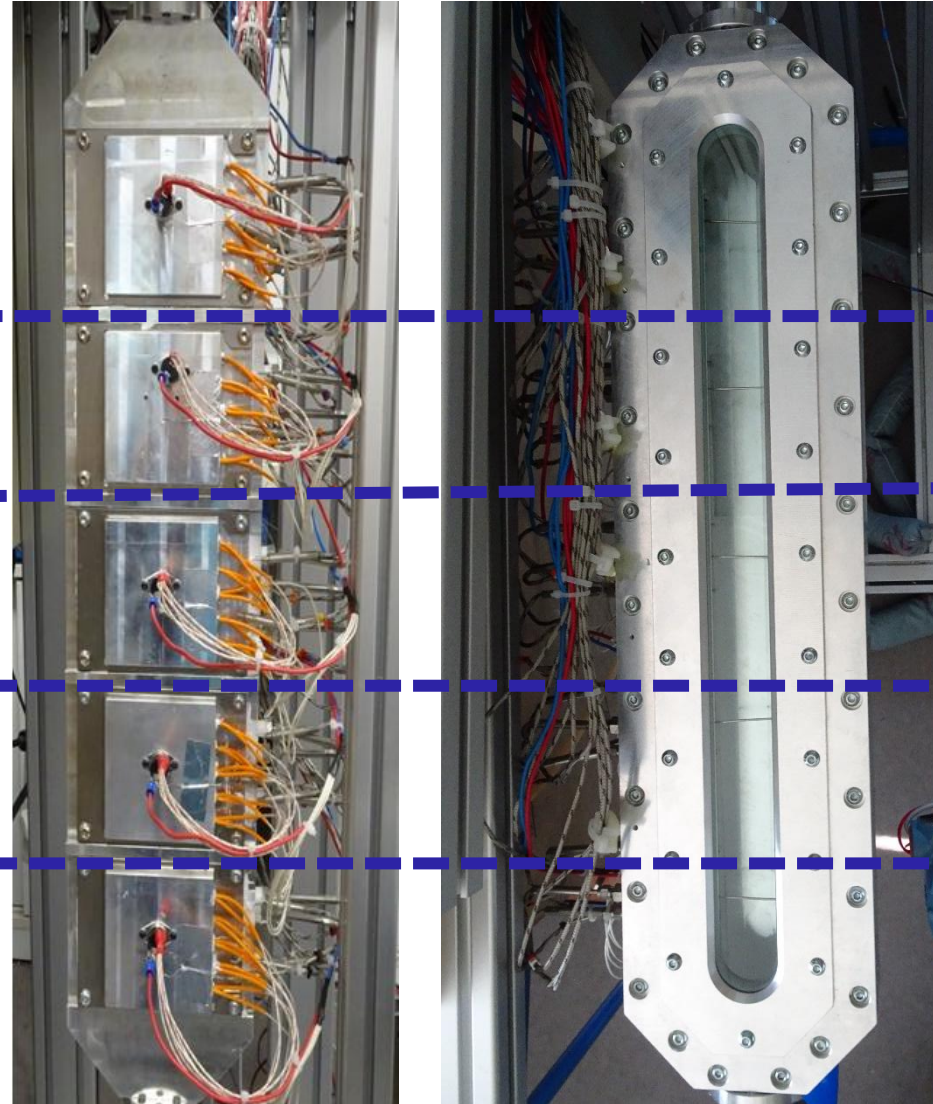

Dissipated power: 2400 - 300 W  
Water coolant inlet: 40°C

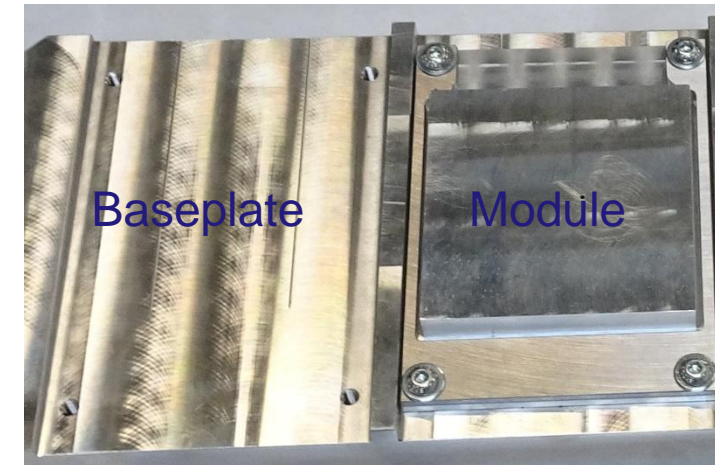

# Results : temperature response

Previous work

Thermosiphon design

Results

Conclusion & future work

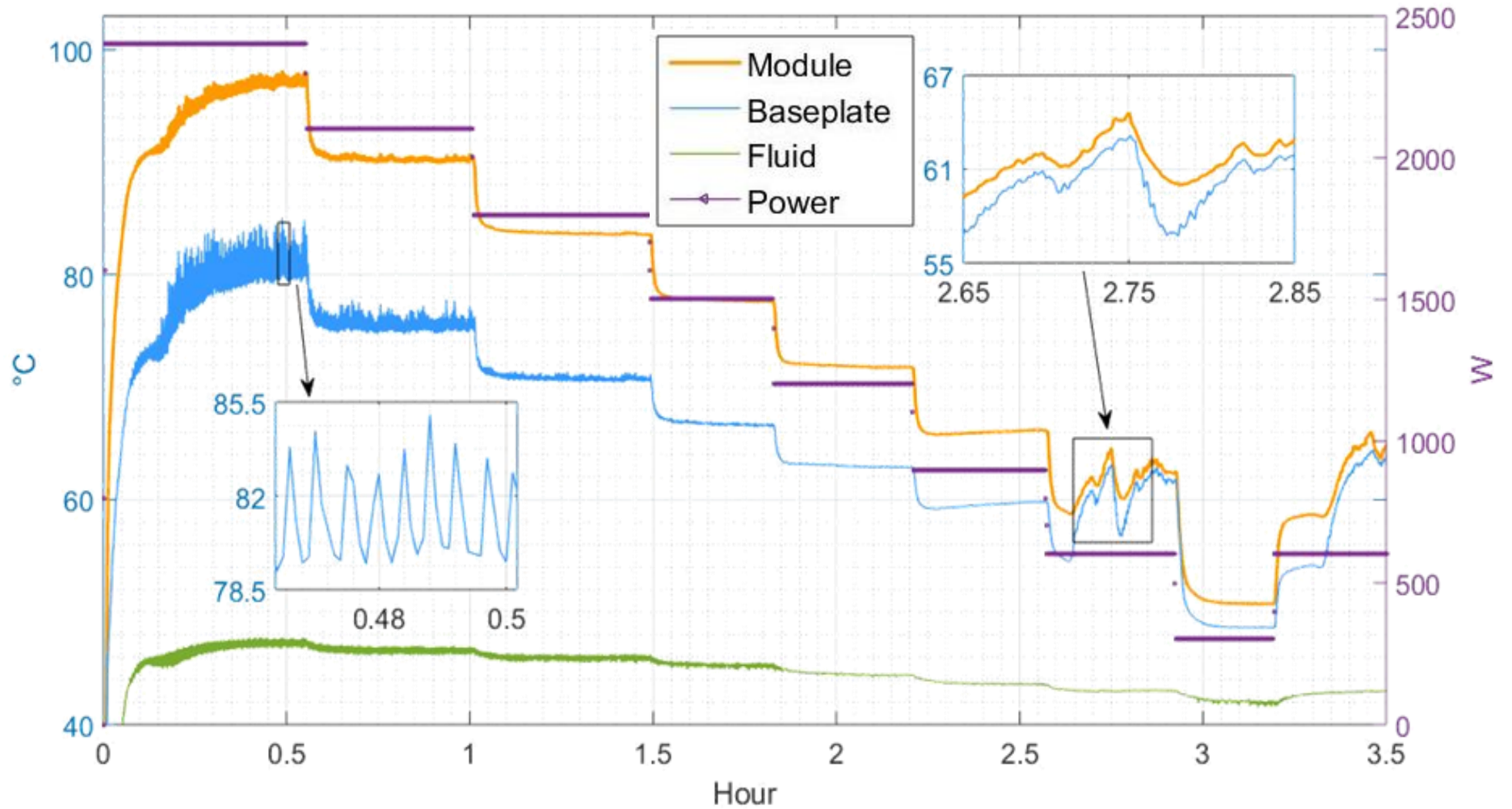



## Results : flow oscillation

x2

Previous work

Thermosiphon  
design

Results

Conclusion &  
future work

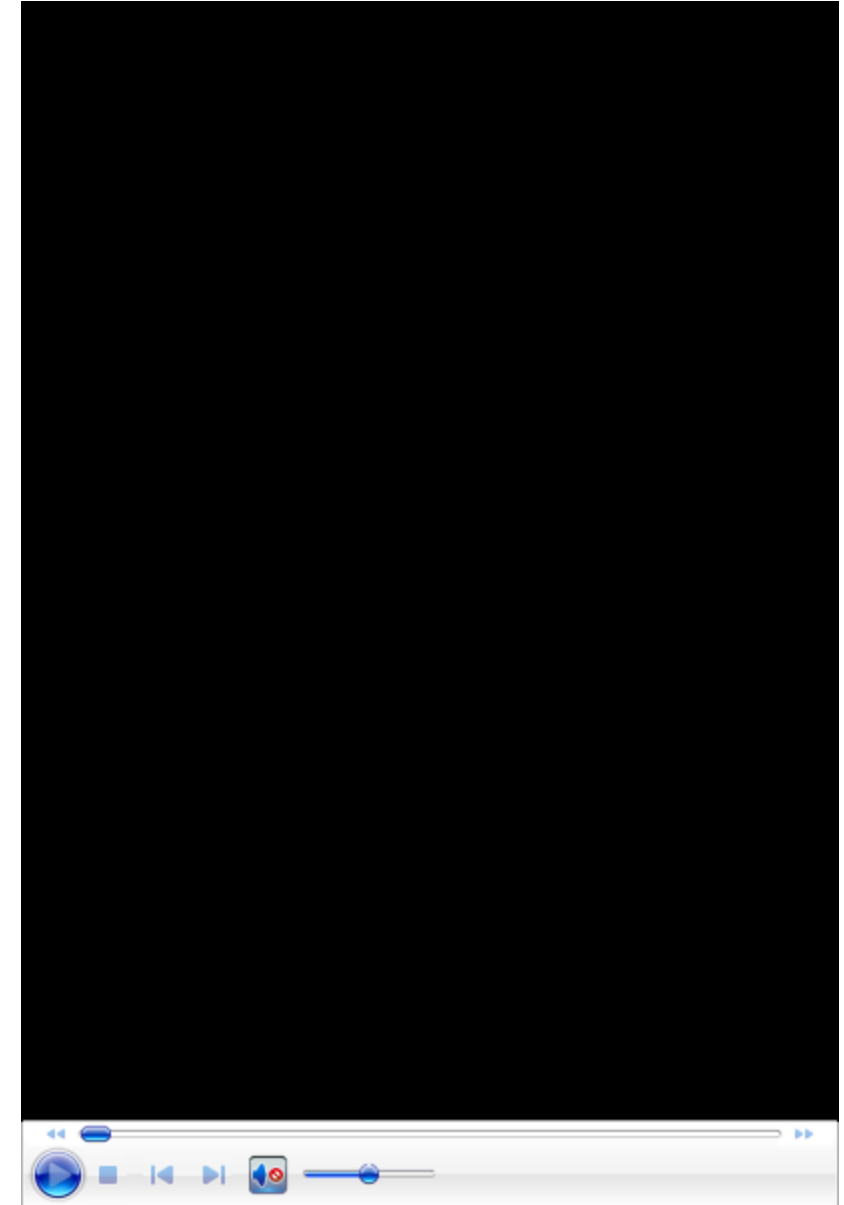
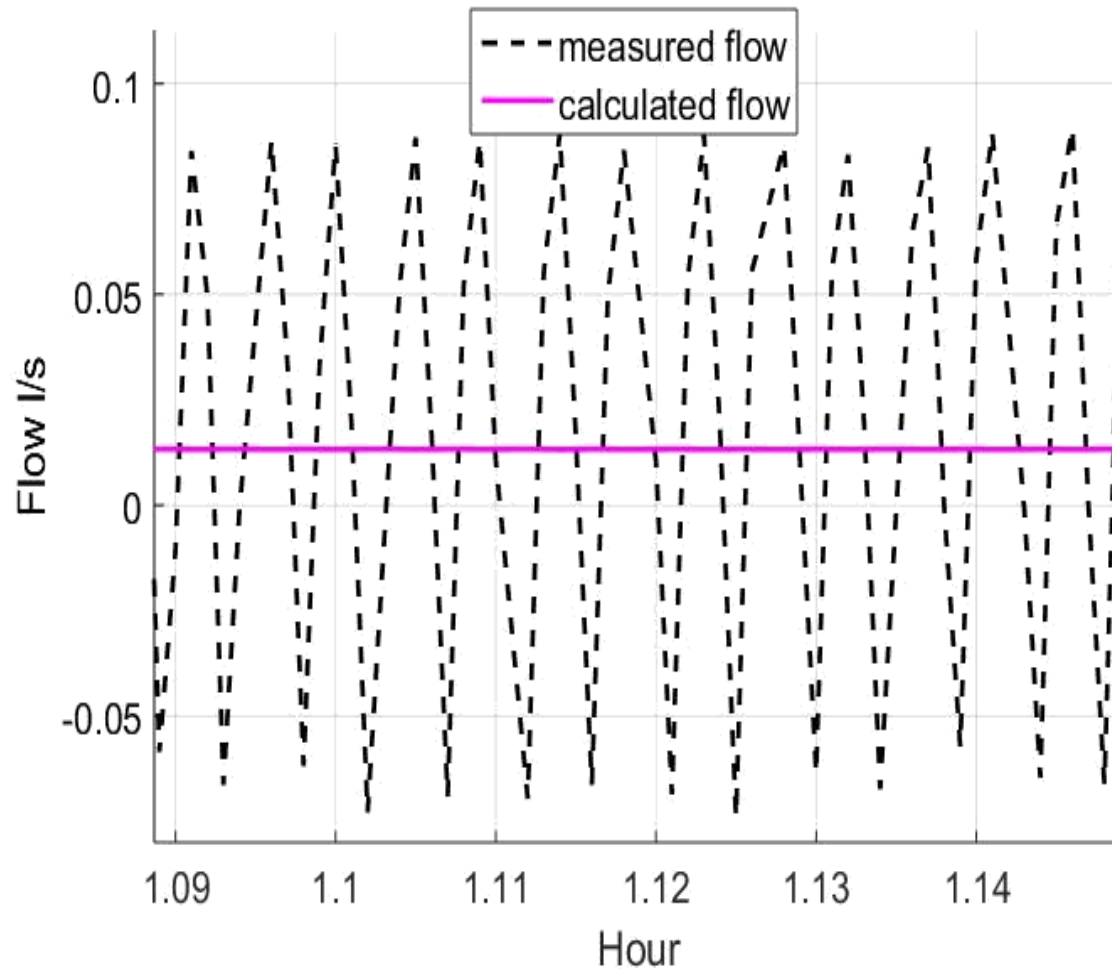

# Results : pression

Previous work

Thermosiphon  
design

Results

Conclusion &  
future work

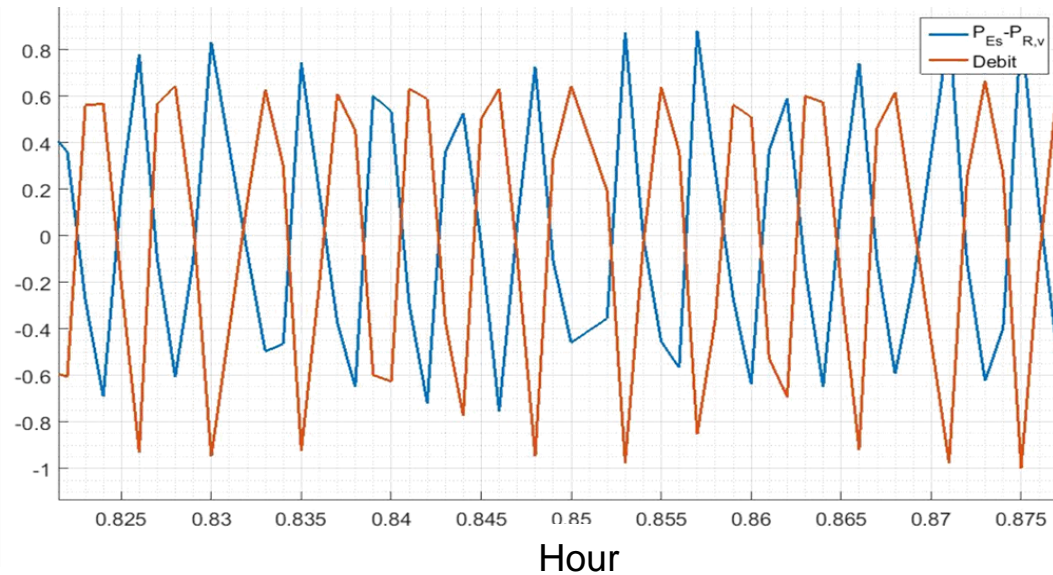
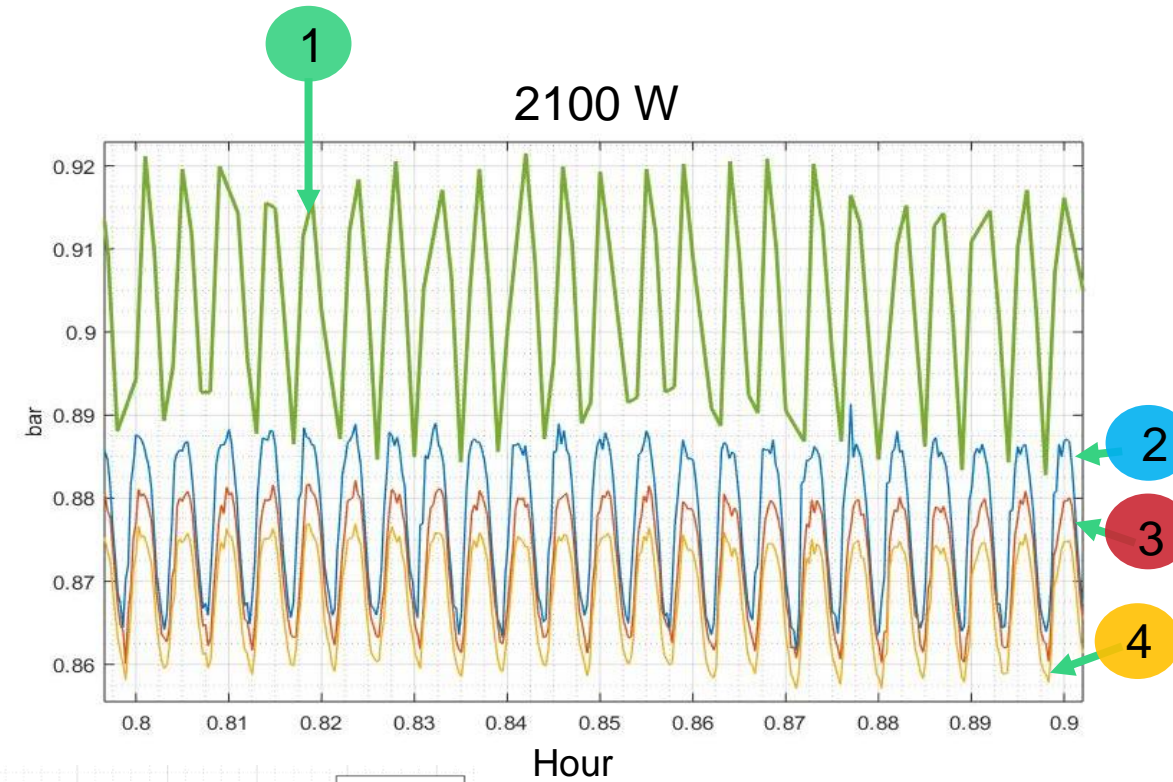
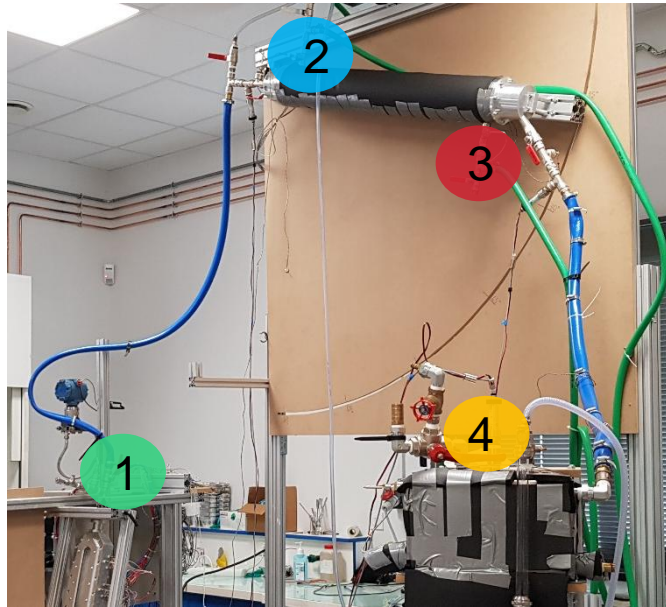



## Results : liquid flow restriction

Previous work

Thermosiphon  
design

Results

Conclusion &  
future work

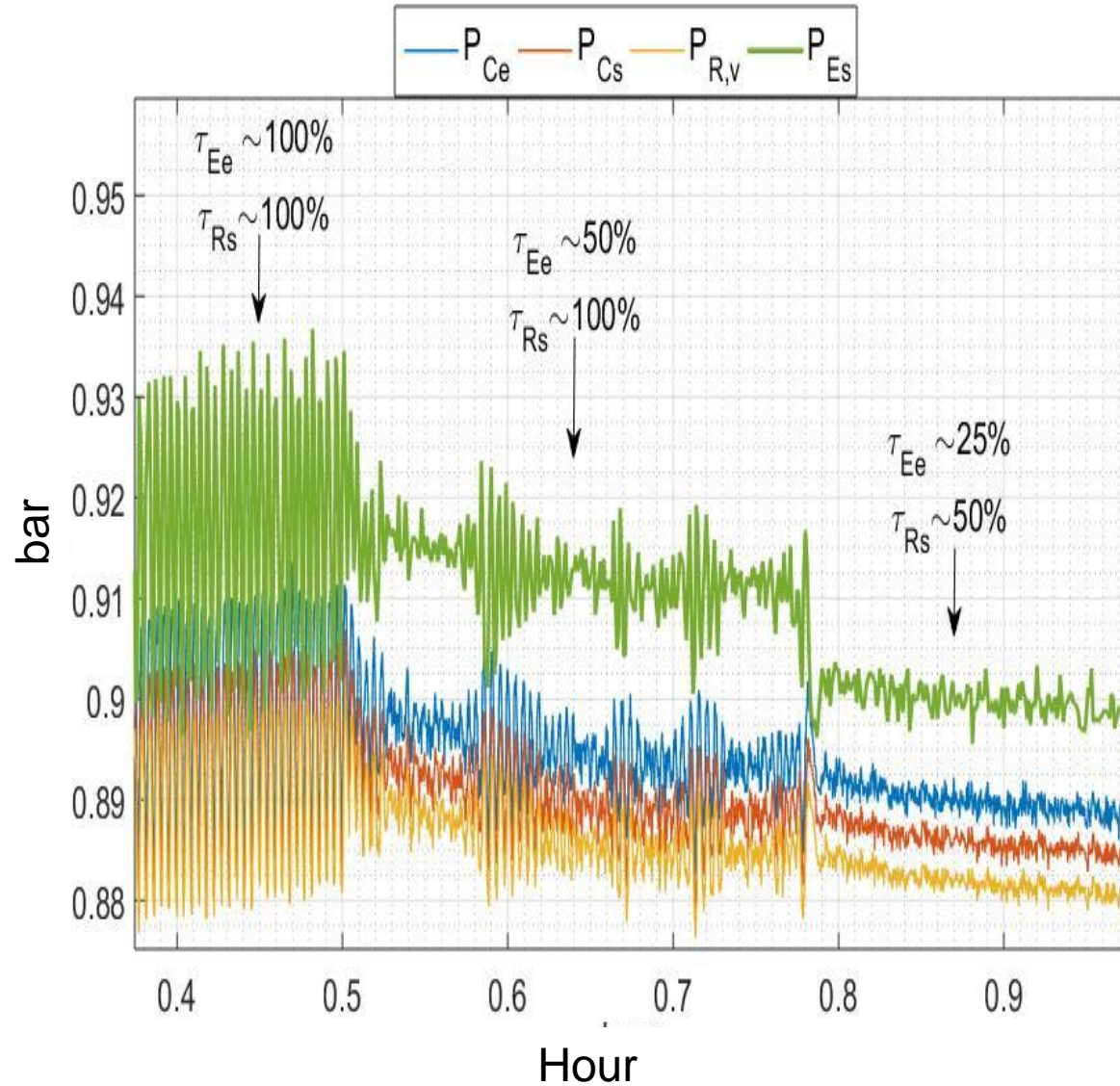



# Results : liquid flow restriction

Previous work

Thermosiphon design

Results

Conclusion & future work

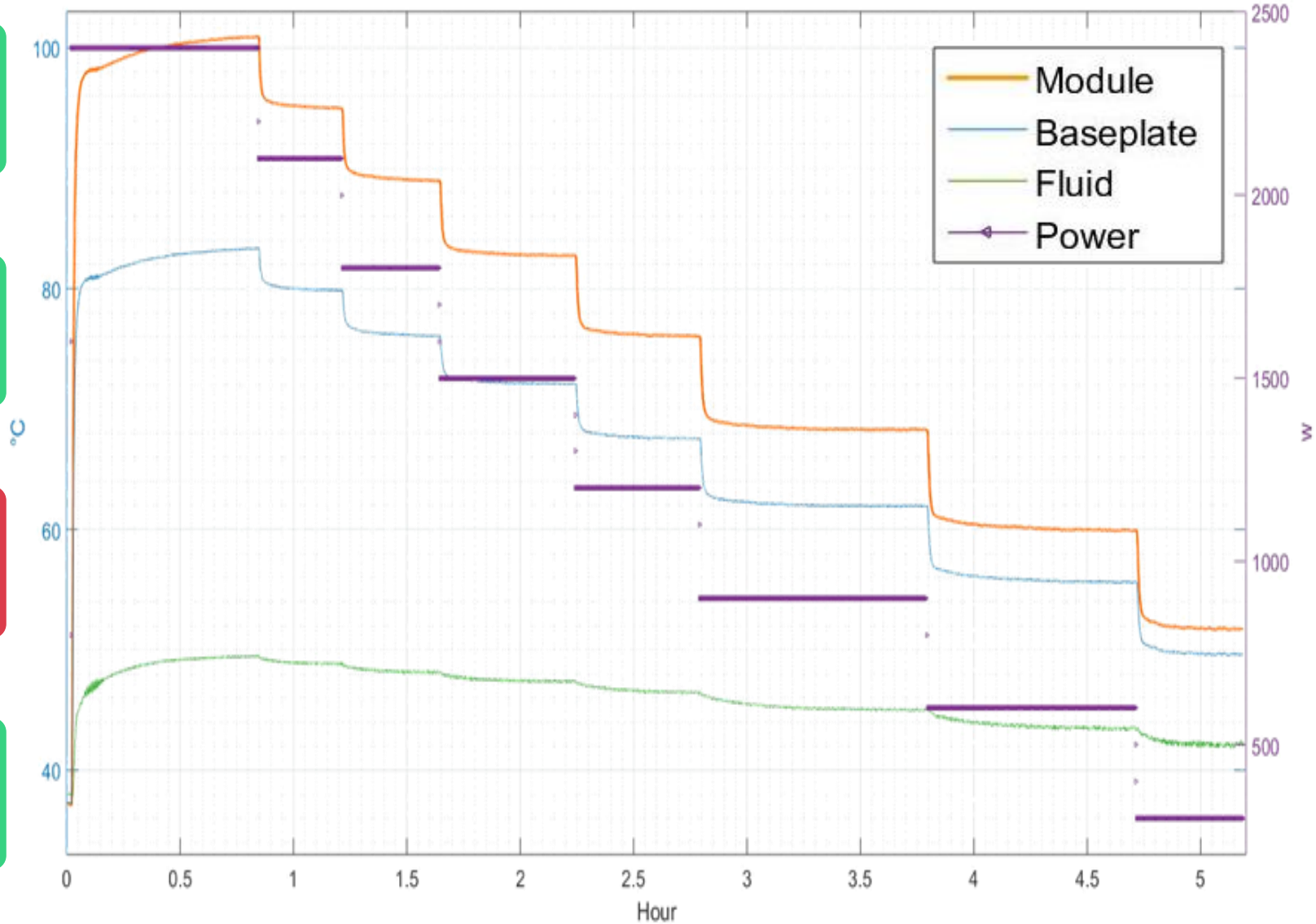

Power	Baseplate temperature
300	50,2
600	56
900	62,3
1200	67,7
1500	71,8
1800	75,4
2100	78,9
2400	81,8

## Results : liquid flow restriction

Previous work

Thermosiphon  
design

Results

Conclusion &  
future work

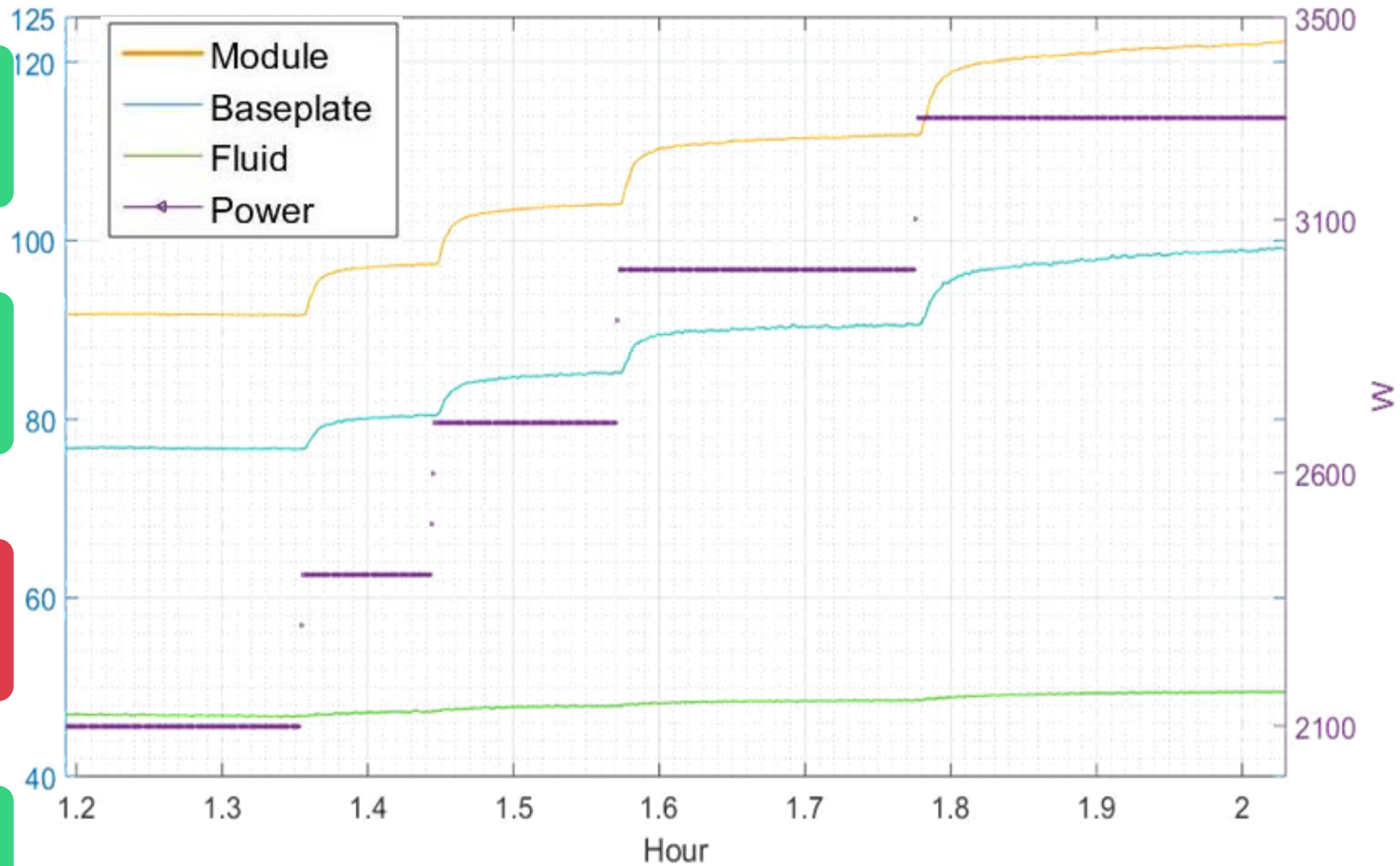

Power	Baseplate temperature
300	50,2
600	56
900	62,3
1200	67,7
1500	71,8
<b>1800</b>	<b>75,4</b>
2100	78,9
2400	81,8
2700	85
3000	90,5
3300	98,8

Restriction in the liquid line stabilizes the flow and eliminates the oscillations

## Results : thermal resistance

Previous work

Thermosiphon design

Results

Conclusion & future work

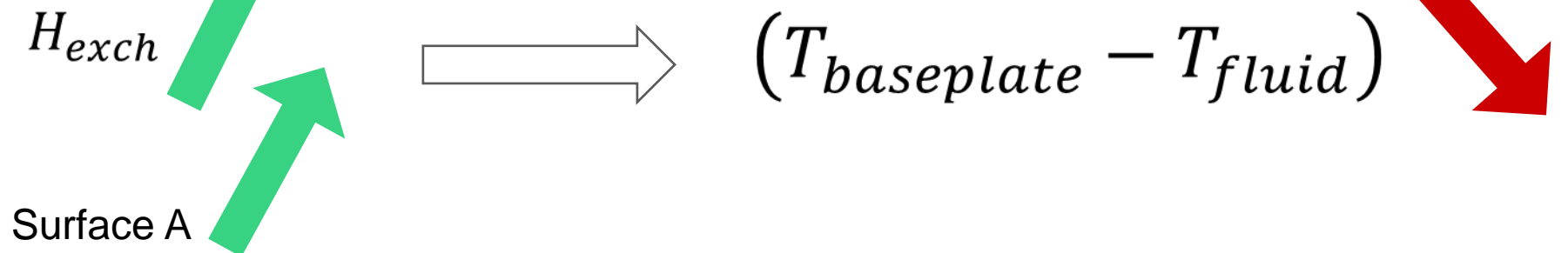
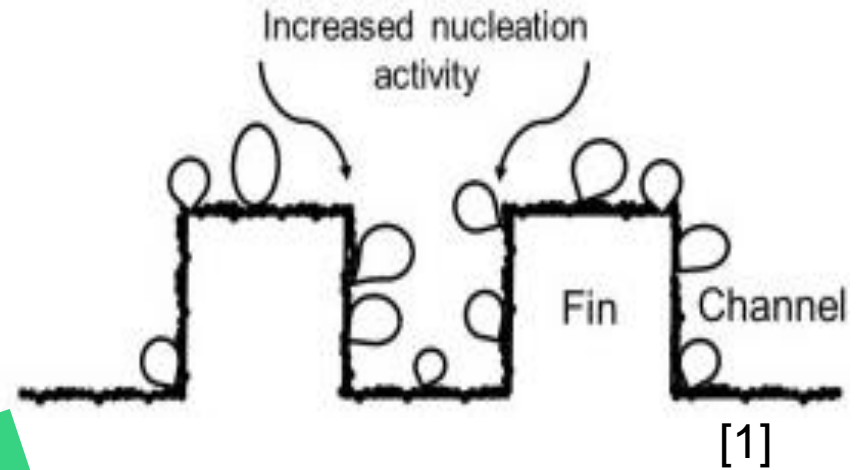



# Results : new evaporator & modified surfaces

Previous work



Thermosiphon design

Results

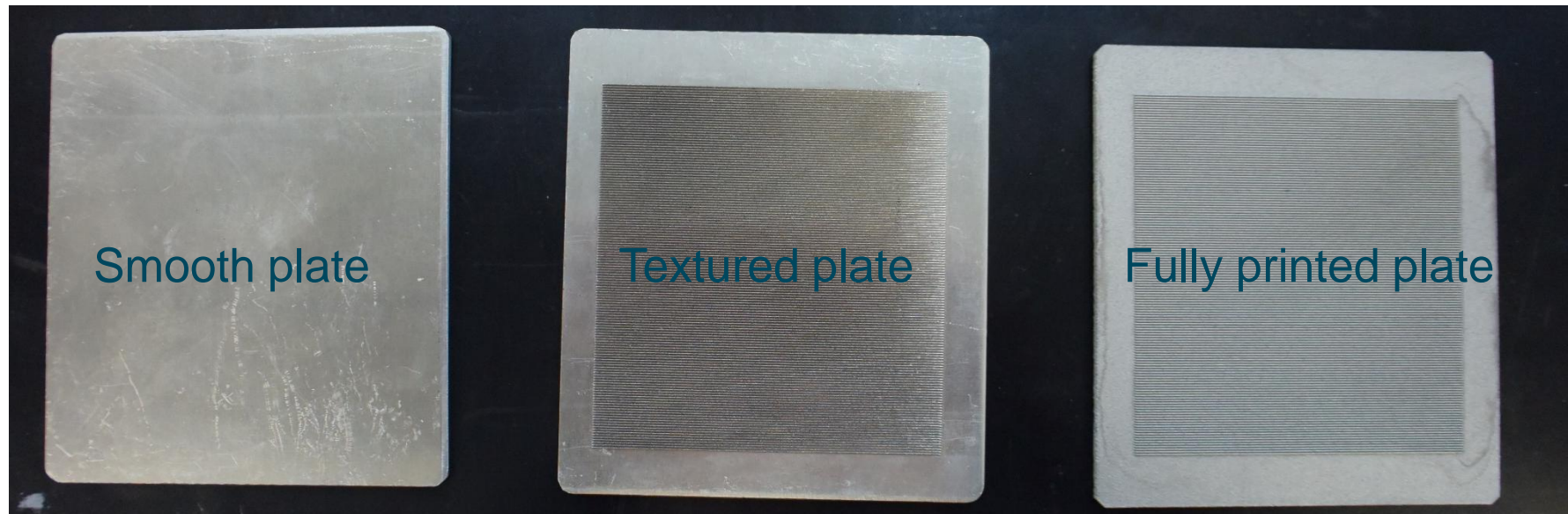

Smooth plate

Textured plate

Fully printed plate

Conclusion & future work

## Results : thermal resistance

Previous work

Thermosiphon  
design

Results

Conclusion &  
future work

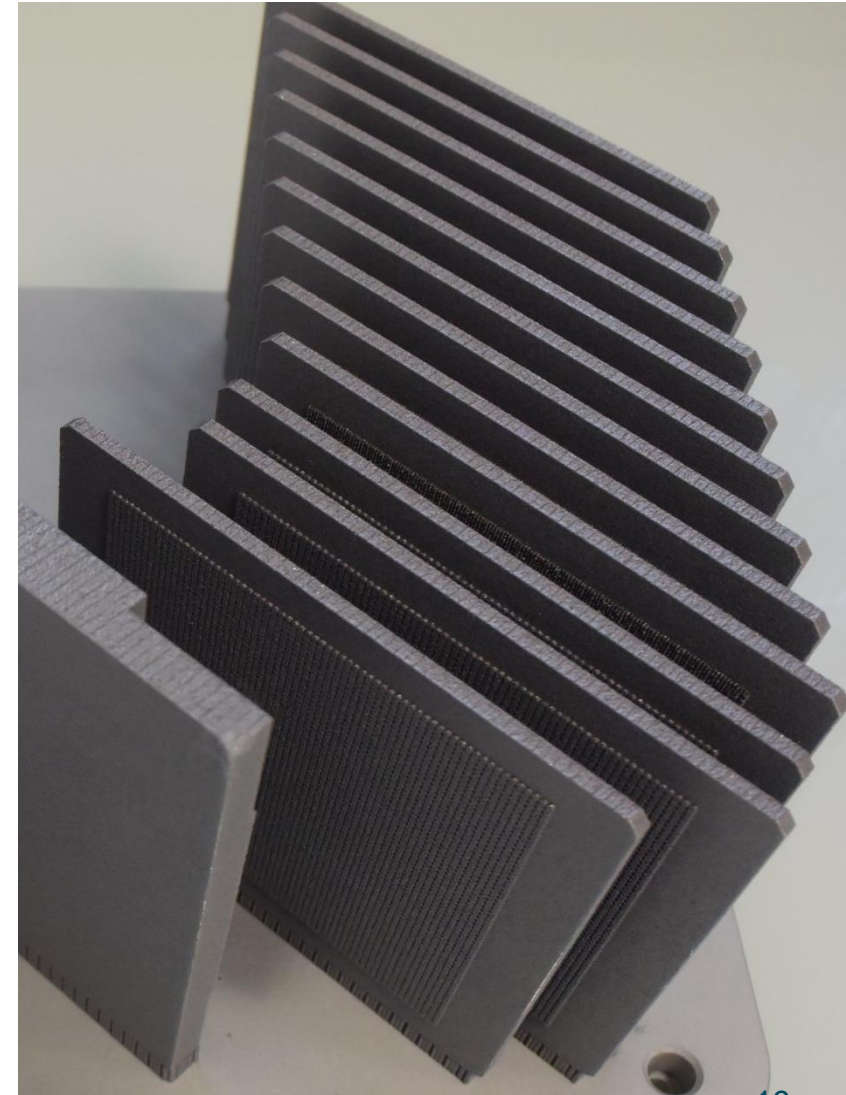
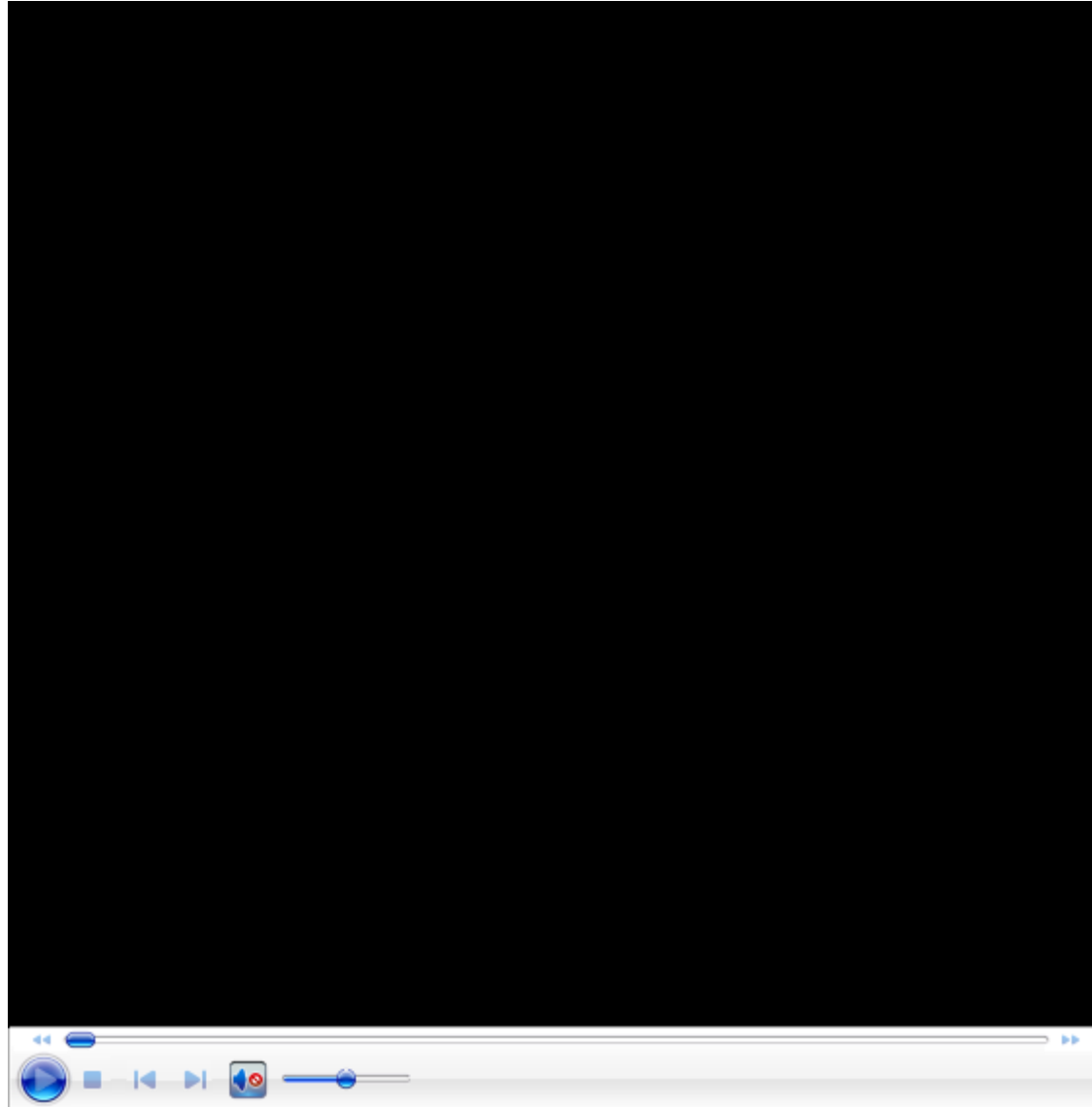

# Results : textured plates vs smooth plates

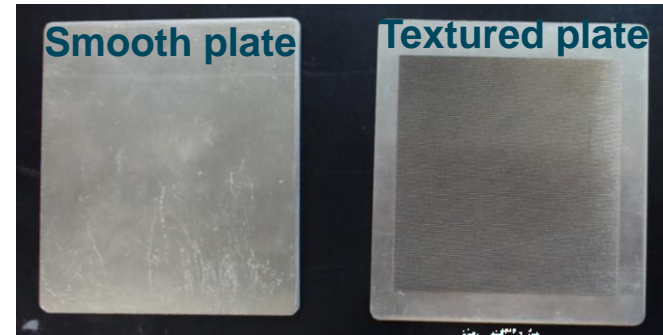
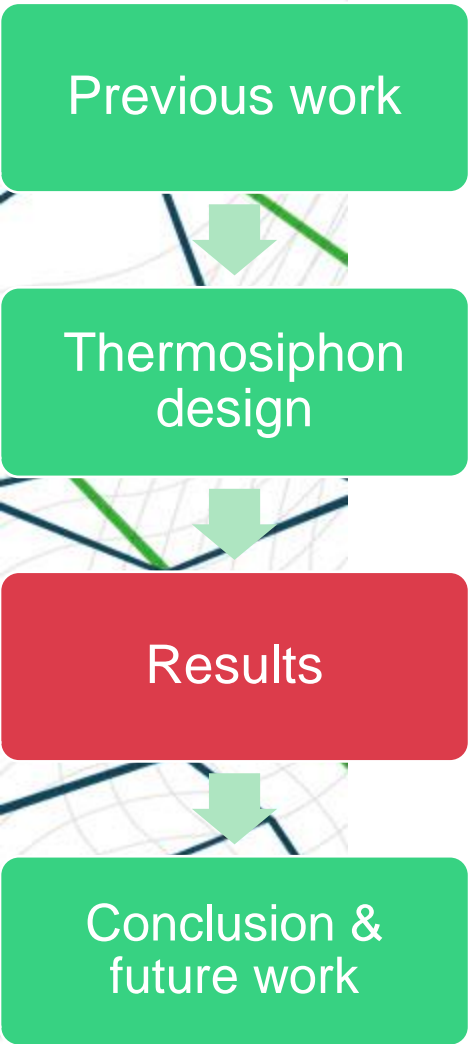

## Overheat

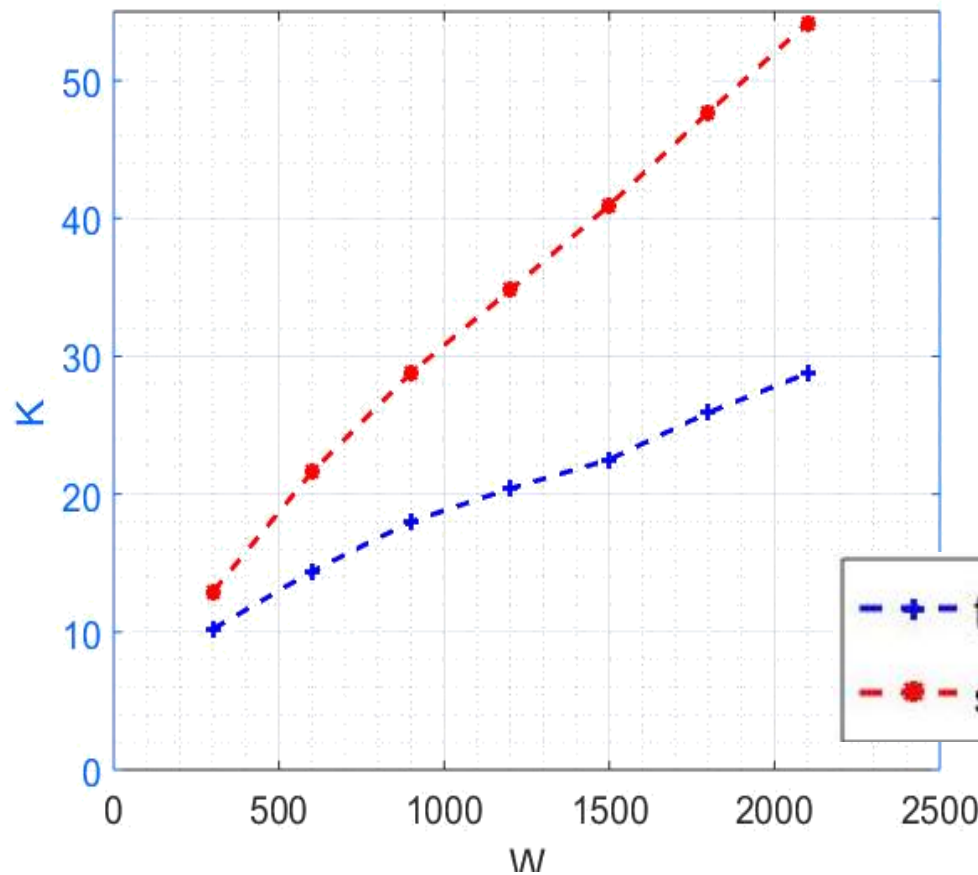

## Thermal resistance

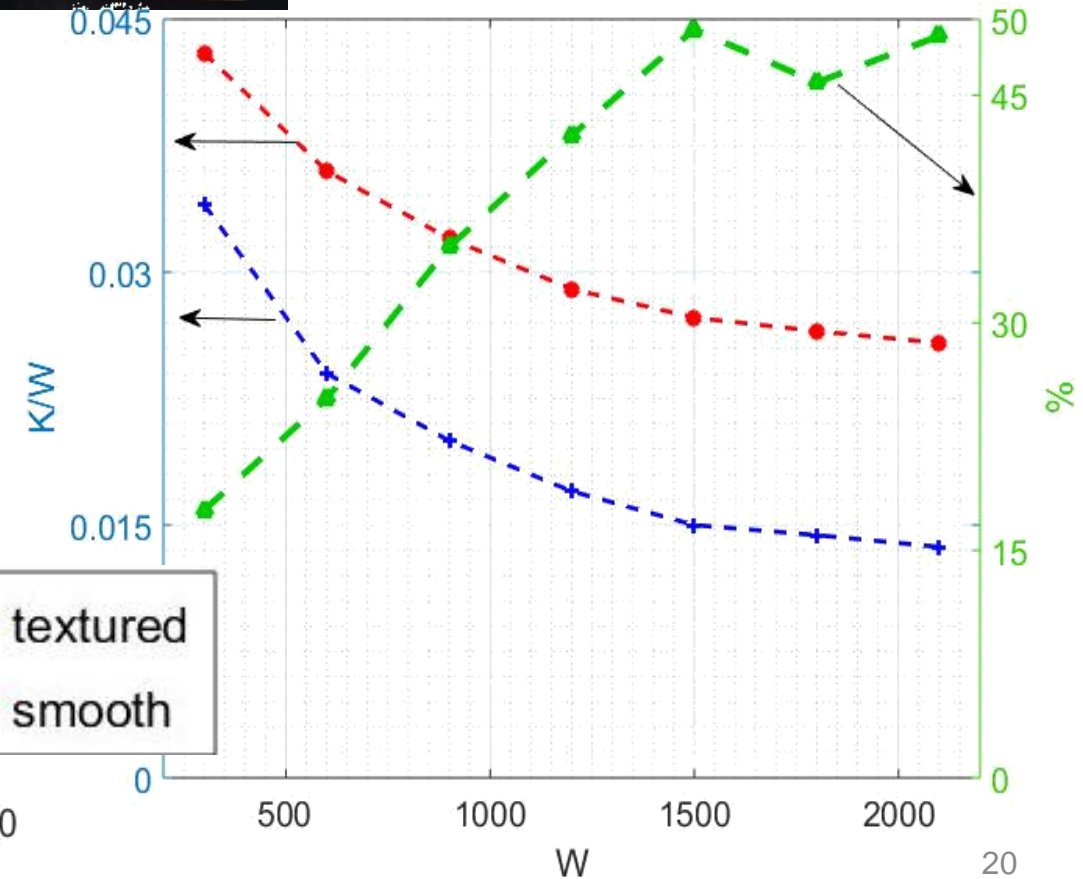



Previous work

Thermosiphon  
design

Results

Conclusion &  
future work

## Conclusions :

- ➔ Design and implementation of a full-scale test system (3kW)
- ➔ Testing and optimization of thermal response
- ➔ Enhancement of the boiling process by textured plates

## Future work :

- ➔ Testing the fully printed plates
- ➔ Implementation of the loop in real conditions in a power converter (TRL 6 & 7)
- ➔ Complete and enhance the numerical model of the loop

# Thank you for your attention

## → Q&A

majededdine.moustaid@supergrid-institute.com

## Annex 1 : geysering (x20)

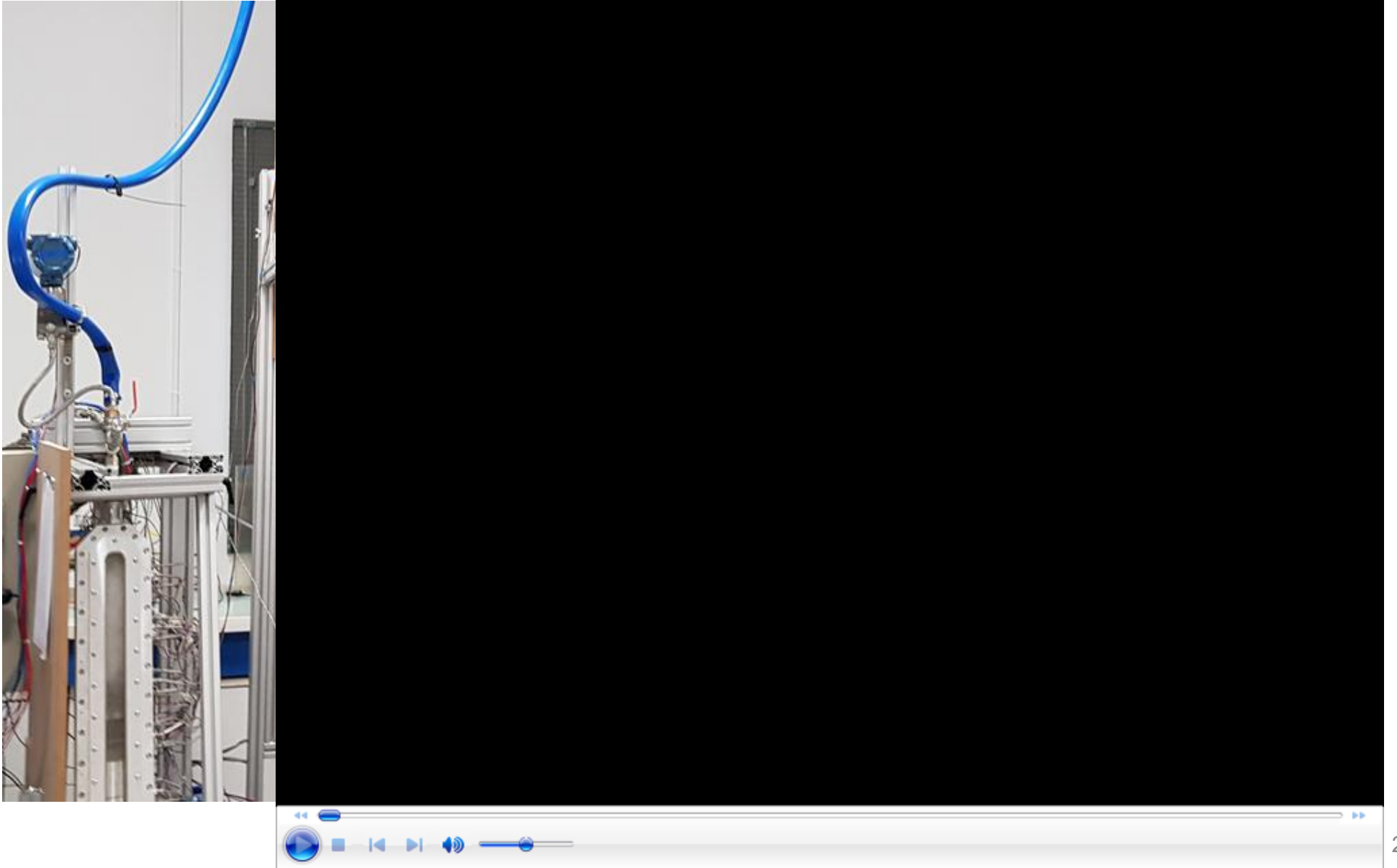



## Annex 2 : thermal response of the evaporator

