



HAL
open science

Butanol and gasoline-like blend combustion characteristics for injection conditions of gasoline compression ignition combustion mode

Tung Lam Nguyen, Camille Hespel, Dinh Long Hoang, Christine Mounaïm-Rousselle

► To cite this version:

Tung Lam Nguyen, Camille Hespel, Dinh Long Hoang, Christine Mounaïm-Rousselle. Butanol and gasoline-like blend combustion characteristics for injection conditions of gasoline compression ignition combustion mode. *Fuel*, 2019, 258, pp.116115. 10.1016/j.fuel.2019.116115 . hal-02967420

HAL Id: hal-02967420

<https://hal.science/hal-02967420>

Submitted on 20 Dec 2021

HAL is a multi-disciplinary open access archive for the deposit and dissemination of scientific research documents, whether they are published or not. The documents may come from teaching and research institutions in France or abroad, or from public or private research centers.

L'archive ouverte pluridisciplinaire **HAL**, est destinée au dépôt et à la diffusion de documents scientifiques de niveau recherche, publiés ou non, émanant des établissements d'enseignement et de recherche français ou étrangers, des laboratoires publics ou privés.



Distributed under a Creative Commons Attribution - NonCommercial 4.0 International License

1 Butanol and gasoline-like blend combustion characteristics for injection conditions of Gasoline Compression Ignition
2 combustion mode

3 Tung Lam Nguyen^{*a,b}, Camille Hespel^a, Dinh Long Hoang^c, Christine Mounaïm-Rousselle^a

4 ^a Univ. Orléans, INSA CVL, PRISME, EA 4229F45072 Orléans, France

5 ^b Univ. Transport and Communications, Hanoi 117200, Vietnam.

6 ^c Hanoi Univ. Science and Technology, Hanoi 113400, Viet Nam

7 **Corresponding and Contact Author:**

8 Tung Lam Nguyen

9 Université d'Orléans- Laboratoire PRISME

10 Polytech Orléans

11 8 rue Léonard de Vinci, 45072 – Orléans Cedex 1

12 Phone: +33-02-38-49-47-28

13 Fax.: +33-02-38-41-73-83

14 Email: tung-lam.nguyen@etu.univ-orleans.fr and lamnt@utc.edu.vn

15 Submitted for consideration at the Fuel journal.

16 **Abstract**

17 As bio-butanol would be one promising alternative fuel to mitigate the energy crisis and reduce the environmental
18 impact of the automotive sector, its potential as blend in gasoline has been widely evaluated especially for conventional Spark
19 Ignition engines. But recent studies prove that Gasoline Compression Ignition operating mode could be a future interesting
20 advanced combustion mode to reach higher efficiency and lower pollutant emissions than conventional SI engines. The
21 objective of this paper is to underline the effect of butanol blend in gasoline in injections conditions needed in GCI by set
22 experimental study in a High Pressure/ High Temperature chamber. Therefore, first data about sprays and combustion
23 characteristics as a function of the butanol content in a gasoline surrogate (PRF80) at injection conditions of GCI, i.e. high
24 pressure (6 MPa) and high-temperature (900 K) conditions but with injection pressure of 40 MPa are given and the results
25 discussed thanks to kinetics simulation of ignition delays.

26 **Keywords:** n-butanol/PRF80 blend, Spray and Combustion Characterization, Flame Lift-Off Length, Ignition Delay.
27

28 **1. Introduction**

29 We are now aware that global energy resources and environmental impacts are major issues for the future of our
30 society. Concerns over future petroleum supply and environmental degradation from fossil fuels have led to substantial interest
31 in the production and use of biomass-derived fuels, due to their global impact on CO₂ production. Second-generation biofuels,
32 manufactured from various types of biomass (wood, plant waste, and more generally lignocellulose material) are superior to
33 the first generation, from food crops (i.e. ethanol and biodiesel) in terms of energy balance, reduction of greenhouse gas
34 emissions and food security. Bio-butanol is one of these second-generation biofuels, well suited for Internal Combustion
35 Engines due to its similar physical properties to engine fuel. In comparison with ethanol, n-butanol is more compatible with
36 existing engines when blended with conventional gasoline or diesel fuels, thus avoiding phase separation and increasing cost-
37 effectiveness in the transportation infrastructure [1].

38 Even if the CO₂ impact of Compression Ignition (CI) engines is lower than that of Spark Ignition (SI) engines due to
39 their higher efficiency, NO_x and soot emissions remain an important drawback as stringent emission legislation demands a
40 continued reduction in engine-out emissions. Therefore, over the last few decades, several advanced combustion concepts
41 based on low temperature combustion have been introduced in order to reduce pollutant emissions from CI engines. As
42 example, Homogeneous Charge Compression Ignition (HCCI), characterized by spontaneous auto-ignition of a lean premixed
43 fuel/air mixture, allows ultra-low NO_x and soot emissions compared to the traditional diesel combustion mode. But it has some
44 disadvantages such as: (1) difficulty controlling HCCI combustion as the auto-ignition process depends on pressure,
45 temperature, O₂ concentration, diluent and fuel properties; (2) high acoustic noise at high loads; (3) high HC and CO emissions
46 at low loads.

47 To overcome the limitations of the CI and HCCI combustion modes, some other combustion concepts, such as Partially
48 Premixed Combustion (PPC), have been developed. By replacing the strongly reactive fuel, i.e. diesel type, by a less reactive
49 one, i.e. gasoline type, emissions can be drastically reduced [2–7]. Gasoline Compression Ignition is a potential strategy to
50 achieve high specific power, high fuel efficiency, as well as low soot and NO_x emissions. The reduction of the temperature
51 inside the cylinder and the ignition delay time extension are two ways to achieve PPC as an advanced combustion method,
52 offering low NO_x and soot emissions. Dempsey et al. [8] provided recently an interesting analysis about the effect of
53 stratification process obtained by different multiple-injection strategies on the emission (NO_x/HC/CO and smoke) and engine
54 performance. They reminded that due to its longer ignition delay, gasoline like fuels allows a better mixing in the cylinder with
55 the ambient air prior the combustion. Thanks to multiple-injection strategy, a portion of the fuel is well “premixed” with air
56 and the post-injection timing allows the control of the start of ignition or combustion. Labreche et al. [9] studied the effect of
57 the second injection phasing and concluded that even if the first injection is early, the second one has to be adjusted near the

58 Top Dead Center (TDC), so the fuel is injected in conditions similar to Conventional Diesel Combustion but due to the
59 physical specificities of gasoline type fuel, the injection pressure has to be adjusted, as confirmed in [10].

60 Manente et al. [11] explored the impact of the octane number range from 70 to 100 on the optimization of GCI
61 combustion. They concluded their study by the suggestion that the change of chemistry affects more the combustion and the
62 pollutant emissions than the mixing itself. Cung et al. [12] studied also the effect of three different type of gasoline fuels with
63 different chemical composition but similar RON (Research Octane Number). Most of studies done about alcohols fuel in GCI
64 combustion modes concern ethanol as in [13–16], with a positive effect on soot emission and also the confirmation that the
65 best injection strategy remains the double injection one as in [17]. But only few studies are focused on the possibility to use
66 butanol blend for GCI applications. As example, in [18], the first investigation indicated also that adding n-butanol improves
67 the oxidation of CO and HC emissions slightly, but with not really NO_x emissions. Yang et al. [19] studied also the combined
68 effects of EGR and adding n-butanol to improve soot emissions. But butanol offers many advantages in comparison to ethanol
69 due to its physical and chemical specificities as its lower vaporization heat, higher miscibility with gasoline, higher cetane
70 number

71 More studies are carried out about the effect of butanol addition to gasoline surrogates on the auto-ignition process
72 without consider the mixing processes as in a constant volume combustion device and homogeneous charge compression
73 ignition engine [20], or a shock tube [21] or in rapid compression machine [22]. But the lack of studies and data available on
74 the butanol addition effect on the spray/combustion characteristics under GCI conditions as done in [23] for gasoline suggested
75 the present study.

76 Therefore, the objective of this study was to carry out experiments in a High-Pressure/High-Temperature facility to
77 characterize the effect of n-butanol on the spray and combustion processes for different butanol-PRF80 blends by considering
78 the second injection conditions as in GCI combustion mode. For that, as the optimized condition was found near Top Dead
79 Center, the standard conditions, defined by Engine Combustion Network (<https://ecn.sandia.gov/>), are considered (900 K
80 ambient temperature and 6 MPa ambient pressure, i.e. Spray A) but with a lower injection pressure (40 MPa). The impact of
81 butanol blend on liquid and vapor spray penetration, the ignition delay and the flame lift-off length is given for the first time to
82 provide dataset to improve future modelling works. Some results from autoignition computations based on a detailed kinetic
83 mechanism are provided to help the discussion about the impact of n-butanol in these conditions.

84 **2. Experimental approach**

85 ***2.1 Experimental facility***

86 The High-Pressure/High-Temperature vessel, called NOSE (New One Shot Engine) is fully described in [24,25]. It is
87 based on a single cylinder engine (155 mm bore diameter and 177.8 mm stroke), driven by an electric motor (Figure 1). The

88 revolution speed of the electric motor is controlled as a function of the crank angle to obtain a plateau near the TDC with
89 constant thermodynamic conditions. The combustion chamber was designed to support optical measurements.

90 The working mode of NOSE starts by setting the initial conditions (pressure and temperature) and intake ambient gas
91 composition. So, after creating a vacuum, different gases (N_2 or N_2/O_2) are injected into the chamber thanks to a mass flow
92 controller (Brooks instruments). The initial temperature is specified by controlling the temperature of the water around the
93 liner and of four heaters located in the cylinder head and set at $90\text{ }^\circ\text{C} \pm 0.5\text{ }^\circ\text{C}$. Two type-K thermocouples are installed inside
94 the chamber and near the injector to measure the gas temperature inside the chamber and the casing temperature, respectively
95 to control the temperature of the chamber and of the ambient gases before injection and combustion. In [25], the homogeneity
96 of the temperature field was verified at different locations in order to validate this set-up as ECN standard set-up A high
97 frequency piezo-electric pressure sensor (KISTLER 7001) is installed at the chamber head and is coupled to a charge amplifier
98 (KISTLER 5011).

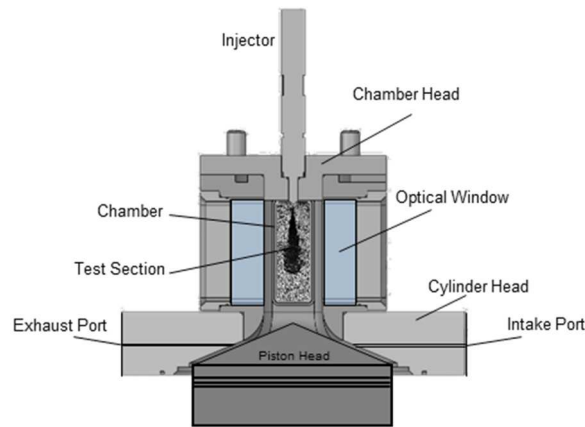

99
100 *Figure 1. The NOSE chamber: cross-section view*

101 The cylinder pressure, temperature inside the vessel, driven current of the injector, photomultiplier signal and crank
102 angle are recorded as a function of time with a National Instruments CompactRIO at 250 kHz. The injection system consists of
103 the following components: (1) a high pressure pneumatic pump, (2) a high pressure line, and (3) a common rail. The respective
104 fuel for each test was provided to the injection by a high pressure pneumatic pump MAXIMATOR M189 DVE-HD driven by
105 an air piston pump to maintain pressure before injection, controlled by a PID system with a pressure regulator.

106 The single-hole CRI 2.16 Bosch was used as ECN Spray A specification. The nozzle was 0.0885 mm in diameter and
107 the k-factor was 1.5. The nozzle tip of the fuel injector was held at a constant temperature of 363 K by circulating coolant
108 during operation. The injection duration was set to 3 ms. In the case of inert conditions, 100% N_2 was introduced to prevent
109 ignition and for reactive conditions an oxygen molar fraction of 21% was added. The injection pressure of 400 bar was based
110 on previous studies about Gasoline Compression Ignition [7,10].

111 This experimental facility achieve High-Pressure/High-Temperature conditions with a high repeatability. The

112 observed shot-to-shot variations are respectively 1.6%, 1%, 0.5%, 4.5% and 5% for ambient temperature, ambient pressure,
 113 oxygen rate, density and injection pressure. According to the models used in the manuscript, its variations imply an accuracy
 114 of 5%, 8%, 13% and 8% for the measurement of liquid penetration, vapour penetration, lift-off length and ignition delay
 115 respectively.

116 **2.2 Measurement techniques**

117 The optical techniques set up around the NOSE chamber were fully described in [24]. These techniques are based on
 118 ECN requirements with signal processing tools. Table 1 summarizes the optical setup for both inert and reactive atmosphere to
 119 characterize macroscopic combustion parameters. Figure 2 shows the scheme of the optical setup for reactive conditions.

120 *Table 1. Summary of the optical setup*

	Inert atmosphere		Reactive atmosphere	
Studied Parameters	Liquid length	Vapor Spray	Ignition delay	Lift off length
Optical Technique	DBI	Schlieren	OH* Chemilu.	OH* Chemilu.
Camera/ Detector	Phantom - V1611		Newport PMT 70680	Photron - APX-I2
Sensor type	CMOS		PM	ICCD
Light source	LED plate	LED	-	-
Lens/ Mirrors	60 mm (f/2.8)	2 Parabolic Mirrors (34 inches diameter) Pinhole of 6 mm	-	UV 60 mm (f/3.5)
Pin hole (mm)		6	-	-
Filter	-	-	BPF 307 nm FWHM 10 nm	BPF 310 nm FWHM 10 nm
Frame speed (kHz)	49	39	2	39
Exposure time (μ s)	3	5	-	499
Image size (pix^2)	512 x 384	1024 x 400	-	512 x 1024
Magnification (pix/mm)	12	12.3	-	18.2

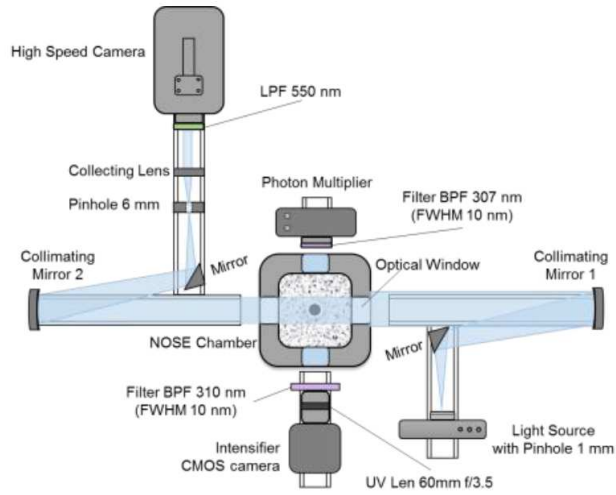

Figure 2. Scheme of optical setup for reactive atmosphere

121

122

123

124

Some images or signals obtained from these different techniques are plotted in the following sections to illustrate the quality of the set-ups.

125

2.3 Fuels

126

127

128

129

130

131

132

As the objective of this study is to provide data and some understanding about the effect of blending butanol in gasoline in the Gasoline Compression Ignition mode, PRF80 was chosen as the gasoline surrogate and different quantities of butanol in volume were added with an increment of 20%, denoted Bu0, Bu20, Bu40, Bu60. The main properties of the pure fuels and blends are given in Table 2. The properties of the blends were estimated by weighted the value of each single component with its volumetric fraction. Viscosity of pure n-heptane, iso-octane, n-butanol and all blends was measured by viscosity meter. As expected due to the pure butanol properties, the increase of butanol amount increases the density and viscosity while the lower heating value decreases. This should be considered to supply the same amount of chemical energy.

133

134

135

136

137

Several studies have been carried out to identify the best way to estimate the Research Octane Number for alcohol and gasoline mixtures [26,27]. Because of the higher molecular weight of butanol, closer to that of gasoline, their molar and volumetric concentrations are similar, and there is no significant difference in blend octane number estimations for these compounds using volumetric or molar concentrations. The research octane number (RON_{blend}) of n-butanol blends was calculated by RON prediction of a linear molar-weighted model [26] given by:

138

$$RON_{blend} = (1-x_{mole}).RON_{PRF80} + x_{mole}.RON_{n-bu} \quad \text{Eq. 1}$$

139

140

141

142

in which: $RON_{PRF80} = (1-y_{mole}).RON_{iso-octane} + y_{mole}.RON_{n-heptane}$, where x_{mol} is the molar fraction of n-butanol in the blend; y_{mol} is the molar fraction of n-heptane in PRF80. One effect of the addition of n-butanol as in Table 2, is the decrease of the reactivity quality as predicted the estimate of the RON by Eq.1, which is important in the case of PPC combustion mode. Moreover, its higher evaporative cooling effect than gasoline also contributes to increase the ignition delay.

Table 2. Fuel properties of Primary reference fuels

Properties	n-heptane	iso-octane	PRF80	n-butanol	Bu20	Bu40	Bu60
Molecular formula	C_7H_{16}	C_8H_{18}	$C_{7.8}H_{17.6}$	C_4H_9OH	$C_{7.04}H_{15.88}-$ $-(OH)_{0.2}$	$C_{6.28}H_{14.16}-$ $-(OH)_{0.4}$	$C_{5.52}H_{12.44}-$ $-(OH)_{0.6}$
M_f , Molar weight [g.mol ⁻¹]	100	114	11.2	74	103.76	96.32	88.88
Oxygen content [%]	-	-	-	21.6	3.08	6.64	10.8
ρ_f , Density at 15 °C [kg.dm ⁻³]	0.684	0.692	0.6904	0.8098	0.718	0.742	0.765
ν_f , Viscosity at 15 °C [mm ² .s ⁻¹]	0.344	0.504	0.452	4.142	0.705	1.212	1.901
ν_f , Viscosity at 40 °C [mm ² .s ⁻¹]	0.214	0.336	0.268	2.211	0.451	0.724	1.050
ν_f , Viscosity at 70 °C [mm ² .s ⁻¹]	0.014	0.144	0.065	1.130	0.205	0.318	0.472
LHV , Lower heating value [MJ.kg ⁻¹]	44.6	44.3	44.36	33.1	42.11	39.86	37.60
L_v , Latent heat of vaporization at 298 K [kJ.mol ⁻¹]	31.6	31.01	31.13	43.07	33.52	35.90	38.29
Air-fuel stoichiometric (mass) ratio	15.14	15.09	15.10	11.21	14.32	13.54	12.77
RON (linear molar-weighted model)	0	100	80	96	83.2	86.6	89.6
Boiling point at 1 atm [°C]	98.38	99.3		117.8			
P_v , Vapor pressure at 298 K [kPa]	4.6	5.5		0.58			
Auto-ignition temperature [°C]	220	396		343			
c_{pf} , Specific heat at 15 °C [kJ/kg.K]	2.24	2.05		2.39			

144

2.4 Mass flow rates for blends

145

146

147

148

149

150

The physical parameters of the different blends can affect the global injected fuel quantity. For that, the average mass flow rate (MFR) for the injection conditions (i.e. ambient and injection pressures of 60 bar and 400 bar respectively) was measured thanks to an IAV Injection rate system (model K-025-50). As example, in Figure 3, the results of the average from 20 repetitive injections with an injection duration of 3 ms are presented for the maximum of Butanol content, i.e. 60% in vol., in comparison to PRF80. First, the initial hydraulic delay is not affected by the fuel difference, contrary to the final hydraulic one, longer in the case of Bu60. Second, the quantity of fuel injected is slightly higher in the case of Bu60 denser than PRF80.

151 Indeed, the discharge coefficient, C_d estimated as the ratio between the average MFR [3 ms – 4 ms] and the theoretical one is
 152 equal to 0.86 for these two fuels. Therefore, the energy input corresponding is 317 kJ and 300 kJ for PRF80 and Bu60
 153 respectively.

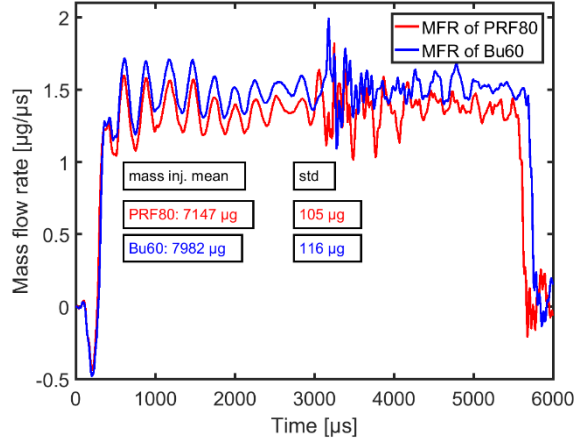

154

155

156

157 **2.5 Analysis tools**

158 • **From the in-cylinder pressure signal**

159 From the in-cylinder pressure signal, filtered with a low-pass filter, first the heat release rate (HRR) was estimated by a
 160 simple estimate of the wall-heat transfer (in order to get $HRR = 0$ before injection timing):

161
$$\frac{dQ}{dt} = \frac{\gamma}{\gamma-1} \cdot P \cdot \frac{dV}{dt} + \frac{1}{\gamma-1} \cdot V \cdot \frac{dP}{dt}$$
, with P and V the combustion vessel pressure and volume respectively. As the air was

162 assumed as the main component of the ambient, so the isentropic ratio, γ is only function of temperature. For that, the
 163 correlation of the specific heat as a function of temperature from [26] was used, with the average temperature estimated where
 164 the inlet valve closed was set at TDC.

165 This estimate helps to identify different phases of the combustion as the start of combustion (SOC), the premixed
 166 combustion and the late mixing controlled combustion phase. The ignition delay, ID, is then the time interval between the start
 167 of injection, SOI, and SOC. But as SOC is not absolute, i.e. low pressure or HRR gradient, it was also estimated by means of
 168 optical techniques as Schlieren imaging images or OH* time-resolved chemiluminescence.

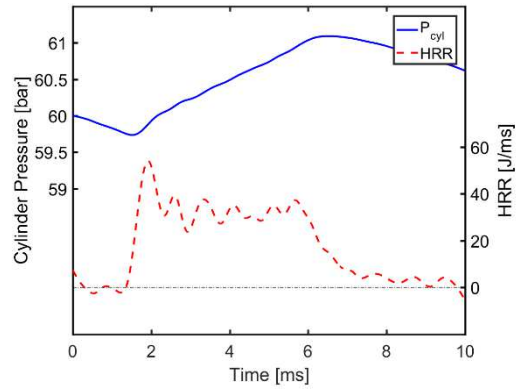

169

170

Figure 4. Typical cylinder pressure and heat release rate

171

172

173

174

To globally characterize the combustion development, BMF (Burned Mass Fraction) 10/50/90 are defined as the time durations where 10/50/90% of the heat has been released, as done for engine combustion analysis. From that, the Combustion Duration, CD, is defined as the difference between BMF90 and BMF10, i.e. the time in which 10-90% of the fuel mass has been burnt.

175

Spray parameters

176

177

178

179

180

181

An example of images obtained from the Schlieren set-up in the case of PRF80 is presented in Figure 5 in inert and reactive ambient conditions. From the contour of the spray images, the penetration length S is calculated as indicated in ECN. Figure 6 shows an example of the evolution of the liquid and vapour spray penetration lengths for PRF80: the green curves are for one condition; the red one is an average of 6 tests and the black one the average \pm the standard deviation. The plot proves that the experiments done in NOSE setup are with a good repeatability as the standard deviation is less than 3%. Therefore, only the average values of the results are given below.

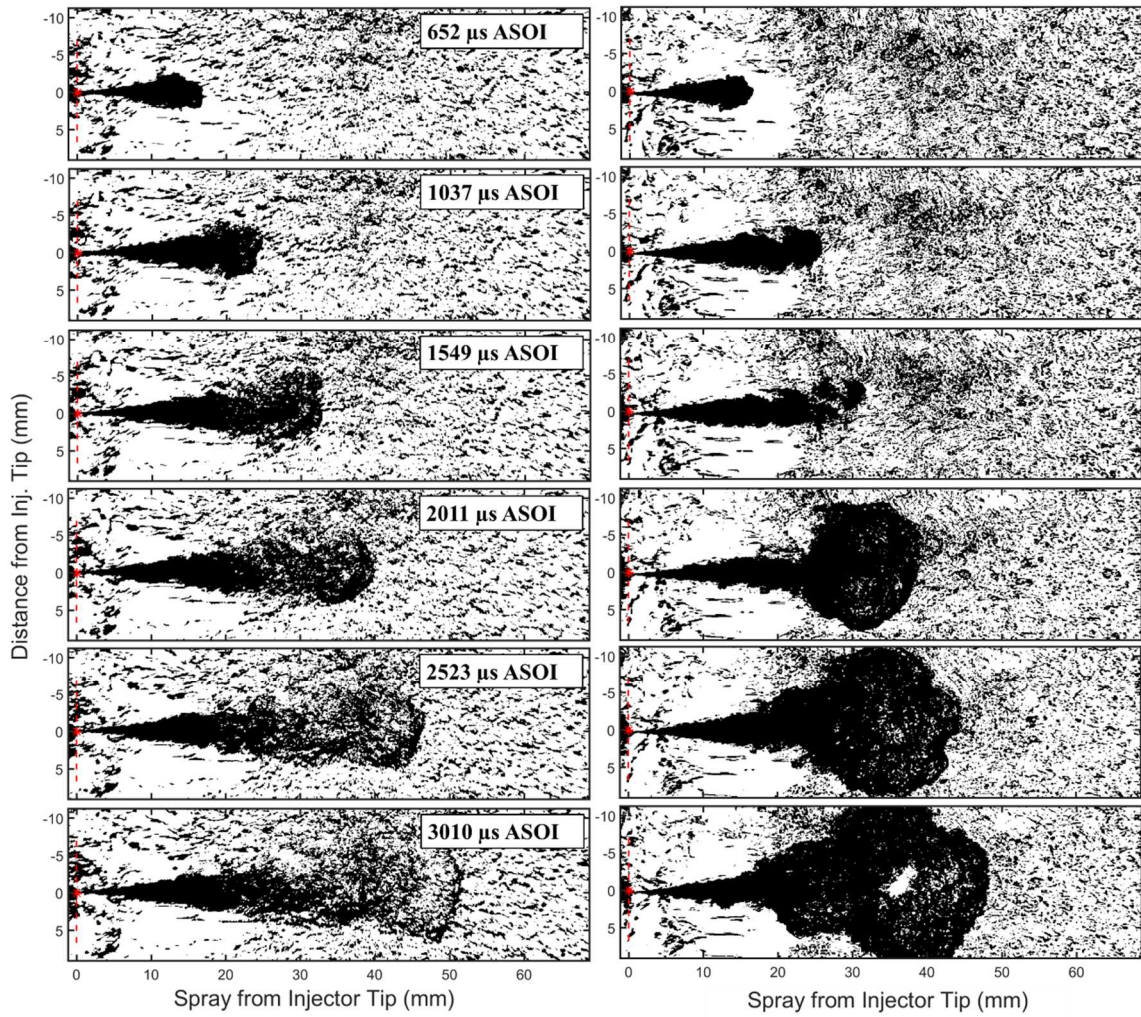

Figure 5. Schlieren images of spray with inert (left) and reactive (right) atmosphere

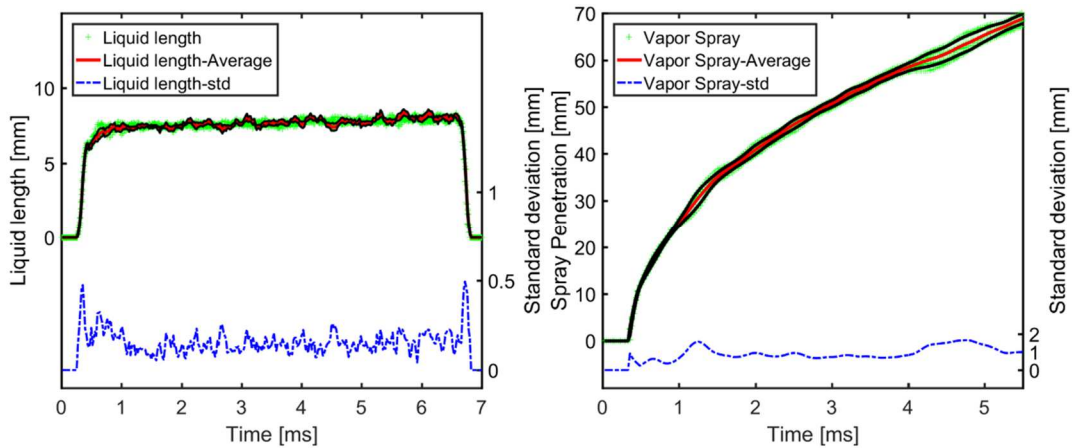
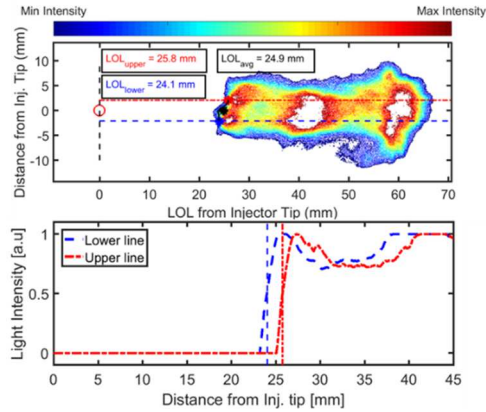

Figure 6. Evolution of the liquid and vapor spray penetration length of PRF80 with time

Combustion parameters

To determine the Lift-off-length, the approach suggested by Siebers and Higgins [29] was used. Once the combustion image has been filtered with a 3x3 pixel mean filter, the flame is divided through the axis defined from the injector tip into two profiles, a bottom and a top profile (Figure 7). The lift-off length is estimated by plotting the OH* intensity profile from the

190 injector tip for both the upper and lower axis. The values reported in this work were calculated with a 50% intensity peak,
191 following the same criteria as Benajes et al. in [30].



192

193 *Figure 7. Flame Lift off length obtained by OH* chemiluminescence: Top: example of one image. Bottom: intensity*
194 *profiles for bottom (continuous red) and top (continuous blue) flame sections; dashed lines in the same colours represent LOL*
195 *estimated with a 50% intensity peak*

196

3. Results

197

3.1 Effect of butanol quantity on spray processes

198

199 Figure 8 shows the temporal evolution of average vapor and liquid spray penetration lengths in non-reactive conditions
200 for all fuels. First, for all the fuels tested, the liquid spray reaches a stable penetration length 0.5 ms after the start of injection
(corrected by the hydraulic delay). But the liquid phase penetration length is strongly affected by the butanol content in the
201 fuel, due to its higher viscosity and density. Figure 9 highlights the non-linear effect of butanol content on the liquid spray
202 penetration length, determined during the stable phase of spray penetration: (1 to 1.5 ms): the effect is greater, i.e. higher
203 gradient when the quantity of butanol is above 20% in volume. Therefore, as seen in Figure 8, the difference relative to the
204 liquid length of PRF80 can reach 30% when 60% of butanol in vol. is added while the difference is only 5% with 20% of
205 butanol. This result is extremely relevant in the context of partially premixed combustion strategies as the start of injection is
206 significantly advanced compared to the Conventional Diesel Combustion mode, and can generate liquid fuel wall
207 impingement.

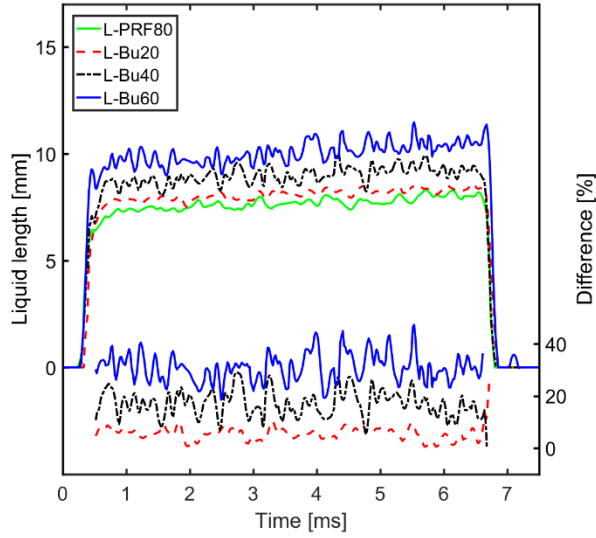

208

209

Figure 8. Liquid Spray penetration of PRF80 and PRF80-Butanol blends – $P_{amb} = 60 \text{ bar}$, $T_{amb} = 900 \text{ K}$, $P_{inj} = 400 \text{ bar}$.

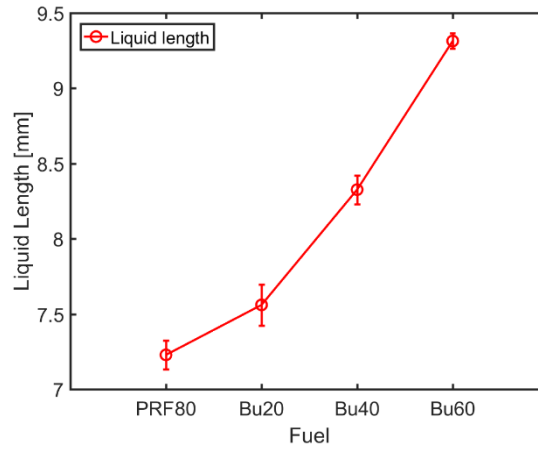

210

211

Figure 9. Liquid length of PRF80 and PRF80 - n-butanol blends

212

$$P_{amb} = 60 \text{ bar}, T_{amb} = 900 \text{ K}, P_{inj} = 400 \text{ bar}.$$

213

The liquid penetration length was estimated from fuel properties, as the correlation suggested by Naber and Siebers

214

[31]:

215

$$LL = A \cdot \sqrt{\frac{\rho_f}{\rho_{amb}}} \cdot \frac{\sqrt{C_d} \cdot d_{noz}}{\tan(\theta/2)} F(B) \text{ with } F(B) = \sqrt{\left(\frac{2}{B(P_{amb}, T_{amb}, T_f)} + 1\right)^2 - 1} \text{ Eq. 2}$$

216

With A an arbitrary constant, $\frac{\rho_f}{\rho_{amb}}$ the fuel/air density ratio, C_d the discharge coefficient, d_{noz} the orifice diameter, θ the

217

angle spray and B , a term analogous the mass and thermal transfer number used in droplet vaporization studies, function of the

218

fuel properties (P_v , M_f , c_{pf} , L_v), ambient gas properties (M_a , c_p) and the operating conditions (P_{amb} , T_{amb} , T_f). Due to the multi

219

components of the fuel, to evaluate the effect of the n-butanol content on LL, the ratio F_{blend}/F_{PRF} was estimated by comparing

220 ratio LL_{blend}/LL_{PRF80} and $\sqrt{\frac{\rho_{blend}}{\rho_{PRF80}}} \sqrt{\frac{C_{d-blend}}{C_{d-PRF80}}}$, as the angle spray values for all fuels under steady state, i.e. from 1 to 1.5 ms,

221 are around $21^\circ \pm 2^\circ$ without any effect of butanol contents. With PRF80 and Bu60, $LL_{Bu60}/LL_{PRF80}=1.3$ and

222
$$\sqrt{\frac{\rho_{Bu60}}{\rho_{PRF80}}} \sqrt{\frac{C_{d-Bu60}}{C_{d-PRF80}}} = 1.047.$$

223 Addition, as reference as [32], the authors a correlation taking account fluid-mechanics with density and evaporative
 224 properties with temperature at which 50% of the fuel distilled in absence of specific and latent heat :

225 $LL \propto d_{noz}^a T_{amb}^b P_{inj}^c \rho_f^e T_{50\%}^h$, with d_{noz} the orifice diameter, T_a the ambient gas temperature, P_{inj} the injection pressure, ρ_a

226 ambient gas density, ρ_f the fuel density, $T_{50\%}$. But as it can be seen, in Table 3, the addition of butanol in gasoline blends has a

227 very slight effect on distillation temperatures (extracted) from [33] . In fact, as underlined Dernote et al. [34], the main change

228 of liquid length is due to the high latent heat of vaporization, so for fuels like oxygenate fuels, the use of atmospheric pressure

229 boiling point to correlate the liquid length is not sufficient.

230 *Table 3. Distillation temperature of Gasoline and blends with n-butanol*

Fuel	Gasoline	Bu20	Bu40	Bu60
$T_{10\%}$ [°C]	73 ± 0	74 ± 1	79 ± 1	88 ± 1
$T_{50\%}$ [°C]	105 ± 0	96 ± 0	97 ± 1	101 ± 0
$T_{90\%}$ [°C]	153 ± 5	135 ± 4	110 ± 2	106 ± 0

231 The specific heat considers as required heat to increase temperature until gases vapor condition: the heat transfer in term
 232 conduction from gas ambient to drops of spray. But, the latent heat as the amount of heat released during change of state from

233 drops of spray to gases vaporization. The volatility as the mass transfer in term evaporation from drops spray to gases

234 vaporization. The experimental results show that LL of Bu60 is the highest, that can be explain by higher: the specific heat

235 (c_{pf}), boiling point temperature and the latent heat (L_v) and by lower vapor pressure due to require more heat of gas ambient

236 transfer to drops spray for increase temperature of drops spray and until boiling point condition, and more heat released to

237 evaporation. The evolution of LL as a function of Butanol contents is important to consider as function of the injection

238 strategies for GPPC (one injection, multiple injection, injection phasing) the liquid fuel wall impingement can occur for high

239 butanol quantity.

240 However, as can be noted in Figure 10, the vapor phase penetration length is very weakly affected by the butanol content: less

241 than 3% of relative difference was observed, even with 60% butanol in volume.

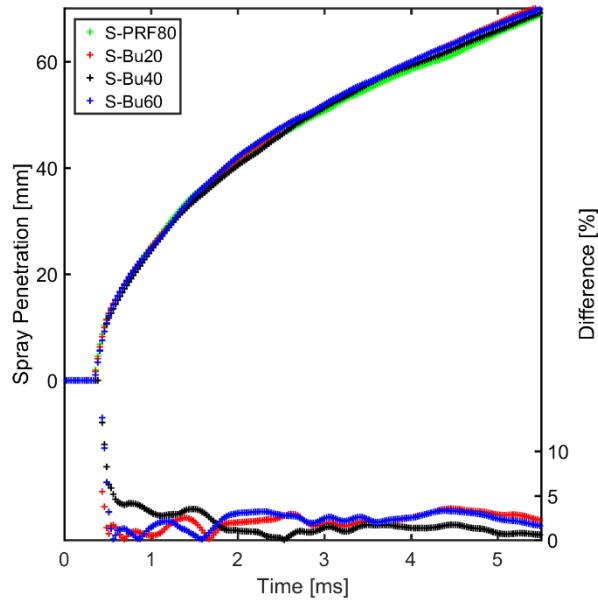

Figure 10. Vapor Spray penetration of PRF80 and PRF80-Butanol blends – $P_{amb} = 60 \text{ bar}$, $T_{amb} = 900 \text{ K}$, $P_{inj} = 400 \text{ bar}$.

3.2 Auto-ignition delays from kinetics modelling

The kinetics simulations were carried out using the constant volume model in the Senkin code [35]. The kinetics model for the blends was designed by using the 1033 species and 4238 reactions detailed mechanism proposed by Curran et al. [36] for the oxidation of iso-octane. This kinetics scheme based on the oxidation of n-heptane [37] can also be used for PRF oxidation. The oxidation of butanol was taken from the kinetic mechanisms of butanol isomers investigated by Sarathy et al. [38].

As the ambient temperature (at the injection timing, i.e. 900 K) is reduced during the vaporization process, the initial conditions for the simulations were set to 60 bar, with a temperature range from 790 K to 910 K, and due to the mixture fraction distribution, a wide equivalence ratio range from 0.2 to 2.0. These variations were explored to further describe the impact of n-butanol on PRF80 blends.

Figure 11 presents the iso-contour of the computed ignition delays for each fuel is plotted for all temperature and equivalence ratio ranges. As expected the ID increases with the increase of Butanol. So, at one given temperature, the same ignition delay can be reached for a higher equivalence ratio. For example, at 860 K, a 1 ms ignition delay is reached for an equivalence ratio of 1.5, 1.62, 1.9 and higher than 2 for a butanol content of 0, 20, 40 and 60% respectively. Therefore, the experimental measurements of the ignition delays associated with this map can provide an idea about the local equivalence ratio and temperature.

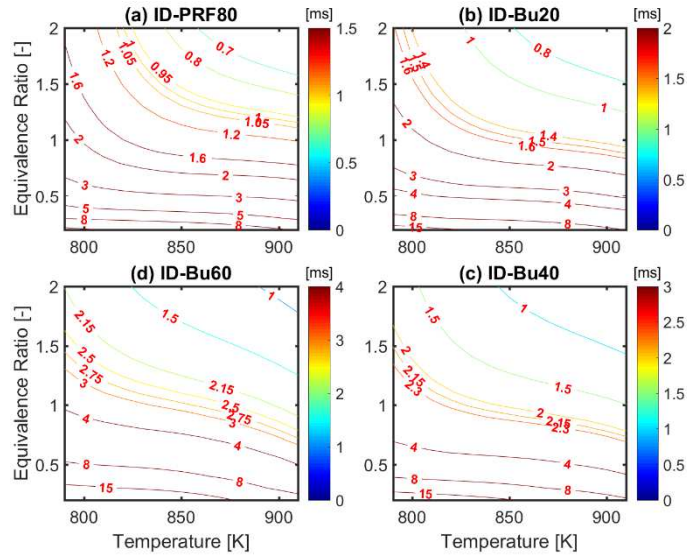

260

261

Figure 11. Ignition delay iso-contours for all fuels as a function of the temperature and equivalence ratio - $P_{amb} = 60$

262

bar.

263

The adiabatic temperature of the fuel/air mixture inside the chamber can be described by:

264

$$m_a c_{pa} (T_m - T_{amb}) + m_f \cdot L_v + m_f c_{pf} (T_m - T_b) = 0 \quad \text{Eq. 3}$$

265

266

267

Here m_a , m_f : the mass of air inside the chamber and the mass of fuel injected, respectively, c_{pa} , c_{pf} : the heat capacity of air and fuel, respectively, L_v : the heating vapor of fuel, T_m , T_{amb} , T_b : Temperature of the air/fuel mixture, of the ambient gas and of the fuel boiling point, respectively. The temperature of the air/fuel mixture is expressed as:

268

$$T_m = \frac{c_{pa} T_{amb} + \frac{\theta}{\theta_{st}} c_{pf} T_b - \frac{\theta}{\theta_{st}} L_v}{c_{pa} + \frac{\theta}{\theta_{st}} c_{pf}}$$

269

270

271

272

273

274

275

276

277

278

The cooling effect of the fuel spray is considered in order to calculate the ignition delay as a function of the equivalence ratio. Indeed, for each air-fuel mixture, the initial adiabatic temperature can be calculated and used to determine the adiabatic temperature evolution during combustion. As, depending on the equivalence ratio, the initial mixture temperature depends on the physical properties of the fuel (such as boiling point, heat capacities and latent heat of vaporization), the initial mixture temperature set to estimate the ignition delay changes considerably as a function of the equivalence ratio and of the fuel. In Figure 12, the ignition delay is plotted by considering the ‘adjusted’ initial temperature as a function of the equivalence ratio for PRF80 and butanol blends. The trend is identical for all fuels: the ignition delay reaches a minimum value for an equivalence ratio between 1.2 and 1.5 before increasing again. As can be seen, the improvement in reactivity caused by the richer mixture competes with the lower mixture air-fuel temperature due to the cooling effect associated with higher fuel concentrations. For lean conditions with $ER < 1.2$, the ignition delay time decreases while the equivalence ratio increases, in

279 contrast to the rich condition with $ER > 1.5$ caused by the cooling effect associated with the stronger increase in fuel molar
 280 fractions. The minimum in ignition delay time corresponds to the best reactive combination between equivalence ratio and
 281 initial mixture temperature. As expected, Figure 12 shows that for a given ER, a higher n-butanol concentration shortens the
 282 ignition delay. Therefore, the effect of butanol content is higher: for 60% of n-butanol content and the ignition delay is twice as
 283 long.

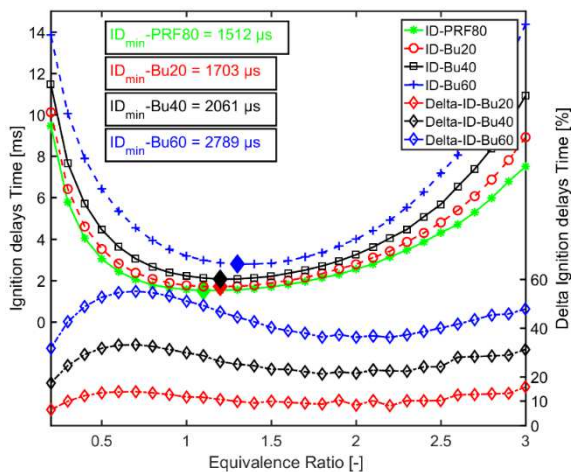

284

285 *Figure 12. Ignition delay as a function of equivalence ratio for PRF80/Bu blends as under adiabatic corresponding*
 286 *temperature, 'bright' losanges indicate minimum ignition delay for each fuel - $P_{amb} = 60$ bar.*

287 3.3 Effect of butanol quantity on combustion processes

288 In Figure 13, the evolution of the average pressure in the combustion chamber and the average apparent heat release
 289 rate are plotted versus time. It can be seen that the start of combustion occurs at least 1.5 ms after the start of injection, so in a
 290 region where the vapor spray penetration is far from the liquid penetration as confirmed in from Figure 6 second it has to be
 291 noted that as a function of the increase in Butanol content, the combustion onset is strongly delayed, due to both the difference
 292 in the chemical ignition delay but also the vaporization and mixing processes in HP/HT vessel.

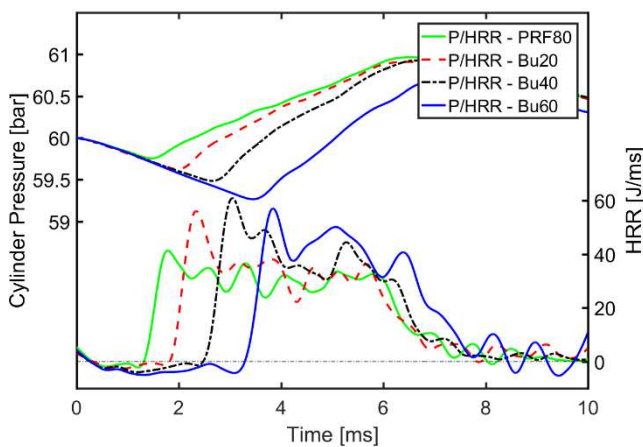

293

294 *Figure 13. Typical pressure and Heat release rates - $P_{amb} = 60$ bar, $T_{amb} = 900$ K, $P_{inj} = 400$ bar.*

295 Figure 14 illustrates the experimental ID of all the fuels obtained from OH* chemiluminescence intensity and HRR

296 temporal evolutions. Both estimates, averaged over the 6 experimental tests are overall in a very good agreement. ID values,
 297 obtained for a stoichiometric mixture at 900 K and the values obtained from Figure 12, i.e. the minimum ones determined
 298 previously from kinetics simulation are also plotted. Even if the estimate of the initial temperature (by taking into account the
 299 cooling effect due to the latent vaporization heat) is rough with the simple equation, globally a good agreement is obtained.

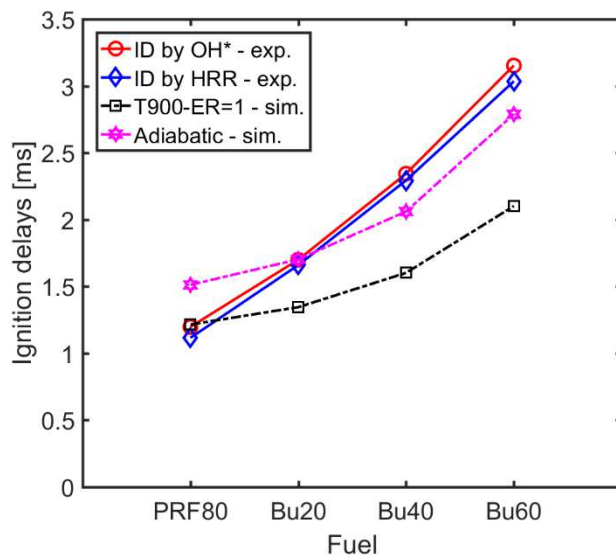

300

301 *Figure 14. Average Ignition delay: experimental and simulated estimates for all fuels - $P_{amb} = 60$ bar, $T_{amb} = 900$ K, P_{inj}*
 302 *= 400 bar.*

303 From Figure 13 also, the shape of the HRR indicates a combustion process in two phases: the premixed phase and the mixing
 304 controlled phase (i.e. diffusion phase).as the fuel is a gasoline type, these two phases are less easily distinguishable than for
 305 diesel fuel. Indeed, the combustion process itself is a mix between premixed and mixing controlled combustion modes. The
 306 first peak seems to be more important as a function of the butanol amount increase To confirm that, the different phases of the
 307 combustion process (i.e. time for 10, 50 and 90 % of the fuel mass fraction to be burnt, BMF10, BMF50, BMF90 respectively)
 308 and the global combustion duration (BMF90-BMF10), split in two phases (BMF50-BMF10, and BMF90-BMF50) were
 309 estimated and are plotted in Figure 15.

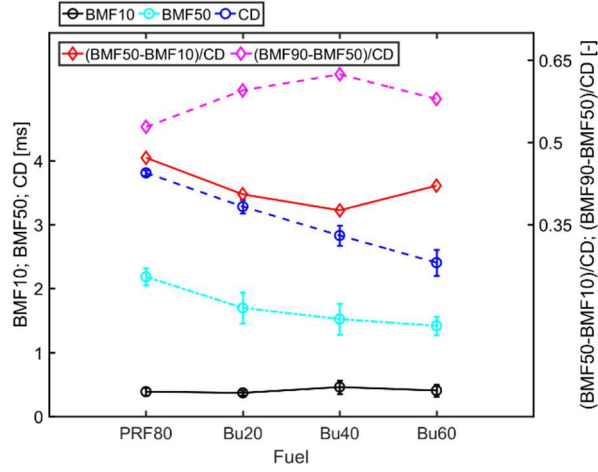

Figure 15. Different combustion phases for all fuels - $P_{amb} = 60 \text{ bar}$, $T_{amb} = 900 \text{ K}$, $P_{inj} = 400 \text{ bar}$

310

311

312

313

314

315

316

317

318

319

320

321

322

323

324

325

326

The earlier stage of combustion is slightly increased as a function of butanol content but the decrease of BMF50 indicates that combustion is faster with butanol, as can be predicted from the laminar flame velocity measurements [39]. It is interesting to note that also the total burning time decreases linearly with the n-butanol amount in the blend. Due to the longer ignition delay, the increase of butanol in the blend favors the premixing of fuel and air. But by considering the both half part of the combustion It can be noted that even if the global effect of butanol addition is linear if only the temporal evolution of the combustion is considered (BMF50, CD) the effect of butanol content is not linear, it is to say that when the amount of butanol is higher than 50%, the premixed phase duration is longer due to the difference of vaporisation physical parameters of butanol in comparison to PRF80.

From OH* chemiluminescence images, it is possible to determine the evolution of the global Averaged Spatially

integrated Intensity, as $ASI = \frac{\sum_i \sum_j I_{i,j}}{N}$, with $I_{i,j}$ the intensity at pixel position (i, j) and N the total pixel number. The plot

of ASI versus time, as Figure 16, helps to identify the premixed phase. Indeed, the rank is similar to the ID rank: PRF80 ASI starts the first, followed by butanol blends as a function of the butanol amount as already observed from the heat release rate plot in Figure 13.

However, ASI is more sensitive to the n-butanol concentration: the peak decreases with the increase in butanol and the time duration also, confirming the shorter combustion duration of the premixed combustion phase.

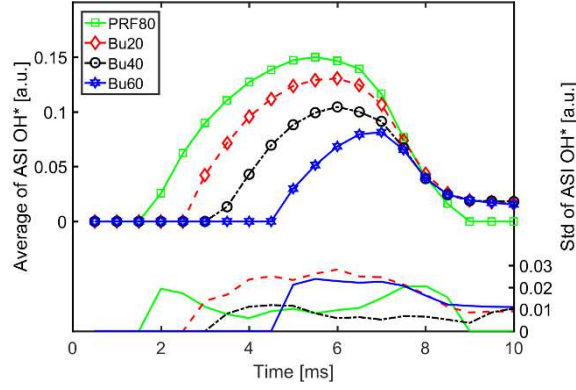

Figure 16. Averaged spatially integrated of Flame OH^* - $P_{amb} = 60$ bar, $T_{amb} = 900$ K, $P_{inj} = 400$ bar

3.4 Effect of butanol amount on Lift off Length

Flame lift-off length (LOL) is an indicator of the mixing time between air and fuel before the ignition which induces the combustion and pollutant process. The temporal evolution of lift off length for PRF80 and n-butanol blends is plotted in Figure 17. It can be noted that the flame first stabilizes far from the injector tip and then slowly approaches it. These movement can be explained by a variation of average ambient temperature during the combustion. As the NOSE volume is smaller this effect is no-negligible. When the fuel injection is stopped, i.e. at 6.5 ms, the flame is convected by the vapor spray. The combustion process continues for a quite a long time after the end of injection, though in a narrower combustion region. Compared with the liquid penetration length evolution, the higher value of LOL proves that fuel reaches the combustion region after total vaporization and that the fuel vapor continues to move downstream with the air entrainment. Then, the fuel vapor and air mixture reaches the reaction zone and is ignited by the flame. Due to the strong effect of containment, the LOL is stable in a relatively small temporal range, identified in Figure 17 by the black symbols.

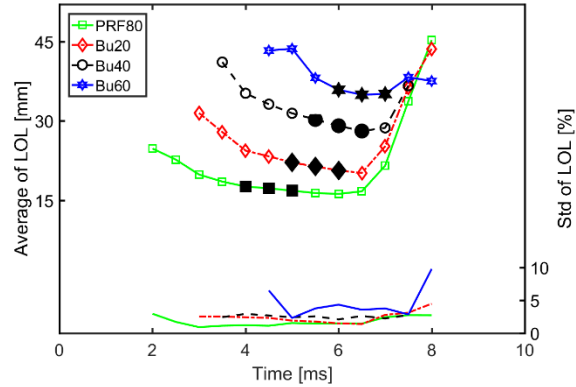

Figure 17. Temporal evolution of Flame Lift off for all fuel conditions - $P_{amb} = 60$ bar, $T_{amb} = 900$ K, $P_{inj} = 400$ bar

As reminded Benajes et al. in [30], the Lift off length is strongly related to gas-jet theory as: $LOL \propto T_{amb}^a \cdot \rho_{amb}^b \cdot u_{th}^c \cdot O_{2\%}^d$, with u_{th} the theoretical velocity of the fuel at the orifice outlet, $u_{th} = \sqrt{2(\Delta p_{noz} / \rho_f)}$, Δp_{noz} the pressure drop through the nozzle orifice approximated to $(p_{rail} - p_{amb})$ and a, b, c, d constant. As in this present study, all parameters were set constant,

345 only fuels change.

346 Therefore, the LOL has to be mainly dependant on the fuel density as: $\frac{LOL_{blend}}{LOL_{PRF80}} = \left(\sqrt{\frac{\rho_{PRF80}}{\rho_{blend}}} \right)^c$. But contrary to the results

347 predicted by Benajes et al. [30], the constant exponent, c as presented in Figure 18, is negative, indicating certainly that this
 348 other parameters have to be taking into account in the case of gasoline and alcohols fuels . Indeed, as underlined by [24,40,41],
 349 the LOL is not only affected by the spray feature but also by the oxygen content in the fuel due to the induced change of the
 350 stoichiometric mixture fraction Z_{st} . The evolution of the Lift off length as a function of the stoichiometric air-fuel ratio is

351 presented also in Figure 18 as $\frac{LOL_{blend}}{LOL_{PRF80}} = \left(\frac{AFR_{blend}}{AFR_{PRF80}} \right)^e$ with AFR the air fuel ratio stoichiometric. The similar evolution

352 indicates that both parameters, density and air/fuel ratio have identical weight.

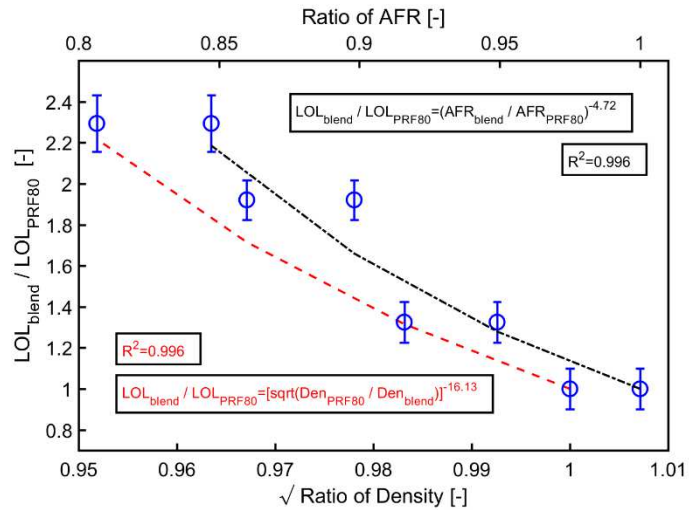

353

354 *Figure 18. Measured lift off length versus the density and the stoichiometric air-fuel ratio for butanol blends relative to*
 355 *values for PRF80*

356 Another way LOL is related with ignition delay [42]. It is described by the Arrhenius-type law. Last, the linear
 357 relationship between LOL and ID is observed in most studies [26], especially focused on Diesel type fuel. The evolution of the
 358 lift off length or ignition delay versus the Octane Number are plotted Figure 19. The estimates of ID by OH*
 359 chemiluminescence and LOL, presented in Figure 14 and Figure 17 respectively are also plotted.

360 The linear dependency between ID and RON or LOL and RON is well observed. The ignition delay is more sensitive to ratio
 361 of octane number.

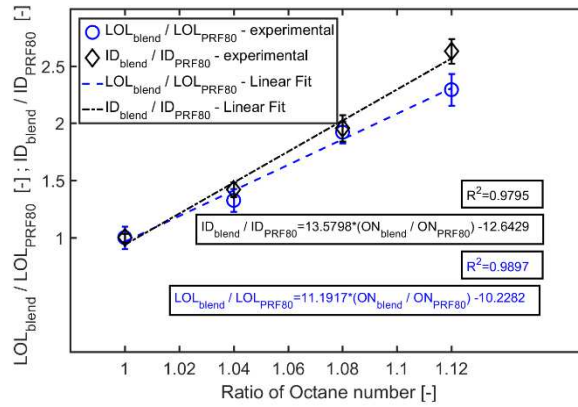

362

363

364

Figure 19. Lift off length and ignition delay ratios as a function of octane number ratio for all fuels. Data compiled from Figure 14 and 17

365

366

4. Conclusions

367

368

369

370

For the first time, experiments were carried out to explore the mixing and the auto-ignition processes in GCI mode under high temperature and high pressure conditions in the case of gasoline surrogate (PRF80) and n-butanol blends in order to consider bio-butanol blends as potential renewable fuels for Gasoline Compression Ignition engine for the first time in a dedicated set-up. .

371

The main conclusions of the work are as follows:

372

373

374

375

376

377

378

379

380

- **Under inert atmosphere conditions**, the addition of n-butanol affects the liquid spray until 35% for the highest content of 60% in volume but without real impact on the vapor spray penetration evolution.
- **Under reactive atmosphere conditions**, as the increase of n-butanol content in the mixture decreases drastically the reactivity of the mixture, the combustion is delayed and located further from the nozzle, as indicated the ignition delay and flame lift-off length evolution as a function of blends. The main results can be summarized as by increasing the amount of n-butanol in the mixture results:
 - o Increases the flame lift-off length which leads to decreasing the local equivalence ratio in the combustion region, resulting in lower soot formation.
 - o Results in shorter combustion duration and relatively strongly premixed combustion.

381

382

Therefore, butanol addition in gasoline could be a good solution in GCI combustion mode as it allows the adjustment of the combustion phasing and its optimisation in engine to increase the efficiency.

383

Acknowledgements

384

385

386

The authors acknowledge the Ministry of Education and Training of Vietnam for financing the Ph. D of Tung Lam Nguyen at the University of Orleans and the French National Research Agency (contract ANR-14-CE22-0015-01) for financial support to the ECN-France project and Region Centre Val de Loire (CPER 2007-2013 Energies du Futur) and FEDER for

387 financial support to build the experimental set-up.

388 **References**

- 389 [1] Zheng P, Allen WB, Roesler K, Williams ME, Zhang S, Li J, et al. Metabolic engineering delivers next-generation
390 biofuels. *Nat Genet* 2008;40:367–72. doi:10.1038/ng.85.
- 391 [2] Kalghatgi G, Hildingsson L, Johansson B. Low NO_x and Low Smoke Operation of a Diesel Engine Using Gasolinelike
392 Fuels. *ASME 2009 Intern Combust Engine Div Spring Tech Conf* 2009:259–71. doi:10.1115/ICES2009-76034.
- 393 [3] Rezaei SZ, Zhang F, Xu H, Ghafourian A, Herreros JM, Shuai S. Investigation of two-stage split-injection strategies
394 for a Dieseline fuelled PPCI engine. *Fuel* 2013;107:299–308. doi:10.1016/j.fuel.2012.11.048.
- 395 [4] Manente V, Zander C-G, Johansson B, Tunestal P, Cannella W. An Advanced Internal Combustion Engine Concept
396 for Low Emissions and High Efficiency from Idle to Max Load Using Gasoline Partially Premixed Combustion. *SAE*
397 *Tech. Pap. Ser.*, 2010. doi:10.4271/2010-01-2198.
- 398 [5] Manente V, Johansson B, Tunestal P, Sonder M, Serra S. Gasoline partially premixed combustion: high efficiency, low
399 NO_x and low soot by using an advanced combustion strategy and a compression ignition engine. *Int J Veh Des* 2012.
400 doi:10.1504/ijvd.2012.048689.
- 401 [6] Sellnau M, Foster M, Hoyer K, Moore W, Sinnamon J, Husted H. Development of a Gasoline Direct Injection
402 Compression Ignition (GDCI) Engine. *SAE Int J Engines* 2014;7:835–51. doi:10.4271/2014-01-1300.
- 403 [7] Rousselle CM, Foucher F, Labreche A. Optimization of Gasoline Partially Premixed Combustion Mode. *SAE Tech.*
404 *Pap. Ser.*, SAE International; 2013. doi:10.4271/2013-01-2532.
- 405 [8] Dempsey AB, Curran SJ, Wagner RM. A perspective on the range of gasoline compression ignition combustion
406 strategies for high engine efficiency and low NO_x and soot emissions: Effects of in-cylinder fuel stratification. *Int J*
407 *Engine Res* 2016. doi:10.1177/1468087415621805.
- 408 [9] Labreche A, Foucher F, Rousselle C. Impact of the Second Injection Characteristics and Dilution Effect on Gasoline
409 Partially Premixed Combustion. *SAE Tech. Pap. Ser.*, 2014. doi:10.4271/2014-01-2673.
- 410 [10] Pinazzi PM, Foucher F. Influence of injection parameters, ozone seeding and residual NO on a Gasoline Compression
411 Ignition (GCI) engine at low load. *Proc Combust Inst* 2017;36:3659–68. doi:10.1016/j.proci.2016.06.075.
- 412 [11] Manente V, Johansson B, Tunestal P, Cannella W. Effects of Different Type of Gasoline Fuels on Heavy Duty
413 Partially Premixed Combustion. *SAE Int J Engines* 2009;2:71–88. doi:10.4271/2009-01-2668.
- 414 [12] Cung KD, Ciatti SA, Tanov S, Andersson Ö. Low-Temperature Combustion of High Octane Fuels in a Gasoline
415 Compression Ignition Engine. *Front Mech Eng* 2017;3:1–14. doi:10.3389/fmech.2017.00022.
- 416 [13] Manente V, Tunestal P, Johansson B, Cannella WJ. Effects of Ethanol and Different Type of Gasoline Fuels on

- 417 Partially Premixed Combustion from Low to High Load. SAE Tech. Pap. Ser., 2010. doi:10.4271/2010-01-0871.
- 418 [14] Woo C, Goyal H, Kook S, Hawkes ER, Chan QN. Double Injection Strategies for Ethanol-Fuelled Gasoline
419 Compression Ignition (GCI) Combustion in a Single-Cylinder Light-Duty Diesel Engine. SAE Tech. Pap. Ser., SAE
420 International; 2016. doi:10.4271/2016-01-2303.
- 421 [15] Shamun S, Shen M, Johansson B, Tuner M, Pagels J, Gudmundsson A, et al. Exhaust PM Emissions Analysis of
422 Alcohol Fueled Heavy-Duty Engine Utilizing PPC. SAE Int J Engines 2016;9:2142–52. doi:10.4271/2016-01-2288.
- 423 [16] Kaiadi M, Johansson B, Lundgren M, Gaynor JA. Experimental Investigation on different Injection Strategies for
424 Ethanol Partially Premixed Combustion. SAE Tech. Pap. Ser., SAE International; 2013. doi:10.4271/2013-01-0281.
- 425 [17] Noh HK, No S. Effect of bioethanol on combustion and emissions in advanced CI engines : HCCI , PPC and GCI
426 mode – A review 2017. doi:10.1016/j.apenergy.2017.09.071.
- 427 [18] Han X, Zheng M, Wang J. Fuel suitability for low temperature combustion in compression ignition engines. Fuel
428 2013;109:336–49. doi:10.1016/j.fuel.2013.01.049.
- 429 [19] Yang B, Yao M, Cheng WK, Zheng Z, Yue L. Regulated and unregulated emissions from a compression ignition
430 engine under low temperature combustion fuelled with gasoline and n-butanol/gasoline blends. Fuel 2014;120:163–70.
431 doi:10.1016/j.fuel.2013.11.058.
- 432 [20] Baumgardner ME, Sarathy SM, Marchese AJ. Autoignition characterization of primary reference fuels and n-
433 heptane/n-butanol mixtures in a constant volume combustion device and homogeneous charge compression ignition
434 engine. Energy and Fuels 2013;27:7778–89. doi:10.1021/ef4015982.
- 435 [21] AlRamadan AS, Badra J, Javed T, Al-Abbad M, Bokhumseen N, Gaillard P, et al. Mixed butanols addition to gasoline
436 surrogates: Shock tube ignition delay time measurements and chemical kinetic modeling. Combust Flame
437 2015;162:3971–9. doi:10.1016/j.combustflame.2015.07.035.
- 438 [22] Gorbatenko I, Tomlin AS, Lawes M, Cracknell RF. Experimental and modelling study of the impacts of n-butanol
439 blending on the auto-ignition behaviour of gasoline and its surrogate at low temperatures. Proc Combust Inst 2019.
440 doi:10.1016/j.proci.2018.05.089.
- 441 [23] López JJ, García-Oliver JM, García A, Domenech V. Gasoline effects on spray characteristics, mixing and auto-
442 ignition processes in a CI engine under Partially Premixed Combustion conditions. Appl Therm Eng 2014;70:996–
443 1006. doi:10.1016/j.applthermaleng.2014.06.027.
- 444 [24] Nilaphai O, Hespel C, Chanchaona S, Mounaïm-Rousselle C. Spray and Combustion Characterizations of
445 ABE/Dodecane Blend in Comparison to Alcohol/Dodecane Blends at High-Pressure and High-Temperature
446 Conditions. Fuel 2018;225:542–53. doi:10.1016/j.fuel.2018.03.184.

- 447 [25] Nilaphai O. Vaporization and Combustion Processes of Alcohols and Acetone-Butanol-Ethanol (ABE) blended in n-
448 Dodecane for High Pressure-High Temperature Conditions. Orleans, 2019.
- 449 [26] Anderson JE, Kramer U, Mueller SA, Wallington TJ. Octane numbers of ethanol- and methanol-gasoline blends
450 estimated from molar concentrations. *Energy and Fuels* 2010;24:6576–85. doi:10.1021/ef101125c.
- 451 [27] Anderson JE, Diccico DM, Ginder JM, Kramer U, Leone TG, Raney-Pablo HE, et al. High octane number ethanol-
452 gasoline blends: Quantifying the potential benefits in the United States. *Fuel* 2012;97:585–94.
453 doi:10.1016/j.fuel.2012.03.017.
- 454 [28] Hayes TK, Savage LD, Sorenson SC. Cylinder Pressure Data Acquisition and Heat Release Analysis on a Personal
455 Computer. SAE Tech. Pap. Ser., 1986. doi:10.4271/860029.
- 456 [29] Siebers DL, Higgins B. Flame Lift-Off on Direct-Injection Diesel Sprays Under Quiescent Conditions 2001.
457 doi:10.4271/2001-01-0530.
- 458 [30] Benajes J, Payri R, Bardi M, Martí-Aldaraví P. Experimental characterization of diesel ignition and lift-off length
459 using a single-hole ECN injector. *Appl Therm Eng* 2013;58:554–63. doi:10.1016/j.applthermaleng.2013.04.044.
- 460 [31] Siebers DL. Scaling Liquid-Phase Fuel Penetration in Diesel Sprays Based on Mixing-Limited Vaporization. SAE
461 Tech. Pap. Ser., vol. 1, 2010. doi:10.4271/1999-01-0528.
- 462 [32] Pastor J V., García-Oliver JM, Nerva JG, Giménez B. Fuel effect on the liquid-phase penetration of an evaporating
463 spray under transient diesel-like conditions. *Fuel* 2011;90:3369–81. doi:10.1016/j.fuel.2011.05.006.
- 464 [33] Aghahosseini Shirazi S, Abdollahipoor B, Martinson J, Windom B, Foust TD, Reardon KF. Effects of dual-alcohol
465 gasoline blends on physiochemical properties and volatility behavior. *Fuel* 2019;252:542–52.
466 doi:10.1016/j.fuel.2019.04.105.
- 467 [34] Mounaïm-Rousselle C, Dernet J, Foucher F, Hespel C, Houille S. Influence of the fuel properties on the spray
468 development characteristics in a Diesel optical access engine. 10th Int. Symp. Combust. Diagnostics, 2012.
- 469 [35] Chemkin. Senkin: a fortran program for predicting homogeneous gas phase chemical kinetics with sensitivity analysis.
470 Sci York 1987.
- 471 [36] Curran HJ, Gaffuri P, Pitz WJ, Westbrook CK. A comprehensive modeling study of iso-octane oxidation. *Combust*
472 *Flame* 2002. doi:10.1016/S0010-2180(01)00373-X.
- 473 [37] Curran HJ, Gaffuri P, Pitz WJ, Westbrook CK. A comprehensive modeling study of n-heptane oxidation. *Combust*
474 *Flame* 1998. doi:10.1016/S0010-2180(97)00282-4.
- 475 [38] Sarathy SM, Vranckx S, Yasunaga K, Mehl M, Oßwald P, Metcalfe WK, et al. A comprehensive chemical kinetic
476 combustion model for the four butanol isomers. *Combust Flame* 2012;159:2028–55.

- 477 doi:10.1016/j.combustflame.2011.12.017.
- 478 [39] Broustail G, Seers P, Halter F, Moréac G, Mounaim-Rousselle C. Experimental determination of laminar burning
479 velocity for butanol and ethanol iso-octane blends. *Fuel* 2011. doi:10.1016/j.fuel.2010.09.021.
- 480 [40] Donkerbroek AJ, Boot MD, Luijten CCM, Dam NJ, ter Meulen JJ. Flame lift-off length and soot production of
481 oxygenated fuels in relation with ignition delay in a DI heavy-duty diesel engine. *Combust Flame* 2011;158:525–38.
482 doi:10.1016/j.combustflame.2010.10.003.
- 483 [41] Manin J, Skeen S, Pickett L, Kurtz E, Anderson JE. Effects of Oxygenated Fuels on Combustion and Soot
484 Formation/Oxidation Processes. *SAE Int J Fuels Lubr* 2014;7:704–17. doi:10.4271/2014-01-2657.
- 485 [42] Pickett LM, Siebers DL, Idicheria CA. Relationship Between Ignition Processes and the Lift-Off Length of Diesel Fuel
486 Jets. *SAE Tech. Pap. Ser.*, SAE International; 2005. doi:10.4271/2005-01-3843.

487

488 **Nomenclature**

489 **Acronyms**

490	AFR	Stoichiometric air-fuel ratio
491	ASOI	After start of injection
492	ASI	Averaged spatially integrated
493	Bu20	80% PRF80 / 20% n-Butanol by Volume
494	Bu40	60% PRF80 / 40% n-Butanol by Volume
495	Bu60	40% PRF80 / 60% n-Butanol by Volume
496	BMF10	Burnt mass fraction 10%
497	BMF50	Burnt mass fraction 50%
498	BMF90	Burnt mass fraction 90%
499	ECN	Engine Combustion Network
500	CD	Combustion duration
501	C_d	Discharge coefficient
502	CVC	Constant volume chamber
503	ER	Equivalence ratio
504	EGR	Exhaust gas recirculation
505	GCI	Gasoline compression ignition
506	HRR	Heat release rate

507	FIT	Fuel ignition tester
508	LTC	Low temperature combustion
509	MFR	Mass flow rate
510	IQT	Ignition quality tester
511	SOC	Start of combustion
512	SOI	Start of injection
513	PID	Proportional-Integral-Derivative controller
514	PPC	Partially premixed combustion
515	PRF	Primary Reference Fuel
516	RON	Research octane number
517	Variable	
518	c_p	Specific heat for an ideal gas at constant pressure
519	c_{pf}	Specific heat for an fuel vaporization at constant pressure
520	c_v	Specific heat for an ideal gas at constant volume
521	d_{noz}	Diameter
522	ID	Ignition delay time
523	k-factor	Conicity factor used in industry
524	LOL	Flame Lift off length
525	LL	Liquid spray penetration length
526	\dot{m}_{me}	Mean mass flow rate
527	\dot{m}_{th}	Theoretical mass flow rate
528	P	Pressure
529	V	Volume
530	R	Gas constant
531	Re	Reynolds number
532	S	Vapor spray penetration length
533	T	Temperature
534	t	Time
535	γ	Specific heat ratio
536	ν_f	Viscosity of fuel

537	ρ_f	Fuel density
538	θ	Angle spray