



**HAL**  
open science

# Proceedings of the 14th IWA Specialized Conference on Small Water and Wastewater Systems & the 6th Specialized Conference on Resources Oriented Sanitation (S2Small 2017)

Florent Chazarenc

► **To cite this version:**

Florent Chazarenc (Dir.). Proceedings of the 14th IWA Specialized Conference on Small Water and Wastewater Systems & the 6th Specialized Conference on Resources Oriented Sanitation (S2Small 2017). 2017. hal-02964318

**HAL Id: hal-02964318**

**<https://hal.science/hal-02964318>**

Submitted on 12 Oct 2020

**HAL** is a multi-disciplinary open access archive for the deposit and dissemination of scientific research documents, whether they are published or not. The documents may come from teaching and research institutions in France or abroad, or from public or private research centers.

L'archive ouverte pluridisciplinaire **HAL**, est destinée au dépôt et à la diffusion de documents scientifiques de niveau recherche, publiés ou non, émanant des établissements d'enseignement et de recherche français ou étrangers, des laboratoires publics ou privés.



2017

# S<sub>2</sub>SMALL

INTERNATIONAL IWA CONFERENCE  
ON SUSTAINABLE SOLUTIONS FOR SMALL WATER  
AND WASTEWATER TREATMENT SYSTEMS

22 > 26

OCTOBER 2017

La Cité Nantes Events Center  
France



## IWA JOINT CONFERENCES:

- › 14<sup>th</sup> IWA Specialized Conference on Small Water and Wastewater Systems (SWWS)
- › 6<sup>th</sup> IWA Specialized Conference on Resources Oriented Sanitation (ROS)
- › 3<sup>rd</sup> International Conference Terra Preta Sanitation & Decentralized Wastewater System

**Book of proceedings**





I am very happy to welcome you to the International IWA conference on sustainable solutions for small water and wastewater treatment systems (S2Small2017) that will be held October 22-26 in Nantes, France. This event co-organized by IMT Atlantique, GEPEA, IWA and ASTEE will be held in Nantes (city congress center). S2Small2017 will address the latest advances in the field of water and wastewater management for small systems and decentralized approaches.

This joint conference will bring together the 14<sup>th</sup> IWA Specialized Conference on Small Water and Wastewater Systems (SWWS) together with the 6<sup>th</sup> IWA Specialized Conference on Resources-Oriented Sanitation (ROS) and the 3<sup>rd</sup> International Conference Terra Preta Sanitation & Decentralized Wastewater System.

The event is a continuation of the previous successful Conferences of the 11<sup>th</sup> SWWS (Harbin, China), the 12<sup>th</sup> SWWS and 4<sup>th</sup> ROS (Muscat, Oman), the 13<sup>th</sup> SWWS and 5<sup>th</sup> ROS (Athens, Greece) and the 2<sup>nd</sup> TPS (Goa, India).

The scope of our conference is to go beyond the simple assumption that small water and wastewater systems are technically feasible and working to answer specific needs under many different configurations. The scope of our conference is to demonstrate that small water and wastewater systems represent part of the solution for the future of humanity, from theoretical concepts up to very applied case studies our conference will show that small is smart, small is beautiful, small is efficient, small is affordable, small is generous in other words small is the future!

Only small solutions for water and wastewater will enable to meet UN Sustainable Development Goal 6: « Ensure access to water and sanitation for all ». Only small water and wastewater solutions will help to increase water re-use, water recycle and resource recovery from wastewater. If you also believe that small water and wastewater systems represent tomorrow's solutions do not hesitate anymore and come to S2Small2017 to share your knowledge, meet the main actors in the field, strengthen your network in a wonderful city (surrounded by water) and in a region where small water solutions are really developed!

*On behalf of the organizing Committee,*

**Florent CHAZARENC**



## Schedule

Monday 23 October	Tuesday 24 October	Wednesday 25 October	Thursday 26 October
Welcome ceremony 09:00 - 09:20	Parallel sessions 08:10 - 09:30	Keynotes 3 08:00 - 09:30	Technical visits 08:00 - 12:00
Keynotes 1 09:20 - 10:20	Coffee-break 09:30 - 09:50	Coffee-break 09:30 - 09:50	
	Parallel sessions 09:50 - 11:10	Parallel sessions 09:50 - 11:10	
Coffee-break 10:20 - 10:40	Health break 11:10 - 11:30	Health break 11:10 - 11:30	
Poster session 10:40 - 12:50	Parallel sessions 11:30 - 12:50	Parallel sessions 11:30 - 12:50	Lunch-picnic 12:00 - 13:00
Lunch 12:50 - 14:00	Lunch 12:50 - 14:00	Lunch 12:50 - 14:00	Technical visits 13:00 - 17:00
Opening ceremony 14:00 - 15:20	Parallel sessions 14:00 - 15:20	Parallel sessions 14:00 - 15:00	
Coffee-break 15:20 - 15:40	Health break 15:20 - 15:40	Health break 15:00 - 15:20	
Keynotes 2 15:40 - 16:40	Parallel sessions 15:40 - 17:00	Parallel sessions 15:20 - 16:20	
	Coffee-break 17:00 - 17:20	Coffee-break 16:20 - 16:40	
Poster session 16:40 - 18:30	Parallel sessions 17:20 - 18:40	Closing ceremony 16:40 - 18:00	
Specialist Group Meeting 16:50 - 18:00	Gala dinner		

Download the detailed program online: <http://s2small2017.org/detailed-program>

**Keynotes 1**

09:20-10:20

Session chair: Florent CHAZARENC

**INV904 - Integrated waste management approach at Devanahalli, India**

SINHA Susmita - *Bremen Overseas Research and Development Association, Germany*

**INV905 - Resource Recovery and Reuse of wastes: An opportunity for African countries**

COFIE Olufunke - *International Water Management Institute, Ghana*

**Keynotes 2**

15:40-16:40

Session chair: Florent CHAZARENC

**INV900 - Membrane for energy and water recovery**

SECO Aurora - *University of Valencia, Chemical Engineering Department, Spain*

**INV901 - Groundwater arsenic/fluoride contamination: low-cost remediation strategies**

BHATTACHARYA Prosun - *KTH Royal Institute of Technology, Stockholm (Sweden)*

Keynote speaker:

SINHA Susmita, Bremen Overseas Research and Development Association, Germany

Bio:

Susmita Sinha is a senior Technical Advisor at Bremen Overseas Research and Development Association (BORDA). An environmental management professional, she has been associated with decentralised sanitation services that caters to solutions across community level to city scale interventions. She is currently involved with applied research linked to wastewater and faecal sludge especially with characterization linked to design matrices and improving treatment efficiency. Her work is also closely linked to developing treatment approaches for making cities and towns 'liveable' by integrating sanitation with water body rejuvenation, food production and minimizing health risk exposure pathways contributing to provision of holistic sanitation solutions.



# Integrated waste management approach at Devanahalli, India

SINHA Susmita, Bremen Overseas Research and Development Association, Germany

Rapid urbanization poses a significant challenge to addressing sanitation issues at a town/city scale. As per the United Nations World Urbanisation Prospects Report<sup>1</sup> India is projected to add 404 million urban dwellers, between 2014 to 2050. According to Census of India, 2011, around 42% of all towns and cities can be classified as small cities/towns - having population less than 100,000. These cities/towns have less than 50% of underground drainage coverage and are seeing rapid urbanization. These cities/towns need sanitation interventions that are innovative and address sanitation linked issues holistically. Safe, affordable and sustainable sanitation solutions that minimize health risks exposure while also meeting the increasing demand for food and water scarcity are progressively becoming viable approaches for addressing sanitation issues in developing towns/cities. To minimize risks associated with sanitation, an integrated approach is needed to address issues linked to negative impacts of lack of waste management on public health, livelihoods and the environment. At a town level, an incremental and integrated approach with support of enabling components of financial resource, institutional capacity, legal and governance frameworks and stakeholders buy-in is being piloted at Devanahalli, Karnataka, India. This pilot project implemented by BORDA and its local partner CDD Society aims to address solid and liquid waste management. The approach adopted in Devanahalli may be replicated in other small towns of India that are getting rapidly urbanized but have limited capacities and resources and are in need of waste management.

---

<sup>1</sup> United Nations, Department of Economic and Social Affairs, Population Division (2014). World Urbanization Prospects: The 2014 Revision, Highlights (ST/ESA/SER.A/352).

Keynote speaker:

COFIE Olufunke, International Water Management Institute,  
Ghana

Bio:

Olufunke Cofie heads the West Africa Office of the International Water Management Institute (IWMI). She is a Principal Researcher with over 20 years progressive professional experience in natural resources management with a focus on the safe recovery of nutrients, organic matter and water from domestic wastes for agriculture in developing countries. She has pioneered the development of a waste-based soil ameliorant, which is being marketed in Ghana. With a PhD in Soil Science and an MBA in Business administration. She has considerable experience in developing and leading multi-institutional and multi-disciplinary research programs. In the nineties, she taught in the Universities in Nigeria and Ghana. Currently, she is posted in Ghana where she leads IWMI's research agenda and the associated diverse staff in West Africa.





# Resource Recovery and Reuse of wastes: An opportunity for African countries

COFIE Olufunke, International Water Management Institute, Ghana

Waste management represents a major hindrance to the development of many countries in Sub-Saharan Africa. Liquid and solid wastes management not only represent a sink for the limited available financial resources, but the poor performance also negatively affect public health, livelihoods and the environment. In general, municipalities struggle to contain these effects in cities that are growing at a fast pace. Resource Recovery and Reuse (RRR) could offer a solution, by e.g. enabling cost recovery in the wastewater treatment systems, limiting the need for landfills, which are costly to operate, and even increasing the availability of resources supporting other key development sectors such as agriculture (compost, water, nutrients) and energy (biogas, fuel pellets or briquettes). Experience from IWMI in Ghana confirms the demand for developing RRR business solutions that address technical issues in a cost-effective way, raises awareness of the potential of RRR and build stakeholder capacity in the field. When successfully devised and implemented, RRR could be an accelerator for meeting some SDG targets (2, 6, 13 and 15).



IWMI, 2017

Keynote speaker:

SECO Aurora, University of Valencia, Chemical Engineering Department, Spain

### Bio:

Aurora SECO is Chemist and Full Professor at the University of Valencia (Chemical Engineering Department) Spain. She has over 25 years of experience in research activities with emphasis on nutrient removal and recovery from wastewater, anaerobic sludge digestion, monitoring of priority pollutants in WWTP effluents and coastal waters and more recently nutrient and energy recovery from urban wastewater by using anaerobic membrane bioreactors and microalgae cultivation. She is founding member and coordinator of CALAGUA research group and has collaborated in 23 competitive research projects and more than 75 research contracts for technology transfer with companies related to wastewater treatment. She has participated in 115 papers published in peer-reviewed international journals and has supervised 26 Ph.D. students. Based on these researches, two patents have been published.

She is leader of the Action Group “AnMBR for WATER Resource Recovery in CIRCULAR Economy: WATER CIRCLE” under the EIP-Water and she also leads one of the only two Innovation Deals for Circular Economy selected by EU, entitled “Sustainable wastewater treatment using innovative AnMBR technology”.



# Membrane for energy and water recovery

SECO Aurora, University of Valencia, Chemical Engineering Department, Spain

The increasing water stress, the necessity of reducing the carbon footprint and the increased depletion of resources has made it necessary to change the traditional economic frame into a new development model focused on Circular Economy (CE). The adoption of the principles of CE would allow protecting businesses against scarcity of resources, developing an environmentally sustainable economy and opening new markets, while creating new jobs

The application CE to the water sector is based on the 3Rs strategy: reduction of negative environmental impacts (e.g. GHG emissions, energy consumption, sludge production, water stress), recovery of energy and nutrients and, finally reuse of reclaimed water. Conventional wastewater treatments based on aerobic processes, and its technologies, are effective in removing organic matter and nutrients, but are characterised by a high energy consumption, sludge production and GHG emissions. On the other hand, the use on anaerobic processes allows improving both economic and environmental sustainability of the treatments by reducing energy demand (net energy surplus can be achieved under certain conditions), decreasing sludge production, limiting GHG emissions and reducing operational cost in comparison with conventional treatments.

Furthermore, low strength wastewater can be anaerobically treated if it is possible to operate at high sludge retention time (SRT) and low hydraulic retention time (HRT). Membrane technology allows uncoupling SRT y HRT, since it guarantees a complete sludge retention. Hence, combination of anaerobic process and membrane technology in the so-called Anaerobic Membrane Bioreactor (AnMBR) makes it possible to shift the concept of wastewater treatment from the current Wastewater Treatment Plant (WWTP) to the new Water Resource Recovery Facility (WRRF) in line with the EU Action Plan for the Circular Economy. This technology has also a big potential for on-site recycling and reuse of water, nutrients and energy.

AnMBR technology still has some limitations: investment cost due to membranes, but it is decreasing as MBR market trend is growing; dissolved methane in the effluent, but there are technological solutions for its recovery; and nutrients content of the effluent, if discharge is produced in sensitive areas, but a post-treatment can be implemented.

Finally, the main challenges of AnMBR is optimising retention process; recovery of dissolved methane, removal of sulphide if it is present in the biogas and overcome legal barriers that prevent the reuse of the effluent for agriculture.

Keynote speaker:

BHATTACHARYA Prosun, KTH Royal Institute of Technology,  
Stockholm (Sweden)

Bio:

Prosun Bhattacharya, PhD degree in Sedimentary Geochemistry from the University of Delhi in India is a professor of Groundwater Chemistry and Coordinator of the KTH-International Groundwater Arsenic Research Group, at the Department of Sustainable Development, Environmental Science and Engineering at KTH Royal Institute of Technology, Stockholm, Sweden. Since 2016, he is also an Adjunct Professor at the School of Civil Engineering & Surveying & International Centre for Applied Climate Science at the University of Southern Queensland, Australia. He is engaged with research on groundwater contamination in different parts of the world, especially focusing on geogenic contaminants – arsenic and fluoride in groundwater of Bangladesh, Bolvi and Tanzania. He has coordinated the prestigious Swedish International Development Cooperation Agency supported action research and implementation project “Sustainable Arsenic Mitigation-SASMIT” Community driven initiatives to target arsenic safe groundwater as sustainable mitigation strategy in Bangladesh. Based on his global engagements in the field of arsenic research he has been honored with the title as the Fellow of the Geological Society of America in April, 2012. He has taken over as the Chair of the IWA Specialist Group Metals and Related Substances in Drinking Water (METRELS).



# Groundwater arsenic contamination and sustainable mitigation strategies

BHATTACHARYA Prosun, KTH Royal Institute of Technology, Stockholm (Sweden)

Access to safe drinking-water is an important component of developing effective policy for health protection. Geogenic contaminants such as arsenic, fluoride, manganese and others like uranium among others mobilized in groundwater sources pose critical risks to public health. Regional scale occurrence of natural arsenic (As) in groundwater has impacted safe drinking water access globally. Being a densely populated country like Bangladesh, millions of people are exposed to As at levels above the WHO guideline (10 µg/L). Considering the magnitude of the human health impacts and the outcomes of the mitigation programs, the main challenge is to implement a sustainable mitigation program for scaling up safe water access that complies with drinking water safety plan (DWSP). Tubewells as the most widely accepted drinking water option in rural Bangladesh, widely installed at community levels by local drillers using the hand percussion drilling technique. Arsenic is mobilized naturally in groundwater under reducing condition in shallow aquifers (< 50 m) where dissolution of Fe-oxyhydroxides release As to the groundwater. Local well drillers are the principal drivers of installation of tubewells based on indigenous knowledge in regions with elevated levels of As, targeting the shallow aquifers (< 100 m) based on sediment color to provide As-safe drinking water at relatively low cost. The Project Sustainable Arsenic Mitigation (SASMIT) has followed up the practice of tubewell installations by the local drillers in Matlab, southeastern Bangladesh with an aim to evaluate and validate their simple perspective on water quality based on color of the aquifer sediments. Water quality monitoring in the shallow, intermediate deep and deep aquifer systems through depth-specific piezometers (n=82) installed at 15 locations in Matlab region, over a period of 3 years and a follow-up monitoring during 2015, revealed that the water quality parameters are relatively stable in terms of overall groundwater quality especially As and Mn. The local drillers' indigenous knowledge on perception of sediment color with validation of water quality monitoring can thus be optimally harnessed for accelerating the drinking water supplies in rural Bangladesh to achieve the target of the SDG 6 and can be adapted in the rest of the world with similar geological settings.



IWMI, 2017



**Parallel session 1 - Aerobic Process 1**

**08:10-09:30**

Session chair: Inga Herrmann

**475 - A study on the effects of different organic load (BOD5) on treatment performance of four selected small wastewater treatment plants**

ALSAADI Shamsa - *Helmholtz Centre for Environmental Research GmbH - UFZ*

**428 - Biological tubular reactor, new technology for small wastewater treatment plants**

GARCÍA-GONZÁLEZ Sergio Adrián - *Facultad de Química, Universidad Nacional Autónoma de México*

**294 - Impacts of operational conditions on oxygen transfer rate, mixing characteristics and residence time distribution in a pilot scale HRAP**

PHAM Le Anh - *ICube laboratory*

**508 - Effects of an increase in salinity on PAOs in EBPR-SBBR reactors in coastal small populations**

ARAGON-CRUZ Carlos - *Centro de las Nuevas Tecnologías del Agua*

**Parallel session 2 - Industrial effluent 1**

**09:50-11:10**

Session chair: Jaime Nivala

**461 - Ten years of German experience in using ecotechnologies for onsite treatment of industrial pollution**

AUBRON Thomas - *Helmholtz Environmental Research Centre - UFZ*

**476 - Cleaning up landfill leachate in rural China with low-energy gas flotation and oxidation**

KINDLER Jean Louis - *OriginClear*

**651 - Environmental behavior of MSWI fly ash in leachate from solid waste landfill**

SUN Xiaolei - *Nanjing University of Science and Technology*

**477 - Performance of a vertical flow soil filter treating industrial wastewater under cold climatic conditions and avoiding filter clogging problems**

RAHMAN Khaja Zillur - *Helmholtz Environmental Research Centre - UFZ*

**Parallel session 3 - Phosphorus Treatment and recovery 1**

**11:30-12:50**

Session chair: Gabriela Dotro

**527 - Treatment performances and operating experiences of the first full-scale Discfilter facility featuring enhanced P removal from pure-MBBR effluent**

GIZEM Mutlu - *Veolia Water Technologies AB, Sweden*

**512 - Phosphorus recovery from pretreated sewage sludge and phosphorus saturated filter materials**

BARCA Cristian - *Laboratory M2P2 Aix-Marseille University*

**319 - Long-term investigation of phosphorus removal by iron electrolysis in actual small-scale wastewater treatment plants**

MISHIMA Iori - *Center for Environmental Science in Saitama*

**652 - Phosphate removal from aqueous solution using ZVI/sand bed reactor: Behavior and mechanism**

SLEIMAN Nathalie - *Université de Limoges*

# **A study on the effects of different organic load (BOD<sub>5</sub>) on treatment performance of four selected small wastewater treatment plants**

Ref # S2SMALL-61761

S. Al-Saadi<sup>1,2\*</sup>, K.Z. Rahman<sup>1</sup>, P. Mosig<sup>1</sup>, M. van Afferden<sup>1</sup>, R. A. Müller<sup>1</sup>

<sup>1</sup> Environmental- and Biotechnology Centre (UBZ), Helmholtz Centre for Environmental Research - UFZ, Permoserstraße 15, 04318 Leipzig, Germany

<sup>2</sup> The Research Council, P.O. Box 1422, Muscat 130, Sultanate of Oman

\*Corresponding author. E-mail address: shamsa.al-saadi@ufz.de (S. Al-Saadi)

**Keywords:** Decentralized wastewater treatment, BOD<sub>5</sub> concentration, Small Wastewater Treatment Plants (SWWTPs), Vertical Aerated Planted Constructed wetland (VAP),

## **INTRODUCTION**

Wastewater source, quality, quantity, location and reuse options play major roles in wastewater management planning process. Other factors, such as capital costs, operation and maintenance costs and land requirement, are involved in the selection of most appropriate treatment technology. Wastewater in rural areas of the arid regions are typically 'highly concentrated' (with BOD<sub>5</sub> > 500 mg/L), which is mainly due to high water scarcity and thereby low water consumption. Therefore, in rural areas, decentralized wastewater treatment is becoming the preferred cost-effective treatment strategy over centralized treatment due to the low population densities and scattered settlement (*Massoud et al., 2009*). Decentralized wastewater treatment systems commonly include eco-technologies (for e.g. constructed wetlands), biofilm technologies, sequencing batch reactors, membrane bioreactors and anaerobic technologies. Recent studies showed that aerated vertical flow constructed wetlands are cost effective, simple to operate and capable of improving the reduction of key pollutants such as organic carbon (*Boog et al., 2014, Nivala et al., 2013*).

The aim of this study is to compare the suitability and treatment performance of Vertical Aerated Planted constructed wetland (VAP) with other three conventional small wastewater treatment plants (SWWTPs) operating under the same wastewater compositions of varying BOD<sub>5</sub> concentrations (ranging from 300 – 1200 mg/L). The other three selected SWWTPs are Fluidized bed biofilm reactor (FBBR), Membrane bioreactor (MBR), and sequencing batch reactor (SBR). The systems are supplied by different German companies and already certified according to the European standard EN 12566-3, whereas the Vertical Aerated Planted (VAP) has been constructed by UFZ according to the German standard and regulations (DWA-A 262).

## MAIN METHODS

This research study was carried out at the BDZ-Research and Demonstration Center for Decentralized Wastewater Treatment in Leipzig, Germany. The site contains 12 various small wastewater treatments plants (SWWTPs) and is located on the premises of the former municipal sewage plant "KA Leutzsch", where all of the systems receive the same domestic wastewater. The three selected SWWTPs (FBBR, MBR & SBR) used in this study are on-site system designed for 4 population equivalent (PE), while the VAP system ( $8 \text{ m}^2 \times 90 \text{ m}$ ,  $\tau_n = 3.5 \text{ d}$ ) is designed for 8 PE, treating primary settled domestic sewage. Gravel (8 - 16 mm) was used as main media in VAP system which was saturated and planted with *Phragmites australis*. The performance of the selected decentralized systems was studied in a twelve months (November 2015-November 2016) time under three experimental phases with varied  $\text{BOD}_5$  concentration as shown in Table 1. The influent was fed simultaneously to all the four systems with duration of 4 months/phase. Throughout these three experimental phases, the samples of the influent and effluent of all four SWWTPs were collected on a weekly basis where several wastewater quality parameters like 5-day carbonaceous biochemical oxygen demand ( $\text{CBOD}_5$ ), chemical oxygen demand (COD), total nitrogen (TN), ammonia nitrogen ( $\text{NH}_4\text{-N}$ ), nitrate nitrogen ( $\text{NO}_3\text{-N}$ ), total phosphorus (TP), E-coli and physical parameters were analyzed.

**Table1:** Organic load ( $\text{BOD}_5$ ) concentration of the influent in three experimental phases

Experimental Phase	Wastewater type	$\text{BOD}_5$ Load, g/PE*d	Wastewater volume, L/(PE*d)	$\text{BOD}_5$ (mg/L)
Phase I	Domestic	45	150	300
Phase II	Modified	45	75	600
Phase III	Modified	45	37.5	1200

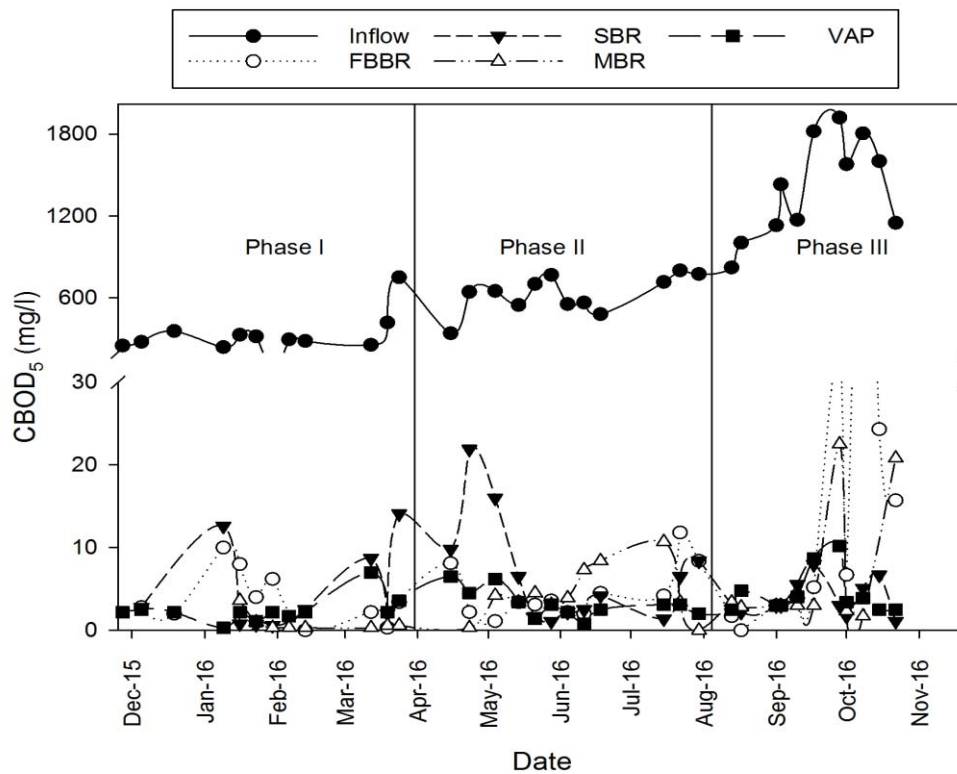
## MAIN RESULTS AND CONCLUSIONS

The results of this study provide advantageous data on the performance characteristics and their treatment efficiency of the selected SWWTPs. The average of influent concentration of, COD,  $\text{CBOD}_5$ ,  $\text{NH}_4\text{-N}$  and TN were  $605 \text{ mg L}^{-1}$ ,  $280 \text{ mg L}^{-1}$ ,  $44 \text{ mg L}^{-1}$  and  $28 \text{ mg L}^{-1}$  in phase I,  $1288 \text{ mg L}^{-1}$ ,  $630 \text{ mg L}^{-1}$ ,  $88 \text{ mg L}^{-1}$  and  $47 \text{ mg L}^{-1}$  in phase II,  $2547 \text{ mg L}^{-1}$ ,  $1480 \text{ mg L}^{-1}$ ,  $285 \text{ mg L}^{-1}$  and  $89 \text{ mg L}^{-1}$  in phase III, respectively. The main results showed: (i) the Vertical Aerated Planted constructed wetland (VAP) is capable to treat wastewater with various influent concentrations and the mean removal efficiency of COD,  $\text{NH}_4\text{-N}$  and TN reached 94%, 91% and 27 for phase I, 97%, 99% and 73% for phase II, and 98%, 88% and 55% for phase III, respectively as summarized in Table 2.

**Table 2:** Characteristics of effluent and removal efficiencies of VAP system during the three experimental phases

Parameter (mg/L)	Phase I (BOD <sub>5</sub> =300 mg/L)			Phase II (BOD <sub>5</sub> =600 mg/L)			Phase III (BOD <sub>5</sub> =1200mg/L)		
	Mean ±SD	Red. (%)	n	Mean ±SD	Red. (%)	n	Mean ±SD	Red. (%)	n
COD	34.5 ± 5.4	94	11	36.2 ± 4	97	12	64 ± 18	97.5	12
CBOD <sub>5</sub>	2.3 ± 1.7	99.2	11	3.3 ± 1.7	99.5	13	5.7 ± 5.1	99.6	12
NH <sub>4</sub> -N	3.9 ± 5.8	91	7	1 ± 0.5	99	13	34.6 ± 30	88	8
TN	44.2 ± 9.2	27	12	33.2 ± 13	73	10	166.3 ± 75	55	11

(ii) There is no significant difference in CBOD<sub>5</sub> removal efficiency of VAP compared to the other three systems (FBBR, MBR & SBR) during the three phases where all the four systems achieved average removal efficiency of nearly 99% (Figure 1), (iii) the highest average removal efficiencies of TP(55%) and TSS (99%) in the three phases were accomplished by VAP system, MBR system demonstrated the highest E-coli removal efficiency (100%) during the three phases, whereas FBBR and VAP systems achieved the highest NH<sub>4</sub>-N mean removal efficiency at 93% during the three phases.



**Figure 1.** CBOD<sub>5</sub> profiles of influent and effluent in the four SWWTPs during the whole operational period of 12 months.

## REFERENCES

- BOOG, J., NIVALA, J., AUBRON, T., WALLACE, S., VAN AFFERDEN, M. & MÜLLER, R. A. 2014. Hydraulic characterization and optimization of total nitrogen removal in an aerated vertical subsurface flow treatment wetland. *Bioresource Technology*, 162, 166-174.
- MASSOUD, M. A., TARHINI, A. & NASR, J. A. 2009. Decentralized approaches to wastewater treatment and management: Applicability in developing countries. *Journal of Environmental Management*, 90, 652-659.
- NIVALA, J., HEADLEY, T., WALLACE, S., BERNHARD, K., BRIX, H., VAN AFFERDEN, M. & MÜLLER, R. A. 2013. Comparative analysis of constructed wetlands: The design and construction of the ecotechnology research facility in Langenreichenbach, Germany. *Ecological Engineering*, 61, Part B, 527-543.



# Biological tubular reactor, new technology for small wastewater treatment plants

Ref # S2SMALL- 65623

S.A. García-González<sup>1</sup> and A Durán-Moreno<sup>1</sup>

<sup>1</sup>Universidad Nacional Autónoma de México/ Departamento de Ingeniería Química/  
Facultad de Química, CP 04510 Ciudad de México, Tel.: +52 5556225293 – Fax: +52  
5556225303. (E-mail: cheko29@hotmail.com, alfdur@unam.mx)

\* Corresponding Author: cheko29@hotmail.com

**Abstract:** the aim of this work was to evaluate the operation of a biological tubular reactor on the real wastewater treatment. This system is a novel technology for the treatment of domestic and industrial wastewater on small scale; his operation is based mainly on the aerobic biological degradation of the contaminants dissolved in the wastewater by accumulated microorganisms inside of the reactor. When the biological tubular reactor was operated in continuous form, it was obtained excellent results for the removal of N-NH<sub>4</sub>, where the removal of nitrogen was 100% considering a range of organic loads of 0.5 to 20 g N-NH<sub>4</sub>/m<sup>2</sup>d. In terms of COD, the removals were from 50% to 98.43% with organic loads near to 60 g COD/m<sup>2</sup>d and it was unstable when the organic load was up 200 g COD/m<sup>2</sup>d. The tubular biological reactor showed to be a feasible technically option for the treatment of small-scale domestic wastewater due to the reactor provided an effluent free of ammonium nitrogen and high COD removal.

**Keywords:** Biological tubular reactor, small wastewater treatment plants, wastewater treatment, water reuse.

## INTRODUCTION

At the beginning of the 21st century, the world faces a water quality crisis, caused by continuous population growth, industrialization, food production practices, increased living standards and poor water use strategies. Major growth will take place in developing countries, particularly in urban areas that already have inadequate wastewater infrastructure (Corcoran et. al., 2010). As human population continues to grow and urbanize, the challenges for securing water resources and disposing of wastewater will become increasingly more difficult.

In addition to that, urban areas are large wastewater producers, providing sanitation services in densely populated areas with current technologies, which involve significant planning and a large and costly infrastructure.

Today, wastewater is usually transported through collection sewers to a centralized Wastewater Treatment Plant (WWTP) at the lowest elevation of the collection system near to the point of disposal site to the environment. Because centralized WWTPs are generally arranged to route wastewater to these remote locations for treatment, water reuse in urban areas is often inhibited by the lack of dual distribution systems. The infrastructure costs for storing and transporting reclaimed water to the points of use are often prohibitive, which is making reuse less economically viable. (Angelakis and Snyder, 2015).

A centralized approach to wastewater treatment has been the globally accepted solution for many decades. While this approach may have been suitable for maintaining urban hygiene in the past, many people agree that in face of a continually growing urban population and increasing water scarcity worldwide, a shift towards decentralization of domestic wastewater should be considered. Some of the issues driving the interest in decentralized systems, apart from declining local water sources are: financial efficiency, installation timeframe of infrastructures, water security, water loss derived from long-distance transport, environmental degradation of aquatic habitats and local community empowerment. Decentralization enables local reuse, water saving and the construction of new infrastructures to keep up with the pace of construction of new residential areas. Furthermore, the shorter life cycle of decentralized, source separated solutions, means that new technological developments may be implemented more rapidly (Opher and Friedler, 2016).

The international trend to solve these problems is designing municipal and industrial wastewater treatment technology more compact and with low energy-consuming systems (WEF, 2010) for be used inside of big cities.

The optimal scenario for municipal wastewater management is the construction of satellite wastewater treatment systems, where reclaimed water will be reused near the point of reclamation. Thus, minimizing pumping costs (Gikas and Tchobanoglous, 2009). So, small decentralized wastewater management systems should be more seriously considered in the future to treat wastewater at or near the points of waste generation. (Angelakis and Snyder, 2015). Reclaimed water will be beneficially used in a number of applications. For example for urban non-potable uses, industrial areas, and landscape irrigation (Angelakis and Gikas, 2014).

Therefore, the aim of this work was to evaluate the operation of a biological tubular reactor on the real wastewater treatment. This system is a novel technology for the treatment of domestic and industrial wastewater on small scale due to it is a compact and low-cost system that treats wastewater in situ, his operation is based mainly on the aerobic biological degradation of the contaminants dissolved in the wastewater by accumulated microorganisms inside of the reactor. Moreover, the system is modular and can be used in cities where space requirements are limited or in rural areas where infrastructure does not exist.

## **MATERIALS AND METHODS**

### **Experimental device**

The biological tubular reactor (BTR) is an aerobic biological reactor (figure 1); it is composed of 5 horizontal tubular modules with 15 cm of diameter and 2 m of length and a height of 1.90 m with a total volume of 0.25 m<sup>3</sup>. Biological system uses nonwoven materials as a support for the fixation of the biomass, the aeration was supplied by Venturi tube.



**Figure 1.** Tubular biological reactor

### **Inoculation**

The bioreactor was inoculated by 100 L of activated sludge with 1965 mg SST/L, it was mixed with 250L of wastewater in a recipe and pumped in the bioreactor, and the inoculum was recirculated by 24 h. Then, the bioreactor was feed with 20 L/min of wastewater by 2 weeks.

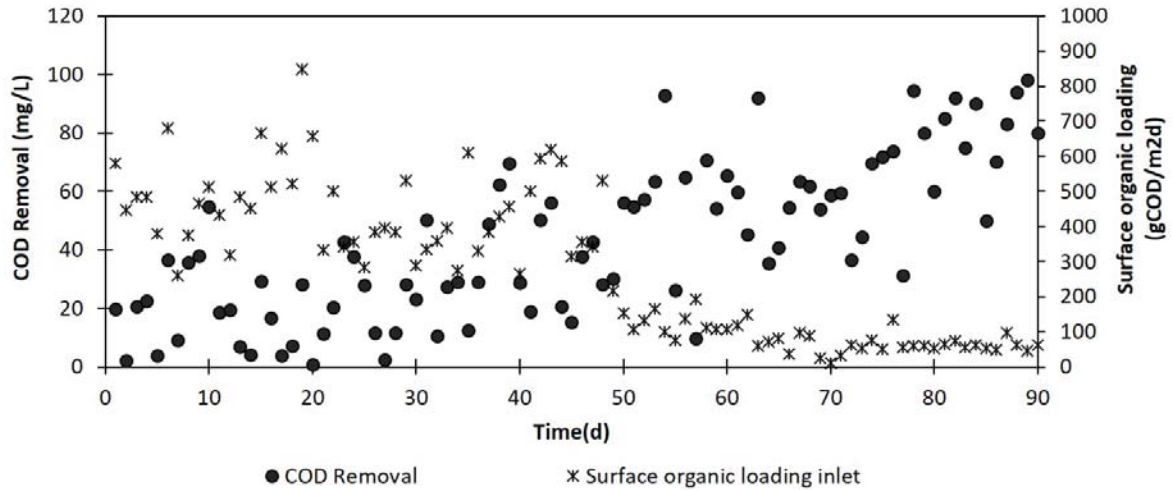
### **Continuous operation**

The reactor was feed with wastewater of treatment plant of the UNAM to verify his operation were determined quality parameters such as DQO, N-NH<sub>4</sub>, N-NO<sub>2</sub> N-NO<sub>3</sub> SST, pH (APHA, 1998) during three months. Dissolved oxygen concentration was measured using a HANNA HI 9143 dissolved oxygen electrode. pH was measured using an Orion™ 2-Star Benchtop pH meter (Thermo Orion, USA).

Additionally, the reactor was operated at different superficial organic load and different air flows to determine the best pollutant removal conditions.

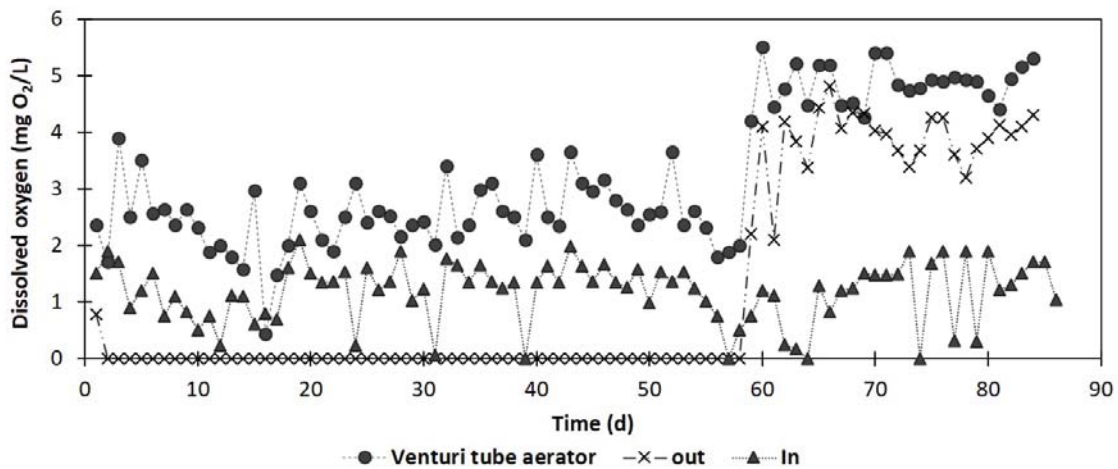
## **RESULTS AND DISCUSSION**

The bioreactor was operated continuously over a period of three months with wastewater from the Wastewater Treatment Plant at the UNAM. Figure 2 shows the COD removal and organic load applied. It was observed that COD removal increases to 90% when the organic loading decreases to near 60 g COD/m<sup>2</sup>d.



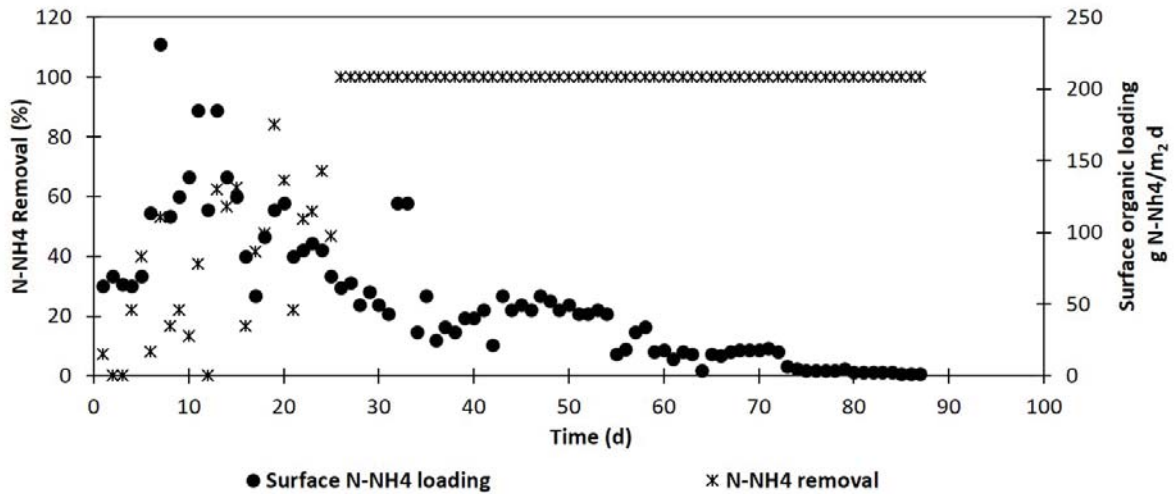
**Figure 2** COD removal at different surface organic loading in BTR

In the first days of the operation in the biological reactor, there was an absence of oxygen in the bioreactor due to a poor suction in the Venturi tube. Since, 60 day tendency could be corrected by increasing the levels of oxygenation in the reactor. Figure 3 shows the dissolved oxygen in the reactor modules during the operation of the bioreactor. The poor COD removal from the reactor in the first few days may be related by the absence of oxygen, the oxygenation in all the modules improved the removal of organic matter.



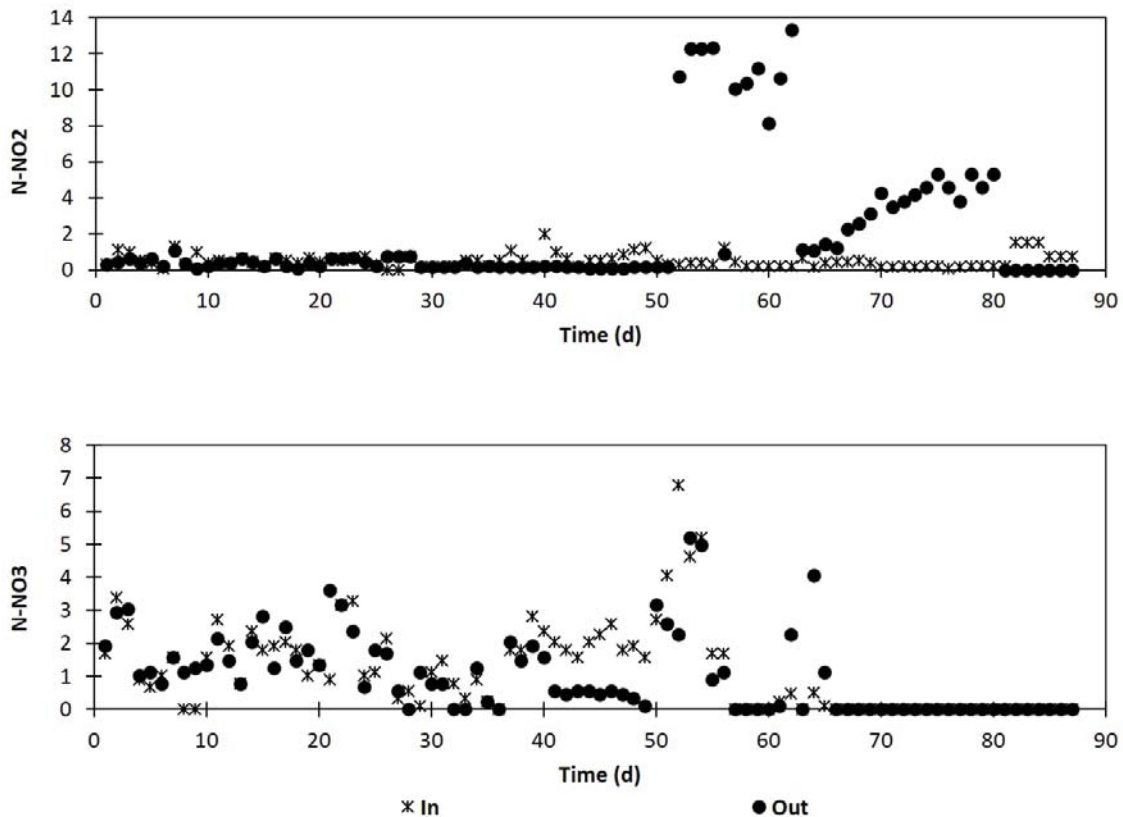
**Figure 3.** Dissolved oxygen in the reactor modules during BTR operation

In regard to the ammonium removal the bioreactor had an excellent performance. Figure 4 shows the removal of ammonium  $N-NH_4$  at different superficial  $N-NH_4$  loading. When the  $N-NH_4$  loadings were around  $100 \text{ g } N-NH_4 / \text{m}^2 \text{ d}$  the biological tubular reactor was unstable the removal of ammonium was near to 60% however, when the  $N-NH_4$  load decreases to 60 until  $5 \text{ g } N-NH_4 / \text{m}^2 \text{ d}$  the removal of ammonium was 100%.



**Figure 4.** Ammonium removal at different superficial N-NH<sub>4</sub> loading in BTR

After 50 days of operation nitrite formation was observed in the bioreactor while the nitrates remained at levels close to 0 mg/L. As shown in Figure 5, this is a clear signal that nitrogen removal within the bioreactors due to the Anamox Process.



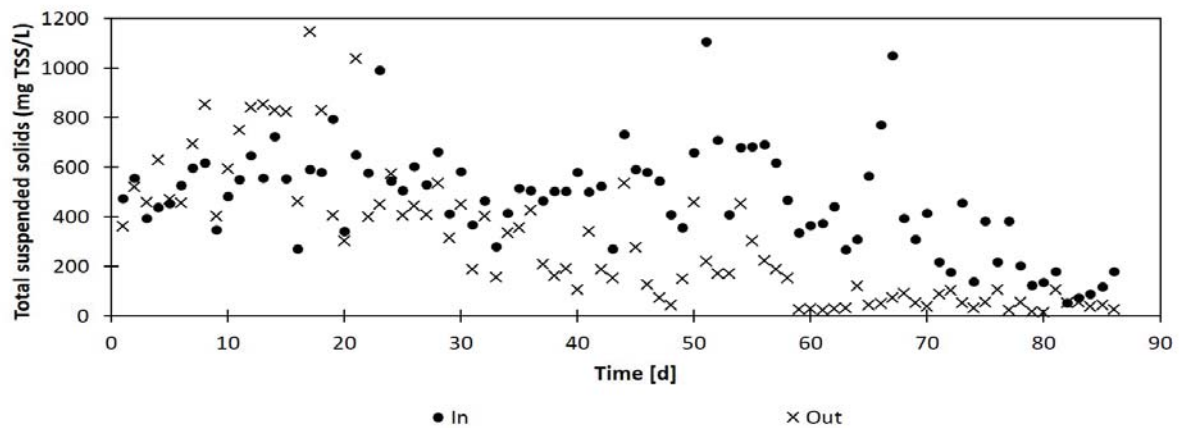
**Figure 5** Nitrite and nitrates measurements in the bioreactor inlet and outlet.

Partial nitrification/anammox process, it is commonly used to remove nitrogen from rich ammonium wastewater. Anaerobic ammonium oxidizing bacteria (Anammox) are capable of oxidizing ammonium with nitrite as electron acceptor. Some works have demonstrated that bacterial competition is influenced in granular sludge by particle size. Nitrogen oxidizing



bacteria tend to grow in smaller particles due to a larger aerobic volume fraction whereas Anammox bacteria dominate in bigger granules due to smaller aerobic volume fraction (Winkler et al., 2012)

Figure 6 shows the TSS at the inlet and outlet of the system, it was observed that the reactor accumulates a considerable amount of SST. After day 58 was observed an excellent TSS removal obtaining an effluent near to 25 mg SST/L.



**Figura 6** Total suspended solids in the bioreactor inlet and outlet.

Figure 7 on the left side shows a fraction of the support used for the microorganisms in it a considerable concentration of microorganisms within the polymer material can be observed. When the SST was determined in the support, it had a concentration of 250 mg SST/cm<sup>2</sup> and the SST inside the reactor was estimated obtaining 392g of SST adhered to the support. And in the right side of Figure 7 shows the inlet and outlet of the reactor.



**Figure 7** Substratum with biofilm (left) Input and output of the bioreactor (right).

In recent works, a complete retention of the biological material within the system is an important requirement for a successful continuous operation of immobilized bioreactors, as the submerged membrane promotes the catalytic process (Chakraborty, 2012).

Moreover, the nonwoven fibrous support immobilized the biofilm in a fashion similar to traditional supports and it protected the cells of shear stress, microorganisms fixed to support generates an advantage and could solve some problems described in this type of

bioreactors(García-González and Durán-Moreno,2016). For example, in horizontal tubular bioreactors maintenance of stable suspended biomass concentration gradient along the bioreactor can be a problem due to biomass washout (Šantek, 2006).

Consequently, biofilm can offer favorable conditions for slow growing organisms such as nitrifying bacteria and anammox bacteria. As well known, aerobic ammonium-oxidizing bacteria (AerAOB) and anaerobic ammonium-oxidizing bacteria (AnAOB) with long generation periods perform two sequential reactions simultaneously under oxygen-limited condition in single stage anammox process. There is no doubt that biofilm-based processes are ideal candidates for AerAOB and AnAOB to co-exist in terms of aerobic region and anaerobic region along the biofilm depth (Liu et. al., 2017).

## **CONCLUSIONS**

Tubular biological reactor showed to be a feasible technically option for the treatment of small-scale domestic wastewater due to the reactor provides an effluent free of ammonium nitrogen and high COD removal. When the biological tubular reactor was operated in continuous form and it was obtained with excellent results of N-NH<sub>4</sub> removal, where the removal of nitrogen was 100% considering a range of N-NH<sub>4</sub> loads of 0.5 to 20 g N-NH<sub>4</sub>/m<sup>2</sup>d. In terms of COD, the removals were from 50% to 98.43% with organic loads near to 60 g COD/m<sup>2</sup>d and it was unstable when the organic load was up 200 g COD/m<sup>2</sup>d. Therefore, it is recommended to continue the study of these types of reactors to determine whether it is possible to carry out the scale of the technology.

## **Acknowledgements**

The authors acknowledge the financial support for this research from the Dirección General de Asuntos del Personal Académico (DGAPA, PAPIIT-IT/102415) of the Universidad Nacional Autónoma de México (UNAM).

## **REFERENCES**

1. American Public Health Association, Water Works Association and Water Environmental Federation, 1998. Standard Methods for the Examination of Water and Wastewater (20th ed.). Washington, USA.
2. Angelakis A. N. and Gikas P., (2014). Water reuse: Overview of current practices and trends in the world with emphasis on EU states. *Water Utility Journal*, 8: 67-78.
3. Angelakis A. N., and Snyder S. A., (2015). Wastewater Treatment and Reuse: Past, Present, and Future. *Water*. 7, 4887-4895.
4. Chakraborty S., Drioli E., Giorno L., (2012). Development of a two separate phase submerged biocatalytic membrane reactor for the production of fatty acids and glycerol from residual vegetable oil streams. *Biomass and bioenergy*, (46), 574-583.
5. Corcoran E., Nellesmann C., Baker E., Bos R., Osborn D. and Savelli H. (2010). Sick water? the central role of wastewater management in sustainable development. A

Rapid Response Assessment. United Nations Environment Programme, UN-HABITAT, GRID-Arendal. Birkeland Trykkeri AS, Norway.

6. García-González S.A. and Durán-Moreno A. (2016) Effect of aeration rate on the performance of a novel non woven flat plate bioreactor 13th IWA Specialized Conference on Small Water and Wastewater Systems & 5th IWA Specialized Conference on Resources-Oriented Sanitation, 14-17/9/2016, Athens, Greece
7. Gikas P., Tchobanoglous G., (2009). The role of satellite and decentralized strategies in water resources management". *J. Environ. Manage.*90 (1), 144-152.
8. Liu T., Quana X., Li D. (2017). Evaluations of biofilm thickness and dissolved oxygen on single stage anammox process in an up-flow biological aerated filter. *Biochemical Engineering Journal.* (119), 20-26.
9. Opher T., Friedler E., (2016). Comparative LCA of decentralized wastewater treatment alternatives for non-potable urban reuse. *Journal of Environmental Management.* (182), 464-476.
10. Water Environment Federation WEF,. *Biofilm reactors: Manual of Practice No. 35.* McGraw-Hill, WEF Press, New York, 2010.
11. Winkler M. K.H., Yang J., Kleerebezem R., Plaza E., Trela J., Hultman B., van Loosdrecht M. C. M., (2012). Nitrate reduction by organotrophic Anammox bacteria in a nitrification/anammox granular sludge and a moving bed biofilm reactor. *Bioresource Technology.* (114), 217-223.

## **Impacts of operational conditions on oxygen transfer rate, mixing characteristics and residence time distribution in a pilot scale high rate algal pond**

**Pham, L. A., Laurent J., Bois P., Wanko A.**

ICube, UMR 7357, ENGEES, CNRS, Université de Strasbourg, 2 rue Boussingault, 67000 Strasbourg, France

**Reviewer's comments:** Add some performance results

**Key words:** oxygen transfer rate, mixing characteristics, residence time distribution, HRAP.

### **Abstract**

Different combinations of operational parameters including water level, paddle rotation speed and influent flow rate were applied to investigate their impacts on mixing characteristics and gas transfer coefficients in pilot-scale high rate algal pond (HRAP). Paddle rotation speed had positive correlation with Bodenstein number, water velocity and oxygen transfer coefficient while increasing water level put negative impact on these parameters, although the impact of water level on water linear velocity was small. Amplification effect of water level and paddle rotation speed on sensitivity of Bodenstein number ( $Bo$ ) and  $k_{LAO_2}$  should be noticed and considered before applying operational parameters for HRAP system. On the other hand, paddle rotation speed had more impact on  $k_{LAO_2}$  than on  $Bo$ . Small impact of inlet flow rate as well as HRT on effective volume/total volume ratio was noticed, while higher paddle rotation speed seemed to increase dead zone in HRAP. In this study, the optimal operational conditions included 0.1m water level and 11.6rpm paddle rotation speed (7 Volt applied).

### **Introduction**

Microalgae have received considerable attention as material for biofuel production due to their capacity of accumulating high amount of lipids and carbohydrates. When cultured in suitable conditions, microalgae showed potential oil yield of 58.7 m<sup>3</sup>/ha/year, while current terrestrial plant used for producing biofuel only reached 5.4 m<sup>3</sup>/ha/year. Microalgae can use wastewater and flue gas as nutrient sources, which also serve as a treatment unit (Mata, Martins, et al., 2010). In the context of cultivating microalgae (algal biomass) for biofuel production, high rate algal pond (HRAP) showed strong advantages over closed photobioreactor including low energy, financial requirement, easier for maintenance and more feasible in expanding to large scale.

HRAP is a shallow raceway-type pond with paddlewheel as the only source of movement (Park, Craggs, et al., 2010). It was estimated HRAP accounted for 95% of large scale microalgae production facility worldwide (Kumar, Mishra, et al., 2015). One major aspect when operating HRAP is the hydrodynamics because proper mixing allows materials to be evenly distributed in the pond, avoids sedimentation and thus anaerobic condition. Extensive studies had been conducted to investigate the impacts of pond or paddlewheel designs as well as some operational

conditions on hydrodynamic conditions or energy consumption in the HRAP. Advanced mathematical models were employed to understand flowing patterns in the raceway under such influences (Mendoza, Granados, et al., 2013; Bitog, Lee, et al., 2011; Liffman, Paterson, et al., 2013; Hreiz, Sialve, et al., 2014; Hadiyanto, Elmore, et al., 2013), yet there is still need for experimental validation (Hadiyanto, Elmore, et al., 2013).

Due to its advantages, HRAP can be applied in many places which make its operation, shape and sizes vary depending on local conditions. However, the operational conditions such as water level, paddle wheel movement or inlet flow rate can govern the hydrodynamic characteristics inside HRAP. Moreover, hydrodynamic is one of the major factors influencing gas transfer in open aerobic biological reactor like HRAP. Therefore, varying operational conditions could have a direct impact on biochemical processes or gas transfer and thus on the performance of the system. Thus understanding such difference is important for choosing the suitable operational conditions for optimizing performance of HRAP.

This study aims to determine the impacts of operational conditions including water level, inlet flow rate and paddle wheel movement on hydrodynamics in a pilot scale HRAP. Classical method employing tracer experiment to obtain residence time distributions (RTD) was applied due to its financial saving, availability and effectiveness. Moreover, to understand how such variation in hydrodynamics impacts gas transfer in HRAP, oxygen transfer rate will also be investigated. Finally, an optimal operational condition will be chosen to apply in the pilot HRAP for algal-bacterial biomass cultivation.

## **Material and Methods**

### ***Pilot description***

The pilot HRAP consists of a single loop race way pond with two straight channels separated by a separation wall and connected by 180° bend at each end. Liquid circulation in the pilot was ensured by a paddlewheel which was driven by a brushed DC motor (DMN37K, 24V, Nidec Servo Corporation, Japan) which was controlled by a bench power supply (ISO-TECH IPS303DD, England). The pilot and paddlewheel were made of transparent plastic (Fig. 1).

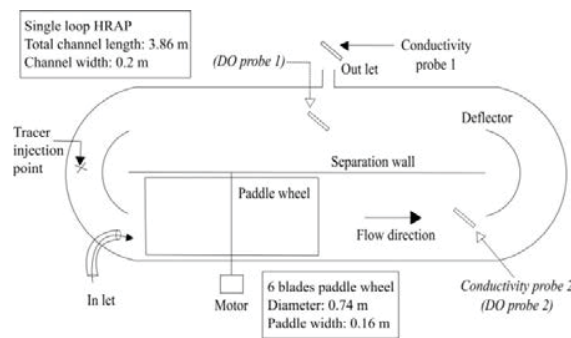
### ***Operational conditions applied***

Combinations of different water level (0.1, 0.15, 0.2 m), inlet flow rate (6 and 9 L/h) and paddle movement in terms of voltage applied (3.5, 7, 10.5 Volt) were applied. Total water volume of the pilot at water level of 0.1, 0.15 and 0.2 m were 72, 108 and 144 L, respectively. The average paddle rotation speed obtained at voltage applied of 3.5, 7, 10.5 Volt were  $5.6 \pm 0.4$ ,  $11.6 \pm 0.9$  and  $16.8 \pm 2.1$  rpm, respectively.

### ***HRAP mixing characteristics and hydrodynamic modeling under different operational conditions***

Mixing characteristics and hydrodynamics of pilot HRAP under different operational conditions were investigated by using tracer test (Levenspiel, 1999). Water conductivity correlated with NaCl concentration was measured every 5s by conductivity electrode (TetraCon<sup>®</sup> 325, WTW, Germany) connected to a multi-parameter portable meter (Multiline P4, WTW, Germany) and recorded with communications software (Multi/Achat II, ver. 1.05, WTW, Germany) (Fig. 1).

For evaluating mixing characteristics inside the pilot, which was mainly due to paddle movement, HRAP was operated in closed condition (inlet flow rate = 0). RTD data obtained was calculated following Voncken, Holmes, et al., 1964 and then used to assess mixing characteristics inside the HRAP. Moreover, in practice, HRAP will be operated in continuous condition, thus RTD data from experiments with continuous operational conditions was calculated based on Levenspiel, 1999 and used to evaluate hydrodynamic behavior of the pilot HRAP. Detailed calculation procedure is indicated in the appendix.



**Figure 1. General illustration of pilot HRAP with tracer experiments in open condition (normal figures and text), in closed condition (dashed figure and italic text) and oxygen transfer rate experiments in closed condition (dashed figures, italic text in brackets)**

### ***HRAP gas transfer rates***

Oxygen transfer rate determination under different operational conditions was performed following European standard (NF EN 12255-15). Evolution of dissolved oxygen (DO) in water was measured by dissolved oxygen electrode (WTW Inolab Oxi Level II Dissolved Oxygen Meter) connected to a multi-parameter portable meter (Multiline P4, WTW, Germany) and recorded with communications software (Multi/Achat II, ver. 1.05, WTW, Germany). Oxygen transfer coefficient ( $k_{LaO_2}$ ) was calculated following procedure reported by Garcia-Ochoa and Gomez, 2009 which takes into account the dynamic response of the electrodes.

### ***Sensitivity analysis***

Two sensitivity functions were used including the absolute-relative (a-r) sensitivity function measuring the absolute change in the variable for a 100% change in input parameter, and the relative-relative (r-r) sensitivity function measuring the relative change in the variable for a 100% change in input parameter. The a-r sensitivity was used for quantitative comparisons of the

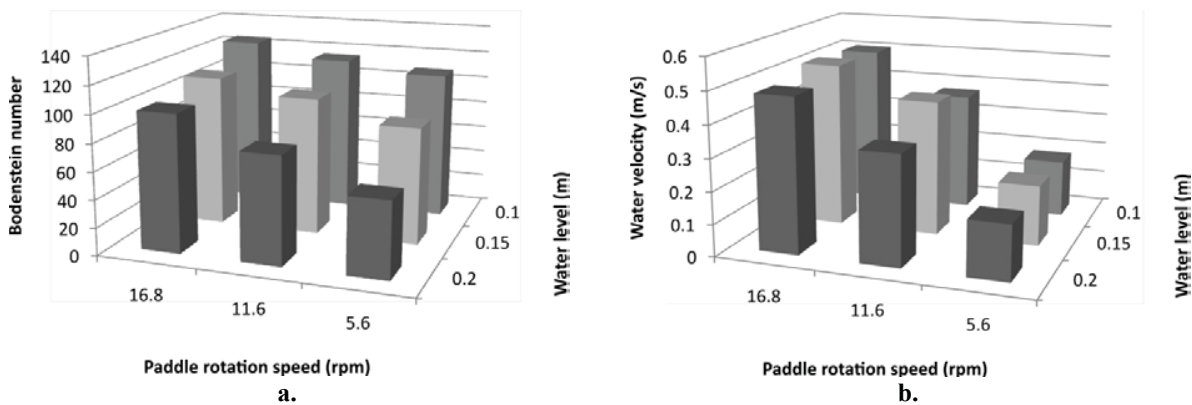


effect of different parameters (water level, paddle rotation speed) on a common variable  $y$  ( $Bo$ ,  $k_{La}$ ). While the  $r$ - $r$  sensitivity was used to compare effects of different parameters on different variables (Reichert, 1994). One-way ANOVA following by Holm tests (95 % confidence interval) was applied in R software (version 3.3.1 (2016-06-21)) to compare these effects. Detailed calculation procedure is indicated in the appendix.

## Results and Discussion

### *Impacts of operational conditions on mixing characteristics*

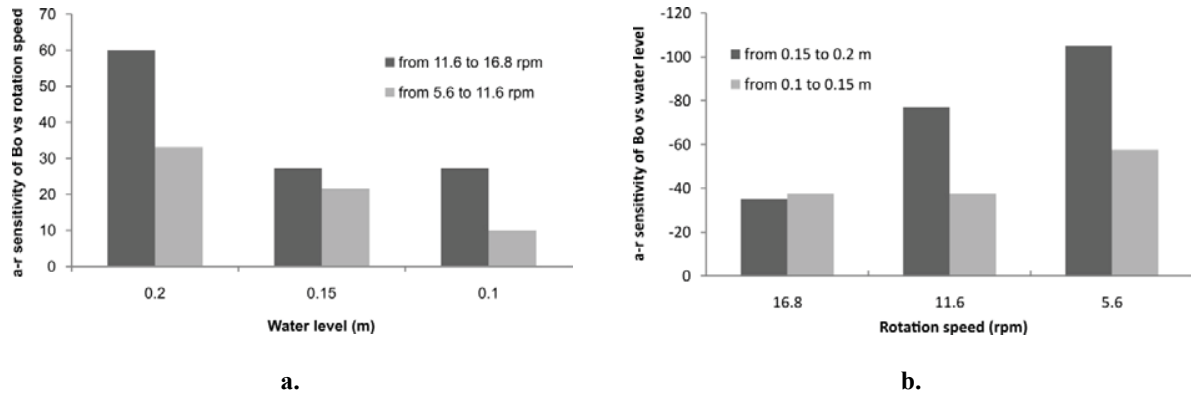
The Bodenstein ( $Bo$ ) number in the pilot HRAP was calculated according to RTD data obtained. High values of  $Bo$  in every experiment suggested plug flow behavior in the pilot HRAP which is in accordance with literature (Miller and Buhr, 1981). Results indicated that  $Bo$  had positive correlation with paddle rotation speed but negative relation with water level (Fig. 2 a.). The average water velocity along the raceway channel which had direct correlation with  $Bo$  was also calculated. In practice, it was suggested that water velocity of 0.2 to 0.3 m/s was sufficient for a HRAP. In this study, the required velocity was satisfied even with the lowest power applied (3.5 V or 5.6 rpm). Moreover, higher velocity may cause more energy consumption (Andersen, 2005). Obviously, paddle rotation speed had strong influence on the circulation in the raceway and their correlation was positive. The change in water level has impact on water velocity due to the fact that as the water level increases, a larger paddle area will be immersed: it results in a decrease of the rotation speed of the paddle. However, this impact was small in this study (Fig. 2 b.).



**Figure 2. Influence of paddle rotation speed, water level to Bodenstein number (a.) and water velocity (b.) in pilot HRAP.**

Sensitivity analysis showed that at one water level,  $Bo$  was more sensitive with the change of paddle rotation speed from 11.6 to 16.8 rpm than from 5.6 to 11.6 rpm. Moreover, as the water level increased, the sensitivity of  $Bo$  with paddle rotation speed also increased (Fig. 3 a.). On the other hand, except at the highest paddle rotation speed,  $Bo$  was more sensitive with the change of water level from 0.15 to 0.2 m than from 0.1 to 0.15 m. As the paddle rotation speed decreased, the sensitivity of  $Bo$  with water level increased (Fig. 3 b.). Since the Bodenstein number

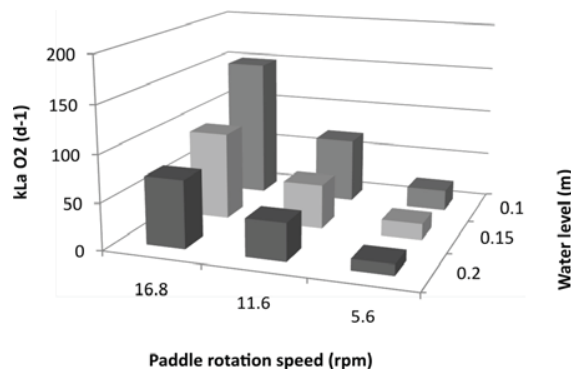
represents the ratio of the total momentum transfer over the molecular mass transfer, any increase in Bo value may lead to an increase in advection and hence shear stress which can damage algal cells (Mata, Martins, et al., 2010). Therefore, the amplification of Bo sensitivity with paddle rotation speed at high speed and/or high water level should be considered before choosing the operational conditions for HRAP.



**Figure 3. Absolute-Relative sensitivity (dimensionless) of Bodenstein number versus paddle rotation speed (a.) and water level (b.). The sign represents positive (no sign) or negative (- sign) correlation.**

#### *Impacts of operational conditions on O<sub>2</sub> transfer rates*

Oxygen transfer coefficients ( $k_{LAO_2}$ ) due to mechanical mixing were calculated from experimental data. It was showed that  $k_{LAO_2}$  in HRAP had positive correlation with paddle rotation speed and negative correlation with water level which was in good agreement with Bo values obtained (Fig. 4). It suggests that higher paddle rotation speed causes more mixing in water and thus more oxygen can be transferred. On the other hand, higher water level (higher volume of fluid) in the reactor decreases mechanical mixing caused by the paddle and thus decreases oxygen transfer coefficient.



**Figure 4. Influence of paddle wheel rotation, water level to oxygen transfer coefficient in pilot HRAP.**

Results from sensitivity analysis indicated that  $k_{LAO_2}$  was more sensitive with the change of paddle rotation speed from 11.6 to 16.8 rpm than from 5.6 to 11.6 rpm. The decreasing of water level also caused higher sensitivity of  $k_{LAO_2}$  with paddle rotation speed (Fig. 5. a.). Water level

changing from 0.1 to 0.15 m caused more change in  $k_{LaO_2}$  than when changing from 0.15 to 0.2 m. As the paddle rotation speed decreasing, the sensitivity of  $k_{LaO_2}$  with water level also decreased with the only exception in rotation speed of 5.6 rpm (Fig. 5. b.). In practice, better gas transfer rate has benefits for the HRAP system including reducing the occurrence of oxygen saturation or anaerobic condition, and hence avoid stressful condition for algae. Therefore, the increased sensitivity of  $k_{LaO_2}$  at high paddle rotation speed and/or at low water level should be considered as precaution.

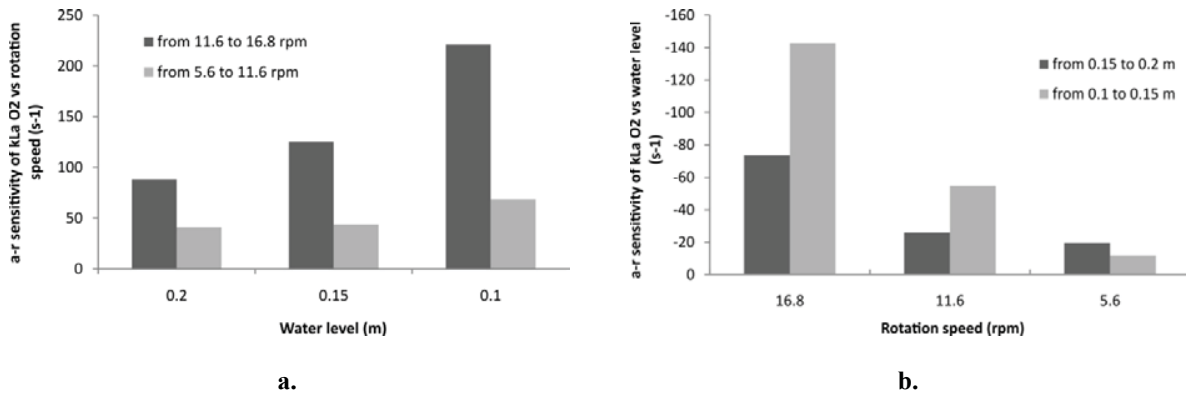


Figure 5. Absolute-Relative sensitivity ( $d^{-1}$ ) of oxygen transfer coefficient ( $k_{LaO_2}$ ) versus paddle rotation speed (a.) and water level (b.). The sign represents positive (no sign) or negative (- sign) correlation.

### Impacts of operational conditions on HRAP hydrodynamics in continuous mode

Result of effective volume/total volume ratios indicated that there is a significant proportion of dead zone (up to 50% at the highest paddle rotation) in the reactor. The increase of paddle rotation speed induced a significant decrease of the effective volume ratio. At the lowest paddle rotation speed, impacts of higher water levels and inlet flow rates resulted to slight increases of the effective volume/total volume ratio. However, these differences decreased as the paddle rotation speed increased. Therefore, the paddle wheel rotation speed and inlet/outlet positions should be optimized to favor mixing time while avoiding dead zone.

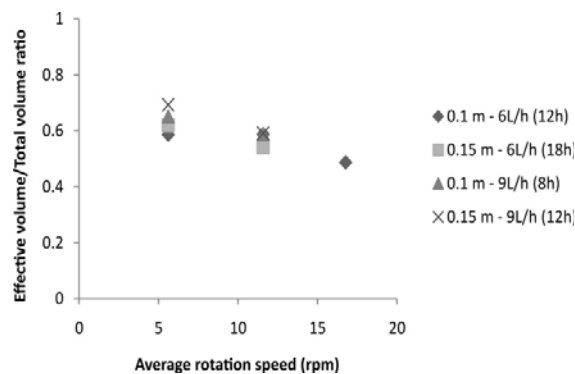
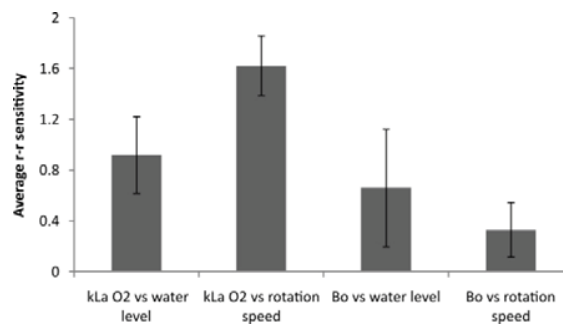


Figure 6. Influence of paddle wheel rotation, water level and inlet flow rate (corresponding HRT put in brackets) to effective volume/total volume ratio in pilot HRAP.

### *Evaluating the impacts of operational conditions on HRAP performance*

To compare the impacts of different operational parameters including water level, paddle rotation speed on  $k_{LAO_2}$  and  $Bo$  in closed operational condition, relative-relative sensitivity of  $k_{LAO_2}$  and  $Bo$  with water level and paddle rotation speed was employed (Fig. 7).  $k_{LAO_2}$  was more sensitive with paddle rotation than with water level ( $p$  value  $< 0.05$ ). In addition, the sensitivities of  $Bo$  with water level and paddle rotation speed were similar ( $p$  value  $> 0.05$ ). On the other side, water level had similar sensitivities with  $k_{LAO_2}$  and  $Bo$  ( $p$  value  $> 0.05$ ), while paddle rotation speed had higher sensitivity with  $k_{LAO_2}$  than with  $Bo$  ( $p$  value  $< 0.05$ ). These results suggested stronger impacts on  $k_{LAO_2}$  from paddle rotation speed than from water level. Similar degree of influences was seen between water level and paddle rotation speed on  $Bo$ . Moreover, paddle rotation speed had more impacts on  $k_{LAO_2}$  than on  $Bo$ . It may suggest changing paddle rotation speed would be more efficient if one wants to improve the  $k_{LAO_2}$ .

Although according to results in this study, a combination of lowest water level and highest paddle rotation should be the best option to achieve optimal hydrodynamics and gas transfer efficiency in HRAP, it may not be the case when considering system performance. High paddle rotation speed can provide better mixing, increase gas transferring and reduce dead zone but it also increases shear stress causing cell damage and consumes greater power, thus increasing the cost (Hadiyanto, Elmore, et al., 2013). Moreover, in this study, global hydrodynamics result indicated that higher rotation speed is likely to keep more biomass staying in the reactor. Therefore, the best combination of operational conditions in this study should be between water level of 0.1m and paddle rotation speed of 11.6rpm (7 Volt applied).



**Figure 7. Average Relative-Relative sensitivities (dimensionless) of oxygen transfer coefficient and Bodenstein number versus water level and paddle rotation speed. Data was converted to absolute value for comparison.**

### **Conclusion**

In this study, different combinations of water level, paddle rotation speed and influent flow rate were applied to investigate their impacts on mixing characteristics oxygen and carbonic transfer coefficients of the pilot HRAP. In general, the pilot HRAP showed good mixing level even with the lowest paddle rotation speed applied, and hence the entire HRAP can be considered as a CSTR. Bodenstein number, water velocity and oxygen transfer coefficient had positive

correlation with paddle rotation speed but negative correlation with water level although the impact of water level on water linear velocity was small. Amplification effect of water level and paddle rotation speed on sensitivity of  $B_o$  and  $k_{LAO_2}$  should be noticed and considered before applying operational parameters for HRAP system. Paddle rotation speed had more impact on  $k_{LAO_2}$  than on  $B_o$ . Small impact of inlet flow rate as well as HRT on effective volume/total volume ratio was noticed, while higher paddle rotation speed seemed to increase dead zone in HRAP. The optimal operational conditions included 0.1m water level and 11.6rpm paddle rotation speed (7 Volt applied). These data obtained could be useful for calibrating 3D hydrodynamic model for better studying the impact of operational conditions on HRAP.

## References

- Andersen, R. A. (2005) *Algal Culturing Techniques*, Academic Press.
- Bitog, J. P., Lee, I.-B., Lee, C.-G., Kim, K.-S., Hwang, H.-S., Hong, S.-W., Seo, I.-H., Kwon, K.-S., and Mostafa, E. (2011) Application of computational fluid dynamics for modeling and designing photobioreactors for microalgae production: a review. *Computers and Electronics in Agriculture*, **76**(2), 131–147.
- El Ouarghi, H., Boumansour, B. E., Dufayt, O., El Hamouri, B., and Vassel, J. L. (2000) Hydrodynamics and oxygen balance in a high-rate algal pond. *Water science and technology*, **42**(10-11), 349–356.
- Garcia-Ochoa, F. and Gomez, E. (2009) Bioreactor scale-up and oxygen transfer rate in microbial processes: An overview. *Biotechnology Advances*, **27**(2), 153–176.
- Hadiyanto, H., Elmore, S., Van Gerven, T., and Stankiewicz, A. (2013) Hydrodynamic evaluations in high rate algae pond (HRAP) design. *Chemical engineering journal*, **217**, 231–239.
- Hreiz, R., Sialve, B., Morchain, J., Escudié, R., Steyer, J.-P., and Guiraud, P. (2014) Experimental and numerical investigation of hydrodynamics in raceway reactors used for algaculture. *Chemical Engineering Journal*, **250**, 230–239.
- Jupsin, H., Praet, E., and Vassel, J.-L. (2003) Dynamic mathematical model of high rate algal ponds (HRAP). *Water science and technology*, **48**(2), 197–204.
- Kumar, K., Mishra, S. K., Shrivastav, A., Park, M. S., and Yang, J.-W. (2015) Recent trends in the mass cultivation of algae in raceway ponds. *Renewable and Sustainable Energy Reviews*, **51**, 875–885.
- Levenspiel, O. (1999) *Chemical reaction engineering*, Wiley.
- Liffman, K., Paterson, D. A., Liovic, P., and Bandopadhyay, P. (2013) Comparing the energy efficiency of different high rate algal raceway pond designs using computational fluid dynamics. *Chemical Engineering Research and Design*, **91**(2), 221–226.
- Mata, T. M., Martins, A. A., and Caetano, N. S. (2010) Microalgae for biodiesel production and other applications: A review. *Renewable and Sustainable Energy Reviews*, **14**(1), 217–232.
- Mendoza, J. L., Granados, M. R., de Godos, I., Acién, F. G., Molina, E., Banks, C., and Heaven, S. (2013) Fluid-dynamic characterization of real-scale raceway reactors for microalgae production. *Biomass and Bioenergy*, **54**, 267–275.
- Miller, S. B. and Buhr, H. O. (1981) Mixing characteristics of a high-rate algae pond. *Water SA*, **7**(1). [online] [http://www.wrc.org.za/Knowledge%20Hub%20Documents/Water%20SA%20Journals/Manuscripts/1981/WaterSA\\_1981\\_%207\\_0202.PDF](http://www.wrc.org.za/Knowledge%20Hub%20Documents/Water%20SA%20Journals/Manuscripts/1981/WaterSA_1981_%207_0202.PDF) (Accessed November 25, 2016).
- Park, J. B. K., Craggs, R. J., and Shilton, A. N. (2010) Wastewater treatment high rate algal ponds for biofuel production. *Bioresource Technology*, **102**(1), 35–42.
- Reichert, P. (1994) AQUASIM—a tool for simulation and data analysis of aquatic systems. *Water Science and Technology*, **30**(2), 21–30.
- Spérandio, M. and Paul, E. (1997) Determination of carbon dioxide evolution rate using on-line gas analysis during dynamic biodegradation experiments. *Biotechnology and Bioengineering*, **53**(3), 243–252.
- Voncken, R. M., Holmes, D. B., and Den Hartog, H. W. (1964) Fluid flow in turbine-stirred, baffled tanks—II: Dispersion during circulation. *Chemical Engineering Science*, **19**(3), 209–213.

## Appendix

### Calculation details:

*Bodenstein (Bo) number calculation:*

$$\frac{C}{C_{\infty}} = \sqrt{\frac{Bo}{4\pi\theta}} \sum_{j=1}^{\infty} \exp\left[-\frac{Bo}{4\theta}(j-\theta)^2\right] \quad (1A)$$

With C is the concentration of tracer detected,  $C_{\infty}$  is the concentration of tracer at infinite time and  $\theta$  is the dimensionless time which is denoted as  $\theta=t/t_c$  ( $t_c$  is circulation time and t is time).

*Oxygen transfer coefficient ( $k_{LAO_2}$ ) calculation:*

$$C_{me} = C^* + \frac{C^* - C_0}{1 - \tau_r k_L a} * \left[ \tau_r k_L a \exp\left(\frac{-t}{\tau_r}\right) - \exp(k_L a * t) \right] \quad (2A)$$

With  $C_{me}$  is the oxygen concentration measured by the electrode and  $C_0$  is the oxygen concentration at the initial time of the aeration while  $C^*$  is equilibrium value of oxygen concentration.  $\tau_r$  is the response time of the electrode and t is time.

*Sensitivity functions:*

$$\delta_{y,p}^{a,r} = p \frac{\partial y}{\partial p} \quad (3A)$$

$$\delta_{y,p}^{r,r} = \frac{p}{y} \frac{\partial y}{\partial p} \quad (4A)$$

With y is the variable that changes due to the change of parameter p.

*Calculation of hydrodynamic parameters in continuous condition:*

*Residence Time Distribution (RTD):*

The RTD function  $E(t)$  can be defined as  $E(t)\Delta t$  = fraction of incoming water that stays in the reactor for a length of time between t and  $\Delta t$ . It is calculated as follows:

$$E(t) = \frac{Q(t)C(t)}{\int_0^{\infty} Q(t)C(t)dt} = \frac{Q(t_i)C(t_i)}{\sum Q(t_i)C(t_i)\Delta t_i} \quad (5A)$$

*Mean residence time ( $\bar{t}$ ):*

$$\bar{t} = \int_0^{\infty} tE(t)dt = \sum t_i E(t_i)\Delta t_i \quad (6A)$$

*Variance ( $\sigma$ ) which is a measure of the RTD curve's spread:*

$$\sigma = \int_0^{\infty} (t - \bar{t})^2 E(t)dt = \sum t_i^2 E(t_i)\Delta t_i - \bar{t}^2 \quad (7A)$$

*Dimensionless variance:*

$$\sigma_{\theta}^2 = \frac{\sigma^2}{\bar{t}^2} \quad (8A)$$



*Calculation of  $uL/D$  ratio for a closed vessel:*

$$\sigma_{\theta}^2 = 2 \left( \frac{D}{uL} \right) - 2 \left( \frac{D}{uL} \right)^2 [1 - e^{-uL/D}] \quad (9A)$$

With D is dispersion coefficient, u is water velocity and L is the length between input and measurement points.

*Calculation of effective volume/total volume ratio:*

$$\frac{\bar{t}}{HRT} \quad (10A)$$

With HRT is hydraulic retention time of the reactor.

## Effects of an increase in salinity on PAOs in EBPRR-SBBR reactors in coastal small populations.

Aragón, C.<sup>1</sup>, Real, A.<sup>1</sup>, Pavón, C.<sup>2</sup>, Romero, P.<sup>2</sup>, Coello, D.<sup>2</sup>

<sup>1</sup> Centro de las Nuevas Tecnologías del Agua. Autovía Sevilla-Huelva (A49), km. 28. 41820. Carrión de los Céspedes, Spain

<sup>2</sup> Universidad de Cádiz. Pol. Río San Pedro s/n, 11510, Puerto Real, Spain.

**Keywords:** biofilm SBBR; phosphorous removal and recovery; saline wastewater.

### Introduction

As phosphorus is non-renewable element, its recycling is of great interest. Huge amount of phosphorus is lost annually for lack of P recovery, some part in wastewater treatment plants (WWTP). Stepwise, WWTP are adopting flow-diagrams that allow not only the removal of phosphorous from the water stream but also the recovery of such element. Most of them are based on enhanced biological phosphorous removal and recovery (EBPRR) processes. One of the systems currently applied to reach P removal and recovery is the sequencing biofilm batch reactor (SBBR) where microorganisms linked to P uptake growth attached to a plastic carrier. High performances on P removal are related to the presence and enrichment of Poly-phosphate accumulating organisms, PAO (Blackall *et al.*, 2002). Several environ factors affect the abundance of PAO: temperature, pH, carbon source, among others (Seviour & Nielsen, 2010). However, effect of salinity on the EBPR still remains unclear (Welles *et al.*, 2014). In this research, the SBBR behaviour in the face of a short increase in salinity was evaluated. The results of this research are applicable for those small and medium size populations located in coastal areas or those WWTP that suffer from saline intrusion.

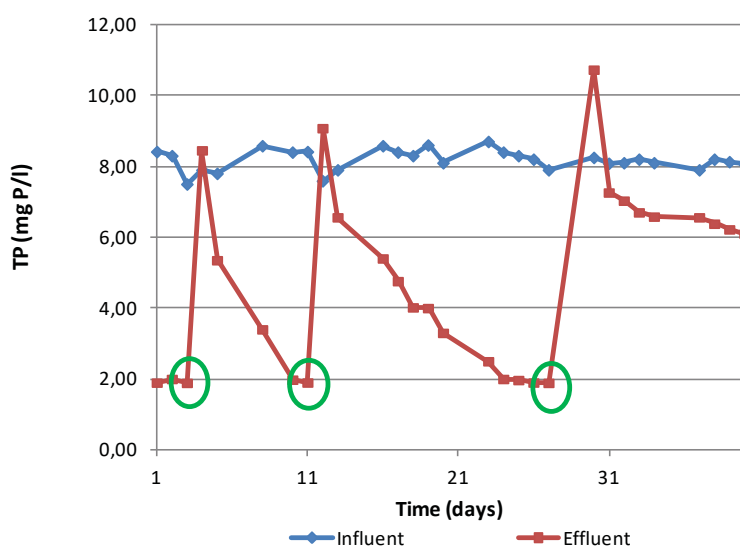
### Material and Methods

Test were carried out in a 10 L-lab-scale –SBBR. The SBBR was operated in cycles of 8 h (3 h anaerobic, 3 aerobic, 1 h anoxic and 1h settling phase). The SBBR reactor contained suspended polyethylene carriers comprising 10% of reactor volume.

Daily, the reactor was fed with 15 L of urban wastewater from the Experimental Plant of CENTA at Carrión de los Céspedes (Seville, Spain). Once the reactor reached steady-state conditions, a punctual increase on salinity (by adding filtered seawater) was maintained during 3 consecutive cycles (24 hours) to check the acute effect on PAOs and the lag phase till recovering steady-state conditions. Three salinity concentrations were chosen in a step-wise manner from 0 to 10 % salinity (W/V)- 3 to 7.5 mS/cm- to cover the whole inhibition range of the microorganisms (from 0 to 100 % relative inhibition). The effect of the punctual increase on salinity on PAOs activity was assessed by the estimation of P removal rate.

## Results and Discussion

Figure 1 shows the curves of TP (mg/l) in the influent and effluent of the SBBR during the trial. In green circles, the days when the peaks of salinity are induced: 2% the first one (3 mS/cm), 5%, the second (4.9 mS/cm) and, 10 %, the third (7.5 mS/cm). According to the results, an increase in salinity, even at low doses, leads to a decrease in the P uptake capacity of the SBBR. In fact, the concentration of TP of increases from 2 mg/l at steady-state conditions to above 8 mg/l when the salinity is raised in the influent of the system. Furthermore, it is observed that the higher the salinity peak the larger period of time is required for reaching steady-state conditions in the system. When increasing the salinity above 7.5 mS/cm, the P uptake by PAO populations is seriously damaged, as observed at the end of the trial.



**Figure 1. TP (mg/l) observed during the trial in the influent and effluent of the SBBR**

Although biofilms are supposed to protect the biomass involved in the degradation of organic matter and nutrients uptake, it seems it is not able to reduce the impact of an increased salinity in wastewaters. Therefore, complementary treatments, such as chemical processes, should be included in the flow-sheet for preventing the uncontrolled release of nutrients in small WWTP.

## References

- Blackall, L.L., Crocetti, G.R., Saunders, A.M. & Bond, P.L. 2002. A review and update of the microbiology of enhanced biological phosphorus removal in WWTPs. *Antonie van Leeuwenhoek* 81, 681–691.
- Seviour, R. & Nielsen, P.H. 2010. *Microbial Ecology of Activated Sludge*. IWA Publishing. London.
- Welles L., Lopez-Vazquez C. M., Hooijmans C. M., van Loosdrecht M. C. M., Brdjanovic D. (2014). Impact of salinity on the anaerobic metabolism of phosphate-accumulating organisms (PAO) and glycogen-accumulating organisms (GAO). *Appl Microbiol Biotechnol* (2014) 98:7609–7622. DOI 10.1007/s00253-014-5778-4.

## Ten years of German experience in using ecotechnologies for onsite treatment of industrial pollution

Aubron, T.<sup>1</sup>, van Afferden, M.<sup>1</sup>, Mosig, P.<sup>1</sup>, Rahman, K.<sup>1</sup>, Müller, R.A.<sup>1</sup>

<sup>1</sup> Helmholtz Centre for Environmental Research (UFZ), Environmental and Biotechnology Center – UBZ, Permoserstrasse 15, Leipzig, 04318 GERMANY (thomas.aubron@ufz.de)

**Keywords:** Ecotechnology; vertical flow filter, industrial pollution, organic compounds, hydrocarbons

### Introduction

A rich and complex history of industrial activities, war-destruction, and economic turmoil has left Germany with more than 300 000 industrial contaminated sites presenting a threat to both the environment and the local populations. Many factories, chemical plants, and landfills remain in operation and sometimes still contribute to the contamination of rivers and aquifers. As part of the regulation, these sites have been inventoried and, when possible, the cocktail of pollutants identified. The common mix of pollutants include biodegradable organic compounds such as BTEX, MTBE, aliphatic hydrocarbons and PAHs; “non-biodegradable” organic compounds such as organochlorides as well as inorganic compounds such as sulphides and cyanides.

Physico-chemical treatment units (air stripping, adsorption, chemical oxidation...) have been extensively implemented to treat water/wastewater and bring pollutant concentrations below accepted limits (DVGW, 2001). Since 2007, the UFZ has tested ecotechnologies such as treatment wetlands for the same purpose. Compared to other conventional systems, ecotechnologies have proven to be effective, robust, inexpensive to operate and easy to maintain (van Afferden, 2011). Several treatment wetland pilot-scale investigations have been successfully validated and implemented at full-scale.

### Material and Methods

As of January 2017, the UFZ has designed, operated and tested six pilots for the treatment of contaminated water with pollutant concentrations as high as 30,000 µg.L<sup>-1</sup>. The typical pilot-scale ecotechnology design consists of two or three stages of vertical flow filters. The first filter is dedicated to the pre-treatment of the influent while the second and/ third filters perform the main treatment. The coarse media (gravel or expanded clay) used for the filters and the extremely high hydraulic load to applied (up to 4 m<sup>3</sup>.m<sup>-2</sup>.d<sup>-1</sup>) limit the risk of ion precipitation that could otherwise induce clogging. Homogeneous distribution of the influent water is critical to ensure proper treatment.

Once the performance of a pilot plant meets the concentration limits, a scaling-up process can be initiated to prepare for a full-scale implementation. This process covers the aspects ranging from design to technical and operational specifications and from permitting procedures to cost estimation for feasibility and tendering.

## Results and Discussion

Of the six pilot plants already tested by the UFZ, one tested pilot has already been up-scaled (Leuna I) while one is under construction (Leuna II) and three have started an up-scaling process (Kupferhammer, Schwarze Pumpe and at the Chemical industry) (Table 1). Two pilots remain under investigation for further optimization. This successful use of ecotechnologies for remediation of industrially polluted water has attracted additional interest from the industry and governmental bodies, resulting in three new pilots being planned and another three being considered.

From an economic aspect, the cost savings for Leuna I alone are expected to reach approximately 2 Mio. € within the first five years of operation thanks to very low operation and maintenance costs and requirements.

Efficient treatment and economic advantages make ecotechnologies a very competitive treatment solution for treating industrial pollution. Successful projects are attracting the attention from stakeholders and the public. The high interest in the use of ecotechnologies stresses the need for more research to investigate pollutant degradation mechanisms and degradation of reportedly “non-biodegradable” compounds.

**Table 1**

Site	Pollutant of concern	Influent concentration (mg/L)	Removal rate (%)	Pilot plant	Full scale system	Flow (m <sup>3</sup> /d)
Leuna I	BTEX	10 000 to 20 000	99.8	Closed	In operation	600
Leuna II	MTBE	1800 to 3100	82.9	Closed	Under construction	430
Kupferhammer	Alkylphenol	5000 to 16 000	99.5	Closed	Construction in 2018	60
Schwarze Pumpe	Alkylphenol	7000 to 14 000	93.8	Closed	Planned	5 000
Chemical industry	2,6-Dimethylmorpholin	500 to 8500	85.6	In operation	Planned	624
Rositz	Petroleum Derived Hydrocarbons	20 000 to 30 000		In operation (just started)		480

## References

- DVGW, 2001, DVGW, D.V.d.G.-u.W.e.V., 2001. Verordnung zur Novellierung der Trinkwasserverordnung vom 21. Mai 2001, Bonn, Germany (in German).
- van Afferden M., Rahman K., Mosig P., De Biase C., Thullner M., Oswald S., Müller R., Remediation of groundwater contaminated with MTBE and benzene: The potential of vertical-flow soil filter systems, Water Research, Volume 45, Issue 16, 15 October 2011, Pages 5063-5074, ISSN 0043-1354.

## **Cleaning up landfill leachate in rural China with low-energy gas flotation and oxidation**

**Kindler, J.<sup>1</sup>, Eckelberry, N.<sup>1</sup>**

<sup>1</sup> OriginClear, Los Angeles, California, 525 S Hewitt Street, United States

**Keywords:** landfill, leachate, wastewater, advanced oxidation, electroflotation

### **Introduction**

The aim of this work was to test the effectiveness of low-energy Electro Flotation and Advanced Oxidation to reduce contaminants present in landfill leachate from a rural northern China city landfill. The operator of this site required a solution beyond traditional treatment methods that require frequent maintenance. Goals for this demonstration were to reduce chemical oxygen demand (COD) from 10,000 mg/l to 100 mg/l and to reduce ammonia (NH<sub>4</sub>) from mid-300ppm to 8ppm. This demonstration was also an opportunity to show proof of concept of technology in a flow-through scenario and demonstrate effective treatment in real time.

A result of rain or ground water that flows through the municipal and industrial wastes in landfills, leachate is a highly contaminated and complex industrial effluent that can contaminate nearby soil, groundwater and surface water and lead to a health risk for local communities. Many governments are taking note of the hazardous of landfill leachate and are updating discharge standards – in China, the EPA has already introduced new water discharge standards.

Current technologies to clean landfill leachate lack the long-term efficiency needed to remove leachate's high contaminant load. As demand for responsible treatment of landfill leachate grows, operators require a reliable and cost-effective way to clean up this hazardous wastewater.

### **Material and Methods**

A 7-step treatment process was used to maximize contaminant removal. The flow rate was set at approximately 12 liters per minute to match the full tank capacity of the Advanced Oxidation (AOx) module and optimize efficiency. Iron(II) Sulfate Heptahydrate and sodium hydroxide were added to the influent water in the holding tank to reduce biological oxygen demand (BOD), raise the pH to 10 and ease flocculation. The influent water then entered an Electro Water Separation (EWS) flotation unit, where suspended solids were separated and clumped together using anodic reactor tubes. The wastewater then flowed through an ultrafiltration (UF) membrane to improve clarity, and through an Advanced Oxidation unit with a pH of 8.7. Hydrogen chloride (HCl) was added to the stream to bring the pH of the solution down to 6.5. Finally, the wastewater flowed through an ultrafiltration (UF) membrane to remove trace contaminants and a reverse osmosis (RO) system for final polishing.

### **Results and Discussion**

Following treatment, COD fell by 75%, Ammonia was reduced by 70% and Sulfur decreased by 65%. The black wastewater turned light brown following treatment and was clear after



passing through a final RO membrane. Onsite testing showed final ammonia levels at 8ppm and a COD under 100. Interviews with end users in China suggest that existing leachate treatment costs roughly \$10 - \$15 per m<sup>3</sup> and a cost analysis of this treatment method suggests that the total cost of this treatment ranges from \$1.27 - \$7.83 per m<sup>3</sup> of wastewater. This is an economically viable treatment solution for rural China landfill managers.

Construction engineering is currently exploring options for retrofitting existing flotation units, as well as responsive residence time and energy input combinations to enable this process to adapt to contamination load variations over long periods of time. Additional studies will also optimize module performance and address the removal of total dissolved solids (TDS) or other contaminants that may only be partially removed by this low-energy treatment.

Metric (mg/l)	Raw water	Post-EWS	% drop
COD	10,239	2,583	75
Ammonia	2,036	610	70
Sulfur	2,078	713	65

Figure 1: Lab results prior to RO treatment show a significant decrease in COD, Ammonia and Sulfur.

Further to this on-site demonstration, several test campaigns have been arranged using leachate from various sources and ages to assess this treatment system’s versatility and ability to handle influent variability. Subsequent tests were done in EWS:A0x lab cells having a batch treatment capability of 4 liters.

**EWS:A0x abatement performance (additional demonstrations)**

Description	Initial COD (mg/l)	Initial NH <sub>3</sub> mg/l	Final COD mg/l	Final NH <sub>3</sub> mg/l	% COD removal	% NH <sub>3</sub> removal
MK (China)	13,000	7,100	840	2,200	94%	69%
HK (China)	2,895	3,210*	656	11*	77%	97%*
WW (Malaysia)**	830	13	335	0	60%	100%
LG (China)	2,975	3,500	1,000	610	66%	83%
NY (China)	2,058	23	204	0.5	90%	98%
YY (China)	67,584	10,460	16,477	402	76%	96%
Average					77%	90%

\* Measured parameter is Total Nitrogen

\*\* After initial biological treatment

**References**

Schiopu, Ana-Maria, Gavrilescu, Maria. “Options for the Treatment and Management of Municipal Landfill Leachate: Common and Specific Issues.” *Clean Soil Air Water*, vol. 36, no. 12, 2010, pp. 1101-1110. Accessed 13 Mar. 2017.

# Environmental behavior of MSWI fly ash in leachate from solid waste landfill

Ref # S2SMALL-52887

X.L. Sun<sup>1,2\*</sup>, X.Y. Sun<sup>1,2</sup>, L.J. Wang<sup>1,2</sup>

<sup>1</sup> Jiangsu Key Laboratory of Chemical Pollution Control and Resources Reuse, 210094, Nanjing, China

<sup>2</sup> School of Environmental and Biological Engineering, Nanjing University of Science and Technology, 210094, Nanjing, China

\* Presenting Author: [xiaoleisun28@163.com](mailto:xiaoleisun28@163.com)

**Abstract:** According to the Chinese standard GB 16889-2008, the stabilized municipal solid waste incineration (MSWI) fly ash is allowed to be disposed in sanitary landfill when the leaching toxicity meets the relevant limits. Thus, the environmental behavior of MSWI fly ash in landfill leachate should be considered. In this study, leaching tests of MSWI fly ash, washing-pretreated MSWI fly ash and stabilized MSWI fly ash at different conditions were conducted to evaluate the stabilization of samples in landfills. The results show that the leaching concentration does not change much except at pH of 2. Leaching concentration of Zn, Pb, Cu, Cd, Cr is higher at 60°C than 25°C, and that is different for As. The leaching concentration of heavy metals from each sample increases with higher solid/liquid ratio.

**Keywords:** Heavy metal; Landfill leachate; MSWI fly ash; Washing- pretreatment

## 1 Introduction

Due to the rapid increase of generated municipal solid waste(MSW) and land shortage for landfill disposal, incineration is becoming the prior choice of many cities for MSW treatment in China because of higher degree of volume reduction, risk minimization and energy recovery from municipal solid waste incineration(MSWI)( Sabbas 2003; Quina 2008). Although incineration could significantly reduce the waste volume by approximately 85-90% and provide usable energy, it is still imperfect for MSW disposal( Galiano 2011). One of the main concerns for MSWI is the generation of potentially hazardous residues such as fly ash

for it contains heavy metals and organic pollutants(Travar 2009; Zhang 2010; Pan 2013). The weight of fly ash from MSWI is up to 2-5 wt% of the original MSW(Zheng 2011). Methods to treat MSWI fly ash are mainly classified into three groups: separation, thermal treatment, and solidification/stabilization (S/S)( Mangialardi 2003; Ferone 2013). S/S method is widely used to dispose MSWI fly ash because of its advantages of low-cost and easy to operate(Jiang 2009; Quina 2010; Colangelo 2012). The stabilized MSWI fly ash will be disposed in secure landfill sites. According to the Chinese standard GB 16889-2008, the stabilized MSWI fly ash is allowed to be disposed in sanitary landfills with MSW when the leaching toxicity of MSWI fly ash meets the relevant limits shown in Table 1. Thus, the environmental behavior of MSWI fly ash in landfill leachate should be considered.

Table 1. Leaching concentration limits for MSWI fly ash.

Pollutants	Hg	Cu	Zn	Pb	Cd	Be	Ba	Ni	As	Cr	Cr(VI)	Se
mg/L	0.05	40	100	0.25	0.15	0.02	25	0.5	0.3	4.5	1.5	0.1

\* Leaching solution: 17.25 mL HOAc diluted to 1 L, adjust pH to  $2.64 \pm 0.05$ .

\* Leaching procedure: flip oscillation for  $18 \pm 2$ h at  $30 \pm 2$ r/min and  $23 \pm 2^\circ\text{C}$  with the solid/liquid of 1kg/20L.

The purpose of this study was to investigate the leaching behavior of MSWI fly ash in landfill leachate at different conditions. Leaching tests of MSWI fly ash, washing-pretreated MSWI fly ash and stabilized MSWI fly ash at different conditions were conducted to evaluate the stabilization of samples in landfills(Dijkstra 2006; Quina 2009; Shi 2009; Komonweeraket 2015).

## 2 Material and Methods

### 2.1 Material

The MSWI fly ash and stabilized MSWI fly ash used in this study were obtained from a municipal waste incineration plant in Nanjing, China. Washing-pretreated MSWI fly ash was obtained by washing 12h at the solid/liquid(S/L) ratio of 1kg/20L. The landfill leachate used in this study was obtained from a sanitary landfill site in

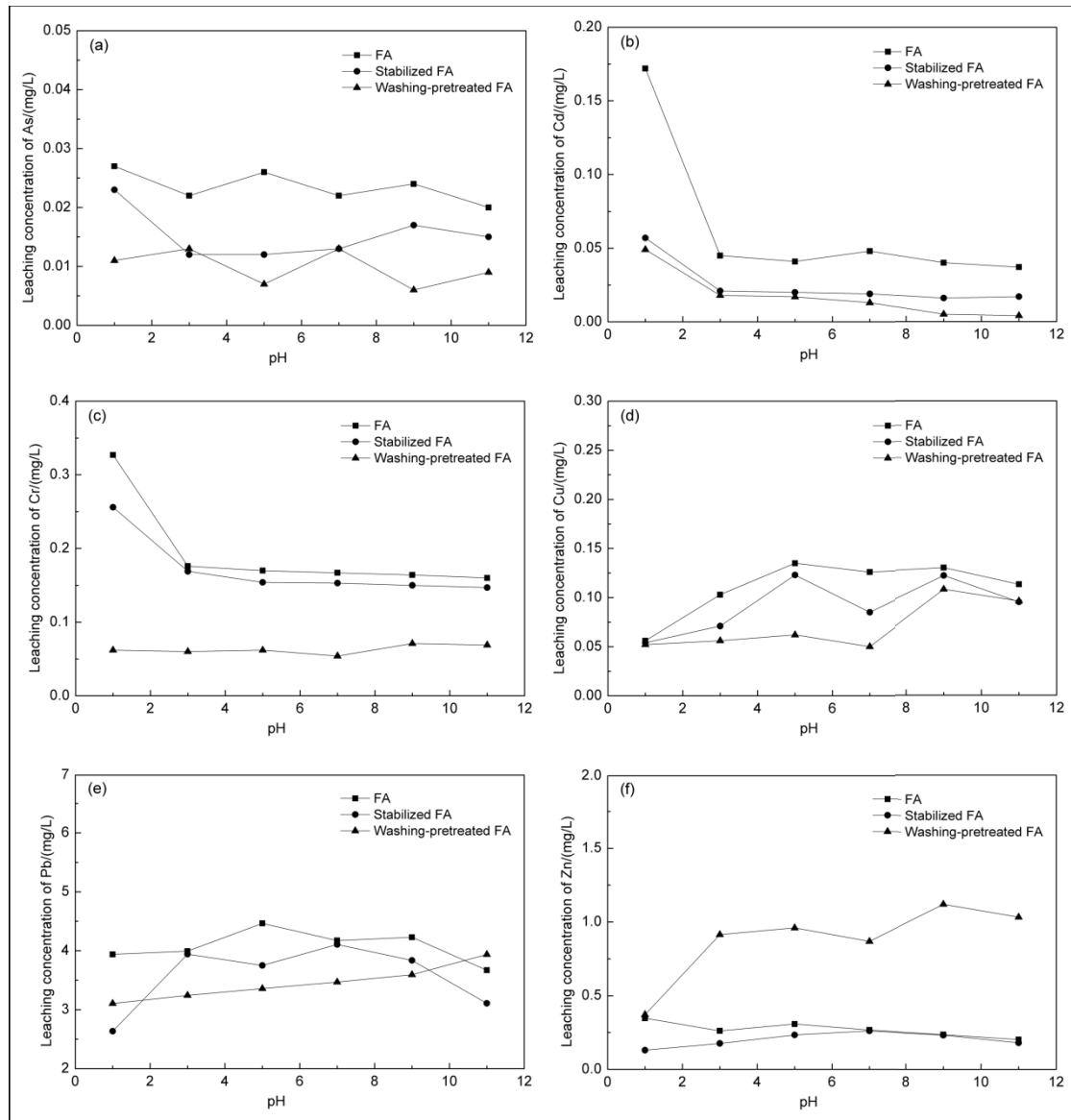
Nanjing, China.

## 2.2 Methods

Effect of pH, solid/liquid and temperature on leaching concentration experiments were carried out as following: ①MSWI fly ash mixed with liquid of different pH (1, 3, 5, 7, 9, 11) at the S/L of 1kg/20L, and then oscillated at 25°C for 24h; ②MSWI fly ash mixed with liquid at different S/L (1kg/5L, 1kg/10L, 1kg/20L), and then oscillated at 25°C for 24h; ③MSWI fly ash mixed with liquid at S/L of 1kg/20L, and then oscillated at 25°C and 60°C respectively for 24h.

## 3 Results and Discussion

### 3.1 Effect of pH on heavy metals leaching concentration from MSWI fly ash



**Figure 1. Heavy metals leaching concentration from MSWI fly ash at different pH.**

Fig. 1 shows the leaching concentration of As, Cd, Cr, Cu, Pb, Zn from MSWI fly ash at different pH. For As, leaching concentration changes little with the pH increasing, and the leaching concentration of MSWI fly ash is higher than stabilized and washing-pretreated MSWI fly ash.

For Cd, leaching concentration is much higher at pH of 1, and then changes little at pH from 3 to 11. The leaching concentration of stabilized MSWI fly ash is close to that of washing-pretreated MSWI fly ash, which is lower than that of MSWI fly ash. For Cr, leaching concentration of MSWI fly ash is similar to that of stabilized MSWI fly ash, the maximum leaching concentration occurs at pH 1. The leaching

concentration of Cr from washing-pretreated MSWI fly ash has been a low level at the whole process.

For Cu, the leaching concentrations of different MSWI fly ash at different are all below 0.15mg/L, which is much lower than the limit value 40mg/L according to the standard.

For Pb, the leaching concentration does not change obviously with the increasing pH, and varies between 2mg/L to 5mg/L, which means more concerns should be given to Pb during disposal of MSWI fly ash.

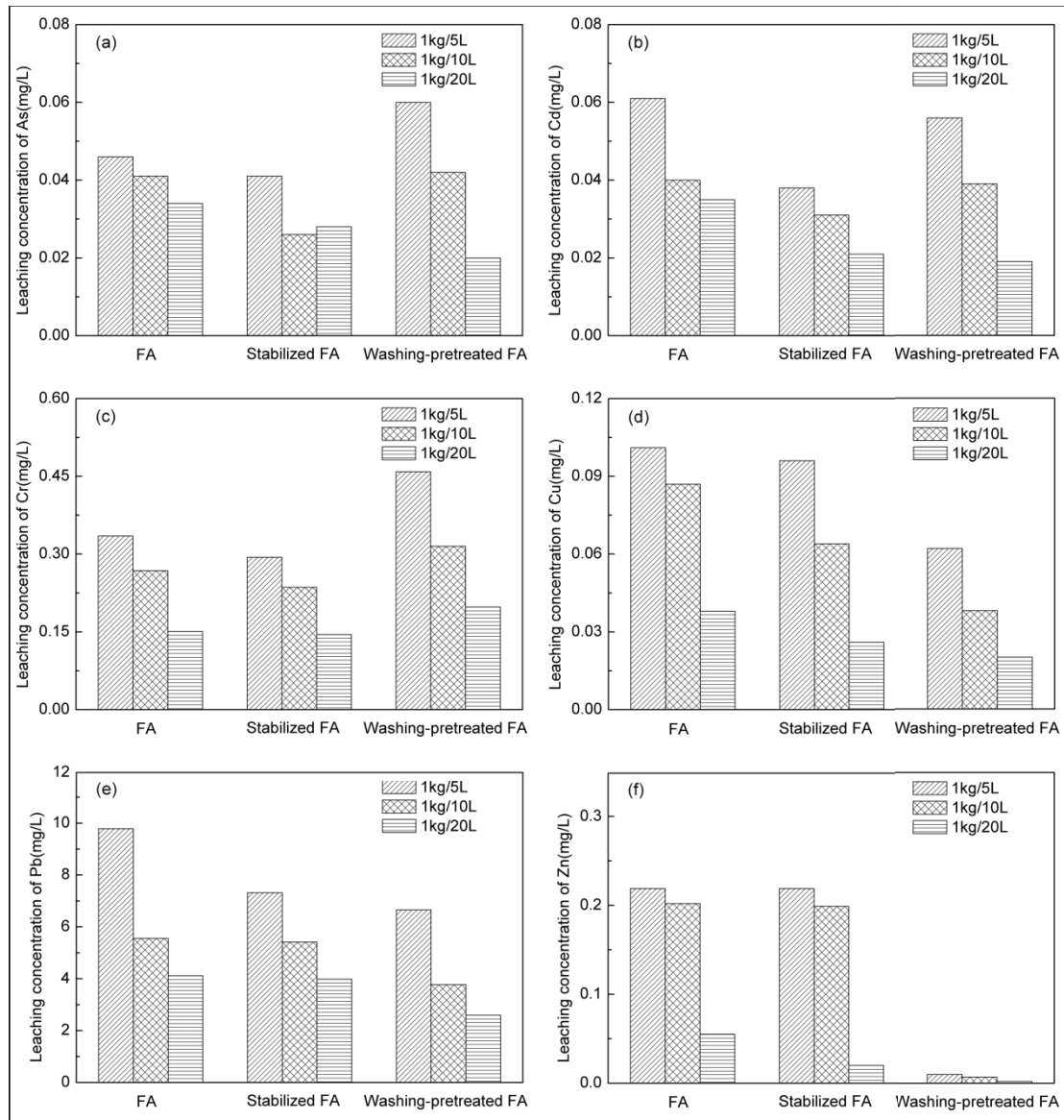
For Zn, the leaching concentration of washing-pretreated MSWI is higher than that of MSWI fly ash and stabilized MSWI fly ash.

### 3.2 Effect of S/L on heavy metals leaching concentration from MSWI fly ash

Fig. 2 shows the leaching concentration of As, Cd, Cr, Cu, Pb, Zn from MSWI fly ash at different S/L ratio. As showing in Fig. 2(a), (b) and (c), the leaching concentration of As, Cd and Cr from MSWI fly ash, stabilized MSWI fly ash and washing-pretreated MSWI fly ash does not changed so much. As shown in Fig. 2(d), (e) and (f), the leaching concentration of Cu, Pb and Zn from washing-pretreated MSWI fly ash is obviously lower than that of MSWI fly ash and stabilized MSWI fly ash.

The leaching concentration of heavy metals from different kind of MSWI fly ash exhibits the same trends when S/L ratio changes. The leaching concentration decreased when S/L ratio changes from 1kg/5L to 1kg/20L. But, the leaching concentration at S/L ratio of 1kg/5L and 1kg/10 is lower than twice and four times respectively as much as that of 1kg/20L.





**Figure 2. Heavy metals leaching concentration from MSWI fly ash at different S/L ratio.**

Fig. 3 shows the leaching concentration of As, Cd, Cr, Cu, Pb and Zn from MSWI fly ash at different temperature. As shown in Fig. 3, the leaching concentration of heavy metals increased when temperature increasing except for As. For As, Cr, Cu and Pb, the leaching concentration from different kind of MSWI fly ash changes little. For Cd and Zn, the leaching concentration of MSWI fly ash is much higher than that of stabilized MSWI fly ash and washing-pretreated MSWI fly ash.

In this study, the leaching concentration of As, Cd, Cr, Cu and Zn is lower than the limit value in Table 1. according to the Chinese standard GB 16889-2008, and the leaching concentration of Pb is much higher than the limit value.

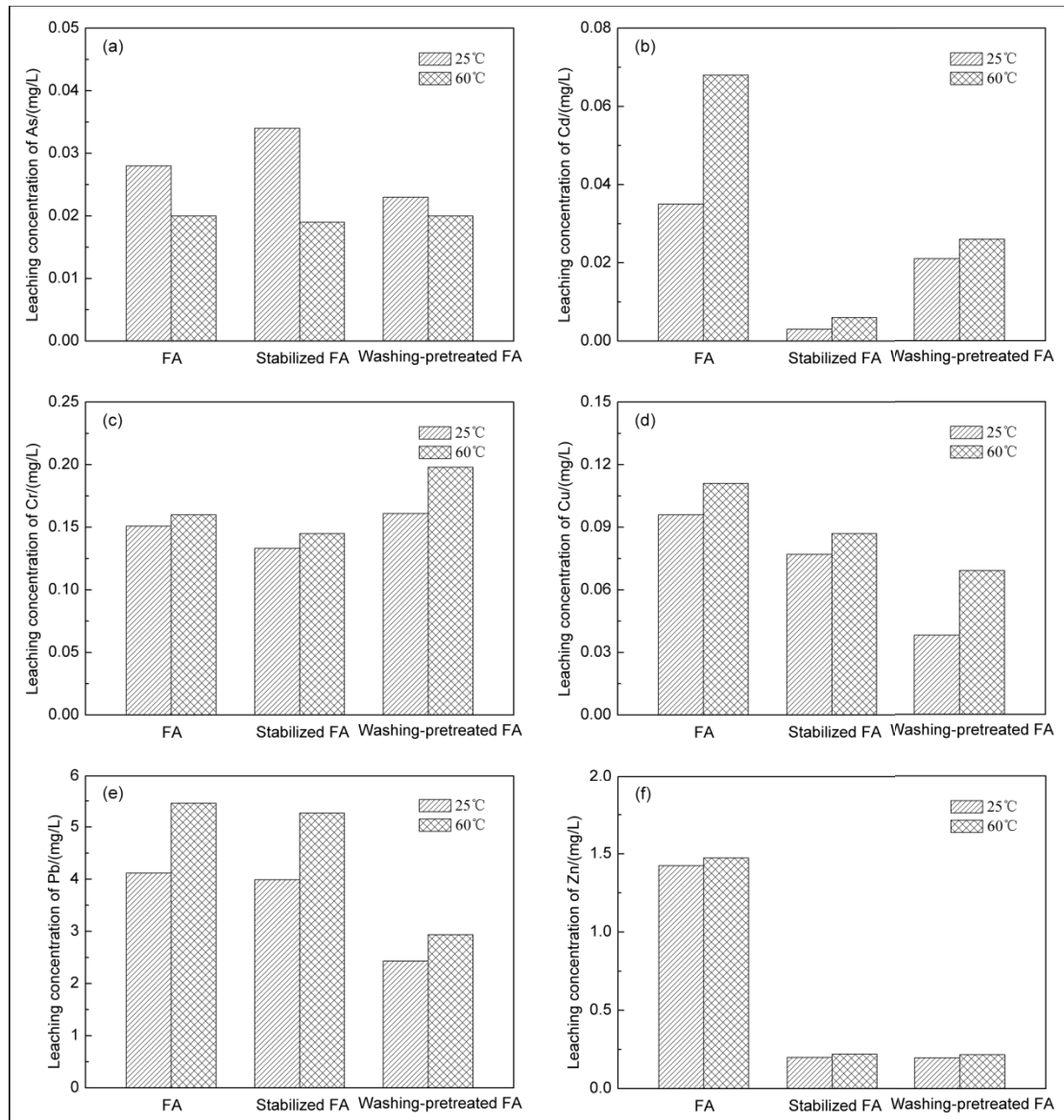


Figure 3. Heavy metals leaching concentration from MSWI fly ash at different temperature.

#### 4 Conclusions

This study investigated the effect of pH, S/L ratio and temperature on the heavy metals leaching behavior when MWSI fly ash disposed in landfill leachate. The results show that: ①the leaching concentration does not change much except at pH of 2; ②the leaching concentration decreased with S/L ratio decreasing; ③the leaching concentration increased with temperature increasing except for As; ④the leaching concentration of heavy metals lower than the relevant limit value except Pb. Therefore, further study and concern should focus on the stabilization of Pb.

#### References

- [1] Colangelo F, Cioffi R, Montagnaro F, Santoro L. 2012 Soluble salt removal from MSWI fly ash and its stabilization for safer disposal and recovery as road basement material[J]. *Waste Management*, 32(6): 1179-1185.
- [2] Dijkstra J. J., van der Sloot H. A., Comans R. N. J.. 2006 The leaching of major and trace elements from MSWI bottom ash as a function of pH and time[J]. *Applied Geochemistry*, 21(2): 335-351.
- [3] Ferone C., Colangelo F., Messina F., Santoro L., Cioffi R. 2013 Recycling of pre-washed municipal solid waste incinerator fly ash in the manufacturing of low temperature setting geopolymer materials[J]. *Materials*, 6(8): 3420-3437.
- [4] Galiano Y. L., Pereira C. F., Vale J. 2011 Stabilization/solidification of a municipal solid waste incineration residue using fly ash-based geopolymers[J]. *Journal of hazardous materials*, 185(1): 373-381.
- [5] Jiang J., Chen M., Zhang Y., Xu X. 2009 Pb stabilization in fresh fly ash from municipal solid waste incinerator using accelerated carbonation technology[J]. *Journal of hazardous materials*, 161(2): 1046-1051.
- [6] Komonweeraket K., Cetin B., Aydilek A. H., Aydilek A. H., Benson C. H., Edil T. B. 2015 Effects of pH on the leaching mechanisms of elements from fly ash mixed soils[J]. *Fuel*, 140: 788-802.
- [7] Mangialardi T. 2003 Disposal of MSWI fly ash through a combined washing-immobilisation process[J]. *Journal of Hazardous Materials*, 98(1): 225-240.
- [8] Pan Y., Wu Z., Zhou J., Zhao J., Ruan X., Liu J., Qian G. 2013 Chemical characteristics and risk assessment of typical municipal solid waste incineration (MSWI) fly ash in China[J]. *Journal of hazardous materials*, 261: 269-276.
- [9] Quina M. J., Bordado J. C., Quinta-Ferreira R. M.. 2008 Treatment and use of air pollution control residues from MSW incineration: an overview[J]. *Waste Management*, 28(11): 2097-2121.
- [10] Quina M. J., Bordado J. C. M., Quinta-Ferreira R. M.. 2009 The influence of pH on the leaching behaviour of inorganic components from municipal solid waste APC residues[J]. *Waste Management*, 29(9): 2483-2493.
- [11] Quina M. J., Bordado J. C. M., Quinta-Ferreira R. M. 2010 Chemical

stabilization of air pollution control residues from municipal solid waste incineration[J]. *Journal of hazardous materials*, 179(1): 382-392.

[12] Sabbas T., Poletini A., Pomi R., Astrup T., Hjelmar O., Mostbauer P., Cappai G., Magel G., Salhofer S., Speiser C., Heuss-Assbichler S., Klein R., Lechner P. 2003 Management of municipal solid waste incineration residues[J]. *Waste management*, 23(1): 61-88.

[13] Shi H. S., Kan L. L. 2009 Leaching behavior of heavy metals from municipal solid wastes incineration (MSWI) fly ash used in concrete[J]. *Journal of hazardous materials*, 164(2): 750-754.

[14] *Standard for Pollution Control of Domestic Refuse Landfill* 2008, Ministry of Environmental Protection, Beijing, China.

[15] Travar I., Lidelöw S., Andreas L., Tham G., Lagerkvist A. 2009 Assessing the environmental impact of ashes used in a landfill cover construction[J]. *Waste Management*, 29(4): 1336-1346.

[16] Zhang H., Zhao Y., Qi J. 2010 Characterization of heavy metals in fly ash from municipal solid waste incinerators in Shanghai[J]. *Process Safety and Environmental Protection*, 88(2): 114-124.

[17] Zheng L., Wang C., Wang W., Shi Y., Gao X.. 2011 Immobilization of MSWI fly ash through geopolymerization: effects of water-wash[J]. *Waste Management*, 31(2): 311-317.

# Performance of a vertical flow soil filter treating industrial wastewater under cold climatic conditions and avoiding filter clogging problems

Rahman, K.Z.<sup>1</sup>, van Afferden, M.<sup>1</sup>, Mosig, P.<sup>1</sup>, Müller, R.A.<sup>1</sup>

<sup>1</sup> Centre for Environmental Biotechnology (UBZ), Helmholtz Centre for Environmental Research - UFZ, Permoserstrasse 15, 04318 Leipzig, Germany

**Keywords:** Cold climate, groundwater remediation, ion precipitation, vertical-flow soil filter

## Introduction

In the following study we investigated the effectiveness of a vertical-flow soil filter (VFSF) system to prevent clogging problems due to precipitation of ions ( $\text{Fe}^{2+}$ ,  $\text{Mn}^{2+}$  and  $\text{Ca}^{2+}$ ) and to assess the influence of different HLRs on the effectiveness of the VFSFs treating industrial wastewater under cold climatic conditions with low ambient air temperatures.

Highly efficient biological degradation of MTBE and BTEX has already been investigated in a VFSF treating contaminated groundwater (van Afferden et al. 2011). However, issues of filter clogging due to several ion precipitations and freezing in winter temperatures still remain. Under extended period of cold climate with ambient air temperatures reaching well below freezing, the effect of cold winter temperatures on microbial degradation are crucial for constructed wetland performance (Seeger et al., 2011). Low temperatures are not only affecting the pollutant removal in constructed wetlands but can also cause the packing layer to freeze, result in pipes breaking (Wallace et al., 2001) and many other adverse consequences.

## Material and Methods

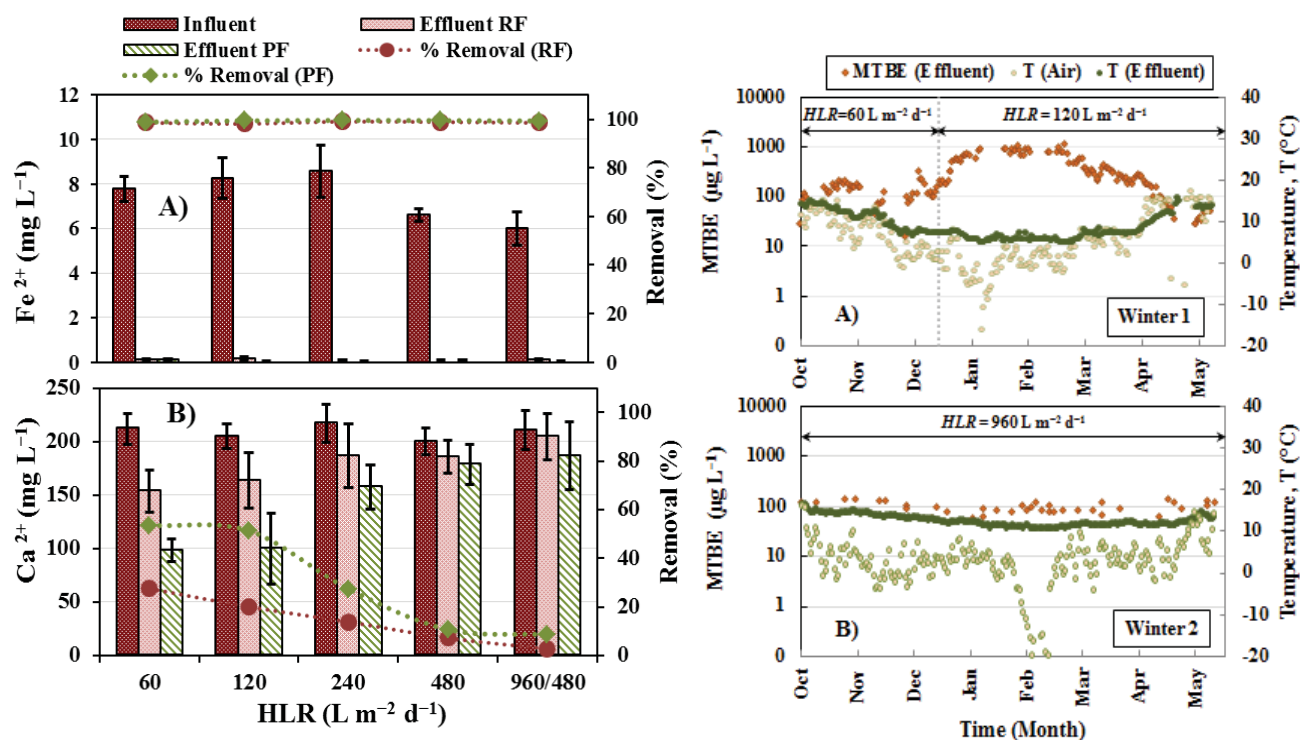
Two technical-scale VFSFs, the Roughing Filter (RF) and Polishing Filter (PF), were used and operated in two-stage in this study. Both filters were filled with granular materials of different grain sizes and arranged in layers of varying configurations. The filters were operated outdoors at the site, with their surface exposed to the local climatic conditions. Industrial wastewater contaminated with MTBE and benzene was injected intermittently to the top of the first filter (RF) at a mean HLR of  $960 \text{ L m}^{-2} \text{ d}^{-1}$  and the effluent of the RF was then pumped into the second treatment step (PF) at a HLR of  $480 \text{ L m}^{-2} \text{ d}^{-1}$ . This intermittent dosing of water was chosen to provide good oxygen transfer to the water phase (Tilley, 2014). This experiment was conducted in a way that at least two winter seasons can be compared under different HLRs within the filters.

## Results and Discussion

The main results showed: (i) during two-stage operation, a highly efficient  $\text{Fe}^{2+}$  removal with a mean removal efficiency of 99% was already observed in the effluent of the first treatment step (Figure 1) and protected the second filter from potential clogging due to iron hydroxide



precipitates, (ii) with a high HLR in the RF resulted in only 3% removal of the mean  $\text{Ca}^{2+}$  inflow concentration ( $211 \pm 18 \text{ mg L}^{-1}$ ). This clearly showed that at high HLR,  $\text{Ca}^{2+}$  was rapidly flushing out of the VFSF system instead of carbonate precipitations and proved to be very effective to protect the filter from potential clogging., (iii) during winter, when daily mean outside air temperature was as low as  $-20^\circ\text{C}$  (Figure 1), a relatively low water temperature in the range of  $5.1\text{--}8^\circ\text{C}$  in the effluent and a low MTBE and benzene mean removal rate of  $0.41 \pm 0.07$  and  $2.08 \pm 0.33 \text{ g m}^{-2} \text{ d}^{-1}$ , respectively, was observed at a low HLR ( $120 \text{ L m}^{-2} \text{ d}^{-1}$ ); whereas, at a high HLR ( $960 \text{ L m}^{-2} \text{ d}^{-1}$ ), a mean temperature of  $13.0 \pm 1.3^\circ\text{C}$  was maintained inside the filter resulting in a high MTBE and benzene removal rate. Results suggest that a two-stage VFSF can be a promising technology for the remediation of heavily contaminated groundwater or industrial wastewater in oil and gas industries.



**Figure 1.** Mean influent and effluent concentration of different ions and their removal and dynamics of MTBE and water temperature in the effluent under different HLRs during A) winter 1 and B) winter 2

## References

- Seeger, E.M., Kusch, P., Fazekas, H., Grathwohl, P., Kaestner, M., 2011. Bioremediation of benzene-, MTBE- and ammonia-contaminated groundwater with pilot-scale constructed wetlands. *Environ. Poll.* 159 (12), 3769-3776.
- Tilley, E., Ulrich, L., Luethi, C., Reymond, P., Zurbrugg, C., 2014. *Compendium of Sanitation Systems and Technologies*. 2nd Revised Edition. EAWAG, Duebendorf, Switzerland.
- van Afferden, M., Rahman, K.Z., Mosig, P., De Biase, C., Thullner, M., Oswald, S.E., Müller, R.A., 2011. Remediation of groundwater contaminated with MTBE and benzene: The potential of vertical-flow soil filter systems. *Water Res.* 45, 5063-5074.
- Wallace, S., Parkin, G., Cross, C., 2001. Cold climate wetlands: design and performance. *Water Sci. Technol.* 44, 259-265.

# Treatment performances and operating experiences of the first full-scale Discfilter facility featuring enhanced phosphorus removal from pure-MBBR effluent

Ref # S2SMALL-35720

P. Kängsepp<sup>1\*\*</sup>, M. Sjölin<sup>1\*</sup>, A. G. Mutlu<sup>1</sup>, B. Teil<sup>2</sup>, C. Pellicer-Nàcher<sup>1</sup>

<sup>1</sup> Veolia Water Technologies AB (Hydrotech), Mejselgatan 6, 23532 Vellinge, Sweden

<sup>2</sup> Bureau d'Etudes Technique, VEOLIA Eau - Centre Régional Arc Alpin Jura, Alpespace - Hôtel d'entreprise Jorasses, 218 voie Aristide Bergès, 73800 Ste Hélène du Lac

\* Presenting Author: gizem.mutlu@veolia.com

\*\* Corresponding Author: pille.kangsepp@hydrotech.se

**Abstract:** The suspended solids (SS) concentration in the effluent of Moving Bed Biofilm Reactors (MBBR) used for secondary biological treatment (pure-MBBR) can be up to 500 mg/L. Several pilot-studies have shown that microscreens (with 40 micron) in conjunction with 2-stage chemical pre-treatment, can provide total phosphorus (TP) removal through precipitation (80-90 %), and SS removal (80-99 %) in the MBBR effluents depending on influent concentration, chemical dosage and requirements on the effluent discharge.

The present study shows that a small-scale municipal WWTP (5,700 Population Equivalents, PE) can be upgraded (to 12,000 PE) by combining MBBR process (with about 140 m<sup>2</sup> footprint) with coagulation-flocculation tanks and Discfilter (with about 20 m<sup>2</sup> footprint) to cover the current and future treatment needs. This compact treatment system can provide reduction of turbidity from 290 to 9.6 NTU, suspended solids (SS) from 120 to 11 mg/L, ammonium (NH<sub>4</sub>-N) from 19 to 0.04 mg-N/L, chemical oxygen demand (COD) from 120 to 11 mg/L, and TP from 4.5 to 0.3 mg/L. Overall, the results show that yearly effluent demands can be complied with combining pure-MBBR-coagulation-flocculation-Discfilter process at full-scale.

**Keywords:** flocculation, coagulation, Discfilter, Moving-Bed Biofilm Reactors (MBBR), phosphorus removal, suspended solids

## INTRODUCTION

The Moving-Bed Biofilm Reactor (MBBR) process is a well-known and proven technology, which has been used extensively for nitrogen and carbon removal (Ødegaard et al. 1994; Rusten and Ødegaard 2007, Ødegaard et al. 2010). Suspended solids (SS) removal downstream of MBBR by microscreens with woven media (either Disc- or Drumfilters) has been studied and commercialized for more than 10 years (Persson et al. 2006, Mattsson et al. 2009, Wilén et al. 2012, Gustavsson & Cimbritz, 2013, Rossi et al. 2013).

SS concentrations from an MBBR-process designed for removal of Biological Oxygen Demand (BOD) are typically in the range of 100-250 mg/L (Ødegaard et al. 2010) and in some cases even up to 500 mg/L (Rossi et al. 2013). Therefore, chemical pre-treatment (flocculation alone or in a combination with coagulation) upstream of Disc and Drumfilters with 40 micron pore openings are needed to fulfil the effluent discharge requirements. Advantages of combining flocculation step with microscreen, include increased filtration flux and decreased filtration area, reducing both investment cost and footprint of equipment, compared to filtration without chemical pre-treatment. A coagulation step is required prior to flocculation, when chemical phosphorus precipitation is targeted. The coagulation-flocculation-filtration process is also considered, when there are stricter discharge requirements for the effluent SS concentrations.

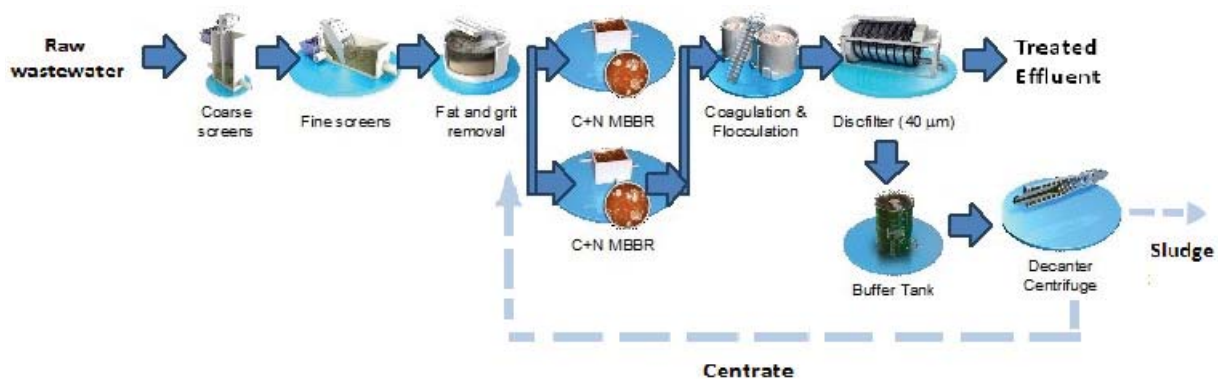


Optimal dosages in total phosphorus (TP) removal applications are crucial to create sufficiently strong flocs that can be retained by the Discfilter sieving process (Väänänen 2017). Variable characteristics of wastewater (e.g. chemical composition of influent, particle characteristics, and size distribution) affect the optimum chemical dosage. Overdosing of coagulant and polymer can impair significantly the filtration fluxes of the installation and lead to unnecessary increase of the operational cost. Therefore, careful design of the dispersion and mixing in coagulation and flocculation stages combined with precise process control are necessary, especially when low TP concentrations need to be reached (Väänänen 2017).

Even though many pilot-scale studies have been carried out to gather comprehensive return of experience for this process combination, it is also important to show that long-term year-around operation is successful. This case study illustrates how the small-scale WWTP of Taninges, built for 5,700 population equivalents (PE) in 1973, has been upgraded in 2015 up to 12,000 PE with a pure-MBBR followed by 2-stage chemical pre-treatment with disc filtration to achieve  $<2$  mg-TP/L in the effluent. The aim of this work was to follow up the operation of this installation to improve process knowledge about the particle separation and TP removal efficiencies downstream pure-MBBR.

## MATERIAL AND METHODS

The Taninges WWTP is located 2 km away from Taninges, very close to popular ski-resorts south-east of France. During upgrading of the WWTP, the existing activated sludge process (AS) was replaced by pure-MBBR process (Figure 1), consisting of 2 lines with 2 reactors each in series. Carbon removal takes place in the first reactor of  $193\text{ m}^3$  (60% filled with AnoxKaldnes K5™ carriers) and nitrification occurs in the second reactor of  $285\text{ m}^3$  (50% filled with AnoxKaldnes K5™ carriers). The MBBR filling degrees correspond to the load from 12,000 PE, with possibility to increase up to 17,000 PE, if required. The MBBR is followed by a 2-stage chemical pre-treatment for TP precipitation and Discfilter (HSF2212/11-2F, Veolia Water Technologies AB, Sweden) with 40 micron filter panels. The Discfilter has 11 vertically mounted discs and features the possibility of adding one more disc to increase the plant's capacity. The Discfilter installation was dimensioned for a maximum flow of  $280\text{ m}^3/\text{h}$ . A part of the effluent is reused for backwashing the filter panels at a pressure of 0.8 MPa without interrupting the wastewater treatment process. The sludge generated while backwashing is directed to a buffer tank and thereafter dewatered in a decanter centrifuge. The centrate from the centrifuge is occasionally pumped back to the upstream of MBBR.



**Figure 1.** Schematic layout of Taninges wastewater treatment plant.

At start-up of the full-scale plant, 3.7 mg Al<sup>3+</sup>/L (PAX-18, Kemira Ltd., Finland) and 3 mg/L cationic emulsion polymer (Hydrex 6631, Veolia Water Technologies, France) were considered as the suitable doses and types of chemicals for coagulation and flocculation. After the plant was brought to operation, further adjustment of the dosing was conducted by bench scale jar-test equipment (Flocculator 2000, Kemira Kemi AB., Sweden) and Hydrotech's Test tube (Veolia Water Technologies AB, Sweden). Effluent concentrations between 1-1.5 mg-TP/L were targeted, even though the discharge requirement was  $\leq 2$  mg-TP/L. Throughout the 3 monitoring periods described here, the dosage of Al-based coagulant was changed between 3.7 and 5.5 mg Al<sup>3+</sup>/L, based on the results from jar tests. The dose of the cationic polymer was changed from 3.0 to 1.9 mg/L in the beginning of the follow-up study and remained so during the rest of the time.

Continuous operation, covering daily and seasonal variations, was monitored by online instruments on a daily basis with measurement frequency of 5 min from December 2016 to May 2017. Optical probes for turbidity measurements (Solitax SC, Hach Lange GmbH, Germany), together with a TP analyser (Phosphax Sigma, Hach Lange GmbH, Germany) were connected to a metering unit (SC1000, Hach Lange GmbH, Germany) for online monitoring of SS and dissolved phosphorus (orthophosphate, PO<sub>4</sub><sup>3-</sup>, HPO<sub>4</sub><sup>2-</sup>) in the influent and effluent of the Discfilter.

Additionally, hourly composite samples were collected with two autosamplers (AS950, Hach Lange GmbH, Germany) from the MBBR effluent (before coagulant dosing point) and the Discfilter during 3 days in December 2016, April 2017, and May 2017. Grab sampling was carried out in parallel to the online measurement campaign (Table 1).

**Table 1.** Operational conditions and sampling during investigation periods.

Duration of tests	Aim of the study	Al <sup>3+</sup> dosing (mg Al <sup>3+</sup> /L)	Polymer dosing (mg/L)	Sample type	Number/frequency of samples
Dec 2016 (3 days)	Evaluate and optimise chemical dosings and its effect on particle and TP separation by Discfilter	3.7 – 4.0	3.0 – 1.9	Hourly composite samples	41
Dec 2016-April 2017	Evaluation of long-term continuous operation of Discfilter with 2-stage pre-treatment	4.0 – 5.5	1.9	On-line measurement	Every 5 min
April 2017 (3 days)	Evaluate the chemical dosing and its effect on particle and TP separation by Discfilter	4.7 – 5.5	1.9	Hourly composite samples	45
April – May 2017	Evaluation of long-term continuous operation of Discfilter with 2-stage pre-treatment	5.0	1.9	On-line measurement	Every 5 min
May 2017 (3 days)	Evaluate MBBR and Discfilter performance	5.0	1.9	Hourly composite samples & Grab samples	9
May – June 2017	Evaluation of long-term continuous operation of Discfilter with 2-stage pre-treatment	5.0	1.9	On-line measurement every 5 min	Every 5 min

Online meters were regularly calibrated via lab measurements. The SS content was determined according to DIN 38404/DIN EN 872:2005/Standard methods 2005. Cuvette tests LCK348, LCK349 and LCK 350 (Hach Lange GmbH, Germany) were used for TP

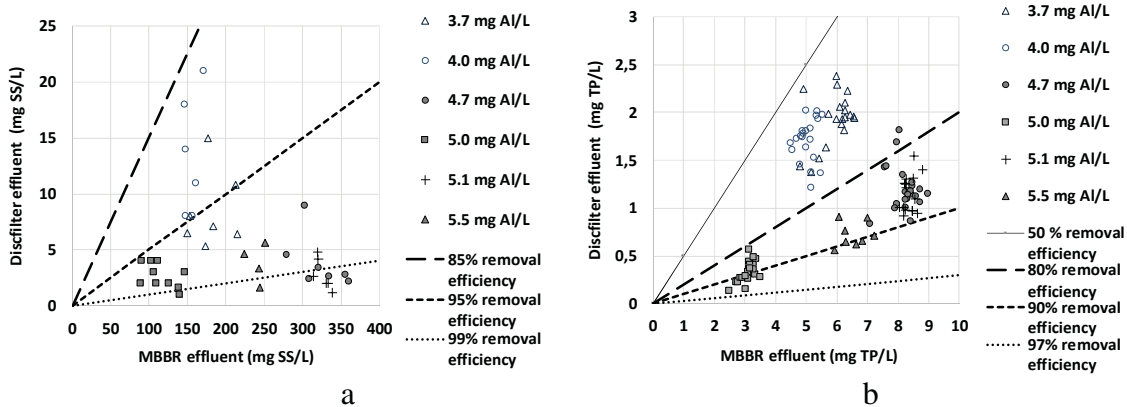
measurements. Turbidity was manually measured in grab samples with a Turbidity meter (2100P, Hach Lange GmbH, Germany). Cuvette tests (Hach Lange GmbH, Germany) LCK303 and LCK304 were used to measure ammonium ( $\text{NH}_4\text{-N}$ ), LCK238 for total-nitrogen (TN), LCK114 and LCK314 for chemical oxygen demand (COD) in the composite samples.

## RESULTS AND DISCUSSION

### Impact of coagulant dosing in coagulation-flocculation step before Discfilter

The removal of P from wastewater involves the precipitation of phosphate as SS and the subsequent removal of those solids (Tchobanoglous et al. 2003). Typically, the post-MBBR SS concentration in feeding to the solids separation unit is around 150-250 mg SS/L when municipal sewage is treated (van Haandel & van der Lubbe 2012). At Taninges WWTP, the daily average SS concentrations in the MBBR effluent varied between 90 and 360 mg SS/L (Figure 2a). In spite of the high influent SS concentrations to solid separation, SS concentration below 10 mg/l could be reached consistently using chemical pre-treatment (with  $\text{Al}^{3+}$  dose of 4.7-5.5 mg/L and with 1.9 mg/L polymer addition) and Discfilter with 40 microns. The required  $\text{Al}^{3+}$  dose is in the same range as in settling/flotation combined with processes, where SS in effluent is expected to be around 10-15 mg SS/L (van Haandel & van der Lubbe 2012).

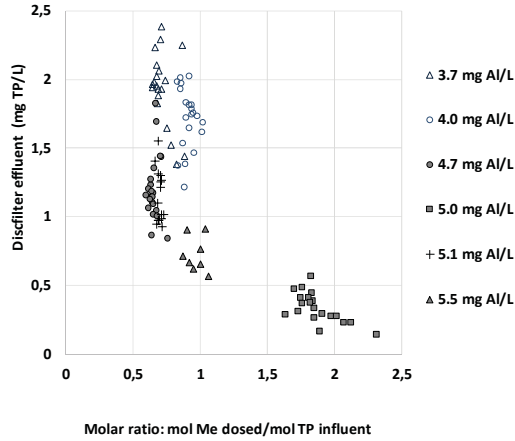
The removal efficiencies for TP were between 50 and 97 % (Figure 2b), depending on the amount of  $\text{Al}^{3+}$  dosed and TP concentrations in the influent. The effluent TP values were below 2 mg/L, with  $\text{Al}^{3+}$  doses above 4.7 mg  $\text{Al}^{3+}$ /L for TP concentrations of up to 9 mg/L in the MBBR effluent.



**Figure 2.** Concentrations of SS (a) and TP (b) in the influent and effluent of coagulation-flocculation-Discfilter process (at different  $\text{Al}^{3+}$  doses and 1.9 mg/L polymer addition).

TP concentration in the effluent from MBBR (influent to coagulation-flocculation-Discfilter process) varied in a large range, between 3 and 9 mg-TP/L. Required molar ratios of  $\text{Al}^{3+}$  dosed/TP in influent were between 0.7-2.3 to achieve <2 mg-TP/L in the filtrate (Figure 3). Previous studies indicate that a molar ratio of 5-7 mol  $\text{Me}^{3+}$ /mol influent TP was sufficient to consistently achieve <0.1 mg-TP/L in the effluent of a plant combining a 2-stage chemical pre-treatment and Discfilter (Väänänen 2014, 2017). The molar ratios presented by Väänänen were higher, as the tests were performed on a different wastewater application with a lower TP influent concentration range. Higher dose of coagulant was required in order to remove sufficient amount of TP and to achieve effluent concentrations below 0.1 mg-TP/L. The

coagulant doses in this study are also lower than what was used by Väänänen et al. (2016) in primary treatment (5-20 mg Al<sup>3+</sup>/L or 10-30 mg Fe<sup>3+</sup>/L), where <0.3 mg-TP/L in the effluent was targeted. In conclusion, exact molar ratios of dosed coagulant to soluble phosphorus in the effluent vary for different applications, depending on the TP concentration in effluent that needs to be obtained and on the amount of phosphorus that is in soluble form.

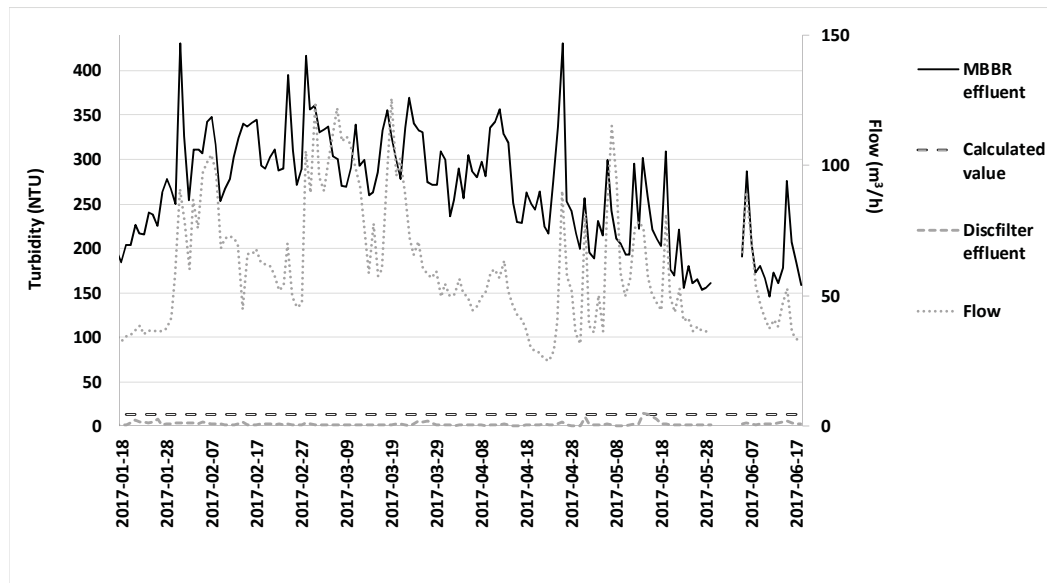


**Figure 3.** Effluent TP concentration achieved versus molar ratios of metal dosed/TP in influent.

In order to combine coagulation and flocculation with microscreen, polymer doses of 1-5 mg polymer/L can be required for primary and 0.5-1.5 mg polymer/L tertiary treatment (Väänänen, 2017). The dose of 1.9 mg/L emulsion added in this study would correspond to about 0.9 mg/L polymer dose.

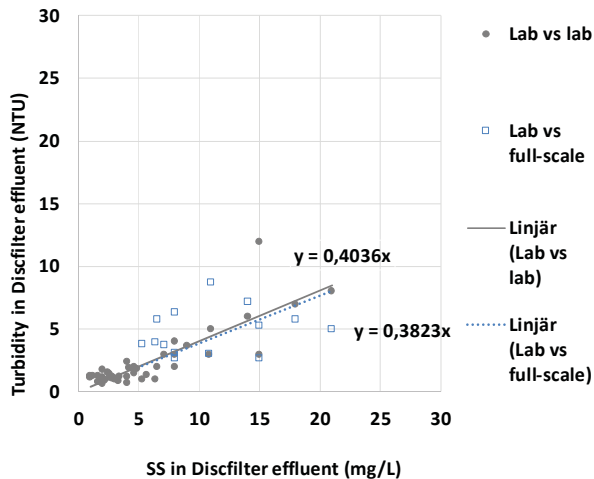
**Evaluation of long term performance**

Actual hourly average flow during the 5 months was 61 m<sup>3</sup>/h, which is much lower than the design flow (280 m<sup>3</sup>/h). The on-line measurements of flow indicate significant daily variations and that flows peak up to 125 m<sup>3</sup>/h (Figure 4).



**Figure 4.** Online measurements of turbidity and flow.

Online turbidity measurements (Figure 4) showed that variations of daily average influent turbidity values between 146 and 431 NTU did not affect the daily effluent turbidity values, which remained between 0.6 and 10 NTU. This would correspond to SS concentrations between 1.5 and 25 mg SS/L by using a converting factor of 1/0.39 (obtained by comparing the laboratory and on-line measurements of turbidity and SS in the effluent, Figure 5). All turbidity values in the effluent (except during 1 day) were under the required effluent limit value of 35 mg SS/L (corresponding to 13.8 NTU).



**Figure 5.** Comparison of laboratory and on-line measurements of turbidity (NTU) and SS (mg/L) values.

On-line measurements often point out that peaks of turbidity and flow occur the same day (Figure 4). SS loading to the Discfilter was between 20 and 300 g SS/m<sup>2</sup>/h, which yielded an backwash time during the monitoring period of about 12% (with 95%-tile of 35%). The loading and backwash values indicate that full capacity of Discfilter was not utilized during the monitoring period. This might be due to the fact that the daily-averaged wastewater flow to the plant was much lower than the peak design flow. The unit is sized to deal with the maximum instantaneous flow in order to give the plant the opportunity to treat all wet weather flow and seasonal high loading events.

The total solids (TS) content in the sludge from Discfilter varied between 4.0 and 6.8 g/L. The sludge is dewatered to 19-25% TS by the centrifuge. The centrate from the centrifuge is pumped back when required upstream of the MBBR and represents about 8% of total influent flow. The concentrations of SS and TP in the centrate were between 0.3 and 1.8 g SS/L, and 4-13 mg-TP/L and would contribute little to the MBBR load.

### Evaluation of overall WWTP performance

Results from sampling period in May (Table 2) show that average reductions of 97% of COD, 99.8% of NH<sub>4</sub>-N and 99% of turbidity were achieved by the plant. TN removal was on average 43% and nitrogen leaves the WWTP mainly as NO<sub>3</sub>-N (plant is not sized for denitrification).

### Assessment of treatment method

The MBBR process combined with coagulation-flocculation-filtration has a total footprint of about 160 m<sup>2</sup>. Microscreens can be delivered with their own stainless-steel tank, which together with the reduced footprint, reduce significantly the construction costs with respect to other technologies.

**Table 2.** Treatment performance of MBBR coupled with 2-stage chemical pre-treatment and Discfilter (Average±standard deviation)

Parameter	Influent to MBBR (mg/L)	Effluent from MBBR (mg/L)	Effluent from Discfilter (mg/L)	Min and max removal efficiencies by plant (%)	Requirements on effluent (mg/L)	Required removal efficiencies (%)
COD	290 (±81)	116 (±14)	9.6 (±1.7)	96,6-98	125	80
NH <sub>4</sub> -N	19 (±6)	0.06 (±0.05)	0.04 (±0.01)	99,7-99,9	3.1	94
TN	54 (±17)	41 (±9)	28 (±7)	17-72	14	82
TP	4.5 (±1.6)	2.9 (±0.2)	0.3 (±0.1)	88-92	2	
SS	120 (±33)	103 (±9.6)	11 (±16)	61-100	35	90
Turbidity	79 (±31)*	103 (±10)*	1 (±0.2)*	97-99	-	-

\*Turbidity values are in NTU, not mg/L

**Table 3.** Amount of chemicals used in conjunction with chemical pre-treatment prior to the Discfilters and cost estimations

	Dosage (mg/L)	Consumption* (kg/year)	Annual cost (EUR/year)	Cost of treated water (EUR/m <sup>3</sup> )
Coagulant**	5	29,500	21,000	0.039
Flocculation aid**	1.9	1,000	1,700	0.003
<b>Total</b>			<b>22,700</b>	<b>0.042</b>

\*At 5-month daily average flow of 61 m<sup>3</sup>/h

\*\*Estimated Cost of PAX-18 is 0.7 EUR/kg and Polymer 1.7 EUR/kg wastewater

Estimated cost for chemical pre-treatment in conjunction with Discfilter is about 0.042 EUR/m<sup>3</sup> of treated wastewater (Table 3). Since dosing of coagulant and flocculent has been flow proportional, the actual annual cost of chemical pre-treatment can fluctuate around 22.7 kEUR due to the variation between the actual and design average flow. Van Haandel & van der Lubbe (2012) stated that since MBBR biomass are not very favourable for settling and since in most countries phosphate removal is required, cost of chemicals for pre-treatment needs to be included within operational cost even for other separation techniques e.g. gravity settling. If, for example, a load-proportional feed forward dosing or feedback control (as presented by Väänänen, 2017) could be applied instead of the flow-proportional dosing, annual chemical consumption would be reduced and the process at the studied plant would be optimized even further.

## CONCLUSIONS

The presented study shows that a small-scale WWTP (for 5,700 PE) can be upgraded (up to 12,000 PE) by combining MBBR with a coagulation-flocculation-Discfilter process to cover the current and future treatment needs. This very compact treatment system can provide a very good reduction of turbidity, SS, NH<sub>4</sub>-N and COD and fulfil the discharge limits of 2 mg-TP/L.



## References

- Gustavsson D. J. I. & Cimbritz M. 2013 Biomass separation following an MBBR for post-denitrification – assessment of microscreening. The Nordic Wastewater Conference (NORDIWA 2013), Oct 8-10. Malmö, Sweden.
- Mattsson A., Ljunggren M., Fredriksson O. & Persson E. 2009 Particle Size Analysis used for Design of Large Scale Tertiary Treatment Microscreen. In: *Proceedings of 2nd IWA Specialised Conference on Nutrient Management in Wastewater Treatment Processes*. 6-9 September, Krakow, Poland.
- Ødegaard H., Rusten B. & Westrum T. 1994 A new MBBR - applications and results. *Water Science and Technology*, **29**, 157-165.
- Ødegaard H., Cimbritz M., Christensson M. & Dahl C. P. 2010 Separation of biomass from moving bed biofilm reactors (MBBRs). Conference Proceedings WEF/IWA Biofilm Reactor Technology Conference, Portland, Oregon, USA, August 15.-18., 2010.
- Persson E., Ljunggren M., la Cour Jansen J., Strube R. & Jönsson L. 2006 Disc filtration for separation of flocs from a moving-bed biofilm reactor. *Water Science Technology*, **53**(12), 139-147.
- Rossi C., le Vaillant E., Strube R., Morän J., Nussbaum B., Skult F. & Stewart M. 2013 Using Microscreens as Clarification Technology Downstream of a Moving Bed Biofilm Reactor (MBBR). Proc. Water Environ. Fed. 2013, 3970–3986.
- Rusten B. & Ødegaard H. 2007 Design and operation of nutrient removal plants for very low effluent concentrations. Proc. Water Environ. Fed. 2007, 1307–1331.
- Wilén, B.-M., Johansen, A. & Mattsson, A. 2012. Assessment of sludge particle removal from wastewater by disc filtration. IWA Publishing 2012. *Water Practice & Technology*, **7**(2). doi:10.2166/wpt.2012.037
- Tchobanoglous G., Burton F.L & Stensel H.D. 2003 Wastewater engineering – treatment and reuse (4th edition).New Delhi: Tata McGraw-Hill Publishing Company. 1819 pp.
- Väänänen J. 2014 *Applying coagulation, flocculation and discfiltration in tertiary treatment*. Licentiate thesis. Lund University. Sweden.  
<http://lup.lub.lu.se/search/ws/files/6132020/4861577.pdf> (accessed 06-July 2017).
- Väänänen J., Langer M. & Cimbritz M. 2013 Phosphorus removal with discfilters in tertiary treatment: dosing requirements. The Nordic Wastewater Conference (NORDIWA 2013), Malmö, Sweden. Conference presentation, NORDIWA 2013, The Nordic Wastewater Conference, 8-10 October, Malmö, Sweden.
- Väänänen J., Cimbritz M., la Cour Jansen Y. 2016 Microsieving in primary treatment: effect of chemical dosing. *Water Science and Technology*, **74** (2), 438-447.
- Väänänen J. 2017 Microsieving in municipal wastewater treatment – chemically enhanced primary and tertiary treatment. Doctoral thesis. Lund University. Sweden.  
[http://portal.research.lu.se/ws/files/20814751/Thesis\\_Janne\\_V\\_n\\_nen\\_v2.pdf](http://portal.research.lu.se/ws/files/20814751/Thesis_Janne_V_n_nen_v2.pdf) (accessed 06-July 2017).
- van Haandel A. & van der Lubbe J. 2012 Handbook of Biological Wastewater Treatment. IWA Publishing, Science.



# Phosphorus recovery from solid residues originated from wastewater treatment plants

*Cristian Barca<sup>a,\*</sup>, Mathieu Martino<sup>a</sup>, Florent Chazarenc<sup>b</sup>, Nicolas Roche<sup>a</sup>, Pierre Hennebert<sup>c</sup>*

<sup>a</sup> Aix-Marseille Univ., CNRS, Centrale Marseille, M2P2 UMR 7340, 13451 Marseille, France

<sup>b</sup> L'UNAM Université, Institut Mines Telecom Atlantique, CNRS, GEPEA, UMR 6144, 44307 Nantes, France

<sup>c</sup> INERIS ARDEVIE, BP 2, F-60550 Verneuil-en-Halatte, France

\* Corresponding author: [cristian.barca@univ-amu.fr](mailto:cristian.barca@univ-amu.fr)

**Keywords:** P recovery; Sewage sludge; Filter material; Bauxite residue; Wet chemical extraction; Circular economy.

## Introduction

Nowadays, phosphorus (P) recovery from wastewater represents a promising strategy to overcome the shortage of natural resources (*e.g.* apatite rocks) for industrial production of chemical fertilizers. Moreover, P removal from wastewater can significantly reduce the supply of this nutrient into sensitive aquatic ecosystems, thus reducing the risk of eutrophication. Therefore, research on development of efficient techniques to recover P from wastewater has gained a growing attention (Nancharaiah *et al.*, 2016; Cieslik and Konieczka, 2017). Overall, the techniques commonly employed to retain P from wastewater can be summarized into two main categories: (i) biological: P is removed by polyphosphate accumulating organisms and it is accumulated in the sewage sludge; (ii) physicochemical: P is removed by chemical precipitation and/or retention on filter materials having a high affinity for P binding.

This study aims at evaluating P recovery from two different solid residues originated from wastewater treatment plants (WWTP): (i) sewage sludge residues from high temperature and pressure water oxidation, and (ii) bauxite residues used as filter media to upgrade P removal in constructed wetlands. The main objectives are: (i) to improve P extraction efficiency while limiting the release of undesired compounds (*e.g.* heavy metals), and (ii) to produce highly P concentrated eluates that can be used as a valuable resource for fertilizer production.

## Materials and methods

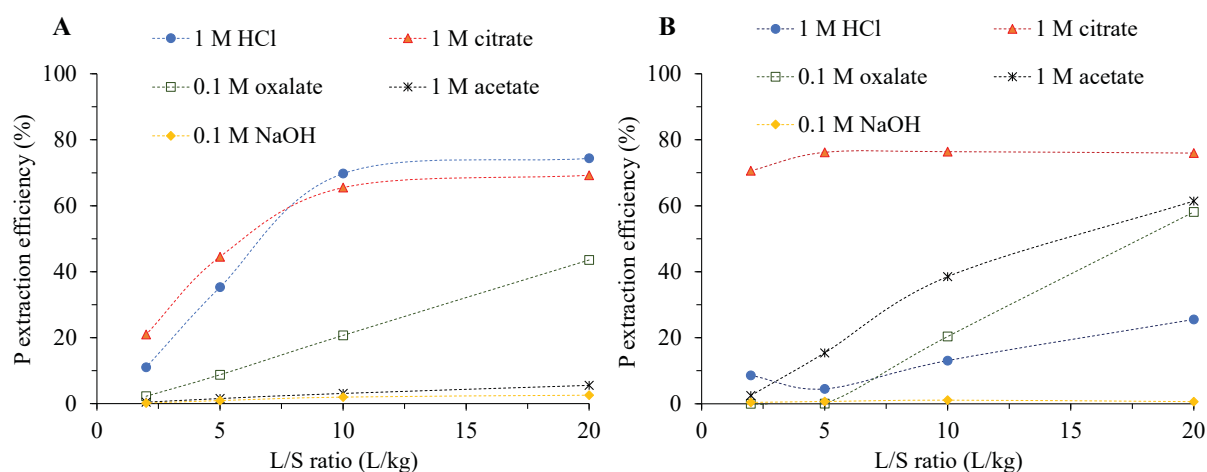
Sewage sludge residues used in this study come from the Pioline WWTP (Aix-en-Provence, France), whereas bauxite residues were collected from a pilot-scale filter treating a synthetic P wastewater after one year of operation (Institut Mines Telecom Atlantique, Nantes, France).

First, *aqua regia* extractions (EN 13657) were performed to determine the total P content of the residues. Second, sequential extractions (as adapted by Barca *et al.*, 2014) were carried out to quantify four fractions of P on residues: (i) weakly bound P, (ii) Fe and Al bound P, (iii) Ca bound P, and (iv) P in residual stable compounds. Third, P extraction experiments (adapted from EN 12457(1-2)) were performed to determine the best extractant solution (1 M HCl, 1 M citrate, 1 M acetate, 0.1 M oxalate, and 0.1 M NaOH) and the best liquid to solid ratio L/S (2, 5, 10, and 20 L/kg).

## Results and discussion

Sludge residues showed a total P content of  $131.9 \pm 1.8$  mg P/g (average  $\pm$  standard deviation) with P mainly present as Ca bound P (86% of total P), whereas bauxite residues showed a total P content of  $1.26 \pm 0.04$  mg P/g with P mainly present in stable compounds (83% of total P).

P extraction efficiency from sludge residues was higher than 65% after 24 h of extraction when using 1 M citrate and 1 M HCl at the L/S ratio of 10 L/kg, thus leading to P extraction capacities of about 90 mg P/g of dried material. The increase of the L/S ratio to 20 L/kg did not lead to a substantial increase in P extraction efficiency (Fig. 1A). Moreover, a good direct correlation between the amounts of Ca and P extracted by acid solutions was observed ( $R^2 > 0.95$ ), with molar ratios of Ca to P ranging around 1.2. This seems to confirm that P extraction from sludge residues was primarily related to dissolution of Ca-P complexes. Instead, the best extractant conditions for bauxite residues were observed when using 1 M citrate at the L/S ratio of 5 L/kg, thus leading to P extraction efficiency higher than 75% (Fig. 1B). Moreover, results indicated that organic acids were more performant than HCl, most probably because P complexing properties of organic acids favoured P extraction from stable compounds of bauxite residues.



**Fig. 1. P extraction experiments: A) sludge residues; B) bauxite residues.**

However, high Al and Fe concentrations (up to 5 g/L) were often observed in the leachates, indicating the need to develop a process of P concentration and purification of the leachates (e.g. sequential precipitation of Al and Fe hydroxides). In addition, P retention experiments performed at the Institut Mines Telecom Atlantique have shown that P saturation capacity of bauxite residue was not reached, indicating the need to continue the operation of the pilot-scale filter and/or to perform complementary long term experiments under real operating conditions.

### Acknowledgment

This project has received the support and has been funded by ECCOREV Research Federation.

### References

- Barca, C., Meyer, D., Liira, M., Drissen, P., Comeau, Y., Andres, Y., Chazarenc, F., 2014. Steel slag filters to upgrade phosphorus removal in small wastewater treatment plants: Removal mechanisms and performance. *Ecol. Eng.* 66, 214-222.
- Cieslik B., Konieczka P., 2017. A review of phosphorus recovery methods at various steps of wastewater treatment and sewage sludge management. The concept of “no solid waste generation” and analytical methods. *J. Cleaner Production* 142, 1728-1740.
- EN 12457(1-2), 2002. Characterisation of waste. Leaching. Compliance test for leaching of granular waste materials and sludges.
- EN 13657, 2002. Characterization of waste. Digestion for subsequent determination of aqua regia soluble portion of elements.
- Nancharaiah Y.V., Venkata Mohan S., Lens P.N.L., 2016. Recent advances in nutrient removal and recovery in biological and bioelectrochemical systems. *Bioresour. Technol.* 215, 173-185.

# Long-term investigation of phosphorus removal by iron electrolysis in actual small-scale wastewater treatment plants

Ref # S2SMALL-99511

I. Mishima<sup>1\*</sup>, M. Hama<sup>2</sup>, Y. Tabata<sup>3</sup>, J. Nakajima<sup>4</sup>

<sup>1</sup> Water Environment Group, Center for Environmental Science in Saitama, 914 Kamitanadare, Kazo, Japan

<sup>2</sup> 1st Development Department, Fuji Clean Co., Ltd., 4-2-21 Neura, Miyoshi, Japan

<sup>3</sup> 2nd Development Department, Fuji Clean Co., Ltd, 33 Yamahana Yamayashiki, Chiryu, Japan

<sup>4</sup> Master's Program in Environmental Engineering, Vietnam Japan University, Luu Huu Phuoc, My Dinh 1, Nam Tu Liem, Hanoi, Vietnam

\* Corresponding Author: [mishima.iori@pref.saitama.lg.jp](mailto:mishima.iori@pref.saitama.lg.jp)

**Abstract:** Small-scale wastewater treatment plants (SWTPs) called Johkasou are widely used as decentralized and individual wastewater treatment systems in sparsely populated areas in Japan. Even in SWTPs, nutrients should be removed to control eutrophication. An iron electrolysis method is effective to remove phosphorus chemically in SWTPs. However, it is necessary to determine the precise conditions under which phosphorus can be effectively and stably removed in actual SWTPs for a long period. Therefore, long-term phosphorus removal from SWTPs was investigated and optimum operational conditions for phosphorus removal by the iron electrolysis were analyzed in this study. Efficient phosphorus removal can be achieved for a long time by adjusting the amount of iron against the actual population equivalent. The change of the circulation ratio had no negative effect on overall phosphorus removal. Phosphorus release to the bulk phase was prevented by the accumulated iron which was supplied by iron electrolysis, resulting in stable phosphorus removal. The effect of environmental load reduction due to phosphorus removal by iron electrolysis was greater than the cost of power consumption for iron electrolysis.

**Keywords:** Iron electrolysis; phosphorus removal; Fe/P molar ratio; small scale wastewater treatment plants.

## INTRODUCTION

Small-scale wastewater treatment plants (SWTPs) called Johkasou are widely used as decentralized and individual wastewater treatment systems in sparsely populated areas in Japan. They can treat domestic wastewater from fewer than 10 household directly. Even in SWTPs, nutrients should be removed in order to control eutrophication in Japan. SWTPs are often installed in agricultural regions with a small population, and the phosphorus removed and accumulated in SWTPs may be used as agricultural fertilizer. Studies on phosphorus recovery from sludge incineration have also been progressing in recent years. As a process prior to the application of these techniques, a method for chemically and stably removing phosphorus in small-scale facilities such as SWTPs would be effective.

An iron electrolysis method is an electrocoagulation technique (Mollah et al., 2001; Pulkka et al., 2014) that uses electrochemical technology (Cong et al., 2016), which has been recently developed as a new method for the addition of iron as a coagulant into the wastewater treatment process (İrdemez et al., 2006; Mishima and Nakajima, 2011; Tran et al., 2012). Ferrous ions are supposed to be released from the anode of the iron electrodes, and then oxidized by dissolved oxygen to become ferric ions. These ferric ions in turn combine with

phosphate ions to remove phosphate from the wastewater. Phosphorus can easily be removed by means of the formation of compounds such as  $\text{FePO}_4$ , as conducted in this study.

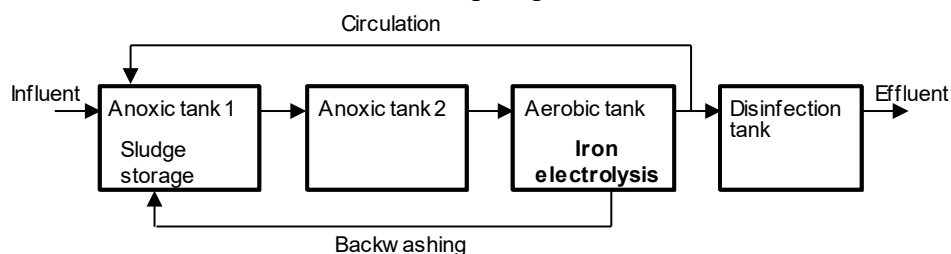
With the iron electrolysis method, because an iron plate can be kept in an aerobic tank, it is not necessary to install the liquid coagulant tank used at large-scale treatment plants. Furthermore, alkali is consequently produced in a cathode, therefore the pH decrease involved when adding liquid coagulant does not occur. In addition, microorganism respiratory activities were not reduced using iron electrolysis in actual wastewater treatment plant (Mishima and Nakajima, 2011). It is also known that iron oxides formed in the anode may prevent the iron electrode from dissolving from the electrode resulting in deteriorated phosphorus removal performance. This problem was addressed by interchanging the anode and cathode in several periods, and this technology enabled a long-term phosphorus removal operation (Moriizumi et al, 1999).

However, problems still remain with regard to the stability of phosphorus removal. Therefore, the behavior of phosphorus and Fe in SWTPs must be investigated in detail in order to clarify the factors contributing to phosphorus removal. Furthermore, it is necessary to determine the precise conditions under which phosphorus can be effectively and stably removed in actual SWTPs for a long period. Therefore, long-term phosphorus removal from SWTPs was investigated and optimum operational conditions for phosphorus removal by the iron electrolysis were analyzed using the data collected. Then, the effects of both the internal phosphorus behavior in the tank and the circulation ratio on the overall phosphorus removal were also investigated in plants. Finally, economy of this phosphorus removal system was calculated using a LCA tool to evaluate the cost effectiveness of this system.

## MATERIALS AND METHODS

### Investigated wastewater treatment plants

This study targeted five actual SWTPs (S1 to S5, each treating wastewater from five people equivalents), in which the iron electrolysis equipment for phosphorus removal was installed at the top of the aerobic tank. Each plant had two anoxic tanks and one aerobic tank, as shown in Figure 1. The volumes of anoxic tank 1, anoxic tank 2, and the aerobic tank were 0.93, 0.95, and 0.73  $\text{m}^3$ , respectively. Fluidized media were placed into the aerobic tank for biological oxidation of organic matter and nitrogen. Filtration using the fluidized media was performed at the bottom of the aerobic tank, and the wastewater in the aerobic tank was returned to the anoxic tank 1 for denitrification. Four iron electrodes (two units) were installed in the aerobic tank. The weight of each iron electrode was approximately 1.2 kg, and a direct current was allowed to flow in order to release iron ions for phosphorus removal.



**Figure 1.** Treatment process of investigated SWTPs with iron electrolysis.

### Operational conditions of wastewater treatment plants

The operational conditions of the five SWTPs are shown in Table 1. Each SWTP can serve five people equivalents; however, the actual population using it was two to five people. The

Fe addition and circulation conditions were adjusted during the experiment in order to assess their effect on phosphorus removal performance. Fe was not added during the first period for all plants nor for all periods of S2 as the control experiment. The amount of Fe addition was calculated according to Faraday's law, based on the direct current. The Fe/P molar ratio (molar ratio of planned P load to amount of Fe addition) and circulation ratio (ratio of returned flow rate as circulation to influent flow rate) were also calculated, and are shown in parentheses in the Fe addition and circulation row of Table 1. Backwashing was carried out twice a day by means of intensive aeration to move the sludge produced in the aerobic tank to the anoxic tank 1. The biologically and chemically produced sludge was stored in anoxic tank 1.

Removal of the accumulated sludge in each SWTP was conducted before beginning the sampling. Effluent sampling was carried out every two weeks, for an entire year from January 2014 to January 2015. BOD, SS, DOC, T-N, NH<sub>4</sub>-N, NO<sub>3</sub>-N, NO<sub>2</sub>-N, T-P, PO<sub>4</sub>-P, Ca and Fe in the effluent were measured. The sludge at the bottom of the SWTP tanks was also sampled, and the Fe content in the sludge and PO<sub>4</sub>-P concentration in the filtrate were measured in order to observe their effects on phosphorus removal. The amount of water consumption was estimated as the influent flow to SWTP by means of a water supply meter installed in each individual house.

**Table 1.** Operational conditions of investigated SWTPs.

Population		Condition	Period1		Period2		Period3		Period4		Period5		
S1	5	Fe addition	gFe/d	-	(-)	8	(0.9)	14	(1.5)	14	(1.5)	14	(1.5)
		Circulation	m <sup>3</sup> /d	4	(4)	4	(4)	4	(4)	-	(-)	>10	(>10)
S2	2	Fe addition	gFe/d	-	(-)	-	(-)	-	(-)	-	(-)	-	(-)
		Circulation	m <sup>3</sup> /d	4	(4)	4	(4)	4	(4)	-	(-)	>10	(>10)
S3	4	Fe addition	gFe/d	-	(-)	8	(1.1)	14	(1.9)	19	(2.6)	19	(2.6)
		Circulation	m <sup>3</sup> /d	4	(4)	4	(4)	4	(4)	4	(4)	4	(4)
S4	2	Fe addition	gFe/d	-	(-)	8	(2.3)	14	(3.8)	14	(3.8)	14	(3.8)
		Circulation	m <sup>3</sup> /d	4	(4)	4	(4)	4	(4)	-	(-)	>10	(>10)
S5	5	Fe addition	gFe/d	-	(-)	8	(0.9)	14	(1.5)	19	(2.1)	19	(2.1)
		Circulation	m <sup>3</sup> /d	4	(4)	4	(4)	4	(4)	4	(4)	4	(4)
n				6		7		6		5		3	

## RESULTS AND DISCUSSION

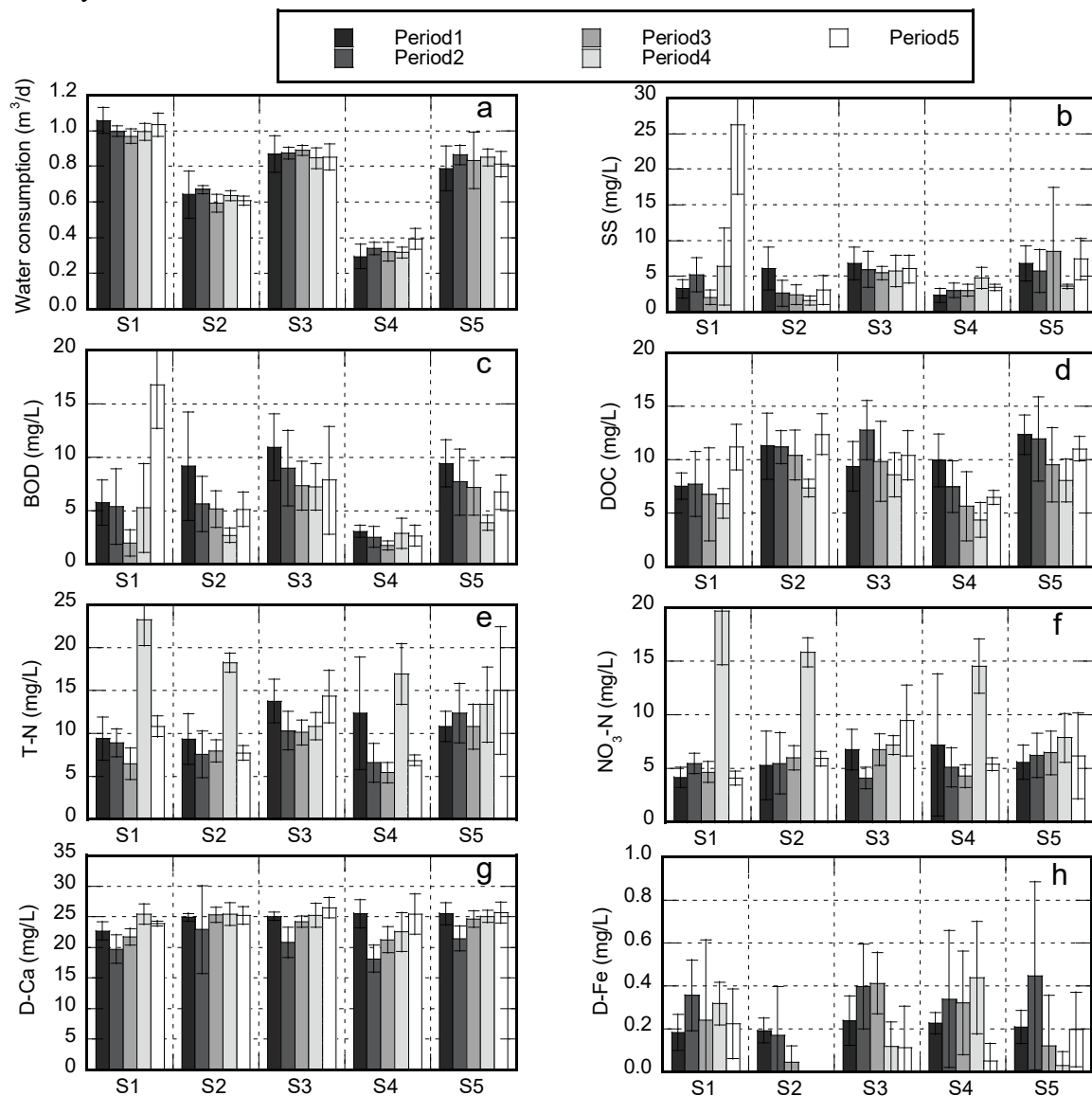
### Outline of treatment performance

Figure 2 shows average values for the amount of water consumption, SS, BOD, DOC, T-N, NO<sub>3</sub>-N, D-Ca, and D-Fe in the effluent during each period, along with the standard deviations. According to the calculation using the amount of water consumption in Figure 2 and population in Table 1, the average daily amounts of water use per person for S1 to S5 were 200, 310, 220, 170, and 170 m<sup>3</sup>/d/person, respectively. Though it was low in S2 due to low population, these values were almost equivalent to 200 m<sup>3</sup>/d/person, which is used as the designed wastewater flow for SWTPs in Japan (JECES, 2017). This indicates that the actual wastewater flow can be estimated if the population has been obtained. Therefore, the influent phosphorus load was calculated using the wastewater flow obtained from the population and a general phosphorus concentration of 5 mgP/L (JECES, 2017). The molar ratios of the Fe addition to phosphorus loads shown in Table 1 were also calculated from these values and used as an index for the phosphorus removal analysis described later.

The values of SS and BOD were generally 10 mg/L or less in every SWTP, with the exception of period 5 for S1. During this period, it was thought that the sludge in the tank reached an excessive concentration and not all of it could be trapped by filtration using the

fluidized media. As a result, SS flowed out in the effluent, leading to an increase in SS and BOD. In fact, following this investigation period, the accumulated sludge was removed from S1 and the additional operation continued for approximately two months. The average values of SS and BOD decreased to 4.8 and 6.0, respectively, in this period.

The fact that T-Ca and D-Ca had almost the same concentration indicated that the majority of calcium existed as a soluble form. The values of D-Ca were nearly constant during all periods, between 20 and 25 mg/L. In the periods where iron electrolysis was not performed, T-Fe in the effluent was 0.2 to 0.3 mg/L. The amount of T-Fe in the effluent exhibited an increase through the iron electrolysis. However, the added Fe was thought to be in a particulate state, because, the values of D-Fe with iron electrolysis were in the same range without iron electrolysis.



**Figure 2.** Water quality in effluent.

During period 4, with the circulation set to 0, a decrease in alkalinity, an accumulation of NO<sub>3</sub>-N and an associated increase in T-N were clearly observed. It was implied that biological denitrification and the associated alkalinity supply ceased because the nitrified wastewater was not circulated to the anoxic tank. As a result, the nitrogen removal performance, an important function of the SWTP, was lost. However, neither nitrification



inhibition nor a significant pH decrease occurred, because an alkalinity of 40 mg/L or greater remained. Actually, the pH values were within a neutral range in every case. As described above, when the circulation was changed, the effect thereof on nitrogen removal was confirmed. In other periods, the T-N values were close to 10 mg/L or less, which indicated that nitrification and denitrification progressed effectively in each period. Changes in T-N corresponding to changes in electrolysis conditions have not been specifically observed; therefore, it was concluded that the iron electrolysis did not obstruct nitrogen removal.

### **Phosphorus removal performance**

Regarding the T-P values during period 1 and the all the periods of S2, the value of S1 was lower than those in other periods, at approximately 2 mgP/L, while that of other periods was approximately 4 mgP/L on average. The difference of phosphorus concentration was observed among SWTPs.

The values of both T-P of S2 did not show remarkable variations during any periods because S2 was not subjected to electrolysis. The mean effluent PO<sub>4</sub>-P concentration and the standard deviation for each measurement period are shown in Figure 3. A decrease in PO<sub>4</sub>-P was observed, corresponding to the increase in Fe addition by means of electrolysis during periods 2 to 5, indicating effective phosphorus removal by iron electrolysis. For S1 and S4, it was confirmed that the PO<sub>4</sub>-P values during period 3 were 1 mg/L or less. However, for S3 and S5, the PO<sub>4</sub>-P values in the effluent during the operation in period 3 were 1 to 2 mg/L. Accordingly, when S3 and S5 were operated with a further increased Fe addition amount during period 4 to 5, it was confirmed that the PO<sub>4</sub>-P values in the effluent decreased further, to 1 mg/L or less. Therefore, the conditions affecting phosphorus removal by less than 1 mg/L differed among the SWTPs.

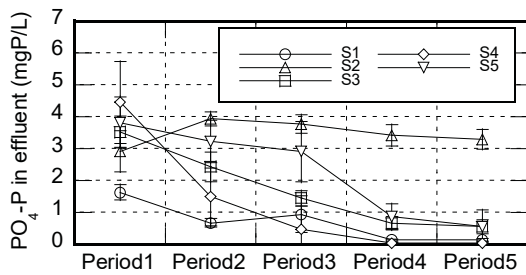
The relationships between the effluent PO<sub>4</sub>-P and Fe/P molar ratio are shown in Figure 4. The PO<sub>4</sub>-P concentration correlated with the Fe/P molar ratio ( $P < 0.001$ ), indicating that efficient phosphorus removal could be achieved by adjusting the Fe addition with the iron electrolysis against the actual population equivalent in each SWTP. This result was corresponding with the previous results in which the addition of iron as a coagulant by Fe/P molar ratio of 2.0 was enough to reduce phosphorus concentration below 1.0 mgP/L (Rittmann and McCarty, 2001).

For S1 and S4, in which iron electrolysis was performed, the circulation ceased during period 4, and the circulation ratio was set to 10 or higher in period 5. Compared to period 3, with a normal circulation ratio, a significant difference in the average PO<sub>4</sub>-P value was recognized only in period 4 for S1 ( $P < 0.01$ ). Average PO<sub>4</sub>-P in period 4 was lower than that in period 3 in S1. This indicated that deterioration of phosphorus removal was not observed even if the circulation stopped or operated at a very high ratio. The fact that a significant difference was found implied that there was a possibility that the highly accumulated iron in the aerobic tank by stopping the circulation contributed effectively for phosphorus removal. In contrast, during period 5, where the circulation ratio was increased, phosphorus removal did not decrease compared to period 3. The large part of added Fe was returned into anoxic tank due to the high circulation ratio. These Fe accumulated in the anoxic tank would contribute to the prevention of the phosphorus release. For further improve of phosphorus removal, analysis of the Fe and phosphorus reaction mechanisms in the aerobic and anoxic tanks will be required.

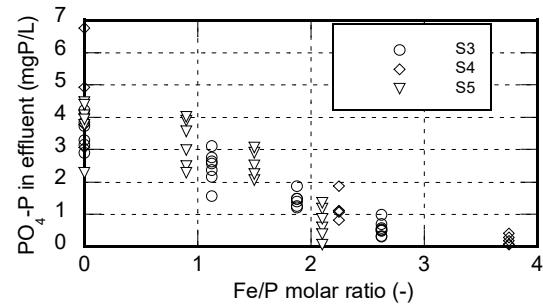
It had been reported that phosphorus removal improved when calcium was rich (Li et al., 2013; Mishima et al. 2017). Mishima et al. (2017) investigated improvement in phosphorus removal through iron electrolysis with calcium addition. In some cases where calcium was lacking, phosphorus removal performance was poor, and when calcium was added, phosphorus removal improved. If the amount of calcium became more than 20 mg/L, an improvement was hardly observed. Therefore, Mishima et al, (2017) pointed out that it was



desirable for the calcium amount to be 20 mg/L or more for the efficient phosphorus removal. In this study, the calcium amount of calcium was approximately 20 - 25 mg/L; therefore, it was suggested that phosphorus removal inhibition due to a lack of calcium did not occur because enough calcium was in the investigated SWTPs.



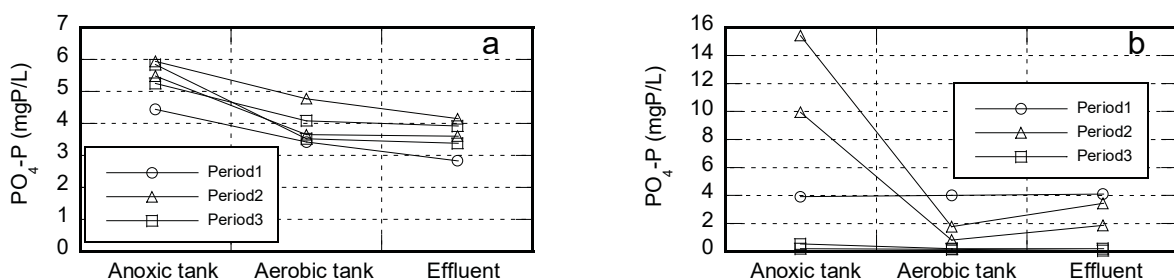
**Figure 3.** Change of PO<sub>4</sub>-P.



**Figure 4.** Relationships between Fe/P molar ratio and PO<sub>4</sub>-P.

Mishima et al. (2017) also reported that the amount of Fe binding to phosphorus decreased because the organic matter formed a complex with iron when the DOC in the bulk of the wastewater was high, and phosphorus removal consequently deteriorated. In this study, the average DOC was 9.2 mg/L during all periods; however, at times the DOC values were high, with a maximum of 18 mg/L. It had the possibility that the phosphorus removal performance was improved further if DOC could be decreased.

The effects of changing PO<sub>4</sub>-P in the anoxic tank 1, aerobic tank, and effluent in S2 and S4 are illustrated in Figure 5. The level of PO<sub>4</sub>-P decreased slightly from the anoxic tank to effluent in S2 without iron electrolysis, and was almost constant during period 1 in S4 without iron electrolysis. PO<sub>4</sub>-P in the anoxic tank during period 2 in S4 was higher than that during period 1 in S1 and during all periods in S2. Moreover, PO<sub>4</sub>-P in the effluent was higher than that in the aerobic tank in S4. These results indicate that the amount of accumulated phosphorus in the tank as a result of the effect of iron electrolysis increased, and part of the accumulated phosphorus was released in an anaerobic condition at the bottom of the tank. PO<sub>4</sub>-P existed in a low concentration from the anoxic tank to effluent during period 3 in S4. This result indicated that the Fe addition by iron electrolysis contributed to not only the direct production of FePO<sub>4</sub> in the aerobic tank, but also the prevention of anaerobic phosphorus release from the sludge.

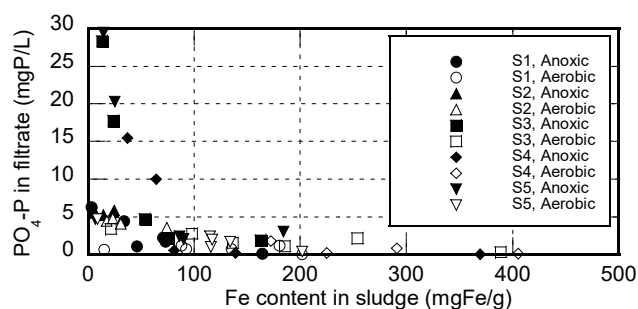


**Figure 5.** Changing PO<sub>4</sub>-P of first anoxic tank, aerobic tank, and effluent in S2 (a) and S4 (b).

### Role of iron

Figure 6 shows the relationships between the Fe content and PO<sub>4</sub>-P in the filtrate in anoxic tank 1 and the aerobic tank, during periods 1 to 4. In this case, the maximum Fe content in the aerobic tank was approximately 400 mg/g. The Fe content in the aerobic tank was higher than that in anaerobic tank, because iron electrolysis was performed directly in the aerobic tank,

and substances such as organic matter suspended in the influent were accumulated in anoxic tank. In particular, the PO<sub>4</sub>-P in the filtrate was a maximum of 29 mgP/L in the anoxic tank (during period 2 of S5), which was much higher than the influent phosphorus concentration. The maximum PO<sub>4</sub>-P in the aerobic tank was 4.8 mgP/L. The PO<sub>4</sub>-P in the filtrate in both the anoxic and aerobic tanks decreased with an increase in Fe content in the sludge samples. It was indicated that phosphorus release from the sludge to the bulk phase was prevented by the Fe, which was supplied by iron electrolysis and accumulated at the bottom of the SWTPs, resulting in stable phosphorus removal.



**Figure 6.** Relationships between Fe content and PO<sub>4</sub>-P.

**Table 2.** Comparison of costs for phosphorus removal.

Electric power consumption (Japanese yen/y)	Reduction of environmental load by T-P removal (Japanese yen/y)
1200	1560

### Economy of this system

LIME2 (Itsubo and Inaba, 2010; Itsubo et al., 2012) is a LCA tool that can estimate the integrated environmental load as an economic value; this tool had already applied to evaluate a wastewater treatment plant (Mishima et al., 2016). Therefore, the economy of phosphorus removal by iron electrolysis was evaluated using this tool. The cost of electric power consumption for iron electrolysis (14 gFe/d of Fe addition) was estimated according to the product of the power consumption due to iron electrolysis and the electric energy charge for each unit of power consumption in the case of period 3 in S4. The environmental load reduction by T-P removal was estimated by the product of the decrease in T-P discharge load and T-P damage factor, and the economic value conversion factor. The decrease in T-P discharge load was calculated by the product of the difference in T-P concentration between the assumed phosphorus concentration in the influent of 5.0 mgP/L (JECES, 2017) and the average effluent T-P concentration of 0.7 mgP/L in the case of period 3 in S4, and the planned water consumption of 1.0 m<sup>3</sup>/d. A T-P damage factor of 973.9 Japanese yen/T-Pkg and an economic value conversion factor of 1 Japanese yen/Japanese yen were used in accordance with LIME2.

A comparison of the calculated results of phosphorus removal costs between electric power consumption and environmental load reduction by T-P removal is shown in Table 2. The electric power consumption cost was in the same range as that of the environmental load reduction by T-P removal, with the latter being 30% higher than the former. Therefore, it was demonstrated that the effect of environmental load reduction due to phosphorus removal by iron electrolysis was greater than the cost of power consumption for iron electrolysis.

### CONCLUSIONS

Long-term phosphorus removal from SWTPs was investigated and optimum operational conditions for phosphorus removal by the iron electrolysis were analyzed in this study. Efficient phosphorus removal can be achieved for a long time by adjusting the amount of iron against the actual population equivalent. The change of the circulation ratio had no negative effect on overall phosphorus removal. Phosphorus release to the bulk phase was prevented by

the accumulated iron which was supplied by iron electrolysis, resulting in stable phosphorus removal. The effect of environmental load reduction due to phosphorus removal by iron electrolysis was greater than the cost of power consumption for iron electrolysis.

## REFERENCES

- Cong, V. H., Sakakibara, Y., Komori, M., Kishimoto, N., Watanabe, T., Mishima, I., Ihara, I., Tanaka, T., Yoshida, Y. & Ozaki, H., 2016 Recent developments in electrochemical technology for water and wastewater treatments. *Journal of Wat. Env. Tech.*, **14**(2), 25–36.
- Japan Education Center of Environmental Sanitation 2017 Johkasou Systems For Domestic Wastewater Treatment 6th Edition. Tokyo.
- İrdemez, Ş., Demircioğlu, N. & Yildiz, Y. Ş. 2006 The effects of pH on phosphate removal from wastewater by electrocoagulation with iron plate electrodes. *Journal of Hazardous Materials*, **137**(2), 1231–1235.
- Itsubo, N., & Inaba, A. 2010 LIME2 Life-cycle Impact Assessment Method Based on Endpoint Modeling. Nippon Publicity, Tokyo. (in Japanese)
- Itsubo, N., Sakagami, M., Kuriyama, K. & Inaba, A. 2012 Statistical analysis for the development of national average weighting factors—visualization of the variability between each individual's environmental thoughts. *Int. J. Life Cycle Assess*, **17**(4), 488-498.
- Li, W., Zhou, J. Z., Zhang, J., Zhao, J., Xu, Y., & Qian, G. 2013 pH-Dependent improvement of pyrophosphate removal on amorphous ferric hydroxide by incorporating  $\text{Ca}^{2+}$ . *Chemical Engineering Journal*, **225**, 372–377.
- Mishima, I. & Nakajima, J. 2011 Application of iron electrolysis to full-scale activated sludge process for phosphorus removal. *Journal of Wat. Env. Tech.*, **9**(4), 359-369.
- Mishima, I., Yoshikawa, N., Yoshida, Y. & Amano, K. 2016 Development of an integrated environmental impact assessment model for assessing nitrogen emissions from wastewater treatment plants. *Journal of Wat. Env. Tech.*, **14**(1), 6–14.
- Mishima, I., Hama, M., Tabata, Y. & Nakajima, J. 2017 Improvement of phosphorus removal by calcium addition in the iron electrocoagulation process. *Water Science and Technology*, in press.
- Mollah, M. Y. A., Schennach, R. Parg, J. R. & Cocke, D. L. 2001 Electrocoagulation (EC)—science and applications. *Journal of Hazardous Materials*, **B84**, 29–41.
- Moriizumi, M., Fukumoto, A., Yamamoto, Y. & Okumura, S. 1999 Basic studies on the characteristics of phosphorus removal by the electrochemical elution of iron. *Journal of Japan Society on Water Environment*, **22**(6), 459–464. (in Japanese)
- Nakajima, J. & Mishima, I. 2004 Reduction of coagulant amount added to activated sludge for phosphorus removal. *Water Science and Technology*, **50**(7), 287–292.
- Pulkka, S., Martikainen, M., Bhatnagar, A. & Sillanpää, M. 2014 Electrochemical methods for the removal of anionic contaminants from water – A review. *Separation and Purification Technology*, **132**, 252–271.
- Rittmann, B.E. & McCarty, P.L. 2001 Environmental biotechnology: principles and applications. McGraw-Hill, New York.
- Tran N., Drogui P., Blais J.-F. & Mercier, G. 2012 Phosphorus removal from spiked municipal wastewater using either electrochemical coagulation or chemical coagulation as tertiary treatment. *Separation and Purification Technology*, **95**, 16–25.

# Phosphate removal from aqueous solution using ZVI/sand bed reactor: Behavior and mechanism

Ref # S2SMALL-12891

N. Sleiman<sup>\*1,2</sup>, V. Deluchat<sup>1</sup>, V. Kazpard<sup>2</sup>, M. Wazne<sup>3</sup>, M. Baudu<sup>1</sup>

<sup>1</sup> University of Limoges, 123 Avenue Albert Thomas, 87000 Limoges, France

<sup>2</sup> Lebanese University, Hadath campus, Lebanon

<sup>3</sup> Lebanese American University, Byblos Campus, Lebanon

\* Corresponding Author: nathalie.sleiman@gmail.com

**Keywords:** Phosphorus removal, zero valent iron, column experiment, preconditioning effect

## INTRODUCTION

Phosphorus (P) is an essential nutrient for plant and living organisms. However an excessive concentration of P in water bodies can lead to an ecological unbalance manifested by eutrophication. This may further deteriorate the water quality. Eutrophication is recognized as one of the major threats for small lakes and reservoirs. It has become a serious problem as a result of increased urbanization and industrialization. Several techniques were developed for the removal of phosphate. Zero valent iron has gained considerable attention for the removal of different organic and inorganic compounds. Some research work focused specifically on phosphate removal using ZVI. The removal of P using ZVI has been previously investigated in batch and column experiments (Sleiman et al. 2016, 2017).

## MATERIAL AND METHODS

In this study, the effectiveness of ZVI for the removal of phosphate in an upflow ZVI /sand 1%  $W_{Fe}/W_{Sand}$  packed columns was assessed along with the determination of the maximum ZVI phosphate trapping capacity (Figure 1).

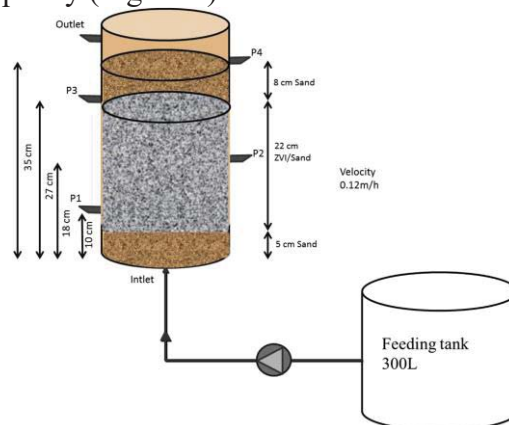


Figure 1. Schematic representation of the column dimensions.

ZVI and its oxidation products may change over time along with their reactivity. In order to assess the evolution of ZVI oxidation products reactivity, phosphate removal was investigated in column reactors with different preconditioning durations. Phosphate removal was also investigated along the various depths of the columns. To attain this goal, phosphate concentration was measured at different sampling ports along the column and the results were assessed in relation to the corresponding phosphate amounts trapped inside the column. Phosphate retention capacities were confirmed through analyzing total phosphorus and iron in the ZVI/sand support collected at the end of the experiment. After column dismantling, a

sequential extraction was done on the solid samples collected at different levels from the column in order to identify the phosphorus and iron forms. Solid samples were also characterized using SEM, XRD and XPS in order to understand the mechanism of phosphate removal.

## MAIN RESULTS AND CONCLUSIONS

In order to see the capacity of the support in different layers to remove phosphate, the ratio P/Fe was calculated. P/Fe ratios were determined as a function of time at P1, P2 and P3. P profile evolved to a homogeneous one at saturation. This evolution of the behavior of phosphate trapping inside the column as a function of time can be explained by the DO concentration migration along the column. When the first layers get saturated and/or the ZVI surface is protected (no oxidation is taking place) DO cannot be consumed and it may migrate to the next layers which become active and efficient to remove phosphate. The concentration of dissolved oxygen was found to be a key parameter in the removal of phosphate using ZVI/sand columns.

The preconditioning or aging phenomenon was defined as the period in which the columns were pumped with a solution of NaCl 0.01M in closed circuit at 100 rpm. After a defined aging time, the columns were then pumped with phosphate solution having a concentration of 20 mgP/L. After column dismantling, the solids collected were studied for their phosphate and iron concentration. Results showed that the mean value of P trapped inside the columns were 94 and 38 respectively for the fresh and 10d aged column. As a function of time, the surface of ZVI may be covered by iron oxides which evolves under aging from amorphous to crystalline phases which may explain the lower efficiency for the 10d aged column compared to the fresh one. These results pointed out the effect of preconditioning on the behavior of the columns for phosphate removal.

In order to verify the hypothesis, a sequential extraction was done on the fresh and 10d aged columns at different sampling points. Results are presented in Figure 2 for Fe and P in the different extractable phases. Figure 2a showed that for the fresh and 10d aged columns, the amorphous phase showed the highest percentage about 90% of P were extracted in the amorphous phase. When comparing the fraction percentages for iron for the fresh and 10d aged columns, we found that the percentage of the crystalline phases were higher for the 10d aged column than the fresh one. XRD results showed that the only iron oxidation products identified at the different layers inside the columns were lepidocrocite and maghemite/magnetite (Wan et al., 2014). XPS results confirmed the sorption of phosphate at the surface of ZVI and its oxidation products and highlighted the formation of an iron phosphate complex.

## LIST OF REFERENCES

Sleiman, N., Deluchat, V., Wazne, M., Courtin, A., Saad, Z., Kazpard, V., Baudu, M., 2016. Role of iron oxidation byproducts in the removal of phosphate from aqueous solution. *RSC Adv.* 6, 1627e1636. <http://dx.doi.org/10.1039/C5RA22444F>.

Sleiman, N., Deluchat, V., Wazne, M., Courtin, A., Saad, Z., Kazpard, V., Baudu, M., 2017. Phosphate removal from aqueous solutions using zero valent iron (ZVI): Influence of solution composition and ZVI aging, *Colloids and Surfaces A: Physicochem. Eng. Aspects* 514,1–10. <http://dx.doi.org/10.1016/j.colsurfa.2016.11.014>

Wan, J., Pressigout, J., Simon, S., Deluchat, V., 2014. Distribution of As trapping along a ZVI/sand bed reactor. *Chem. Eng. J.* 246, 322e327. <http://dx.doi.org/10.1016/j.cej.2014.02.073>.

**Parallel session 4 - Anaerobic Digestion 1**

**14:00-15:20**

Session chair: Paula Paulo

**516 - Two- vs. single-stage anaerobic wastewater treatment: Evaluation of effluent quality and energy production potential**

MOTA Vera Tainá - *University of São Paulo*

**301 - Evaluation of spatial alkalinities distribution in an up-flow fixed bed anaerobic digestion reactor**

HMISSI Maha - *Laboratory of Hydraulic Modelisation and environnement, Tunisia*

**552 - Post-treatment of UASB effluent by phototrophic reactors for sulphide and organic matter removal**

BRESSANI Thiago - *Federal University of Minas Gerais, Department of Sanitary and Environmental Engineering (UFMG/DESA)*

**466 - Acclimation of mesophilic granular sludge for the anaerobic digestion of agroindustrial effluents under thermophilic conditions**

CARRILLO-REYES Julian - *University of Mexico*

**Parallel session 5 - Anaerobic Digestion 2**

**15:40-17:00**

Session chair: Philippe Ker Rault

**451 - Anaerobic municipal wastewater treatment in centralized and decentralized treatment systems: biological methane potential and microbial community at 20 and 35°C**

GAO Mengjiao - *University of Alberta*

**470 - Hybrid Anaerobic Upflow Sludge Blanket Baffled Reactor for Source-separated Blackwater Treatment**

MOGES Melesse Eshetu - *PhD Candidate*

**510 - Anaerobic digestion of sieved, statically and mechanically thickened blackwater at different organic loading rates**

MORANDI Carlo G. - *Kaiserslautern University of Technology*

**604 - Carbon footprint assessment and management of sludge and gaseous emissions in decentralized anaerobic-based sewage treatment plants**

BRESSANI Thiago - *Federal University of Minas Gerais*

**Parallel session 6 - Anaerobic / Aerobic systems**

**17:20-18:20**

Session chair: Yves Andres

**467 - Coupling wastewater treatment based on microalgae-bacteria with the continuous methane recovery: effect of digester temperature**

CARRILLO-REYES Julian - *University of Mexico*

**488 - Sequential "electrochemical-peroxidation – electro-Fenton" process for the treatment of anaerobic sludge from a poultry farm**

OLIVIER Lefebvre - *National University of Singapore*

**490 - Identifying optimal conditions for the start-up of an AnMBR treating concentrated domestic wastewater**

FERRARI Federico - *Catalan Institute for Water Research*



# Two- vs. single-stage anaerobic wastewater treatment: Evaluation of effluent quality and energy production potential

Ref # S2SMALL-53711

V.T. Mota<sup>1\*</sup>, M. Zaiat<sup>1</sup>

<sup>1</sup> University of São Paulo, Department of Hydraulics and Sanitary Engineering, Biological Processes Laboratory. Avenida João Dagnone, 1100. São Carlos, São Paulo, Brazil. CEP: 13563-120

\* Corresponding Author: [vtaina@hotmail.com](mailto:vtaina@hotmail.com)

**Abstract:** In this study, two and single-stage anaerobic reactors were assessed for treatment performance and bioenergy production from sucrose-based wastewater (5 gCOD L<sup>-1</sup>), at 30°C. In the two-stage system, a hydrogen-producing UASB reactor (HR) was used in the acidogenic phase. The methanogenic reactor (MR) of the two-stage system, and the single-stage methanogenic reactor (SMR) of the single-stage system consisted of structured fixed-bed reactors filled with polyurethane foam. The two-stage system showed superior performance, evidenced by less organic acids, chemical organic demand (COD) and volatile suspended solids (VSS) levels in the effluent, and higher biogas yields. At the end of operation, the OLR applied to the two- and single-stage systems were 6.4 and 5.2 gCOD L<sup>-1</sup>d<sup>-1</sup>, respectively. Under these conditions, effluent soluble COD levels and effluent VSS concentrations were, respectively, 165 and 92 mg L<sup>-1</sup> in the two-stage system, and 256 and 244 mg L<sup>-1</sup> in the single-stage system. The energy yield of the two-stage system was 20,688 kJ g<sup>-1</sup>COD<sub>added</sub>, which was 34% higher than the yield of the single-stage system, that was 15,485 kJ g<sup>-1</sup>COD<sub>added</sub>.

**Keywords:** fixed-bed reactor, hydrogen; methane; two-stage anaerobic treatment, UASB, suspended solids.

## INTRODUCTION

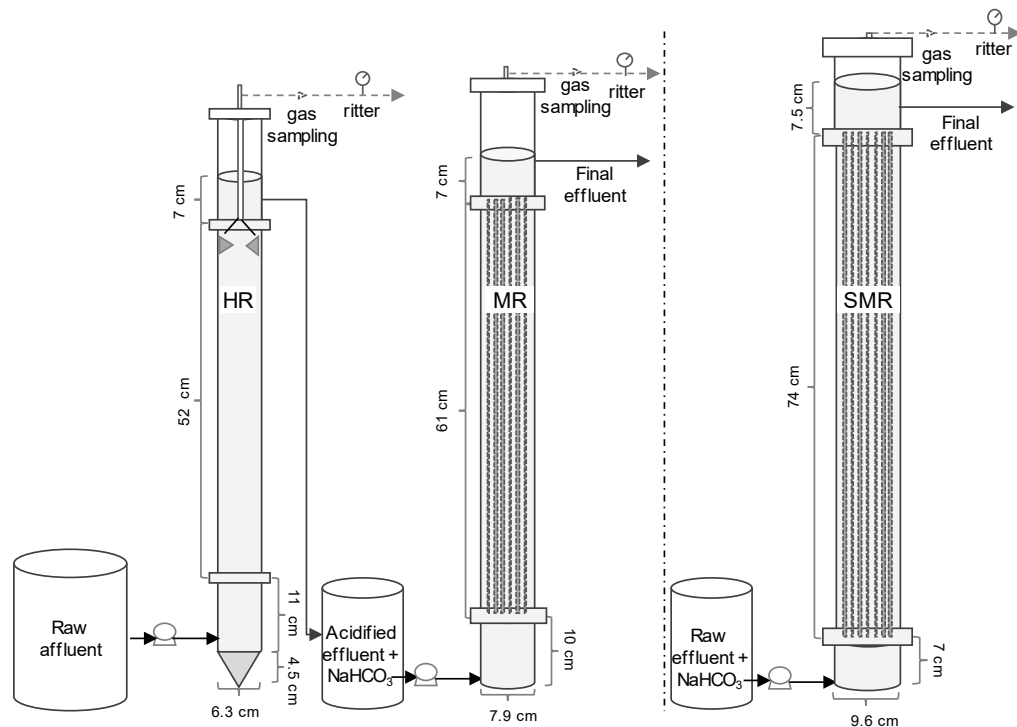
A two-stage anaerobic system consists of two reactors placed in series, wherein acidogenesis and methanogenesis should prevail in the first and second reactor, respectively, as a result of selective pressure. Despite its several advantages – greater efficiency of removing pollutants, reduction of toxic inhibition on methanogens (Ke et al. 2005), higher tolerance to shock loads (Cohen et al. 1982), and enrichment of methane content in the biogas (Yeoh, 1997) – about only 10% of installed capacity of anaerobic reactors in Europe is through two-stage anaerobic digestion (Rapport et al. 2008). As pointed out by these authors, the increasing of commercial application of this process is expected to growth as the higher complexity and construction costs are overcome by the improvements in the process. In this context, this study evaluated some potential advantages of the two-stage over single-stage anaerobic reactors, including higher bioenergy production potential through recovery of hydrogen besides methane, and improvement of effluent quality due to the lower volatile suspended solids (VSS) concentration in final effluent. Two and single-stage anaerobic reactor were run in parallel at increasing organic loading rates (OLR).

## MATERIALS AND METHODS

The reactors were cylindrical and made of acrylic. The two-stage system comprised an upflow anaerobic sludge blanket (UASB) reactor of 2.2 L working volume and 6.3 cm internal diameter, used for acidogenesis, followed by a structured fixed-bed reactor of 3.8 L working volume and 7.9 cm internal diameter, used for methanogenesis. The single-stage system



consisted of a structured fixed-bed reactor of 6.4 L working volume and 9.6 cm internal diameter. The medium compartment of the structured-fixed bed reactors was filled with polyurethane foam strips at a porosity about 80% (Figure 1). The reactors were named as follows: i) HR: hydrogen-producing reactor, used for acidogenesis in the two-stage system, ii) MR: methanogenic reactor, used for methanogenesis in the two-stage system, iii) SMR: single-stage methanogenic reactor, used in the single-stage system. The reactors were inoculated with 15 gVTS L<sup>-1</sup> of sludge from slaughterhouse wastewater treatment plants. The granules were completely disrupted with a blender before inoculation.



**Figure 1.** Schematic diagram of the two-stage (left) and single-stage (right) systems.

The HR and SMR were fed with sucrose-based wastewater composed of demerara sugar (Native®) and a nutrient's solution in the following concentrations (mg L<sup>-1</sup>): NH<sub>4</sub>Cl (170), CaCl<sub>2</sub>·2H<sub>2</sub>O (8), KH<sub>2</sub>PO<sub>4</sub> (37), MgSO<sub>4</sub>·4H<sub>2</sub>O (9), FeCl<sub>3</sub>·4H<sub>2</sub>O (2), CoCl<sub>2</sub>·6H<sub>2</sub>O (2), MnCl<sub>2</sub>·4H<sub>2</sub>O (0.5), CuCl<sub>2</sub>·2H<sub>2</sub>O (0.03), ZnCl<sub>2</sub> (0.05), H<sub>3</sub>BO<sub>3</sub> (0.05), (NH<sub>4</sub>)<sub>6</sub>Mo<sub>7</sub>O<sub>24</sub>·4H<sub>2</sub>O (0.09), Na<sub>2</sub>SeO<sub>3</sub>·5H<sub>2</sub>O (0.1), NiCl<sub>2</sub>·6H<sub>2</sub>O (0.05), EDTA (1), HCl 36% (1 μL L<sup>-1</sup>); and the MR was fed with acidified wastewater from the HR. Demerara sugar concentration in raw effluent of the HR was approximately 4.45 g L<sup>-1</sup> (4.8 gCOD L<sup>-1</sup> on average). The methanogenic reactors were fed with diluted wastewater during the acclimation period, which lasted for 38 days. From days 0 to 17 (acclimation 1) the feeding was diluted 5-fold, and from days 18 to 38 (acclimation 2) the feeding was diluted 3.3-fold. After acclimation, the MR and SMR were fed with acidified effluent without dilution (4.4 gCOD L<sup>-1</sup> on average) and raw wastewater (4.8 gCOD L<sup>-1</sup> on average), respectively. NaHCO<sub>3</sub> was added in the feeding of the MR and SMR as buffer agent, at concentrations of 1 g L<sup>-1</sup> and 1.5 g L<sup>-1</sup> during acclimation periods 1 and 2, respectively, and 5 g L<sup>-1</sup> from days 39 to 73, and 4.16 g L<sup>-1</sup> from days 74 to 178. MR and SMR feeding was also supplemented with yeast extract at concentration of 200 mg L<sup>-1</sup>, and during acclimation 1 and 2 it was diluted 5- and 3.3-fold, respectively (40 and 61 mg L<sup>-1</sup>). The temperature was maintained at 30±2 °C.

The operation was divided in two periods of acclimation, when MR and SMR affluent was diluted as described above, and seven phases of operation, when the MR and SMR flow rate was gradually increased according to their stability responses (Table 1).

**Table 1.** Operating conditions

Phase	Time (days)	Two-stage system					Single-stage system			
		HR		MR		HR+MR	SMR			
		$S_0$ (gCOD L <sup>-1</sup> )	HRT(h)	$S_0$ (gCOD L <sup>-1</sup> )	HRT (h)	OLR (gCOD L <sup>-1</sup> d <sup>-1</sup> )	$S_0$ (gCOD L <sup>-1</sup> )	HRT (h)	OLR (gCOD L <sup>-1</sup> d <sup>-1</sup> )	
Aclim. 1	0-17	4.5	4.2	0.7	5.4	3.5	0.9	8.7	2.5	
Aclim. 2	18-38	4.7	7.7	1.2	8.7	3.1	1.5	14.4	2.5	
1	39-58	4.6	4.8	3.9	29.8	3.2	4.6	47.6	2.3	
2	59-93	4.8	4.7	3.9	48.5	2.2	4.7	56.5	2.0	
3	94-101	4.6	4.4	4.9	36.0	2.7	4.9	40.8	2.9	
4	102-129	5.0	4.6	4.7	29.4	3.5	4.9	34.0	3.5	
5	130-136	4.8	4.5	5.0	24.5	4.0	5.1	34.0	3.6	
6	137-156	4.7	4.4	4.8	20.4	4.6	4.8	34.0	3.4	
7	157-178	4.8	4.5	4.4	13.7	6.4	4.9	22.8	5.2	

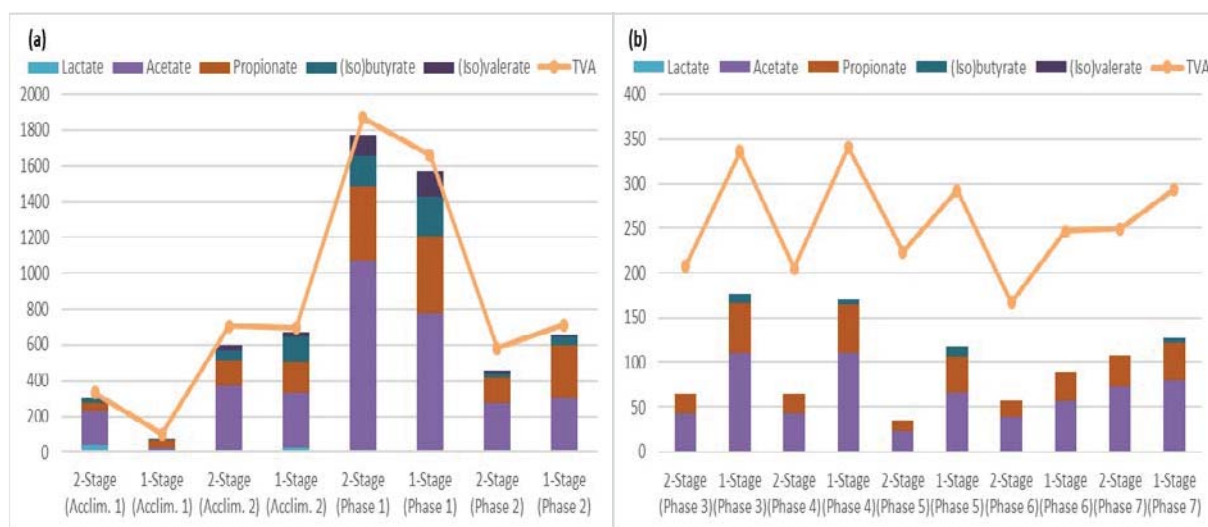
Biogas flow rate was measured using Milligas counter gas meters (Ritter®). The composition, in terms of H<sub>2</sub>, CH<sub>4</sub> and CO<sub>2</sub>, was analysed using Shimadzu GC-2010 gas chromatograph. Sucrose (glucose and fructose) and organic acids (lactic, formic, acetic, propionic, isobutyric, butyric, isovaleric, valeric) were determined using Shimadzu System UV/DAD (210 nm) high performance liquid chromatography (HPLC). Total COD, soluble COD (filtered in 1.2 µm membrane) and VSS concentration were analysed according to *Standard Methods* (2005). The pH was measured using a pHmeter (Hach equipment). Total volatile acids (TVA) and bicarbonate alkalinity were measured by titration using Kapp method, which is considered robust and reliable (Mota *et al.*, 2015).

## RESULTS AND DISCUSSION

From Phase 1 to Phase 7, when the operating parameters of the HR were set to 4.6 h HRT and 25.6 gCOD L<sup>-1</sup>d<sup>-1</sup> OLR, this reactor presented great stability during operation, constant production of hydrogen and organic acids. Despite affluent pH was 6.5, effluent pH was 2.7 on average. The highly acid environment did not harm the H<sub>2</sub> production, which was stable and in a high range, corresponded to volumetric hydrogen production rate (VHPR) of 175 mLH<sub>2</sub> L<sup>-1</sup>h<sup>-1</sup> and hydrogen yield (HY) of 3.4 mLH<sub>2</sub> per mol of sucrose consumed. Sucrose was removed by 81%, and most of acidified sucrose was converted to acetate (54.9% molar ratio), followed by lactate (25.4% molar ratio). Minor amounts were found of (molar ratio): butyrate (7.7%), propionate (7.7%), valerate (2.8%) and formate (1.4%).

Effluent pH values of MR and SMR were, respectively, 7.1 and 7.0, on average. Figure 2 shows the organic acid concentrations in MR and SMR. During Acclimation 1, SMR effluent showed lower concentrations of organic acids and higher concentrations of bicarbonate alkalinity (BA) than MR effluent. This is probably due to the lower OLR applied to the SMR compared to the OLR applied to HR+MR system (Table 1). The increased organic concentration in the feeding during Acclimation 2 caused organic acid concentration increase, especially in SMR, though the OLR did not change significantly. After acclimation, MR and SMR started to be fed with undiluted wastewater at the same OLR of the previous period; and an even greater increase in organic acid concentrations was observed during Phase 1, resulting in accumulation of acetate, propionate, butyrate and valerate. As organic acid levels were above 1000 mg L<sup>-1</sup>, which is the inhibitory threshold for the methanogenic archaea (Foresti

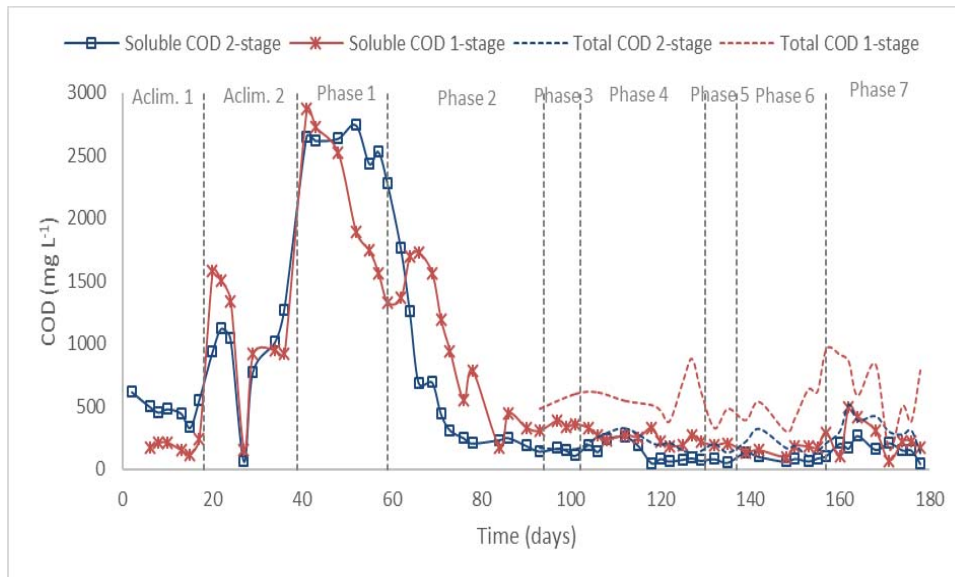
2002), in Phase 2 the OLR was reduced by increasing the HRT. This procedure was sufficient to recover the systems. From this stage, in which the flow rates were adjusted to keep OLR equally in two- and single-stage systems (Table 1), the MR started to show a better performance, as can be observed by its lower organic acid concentrations.



**Figure 2.** Total volatile acids (TVA) and acid species concentrations ( $\text{mg L}^{-1}$ ) in the MR and SMR during the beginning of operation (a) and after reaching a pseudo-steady state (b)

The OLR increase in Phases 3 and 4 did not impact on reactors' performance, revealing that the high concentrations of organic acid observed previously resulted from possible shock loading during the start-up and kinetic limitations. It is noteworthy that organic acid concentrations dropped substantially from Phase 3, achieving TVA concentrations lower than  $400 \text{ mgHAc L}^{-1}$ . In Phase 7, OLR in MR and SMR were increased by approximately 50%, wherein HR+MR system and the MR solely operated at  $6.4$  and  $7.8 \text{ gCOD L}^{-1}\text{d}^{-1}$  OLR, respectively, and SMR operated at  $5.2 \text{ gCOD L}^{-1}\text{d}^{-1}$  OLR. However, the impacts on treatment performance were mild, suggesting that methanogenic community was established in the reactors. Lactate, formate and (iso)valerate were no more detected, and (iso)butyrate was detected only in the SMR at very low concentrations ( $<11 \text{ mg L}^{-1}$ ). Especially in the SMR, acetate and propionate were detected in higher levels. Acetate accumulation suggests kinetic limitations of acetoclastic methanogenic archaea. Propionate degradation, in turn, can be hampered by relatively low concentrations of dissolved hydrogen and acetate, and hydrogen interspecies transfer limitations (Kim *et al.* 2002). It was demonstrated that during the stable periods (Phases 3 to 7), acid concentrations in MR effluent were below of those found in SMR effluent, even in the periods when the OLR applied in the two-stage system were the highest (Phases 5 to 7). These results suggest that the separation of anaerobic digestion phases reduced the problems related to kinetic, thermodynamic and mass transfer limitations, under the tested conditions.

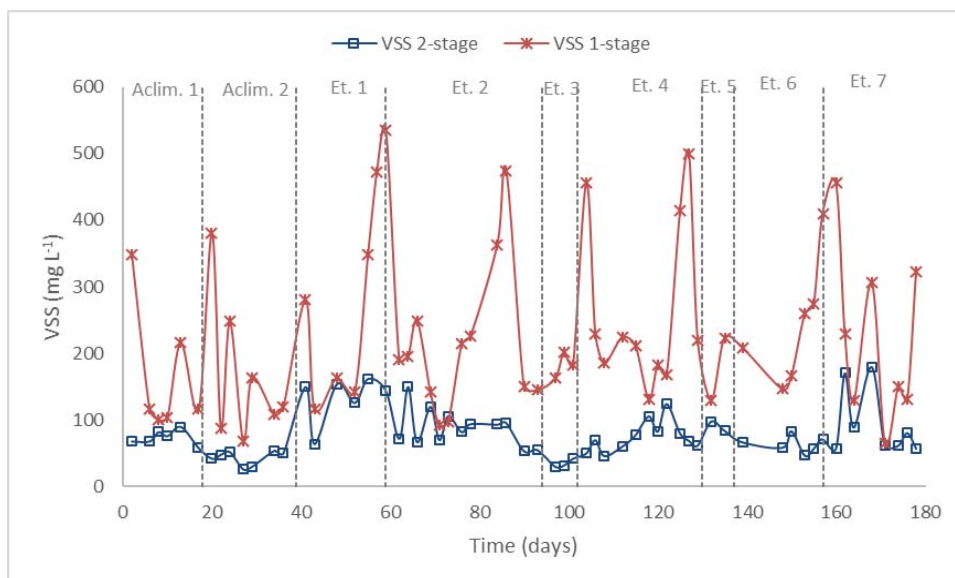
Effluent soluble COD levels during the whole operation period showed the same pattern observed for organic acid concentrations (Figure 3). During start-up, affluent dilution was not sufficient to achieve satisfactory performance and effluent COD levels were quite high: mean of  $484 \text{ mg L}^{-1}$  in MR and of  $184 \text{ mg L}^{-1}$  in SMR. The reduction in dilution rate from 5- to 3.3-fold during the period of Acclimation 2 resulted in even lower COD removal, and soluble effluent COD levels increased twice in MR (mean of  $1028 \text{ mg L}^{-1}$ ), and nine-fold in SMR (mean of  $1200 \text{ mg L}^{-1}$ ), except from day 25 to day 27, when MR and SMR were fed with only water and nutrients, to avoid acid accumulation.



**Figure 3.** Soluble COD levels in MR and SMR's effluents

The progressive OLR increase in MR by approximately 20% at each operational phase till Phase 6 did not affect its performance. The soluble and total COD removal in the two-stage system increased from 85.8% and 76.1%, during Phase 2, to 98.1% and 96.0%, during Phase 6, respectively. In these periods, soluble and total COD removal in the single-stage system were, respectively, 79.8% and 77.8% (Phase 2), and 96.8% and 89.9% (Phase 6). The higher OLR increase in Phase 7 caused a slight reduction in COD removal; total COD removal in two-stage system decreased from 96.0% to 93.4%, and in the SMR from 89.9% to 86.6%.

The higher total COD levels in effluent from the single-stage system resulted not only from soluble COD, but especially from particulate COD, i.e. total COD minus soluble COD, which was also verified by its high effluent VSS concentrations (Figure 4).

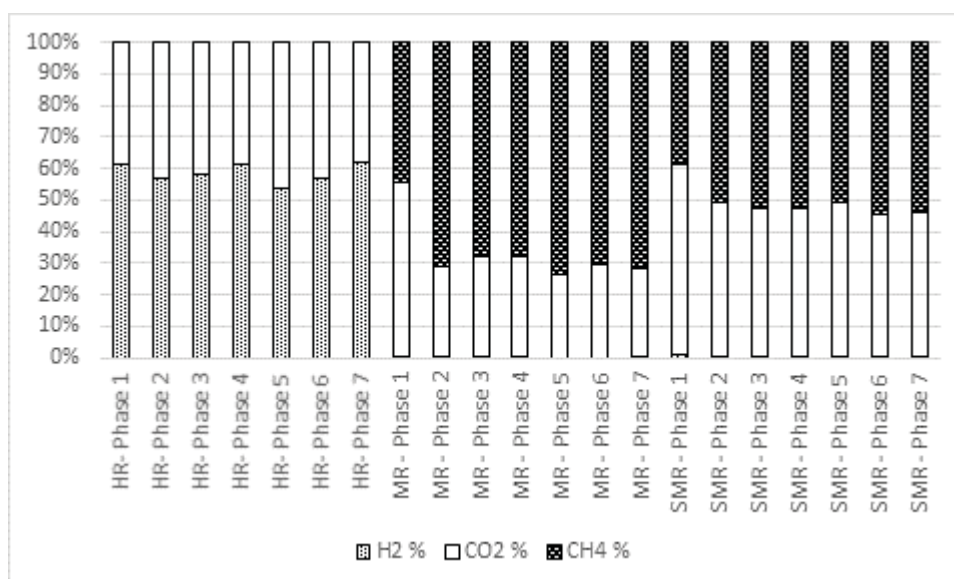


**Figure 4.** Volatile suspended solids in MR and SMR's effluents

The increased effluent VSS concentrations in the SMR ( $223 \pm 119 \text{ mg L}^{-1}$ ) are likely to be attributed to fast growth rates of acidogenic bacteria and extracellular polymeric substances (EPS) release, which are partially adhered to the microbial flocs. On the other hand, effluent VSS concentrations in the MR were much lower ( $80 \pm 36 \text{ mg L}^{-1}$ ), despite the high VSS

concentrations in its affluent, i.e. HR effluent ( $257 \pm 167 \text{ mg L}^{-1}$ ). It is believed that acidogenic bacteria from the HR partially undergo decay when they entered into MR, as a result of the low availability of non-acidified substrate, culminating in the stabilization of those bacteria as well as of the EPS and soluble microbial products (SMP) released by them. In contrast, in the SMR, since there was a constant inflow of non-acidified substrate, the acidogenic bacteria were continuously growing and releasing SMP and EPS, resulting in higher concentrations of COD and VSS in the effluent.

The suppression of methanogenesis in the HR was successfully achieved; no  $\text{CH}_4$  was detected in HR' biogas, which was  $\text{H}_2$ -rich (60%) (Figure 5). Biogas from the MR and the SMR was composed of  $\text{CH}_4$ ,  $\text{CO}_2$ , and, during the instability periods, traces of  $\text{H}_2$  (Figure 5). It is notable that from Phase 2,  $\text{CH}_4$  content in biogas of the MR kept much higher than that of the SMR, suggesting a higher calorific potential of the MR biogas. These results corroborate with other studies that compared two-stage to single-stage anaerobic digestion, wherein increased  $\text{CH}_4$  content was found in the methanogenic reactor fed with acidified wastewater (Ghosh *et al.*, 1985; Yeoh, 1997; Ghosh *et al.*, 2000). It is assumed that the occurrence of acidogenesis in a previous stage, in the HR, resulted in lower  $\text{CO}_2$  production by fermentative activity in the MR, resulting in higher  $\text{CH}_4$  content in its biogas.



**Figure 5.** Composition of biogas from HR, MR and SMR

For energy production potential evaluation in the two-stage system and single-stage system, it was analysed data from Phase 4, where the same OLR of  $3.5 \text{ gCOD L}^{-1}\text{d}^{-1}$  was applied in both systems, and data from Phase 7, when the systems operated at their maximum OLR, corresponded to  $6.4 \text{ gCOD L}^{-1}\text{d}^{-1}$  in the two-stage system and  $5.2 \text{ gCOD L}^{-1}\text{d}^{-1}$  in the SMR. In an attempt to normalize the input parameters, it was considered the added COD; and to display the results in units of energy, it was considered a calorific potential of 142 kJ per g of  $\text{H}_2$  and 50 kJ per g of  $\text{CH}_4$  (Nasr *et al.*, 2012). Under the conditions evaluated, the replacement of a single system by a two-stage system can result in energy yield increase around 25% (Phase 4) and 34% (Phase 7). Even if it is not considered the  $\text{H}_2$  recovery potential, the energy yield from the two-stage system was 7.7% and 20.7% higher in Phases 4 and 7, respectively, in relation to the single-stage system (Table 2). Similar results were obtained in the study by Luo *et al.* (2011), wherein the yield of the single-stage system was 11.8 kJ per g of VS added and in the two-stage system it was 13.1 kJ per g of VS added (12.4 kJ from  $\text{CH}_4$  and 0.7 kJ from  $\text{H}_2$ ).



Although the relatively low energy yield from H<sub>2</sub> production, that was from 10.3 to 14.3% of the total energy, a possible use of the H<sub>2</sub> is as combustion catalyst, rather than as an energy carrier. For this purpose, the biogas from acidogenic reactor can be mixed to the biogas from the methanogenic reactor, producing a mixture of CH<sub>4</sub>, CO<sub>2</sub> and H<sub>2</sub>. This mixture, sometimes called as bio-hythane, may offer advantages over conventional biogas (consisted of only CH<sub>4</sub> and CO<sub>2</sub>), such as improved combustion properties and reduced CO<sub>2</sub> and NO<sub>x</sub> emissions (Ghoniem 2011, Cavinato *et al.* 2012).

**Table 2.** Energy yields

Variable	Phase 4		Phase 7	
OLR (gCOD L <sup>-1</sup> d <sup>-1</sup> )	HR = 25.8, MR = 3.9, HR+MR = 3.5, SMR = 3.5		HR = 26.0, MR = 7.8, HR+MR = 6.4, SMR = 5.2	
Energy yield	HR+MR	SMR	HR+MR	SMR
kJH <sub>2</sub> kg <sup>-1</sup> COD <sub>added</sub>	2288.7	32.0	2138.8	122.7
kJCH <sub>4</sub> kg <sup>-1</sup> COD <sub>added</sub>	13729.5	12750.4	18549.6	15362.6
kJH <sub>2</sub> +CH <sub>4</sub> kg <sup>-1</sup> COD <sub>added</sub>	16018.2	12782.3	20688.4	15485.4
H <sub>2</sub> /Total energy yield	14.3%	0.3%	10.3%	0.8%
CH <sub>4</sub> / Total energy yield	85.7%	99.7%	89.7%	99.2%

## CONCLUSIONS

It was noteworthy that organic acids, soluble and total COD levels in the final effluent from the two-stage system remained lower than that from single-stage system, when the systems were operated under equal OLR and even when the two-stage system was operated under higher OLR. It is suggested that the separation of the stages led to lower growth of suspended acidogenic biomass and release of EPS in the methanogenic reactor, as evidenced by its substantially reduced VSS concentration. In the end of operation, effluent total COD was 317 mg L<sup>-1</sup> in the two-stage system, and 666 mg L<sup>-1</sup> in the single-stage system. The two-stage system also demonstrated a higher potential for bioenergy production. Biogas from the two-stage methanogenic reactor presented 70% methane, in contrast to biogas from the single-stage system that presented 52% methane. In addition, increased energy yields up to 34%, through methane and hydrogen production, were achieved in the two-stage system. These results demonstrate that the two-stage anaerobic treatment, when properly designed, can result in lower required reactor volumes, significantly better effluent quality, and higher energy potential recovery from wastewater.

## REFERENCES

- Cavinato C., Giuliano A., Bolzonella D., Pavan P., Cecchi F. 2012 Bio-hythane production from food waste by dark fermentation coupled with anaerobic digestion process: A long-term pilot scale experience. *International Journal of Hydrogen Energy*, **37**(15), 11549–11555.
- Cohen, A., Breure, A.M., Van Andel, J.G., Van Deursen, A. 1982 Influence of Phase Separation on the Anaerobic Digestion of Glucose, 2. Stability and Kinetic Responses to Shock Loadings. *Water Research*, **16**, 449-455.
- Foresti E. 2002 Anaerobic Treatment of Domestic Sewage: Established Technologies and Perspectives *Water Science and Technology*, **45**(10), 181–186.
- Ghoniem A.F. 2011 Needs, resources and climate change: clean and efficient conversion technologies. *Progress in Energy and Combustion Science*, **37**(1), 15-51.



- Ghosh S., Henry M.P., Sajjad A., Mensinger M.C., Arora J.L. 2000 Pilot-Scale Gasification of Municipal Solid Wastes by High-Rate and Two-Phase Anaerobic Digestion (TPAD). *Water Science and Technology*, **41**, 101-110.
- Ghosh S., Ombregt J.P., Pipyn P. 1985 Methane Production from Industrial Wastes by Two-Phase Anaerobic Digestion. *Water Research*, **19**(9), 1083-1088.
- Ke S., Shi Z., Fang H.H.P. 2005 Applications of Two-Phase Anaerobic Degradation in Industrial Wastewater Treatment. *International Journal of Environment and Pollution*, **23**, 65–80.
- Kim M., Ahn Y.H., Speece, R.E. 2002 Comparative process stability and efficiency of anaerobic digestion; mesophilic vs thermophilic. *Water Research*, **36**, 4369–4385.
- Lun S.Y., Wu J., Chen J. 1995 Anaerobic Waste Treatment: Efficient Separation of the Acid and Methane Forming Phases Using Two UASB Reactors. *Process Biochemistry*, **30**, 523-529.
- Luo G., Xie L., Zhou Q., Angelidaki I. 2011 Enhancement of bioenergy production from organic wastes by two-stage anaerobic hydrogen and methane production process. *Bioresource Technology*, **102**, 8700–8706.
- Mota V.T., Santos F.S., Araújo T.A., Amaral M.C.S. 2015 Evaluation of titration methods for volatile fatty acids measurement: effect of the bicarbonate interference and feasibility for the monitoring of anaerobic reactors. *Water Practice and Technology*, **10**(3), 486-495.
- Nasr, N.; Elbeshbishy, E., Hafez, H., Nakhla, G., El Naggar, M. H. 2012 Comparative Assessment of Single-Stage and Two-Stage Anaerobic Digestion for the Treatment of Thin Stillage. *Bioresource Technology*, **111**, 122-126.
- Rapport J., Zhang R., Jenkins B.M., Williams R.B. 2008 *Current Anaerobic Digestion Technologies Used for Treatment of Municipal Organic Solid Waste*, Report California Environmental Protection Agency
- Standards methods for the examination of water and wastewater* 2005 21st ed. American Public Health Association/ American Water Works Association/ Water Environmental Federation, Washington DC, USA.
- Yeoh B.G. 1997 Two-Phase Anaerobic Treatment of Cane-Molasses Alcohol Stillage. Anaerobic Digestion VIII. *Water Science and Technology*, **36**(6-7), 441-448.

# Evaluation of spatial alkalinities distribution in an up-flow fixed bed anaerobic digestion reactor

Maha Hmissi<sup>1,3</sup>, Victor Alcaraz-Gonzalez<sup>2</sup>, Jérôme Harmand<sup>3</sup>, Hedi Shayeb<sup>1</sup>

<sup>1</sup>Université de Tunis El Manar, École Nationale d'Ingénieurs de Tunis, Laboratoire de modélisation en Hydraulique et Environnement, B.P. 37, 1002 Tunis Le Belvédère, Tunisie. (e-mail: [maha.hmissi@hotmail.fr](mailto:maha.hmissi@hotmail.fr))

<sup>2</sup> Department of Chemical Engineering University of Guadalajara – CUCEI, Blvd. Gral. M. García Barragán 1451, 44430, Guadalajara, Jalisco, Mexico. (e-mail: [victor.alcaraz@cucei.udg.mx](mailto:victor.alcaraz@cucei.udg.mx))

<sup>3</sup> LBE, INRA, 11100, Narbonne, France. (e-mail: [jerome.harmand@inra.fr](mailto:jerome.harmand@inra.fr))

## Abstract

In this work, an experimental study of the hydrodynamic behaviour of a pilot-scale fixed bed up-flow anaerobic digestion process for the treatment of tequila vinasses, is carried out. This study takes into account the physicochemical phenomena concerning alkalinity. The experimental results confirm the existence of the theoretical expected spatial distribution for the VFAs, pH, alkalinity and bicarbonate along the axial reactor axis.

Keywords: Hydrodynamic; Up-flow fixed bed anaerobic digester; alkalinity; Tequila vinasses; Spatial distribution

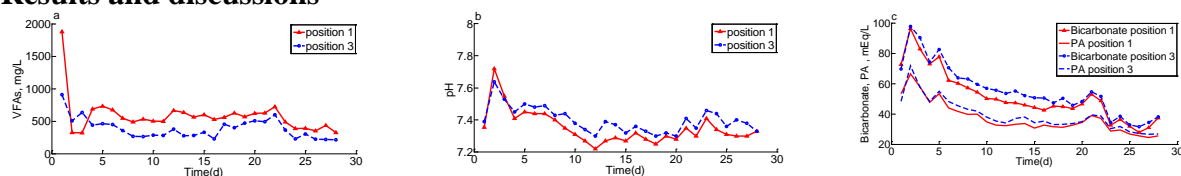
## Introduction

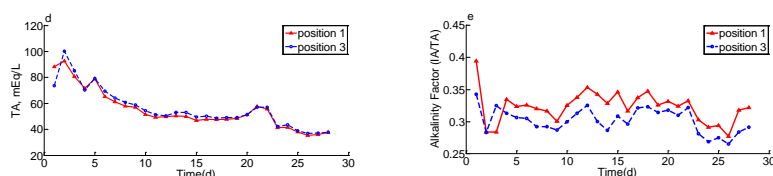
It is well known that pH control lonely, or Volatile Fatty Acids (VFA) control lonely are not enough for guaranteeing operational stability in anaerobic digestion (AD) processes. Actually, alkalinity control is needed (Alcaraz-Gonzalez et al. 2013; Steyer et al. 2002; Ripley et al. 1986). However, most of hydrodynamic studies in AD do not take into account the physicochemical phenomena concerning alkalinity, whose main components are bicarbonate and VFA. In the case of wastewaters with high buffering capacity, pH measurements may be rather not enough to indicate process changes and therefore they are not adapted for process supervision and control. Hence, monitoring and control of alkalinity becomes even more important than pH or VFA only. In this work, we present an experimental study of the hydrodynamic behavior species involved on alkalinities in an up-flow AD granular sludge fixed bed reactor for the treatment of tequila vinasses. Measurements of VFAs, pH, alkalinity and bicarbonate were obtained at three sampling points in the reactor.

## Materials and methods

The wastewater treated was raw tequila vinasses obtained from a tequila factory located at Guadalajara-Jalisco, Mexico. Experimental run was carried out in an AD up-flow fixed bed reactor of 445 L total volume. To monitor the substrate spatial distribution in the reactor, sampling devices were installed at three locations within the reactor. The three sampling devices were installed at heights of 25, 50.0, and 75.0 cm from the basis of the reactor corresponding to the bottom, the middle and the top.

## Results and discussions





**Figure 1. Dynamical behavior and spatial distribution into the up-flow fixed bed bioreactor: a) VFAs (mg/L), b) pH (dimensionless), c) Partial Alkalinity (PA) (mEq/L) and bicarbonate (mEq/L), d) Total Alkalinity (TA) (mEq/L), e) alkalinity factor (dimensionless).**

In this experiment, alkalinity actors are axially distributed in an up-flow fixed bed reactor. Figs.1a-e show experimentally the spatial distribution of alkalinity, bicarbonate, pH and total VFAs along the reactor height. Fig.1a shows that the distribution of total VFAs along the reactor height is experimentally observed, the gradient of VFAs decreased from the bottom to the top. Fig.1.b shows also the distribution of pH along the reactor height. The gradient of pH increases from position 1 to position 3 and the profile was observed from the bottom to the top. Moreover, for the bicarbonate and partial alkalinity (PA) we observed an increasing of gradient from position 1 to position 3. During the last week, measurements of bicarbonate and PA were very close (Zaher, 2002), and we observed a significant decrease of bicarbonate measurements, which was influenced by the decrease of VFAs in the same period. The combined effect of the decrease in these two variables; VFAs and bicarbonate was not only the decrease of total alkalinity (TA) itself but also a relative loss on the spatial distribution degree. In fact, during the last week TA was around 40 mEq/L, and its spatial distribution was effectively reduced. The alkalinity factor  $\alpha$  (IA/TA) with IA as the intermediate alkalinity, was maintaining around 0.3. In the last week  $\alpha$  inside the reactor was around 0.28 which indicates a good operational stability of the process. We observed also gradients of alkalinity factor along the reactor height.

## Conclusion

In this work, an experimental study has been carried out in order to assess the hydrodynamic behaviour in terms of spatial distribution in a fixed bed bioreactor of species involved in alkalinity. pH and VFA control are not enough for guaranteeing stability. Actually, alkalinity control is needed. TA was spatially distributed influencing the behavior of substrate inside the reactor.

## Acknowledgements

The authors gratefully acknowledge the TREASURE research network for its financial support (cf [www.inra.fr/treasure](http://www.inra.fr/treasure)).

## References

- Alcaraz-González, V., Fregoso-Sánchez, F. A., Méndez-Acosta, H. O., and González-Álvarez, V. (2013). Robust Regulation Of Alkalinity In Highly Uncertain Continuous Anaerobic Digestion Processes. *CLEAN – Soil, Air, Water*. 41(12), 1157- 1164.
- Steyer, J. P., Bouvier, J. C., Conte, T., Gras, P., Harmand, J., and Delgenes J. P. (2002). On-line measurements of COD, TOC, VFA, total and partial alkalinity in anaerobic digestion process using infra-red spectrometry, *Wat. Sci. Technol.* 45(10),133–138.
- Ripley, L., Boyle, W., and Converse, J. (1986) Improved alkalimetric monitoring for anaerobic digestion of high-strength wastes. *Journal of Water Pollution Control Federation* 58, 406–411
- Zaher, U., Bouvier, J. C., Steyer, J. P., and Vanrolleghem P. A. (2002). Titrimetric Monitoring of Anaerobic Digestion: VFA, Alkalinities and more. ICA2002 IWA Conference

# Post-treatment of UASB effluent by phototrophic reactors for sulphide and organic matter removal

Ref # S2SMALL-04741

Azevedo, L. S.<sup>1</sup>, Castro, I. M. P.<sup>1</sup>, Santos, L. A.<sup>1</sup>, Leal, C. D.<sup>1</sup>, Araújo, J. C.<sup>1</sup>, Chernicharo, C. A. L.<sup>1\*</sup>

<sup>1</sup>Federal University of Minas Gerais, Department of Sanitary and Environmental Engineering, Av. Antônio Carlos 6.627, Campus Pampulha, 31.270-901 - Belo Horizonte - MG - Brazil.

\* Presenting Author: calemos@desa.ufmg.br

**Abstract:** Two phototrophic bioreactors were investigated as an alternative to post-treat effluent from an UASB reactor treating domestic sewage, aiming at sulphide oxidation to elemental sulphur and complementary organic matter removal. The bioreactors were operated at different hydraulic retention times and presence or absence (control) of packing material for biomass retention. Greater sulphide removal efficiencies were achieved in both reactors for HRT of 6 h, 75% and 92% for the control reactor and packed reactor, respectively. Higher organic matter (COD) and solids (TSS) removal were observed in the packed reactor, able to produce a final effluent with low COD and TSS concentrations (100 mgCOD.L<sup>-1</sup> and 30 mgTSS.L<sup>-1</sup>). Denaturing gradient gel electrophoresis results revealed that purple and green biomass developed in both reactors and comprised a diverse bacterial community with sequences related to phototrophic sulphur bacteria such as *Thiocapsa* and *Chlorobaculum*. Elemental Sulphur formation was detected and the potential for Sulphur recovery was observed. The phototrophic bioreactors were able to improve the quality of the anaerobic effluent and higher efficiencies related to the packed reactor were attributed to the presence of the packing material and higher cell retention time.

**Keywords:** post-treatment, phototrophic bioreactors, sulphide oxidation, UASB reactor.

## INTRODUCTION

UASB reactors have been widely adopted for sewage treatment in many warm climate countries. Despite several advantages attributed to the system, some limitations still remain such as mal-odour emission and the need of a post-treatment unit for additional organic matter and nutrient removal (i.e. nitrogen, phosphorous and sulphur), in order to reduce the discharge impact of effluents on receiving waters (Chernicharo *et al.* 2015). Odour emission in anaerobic-based sewage treatment plants is mainly related to the release of dissolved sulphide present in the bulk liquid, especially in the outlet structures where turbulent conditions prevail (Souza *et al.* 2012). Along with its characteristic offensive odour, H<sub>2</sub>S has several negative effects such as toxicity, corrosivity and flammability (USEPA 2010).

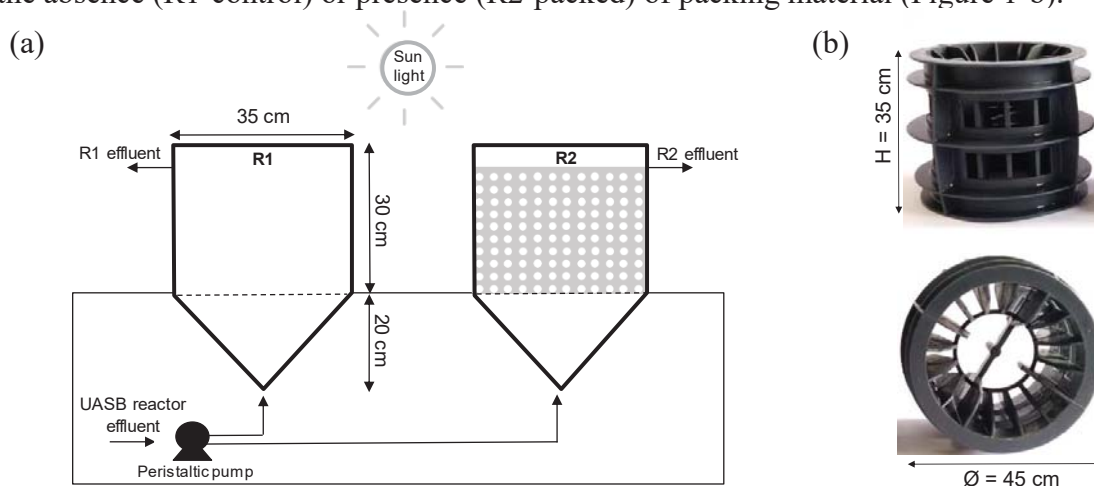
Strategies for sulphide control involve either inhibition of H<sub>2</sub>S production or elimination of the produced gas (Garcia de Lomas *et al.* 2005). Sulphide oxidation may occur by biological or chemical pathways, however, biological process has major advantages such as low cost and high efficiency, achieving less than 1 mg.L<sup>-1</sup> of sulphide concentration in the effluent (Henshaw *et al.* 1999). Biological sulphide oxidation in liquid or gas streams may occur through the activity of phototrophic or chemolithotrophic bacteria, under aerobic, anoxic or anaerobic conditions. Sulphide-oxidizing bacteria are grouped according to the used sulphur compound, colour and environmental conditions. Aerobic sulphide oxidation is performed by colorless sulphur bacteria while anaerobic oxidation occurs by means of anoxygenic photosynthesis, performed by green and purple bacteria that use light as energy source in anoxic environments (Madigan 2010). Although advantages of biological process have been reported, the scale up of phototrophic reactors is not straight forward due to the requirement of transparent material to allow light entrance (Janssen *et al.* 1999).

Previous studies have investigated the biological oxidation of sulphide to elemental sulphur (Vannini *et al.* 2008; Fajardo *et al.* 2012; Liu *et al.* 2015), however, information regarding the removal of dissolved sulphide using real anaerobic effluent and bacteria naturally present in it are scarce. In this study, two phototrophic bioreactors were investigated as an alternative to post-treat effluent from an UASB reactor treating domestic sewage, aiming at sulphide oxidation to elemental sulphur and complementary organic matter removal. Partial sulphide oxidation to elemental sulphur is of particular interest due the possibility of elemental sulphur recovery. The phototrophic bioreactors were designed with a shape similar to the settler compartment of a UASB reactor and operated under conditions comparable to real scale. Therefore, results obtained in this work may be used to optimize reactor operational conditions, in order to favour elemental sulphur formation and to improve the overall performance of the phototrophic bioreactors.

## MATERIALS AND METHODS

### Experimental set-up

The experiments were performed in a system comprised by a pilot-scale UASB reactor built in fibreglass (340 L) followed by two Plexiglas bioreactors (30 L) operating in parallel, designed to oxidise dissolved sulphide present in the UASB reactor effluent. The phototrophic reactors were designed to be fed from the bottom (upflow mode), with a configuration similar to the settler compartment of UASB reactors: cone-shaped bottom ( $h=20\text{cm}$ ) and cylindrical chamber ( $h=30\text{cm}$ ), as shown in Figure 1 (a). The Plexiglas reactors were identical, except for the absence (R1-control) or presence (R2-packed) of packing material (Figure 1-b).



**Figure 1.** Schematic representation and dimensions of the (a) bioreactors and (b) packing material.

The set-up was installed at the Centre for Research and Training in Sanitation UFMG/COPASA, located at the Arrudas WWTP, the main treatment plant of Belo Horizonte city, Brazil (coordinates  $19^{\circ}53'42''$  S and  $43^{\circ}52'42''$  W, altitude 800 m). The pilot-scale UASB reactor was fed with an aliquot of the raw sewage that feeds the full-scale plant, after being submitted to preliminary treatment for solids and grit removal. The main characteristics of the typical urban wastewater were:  $\text{pH} = 7.5$ ;  $\text{COD} = 516 \text{ mg.L}^{-1}$ ;  $\text{S}^{2-} = 0.5 \text{ mg.L}^{-1}$ ;  $\text{SO}_4^{2-} = 32 \text{ mg.L}^{-1}$ .

The bioreactors were monitored over 7 months under distinct operational conditions, according to the following hydraulic retention time (HRT): 6 h, 4 h and 2 h. Throughout the monitoring period, redox potential and pH inside the reactors ranged between  $-68 \text{ mV}$  and  $-110 \text{ mV}$  (Standard hydrogen electrode) and 6.8 - 7.1, respectively. At the end of each phase,



the reactors were emptied and the packing material replaced. R2-packed was equipped with a perforated stainless-steel basket, in order to retain the polypropylene rings ( $\text{\O} 45 \text{ mm}$ ,  $h= 35 \text{ mm}$ ,  $86 \text{ m}^2/\text{m}^3$  specific surface – *Bio Project*, Brazil), used as packing material (Figure 1-b). The adoption of packing material intended to provide higher retention of microorganisms naturally present in the UASB reactor effluent once the phototrophic reactors were not inoculated.

### Physicochemical analysis

Sulphate ( $\text{SO}_4^{2-}$ ), total suspended solids (TSS) and chemical oxygen demand (COD) were measured according to the standard methods (APHA, 2012). Sulphide was measured according to Plas *et al.* (1992) and elemental sulphur ( $\text{S}^0$ ) by high performance liquid chromatography (HPLC) using a PRP-1 reverse phase HPLC column (dimensions:  $15 \text{ cmL} \times 4.1 \text{ mmID}$ ), as described by Henshaw *et al.* (1998). Analyses were performed twice a week except for TSS and  $\text{S}^0$ , which were analyzed once a week.

### Analysis of the microbial community

At the end of each phase, samples were collected from the microbial layer (attached and non-attached biomass) and sludge (bottom of the reactors) aiming to allow the comparison of bacterial diversity for all tested HRT. Cells were taken from several polypropylene rings located at different heights to provide a representative sample. Samples were centrifuged three times (4000 rpm for 10 minutes) and washed with phosphate buffer saline solution (1x PBS, NaCl,  $\text{Na}_2\text{HPO}_4$ ,  $\text{NaH}_2\text{PO}_4$ ,  $\text{pH} = 7.2\text{-}7.4$ ). The supernatant was discharged and the pellets were stored at  $-20^\circ\text{C}$ . DNA was extracted using *PowerSoil DNA Isolation Kit* (MO BIO Laboratories, E.U.A.). Polymerase chain reaction and denaturing gradient gel electrophoresis (PCR-DGGE) was performed using the primer set 1055F and 1392R with a GC clamp according to Ferris *et al.* (1996). DGGE was performed at  $60^\circ\text{C}$  in  $0.5\times\text{TAE}$  buffer at 80 V for 16,5h using a DCode system (Bio-Rad Universal Mutation Detection, (Hercules, CA, USA) comprising 8% polyacrylamide gel with a 50–65% gradient of urea formamide denaturant. Gels were stained with SYBR Gold solution (Life Technologies) and visualized under UV transillumination. Specific gel bands were excised, re-amplified, purified, and sequenced using a genomic service (Macrogen Inc., Seoul, Korea). Sequences were compared with that from *Ribosomal Database Project* (<https://rdp.cme.msu.edu/classifier/classifier.jsp>) and National Center for Biotechnology Information (NCBI) database. DGGE patterns were analysed using BioNumerics software 6.6 and the Shannon Index (Gafan *et al.* 2005) was employed to assess bacterial biodiversity in biomass and sludge under the tested conditions.

## RESULTS AND DISCUSSION

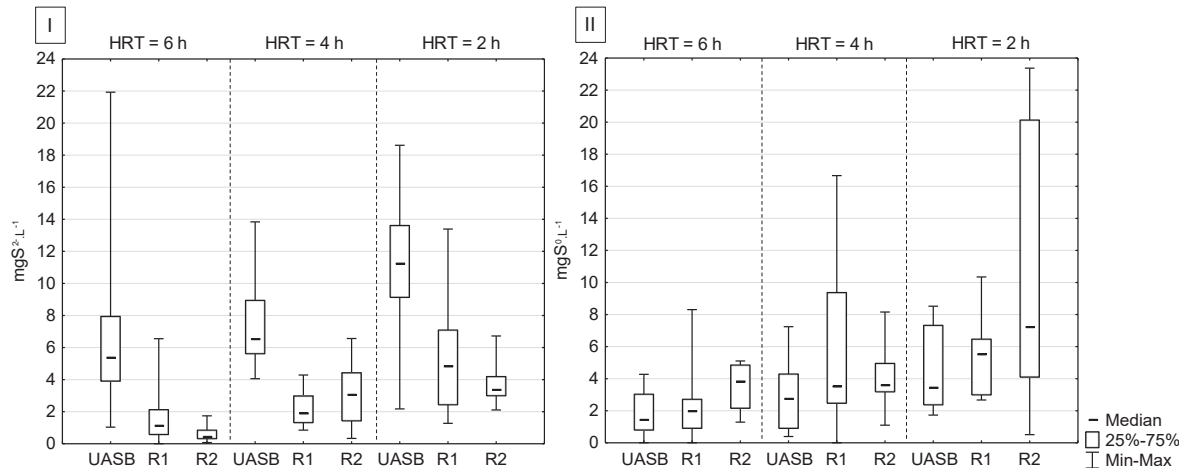
### Biological sulphide oxidation

Dissolved sulphide and elemental sulphur concentrations in the effluent of the UASB reactor and phototrophic bioreactors are shown in Figure 2. Dissolved sulphide values observed in the UASB reactor effluent,  $5 - 11 \text{ mgS}^{2-}.\text{L}^{-1}$ , were similar to those obtained by Souza *et al.* (2012),  $7 - 11 \text{ mgS}^{2-}.\text{L}^{-1}$ , and higher than those observed by Garcia *et al.*, (2017),  $2 - 3 \text{ mgS}^{2-}.\text{L}^{-1}$ . These studies investigated anaerobic reactors treating domestic wastewater from the same contribution region.

Sulphide median concentration in the UASB reactor effluent was higher for the operational period at 2h HRT,  $11,3 \text{ mgS}^{2-}.\text{L}^{-1}$ , as compared to the previous phases, HRT of 6 and 4 h ( $5.4$  and  $6.6 \text{ mgS}^{2-}.\text{L}^{-1}$ ). Due to this huge variation between phases, removal efficiencies instead of absolute concentrations values were used to compare the results. Higher sulphide removal



efficiencies were observed for both bioreactors for HRT of 6h, 75% for R1-control and 92% R2-packed. Garcia *et al.* (2017) reported sulphide removal efficiencies between 50 - 60%, for the same HRT. This lower efficiency could be related to median sulphide concentration in the UASB reactor effluent,  $2 \text{ mgS}^{2-} \cdot \text{L}^{-1}$ , 63% lower than the one determined in this study,  $5.4 \text{ mgS}^{2-} \cdot \text{L}^{-1}$ . Sulphide effluent concentrations of the phototrophic bioreactors were 1.2, 2.0 and  $4.9 \text{ mgS}^{2-} \cdot \text{L}^{-1}$  for R1-control, and 0.5, 3.1 and  $3.4 \text{ mgS}^{2-} \cdot \text{L}^{-1}$ , for HRT of 6, 4 and 2 h, respectively.



**Figure 2.** (I) Dissolved sulphide and (II) Elemental sulphur concentrations in the effluent of the UASB reactor and phototrophic bioreactors. R1-control, R2-packed with polypropylene rings.

Among the studied conditions, higher sulphate concentrations were observed in R1-control effluent, pointing that the absence of packing material favoured sulphide oxidation to sulphate, with median concentrations of  $40.2$ ,  $27.0$  and  $28.1 \text{ mgSO}_4^{2-} \cdot \text{L}^{-1}$  for 6, 4 and 2h of HRT, respectively. Although R2-packed effluent showed higher sulphide oxidation under 6 and 2 h HRT conditions, the same did not occur regarding sulphate formation, with median concentrations of  $28.0$  and  $24.1 \text{ mgSO}_4^{2-} \cdot \text{L}^{-1}$ , possibly due the greater formation of elemental sulphur provided by the use of packing material.

Since biologically produced elemental sulphur has a white or yellow-pale colour (Janssen *et al.* 1999), the formation of this compound was observed from the white precipitate present in the effluent of the phototrophic reactors and confirmed by high performance liquid chromatography. The white precipitate observed in the R2-packed effluent corresponding to extracellular sulphur is presented in Figure 3 (I-II), whereas intracellular stored sulphur is presented in Figure 3-III.

Regarding elemental sulphur formation, higher concentrations were observed in R2-packed effluent for all tested HRT, even when higher sulphide removal efficiency was associated to R1-control (see Figure 2-II). Elemental sulphur concentrations in the R1-control effluent were  $2.0$ ,  $3.6$  and  $5.6 \text{ mgS}^0 \cdot \text{L}^{-1}$ , while higher concentrations were observed in the R2-packed effluent,  $3.8$ ,  $3.6$  and  $7.3 \text{ mgS}^0 \cdot \text{L}^{-1}$ , for HRT of 6, 4 and 2h, respectively. The greatest sulphur formation was related to R2-packed, suggesting that the presence of polypropylene rings provided longer cellular retention time and favoured elemental sulphur formation.

It is possible to observe, from Figure 2-II, that elemental sulphur was produced in the UASB reactor, probably in the settling compartment. Green and purple colours were observed in the phototrophic reactors possibly due the existence of naturally occurring sulphur bacteria in the UASB reactor effluent. Therefore, considering sun light penetration into the upper part of the reactor (uncovered settling compartment) it is possible to assume that the elemental sulphur in the UASB reactor effluent is related to sulphur bacteria activity, located in the reactor scum

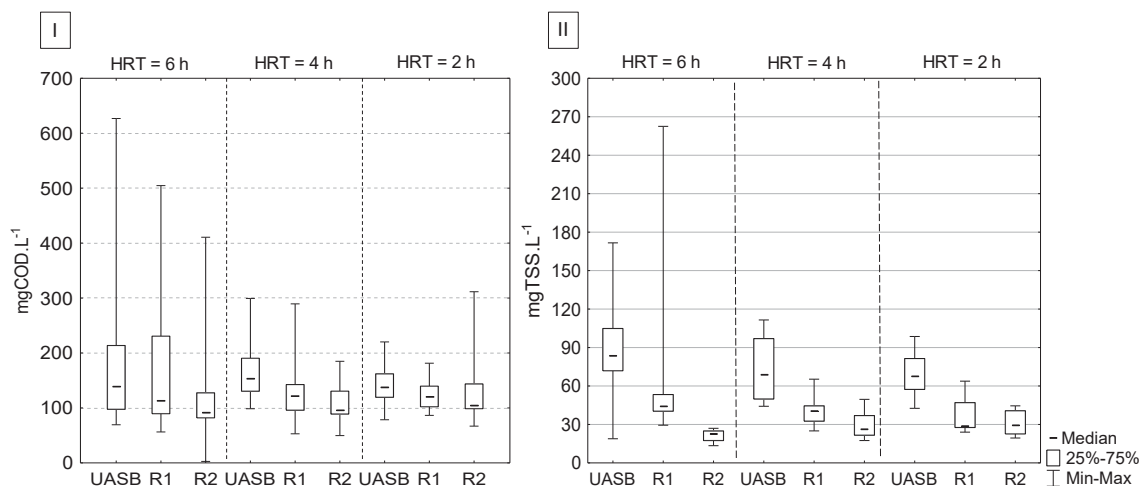
layer, naturally formed and maintained on the surface of the settler compartment of the UASB reactor.



**Figure 3.** (I) Settling test of R2-packed effluent (HRT = 6h) after 30 minutes, with white solids at the bottom of the Imhoff cone; (II) white precipitate present in the R2-packed effluent; (III) microscopic image of purple bacteria in R2-packed biomass (HRT = 4h), emphasizing intracellular elemental sulphur.

### Overall performance of the system

The overall performance of the system for the parameters COD and TSS is depicted in Figure 4. Regarding COD, higher median removal efficiency was observed for R2-packed, about 40% for HRT of 6 and 4h, as compared to around 28% observed for R1-control for HRT of 4 h. R1-control median effluent COD concentrations were 113.2, 122.3 and 120.7 mgCOD.L<sup>-1</sup>, whereas lower concentrations were observed for R2-packed, 91.5, 96.0 and 104.4 mgCOD.L<sup>-1</sup>, for HRT of 6, 4 and 2h, respectively.



**Figure 4.** Concentrations of (I) COD and (II) TSS in UASB and phototrophic reactors effluent at different operational conditions (HRT = 6, 4 and 2 h).

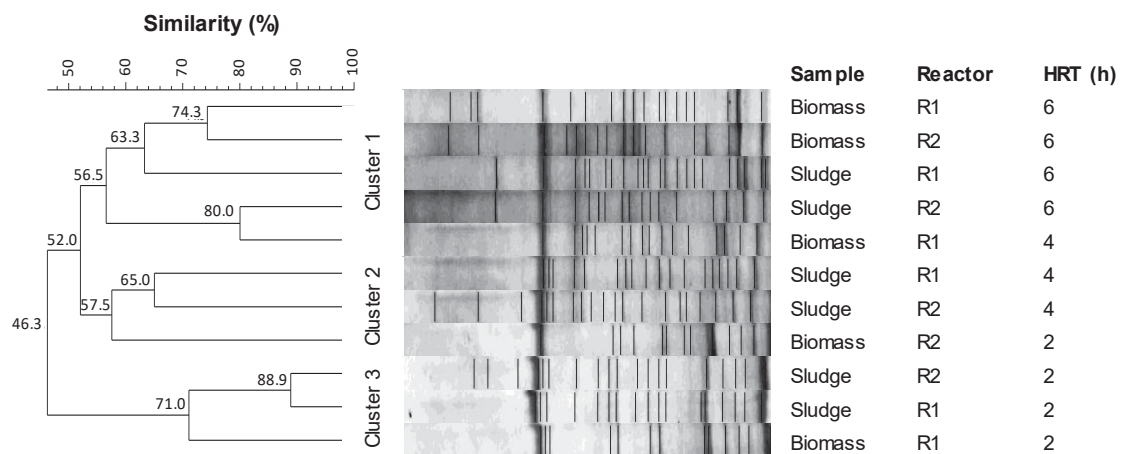
Considering TSS, lower concentrations were observed in the R2-packed effluent for HRT of 6h and 4h, 22.8 and 26.4 mgTSS.L<sup>-1</sup>, while 40.5 and 44.7 mgTSS.L<sup>-1</sup> were observed in the R1-control effluent. For the lower HRT (2h), the TSS concentration was around 29 mgTSS.L<sup>-1</sup> for both bioreactors, indicating that the higher flowrate induced the loss of biomass attached to the polypropylene rings. For this operational condition the presence of packing material did not contribute to increase the solids retention capacity of R2-packed.

Higher COD removal efficiencies and TSS retention were observed in the R2-packed, which was able to produce a final effluent with low COD and TSS concentrations, close to 100 mgCOD.L<sup>-1</sup> and 30 mgTSS.L<sup>-1</sup>, therefore able to comply with restrictive discharge standards.

### Effect of packing material on microbial diversity

Bacterial community diversity of biomass and sludge was evaluated at the end of each phase by PCR-DGGE technique. The comparison of DGGE profiles was performed by the dendrogram showed in Figure 5, which reports the similarity between the profiles. DNA extraction of biomass was not successful and for this reason it was not included in the following stages. DGGE results revealed that bacterial community was diversified in the bioreactors, between, different operational conditions, and three major and distinct clusters were identified according to the tested HRT (showing 57-71% similarity). Except for HRT of 6h, with 74,3% of similarity between biomass, the profiles of microbial diversity observed for the others HRT were different.

The lowest similarity of biomass was observed for HRT of 2 h, 46%. Regarding sludge bacterial composition, R1-control and R2-packed showed lower similarities for 6 and 4 h HRT, 57 and 65%, respectively. The highest similarity observed in the dendrogram were related to sludge samples under 2h HRT conditions. The difference between the profiles of the reactors suggests that the presence of the packing material in R2-packed and absence in R1-control affected both sludge and biomass bacterial community. Sludge and biomass of R1-control presented similarity between 52- 71%, while the samples of R2-packed showed lower similarity, 46-57%. Among the values observed for sludge and biomass, lowest similarity was observed to R2-packed (46%) for HRT of 2h, indicating that the presence of the packing material favoured distinct bacterial compositions between sludge and biomass.



**Figure 5.** Dendrogram based on the DGGE profiles of the bacterial community in biomass and sludge samples collected at different operational conditions (HRT = 6, 4 and 2h).

The similarity in the dendrogram was confirmed by the Shannon diversity index, used to estimate bacterial diversity of biomass (attached and non-attached) and sludge (bottom of the reactors) samples ranged from 1.05 to 1.29, indicating that the decrease of HRT did not expressively affect the microbial diversity. Concerning the sludge index, higher values were observed, 1.18-1.29, when compared to biomass index, 1.05-1.20. Although similar, it is possible to note that both biomass and sludge presented higher diversity for HRT of 6h, except for sludge under 4h HRT condition.

### Microbial community in the phototrophic reactors determined by sequencing

Sequences similar to several bacteria genera were identified by sequencing the strongest bands in the DGGE gel. DNA sequences similar to *Anaerolineaceae* (likely *Anaerolinea* genus) were identified in the sludge of R2-packed (6h and 2h HRT) and R1-control (4h). This genus consists of fermentative hydrolytic bacteria, possible associated to the degradation of organic matter present in the UASB reactor effluent (Hug *et al.*, 2013).

Sequences related to *Rhodopseudomonas* and *Rhodocyclus*, purple non-sulphur bacteria, were identified in the biomass of R1-control (6h HRT) and R2-packed (2h HRT) and in the sludge of R1-control (4h HRT). *Rhodopseudomonas palustris*, a phototrophic bacteria with versatile metabolism and capable of organic matter degradation (Madigan, 2010), was identified in the biomass of R2-packed (2h HRT). DNA sequences similar to *Spirulina* genus, a strong band present in all the samples from both reactors, is related to filamentous cyanobacteria. Phototrophic sulphur bacteria and cyanobacteria may coexist, due to sulphur bacteria oxygen tolerance (Stal 1995).

Sequences similar to sulphur bacteria, *Thiocapsa*, *Chlorobaculum*, *Sulfurimonas* and *Sulfuricella*, were identified in sludge and biomass of R1-control (6h HRT). Purple Sulphur bacteria from *Thiocapsa* genus perform anoxygenic photosynthesis, using H<sub>2</sub>S as an electron donor to produce intracellular elemental sulphur. Purple bacteria and intracellular sulphur were observed (Figure 3-III), corroborating that sulphur bacteria occurred at different HRT. *Chlorobaculum* sequences, which is a green sulphur bacteria, were identified in the biomass of R1-control for HRT of 4h. The main advantage attributed to green bacteria is related to extracellular elemental sulphur formation (Madigan, 2010). Although *Chlorobaculum* genus was identified specifically in one band from R1-control, the occurrence of extracellular elemental sulphur in the phototrophic reactors effluent was verified throughout monitoring.

Even though the sequencing of all DGGE bands was not accomplished, the presence of phototrophic sulphur bacteria was verified in most of the DGGE profiles (bands in similar position were sequenced); thus suggesting that phototrophic sulphur bacteria occurred in all operational conditions.

## CONCLUSIONS

The results demonstrated that the phototrophic bioreactors were able to improve the quality of the effluent from the UASB reactor, regarding suspended solids removal/retention, COD removal, biological sulphide oxidation. The higher efficiencies related to R2-packed are likely due to the presence of the packing material and higher cell retention time. Higher sulphide removal efficiencies were obtained for the HRT of 6 h (R1-control: 78% and R2-packed: 92%) although higher elemental sulphur production was obtained for the lowest HRT (2 h), with median effluent concentrations of 5.5 and 7.3 mgS<sup>0</sup>.L<sup>-1</sup>, respectively for R1-control and R2-packed. Higher COD removal efficiencies and TSS retention were observed in the R2-packed reactor, which was able to produce a final effluent with low COD and TSS concentrations, (100 mgCOD.L<sup>-1</sup> and 30 mgTSS.L<sup>-1</sup>), therefore able to comply with restrictive discharge standards. Microbial diversity in the phototrophic reactors was diverse and similar. Sulphur bacteria were detected and identified, demonstrating the occurrence of biological sulphide oxidation in the reactors. Elemental Sulphur formation and the potential for Sulphur recovery were observed.

## ACKNOWLEDGEMENTS

The authors would like to acknowledge the support obtained from the following Brazilian institutions: Conselho Nacional de Desenvolvimento Científico e Tecnológico – CNPq; Coordenação de Aperfeiçoamento de Pessoal de Nível Superior – CAPES; Financiadora de Estudos e Projetos – Finep; Fundação de Amparo à Pesquisa do Estado de Minas Gerais – FAPEMIG; Instituto Nacional de Ciência e Tecnologia em Estações Sustentáveis de Tratamento de Esgoto – INCT ETEs Sustentáveis (INCT Sustainable Sewage Treatment Plants). We also acknowledge the support from Copasa.



## REFERENCES

- Chernicharo C. A. L., Van Lier J. B., Noyola A. & Ribeiro T. B. 2015 Anaerobic sewage treatment: state of the art, constraints and challenges. *Environ Sci Biotechnol*, 14, 649–679.
- Fajardo C., Corral-mosquera A., Campos J. L. & Méndez R. 2012. Autotrophic denitrification with sulphide in a sequencing batch reactor. *Journal of Environmental Management*, 113, 552-556.
- Ferris M. J., Muyzer G & Ward D. M. 1996 Denaturing gradient gel electrophoresis profiles of 16S rRNA-defined populations inhabiting a hot spring microbial mat community. *Appl Environ Microb.*, 62, 340–346.
- Gafan G.P., Lucas V.S., Roberts G.J., Petrie A., Wilson M. & Spratt D.A. 2005 Statistical analyses of complex denaturing gradient gel electrophoresis profiles. *J. Clin. Microbiol.*, 43, 3972–3978.
- Garcia de Lomas J., Corzo A., Gonzalez J. M., Andrades J.A., Iglesias, E. & Montero, M. J. 2005 Nitrate promotes biological oxidation of sulfide in wastewater: experiment at plant-scale. *Biotechnology and Bioengineering*, 93(4), 801–811.
- Garcia G. P. P., Diniz R. C. O., Bicalho S. K., Franco V., Pereira A. D., Brandt E. F., Etchebehere C., Chernicharo C. A. L., Araujo J. C. 2017 Microbial community and sulphur behaviour in phototrophic reactors treating UASB effluent under different operational conditions. *International Biodeterioration and Biodegradation*, 119, 486-498.
- Henshaw P. F., Bewtra J. K. & Biswas N. 1998 Hydrogen sulphide conversion to elemental sulphur in a suspended-growth continuous stirred tank reactor using *Chlorobium limicola*. *Water Res.*, 32(6), 1769- 1778.
- Hug L. A., Castelle C. J., Wrighton K. C., Thomas, B. C., Sharon, I., Frischkorn, K. R., Williams K. H., Tringe S. G., Banfield, J. F. 2013 Community genomic analyses constrain the distribution of metabolic traits across the *Chloroflexi* phylum and indicate in sediment carbon cycling. *Microbiome*, 1(22), 1-17.
- Janssen A. J. H., Lettinga G. & Keiser A. 1999 Removal of hydrogen sulfide from wastewater and waste gases by biological conversion to elemental sulfur. Colloidal and interfacial aspects of biologically produced sulphur particles. *Elsevier*, 151, 389-397.
- Liu C., Zhao D., Yan L., Wang A., Gu Y. & Lee D. 2015 Elemental sulfur formation and nitrogen removal from wastewaters by autotrophic denitrifiers and anammox bacteria. *Bioresource Technology*, 191, 332–336.
- Madigan M. T., Martinko J. M. & Parker, J. 2010 *Brock biology of microorganisms*. Prentice-Hall, 3rd ed., 1155 p.
- Plas C., Harant H., Danner H., Jelinek E., Wimmer, K., Holubar P. & Braun, R. 1992 Ratio of biological and chemical oxidation during the aerobic elimination of sulphide by colourless Sulphur sulphur bacteria. *Applied Microbiology and Biotechnology*, 36(6), 817-822.
- Souza C. L.; Chernicharo C. A. L. & Melo, G. C. B. 2012 Methane and hydrogen sulfide emissions in UASB reactors treating domestic wastewater. *Water Science & Technology*. 65 (7), 1229-1237.
- Stal L. J. 1995 Physiological ecology of cyanobacteria in microbial mats and other communities. *New Phytol*, 131, 1-32.
- Standard Methods for the Examination of Water and Wastewater* 2012 22th edn, American Public Health Association/American Water Works Association/Water Environment Federation, Washington DC, USA.
- United States Environmental Protection Agency* 2010 Acute Exposure Guideline Levels for Selected Airborne Chemicals. Washington DC, USA, 462 p.
- Vannini C., Munz G., Mori G., Lubello C., Verni, F. & Petroni, G. 2008 Sulphide oxidation to elemental sulphur in a membrane bioreactor: Performance and characterization of the selected microbial sulphur- oxidizing community. *Systematic and Applied Microbiology*, 31, 461-473.

# Acclimation of mesophilic granular sludge for the anaerobic digestion of agroindustrial effluents under thermophilic conditions

Ivonne Figueroa-González<sup>1</sup>, Gloria Moreno<sup>1</sup>, Julián Carrillo-Reyes<sup>1</sup>, Guillermo Quijano<sup>1,2</sup>, Arturo Sánchez<sup>3</sup>, Germán Buitrón<sup>1</sup>

<sup>1</sup>Laboratory for Research on Advanced Processes for Wastewater Treatment, Engineering Institute - Juriquilla Academic Unit, National Autonomous University of Mexico (UNAM), Blvd. Juriquilla 3001, Querétaro 76230, Mexico.

<sup>2</sup>CONACYT-Engineering Institute – Juriquilla Academic Unit, National Autonomous University of Mexico (UNAM).

<sup>3</sup>IPN (CINVESTAV) – Advanced Engineering Unit Guadalajara, Zapopan, Jalisco, Mexico

**Keywords:** Anaerobic digestion; biomethane potential; biorefineries effluents; granular sludge; thermophilic conditions

## Introduction

Production of liquid biofuels such as bioalcohols from agricultural residues is nowadays attracting worldwide interest due to the increasing demand for renewable energy sources. However, biorefineries must deal with the challenge of treating efficiently their effluents, which are rich in simple sugars, lignin, traces of bioalcohols, ashes, among others (Kaparaju et al., 2009). Anaerobic digestion (AD) might become the reference technology for the treatment of biorefinery effluents owing to its relatively simple design and low capital/operating costs (Kaparaju et al., 2009). An additional motivation to treat biorefinery effluents by means of AD is the potential generation of CH<sub>4</sub>, another renewable energy source (Ryan et al. 2009). The operating temperature has a strong influence on key physicochemical parameters and microbiological processes in the AD technology. In fact, under thermophilic conditions (~55°C) the pumping and mixing performance in the digester is more efficient, enhancing the CH<sub>4</sub> production (Alqaralleh et al., 2016). Enhanced microbial growth rates and lower retention times are additional advantages of thermophilic operation. The aim of this work was to evaluate the acclimation of a mesophilic granular sludge (GS) to thermophilic conditions. The evaluation was based on the CH<sub>4</sub> production performance under thermophilic conditions using wine vinasses and an effluent from hydrogenogenic UASB reactor as substrates, which are similar to biorefinery effluents. Biomethane potential tests (BMPs) were carried out with granular sludge (GS) as inoculum and with a thermophilic digestate (which served as a reference inoculum already adapted to thermophilic conditions) to evaluate the methane yield. Additionally, BMPs were carried out with GS at mesophilic conditions to evaluate the effect of temperature in methane production.

## Materials and Methods

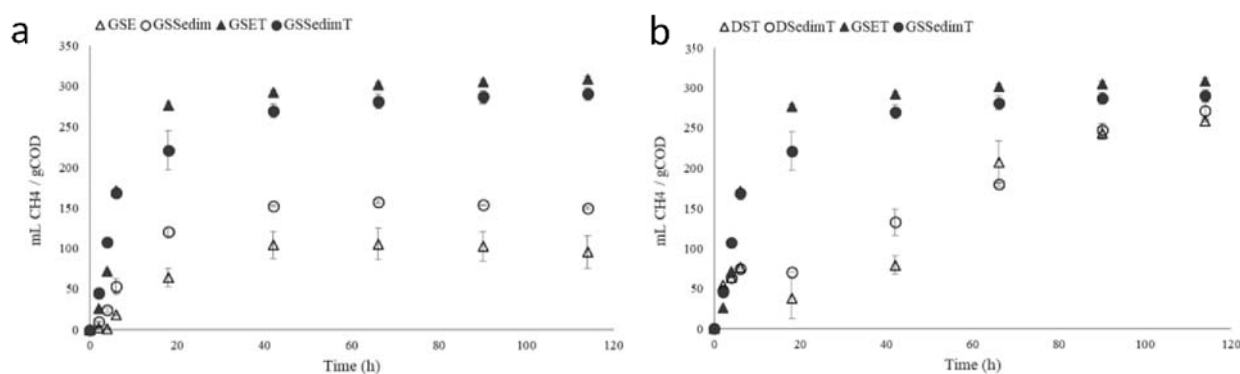
The BMP tests were performed in 1-L glass bottles according to Angelidaki et al. (2009). The GS, obtained from a brewery (Guadalajara, México), was acclimated for 2 days to 55°C prior the beginning of the BMP tests using glucose as substrate. The thermophilic digestate was obtained from an anaerobic digester (Querétaro, México). Wine vinasse was allowed to settle for at least 1 hour yielding the sediment fraction used as substrate. BMPs were performed with this fraction and the reactor effluent with a ratio of 0.5 gDQO<sub>substrate</sub>/gVS<sub>inoculum</sub>. After headspace deoxygenation with N<sub>2</sub>, the bottles were gas-tight closed and incubated at 55°C or 35°C. The tests were carried



out in duplicate. Blanks without substrate (for endogenous CH<sub>4</sub> production of the inoculum) and controls with carboxymethylcellulose (to confirm the inoculum hydrolytic activity) were also performed. The biogas produced was stored in gas-tight Tedlar<sup>®</sup> bags and the gas volume was daily measured with a 100 mL hermetic syringe. The biogas composition was determined by gas chromatography (GC-TCD) according to Cardeña et al. (2017). The volume of CH<sub>4</sub> produced per gram of COD consumed was calculated at STP conditions.

## Results and Discussion

As shown in Figure 1, the GS successfully treated effluent and the sediment under thermophilic conditions. The GS supported final CH<sub>4</sub> yield of 308 and 290 mL CH<sub>4</sub>/gCOD when using the UASB reactor effluent and the wine vinasses sediment, respectively. The thermophilic digestate generated a final CH<sub>4</sub> yield of 259 and 272 mL CH<sub>4</sub>/gCOD with effluent and sediment, respectively. These results showed that the granular sludge performance is at least equal than the reference thermophilic inoculum. Moreover, the relatively short acclimation time of the GS did not hindered the methanogenic potential of the inoculum when dealing with complex agroindustrial substrates (it was observed that both inocula also supported hydrolytic activities). Finally, in thermophilic conditions, methane production was 2-fold higher compared with mesophilic conditions.



**Figure 1.** Methane yield curves of (a) comparing mesophilic/thermophilic conditions and (b) comparing thermophilic performance of inocula. Digestate (D); Granular Sludge (GS); Effluent (E); sediment (Sedim); Thermophilic (T); Mesophilic (M).

## Acknowledgements

This study was financially supported by “Fondo de Sustentabilidad Energética SENER – CONACYT (Mexico)”, through the project 249564 CEMIE-Bio Liquid Biofuels Cluster, and project CONACYT 255537.

## References

- Alqaralleh, R.M., Kennedy, K., Delatolla, R., Sartaj, M., 2016. Thermophilic and hyper-thermophilic co-digestion of waste activated sludge and fat, oil and grease: Evaluating and modeling methane production. *J. Environ. Manage.* 183, 551–561.
- Angelidaki, I., Alves, M., Bolzonella, D. et al., 2009. Defining the biomethane potential (BMP) of solid organic wastes and energy crops: a proposed protocol for batch assays. *Water Sci. Technol.* 59, 927–934.
- Cardeña, R., Moreno, G., Bakonyi, P., Buitrón, G., 2017. Enhancement of methane production from various microalgae cultures via novel ozonation pretreatment. *Chem. Eng. J.* 307, 948-954.
- Kaparaju, P., Serrano, M., Thomsen, A.B., Kongjan, P., Angelidaki, I., 2009. Bioethanol, biohydrogen and biogas production from wheat Straw in a biorefinery concept. *Bioresour. Technol.* 100, 2562-2568.

# **Anaerobic municipal wastewater treatment in centralized and decentralized treatment systems: biological methane potential and microbial community at 20 and 35°C**

Ref # S2SMALL-97453

M. Gao, L. Zhang, Y. Liu\*

Department of Civil and Environmental Engineering, University of Alberta, 7-263  
Donadeo Innovation Centre for Engineering, Edmonton, Alberta, T6G 1H9, Edmonton,  
Canada

\* Corresponding Author: yang.liu@ualberta.ca

**Keywords:** biological methane potential; blackwater; municipal wastewater; primary sludge.

## **INTRODUCTION**

Conventional wastewater treatment plants utilize aerobic processes as the core biological treatment unit. The intensive energy input associated with aeration and the production of excessive sludge lead to high operational costs of these systems. Chemical energy contained in organic matters of municipal wastewater is 23.0 W/capita, which can be recovered in the form of methane using anaerobic treatment (Gao 2014). In particular, blackwater, mainly feces and urine, can be collected separately from household greywater. Source diverted blackwater presents high energy content source (Zeeman & Kujawa-Roeleveld 2011). The methane production potential of blackwater collected from different sources (different types of toilets) has not been evaluated previously. The high ammonia concentration and high pH in blackwater may inhibit anaerobic blackwater treatment and should be evaluated. The difference in various wastewater collection systems can lead to the difference in wastewater biological methane potentials and microbial community structure in anaerobic reactors. It is important to elucidate the impacts of collection procedures and potential inhibitors on the anaerobic treatment of blackwater and conventionally collected sewage because this information is needed for the design and operation of such systems. This study evaluates and compares the energy production potential and microbial population dynamics of municipal wastewater (sewage), primary sludge, and blackwater collected from different types of toilets at 20°C and 35°C. Potential challenges for operating anaerobic wastewater treatment systems have been identified.

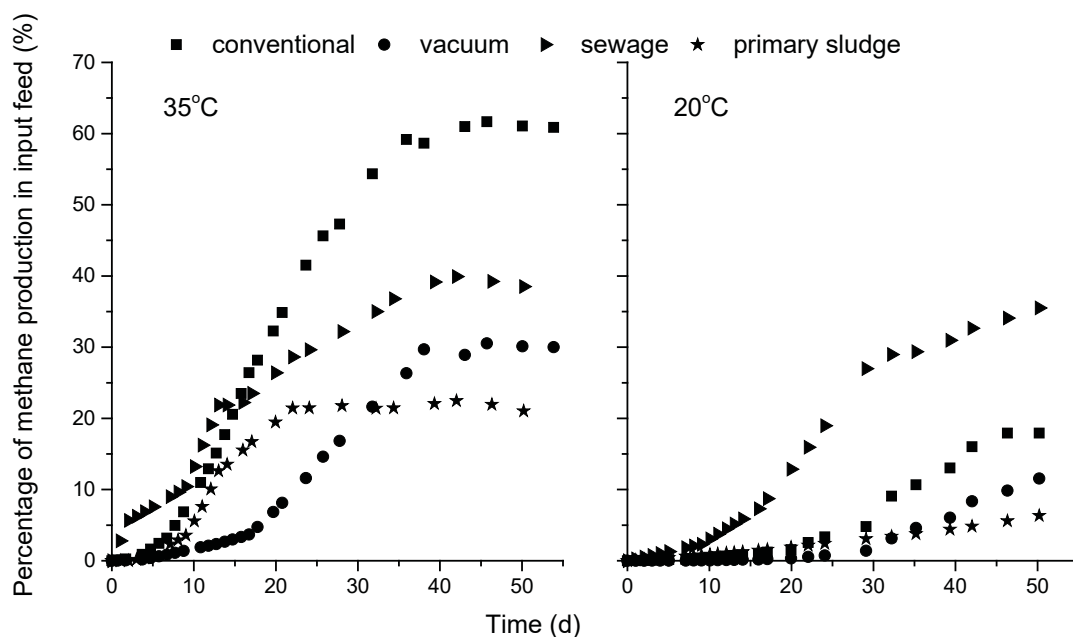
## **METHODS AND MATERIALS**

The biological methane potential (BMP) was measured at 20 and 35°C in blackwater (from vacuum and conventional toilets), sewage, and primary sludge in batch experiments using serum bottles (157 mL). The components for blackwater preparation were contributed by people in the research group. The contribution was made diversely to make the blackwater representative. The components were all mixed by a blender to be homogeneous and prepared as a feed stock. The blackwater in vacuum and conventional toilet was made based on 1 L water/flush and 9 L water/flush respectively. Chemical oxygen demand (COD), pH, NH<sub>4</sub><sup>+</sup>-N, total nitrogen, volatile solids, total solids, and total phosphorus in the substrates were determined at the start and end of each experiment. The volumes of the substrates were 15 mL,

110 mL, 135 mL and 30 mL, respectively for blackwater in vacuum toilet, blackwater in conventional toilet, sewage and primary sludge. The digester sludge from local wastewater treatment plant was used as inoculum. The input inoculum volume was 0.1 mL, which was small to avoid its impact on the substrates' BMP. Blank sample with inoculum and water was set up to check methane production due to the inoculum. Nutrients and trace element medium were not added as it was assumed sufficient in the substrate. Microbial community diversity for various samples was compared.

## RESULTS AND CONCLUSIONS

Our studies showed that the COD, pH, and ammonia concentration of blackwater from the vacuum toilet and sewage, respectively, were 29.5 g/L, 8.6, and 1.0 g NH<sub>4</sub>-N/L and 720 mg/L, 7.4, and 52 mg NH<sub>4</sub>-N/L. In BMP tests at 35 °C, the lag phase of blackwater and sewage was 2.5 days; at 20 °C, the lag phase of blackwater increased to 10 days, while the lag phase of sewage remained at 2.5 days. The methane production rates in blackwater in the conventional toilet, primary sludge, and sewage were similar at 35 °C, and were higher than the methane production rate in the vacuum toilet collected blackwater. BMP of blackwater from conventional toilet was 62% at 35 °C, which was higher than sewage (40%), primary sludge (22%), and blackwater collected from vacuum toilet (31%). Compared to the 35 °C condition, a longer time would be required to achieve the same BMP at 20°C. The low methane production in the vacuum toilet blackwater may be caused by ammonia inhibition. The hydrolysis rate constants of blackwater, primary sludge, and sewage were determined. Methanogen microbiology in the BMP tests was monitored and compared.



**Figure 1.** Cumulative methane production from sewage, primary sludge, blackwater (vacuum toilet, conventional toilet) at 20 and 35 °C.

## REFERENCES

- Gao, Han, Yaniv D. Scherson, and George F. Wells, Towards energy neutral wastewater treatment: methodology and state of the art, *Environmental Science: Processes & Impacts*, **16.6** (2014): 1223-1246.
- G. Zeeman, K. Kujawa-Roeleveld, Resource recovery from source separated domestic waste(water) streams; full scale results, *Water Science and Technology*, **64** (2011), 1987-1992.

# *A Hybrid Up-flow Sludge Blanket - ABR reactor for source-separated blackwater treatment*

Melesse Eshetu Moges<sup>1,2</sup>, Daniel Todt<sup>2</sup>, Eshetu Janka<sup>3</sup>, Arve Heistad<sup>1</sup>, and Rune Bakke<sup>3</sup>

<sup>1</sup> Faculty of Science and Technology, Norwegian University of Life Sciences (NMBU), P.O. Box 5003, NO-1432 <sup>2</sup> Ecomotive AS, [melesse.eshetu@nmbu.no](mailto:melesse.eshetu@nmbu.no); [dt@ecomotive.no](mailto:dt@ecomotive.no); [arve.heistad@nmbu.no](mailto:arve.heistad@nmbu.no).

<sup>3</sup>University College of Southeast Norway (USN), Porsgrunn, Norway. [Rune.Bakke@usn.no](mailto:Rune.Bakke@usn.no); [eshetu.j.wakjera@usn.no](mailto:eshetu.j.wakjera@usn.no)

\*Correspondence: [melesse.eshetu@nmbu.no](mailto:melesse.eshetu@nmbu.no); Tel.:+47 91529750

## **Abstract**

The performance of a hybrid upflow sludge blanket anaerobic baffled reactor was tested as an integrated treatment system for source-separated blackwater. The system consist of a stirred equalization tank, a buffer inlet tank and two hybrid reactors, each with a working volume of 16.4 L. Both reactors run at 3-days hydraulic retention time with different intermittent pulse feeding. The pulse intensities into the reactors were regulated by adjusting pump speed. Pulse length of 12 and 24 seconds per feed was set with respective rates of 114 L h<sup>-1</sup> and 52 L h<sup>-1</sup> for short-pulse fed reactor (RI) and long-pulse fed reactor (RII). Stable performance of the reactors was attained after 120 and 90 days, for RI and RII, respectively. Total COD removal efficiency stabilized above 78 % at steady state. Biogas production ranged from 8.6.-19 L d<sup>-1</sup>, with 63–82 % methane concentration and an average conversion of 0.69 and 0.75 g CH<sub>4</sub>-COD g<sup>-1</sup>COD<sub>in</sub> for RI and RII, respectively, at steady state. The results imply that source-separated blackwater can be treated efficiently in an anaerobic sludge blanket process on average loading rate of 0.3 g COD d<sup>-1</sup> L<sup>-1</sup> reactor volume with high methane production potential and appreciable removal of organic and particulate matter.

**Key words:** *blackwater, hybrid reactor, source-separation, post-treatment, resource-recovery.*

## **Introduction**

Considering the increasing concerns of water scarcity and environmental pollution, a new trend has emerged for decentralized and source-separated approaches of processing wastewater as a resource (Larsen et al. 2013, Voulvoulis 2014). Source-separation of wastewater involves separate collection and treatment of the different domestic wastewater streams. About 70% of organic matter (COD) and 80% of nutrients discharged by a household into the wastewater originate from toilets (Langergraber and Muellegger 2005, Kujawa-Roeleveld and Zeeman 2006, Todt 2015) which constitute only 1% by volume of the total domestic wastewater.

Recent studies on separate collection and treatment of blackwater (BW) fraction show that anaerobic up-flow reactors have potential for energy and nutrient recovery (Kujawa-Roeleveld 2005, Kujawa-Roeleveld and Zeeman 2006, Zeeman and Kujawa-Roeleveld 2011, Zeeman et al. 2008). The key feature of anaerobic up-flow reactors is the formation of sludge blankets in which biomass and particulate organic matter are retained in the reactor. The up-flow mode provides sufficient contact between anaerobic sludge and incoming substrate of the wastewater, thereby increase the physical removal of suspended solids and biological removal of dissolved organic compounds (Zeeman et al. 2001, Luostarinen and Rintala 2005). Understanding factors that

influence those key features of the up-flow reactor will help to develop a robust and effective reactor. The feasibility of high-rate anaerobic up-flow reactor systems for blackwater, therefore, depends primarily on:- (i) the nature of the organic components in the blackwater, (ii) the operational conditions (particularly organic load rate OLR, hydraulic loading rate HLR, pH and Temperature), and (iii) the reactor configuration, especially its capacity to retain viable biomass in sludge bed.

A hybrid reactor which integrates an up-flow sludge blanket in an anaerobic baffle reactor (ABR) was developed based on the hypothesis of combining the advantages of up-flow anaerobic sludge blanket (UASB) and ABR while minimizing their limitations. Studies with animal manure showed that this process works reliable on relatively high loading rates and short hydraulic retention time (Bergland et al. 2015), which makes it attractive for an application to blackwater. The performance of such a reactor principle was tested here as an integrated treatment system for source-separated blackwater. The aim of this study was to evaluate effects of load and feed pulses on the system performance in terms of initial adaptation, stability, effluent quality, removal efficiency of organic and suspended particulate matter, biogas production and methane yield.

## **2. Methods**

### **2.1. Collection and characterization of source separated blackwater**

The substrate used in this anaerobic digestion experiment is a source-separated blackwater (BW) collected from student dormitories at the Norwegian University of Life Sciences with 48 inhabitants. The dormitory is equipped with vacuum toilets with 1.2 liter flushing volume. A vacuum pump with integrated grinder (Vacuumarator™ 25MB, Jets, Hareid, Norway) delivers the BW to a pumping station from which it is transferred with an impeller pump (40U, Tsurumi Europe GmbH, Düsseldorf, Germany), into a stirred storage tank located in the laboratory facilities. Total retention time in the sewer system is 36-48h. More details are given in Todt et al. (2015). Samples were taken from this tank on weekly bases to study and characterize the composition of blackwater as described in section 2.3

### **2.2. Reactor configuration and setup**

Two prototype laboratory-scale hybrid UASB-ABR reactors with a working volume of 15.7 L each were used for this study. The reactors were constructed from 10 mm thick PVC pipe section with an internal structure to establish two chambers. The feed enters at the bottom of the main chamber with an up-flow anaerobic sludge blanket (UASB) with internal dimensions of 315 mm height and 315 mm diameter. The water flows from the top of this first chamber, to the bottom of a smaller chamber of 245 mm height and 135 mm diameter, directed by a baffle in this chamber, therefore defined as an anaerobic baffle reactor (ABR) (McCarty et al. 1992, US Patent 5091315). One-third of the baffled chamber is used for down-flow and remaining two-third of the ABR is used for up-flow.

The reactors were fed with concentrated and partially hydrolyzed blackwater from a buffer tank using peristaltic pumps with intermittent flow of 16 pulses per day but with two different pulse lengths, 12 and 24 seconds per pulse for Reactor I and Reactor II, respectively. The hydraulic load was adjusted to 6 L d<sup>-1</sup> for each of the reactors by accordingly adjusting the rotation speed of the peristaltic pumps with help of a frequency converter. The baffle chamber separates the solid from the liquid phase. A T-tube on the outlet of the second chamber (the ABR) separates the gas from the liquid phase. The u-tube pressure lock on the liquid outlet prevents the gas from escaping with

the liquid. Reactor temperature was adjusted to 25 and 28 °C with help of a heated water bath to keep the reactors at constant temperature.

### 2.3. Liquid analysis

Inlet raw blackwater and digested effluent samples were taken on a weekly basis in form of 24h composite samples. Occasionally samples were also taken at the bottom of the two chambers in each of the reactors. Analysis of chemical oxygen demand (total COD<sub>t</sub> and soluble CODs), pH, total ammonia nitrogen (TAN), total and soluble phosphorous (P-tot and PO<sub>4</sub>-P), total suspended solids (TSS), total solids (TS), volatile solids (VS), volatile suspended solids (VSS), and measurement of the concentration of volatile fatty acids (VFAs) were carried out to determine the characteristics and efficiency of the system. Total COD and total P were measured from the unfiltered sample. Soluble COD, PO<sub>4</sub>-P and TAN were measured from filtered samples using 1.2µm glass fiber filters. COD<sub>t</sub> and COD<sub>f</sub> concentrations were analyzed using spectrophotometric test kits (Hach-Lange, Berlin, Germany) LCK 014 and LCK 514, respectively. Total P, PO<sub>4</sub><sup>3-</sup>-P, and TAN in the filtered samples were diluted (with a dilution factor of 10<sup>3</sup>) and analyzed using Hack Lange test kits of LCK 349 and LCK 304, respectively.

Total suspended solids (TSS), volatile suspended solids (VSS) retained on the 1.2µm glass fiber filters (Whatman GF-C, GE Healthcare, Little Chalfont, UK) and total solids (TS), volatile solids (VS) were determined using standard methods (American Public Health Association (APHA) 2005). Limited number of samples were taken for *E. coli* and total coliform bacteria analysis from the influent and effluent of the reactor to estimate the effect of anaerobic digestion on pathogen reduction, following the standard analytical methods (American Public Health Association (APHA) 2005) using Colilert 18 test kits (IDEXX Laboratories Inc, Maine, US). For VFA analysis, samples were centrifuged at 6000 rpm for 10 min and the supernatant was filtered through 0.45µm membrane filter prior to analysis. VFA was analyzed using HPLC at the NMBU Biogas laboratory in Ås and using gas chromatography (Hewlett Packard 6890) at USN, Porsgrunn. The gas chromatography has a flame ionization detector, a capillary column and helium as gas carrier.

### 2.4. Biogas monitoring

Biogas production, from both reactors, was monitored daily. The gas volume was measured continuously using Ritter® MilliGas counter (Dr.-Ing. Ritter Apparatebau GmbH & Co. KG). Gas samples were collected using 1 L collection bag (7"x7" multi-layer RESTEK, Bellefonte US) for CH<sub>4</sub> and CO<sub>2</sub> determination. The gas composition as methane (CH<sub>4</sub>) and carbon dioxide (CO<sub>2</sub>) was then determined via gas chromatography (GC) (Perkin Elmer, TC detector, carbowax packed column, helium as carrier gas, and flowrate of 17 mL min<sup>-1</sup>). The methane-COD (CH<sub>4</sub>cod) production was calculated from the average measured CH<sub>4</sub> fraction (partial pressure of methane) in the biogas ( $f_{CH_4}$  in Pa), the daily cumulative gas flow rate ( $Q_{gas}$  L/d), and,  $TOD(CH_4)$  is theoretical oxygen demand for CH<sub>4</sub> (64 g COD CH<sub>4</sub> mol<sup>-1</sup>), R is the universal gas constant (8.3145 m<sup>3</sup> Pa mol<sup>-1</sup> K<sup>-1</sup>) and T is operational reactor temperature (°C)).

$$CH_4cod = \frac{f_{CH_4} * Q_{gas}}{R * (T + 273)} * TOD(CH_4) \quad 1$$

### 2.5. Mass balance calculation

The COD mass balance was established with the organic mass loading rates (OLR) determined for inlet (COD<sub>in</sub>), effluent (COD<sub>out</sub>), excess sludge (COD<sub>sludge</sub>) and gas (COD<sub>CH<sub>4</sub></sub>). OLR is expressed



as the daily load of organic matter determined as COD normalized per reactor volume unit ( $\text{g O}_2 \text{d}^{-1} \text{L}^{-1}$ ) where  $Q$  is the hydraulic load in  $\text{L d}^{-1}$ ,  $C_{\text{cod}}$  is the COD concentration in  $\text{g L}^{-1}$  at the particular sampling point and the working volume of the reactor in L ( $V_{\text{reactor}}$ ):

$$OLR = \frac{Q * C_{\text{cod}}}{V_{\text{reactor}}} \quad 2$$

COD accumulated in the reactor in form of biomass/sludge ( $\text{COD}_{\text{acc}}$ ) was then calculated from the OLR at  $\text{COD}_{\text{in}}$ ,  $\text{COD}_{\text{out}}$ ,  $\text{COD}_{\text{sludge}}$  and  $\text{COD}_{\text{CH}_4}$ .

$$COD_{\text{acc}} = COD(\text{in} - \text{out}) - COD(\text{CH}_4) - COD_{\text{sludge}} \quad 3$$

### 3. Results and discussion

The raw blackwater (BW) used in this research is presented in Table 1, and characterized by organic matter concentration measured as COD<sub>t</sub>, COD<sub>s</sub>, total suspended solids, total solids, volatile solids, pH, volatile fatty acid, ammonium nitrogen and phosphorus. The influent COD<sub>t</sub> and COD<sub>s</sub> concentrations were in the ranges 1900-7600 mg/L and 400-2300 mg/L, respectively. The average of the influent particulate (COD<sub>t</sub>-COD<sub>s</sub>)/COD<sub>t</sub> ratio remained relatively high (0.8 on average) throughout the operation. The influent COD is therefore mainly in the suspended form constituting about 77 % of the total COD. The COD of the filtered sample, defined as the soluble fraction, constitute about 23 % of total COD. The volumetric organic loading rate ranged from 25–45 g COD/reactor volume/d for Reactor I and 27-47 g COD/reactor volume/d for Reactor II.

The influent TSS concentration ranges from 1000–5900 mg/l. The high standard deviation indicates significant temporal variability of raw BW composition during the study period. The daily variation in the BW composition could arise from several factors including the diet of the inhabitants, toilet paper consumption and number of flushing events per toilet visit.

Table 1. The composition of BW used during the experimental period. The  $\pm$  shows the standard deviation.

Parameter	Unit	Average
pH		9 $\pm$ 0.34
COD <sub>t</sub>	mg/L	5500 $\pm$ 1300
COD <sub>f</sub>	mg/L	1200 $\pm$ 330
TSS	mg/L	3000 $\pm$ 900
TS	mg/L	6300 $\pm$ 700
VFA	mg/L	400 $\pm$ 200
VS	mg/L	4800 $\pm$ 600
NH <sub>4</sub> -N	mg/L	900 $\pm$ 180
Tot P	mg/L	120 $\pm$ 20
PO <sub>4</sub> <sup>-</sup> P	mg/L	60 $\pm$ 20

#### COD removal efficiency

During the start-up phase, the removal efficiency of total COD varied with time ranging from 31 to 67 % with an average of 48 % in RI and from -4 to 74 % with an average of 36 % in RII (Fig.1 top). Suspended particulate COD fraction removal during this stage of operation was on average 68 and 76 % for RI and RII, respectively. The filtered COD fraction removal was negative with an

average of -25 for RI and -49 % and RII during the first four months. This implies that the disintegration of the particulate fraction of COD and hydrolysis of the feed organic exceeded methanogenesis during the first part of the study. Similar results has been reported in other studies (Al-Jamal and Mahmoud 2009, de Graaff et al. 2010, Sharma et al. 2014, Sharma and Kazmia 2015).

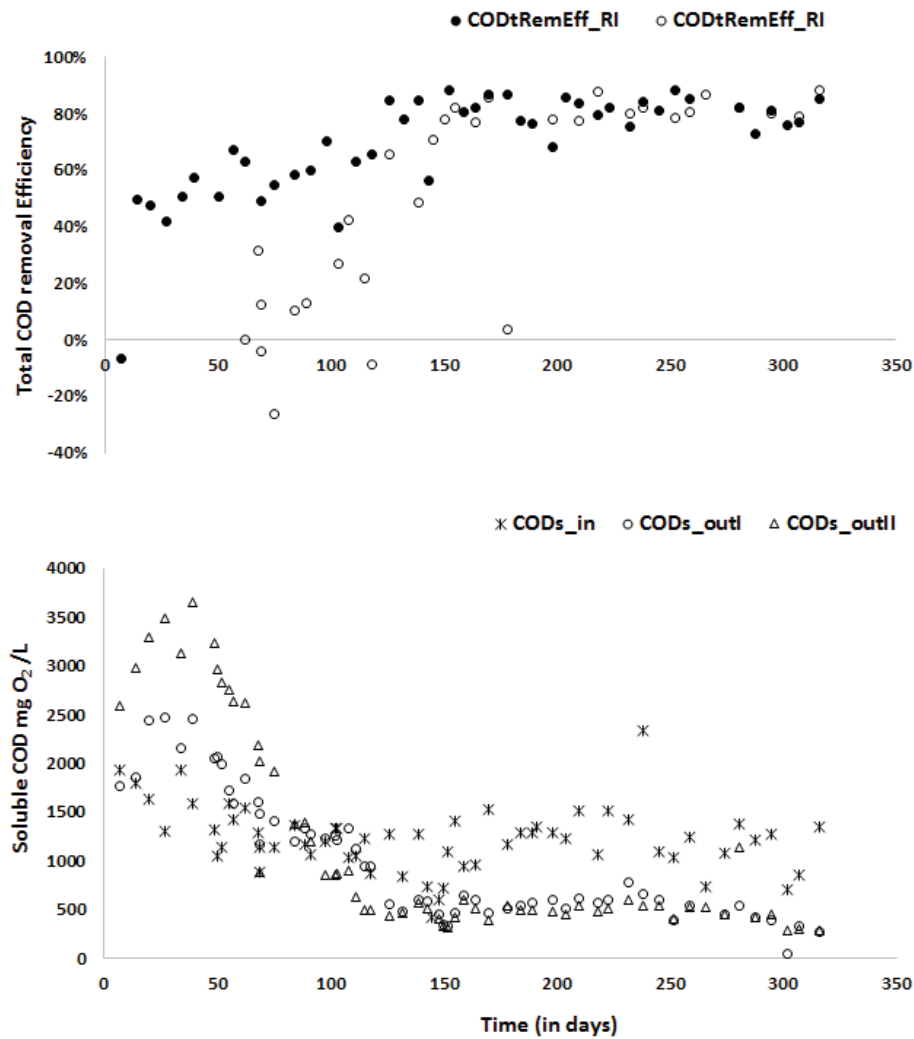


Figure 1. Total COD removal efficiency (CODtRemEff) in R-I and R-II during the start-up and steady state (top), and measured soluble COD (CODs) in and out of the reactors throughout the study.

The surplus dissolved organics in the effluent compared to influent dissolved organics diminished with time and the reactors reached steady state after 120 and 90 days for RI and RII respectively (Fig 1 bottom). During the steady state period, both particulate and soluble organic fraction removal stabilized with an average removal efficiency of 86 and 90 % for particulate COD and 55 and 54 % for soluble fraction in RI and RII, respectively. This implies that the special UASB-ABR reactor configuration achieved efficient retention and degradation of particulate organic matter.

The effluent quality demonstrated the ability of the reactors to remove efficiently the particulate organic matter and total suspended solids.

### Effect of OLR

During the steady state period, the two reactors received in average an organic load of 32.5 g COD/day and 24.8 g COD/day for RI and RII, respectively. This translates into an OLR (normalized per reactor volume, see Eq. 2) of 0.3 and 0.21 g d<sup>-1</sup> L<sup>-1</sup> respectively. The variability of organic load was more pronounced in RII than RI (Fig.2) and likely a result of different flow velocities out the buffer tank during feeding, which were 610 m/h and 320 m/h for RI and RII, respectively. However, the effect was not reflected on the effluent quality at steady state. Moreover, both reactors have similar trend in the removal efficiency and methane conversion rate although higher methane conversion rate was observed in RII. This could be due to the longer feeding length, which provide more time of substrate exposure.

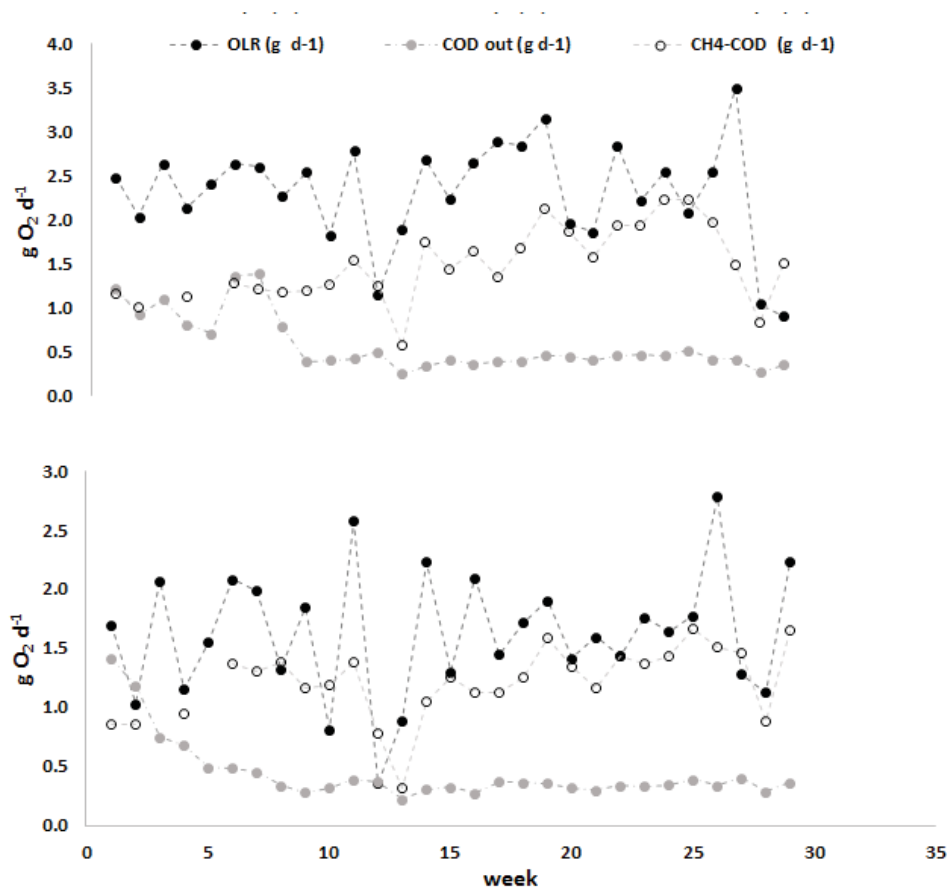


Figure 2. COD mass loading rates, normalized per liter reactor volume for inlet, gas (CH<sub>4</sub>) and effluent for Reactor I (top) and Reactor II (bottom)

### Pulse feeding effects

Fig. 3 shows effluent sludge volume taken after 5 minutes and 30 minutes of sedimentation. The result clearly revealed that in both reactors the effluent sludge is characterized by well sorted heavy particle concentration that settle within very short time. In all observations, most of the effluent sludge settled within five minutes. Hence, the change in amount of effluent sludge between 5 and 30 min sedimentation time was insignificant ( $p>0.5$ ). The settled effluent sludge volume was higher for Reactor I than in Reactor II except the first two days and at steady state when both were close to zero.

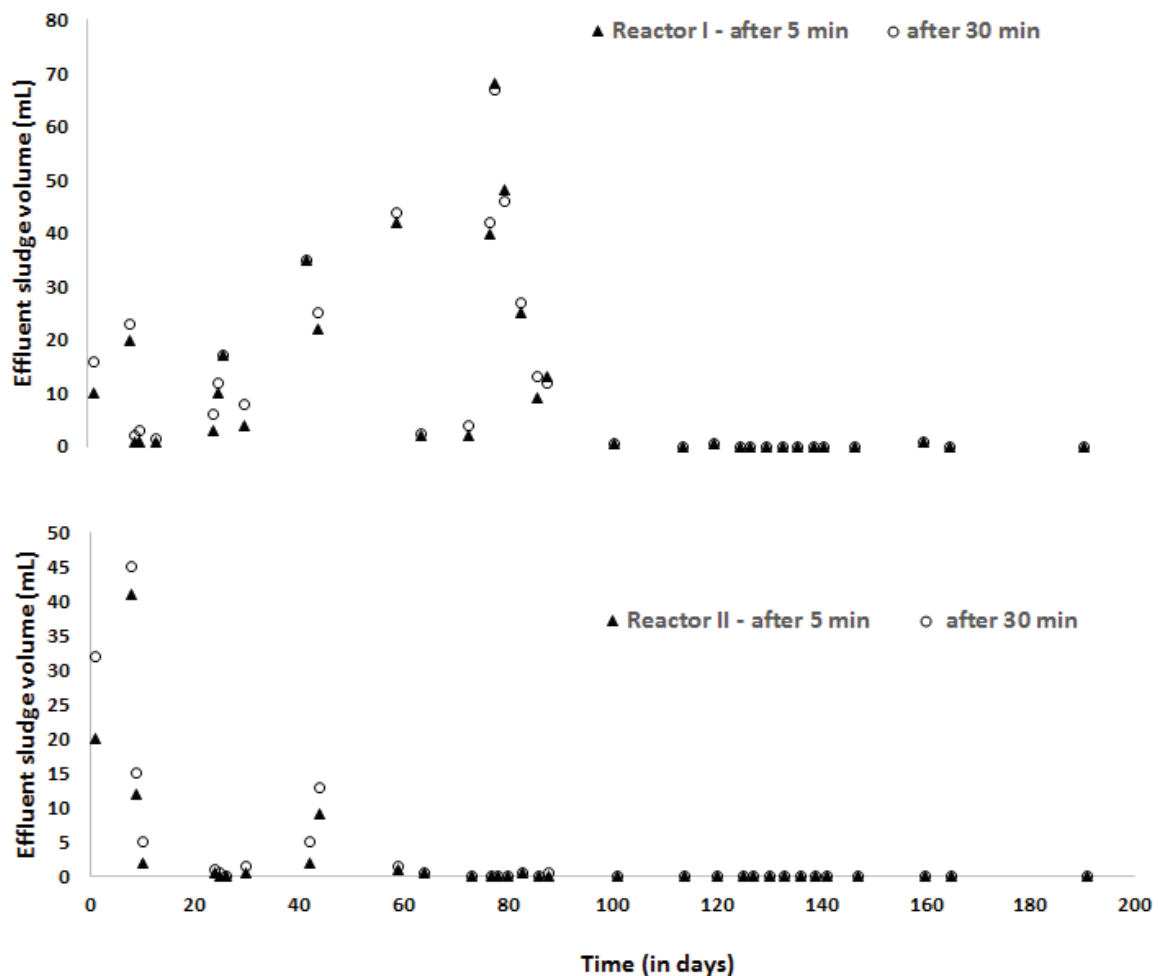


Figure 3. Effluent sludge volume of R-I (top) and R-II (bottom) after 5 and 30 min of sedimentation time during the study.

The up-flow velocity plays an important role in determining the behavior of sludge development in sludge beds and sludge blanket expansion (Wiegant 2001, Mahmoud 2002, van Lier et al. 2008). In our reactors, the up-flow velocity is determined by the actual flow rate during pulse feedings of  $114 \text{ L h}^{-1}$  and  $52 \text{ L h}^{-1}$  resulting in an up-flow velocity of  $1.5$  and  $0.7 \text{ m h}^{-1}$  for RI and RII, respectively. In a UASB reactor, the up-flow water velocity usually ranges between  $0.1$  and  $1.4 \text{ m h}^{-1}$  (Kalyuzhnyi et al. 2001, Korsak 2008). The high rate of flow in this study lasts, however, only for a very short time for 12 and 24 seconds per pulse with 5388 and 5376 seconds long pulse

intervals. The average up-flow velocity was therefore much less than this actual pulse up-flow velocity. The high flow rate, during pulse feed, lifts the sludge blanket by about 6 mm but it slowly sinks during the long pulse intervals. In un-matured reactors, this causes instability and removal of more biomass to the effluent, which is especially the case at the startup stage in RI, requiring longer time to reach steady. Steady state was reached sooner for the less intense feed pulse (RII) than for the high flow pulse (RI). Studies on the effect of upflow velocity on suspended solid removal indicated deterioration of effluent quality as upflow velocity increases from 0.7-0.9 m/h to 3.2 m/h (Gonçalves et al. 1994). However, no significant differences in residual sludge was observed in the effluents of the two cases (RI vs RII) at steady state (Fig. 3). The two cases also had similar COD removal and comparable methane production at steady state (Fig. 1 and 2), implying that the reactors had sufficient sludge expansion volume, solid separation and mass transfer for both feed pulses tested. It also implies that the reactor culture was able to adapt to both feed pulses tested.

### ***Production and influence of volatile fatty acid (VFA)***

#### **Start-up period**

It has been observed that the organic substrates present in the blackwater were subject to simultaneous hydrolysis and acidification by hydrolytic and acidogenic bacteria in the feed buffer tank. Low pH at the bottom of the buffer tank revealed the formation of VFA. The concentration of VFA in the buffer tank reached a peak value of 4750 mg/l and had higher values than the raw blackwater throughout the operation period. The buffer tank, therefore, serve as a pre-hydrolysis and fermentative step. Moreover, VFA concentration substantially varied spatially and temporally in the system, particularly at the early stage of the study. In all cases, VFA levels in the second chamber of the reactors were lower than in the first chamber.

Acetate was prime constituent of VFA and the main intermediate product of acidogenic degradation in the buffer tank, as well as in the different parts of the reactors and effluents. The ratio of acetate to total VFAs reached more than 90 %, which shows the significant activity of acidogenic bacteria. The higher concentration of acetic acid as compared to the other volatile acid components is due to the fact that acetates are produced in all biochemical pathways of anaerobic biodegradation of carbohydrates, protein and fats (Narkis et al. 1980). During this start-up phase, total VFA concentrations in the reactor effluent was higher than the feed blackwater and reached peak value after two months in both R-II than R-I (Fig. 4). This demonstrates that the establishment of methanogenesis was lagging behind acetogenesis due to the slow growth rate of methanogenic archaea. Nevertheless, effluent VFA decreased sharply towards the end of the start-up period as the acetate produced is rapidly convert into methane by methanogens (Senturk et al. 2014). The concentration of VFA in the effluent also corresponds with the observed effluent CODs concentrations (Fig 1 bottom). Propionic acid concentration was also relatively high in the blackwater but low in the reactor effluents, implying that methanogenesis was the overall rate limiting step in the biogas production. The methane concentration was, however, above 65 % in the generated biogas.

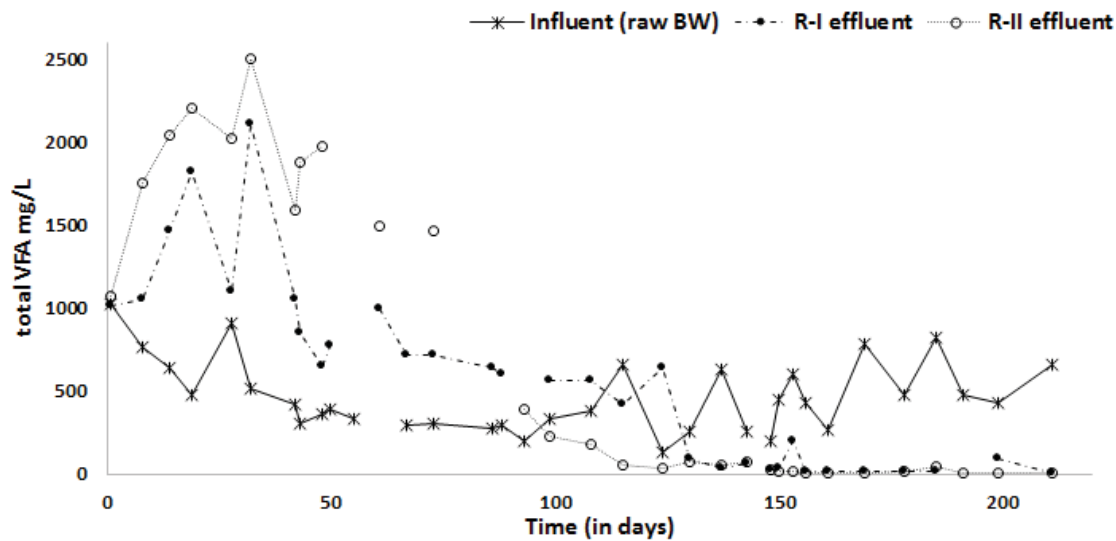


Figure 4. Total VFA in the influent (blackwater from feed tank), Reactor I effluent, and Reactor II effluent.

### Steady state period

The methane production progressively increased when the reactors matured and 60-70 % of the feed COD was converted to methane at steady state. Effluent VFA concentrations decreased and the COD and TSS removal reached 89 % & 90 %, respectively. Fig. 5 shows the average VFA concentration during steady state period from the inlet tank, buffer tank and the different chambers of the two reactors. The average VFA is high in the buffer tank but degraded very fast in the reactors. In such highly buffered systems, pH changes in the reactor are small. Hence, VFAs can be considered reliable for process monitoring (Murto M. et al. 2004).

The total VFA in the up-flow sludge blanket compartment R1C1 for R-I and R2C1 for R-II, is generally higher than in the ABR compartments R1C2 and R2C2 for R-I and R-II, respectively. VFA concentration decreased through the reactor chambers, indicating stability of the reactors (Mes et al. 2003, Colón et al. 2015). The decrease VFA concentration in the second chamber of the reactors, particularly in R-II indicates complete degradation of VFA. This corresponds to the effluent VFA, which is close to zero at steady state.

### pH

Over all, in both reactors pH remained stable for most of the time both in the influent and in the effluent during the operation period. This is mainly due to the high buffer capacity as well as high ammonium concentration in the influent. The average pH of the influent was 9.1 and 8.38 and 8.1 for the effluent of R-I and R-II, respectively. In AD pH is a key factor in the formation and characterization of VFA and the ammonium/free ammonia equilibrium (Ortiz et al. 2014). The pH influences bacterial and archaeal growth rates (Espinoza-Escalante et al. 2009). A pH between acid and neutral (i.e. pH 5-7) promotes butyric acid production, while basic conditions (~ pH 8) favor acetic and propionic acid formation (Horiuchi et al. 2002). This supported our observations of high acetate as the main intermediate result of acidogenic degradation in the buffer tank, the different compartments of the reactors and effluents.



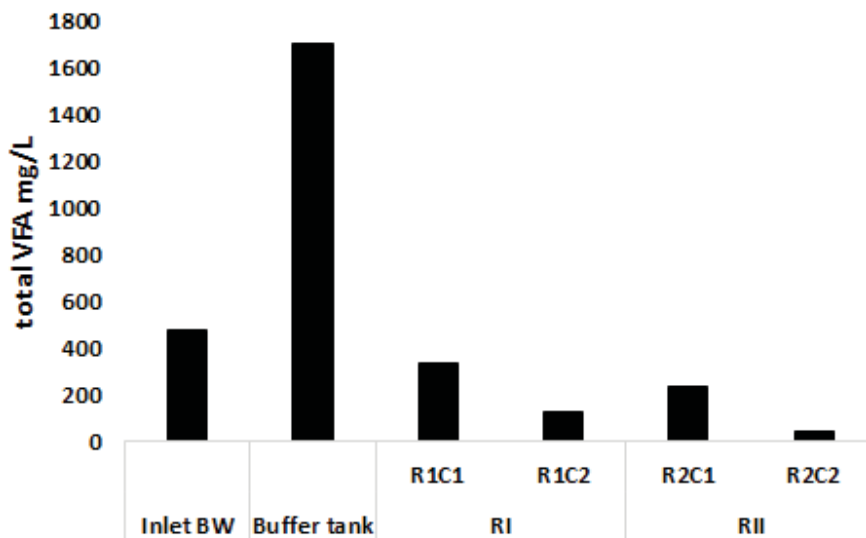


Figure 5. Average total VFA in the inlet blackwater, buffer tank, and different compartments of RI and RII.

### Mass-balance and potential methane recovery

#### Biogas Production

Biogas production and methane content were measured and compared between the two reactors. Biogas production ranged from 8.6-19 L d<sup>-1</sup> in RI and 6-10 L d<sup>-1</sup> for RII, with an average methane content of 70 % and 74 %, respectively. The biogas production was highly variable mainly due to the fluctuation of organic loading. High biogas recorded during the present study can be attributed to a combination of the reactor configuration and significant pre-hydrolysis in the buffer tank. On top of that compared to other single-phase systems, and conventional UASB which produce biogas with methane content fluctuating between 40 % and 60 % (Yu et al. 2002), this hybrid reactor is efficient in terms of production of biogas with high methane content. The average methane content in this study is comparable to reported biogas yield after co-digestion of blackwater using anaerobic hybrid reactor (Elmitwalli et al. 2002) and the amount of CH<sub>4</sub>-COD produced in the MIX-UASB reactor (Tervahauta et al. 2014).

#### COD mass-balance

Figure 6 presents steady state COD mass-balance for the two reactors and the combined mass balance for the system. The cumulative organic load during the steady state period was 0.3 and 0.21 kg COD with an average daily normalized organic loading rate of 2,5 and 1.7 g O<sub>2</sub> d<sup>-1</sup> L<sup>-1</sup> reactor volume and a hydraulic loading of 681 and 718 L for RI and RII, respectively. In relation to the inlet COD, 69 % of the COD is converted to CH<sub>4</sub> in RI and 75 % in RII. The amount of COD retained or accumulated as biomass in the reactor is 14 % for RI and 5 % for RII. Low retained COD in RII can be attributed to higher conversion rate of COD to methane, although the reactor has lower gas volume production compared to gas production in RI. Residual COD fractions in the effluent is 17 % and 20 % in RI and RII, respectively.

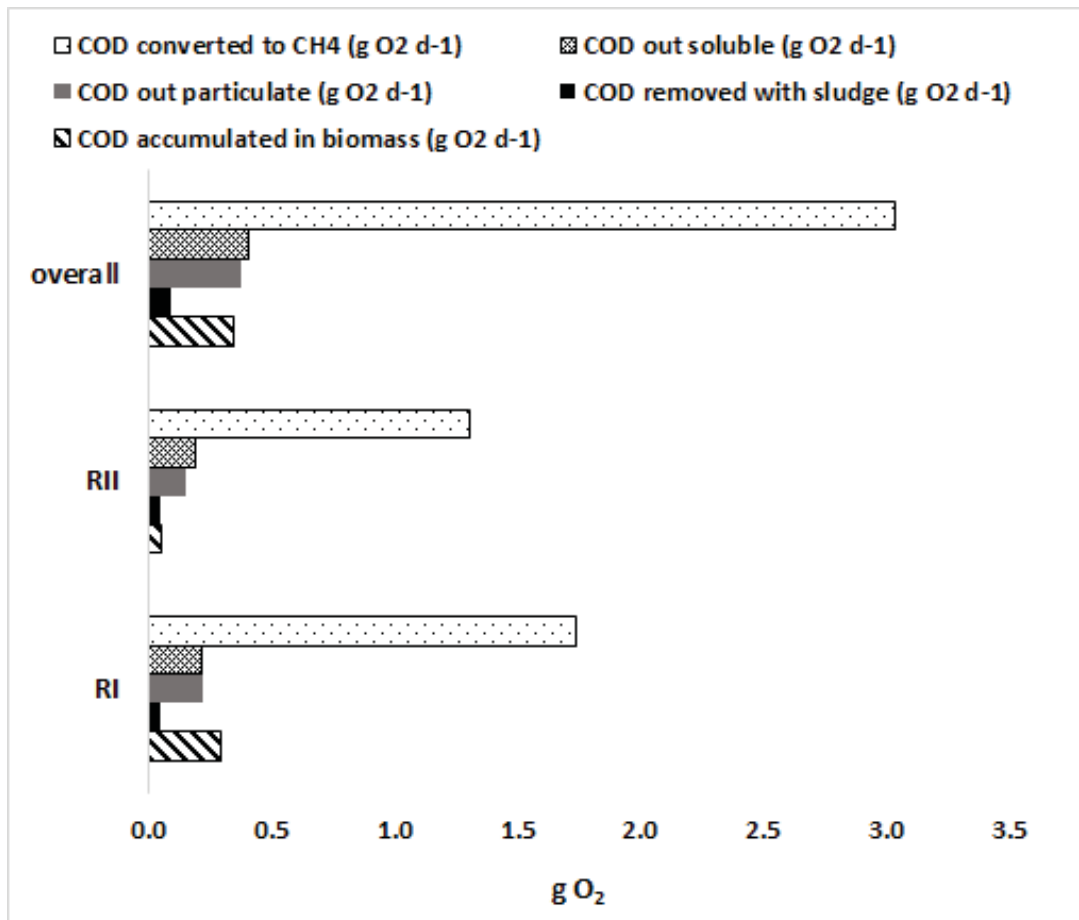


Figure 6. The overall mass balance of RI and RII at steady state.

#### 4. Conclusions

In this study, source-separated blackwater was anaerobically treated with a hybrid UASB-ABR reactor at controlled temperature (i.e. 25-28 °C) for several months, going from variable efficiency to steady state after less than ½ year. The concentrated source-separated blackwater was treated efficiently at 3 d HRT with total COD removal efficiency stabilized above 78 % at steady state. Biogas production ranged from 8.6.-19 L d<sup>-1</sup> and an average conversion of 0.69 and 0.75 g CH<sub>4</sub>-COD g<sup>-1</sup>COD<sub>in</sub> at steady state for the two reactors operated with different feed pulses. Feed pulse length influenced significantly the early phase of the AD process. Short and strong feed pulse resulted more unstable performance at start-up phase and longer time to reach steady state compared to the longer pulse feeds with lower flow rate, but similar steady state performance was observed for the two feed pulses. Gas production was mainly influenced by the uncontrolled change in the influent composition but biogas methane concentration was quite stable. The system conserves nutrients as soluble N and P in the effluent, which opens up the opportunity to recover these valuable resources with novel post-treatment steps. The results imply that source-separated blackwater can be treated efficiently in an anaerobic sludge blanket process at an average loading rate of 0.3 g COD d<sup>-1</sup> L<sup>-1</sup> reactor volume with high methane production and removal of organic particulate matter.

## Acknowledgement

The authors gratefully acknowledge the financial support by Ecomotive AS and The Norwegian Research Council (NRC). Special thanks are extended to John Morken (PhD) at Faculty of Science and Technology, NMBU, for providing us access to the Biogas Laboratory and discussions during biogas analysis; Magdalena Bruch (PhD student) who analyzed the volatile fatty acids at the Biogas lab. Marie Bindingsbø and Frida Celius Kalheim (both MSc students) for assisting in blackwater analysis and Oliver Sahlmann for his technical support.

## References

- Al-Jamal, W., and N. Mahmoud. 2009. Community onsite treatment of cold strong sewage in a UASB-septic tank. *Bioresour. Technol.* **100**: 1061–1068.
- American Public Health Association (APHA), A. W. W. A. A., and Water Environment Federation (WEF). 2005. STANDARD METHODS FOR THE EXAMINATION OF WATER AND WASTEWATER. 21st edition, Washington, DC.
- Bergland, W. H., C. Dinamarca, M. Toradzadegan, A. S. R. Nordga, I. Bakke, and R. Bakke. 2015. High rate manure supernatant digestion. *Water Research* **76**:1-9.
- Colón, J., A. A. Forbis-Stokes, and M. A. Deshusses. 2015. Anaerobic digestion of undiluted simulant human excreta for sanitation and energy recovery in less-developed countries. *Energy for Sustainable Development* **29**:57-64.
- de Graaff, M. S., Hardy Temmink, Grietje Zeeman, and C. J. N. Buisman. 2010. Anaerobic Treatment of Concentrated Black Water in a UASB Reactor at a Short HRT. *Water* **2** 101-119.
- Elmitwalli, T. A., V. Sklyar, G. Zeeman, and G. Lettinga. 2002. Low temperature pre-treatment of domestic sewage in an anaerobic hybrid or an anaerobic filter reactor. *Bioresource Technology* **82**:233–239.
- Espinoza-Escalante, M., C. Pelayo-Ortíz, H. Gutierrez, and Y. Gonzalez. 2009. Anaerobic digestion of the vinasses from the fermentation of Agave tequilana Weber to tequila: The effect of pH, temperature and hydraulic retention time on the production of hydrogen and methane. *Biomass & Bioenergy* **33**.
- Gonçalves, R. F., A. C. Cha Lier, and F. Sammut. 1994. Primary fermentation of soluble and particulate organic matter for waste water treatment. *Water Sci. Technol.* **30**:53–62.
- Horiuchi, J. I., T. Shimizu, K. Tada, T. Kanno, and M. Kobayashi. 2002. Selective production of organic acids in anaerobic acid reactor by pH control. *Bioresource Technology* **82**: 209-213.
- Kalyuzhnyi, S., V. Fedorovich, and P. Lens. 2001. Novel Dispersed Plug Flow Model for UASB Reactors Focusing on Sludge Dynamics. Pages 123-128 in 9th International Conference on Anaerobic Digestion, Antwerpen, Belgium.
- Korsak, L. 2008. Anaerobic Treatment of Wastewater in a UASB Reactor. Licentiate Thesis in Chemical Engineering KTH, Stockholm, Sweden.
- Kujawa-Roeleveld, K. 2005. Anaerobic Treatment of Concentrated Wastewater in DESAR Concepts; STOWA. Utrecht, the Netherlands.
- Kujawa-Roeleveld, K., and G. Zeeman. 2006. Anaerobic treatment in decentralized and source-separation-based. *Rev Environ Sci Bio/Technol* **5**:115-139.
- Langergraber, G., and E. Muellegger. 2005. Ecological sanitation – a way to solve global sanitation problems? *Environ Int.* **31**:433–444.
- Larsen, T. A., K. M. Udert, and J. Lienert. 2013. Source separation and decentralization for wastewater management. IWA Publishing.
- Luostarinen, S. A., and J. A. Rintala. 2005. Anaerobic on-site treatment of black water and dairy parlour wastewater in UASB-septic tanks at low temperatures. *Water Research* **39**:436–448.

- Mahmoud, N. 2002. Anaerobic Pre-treatment of Sewage Under Low Temperature (15 °C) Conditions in an Integrated UASB-Digester System. Wageningen University, Wageningen, The Netherlands.
- Mes, T. Z. D. d., A. J. M. STAMS, and G. ZEEMAN. 2003. Methane production by anaerobic digestion of wastewater and solid wastes. Pages 58-94 in J. H. REITH, R. WIJFFELS, and H. H. BARTEN, editors. Biomethane and Biohydrogen. Status and perspectives of biological methane and hydrogen production.
- Murto M., Björnsson L., and M. B. 2004. Impact of food industrial waste on anaerobic co-digestion of sewage sludge and pig manure. *J. Environ. Manage.* **70**:101–107.
- Narkis, N., S. Henefeld-Fourrier, and M. Rebhun. 1980. Volatile organic acids in raw wastewater and in physico-chemical treatment. *Water Research* **14**:1215-1223.
- Ortiz, G., C. A. Villamar, and G. Vidal. 2014. Odor from anaerobic digestion of swine slurry: influence of pH, temperature and organic loading. *Sci Agric.* **71**:443-450.
- Senturk, E., M. Ince, and G. O. Engin. 2014. The effect of shock loading on the performance of a thermophilic anaerobic contact reactor at constant organic loading rate. *Journal of Environmental Health Science & Engineering* **12**:84.
- Sharma, M. K., and A. A. Kazmia. 2015. Anaerobic onsite treatment of black water using filter-based packaged system as an alternative of conventional septic tank. *Ecological Engineering* **75**:457-461.
- Sharma, M. K., A. Khursheed, and A. A. Kazmia. 2014. Modified septic tank-anaerobic filter unit as a two-stage onsite domestic wastewater treatment system. *Environ. Technol.* **35**:2183–2193.
- Tervahauta, T., I. M. Bryant, L. H. Leal, C. J. N. Buisman, and G. Zeeman. 2014. Improved Energy Recovery by Anaerobic Grey Water Sludge Treatment with BlackWater. *Water* **6**:2436-2448.
- Todt, D. 2015. Source separating sanitary systems – energy efficient treatment of blackwater and minimizing greenhouse gas emissions. Norwegian University for Life Sciences, Norway.
- Todt, D., A. Heistad, and P. D. Jenssen. 2015. Load and distribution of organic matter and nutrients in a separated household wastewater stream. *Environmental Technology* **36**:1584-1593.
- van Lier, J. B., N. Mahmoud, and G. Zeeman. 2008. Anaerobic Wastewater Treatment in M. Henze, M. C. M. v. Loosdrecht, G. A. Ekama, and D. Brdjanovic, editors. *Biological Wastewater Treatment: Principles, Modelling and Design* IWA Publishing, London, UK.
- Voulvoulis, N. 2014. Understanding Systems and Their Complex Interrelationships: a Prerequisite to Solving Environmental Problems. Symbiosis International Conference Athens, Greece.
- Wiegant, W. M. 2001. Experiences and potential of anaerobic wastewater treatment in tropical regions. *Water Sci. Technol.* **44**:107-113.
- Yu, H.-Q., Z.-H. Hu, T.-Q. Hong, and G.-W. Gu. 2002. Performance of an anaerobic filter treating soybean processing wastewater with and without effluent recycle. *Process Biochemistry* **38**:507-513.
- Zeeman, G., and K. Kujawa-Roeleveld. 2011. Resource recovery from source separated domestic waste(water) streams; full scale results. *Water Science and Technology* **64**:1987-1992.
- Zeeman, G., K. Kujawa-Roeleveld, and G. Lettinga. 2001. Anaerobic treatment systems for high-strength domestic waste(water) streams. Pages 218–234 in P. Lens, G. Zeeman, and G. Lettinga, editors. *Decentralised Sanitation and Reuse*. IWA Publishing, UK.
- Zeeman, G., K. Kujawa, T. de Mes, L. Hernandez, M. de Graaff, L. Abu-Ghunmi, A. Mels, B. Meulman, H. Temmink, and C. Buisman. 2008. Anaerobic treatment as a core technology for energy, nutrients and water recovery from source-separated domestic waste (water). *Water Sci. Technol.* **57**:1207–1212.

# Anaerobic digestion of sieved, statically and mechanically thickened blackwater at different organic loading rates

Ref # S2SMALL-34705

C. G. Morandi<sup>1</sup>, K. Mouarkech<sup>2</sup>, S. Wasielewski<sup>2</sup>, R. Minke, H. Steinmetz<sup>1</sup>

<sup>1</sup> Kaiserslautern University of Technology, Faculty of Civil Engineering, Department of Resource-Efficient Wastewater Technology, Paul-Ehrlich-Straße 14, 67663, Kaiserslautern, Germany

<sup>2</sup> University of Stuttgart, Institute for Sanitary Engineering, Water Quality and Solid Waste Management, Chair of Sanitary Engineering and Water Recycling, Am Bandtäle 2, 70569, Stuttgart, Germany

\* Presenting Author: C. G. Morandi, [carlo.morandi@bauing.uni-kl.de](mailto:carlo.morandi@bauing.uni-kl.de)

**Keywords:** Biogas recovery, resource-oriented sanitation, small wastewater treatment system

## INTRODUCTION / MAIN METHODS

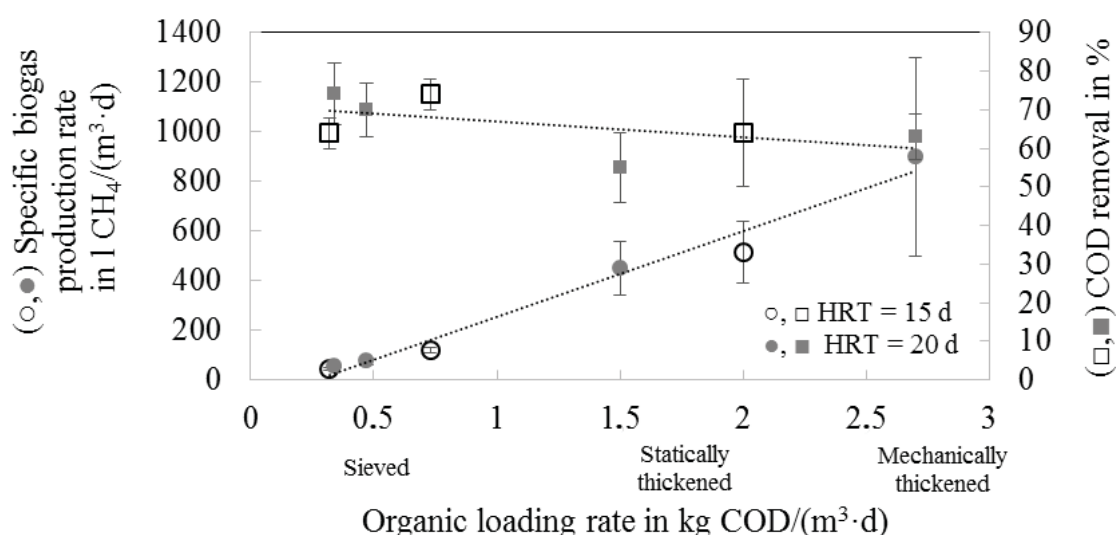
The municipal wastewater treatment sector is currently undergoing a period of rapid transformation; the focus herein is shifting from solely removing anthropogenic pollutants to more specific treatment strategies with source-separated sanitation, where the recovery of valuable resources from wastewater, such as energy, nutrients and water, plays a significant role (Zeeman and Kujawa-Roeleveld, 2013). This work centres on recovering biogas from blackwater using a 5 l Continuous Stirred Tank Reactor (CSTR). This reactor configuration is potentially suitable for small sanitation concepts, as it is a robust technology with low machine and control-related expenditures, which allows simple operation monitoring and maintenance (Hinken et al., 2015). Additionally, some studies have previously investigated blackwater digestion in Upflow Anaerobic Sludge Bed (UASB) Reactors (de Graaff et al., 2010). A few researchers also addressed the use of a CSTR for blackwater digestion, yet at relatively low OLRs or by adding co-susbrates like kitchen refuse (Wendland et al., 2007). However, to the best of the authors' knowledge, none has thus far used sieved or statically/mechanically thickened domestic blackwater as feedstock for anaerobic digestion. This research attempted to initially forgo coarse solids by sieving blackwater in order to understand how sieving impacts blackwater digestion. In a second step, two different thickening pre-treatment methods were adopted with the end goal of enhancing biogas production from household blackwater for effective, simple small treatment systems.

A 5 l lab-scale anaerobic CSTR was run for approx. 310 days with sieved blackwater as feedstock, which was collected from the vacuum toilets installed within the facilities of the Institute for Sanitary Engineering, Water Quality and Solid Waste Management at the University of Stuttgart. After a transition period, the reactor was eventually fed with statically or mechanically thickened blackwater for further 140 days. All experiments were carried out at 15 or 20 d hydraulic retention time (HRT) in order to investigate the impact of the HRT upon digestion. Sieved blackwater was characterised by a concentration of 2.4–10.5 g/l COD and 2.9–9.0 g/kg total solids (TS), while statically thickened blackwater consisted of 17.8–52.4 g/l CSB and 14–40 g/kg TS. For centrifuged blackwater, the COD concentration amounted to 34.9–65.1 g/l. The dissolved COD content in raw blackwater was determined to

27±10% of COD<sub>tot</sub> (n=52) and the COD/BOD<sub>5</sub> ratio to 1.9 (n=5). After sedimentation, the soluble COD in the blackwater feedstock reduced to 13±3% COD<sub>tot</sub> (n=8) and the COD/BOD<sub>5</sub> ratio increased to 2.3 (n=5).

## MAIN RESULTS AND CONCLUSIONS

Stable digestion of pre-treated blackwater allowed successful COD removal and production of biogas throughout all investigated phases, which can be inferred from Figure 1. For digestion of sieved blackwater at 0.32–0.73 kg COD/(m<sup>3</sup>·d), a HRT of 15 d has proved to be sufficient, which was potentially attributed to a faster hydrolysis due to the absence of coarse solids. Correspondingly, relatively high COD removals of 64–74 % were obtained at gas production rates of 43–120 l CH<sub>4</sub>/(m<sup>3</sup>·d). Figure 1 also elucidates the advantage of thickening, as it was observed that the OLR was linearly proportional to the gas production within the investigated range. 514 l CH<sub>4</sub>/(m<sup>3</sup>·d) were produced from statically thickened blackwater at 15 d HRT and 2.0 kg COD/(m<sup>3</sup>·d). At 20 d HRT and 1.5 COD/(m<sup>3</sup>·d) a slightly lower rate of 450 l/(m<sup>3</sup>·d) was achieved due to the lower loading to the reactor. In addition, the centrifuged influent produced in average 898 l CH<sub>4</sub>/(m<sup>3</sup>·d). However, with thickened blackwater slightly lower removals of 55–64 % COD were achieved in comparison to sieved blackwater due to higher OLRs and the slightly higher COD/BOD<sub>5</sub> ratio of thickened blackwater.



**Figure 1.** Specific methane production rates and removal efficiencies for blackwater digestion at different organic loading rates and hydraulic retention times.

In sum, the results showed that all investigated pre-treatments gave viable feedstock for use in blackwater treatment. On the one side, digestion of sieved blackwater was characterised by slightly higher removal efficiencies and allowed a satisfying reactor operation at both 15 d and 20 d HRT; on the other side, thickening blackwater provided the advantage of much higher biogas production rates for the same reactor volume.



## REFERENCES

de Graaff M. S., Temmink H., Zeeman G., Buisman C. J. N. 2010 Anaerobic Treatment of Concentrated Black Water in a UASB Reactor at a Short HRT. *Water* 2 (1), 101–119.

Hinken L., Austermann U., Meyer H. Urban I. 2015 Anaerobe Abwasserbehandlung zur Kohlenstoffelimination (Anaerobic wastewater treatment for carbon removal). In: Karl-Heinz Rosenwinkel, Helmut Kroiss, Norbert Dichtl, Carl-Franz Seyfried and Peter Weiland (ed.): *Anaerobtechnik. Abwasser-, Schlamm- und Reststoffbehandlung, Biogasgewinnung* (Anaerobic technology. Treatment of wastewater, sludge and residue materials, biogas production). 3. New and revised edition (German). Berlin: Springer Vieweg, pp. 283–351.

Wendland C., Deegener S., Behrendt J., Toshev, P., Otterpohl R. 2007 Anaerobic digestion of blackwater from vacuum toilets and kitchen refuse in a continuous stirred tank reactor (CSTR). *Water Science & Technology* 55 (7).

Zeeman G., Kujawa-Roeleveld K. 2013 Anaerobic treatment of source-separated domestic wastewater. In: Tove A. Larsen, Kai M. Udert und Judit Lienert (Hg.): *Source Separation and Decentralization for Wastewater Management*. London, New York: Iwa Publishing, pp. 307–319.

# Carbon footprint assessment and management of sludge and gaseous emissions in decentralized anaerobic-based sewage treatment plants

Ref # S2SMALL-27725

T. Bressani-Ribeiro<sup>1</sup>, E.M.F. Brandt<sup>2</sup>, V.R. Melo<sup>1</sup>, F.J. Bianchetti<sup>1</sup>, E. McAdam<sup>3</sup>, C.R. Mota Filho, C.A.L. Chernicharo<sup>1\*</sup>

<sup>1</sup> Federal University of Minas Gerais, Department of Sanitary and Environmental Engineering, Av. Antônio Carlos 6.627, Campus Pampulha, 31.270-901 - Belo Horizonte - MG - Brazil.

<sup>2</sup> Federal University of Juiz de Fora, Department of Sanitary and Environmental Engineering, Engineering College, Campus UFJF, 36036-330 - Juiz de Fora - MG - Brazil.

<sup>3</sup> Cranfield Water Science Institute, Cranfield University, Bedfordshire, UK.

\* Presenting Author: [calemos@desa.ufmg.br](mailto:calemos@desa.ufmg.br)

**Abstract:** Anaerobic-based sewage treatment plants (STPs) have an important role in the sanitation sector in Latin America. If well designed, built and operated, these STPs can effectively meet legal discharge standards. Nevertheless, there are commonly neglected problems whose solutions would bring significant environmental improvements. A few examples are the loss of dissolved methane in the treated effluent and incomplete biogas combustion in low-efficiency biogas burners, both associated with greenhouse gases emissions. The aim of this work was to identify the most suitable alternatives in terms of carbon emission minimization for the integrated management of biogas, diffuse emissions (waste gas) and sludge in small anaerobic-based STPs (10,000 Pe). Three different hypothetical scenarios were simulated to assess STPs carbon footprint, considering different strategies based on the most suitable options for the integrated management of by-products. Diffuse emissions were found to be the main source of carbon emissions from STPs, even when biogas is not used for thermal energy recovery. In order to effectively minimize GHG emissions from STPs, the use of biogas instead of LPG for cooking in the STP vicinity seems to be a key strategy.

**Keywords:** By-products management; biogas; UASB reactors; anaerobic sewage treatment, greenhouse gases

## INTRODUCTION

The use of anaerobic technology in sewage treatment plants (STPs) has significantly expanded in the last decades and is now considered a consolidated technology in Latin America (Chernicharo *et al.* 2015). However, one of the major limitations for an even wider use of anaerobic-based reactors (e.g. UASB reactors) is the management of CH<sub>4</sub> and H<sub>2</sub>S in the gas phase (biogas) and dissolved in the liquid phase (released as diffuse emissions). Odorous emissions (caused mainly by hydrogen sulfide) are known to affect the quality of life of local communities and methane emissions significantly contribute to the carbon footprint of the treatment process.

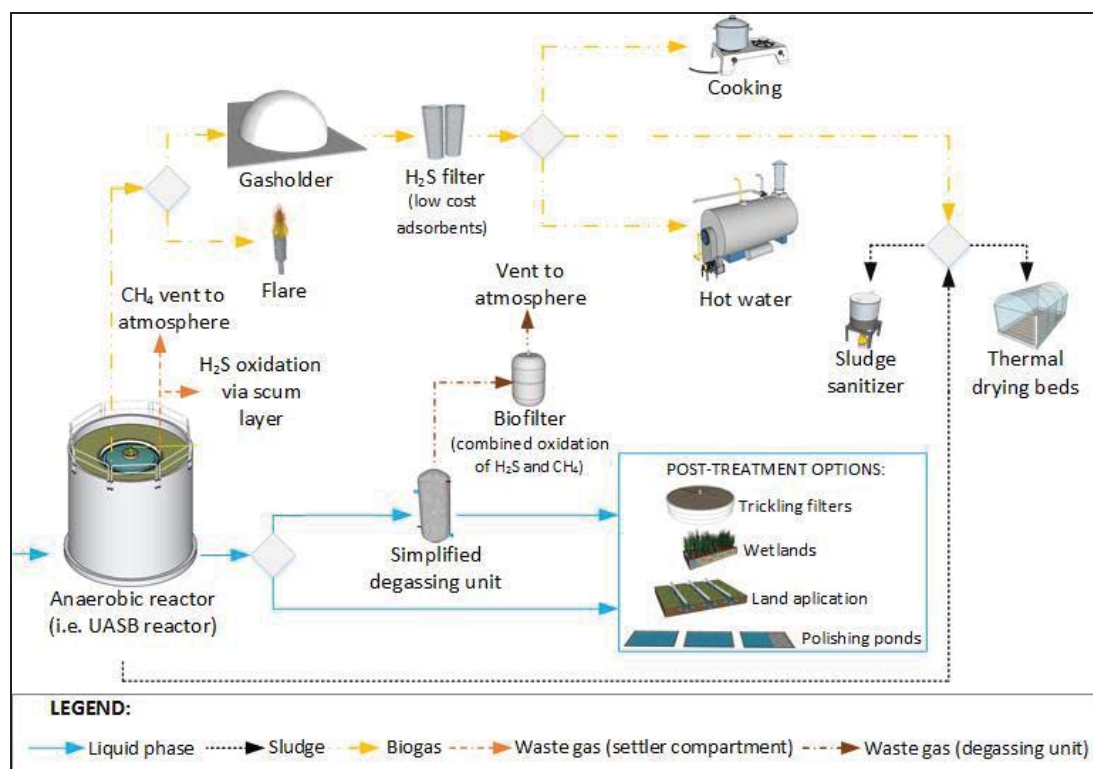
The advantages of anaerobic treatment are considered important attributes for developing more sustainable environmental technologies, such as little (close to none) demand for fossil fuels, simple and robust technology, and potential for resources recovery. Nevertheless, solid (sludge and scum) and gaseous (biogas) by-products are usually disposed of in landfills or flared, respectively. Although these routes are accepted in Brazil, they are not the most appropriate ones, due to their associated negative impacts in the atmosphere, soil and groundwater. Efforts to recover by-products are still incipient, mainly in small, decentralized

STPs. When accomplished, they occur in a disjointed manner, usually addressing only a few of the possible alternatives.

The aim of this work was to assess the most suitable alternatives in terms of carbon emission minimization for the integrated management of biogas, diffuse emissions (waste gas) and sludge in small anaerobic-based STPs (10,000 Pe). Three different hypothetical scenarios were simulated to assess the STPs' carbon footprint, considering different management strategies.

## MATERIALS AND METHODS

The most suitable options for the integrated management of by-products generated in small STPs were drawn up in a schematic flow-sheet (Figure 1), based on results obtained in several studies carried out by our research group (Borges *et al.* 2005; Souza *et al.* 2011; Lobato *et al.* 2012; Glória *et al.* 2016; Brandt *et al.* 2016; Rosa *et al.* 2016). For the liquid phase treatment, this proposed flow-sheet comprises a first anaerobic stage (UASB reactor) followed by a compact or an extensive aerobic post-treatment system (e.g trickling filters, wetlands, land application or polishing ponds). It is also possible to implement a simplified degassing unit to desorb  $H_2S$  and  $CH_4$  from the liquid phase (Glória *et al.* 2016), which would be followed by a biofilter for combined sulfide and methane abatement (Brandt *et al.* 2016).



**Figure 1.** Flow-sheet proposal for integrated by-products management in decentralized anaerobic-based STP (10,000 Pe)

The two considered alternatives for the management of sludge from small STPs were sludge sanitizers or thermal drying beds. When sanitizers are used, an increase in the sludge solids content is not expected (Borges *et al.* 2005) and such an option could be applied where the treated sludge (bio-solid) is used in the immediate vicinity of the STP (long-distance transportation not required). It is important to emphasize that sludge management for the extensive natural post-treatment options (wetlands, land application and polishing ponds) can

be neglected. This can also be accomplished with the trickling filters by using sponge-based systems (Almeida *et al.* 2013).

Alternatives for biogas management comprise its use for cooking or water heating in households near the STPs. Biogas is burned when thermal energy recovery is not applied.

A recently developed tool called “*Sulfide and Carbon Emission Avoidance and Energy Recovery in STPs*” (Chernicharo *et al.* in press) was used to perform the carbon footprint assessment of an anaerobic-based 10,000 Pe STP, considering three different scenarios (Table 1). The first one (*default scenario*) was proposed based on the typical configuration of UASB-based sewage treatment plants implemented in developing countries. In this case, the produced biogas is directly burned without energy recovery, the excess sludge goes to drying beds and there is no downstream dissolved gas management.

The second proposed scenario considered the following uses of the produced biogas: 90% of the estimated production (in terms of annual volume) was considered for sludge sanitization (Borges *et al.* 2005) and 10% directly flared. For the third simulated scenario, the same biogas proportion was considered for sludge sanitization purposes. However, the remaining biogas amount was equally divided for use in cooking and water heating for bathing in the vicinities of the STP.

**Table 1** – Proposed scenarios for simulation using the tool *Sulfide and Carbon Emission Avoidance and Energy Recovery in STPs*

Gas phase / Solid phase	Proposed scenarios – Management alternatives		
	Scenario 1 ( <i>Default</i> )	Scenario 2	Scenario 3
Biogas	Flaring	90% of the estimated biogas production was considered for sludge sanitization and 10% directly flared	90% of the estimated biogas production was considered for sludge sanitization and 10% equally divided for cooking and water heating in the STP vicinity
Diffuse emissions from settler compartment (waste gas)	Open air settler	Open air settler	Open air settler
Diffuse emissions from gases dissolved in effluent (waste gas)	No downstream dissolved gases management (sulfide and methane emissions to the atmosphere)	No downstream dissolved gases management (sulfide and methane emissions to the atmosphere)	Simple degassing unit (spray aeration) followed by a biofilter
Sludge	Drying beds	Drying beds	Sludge sanitizer or thermal drying beds

<sup>a</sup>All simulated scenarios considered the liquid phase passing through an aerobic post-treatment. Such a condition does not influence the management of gaseous emissions.

The aforementioned developed tool enables the determination of the amount of sulfide and methane in three different emission compartments, considering UASB-based STPs: internal surface of the gas-solid-liquid (GSL) separator - biogas hood; external surface of the GSL separator - settler compartment; and exit of a degassing unit - removal and/or recovery dissolved gases released from the anaerobic effluent (see Figure 1). Therefore, the tool allows the estimation of the total amount of methane supposed to be emitted into the atmosphere,

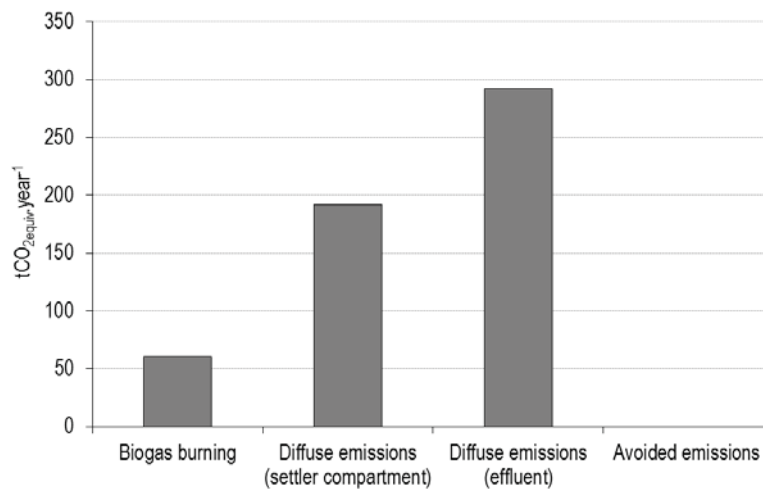
which is then converted to CO<sub>2</sub> equivalent, allowing the assessment of the carbon footprint of the STP. The main parameters and equations employed in the tool are described in Chernicharo *et al.* (in press).

## RESULTS AND DISCUSSION

In decentralized STPs, capacity and skills for operation and maintenance are limited, mainly in developing countries. Therefore, highly mechanized and complex options for the recovery and management of by-products should be avoided. The proposed schematic flow-sheet (Figure 1) considers simple alternatives for energy recovery from biogas and for controlling gaseous emissions from the liquid phase. Also, a simpler UASB reactor with an open-air settler was considered. This allows for the development of a scum layer containing phototrophic microorganisms able to oxidize H<sub>2</sub>S (Garcia *et al.* 2015). Notwithstanding, the unclosed settler compartment leads to diffuse CH<sub>4</sub> emissions.

### Scenario 1 (Default conditions)

The simulated default scenario took into account the typical flow-sheet for anaerobic-based STPs in developing countries, mainly in Latin America and Caribbean region (Chernicharo *et al.* 2015). In this case, the entire volume of the estimated biogas production is flared without recovery of the available energy (thermal) potential, contributing to the carbon footprint of the STP. Nevertheless, the most representative source of CO<sub>2</sub> equivalent emissions for Scenario 1 was associated with the absence of diffuse emissions control. Dissolved methane in the UASB reactor effluent accounts for 54% of the total carbon footprint of the STP, which is equivalent to 544.2 tCO<sub>2,equiv</sub>·year<sup>-1</sup> (54.4 kgCO<sub>2,equiv</sub>·inhab<sup>-1</sup>·year<sup>-1</sup>), as shown in Figure 2.

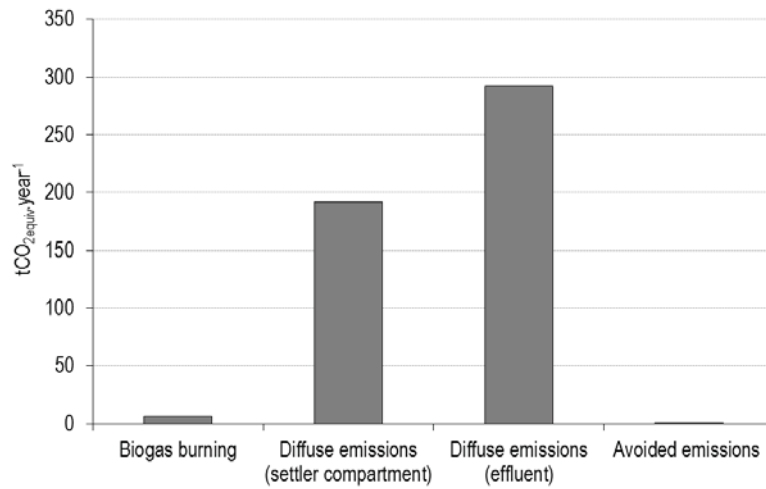


**Figure 2.** Carbon footprint for the simulated Scenario 1

### Scenario 2

The use of biogas for sludge treatment instead of flaring, as simulated in Scenario 2 (90% of the estimated biogas production for sanitization or thermal drying beds) consequently reduces by 90% the CO<sub>2</sub> equivalent emissions associated with biogas. The use of heat for drying excess sludge allows the production of bio-solids (84% TS; Possetti *et al.* 2015) that can be used in the vicinities of the STP, directly contributing to additional GHG emissions reduction of ca. 0.5 tCO<sub>2,equiv</sub>·year<sup>-1</sup> (5.4 kgCO<sub>2,equiv</sub>·inhab<sup>-1</sup>·year<sup>-1</sup>), due to lower consumption of fossil fuels for transport. It can be observed that the carbon footprint associated with diffuse emissions (settler compartment and effluent) for Scenario 2 is equal to that of Scenario 1. That is expected, since there is no management of dissolved methane in the liquid phase.

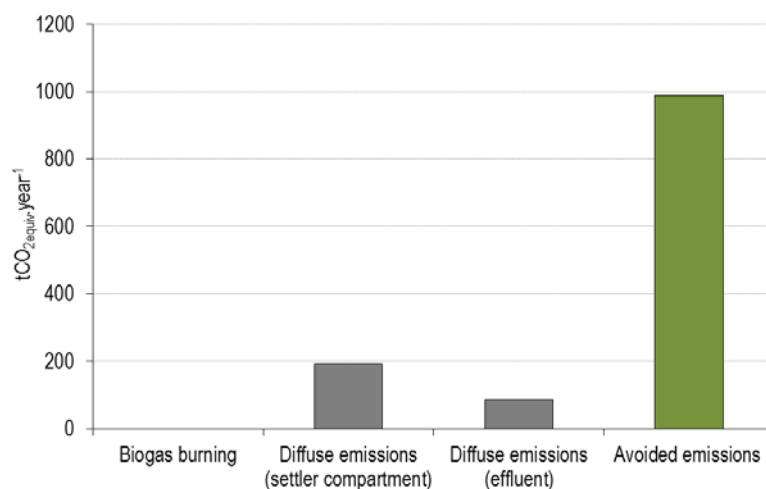
Regarding the simulated solid and gaseous phase management alternatives in Scenario 2, the balance between emitted and avoided CO<sub>2</sub> equivalents remains negative, as depicted in Figure 3. In this case, a total emission of 488.2 tCO<sub>2,equiv</sub>.year<sup>-1</sup> (48.8 kgCO<sub>2,equiv</sub>.inhab<sup>-1</sup>.year<sup>-1</sup>) was estimated.



**Figure 3.** Carbon footprint for the simulated Scenario 2

### Scenario 3

The use of biogas for cooking and water heating in the STP vicinity can avoid the emission of approximately 989.7 tCO<sub>2,equiv</sub>.year<sup>-1</sup> (98.9 kgCO<sub>2,equiv</sub>.inhab<sup>-1</sup>.year<sup>-1</sup>) to the atmosphere, as shown in Figure 4. Such a carbon footprint reduction was mainly related to the replacement of 5% of LPG used in the STP vicinity (in a volumetric base) by the estimated biogas production. As previously stated for Scenario 2, the use of heat to sanitize excess sludge contributes directly to further GHG emissions reductions of ca. 0.5 tCO<sub>2,equiv</sub>.year<sup>-1</sup> (0.05 kgCO<sub>2,equiv</sub>.inhab<sup>-1</sup>.year<sup>-1</sup>). In this case, biogas flaring would not be used. Simple desorption units (Glória *et al.* 2016) followed by sulfide and methane oxidation in biofilters (Brandt *et al.* 2016) can reduce the amount of dissolved gases in the final effluent, controlling odour nuisance and avoiding the emissions of approximately 164.8 tCO<sub>2,equiv</sub>.year<sup>-1</sup> (16.5 kgCO<sub>2,equiv</sub>.inhab<sup>-1</sup>.year<sup>-1</sup>) to the atmosphere. It is important to highlight the possibility of complete carbon neutralization in Scenario 3, which is clearly demonstrated in Figure 4.



**Figure 4.** Carbon footprint for the simulated Scenario 3



## CONCLUSIONS

- The developed tool “*Sulfide and Carbon Emission Avoidance and Energy Recovery in STPs*” allows a comparative characterization of the main sources of carbon emissions in anaerobic-based STPs. This can be useful for decision makers in trade off analyzes of investments in small STPs infrastructure.
- The control of diffusive emissions seems to be crucial to mitigating the carbon footprint of small anaerobic-based STPs. In order to effectively neutralize carbon emissions, the use of biogas instead of LPG for cooking in the STP vicinity provides significant reductions of GHG emissions.

## ACKNOWLEDGMENTS

The authors would like to acknowledge the support obtained from the Prosperity Fund (United Kingdom) and the following Brazilian institutions: *Conselho Nacional de Desenvolvimento Científico e Tecnológico – CNPq; Coordenação de Aperfeiçoamento de Pessoal de Nível Superior – CAPES; Fundação de Amparo à Pesquisa do Estado de Minas Gerais – FAPEMIG; Instituto Nacional de Ciência e Tecnologia em Estações Sustentáveis de Tratamento de Esgoto – INCT ETEs Sustentáveis (INCT Sustainable Sewage Treatment Plants).*

## REFERENCES

- Almeida, P.G.S; Marcus, A.K.; Rittmann, B.E.; Chernicharo, C.A.L. 2013 Performance of plastic- and sponge-based trickling filters treating effluents from an UASB reactor. *Water Science and Technology*, **67**(5), 1034-1042.
- Borges, E.S.M., Godinho, V.M, Chernicharo, C.A.L. 2005 Thermal hygienization of excess anaerobic sludge: a possible self-sustained application of biogas produced in UASB reactors. *Water Science and Technology*, **52**(10-11), 227-234.
- Brandt, E.M.F., Duarte, F.V., Vieira, J.P.R., Melo, V.M., Souza, C.L., Araujo, J.C., Chernicharo, C.A.L. 2016 The use of novel packing material for improving methane oxidation in biofilters. *Journal of Environmental Management*, **182**, 412-420.
- Chernicharo, C.A.L., van Lier, J.B., Noyola, A., Ribeiro, T.B. 2015 Anaerobic sewage treatment in Latin America. In: *Anaerobic Biotechnology: Environmental Protection and Resource Recovery*. 1<sup>st</sup> ed. (H. P. Fang & T. Zhang, Org.). Imperial College Press, London, pp. 263–296.
- Chernicharo, C.A.L., Brandt, E.M.F, Bressani-Ribeiro, T., Melo, V.R., Bianchetti, F.J., Mota Filho, C.R., McAdam, E. Development of a tool for improving the management of gaseous emissions in UASB-based sewage treatment plants. In: *7th Conference on Odours and Air Emissions*, Warsaw, Poland. *In press*
- Lobato, L.C.S., Chernicharo, C.A.L., Souza, C.L. 2012 Estimates of methane loss and energy recovery potential in anaerobic reactors treating domestic wastewater. *Water Science and Technology*, **66**(12), 2745-2753.
- Garcia, G. P. P., Oliveira, R. C., Bicalho, S. K., Franco, V., Gontijo, E. M., Toscano, R. A., Canhestro, K. O., Santos, M. R., Carmo, A. L. D., Lobato, L. C., Brandt, E. M., Chernicharo, C. A. L., Araujo, J. C. 2015 Biological sulphide removal from anaerobically treated domestic sewage: Reactor performance and microbial community dynamics. *Environmental Technology*, **36**, 1-26.

Glória, R.M., Motta, T.M., Silva, P.V.O., Costa, P., Brandt, E.M.F., Souza, C.L., Chernicharo, C.A.L. 2016 Stripping and dissipation techniques for the removal of dissolved gases from anaerobic effluents. *Brazilian Journal of Chemical Engineering*, **33**(4), 713-721.

Possetti, G.R.C., Rietow, J.C., Gervasoni, R., Althoff, O. A., Carneiro, C. 2015 Investigação experimental de um sistema piloto de secagem térmica de lodo movido a biogás (*Experimental investigation of a pilot-scale system for sludge thermal drying using biogas*). In: *Brazilian Congress on Sanitary and Environmental Engineering*. Rio de Janeiro, Brazil.

Rosa, A.P., Conesa, J.A., Fullana, A., Melo, G.C., Borges, J.M., Chernicharo, C.A.L. 2016 Energy potential and alternative usages of biogas and sludge from UASB reactors: case study of the Laboreaux wastewater treatment plant. *Water Science and Technology*, **73**(7), 1680-1690.

Souza, C.L., Chernicharo, C.A.L., Aquino, S.F. Quantification of dissolved methane in UASB reactors treating domestic wastewater under different operating conditions. 2011 *Water Science and Technology*, **64**, 2259.

## **Coupling wastewater treatment based on microalgae-bacteria to continuous methane recovery: effect of the digester temperature**

**Carrillo-Reyes, J.<sup>1</sup>, Arcila, J.S.<sup>1</sup>, Buitrón, G.<sup>1</sup>**

<sup>1</sup> Laboratory for Research on Advanced Processes for Water Treatment, Unidad Académica Juriquilla, Instituto de Ingeniería, Universidad Nacional Autónoma de México, Blvd. Juriquilla 3001, Querétaro 76230, México.

**Keywords:** Methane; high rate algal pond; microalgae-bacteria biomass

### **Introduction**

The microalgae are an attractive feedstock for biofuels production, and can accumulate lipids and carbohydrates, fix CO<sub>2</sub>, and have a fast growing rate. The microalgae culturing in wastewater plays a treatment effect, reducing the COD (chemical oxygen demand) and removing N and P. In addition, microalgae drives a photosynthetic oxygenation, which is used, by heterotrophic aerobic bacteria to mineralize organic matter, and to generate CO<sub>2</sub> used in turn by microalgae. This association microalgae-bacteria (Mab) is able to reduce operational costs over conventional aerobic wastewater treatment processes (Muñoz and Guieysse, 2006). That natural formed Mab colonies self-aggregate in flocs or granules; in this sense, Arcila and Buitrón (2016) developed Mab granules close to 2.5 mm of diameter, in an HRAP (high rate algal pond) treating domestic wastewater, which achieved 98.3% of settleability. Then, the recovered wet Mab biomass can be anaerobically digested to produce methane.

The coupling of wastewater treatment based on Mab cultivation to methane production, potentially may increase the energy gain and reduces production cost. In order to increase the methane recovery from Mab biomass, different temperatures during digestion have been proposed, where thermophilic temperature may accelerate the hydrolysis rate over mesophilic one (Cea-Barcia et al., 2015). In the present work, the effect of different temperatures, mesophilic and thermophilic, were evaluated for the continuous methane production in the long term, using Mab biomass as substrate. Mas flocs were obtained from an outdoor HRAP treating domestic wastewater. In addition, the energy balance was calculated considering the energy inputs since the Mab grow in the HRAP and the energetic potential of the methane production.

### **Material and Methods**

The Mab biomass was produced in an outdoor HRAP of 50 L (working volume) treating domestic wastewater with a hydraulic retention time (HRT) of 10 d. The Mab flocs were withdrawn every three days from a sedimentation tank during 300 days. The Mab biomass was digested in an anaerobic completely stirred tank reactor (AnCSTR) of 1.5 L (working volume) inoculated with granular anaerobic sludge. The AnCSTR was daily fed at a constant organic loading rate of 1.1 kg VS (volatile solids)/L-d, mixing at 150 rpm and temperature control using a water bath and recirculation. Two HRT, 15 and 30 days, and operational temperatures, 35°C and 55°C, were evaluated during the 280 days of continuous operation.

## Results and Discussion

In the HRAP the initial COD of domestic wastewater ( $816 \pm 129$  mg/L) was reduced 83 %, having a stable performance in terms of COD,  $N-NH_4^+$  and  $P-PO_4^{3-}$  removal during 300 days of operation. The productivity of Mab biomass in the HRAP was  $11.6 \pm 4.3$  g VS/m<sup>2</sup>·d. That biomass was daily fed to the digester, after sedimentation.

Regarding the digestion of Mab biomass, among the scarce scientific works evaluating the continuous methane production using Mab biomass (Passos et al., 2014), up to our knowledge, this is the first report evaluating thermophilic and mesophilic temperatures in the long term. Considering only the stable periods, an HRT of 30 d a clear advantage using thermophilic over mesophilic digestion was observed, increasing in average 55% the yield obtained. For both temperatures at 30 d of HTR, the chemical oxygen demand (COD) removal range from 60-62%. Our results contradict the results of Wieczorek et al. (2015), who stated that the thermophilic temperature in batch tests did not increase the methane yield, which is explained by the short period of fermentation (29 days) using an inoculum adapted to mesophilic conditions.

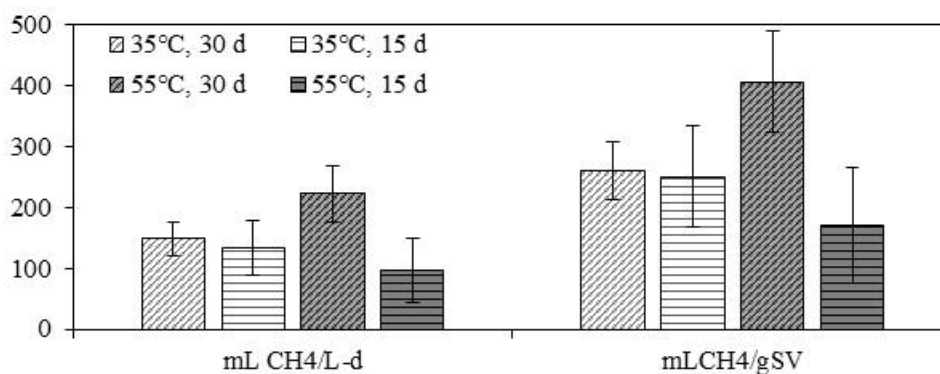


Figure 1. Methane productivity and yield obtained from different conditions evaluated in the AnCSTR.

This work demonstrates the suitability of coupling wastewater treatments process based on HRAP and the thermophilic digestion of the Mab biomass produced, in terms of methane production.

## Acknowledgements

This study was financially supported by “Fondo de Sustentabilidad Energética SENER – CONACYT (Mexico)”, through the project 247006 Gaseous Biofuels Cluster and DGAPA-UNAM (PAPIIT IN101716)

## References

- Arcila, J.S., Buitrón, G., 2016. Microalgae-bacteria aggregates: effect of the hydraulic retention time on the municipal wastewater treatment, biomass settleability and methane potential. *J. Chem. Technol. Biotechnol.* 91, 2862–2870
- Cea-Barcia, G., Moreno, G., Buitrón, G., 2015. Anaerobic digestion of mixed microalgae cultivated in secondary effluent under mesophilic and thermophilic conditions. *Water Sci. Technol.* 72, 1398–13403.

- Muñoz, R., Guieysse, B., 2006. Algal–bacterial processes for the treatment of hazardous contaminants: A review. *Water Res.* 40, 2799–2815.
- Passos, F., Hernández-Mariné, M., García, J., Ferrer, I., 2014. Long-term anaerobic digestion of microalgae grown in HRAP for wastewater treatment. Effect of microwave pretreatment. *Water Res.* 49, 351–359.
- Wieczorek, N., Kucuker, M.A., Kuchta, K., 2015. Microalgae-bacteria flocs (MaB-Flocs) as a substrate for fermentative biogas production. *Bioresour. Technol.* 194, 130–136.

# Sequential “electrochemical-peroxidation – electro-Fenton” process for the treatment of anaerobic sludge from a poultry farm

Ref # S2SMALL-67685

H. Olvera-Vargas<sup>1</sup>, X. Zheng<sup>1</sup>, O. Lefebvre<sup>1\*</sup>

<sup>1</sup> National University of Singapore, 1 Engineering Drive 2, Singapore 117576, Singapore

\* Corresponding Author: [ceelop@nus.edu.sg](mailto:ceelop@nus.edu.sg)

**Abstract:** In this study, we present a sequential electrochemical process for anaerobic sludge treatment combining electrochemical peroxidation (ECP) and electro-Fenton (EF). In the first step, ECP (consisting of H<sub>2</sub>O<sub>2</sub>-assisted electrocoagulation with iron electrodes) was applied as a conditioning and stabilizing method. COD, TOC and TSS were considerably reduced by 85%, 90% and 86%, respectively, after 2-h treatment under optimized conditions (initial pH of 5, 5:1 H<sub>2</sub>O<sub>2</sub>/Fe<sup>2+</sup> dose ratio and 10 mA cm<sup>-2</sup>), and sludge with good settling and compaction properties was generated. In the second step, EF was used to mineralize the remaining organic fraction in the filtrate. Remarkably, after 4 h of EF under optimal conditions (pH 3 and 500 mA), the COD content was only slightly higher than the Singaporean standard limit for discharge into watercourse (100 mg L<sup>-1</sup>), with an overall cost of S\$ 0.05 L<sup>-1</sup> sludge.

**Keywords:** anaerobic sludge, electrochemical peroxidation, electrocoagulation, electro-Fenton, wastewater treatment.

## INTRODUCTION

As a consequence of the growth of human population, the number of wastewater treatment plants (WWTP) has significantly increased over the recent years. These facilities produce large quantities of sludge generated by the universally used aerobic and anaerobic wastewater treatments (Christensen *et al.* 2015). In fact, the complex characteristics of sludge render treatment and disposal difficult and expensive and as a result, sludge management already represents over 60% of the total cost of conventional WWTPs (Zhou *et al.* 2014). Incineration, landfilling and land application are the most commonly used disposal options. Dewatering is a crucial step in sludge treatment before final disposal, since it reduces the volume and hence transporting and total costs. It is thus a major concern in sludge treatment technology (Christensen *et al.* 2015; Zhou *et al.* 2014). Conventional biological and physicochemical methods for sludge treatment require high energy consumption and long retention times, and their efficiencies are limited. On the other hand, Advanced Oxidation Processes (AOPs), based on the formation of the strong oxidant, hydroxide radical (<sup>•</sup>OH), have attracted great attention as treatment alternatives for sludge conditioning, as they possess the capability of degrading extracellular polymeric substances and disrupting sludge flocs for settleability and dewatering improvement (Pilli *et al.* 2015; Zhou *et al.* 2014). Amidst AOPs, electrochemical methods (EAOPs) have shown multiple advantages in the treatment of wastewater from many different sources, including pharmaceutical, dye-stuff, landfill leachate, agricultural and so on (Moreira *et al.* 2017; Martínez-Huitle *et al.* 2015). These environmentally friendly processes are characterized by the *in-situ* electrochemical generation of the oxidants and the lack of secondary sludge formation. Moreover, they operate at mild conditions and can economically compete with chemical AOPs (Cañizares *et al.* 2009). The electro-Fenton process (EF) is one of the most widespread technologies, which relies on the generation of <sup>•</sup>OH in the bulk solution by means of the Fenton’s reaction (Eq. 4), that is promoted by the cathodic production of the Fenton’s reagent (H<sub>2</sub>O<sub>2</sub> and Fe<sup>2+</sup>) in acidic



solutions containing catalytic amounts of  $\text{Fe}^{2+}$  ions, according to Eq. 1 and 2 (Moreira *et al.* 2017; Brillas *et al.* 2009). In some applications, the use of an iron anode during EF provides the  $\text{Fe}^{2+}$  ions required for the Fenton's reaction, which accumulate in the solution during the electrolysis (Daghrir & Drogui 2013). Carbonaceous electrodes such as carbon felt, gas diffusion electrodes, carbon fibers, carbon sponge, graphene, among others, are the preferred cathode materials for EF (Brillas *et al.* 2009). In addition, the efficiency of the EF process can be enhanced when it is coupled with anodic oxidation (AO) by using a powerful boron-doped diamond (BDD) anode. Thereby,  $\cdot\text{OH}$  are homogeneously (Eq. 3) and heterogeneously (Eq. 4) produced (Sopaj *et al.* 2016).



Undoubtedly, electrochemical technologies represent potential options for wastewater treatment at industrial scale and in decentralized systems. In this sense, despite not being considered as an EAOP, electrocoagulation (EC) is a powerful technique that has found diverse applications for the treatment of highly polluted industrial wastewater and as part of a treatment train (An *et al.* 2017). The electrochemical production of the coagulants (aluminum or iron oxyhydroxides) from a sacrificial anode promotes contaminants agglomeration and precipitation. EC has also been coupled to the chemical Fenton process by addition of  $\text{H}_2\text{O}_2$ , promoting an oxidative environment which favors the degradation of organic substances, the so-called "electrochemical peroxidation" (ECP) (Moreira *et al.* 2017; Brillas *et al.* 2009). As a matter of fact, some electrochemical methods have been applied to sludge dewatering and stabilization. However, results have not been conclusive and the removal of organic matter has remained low (Curteanu *et al.* 2014; Bureau *et al.* 2012).

In this context, the present work presents a sequential treatment strategy based on electrochemical technologies for the remediation of anaerobic sludge. In the first step, sludge conditioning and stabilization was assessed by means of electrocoagulation (EC) with iron electrodes. Optimization of the process was made in terms of the cathode material (iron and graphite) and in the presence or absence of  $\text{H}_2\text{O}_2$ . In the second step,  $\text{H}_2\text{O}_2$ -assisted electrocoagulation (ECP) with iron electrodes was selected as the conditioning and stabilising method and the operating parameters were optimized (initial pH,  $[\text{Fe}^{2+}]/[\text{H}_2\text{O}_2]$  dose ratio and current). Finally, the EF process (BDD/carbon brush cell configuration) was used to achieve complete mineralization of the remaining organic fraction in the filtrate. Our goal is to present electrochemical technology as a sustainable solution for sludge remediation through a two-step integrated process. An economic assessment is finally presented.

## MATERIALS AND METHODS

### Sample collection and characteristics.

The sample came from a poultry farm in Singapore, which generates approximately 150 tons per day of anaerobic sludge; this sludge requiring proper attention before disposal. It contains very high Chemical Oxygen Demand (COD) and total suspended solid (TSS), which is far from reaching the National Environmental Agency (NEA) sewer discharge standards. The samples were collected and stored in polypropylene containers at 4 °C. The chemical characterization of the raw sample is presented in Table 1.

**Table 1.** Chemical composition of the anaerobic sludge with the NEA permissive discharge levels.

Parameters	Values	Discharge limit (public sewer)*	Discharge limit (watercourse)*
pH	7.8 - 8.2	6 – 9	6 – 9
COD (mg L <sup>-1</sup> )	25800	600	100
BOD <sub>5</sub> (mg L <sup>-1</sup> )	4000	400	50
TOC (mg L <sup>-1</sup> )	5405	-	-
TSS (mg L <sup>-1</sup> )	29300	400	50
TDS (mg L <sup>-1</sup> )	9400	3000	2000
P-PO <sub>4</sub> (mg L <sup>-1</sup> )	6800	-	5
N-NH <sub>4</sub> (mg L <sup>-1</sup> )	4730	-	-
N-NO <sub>3</sub> (mg L <sup>-1</sup> )	800	-	-
Total N (mg L <sup>-1</sup> )	4527	-	-
Fe (mg L <sup>-1</sup> )	8.08	50	20

\*Source: National Environmental Agency, Singapore

### Experimental setup.

Due to the complex nature of the sample, a conditioning step was done before each experiment based on preliminary tests (data not shown). K<sub>2</sub>SO<sub>4</sub> 0.1 M was added as supporting electrolyte and the pH was adjusted to a value of 5 using H<sub>2</sub>SO<sub>4</sub> in order to promote hydrolysis of the cell polymeric substances. All the experiments consisted of conducted in a batch glass electrolytic reactor with 0.5 L capacity, powered by a HAMEG 7042-5 power supply (Germany). For the EC and ECP trials, both anode and cathode were pure Fe plates with dimensions 5 x 6.5 x 0.5 cm. The gap between the electrodes was fixed at 4 cm. The working volume was 400 mL and the experiments were conducted at room temperature with constant stirring at 500 rpm. For ECP experiments, H<sub>2</sub>O<sub>2</sub> (30% w/w) was manually added at a fixed time interval of 10 minutes for the first hour and 15 minutes for the second hour. The pH of the treated sample was adjusted to 9 at the end of treatment in order to promote the precipitation of Fe(OH)<sub>3</sub>. The treated effluent was filtered with vacuum to separate the filtrate from the solid sludge. The sludge was dried in an oven at 55°C overnight for further analysis. 175 mL of the filtrate were recovered and acidified to pH 3 before EF treatment. For EF, a BDD anode (15 x 2.5 x 0.1 cm) and a carbon brush cathode were utilized.

### Analytical methods

COD, phosphate (P-PO<sub>4</sub>), nitrite (N-NO<sub>2</sub>), nitrate (N-NO<sub>3</sub>) and ammonium (N-NH<sub>4</sub>) concentrations were determined with colorimetric standard methods using HACH vials tests. Total Organic Carbon (TOC) and Total Nitrogen (TN) were determined using a Shimadzu TOC-V CSH analyser. Biochemical oxygen demand at 5 days (BOD<sub>5</sub>) was determined by respirometric method using an OxiTop® control system (WTW GmbH, Germany). TSS content was measured using a standard method (American Public Health Association, 1999). The efficiency of treatment was analysed based on the respective TSS, COD and TOC removal efficiencies. For the ECP experiments, the samples were analysed after they settled down for one hour. The pH was measured with a VWR pHenomenal MU 6100H pH-meter. For most EC-based experiments, the pH of the sample increased from 5 to 8. Determination of iron was carried out by inductively coupled plasma optical emission spectrometry (ICP-OES, PerkinElmer, America).

## Cost calculation

For feasibility evaluation, an economic analysis was made taking into consideration the costs associated to the chemical consumption, energy consumption, and cost of sludge disposal. The energy consumption was calculated based on Eq. 5, where  $E_{cell}$  is the applied voltage (V),  $I$  is the current (A),  $t$  is the experiment duration (h) and  $V_s$  is the sample volume (L).

$$\text{Energy consumption (kWh L}^{-1}\text{)} = (E_{cell}It/1000V_s) \quad (5)$$

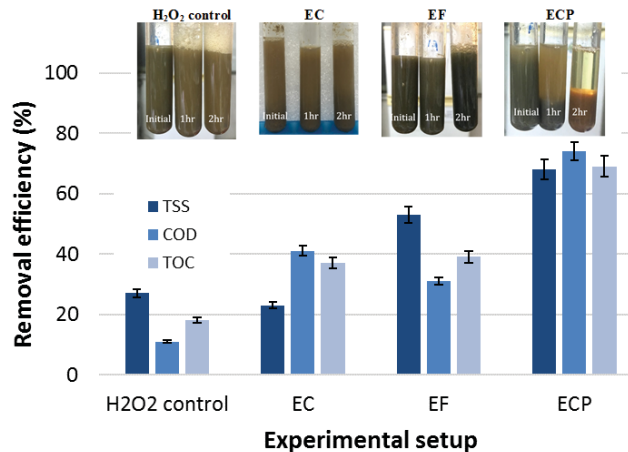
In accordance with Singapore Power (SP) 2017 tariffs, the energy price was estimated at S\$ 0.16 kWh. For the chemicals,  $H_2SO_4$  (96% w/w) was evaluated at S\$ 0.2  $kg^{-1}$  and KOH at S\$ 0.2  $kg^{-1}$ . The electrolyte  $K_2SO_4$  was estimated at S\$ 0.2  $kg^{-1}$ , while  $H_2O_2$  (30% w/w) accounted for S\$ 0.4/kg. Disposal costs for dehydrated sludge, including transportation and charges for waste disposal, were evaluated at S\$ 0.1  $kg^{-1}$  of wet dehydrated sludge by assuming that these residues were not considered hazardous material (National Environment Agency SG). The total cost (S\$  $L^{-1}$  sample) was calculated according to Eq. 6:

$$\text{Total Cost S\$ L}^{-1} \text{ sludge} = \frac{\text{Power cost (S\$)} + \text{Chemical Cost (S\$)} + \text{Sludge cost (S\$)}}{\text{Volume of Sample (L)}} \quad (6)$$

## RESULTS AND DISCUSSION

### Conditioning and stabilization: preliminary tests

The primary objective of the present part was to investigate the best strategy for sludge conditioning, aiming at disrupting the floc structure of the sludge. For this purpose, EC with Fe anode was used as the basis for the treatment. Three experimental strategies were explored: i) EC with both iron electrodes, ii) EF using a graphite cathode and iii) ECP with iron electrodes and external addition of  $H_2O_2$ . The electrolyses were performed at 500 mA (corresponding to 15.4  $mA\ cm^{-2}$ ) and the efficiency was evaluated in terms of TSS, COD and TOC removal and results are presented in Fig. 1.



**Fig. 1.** Removal efficiency of preliminary experiments. Experimental conditions:  $V = 400$  mL,  $pH = 5$ ,  $Na_2SO_4 = 0.1$  M,  $i = 500$  mA, 2 h-treatment. For EC, two iron plates were used as electrodes. For EF, iron anode and graphite cathode. For ECP (iron electrodes),  $H_2O_2$  was progressively added during the treatment.

The results showed limited TSS, COD and TOC removal efficiencies by EC or EF, while the best performance was achieved by means of ECP (68, 74 and 69% of TSS, COD and TOC removal efficiency, respectively). These results can be explained in terms of the complexity of the sludge sample (high content of organic matter and suspended solids, and low filterability). In the case of EC, the coagulation process promoted by the electrochemical release of

$\text{Fe}^{2+}/\text{Fe}^{3+}$  ions was not efficient enough to disrupt the polymeric material and induce proper coagulation. For EF (Fe anode and graphite cathode), two issues were encountered: first, the electrochemical production of  $\text{H}_2\text{O}_2$  on the surface of graphite was not sufficient for the constant production of  $\cdot\text{OH}$  via the Fenton's reaction (Eq. 3) and second, the rate of the Fenton's reaction was slow at the operating pH of 5. It is well known that the Fenton's reaction has an optimal operating value of 3 according to  $\text{Fe}^{3+}$  ions speciation in solution (Pignatello *et al.* 2006). One EF experiment was performed at pH 3 (results not shown) and the removal efficiencies were not significantly improved. Although many studies have demonstrated that EF is very efficient in degrading organic matter (Moreira *et al.* 2017; Brillas & Martínez-Huitle 2015), its direct application to a highly contaminated anaerobic sludge waste in this investigation did not give satisfactory results.

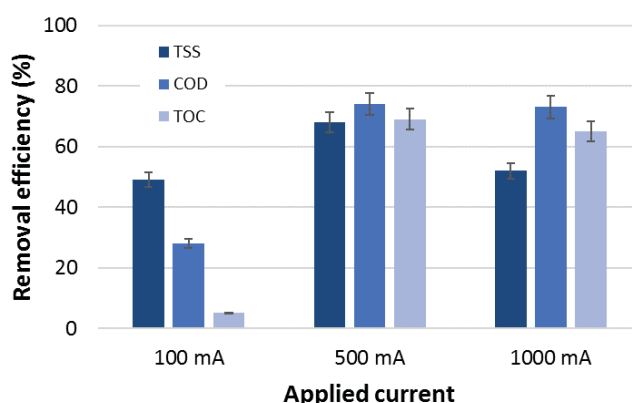
The external addition of  $\text{H}_2\text{O}_2$  in ECP (1:5  $[\text{Fe}^{2+}]/[\text{H}_2\text{O}_2]$  ratio, calculated from the theoretical amount of iron released from the anode according to Faraday's law,  $m = ItM_w/nF$ ) significantly enhanced the removal efficiencies, dramatically improving EC performance. In fact,  $\text{H}_2\text{O}_2$  promoted the Fenton's reaction for the production of  $\cdot\text{OH}$ , which contributed to the oxidation of the organic material, ultimately provoking disintegration of the sludge flocs, releasing free water and exposing cellular material to further oxidative attack. In this way sludge conditioning and stabilization was effectuated by a combined coagulation/Fenton's oxidation process. The control experiment with  $\text{H}_2\text{O}_2$  addition without application of external current evidenced the low oxidative power of  $\text{H}_2\text{O}_2$  in the absence of  $\text{Fe}^{2+}$  ions: TSS, COD and TOC were only removed by 32%, 11% and 18%, respectively. The inset panel in Fig. 1 depicts the visual appearance of the samples throughout the experimental period.

### ECP optimization

Taking into account the preliminary experiments, ECP was selected as the conditioning and stabilizing method. Accordingly, the process was optimized with relation to the main parameters affecting its performance, namely: pH, current and  $[\text{Fe}^{2+}]/[\text{H}_2\text{O}_2]$  ratio.

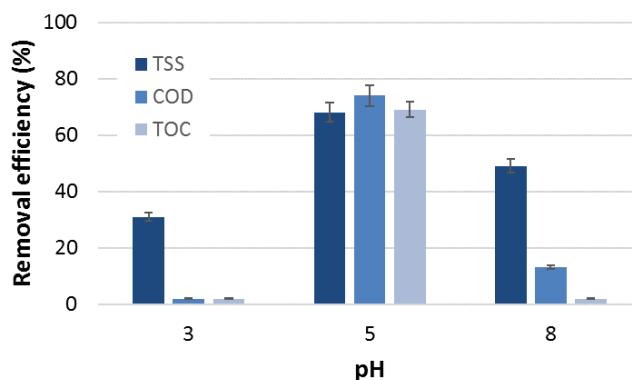
Current density is a key operating parameter affecting the performance of electrochemical processes since it controls the rate of the electrochemical reactions taking place. In the case of EC and related processes, it is particularly important because, according to the Faraday's law, current is directly linked to the production of  $\text{Fe}^{2+}$  ions, whose precipitation as  $\text{Fe}(\text{OH})_3$  determine the coagulation efficiency. Furthermore, when  $\text{H}_2\text{O}_2$  is used (ECP), the amount of dissolved  $\text{Fe}^{2+}$  also determines the chemical production of  $\cdot\text{OH}$  (Eq. 3). Thus, the performance of ECP was investigated at different current values (100 mA, 500 mA and 1000 mA) with initial pH 5 and  $[\text{Fe}^{2+}]/[\text{H}_2\text{O}_2]$  ratio of 1:5. Results are presented in Fig. 2, showing that the removal efficiency increased as the current increased from 100 mA to 500 mA, with the latter value giving the best TSS, COD and TOC removal efficiencies (68%, 74% and 69% respectively). This behaviour can be explained in terms of the amount of  $\text{Fe}^{2+}/\text{Fe}^{3+}$  ions produced during the electrolysis, which increased with current density. Thus, an increase in both coagulant dose and  $\text{Fe}^{2+}/\text{Fe}^{3+}$  free ions, resulted in a better coagulation/oxidation ECP process. On the contrary, the application of higher current values (1000 mA) did not help further increase the removal efficiency, which can be ascribed to: i)  $\text{H}_2\text{O}_2$ 's higher tendency to oxidize to  $\text{O}_2$  at high current as shown in reaction 7 and 8 and most importantly ii) an excess of  $\text{Fe}^{2+}$  ions that promoted the competitive waste reactions 9 and 10, consuming  $\cdot\text{OH}$ . Moreover, the rise in current density (and in the applied potential consequently) entails heat generation and higher energy consumption, thus, the current density shouldn't be increased to very high values to prevent such adverse effects (the optimal value was 500 mA).





**Fig. 2.** Effect of current on the TSS, COD and TOC removal efficiency at pH 5 and 1:5  $[\text{Fe}^{2+}]/[\text{H}_2\text{O}_2]$  ratio. ECP with iron plate electrodes.  $V = 400 \text{ mL}$ ,  $\text{Na}_2\text{SO}_4 = 0.1 \text{ M}$ , 2 h-treatment.

The pH plays a fundamental role in ECP as it affects iron solubility, complexation and redox cycling between  $\text{Fe}^{2+}$  and  $\text{Fe}^{3+}$  ions (Brillas *et al.* 2009; Yahiaoui *et al.* 2011). To examine the effect of pH on the treatment of anaerobic sludge, a series of experiments with pH ranging from 3 to 8 (with 8 being the initial pH of the sludge sample) were conducted under 500 mA of current and a  $[\text{Fe}^{2+}]/[\text{H}_2\text{O}_2]$  ratio of 1:5. The results (Fig. 4) showed that ECP displayed the best efficiencies under slightly acidic condition (pH 5) with 68%, 74% and 69% of TSS, COD and TOC removal efficiency, respectively. Even though Fenton-based processes generally operate optimally in acidic medium (pH between 2 and 4), during ECP, the efficiency of the Fenton's reaction is coupled to the coagulation process, whose optimal pH value is found between 5-8 due to  $\text{Fe}(\text{OH})_3$  formation (Lakshmanan *et al.* 2009). Accordingly, the performance is governed by a compromise between electrocoagulation and Fenton's oxidation. In this way, under acid conditions, coagulation efficiency dropped, dramatically impacting ECP performance. On the other hand, at high pH values (pH 8), the rate of the Fenton's reaction was significantly diminished as ferric hydroxide precipitated, hence hindering the production of  $\cdot\text{OH}$ . Additionally, at higher pH, the scavenging of  $\cdot\text{OH}$  by carbonate species ( $\text{CO}_3^{2-}/\text{HCO}_3^-$ ) is another factor that led to a decrease in the removal efficiency (Pignatello *et al.* 2006). The optimal pH value of 5 favoured both coagulation and Fenton's oxidation, ensuring enough  $\text{Fe}^{2+}$  ions for  $\text{H}_2\text{O}_2$  decomposition via the Fenton's reaction, while a progressive increase of the pH during the electrolysis assisted the coagulation process.



**Fig. 3.** Effect of pH on the TSS, COD and TOC removal efficiencies at 500 mA and 1:5  $[\text{Fe}^{2+}]/[\text{H}_2\text{O}_2]$  ratio. ECP with iron plate electrodes.  $V = 400 \text{ mL}$ ,  $\text{Na}_2\text{SO}_4 = 0.1 \text{ M}$ , 2 h-treatment.

The concentration of  $\text{H}_2\text{O}_2$  plays a crucial role in ECP because  $\cdot\text{OH}$  concentration is directly dependent upon  $\text{Fe}^{2+}$  and  $\text{H}_2\text{O}_2$  concentration. In general, the efficiency increases as the  $[\text{Fe}^{2+}]/[\text{H}_2\text{O}_2]$  ratio rises, but the optimal ratio depends on the characteristics of the treated effluent (Pilli *et al.* 2015; Moussavi & Aghanejad 2014). The effect of  $\text{H}_2\text{O}_2$  concentration ( $[\text{Fe}^{2+}]/[\text{H}_2\text{O}_2]$  ratio of 1:1, 1:5 and 1:10) was evaluated under 500 mA of current and pH 5. According to the results (data not shown), the removal efficiency did not change significantly at these three ratios. This behaviour can be ascribed to an excess of  $\text{H}_2\text{O}_2$  concentration: on the one hand, the waste reaction of  $\text{H}_2\text{O}_2$  with  $\cdot\text{OH}$  (Eq. 11) was promoted by high contents of  $\text{H}_2\text{O}_2$ . On the other hand, at a concentration higher than the optimum value,  $\text{H}_2\text{O}_2$  self-decomposed to  $\text{H}_2\text{O}$  and  $\text{O}_2$  as shown in Eq. 12, leading to less  $\cdot\text{OH}$  production. The 1:5  $[\text{Fe}^{2+}]/[\text{H}_2\text{O}_2]$  ratio was chosen as the optimal value because of the properties of the solid sludge obtained at the end of the 2 h treatment, which presented better filterability and settleability properties as compared to the sludge produced with the 1:1 ratio.



After 2 h of ECP treatment under optimal conditions (pH 5, 500 mA of current and  $[\text{Fe}^{2+}]/[\text{H}_2\text{O}_2]$  ratio of 1:5), a sludge cake with good settleability was obtained. The treated sludge was vacuum-filtered and further analysed. Table 2 shows the chemical composition of the dry dewatered sludge. It can be seen that it contains an important amount of organic carbon, P- $\text{PO}_4$ , N- $\text{NH}_4$  and  $\text{NO}_3^-$ , which confer it fertilizing properties. As expected, Fe was significantly present in the sludge with a concentration of  $70.58 \text{ mg L}^{-1}$ .

**Table 2.** Chemical composition of ECP dry sludge after treatment.

	Fe	TVSS	N- $\text{NH}_4$	N- $\text{NO}_3^-$	P- $\text{PO}_4$	TC
$\text{mg L}^{-1}$	70.58	0.54	7.00	8.00	100	14.67

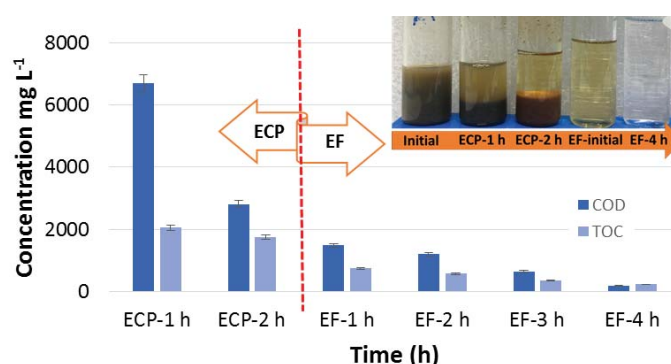
### EF post-treatment

ECP alone was able to achieve TSS, COD and TOC removal efficiencies of 89%, 85% and 67 % respectively. However, the liquid sample still contained a high concentration of COD and TOC. Accordingly, the remaining filtrate after dewatering was further treated by means of EF using a BDD anode and a carbon brush cathode. The aim was to make use of the outstanding EF capacity to mineralize organic pollutants, as stated in many previous studies (Lin *et al.* 2017; Mousset *et al.* 2016; Olvera-Vargas *et al.* 2014). Based on previous research, the



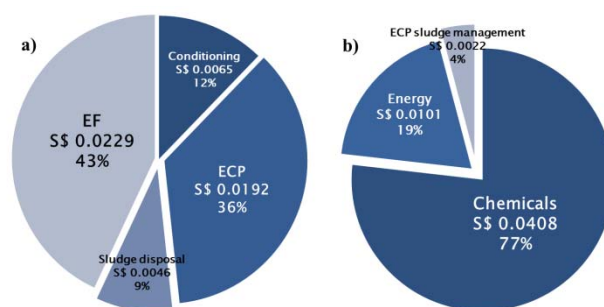
electrolysis was performed at 500 mA (13.3 mA cm<sup>-2</sup> with respect to the anode) and pH 3 (Olvera-Vargas, Oturan, et al., 2014; Mousset, Wang, et al., 2016). The Fenton's reaction was catalysed by the remnant amount of Fe<sup>2+</sup>/Fe<sup>3+</sup> ions from the ECP process (7.35 mg L<sup>-1</sup>). The evolution of COD and TOC during the sequential ECP-EF treatment are presented in Fig. 4. As expected, during EF the concentration of organic matter decreased with time due to the oxidative attack of ·OH formed i) homogeneously through the Fenton's reaction (Eq. 3) and ii) heterogeneously on the BDD surface according to Eq. 4.

The remaining COD and TOC content after ECP was reduced by 90% and 63%, respectively, following 4 h of EF treatment, reaching a COD content only slightly higher than the Singaporean standard limit for discharge into watercourse and recreation purposes (100 mg L<sup>-1</sup>). The BOD<sub>5</sub> (120 mg L<sup>-1</sup>) was below the NEA limit (400 mg L<sup>-1</sup>). More remarkably, COD was reduced to less than 50 mg L<sup>-1</sup> after 6 h of treatment, overpassing the NEA watercourse discharge limit. It is worth mentioning that the solution became crystal clear after only 2 h of EF (cf. inset in Fig. 4).



**Fig. 4.** Overall COD and TOC evolution during the sequential ECP-EF process. For ECP: iron plate electrodes, V = 400 mL, Na<sub>2</sub>SO<sub>4</sub> = 0.1 M, I = 500 mA, 1:5 [Fe<sup>2+</sup>]/[H<sub>2</sub>O<sub>2</sub>] ratio, pH = 5 and 2 h-treatment. For EF: V = 175 mL, Na<sub>2</sub>SO<sub>4</sub> = 0.1 M, I = 500 mA, pH = 3 and 4 h-treatment. Inset panel: visual evolution of the sludge sample during the overall treatment.

The cost for the overall ECP-EF treatment was estimated according to the method described in the materials and methods. The total cost per litre of sludge, including conditioning, ECP, precipitation of iron excess, EF post-treatment and final pH adjustment, was estimated to be S\$ 0.053 L<sup>-1</sup>, about half of the cost of disposal by incineration. It is important to bear in mind that the present strategy contemplates discharge into watercourse and for recreation purposes. Furthermore, the solid produced after ECP could be sold as a fertilizer. As observed in Fig. 5, the chemical cost represents the largest percentage (77%), while power and sludge management costs occupied the remaining fraction (19% and 4%, respectively). The cost break-down for each stage depicted in Fig. 5b indicates that the intermediate operations, conditioning and filtration, took up to 12% and 9%, respectively.



**Fig. 5.** Cost breakdown for each stage of the sequential treatment (a) and total operational costs per category (b). The costs per litres of treated sludge.

## CONCLUSIONS

A sequential electrochemical treatment was applied to condition and stabilize anaerobic sludge from a poultry farm. The two-step integrated ECP-EF treatment consisted in: i) 2 h-ECP at pH 5, current of 500 mA and  $[\text{Fe}^{2+}]/[\text{H}_2\text{O}_2]$  of 1:5, followed by ii) 6 h-EF (at pH 3 and 500 mA) of the residual filtrate after dewatering. During the ECP stage, the sludge was efficiently destabilized and conditioned by the synergistic effects of electrocoagulation and the Fenton's reaction, which resulted in production of a dewatered sludge with good settling and filterability properties. The filtrate after dewatering was subjected to EF, during which the excess of organic matter was efficiently oxidized by means of  $\cdot\text{OH}$ . The produced effluents after 2 h of ECP and 4 h of EF were able to reach the NEA sewer discharge standards in terms of COD (600 and 180  $\text{mg L}^{-1}$ , respectively), BOD<sub>5</sub> (400 and 130  $\text{mg L}^{-1}$ , respectively) and TSS (400 and 50  $\text{mg L}^{-1}$ , respectively). Furthermore, following 6 h of EF, the effluent reached the COD watercourse discharge limit of 50  $\text{mg L}^{-1}$  of COD. The total energy consumption was 0.0634  $\text{kWh L}^{-1}$  sludge, while the estimated total operational cost for the treatment was S\$ 0.053  $\text{L}^{-1}$  sludge. In conclusion, electrochemical technology is presented as a sustainable potential alternative for sludge remediation through this two-step integrated ECP-EF process.

## ACKNOWLEDGMENTS

The authors would like to thank the Singapore Ministry of Education Academic Research Fund Tier 1 through the grant WBS R302000145112.

## REFERENCES

- American Public Health Association 1999 *Standard methods for examination of water and wastewaters*, Washington, DC.
- An, C., Huang, G., Yao, Y., and Zhao, S. (2017) Emerging usage of electrocoagulation technology for oil removal from wastewater: A review. *Science of The Total Environment*, **579**, 537–556.
- Brillas, E. and Martínez-Huitle, C. A. 2015 Decontamination of wastewaters containing synthetic organic dyes by electrochemical methods. An updated review. *Applied Catalysis B: Environmental*, **166**, 603–643.
- Brillas, E., Sirés, I., and Oturan, M. A. 2009 Electro-Fenton process and related electrochemical technologies based on Fenton's reaction chemistry. *Chemical Reviews*, **109**(12), 6570–6631.

- Bureau, M.-A., Drogui, P., Sellamuthu, B., Blais, J. F., Asce, M., and Mercier, G. 2012 Municipal wastewater sludge stabilization and treatment using electrochemical oxidation technique. *Journal of Environmental Engineering*, **138**(7): 743-751.
- Cañizares, P., Paz, R., Sáez, C., and Rodrigo, M. A. 2009 Costs of the electrochemical oxidation of wastewaters: a comparison with ozonation and Fenton oxidation processes. *Journal of Environmental Management*, **90**(1), 410–20.
- Chaplin, B. P. 2014 Critical review of electrochemical advanced oxidation processes for water treatment applications. *Environmental Science. Processes & Impacts*, **16**(6), 1182–203.
- Christensen, M. L., Keiding, K., Nielsen, P. H., and Jørgensen, M. K. 2015 Dewatering in biological wastewater treatment: A review. *Water Research*, **82**, 14–24.
- Curteanu, S., Godini, K., Piuleac, C. G., Azarian, G., Rahmani, A. R., and Butnariu, C. 2014 Electro-Oxidation method applied for activated sludge treatment: experiment and simulation based on supervised machine learning methods. *Industrial & Engineering Chemistry Research*, **53**(12), 4902–4912.
- Daghrir, R. and Drogui, P. 2013 Coupled electrocoagulation–electro-Fenton for efficient domestic wastewater treatment. *Environmental Chemistry Letters*, **11**(2), 151–156.
- Lakshmanan, D., Clifford, D. A., and Samanta, G. 2009 Ferrous and ferric ion generation during iron electrocoagulation. *Environmental Science & Technology*, **43**(10), 3853–3859.
- Lin, H., Oturan, N., Wu, J., Zhang, H., and Oturan, M. A. 2017 Cold incineration of sucralose in aqueous solution by electro-Fenton process. *Separation and Purification Technology*, **173**, 218–225.
- Martínez-Huitle, C. A., Rodrigo, M. A., Sirés, I., and Scialdone, O. 2015 Single and coupled electrochemical processes and reactors for the abatement of organic water pollutants: A critical review. *Chemical Reviews*, **115**(24), 13362–407.
- Moreira, F. C., Boaventura, R. A. R., Brillas, E., and Vilar, V. J. P. 2017 Electrochemical advanced oxidation processes: A review on their application to synthetic and real wastewaters. *Applied Catalysis B: Environmental*, **202**, 217–261.
- Moussavi, G. and Aghanejad, M. 2014 The performance of electrochemical peroxidation process for COD reduction and biodegradability improvement of the wastewater from a paper recycling plant. *Separation and Purification Technology*, **132**, 182–186.
- Mousset, E., Wang, Z., and Lefebvre, O. 2016 Electro-Fenton for control and removal of micropollutants – process optimization and energy efficiency. *Water Science and Technology*, **74**(9), 2068-2074.
- National Environmental Agency, Singapore. [www.nea.gov.sg](http://www.nea.gov.sg) (accessed 10 July 2017).
- Olvera-Vargas, H., Oturan, N., Brillas, E., Buisson, D., Esposito, G., and Oturan, M. A. 2014 Electrochemical advanced oxidation for cold incineration of the pharmaceutical ranitidine: Mineralization pathway and toxicity evolution. *Chemosphere*, **117**, 644–651.
- Pignatello, J. J., Oliveros, E., and MacKay, A. 2006 Advanced oxidation processes for organic contaminant destruction based on the fenton reaction and related chemistry. *Critical Reviews in Environmental Science and Technology*, **36**, 1–84.
- Pilli, S., Yan, S., Tyagi, R. D., and Surampalli, R. Y. 2015 Overview of Fenton pre-treatment of sludge aiming to enhance anaerobic digestion. *Reviews in Environmental Science and Bio/Technology*, **14**(3), 453–472.

Sopaj, F., Oturan, N., Pinson, J., Podvorica, F., and Oturan, M. A. 2016 Effect of the anode materials on the efficiency of the electro-Fenton process for the mineralization of the antibiotic sulfamethazine. *Applied Catalysis B: Environmental*, **199**, 331–341.

Yahiaoui, O., Aizel, L., Lounici, H., Drouiche, N., Goosen, M. F. A., Pauss, A., and Mameri, N. 2011 Evaluating removal of metribuzin pesticide from contaminated groundwater using an electrochemical reactor combined with ultraviolet oxidation. *Desalination*, **270**(1–3), 84–89.

Zhou, X., Jiang, G., Wang, Q., and Yuan, Z. 2014 A review on sludge conditioning by sludge pre-treatment with a focus on advanced oxidation. *RSC Advances*, **4**, 50644–50652.

## Identifying optimal conditions for the start-up of an AnMBR treating concentrated domestic wastewater.

**Ferrari, F., Zahedi, S., Rodríguez-Roda, I., Pijuan, M.**

ICRA Catalan Institute for Water Research, H2O Building, Scientific and Technological Park of the University of Girona, 101 carrer Emili Grahit, 17003 Girona, Spain

**Keywords:** ambient temperature; AnMBR; biomethane; BMP; domestic wastewater.

### Introduction

Anaerobic membrane reactor (AnMBR) technology has been postulated as a good strategy for treating medium-high strength wastewaters (WWs) keeping high chemical oxygen demand (COD) removal efficiencies and good methane production even at very low HRTs. However, the start-up of these reactors, especially when dealing with domestic wastewater with relatively low temperatures and low COD concentrations, have been proved to be long. The aim of this study was to assess the effect that different temperatures, wastewater concentrations and inoculum-substrate (I/S) ratios have on the methane production potential of an anaerobic sludge. This work is conducted within the scope of a project that aims at obtaining reused water from sewer mining via a forward osmosis process and energy in the form of methane from the anaerobic treatment of the concentrate produced in the FO process. This information will be very useful for the start-up of an AnMBR treating the concentrate solution produced during the forward osmosis (FO) process.

### Material and methods

Two different sets of experiments were conducted. The first one aimed at evaluating the efficiency of anaerobic digestion (AD) of WW at 3 different temperatures (37 °C, 23°C and 15 °C) using the same I/S ratio (2.0) and 3 substrate COD concentration, representing 8, 4 and 2 times the COD concentration factors of a FO process treating medium strength WW with a 90%, 80% and 45% water recovery respectively (Ansari et al., 2015). In the second set of tests the effect of different I/S ratio (1.0, 1.5, 2.0 and 2.5) during the WW anaerobic degradation was evaluated. Tests were performed in 250 mL serum bottles. Inoculum was taken from a mesophilic anaerobic digester operating at 37 °C and treating a mixture of primary and waste activated sludge from a local wastewater treatment plant. The average inoculum composition was 15.08 g COD/L, 13.7 g ST/L (58%VS) and pH was equal to 7.42. Experimental conditions are shown in Table 1. To reach target substrate COD concentrations, a synthetic FO concentrate solution (SYNTHES) (Aiyuk & Verstraete, 2004) was used as substrate. For each I/S ratio and temperature, 2 blanks were prepared to verify the residual biogas production of the inoculum. Bottles were flushed with 100% N<sub>2</sub> gas for 1 min, sealed with a rubber stopper retained with a plastic top and stored on an orbital shaker that was placed in a temperature controlled incubator. Biogas production was determined with the pressure transducer technique and the percentage of methane in the biogas with a gas detector (GIR-3000, GasTech). The maximum specific methanogenic activity (SMA) was calculated dividing the CH<sub>4</sub> produced in grams of COD (considering the theoretical conversion of 0.35L CH<sub>4</sub>/gram COD) with the product of the volatile solids (VS) present in the inoculum and the

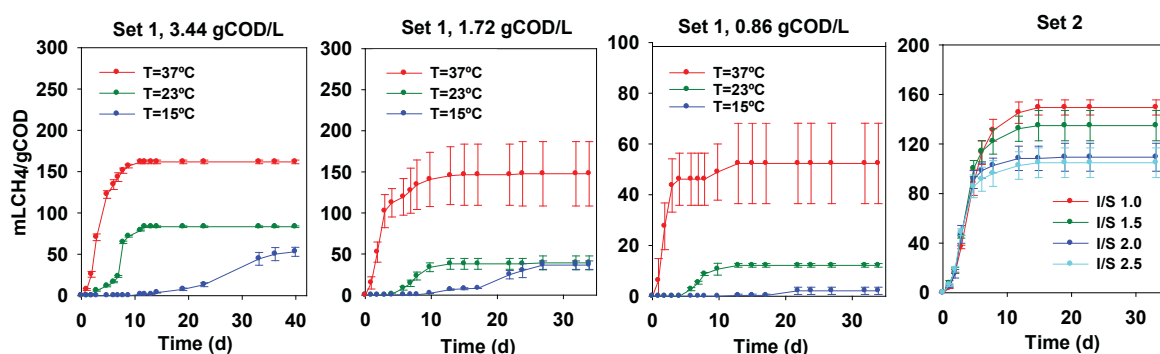
days of the interval of time considered. The specific methanogenic production was calculated by dividing the cumulated  $\text{CH}_4$  produced ( $\text{mL CH}_4$ ) with the COD initially present in the substrate. Dissolved  $\text{CH}_4$  was determined at the end of the experiment through gas chromatography.

## Results and discussion

The main results obtained are shown in Table 1 and Figure 1. The first set of experiments (Set 1) showed that lower temperatures lead to lower methane yield, lower maximum methanogenic activity and higher lag phases; same I/S ratio and substrate with lower COD concentrations led to lower COD conversion to  $\text{CH}_4$  and lower maximum SMA. Results from Set 2 showed that decreasing the I/S ratio fosters the biometanization of WW, indeed lowering the I/S from 2 to 1, implied an increase in the SMA and COD conversion to  $\text{CH}_4$  of 90% and 40% respectively.

**Table 1. Experimental conditions applied in each experiment and main results obtained**

	Set 1									Set 2			
Substrate COD (gCOD/L)	3.44	3.44	3.44	1.72	1.72	1.72	0.86	0.86	0.86	3.77	2.51	1.89	1.51
I/S ratio	2.0	2.0	2.0	2.0	2.0	2.0	2.0	2.0	2.0	1.0	1.5	2.0	2.5
Temperature ( $^{\circ}\text{C}$ )	37	23	15	37	23	15	37	23	15	37	37	37	37
COD conversion to $\text{CH}_4$ (%)	46 $\pm$ 1	24 $\pm$ 0	15 $\pm$ 2	36 $\pm$ 4	11 $\pm$ 2	6 $\pm$ 1	15 $\pm$ 4	4 $\pm$ 0	1 $\pm$ 0	43 $\pm$ 2	39 $\pm$ 3	31 $\pm$ 3	30 $\pm$ 3
SMA (g COD/d/kgVS)	90	35	8	73	11	2	14	3	<1	136	102	71	50
Period max SMA (d)	2-5	8-11	23-33	1-3	6-8	17-22	1-3	6-8	17-22	2-5	2-5	2-5	2-5



**Figure 1. SMP from Set 1 and Set 2.**

## Conclusions

- Increasing temperatures accelerate WW biodegradation and shorten the period of max SMA.
- Increasing organic loads keeping the I/S ratio constant implies an increase in the biomethane production and methanogenic activity.
- Increasing organic loads lead to increasing WW biomethanization.

## References

- Aiyuk, S., & Verstraete, W. (2004). Sedimentological evolution in an UASB treating SYNTHES, a new representative synthetic sewage, at low loading rates. *Bioresource Technology*, 93(3), 269–278.
- Ansari, A. J., Hai, F. I., Guo, W., Ngo, H. H., Price, W. E., & Nghiem, L. D. (2015). Selection of forward osmosis draw solutes for subsequent integration with anaerobic treatment to facilitate resource recovery from wastewater. *Bioresource Technology*, 191, 30–36.



**Parallel session 1 - Greywater Treatment**

**08:10-09:30**

Session chair: Makarand M. Ghangrekar

**440 - Electrocoagulation of domestic and office-building greywater**

FRIEDLER Eran - *Faculty of Civ. & Env. Eng., Technion - Israel Inst. of Technology*

**448 - Impact of suspended solids and organic matter on chlorine disinfection efficiency of greywater**

FRIEDLER Eran - *Faculty of Civ. & Env. Eng., Technion - Israel Inst. of Technology*

**449 - Long term micropollutant removal in a Vertical Ecosystem for decentralised greywater reuse in a Euro-Mediterranean resort**

KISSER Johannes - *Alchemia-Nova*

**434 - The alternative use of *Pseudomonas aeruginosa* as an indicator on the disinfection of greywater**

PAULO Paula - *Federal University of Mato Grosso do Sul - UFMS*

**Parallel session 2 - Infiltration systems**

**09:50-11:10**

Session chair: Srikanth Mutnuri

**497 - Greenhouse gas emissions from soil treatment units of on-site domestic wastewater treatment systems in Ireland**

SOMLAI-HAASE Celia - *Trinity College Dublin*

**299 - The performance of a self-contained recirculating evapotranspiration system in tropical and temperate climates**

KELE Ben - *Central Queensland University and Arris Pty Ltd*

**483 - Willow evapotranspiration systems to mitigate surface water pollution from domestic wastewater in rural areas with low permeability soils**

GILL Laurence - *Trinity College Dublin*

**259 - Effects of nitrogen and organic shock loadings on a soil filter treating matured landfill leachate**

GUAN Yidong - *Nanjing University of Information Science and Technology*

**Parallel session 3 - Treatment wetlands 1**

**11:30-12:50**

Session chair: Carlos Arias

**524 - Combination of constructed wetlands and photocatalysis processes for the elimination of persistent organic pollutants from municipal wastewater**

GONZALO Gael - *University of A Coruña*

**566 - Constructed wetlands planted with willow for domestic wastewater treatment under cold climate**

GREBENSHCHYKOVA Zhanna - *IMT Atlantique*

**274 - Efficiency of a short rotation willow coppice for the treatment of municipal wastewater under a North American humid continental climate**

LACHAPPELLE T. Xavier - *Polytechnique Montréal*

**514 - Domestic wastewater treatment by a two stage vertical subsurface flow constructed wetland: removal efficiency**

SEGURA Irleth - *Mexican Institute of Water Technology*

## Electrocoagulation of domestic and office-building greywater

Friedler, E.<sup>1</sup>, Efan, I.<sup>1</sup>, Gilboa, Y.<sup>1</sup>

<sup>1</sup> Faculty of Civil and Environmental Engineering, Technion – Israel Institute of Technology, Haifa, Israel.

**Keywords:** Electrocoagulation; greywater, iron anode, aluminium anode

### Introduction

Domestic greywater (GW) reuse may serve as an alternative source of increasing available water supply while conserving freshwater resources. GW is usually treated onsite, hence, small footprint and low operation and maintenance costs (e.g. low energy and chemicals consumption) of the treatment systems are important (Lin et al., 2005; Elazzouzi et al., 2017). In recent years, electrocoagulation (ELC) has been proposed as an effective method for wastewater treatment. In ELC the coagulant is generated *in situ* by electrolytic oxidation of the anode, commonly being aluminium (Al) or iron (Fe). The dissolution of the anode followed by hydrolysis of Al or Fe hydroxides destabilize and aggregate colloid particles making their subsequent removal more efficient. Since the electrodes dissolve they should be replaced periodically, however, it is a simpler operation as compared with supplying, storing and dosing chemicals in conventional coagulation. ELC equipment and operation are relatively simple. In addition, flocs formed by ELC tend to be larger than flocs formed by chemical coagulation, contain less bound water, are more stable, and therefore, can be separated faster by sedimentation / filtration (Mollah et al., 2001).

This research studies ELC as a pre- or post- treatment of other GW treatment process. ELC was tested on two types of GW: office building GW originating mainly from washbasins in restrooms (Friedler and Alfiya, 2010), and mixed domestic GW (showers and washbasins) from married students accommodation in the Technion campus (Gilboa and Friedler, 2008).

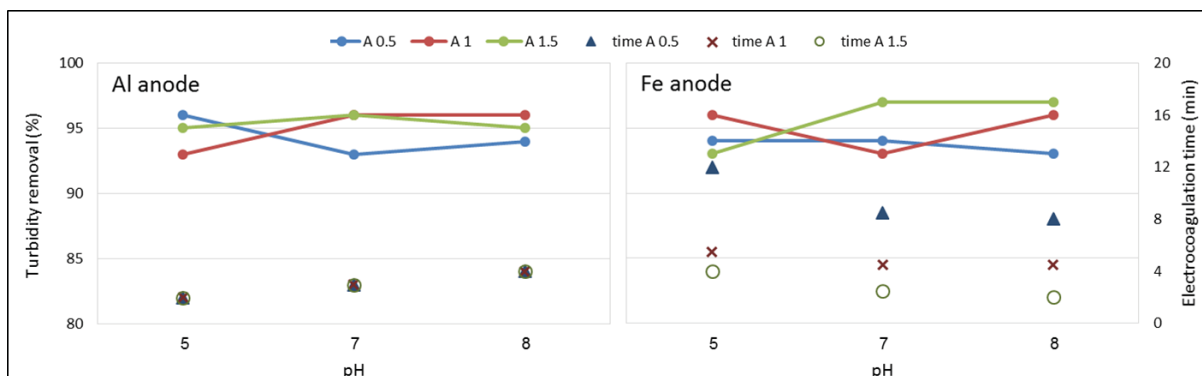
### Materials and Methods

The effects of pH (5-7) and electrical current (0.5-1.5 A) on ELC was studied using Al and Fe anodes. In this stage synthetic GW was used (having constant chemical composition), prepared based on data from the literature (Oschmann et al., 2005; Fenner and Komvuschara, 2005). Then, the process was applied on the abovementioned two types of GW (domestic and office building) in batch experiments followed by continuous ones. ELC efficiency was assessed by measuring the removal of the following parameters: turbidity, UV254nm absorbance, COD, methylene blue active substances (MBAS; a measure of anionic detergents), and total phosphorus (TP).

### Results and Discussion

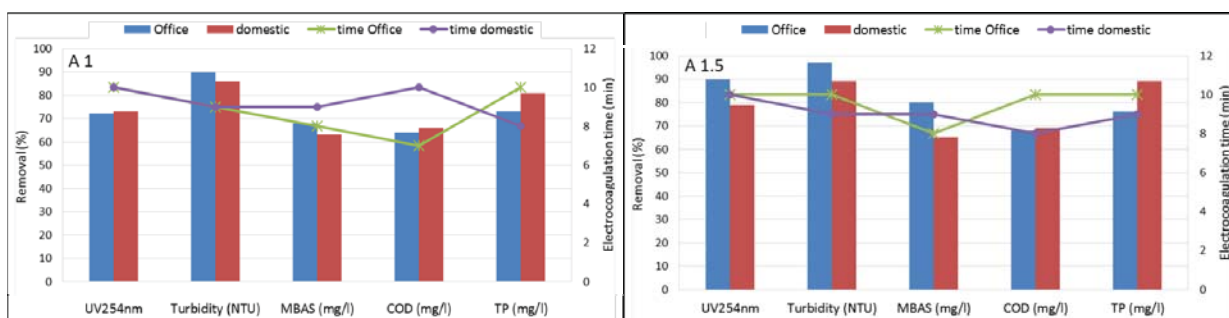
The main results showed: (i) both Al and Fe anodes were efficient in turbidity removal, but the time needed from the Fe electrode for optimal turbidity removal (93-97%) was significantly longer for 0.5 A (Fig. 1). In addition, the optimal initial pH value for all pollutants removal was about 7 while pH 5 was less favorable, apart from phosphorus, which exhibited high removal

rate for all examined pH values. (ii) At neutral pH range, which is typical to greywater, the Fe anode was more efficient than Al anode (iii) High efficiency of pollutants removal was obtained also in the continuous experiments, performed on the two types of real GW (Fig. 2).



**Figure 1. Electrocoagulation of synthetic GW with Al and Fe anodes - Turbidity removal and optimal time at different pH values (5, 7, 8) and three electrical currents (0.5, 1 and 1.5 A)**

Removal efficiency – lines; Optimal time (time needed to reach the highest removal efficiency) - shapes



**Figure 2. Electrocoagulation of real GW (domestic, office building) – Pollutants removal efficiencies and optimal time from continuous experiments (Fe anode; electrical currents 1 and 1.5 A)**

Removal efficiency – bars; Optimal time (time needed to reach the highest removal efficiency) - lines

## References

- Elazzouzi, M., Haboubi, K., Elyoubi, M. S. (2017). Electrocoagulation flocculation as a low-cost process for pollutants removal from urban wastewater. *Chem. Eng. Res. and Design*, 117, 614-626.
- Fenner, A. R., Komvuschara, K., (2005). A new kinetic model for ultraviolet disinfection of greywater. *J. of Env. Eng.*, June, 850-864.
- Friedler, E., Alfiya, Y., (2010). Physicochemical treatment of office and public buildings greywater. *Wat. Sci. Tech.*, 62(10), 2357-2363.
- Gilboa, Y., Friedler, E., (2008). UV disinfection of RBC treated light greywater effluent: kinetics, survival and regrowth of selected microorganisms. *Wat. Res.*, 42(4-5), 1043-1050.
- Lin, C. J., Lo, S. L., Kuo, C. Y., Wu, C. H. (2005). Pilot-scale electrocoagulation with bipolar aluminum electrodes for on-site domestic greywater reuse. *J. of Env. Eng.*, 131(3), 491-495.
- Mollah, M. Y. A., Schennach, R., Parga, J. R., Cocke, D. L. (2001). Electrocoagulation - science and applications. *J. of hazardous materials*, 84(1), 29-41.
- Oschmann, N., Nghiem, L. D., Shafer, A. I., (2005). Fouling mechanisms of submerged ultrafiltration membranes in greywater recycling. *Desalination*, 179(1-3), 215-223.

## Impact of suspended solids and organic matter on chlorine disinfection efficiency of greywater

Ref# S2SMALL- 07635

E. Friedler<sup>1</sup>, D. F. Chavez<sup>2</sup>, Y. Alfiya, Y.<sup>1</sup>, Gilboa, Y.<sup>1</sup>, Gross, A.<sup>2\*</sup>

<sup>1</sup> Faculty of Civil & Environmental Engineering, Technion - Israel Inst. of Technology. Technion, 3200 Haifa Israel

<sup>2</sup> Zuckerberg Institute for Water Research, Blaustein Institutes for Desert Research, Ben-Gurion University of the Negev, Sede Boqer Campus 84990 Midreshet Ben-Gurion, Israel

\* Corresponding author: [amgross@bgu.ac.il](mailto:amgross@bgu.ac.il)

### Abstract – 200 words

Greywater (GW) reuse can reduce domestic water consumption, however, it must be treated and disinfected for safe reuse. This research studied the efficiency of chlorine disinfection of GW under a range of total suspended solids (TSS; 3.9-233 mg/l) and organic matter (1-107 mg/l), represented by 5-d biochemical oxygen demand (BOD<sub>5</sub>) concentrations in batch and flow-through setups. In addition, a multiple linear regression (MLR) model was developed for predicting the impact of TSS, BOD<sub>5</sub> and residual chlorine on chlorine disinfection efficiency. Inactivation of 3 to 5 logs of faecal coliforms (FC) was demonstrated in both batch and flow-through experiments. Presence of TSS and BOD<sub>5</sub> reduced chlorine efficiency to inactivate FC, yet, the negative impact of TSS was more pronounced in both setups. The MLR model developed based on the batch results ( $p < 0.0001$ ;  $R^2 = 0.76$ ) was verified successfully against results of treated GW disinfected by the flow-through chlorination ( $p < 0.0001$ ;  $R^2 = 0.6$ ). It is therefore postulated that the required residual chlorine concentration needed in an on-site flow-through reactor can be predicted using the model, given the initial FC concentration, BOD<sub>5</sub>, TSS and the required final FC concentration of the GW to be disinfected. This approach is valuable from both operational and research perspectives.

**Keywords:** BOD; suspended solids, chlorination, greywater, chlorine tablet, chlorine flow-through chamber

## INTRODUCTION

Reuse of greywater (GW; domestic wastewater excluding toilet water) for non-potable uses, such as garden irrigation, has a potential to reduce domestic water consumption and thus to alleviate stress on depleted water resources while reducing water costs for residents (Maimon et al., 2010). However, untreated GW contains pathogens and other pollutants and might pose environmental and health risks if used without treatment and disinfection (March and Gual, 2009; USEPA, 2002). Chlorination and UV irradiation are probably the most widely used disinfection methods in small, onsite GW systems (Gross et al., 2015).

Chlorine is reliable and effective against a wide spectrum of pathogenic organisms and is considered as more cost-effective than other common disinfectants, such as UV radiation or ozone (USEPA, 2002; Leverenz et al., 2007). In addition, chlorine residual remains in the effluent after application, ensuring continued disinfection along the conveyance system and reducing potential regrowth (Friedler *et al.*, 2006, 2011). Furthermore, chlorine-dosing is flexible and can be controlled by simple, low-cost devices. Nonetheless, chlorine is toxic and corrosive thus, its storage, shipping, handling and application should be done responsibly.

Efficient application of disinfection agent should take into consideration the required dose, which can be achieved by varying the chlorine concentration and the disinfection contact time. The

required dose varies based on chlorine demand (wastewater characteristics) and chlorine residual requirements. According to the WHO guidelines (2006) the residual concentration of free chlorine should be  $\geq 0.5$  mg/l after at least 30 min contact time at pH <8.0.

Dissolved and suspended organic matter is oxidized by chlorine and therefore increases chlorine demand and reduces the overall efficiency of disinfection, hence, it is recommended that organic matter concentration is minimized before the treated effluent is disinfected (USEPA, 2002). Total suspended solids (TSS) reduce chlorination efficiency also by physically “shielding” microorganisms attached to it and thus reduce the chance for efficient contact between the microorganism and chlorine compared to non-attached bacteria (Bohrerova and Linden, 2006; Winward et al., 2008). More so, presence of organic matter might further reduce chlorine disinfection efficiency by stabilization of microbial cell membranes (Virto et al., 2005). Winward et al. (2008) who examined the impact of organic and particulate matter on chlorine disinfection of greywater in a batch system, indicate that the organic matter affected chlorine demand but did not affect the resistance of total coliforms to chlorine. Yet, these authors recommended removing the organic matter before chlorination for reducing the chlorine demand and the potential for microbial regrowth.

Chlorine can be supplied in several forms: chlorine gas, liquid hypochlorite solutions, and chlorine compounds in solid tablets. Solid hypochlorite tablets, stored in a flow-through chamber and liquid hypochlorite solutions, are the most common forms of chlorination in small treatment systems, since they are less hazardous than gaseous chlorine. Liquid chlorine application is accurate but requires the use of acids and operation of a dosing pump thus, less safe and more complex than use of tablets. Chlorine tablets are the simplest to handle, but are less controllable for accurate dosing of the chlorine which is affected by flow rate and tablet condition (i.e. new vs. used) (Leverenz et al. 2007; Park et al., 2016). The uniformity of application of chlorine tablets is beyond the scope of this study, yet several companies claim to have accurate dosing devices for chlorine tablets. Moreover, as discussed below, results from the current study did not vary much over time for a certain GW quality.

Interestingly, there is no systematic information on the impact of organic matter and suspended solids on chlorine disinfection in both batch and flow-through disinfection units. The objectives of this study were to test the efficiency of chlorine disinfection of GW under a range of TSS and BOD<sub>5</sub> concentrations by performing chlorination at batch and flow-through setups. In addition, the study aimed to develop a regression model for predicting the impact of TSS and BOD<sub>5</sub> on chlorine disinfection efficiency in both setups.

## **MATERIALS AND METHODS**

The research was executed in two phases. Initially, treated GW samples varying in their TSS and BOD<sub>5</sub> concentrations were disinfected in a batch setup by hypochlorite solution. The results obtained were used for developing a multiple linear regression model. In the second phase, treated GW from full-scale onsite treatment systems (described below), was disinfected in a flow-through disinfection unit using chlorine tablets. The applicability of the model developed was verified on the results of the flow-through experiments.

### **Batch chlorination experiment**

*GW samples.* Pre-disinfected treated GW samples (10 L each) from 11 full-scale onsite treatment systems from single-family homes (constructed and operated by the tenants themselves), were

collected and analyzed for fecal coliforms (FC), TSS and BOD<sub>5</sub> (Table 1). Subsamples were disinfected in a batch mode. Initially, chlorine demand of the subsamples was determined. For that, aliquots of 25 ml were exposed to four different chlorine doses of 0.5, 1, 3 and 6 mg/l. After 1 h, the residual total and free chlorine were determined by the DPD method (APHA, 2012).

**Table 1.** Quality of pre-disinfected treated GW from 11 onsite treatment systems that was used in the batch experiment. Each site was sampled 4 times (n = 44 samples).

Parameter <sup>1</sup>	Range	Average	Median
TSS (mg/l)	3.9-233	38	15
Dissolved BOD (mg/l)	1- 107	41	37
Turbidity (NTU)	1.47-512	87	18
FC (CFU/100ml)	<1-10 <sup>6</sup>	10 <sup>5</sup>	10 <sup>5</sup>

<sup>1</sup> All analyses were performed according to APHA (2012)

*Multiple linear regression (MLR) model.* The laboratory results were used for developing an MLR model. The parameters chosen for the model (TSS, BOD<sub>5</sub>, residual chlorine and log FC concentrations in the GW before disinfection) were those expected to significantly affect disinfection efficiency.

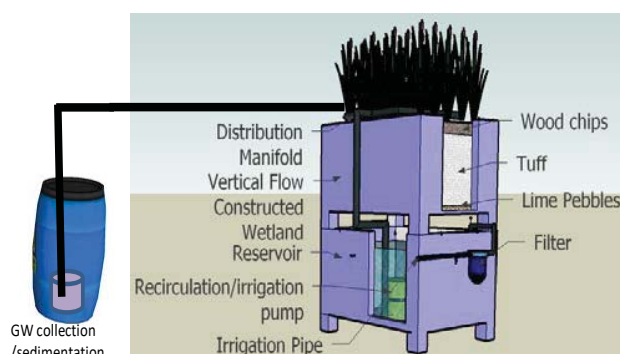
### Flow-through chamber

*GW samples.* Treated domestic GW (1 L) from six single-family full-scale recirculating vertical flow constructed wetland (RVFCW) systems located in Israel's Central Negev Desert were collected at least 4 times and immediately brought to the laboratory where subsamples were analyzed as described below. Briefly, the RVFCW system consisted of two 500 L plastic containers (1.0 m×1.0 m×0.5 m) placed one above the other. The upper one held a planted three-layered bed, consisting of a 5 cm upper layer of woodchips followed

by a 35 cm tuff gravel and a 10 cm lower layer of limestone pebbles. The lower container functioned as a reservoir. GW was pumped from a 200 L equalization-sedimentation tank and applied to the top of the bed, from there it dripped through the bed into the reservoir (the lower container) through the perforated bottom of the upper container (Fig. 1). GW was recirculated from the reservoir to the top of the upper bed at a rate of about 300 L/h for 8 h after which it was filtered through 130 µm filter and then reused for garden irrigation. Additional details about the system can be found elsewhere (Gross *et al.*, 2007; Alfiya *et al.* 2013).

TSS and BOD<sub>5</sub> of pre-disinfected, partial to fully treated GW from the RVCW on-site systems ranged from 1-130 mg/l and 3-100 mg/l, respectively and the FC concentration ranged from 10<sup>4</sup> to 10<sup>5</sup> CFU/100 ml. The latter was ensured by adding bacteria from untreated GW (10<sup>7</sup> CFU/100 ml). Since the volume added was three orders of magnitude smaller than the treated GW sample, it did not significantly affect the quality of the measured parameters.

*Flow-through chamber setup.* Chlorination was performed by discharging the treated GW (at a predetermined flow rate) via a 500 ml irrigation chamber (Amiad LTD) containing a slow release



**Figure 1.** Schematic of the onsite recirculating vertical flow constructed wetlands (RVFCW) GW treatment system (After Alfiya *et al.*, 2013)



HTH tablet (High Test Hypochlorite; 70% available chlorine). A single chlorine tablet was placed in the flow-through chamber, and was designed to dissolve slowly as water flows through the chamber according to the determined contact time. The chamber was connected at both ends to tubes (Fig. 2); the input tube was connected to an aquarium submerged pump (Atman, model AT 102) that regulated the input flow to 8 l/min, mimicking typical rates in regular garden systems. In other words, each sample of treated GW was exposed to the same contact time, although the quality of the treated GW was quite different, and thus there could be large variability in the required chlorine dose. Chlorinated samples were collected from the outlet tube. Sub-samples were analysed before and after disinfection for TSS, BOD<sub>5</sub>, FC and total residual chlorine (after disinfection). Disinfection efficiency was determined by calculating the log inactivation of FC.



**Figure 2.** Flow-through chamber

## RESULTS AND DISCUSSION

### Batch chlorination experiment

As expected, presence of TSS and organic matter reduced chlorine efficiency of removing FC and was more pronounced for the lower initial chlorine concentrations used such as 0.5 and 1 mg/l. For example, disinfection efficiency at TSS and BOD<sub>5</sub> concentrations of 15 and 50 mg/l (respectively) was 2 and 1.5 order of magnitude higher at chlorine dose of 6 mg/l than at doses of 0.5 and 1 mg/l, respectively. The reduction in the efficiency of chlorine disinfection when TSS increased, was much more pronounced than the efficiency reduction when BOD<sub>5</sub> concentrations were higher (Fig. 3). Moreover, the negative effect of TSS started already at low concentrations and increased consistently with increasing TSS concentrations across all the concentrations range tested. On the other hand, the negative effect of BOD<sub>5</sub> on FC inactivation was observed only when its concentration was higher than 50 mg/l.

The total residual chlorine, measured 0.5 h after its application ranged between 0.21 and 1.86 mg/l (Table 2- phase 1); mostly within the acceptable levels for reuse (minimum of 0.5 or 1 mg/l, dependent on intended use; Halperin and Aloni, 2003, WHO 2006). In addition, 3-log inactivation of FC was obtained on average, while FC was not detected at 60% of the samples.

**Table 2.** Performance of the chlorination disinfection systems- batch and flow-through

		Phase 1	Phase 2
		Batch chlorination	Flow-through chlorine chamber
Total chlorine residual (mg/l)	Average	1.0 ( $\pm 0.35$ )	1.7 ( $\pm 1.3$ )
	Range	0.21-1.86	0.5-5.8
	Median	1.0	1.3
FC Log inactivation	Average	3.0 ( $\pm 1.45$ )	3.0 ( $\pm 0.6$ )
	Range	0.2-5.5	1.4-4.3
	Median	2.9	3.0

### Multiple linear regression (MLR) model

The relationship between FC inactivation and TSS, BOD, log FC concentration of the treated GW (before disinfection) and the measured total residual chlorine were described by a MLR model (Eq. 1).

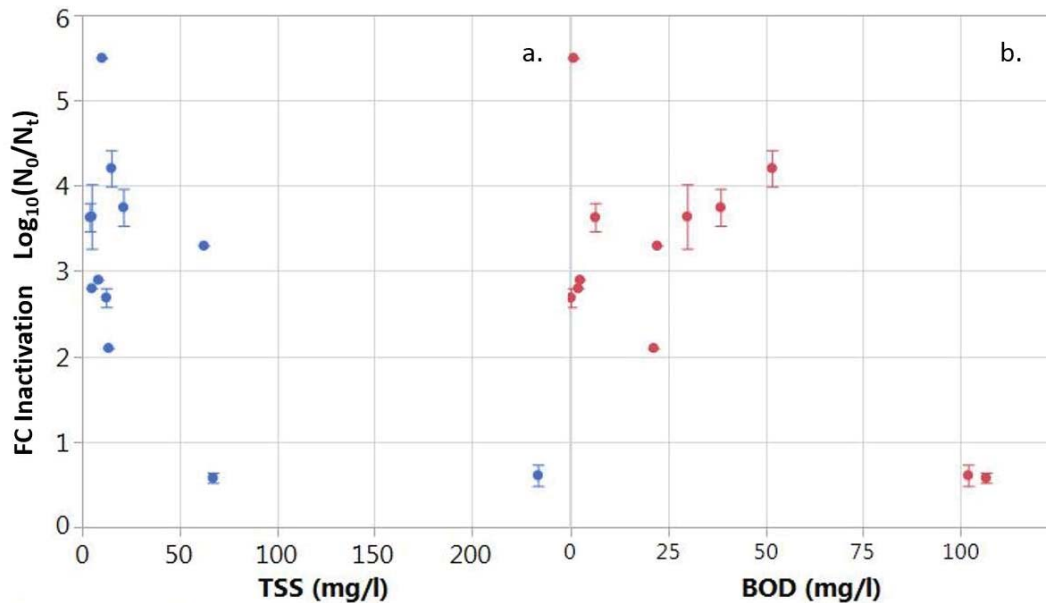
$$(1) FC_{\text{inactivation}} = \beta_1 \cdot [BOD_5] + \beta_2 \cdot [TSS] + \beta_3 \cdot [\log FC \text{ raw}] + \beta_4 \cdot [\text{residual chlorine}]$$

Where:

$FC_{\text{inactivation}}$  in  $\log(\text{cfu}/100\text{ml})$ ;  $BOD_5$  TSS and residual chlorine in  $\text{mg}/\text{l}$ ;  $\log FC \text{ raw}$  in  $\log(\text{cfu}/100\text{ml})$ ;  $\beta_1$ ,  $\beta_2$ ,  $\beta_3$  and  $\beta_4$  are coefficients estimating the explanatory variables (Table 3).

All coefficients were established based on the batch disinfection experiments, and the model was found to be statistically significant ( $p < 0.0001$  and  $R^2 = 0.76$ ; Figure 4a). Moreover, all explanatory variables were statistically significant indicating that these chosen variables have significant influence on the efficiency of chlorine disinfection (at the examined ranges).

Other combinations of these variables (including interactions between them) were tested, however they did not increase the fit of the model. Therefore, the simplest model is presented. To compare the effects of the various explanatory variables on chlorination efficiency the effect size test, which is used for assessing the variables effect on a suggested model, was applied. In this test the p-value was transformed to the LogWorth ( $-\log_{10}(\text{p-value})$ ), assuming that larger effects lead to more significant p-values and larger LogWorth (Table 3).

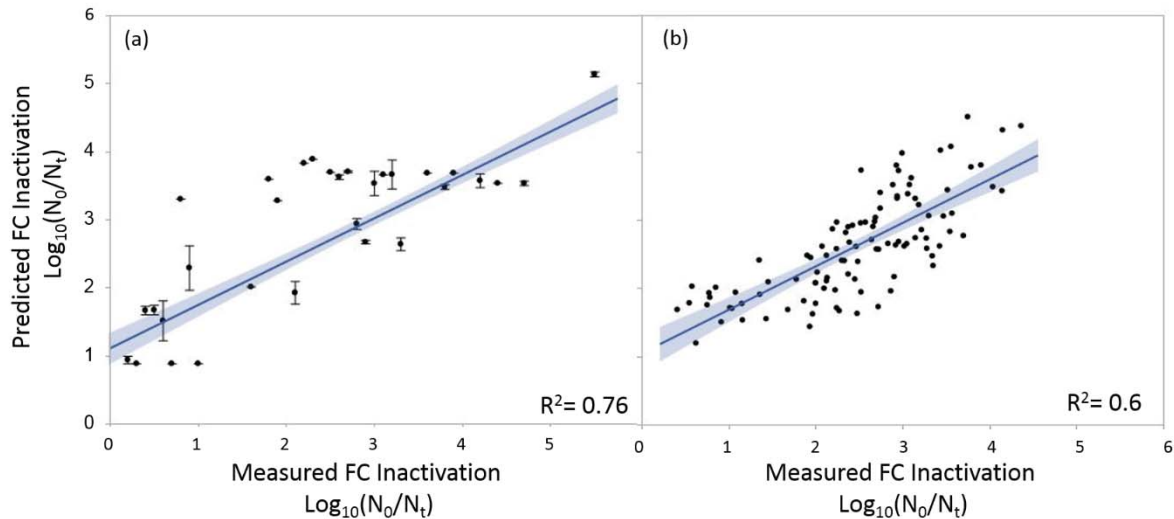


**Figure 3.** Log Inactivation of fecal coliforms (FC) as a function of total suspended solids (TSS) (a); and biochemical oxygen demand ( $BOD_5$ ) concentrations in the GW (b)

The model indicates that initial microbial concentration was the most significant parameter (having positive effect) followed by TSS and then  $BOD_5$  concentrations, both resulted in a reduction of FC inactivation. These results are consistent with established theory and demonstrate the negative effect of TSS and  $BOD_5$  on chlorine disinfection. Most likely some of the  $BOD_5$  and TSS increased the chlorine demand as they were oxidized, thus reducing the active chlorine concentration and consequently the FC inactivation. In addition, as aforementioned, TSS and  $BOD_5$  may affect chlorination efficiency by increasing the bacteria resistance due to stabilization of the microbial cell membranes (Virto et al., 2005) or due to bacteria attachment to suspended solids (Bohrerova and Linden, 2006; Winward et al., 2008).

**Table 3.** THE MLR model coefficients

Explanatory Variable	Coefficient	Estimate	p-value	LogWorth
Dissolved BOD (mg/l)	$\beta_1$	-0.016	<0.0001	5.43
TSS(mg/l)	$\beta_2$	-0.013	<0.0001	10.8
Log FC raw (log(CFU/100ml))	$\beta_3$	0.831	<0.0001	22.8
Residual chlorine (mg/l)	$\beta_4$	0.644	<0.0001	2.83

**Figure 4.** Predicted vs measured FC inactivation (a) batch setup (b) flow-through chamber

#### Flow-through chlorine tablet chamber

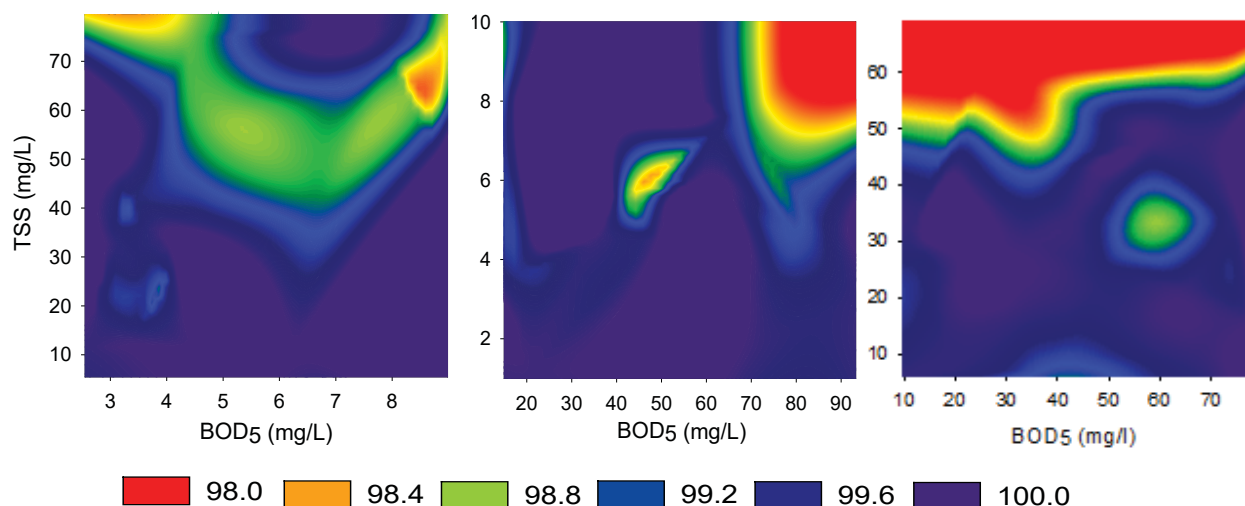
FC inactivation of 3-logs on average was obtained for all samples (including the ones with elevated TSS and BOD concentrations) and in over 90% of the samples counts were less than 10 cfu/100ml. Similarly to the batch experiment, the effect of TSS was more pronounced in reducing chlorine disinfection efficiency as compared with the one of BOD<sub>5</sub> (Fig. 5 maps). As explained above, these results are consistent with previous findings that suggest that coliforms in GW were associated to particles and were sheltered by them, thus were resistant to disinfection whereas organic matter affected chlorine demand but not resistance.

The total residual chlorine in the flow-through system, measured 0.5 h following chlorine application ranged between 0.5 to 5.8 mg/l (Table 2- phase 2). Similar to the batch experiment, residual chlorine range was within the acceptable levels for unlimited wastewater reuse (Halperin and Aloni, 2003; WHO, 2006).

The MLR model, developed based on the batch-phase experiments, was verified on the flow-through disinfection chamber results and was found to be statistically significant with ( $p < 0.0001$ ;  $R^2 = 0.6$ ; Fig. 4 b). Although the quality of treated GW samples from the two phases was quite different, and so were the means of chlorination, the model fitted well and explained most of the variability in the measured FC inactivation. This correlation suggest that it would be possible to predict the required residual concentration needed in the flow through reactor given the initial FC concentration, BOD<sub>5</sub>, TSS and the required final FC concentration of the water to be disinfected, as described in Eq. 2 below. This approach is valuable not only from an operational standpoint, but also from a research perspective.

$$(2) [\text{residual chlorine}] = \frac{FC_{\text{inactivation}} + 0.016 \cdot [BOD_5] + 0.013 \cdot [TSS] - 0831 \cdot [\log FC \text{ raw}]}{0.644}$$

Controlling the residual chlorine concentration in a flow-through disinfection reactor for a certain GW quality would require manipulation of the amount of chlorine (e.g. number of chlorine tablets) and the contact time such as by manipulation of the flow rate.



**Figure 5.** FC removal in the flow-through disinfection reactors as a function of TSS and BOD<sub>5</sub> in GW, for three different scenarios: a. increase of TSS (BOD<sub>5</sub> relatively constant); b. Increase of BOD<sub>5</sub> (TSS relatively constant); c. combined increase of TSS and BOD.

Total chlorine residual ranged from 0.5 to 5.8 mg/l (average 1.3 mg/l). Percentage of FC removal ranging from 98 to 100 % with line interval of 0.1.

## CONCLUSIONS

This study indicates that the efficiency of chlorine disinfection of treated GW decreases as a result of increasing TSS and BOD<sub>5</sub> concentrations. Both the batch experiment and the flow-through setup have shown that dissolved organic matter affect the efficiency of chlorination significantly less than TSS, as expresses by much lower LogWorth value. Furthermore, the effect of TSS was continuous starting from low concentrations, while the effect of BOD<sub>5</sub> became significant only above a certain threshold concentration. A multiple linear regression model was developed in a batch setup and verified successfully against results of treated GW that were disinfected by a flow-through chlorine disinfection chamber. It is therefore postulated that the total chlorine residual required for on site flow-through chambers can be evaluated based on the model in order to achieve the needed disinfection efficiency.

## REFERENCES

- Alfiya Y., Gross A., Sklarz M. & Friedler E. 2013. Reliability of onsite greywater treatment systems in Mediterranean and arid environments – A case study. *Wat. Sci. Tech.*, **67**(6): 1389-1395.
- APHA, AWWA, WEF 2012. Standard Methods for the Examination of Water and Wastewater, 22<sup>nd</sup> edn. American Public Health Association, American Water Works Association, Water Environment Federation. Washington, DC.

- Bohrerova Z. & Linden K.G. 2006 Ultraviolet and chlorine disinfection of Mycobacterium in wastewater: effect of aggregation. *Water Environ. Res.*, **78**(6), 565-571.
- Friedler E., Kovalio R. & Ben-Zvi A. 2006 Comparative study of the microbial quality of greywater treated by three on-site treatment systems. *Env. Tech.*, **27**(6), 653-663.
- Friedler E., Yardeni A., Gilboa Y. & Alfiya Y. 2011 Disinfection of greywater effluent and regrowth potential of selected bacteria. *Wat. Sci. Tech.*, **63**(5), 931-940.
- Gross A., Shmueli O., Ronen Z. & Raveh E. 2007 Recycled vertical flow constructed wetland (RVFCW) a novel method of recycling greywater for irrigation in small communities and households. *Chemosphere* **66**, 916-923.
- Gross A., Maimon A., Alfiya Y. & Friedler E., 2015. *Greywater reuse*. CRC Press & IWA publishing. 301 p.
- Halperin R. & Aloni U. 2003 *Standards for treated wastewater reuse in the city, for recreation and in industry*. Israel Ministry of Health, Jerusalem, 15 p. (Hebrew).
- Leverenz H. L., Darby J. & Tchobanoglous G. 2007 Comparison of a commercially available chlorine and an ultraviolet disinfection unit for onsite wastewater systems. *Small Flows Magazine*, **8**(2), 11-21.
- Maimon A., Tal A., Friedler E. & Gross A. 2010 Safe onsite reuse of greywater for irrigation - a critical review of current guidelines. *Environ Sci Technol*, **44**, 3213-3220.
- March J. G., & Gual M. 2009. Studies on chlorination of greywater. *Desalination*, **249**(1), 317-322.
- Park E., Mancl K. M., Tuovinen O. H., Bisesi M. S. & Lee J. 2016 Ensuring safe reuse of residential wastewater: reduction of microbes and genes using peat biofilter and batch chlorination in an on-site treatment system. *J. of appl. Microbiol.*, **121**(6), 1777-1788.
- U.S. Environmental Protection Agency (USEPA), 2002. Onsite wastewater treatment systems manual. Office of Water, U.S. Environmental Protection Agency, Washington, DC. EPA 625-R-00-008.
- Virto R., Manas P., Alvarez I., Condon S., Raso J. 2005 Membrane damage and microbial inactivation by chlorine in the absence and presence of a chlorine-demanding substrate. *Appl. Environ. Microbiol.*, **71**(9), 5022-5028.
- Winward G. P., Avery L. M., Stephenson T., & Jefferson B. 2008 Chlorine disinfection of grey water for reuse: Effect of organics and particles. *Wat. Res.*, **42**(1), 483-491.
- World Health Organization (WHO) 2006 *Guidelines for the safe use of wastewater, excreta and greywater: Vol. 4 - Excreta and greywater use in agriculture*. WHO Geneva, 204 p.



## Long term micropollutant removal in a Vertical Ecosystem for decentralised greywater reuse in a Euro-Mediterranean resort

Buttiglieri, G.<sup>1</sup>, Zraunig, A.<sup>2</sup>, Radtke, M.<sup>3</sup>, Kisser, J.<sup>2</sup>, Rodriguez-Roda, I.<sup>1,4</sup>, Gattringer H.J.<sup>2</sup>

<sup>1</sup> ICRA, Catalan Institute for Water Research, Parc Científic Tecnològic de la UdG. 17003 Girona, Spain

<sup>2</sup> alchemia-nova GmbH, institute for innovative phytochemistry & closed loop processes, Vienna, Austria

<sup>3</sup> Radtke Biotechnik, Veitshöchheim, Germany

<sup>4</sup> LEQUIA, Institute of the Environment, University of Girona, E-17071 Girona, Spain

**Keywords:** Constructed wetlands; ecosystem services; water reuse; pharmaceutical compounds; EDCs.

### Introduction

Tourism water consumption is typically below 5% of domestic water use, but can be as high as 40% in certain countries (e.g. Mauritius). Decentralised treatment facilities for water re-use, including constructed wetland, could provide environmental benefits and effective solutions towards water scarcity mitigation. Different water quality requirements are established by national and international regulations. Micropollutants have been rarely included in such policies, partially due to the lack of information, and touristic nuclei can have a strong impact on water quality (Moreno-Gonzalez et al., 2015). Micropollutant removal by means of greywater treatment technologies have been theoretically calculated (Revitt et al., 2011) or experimentally performed (Ramprasad and Philip, 2016), but only for few selected compounds, not with real greywater or not including touristic infrastructures.

A highly integrated subsurface horizontal flow constructed wetland (VertECO) was designed to treat greywater for water reuse purpose. This simulated wetland was observed and long term (24 months) validated with real greywater in a large Euro-Mediterranean resort. Several micropollutants were included in the research (13 endocrine disrupting compounds, EDCs, and 14 pharmaceutical active compounds, PhACs).

### Material and Methods

Hotel Samba is a large 3 star resort located in an extremely touristic area (NE, Spain), where dramatic water demand increase coincides with water scarcity events during the summer months, with reported water from 25,000 to 34,000 m<sup>3</sup>/year (100-135 L/person/day).



Fig. 1. Schematic overview of the VertECO unit (left). Demonstration unit at the hotel (right).



VertECO simulates a wetland ecosystem placed vertically staggered in 4 levels with a reduced floor footprint (Figure 1). Plants, mostly swamp and marsh, are cultivated hydroponically with coarse expanded clay as root substrate, ambient air pumped into the bottom and a permanent comparatively high subsurface water level. The total substrate volume is 2 m<sup>3</sup>. Real hotel greywater (1 up to 1.5 m<sup>3</sup> per day) was collected, oxygenated and pumped intermittently into the top level. Inflow and outflow samples were evaluated towards further uses inside the hotel, like toilet flushing or irrigation. Long term (24 months) analysis was performed in terms of standard parameters and micropollutants (EDCs and PhACs).

## Results and Discussion

Very satisfactory pollution abatement in standard water quality parameters was obtained with 84%, 92% and 95% removal of TOC, COD and BOD<sub>5</sub>, in compliance with all limits for water reuse purposes as determined by Spanish national legislation. The comprehensive and constant monitoring of micropollutants showed, though, great yearly and daily variance. The differences among seasons and corresponding treatment capabilities were investigated. A substantial reduction of many PhACs and EDCs was also observed (Figure 2). The removal was on average higher than 75% for 10 compounds, intermediate (between 40 and 75%) for other 10 and lower than 40% for 7 compounds (bisphenol A, 1-H benzotriazole, atenolol, carbamazepine, hydrochlorothiazide, ketoprofen, naproxen). Furthermore, a four-weeks micropollutants spiking experiment (at 50 µg/L) was performed. The VertECO demonstrated a good capacity in removing organic pollutants from greywater. The complex microorganism populations appear to be self-adapting with indications that the longer they are exposed to certain organic pollutants, the better they get at breaking them down.

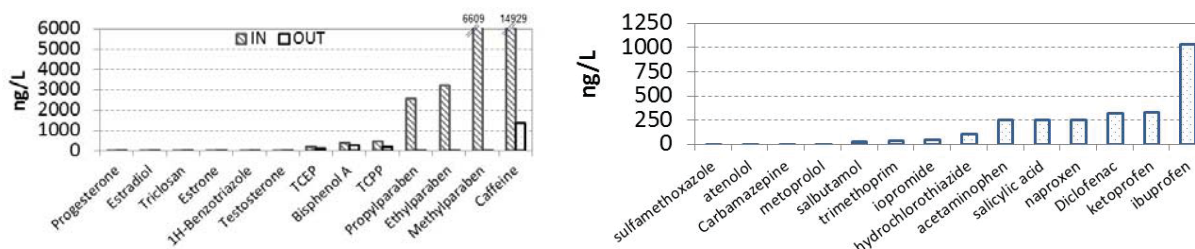


Fig. 2. Occurrence of selected EDCs influent and effluent (left) and PhACs in the effluent (right); n=75.

## Acknowledgments

This document has been produced with the assistance of the European Union (Grant agreement N° 619116), the support of ICRA (2014 SGR 291) and RyC-2014-16754.

## References

- Moreno-González R., Rodríguez-Mozaz S., Gros M., Barceló D., León V.M. (2015), Seasonal distribution of pharmaceuticals in marine water and sediment from a Mediterranean coastal lagoon (SE Spain). *Environ Res* 13, 326-344.
- Ramprasad, C., Philip, L. (2016). Surfactants and personal care products removal in pilot scale horizontal and vertical flow constructed wetlands while treating greywater. *Chem Eng J*, 284: 458–468.
- Revitt, D.M., Eriksson E., Erica Donner E. (2011). The implications of household greywater treatment and reuse for municipal wastewater flows and micropollutant loads. *Water Res*, 45:1549 -1560.

# Alternative use of *Pseudomonas aeruginosa* as a greywater disinfection indicator by Advanced Oxidation Processes

Ref # S2SMALL- 85630

A. Teodoro<sup>1</sup>, A. Machulek Júnior<sup>2</sup>, M. Á. Boncz<sup>3</sup>, P. L. Paulo<sup>4\*</sup>

<sup>1 2 3 4</sup>Faculty of Engineering, Architecture and Urbanism, and Geography (FAENG), Federal University of Mato Grosso do Sul (UFMS), Cidade Universitaria, Campo Grande - MS, Brazil.

\* Presenting Author: [paula.paulo@ufms.br](mailto:paula.paulo@ufms.br)

**Abstract:** Greywater presents great potential for reuse, if treated correctly and efficiently, it can be used in a variety of residential uses. The objective of this work was to test advanced oxidation for greywater disinfection through UV/TiO<sub>2</sub>, UV/TiO<sub>2</sub>/H<sub>2</sub>O<sub>2</sub>, photo-fenton, UV/H<sub>2</sub>O<sub>2</sub> and Photolysis (UV) processes, using *Pseudomonas aeruginosa* as an alternative indicator. In general, the processes with hydrogen peroxide (150 mg.L<sup>-1</sup>) mixed in the pretreated greywater and exposed to solar radiation or artificial radiation from UV lamps were the most efficient in the disinfection experiments, with total inactivation of *P. aeruginosa*. These processes (UV/H<sub>2</sub>O<sub>2</sub> and photo-Fenton) were better fitted to the log-linear/caudal decay model with remaining microorganism for the hydrogen peroxide concentration of 25 mg.L<sup>-1</sup>. The use of *P. aeruginosa* as an alternative indicator for the greywater disinfection was very promising due to its high resistance and high natural concentration in the effluent used in the experiments. The treatment applied with the UV/H<sub>2</sub>O<sub>2</sub> process with the hydrogen peroxide concentration at 150 mg.L<sup>-1</sup> was the only one that showed acute toxicity, even though it removed a good part of the surfactant concentration from the pre-treated greywater.

**Keywords:** effluent treatment; pathogen indicator; source separation

## INTRODUCTION

Greywater is defined as wastewater without effluent contributions from sanitary basins, which means only wastewater produced in bathtubs, showers, washbasins, washing machines and kitchen sinks. It is considered a highly recoverable water source, especially in countries suffering from water scarcity (Tsoumachidou et al., 2017). Light greywater refers to the wastewater produced by the previously mentioned sources, excluding greywater from the kitchen sink because it has a higher amount of undesirable compounds such as oils and fats (Allen et al., 2010). The relatively high concentration of the readily biodegradable fraction of organic matter may contribute in some cases to the presence of high levels of pathogens in greywater (Ridderstolpe, 2004).

For years, *Escherichia coli*, the main representative of the thermotolerant coliform subgroup, has been used as an indicator of fecal contamination. However its use for this purpose has been questioned. Some disadvantages are pointed out about the general use of *Escherichia coli*, such as its low tolerance to saltwater toxicity and accelerated bacterial decay, which may provide non-real data regarding the presence of other pathogenic microorganisms such as Giardia cysts, Cryptosporidium oocysts and human enteric viruses, which exhibit superior resistance to disinfectants. As with domestic sewage, due to the different characteristics of greywater, it is advisable to use more than one microorganism indicator. Mohammed et al. (2012) found that non-enteric bacteria (*Pseudomonas aeruginosa* and *Staphylococcus aureus*) had a good ability to reproduce and persist, particularly in sterile dry sand, in addition to surviving a number of conditions. Thus, it is believed that these microorganisms can be used more reliably as indicators. *P. aeruginosa* are opportunistic bacteria, related to several cases of serious infections, mainly in hospital ones. They can be found widely in the environment, human skin and also in the feces of sick people (Toledo & Trabulsi, 2002). According to

Pitten et al. (2001), *P. aeruginosa* has a strong involvement in the most severe infections, such as those of the respiratory tract, urinary tract and the blood flow. Characterized by straight or curved bacilli, the genus *Pseudomonas* is restricted aerobic, gram-negative and has mobility through flagella. They have the capacity to grow in waters with low levels of dissolved solids and organic compounds, adapting easily in environments with low nutrient availability. Because of the natural resistance to several antibiotics, the presence of *Pseudomonas aeruginosa* is closely related to hospital infection cases and is capable of triggering several waterborne gastroenteritis outbreaks (Bier, 1994). The choice of disinfection indicators to be used for greywater reuse should indicate the true risks that this wastewater can pose. *Pseudomonas aeruginosa* is an example of microorganism that can be used with complementary pollution indicators in addition to the coliform group (Jones et al., 2013). *Pseudomonas* present in greywater can cause various diseases and compromise the organoleptic characteristics of water. Direct contact with water or effluents containing a sufficient number of these microorganisms can produce various infections on the skin, mucous membranes of the eyes, ears, nose and throat, thus requiring prior treatment to ensure safe reuse (WHO, 2006). In this sense, Advanced Oxidation Processes (AOP) can be used for the decontamination of water containing organic pollutants, classified as bio recalcitrant, and for the disinfection of emerging pathogens (Polo-López et al., 2012). These methods are based on the formation of highly reactive chemical species that degrade even the most recalcitrant molecules in biodegradable compounds (Malato et al., 2009), and have been widely studied in the last decades with several applications for effluent treatment (Dewil et al., 2017). Although there are different advanced oxidation processes, they are all driven by the same chemical characteristic: hydroxyl radical production ( $\text{HO}^\cdot$ ), which are capable of oxidizing and mineralizing almost any organic molecule, producing  $\text{CO}_2$  and inorganic ions under the proper conditions (Machulek Jr et al., 2013). Thus, the objective of this work was to test different greywater disinfection systems using advanced oxidation processes using an alternative disinfection indicator.

## **MATERIAL AND METHODS**

The experiments were carried out on bench scale and pilot scale. For the bench tests, cylindrical photochemical reactors of borosilicate glass were used, with a useful volume of 1 L (first and second stages of tests). The UV radiation source was a 125 W high pressure mercury vapour lamp (without the protective bulb) with the maximum emission at 254 nm, positioned along the longitudinal axis of the reactor and protected by a quartz tube. The radiation intensity ( $4.30 \text{ mW}\cdot\text{cm}^{-2}$ ) was determined by actinometry with potassium oxalate, according to the methodology proposed by Harris et al., 1987. The greywater was recirculated in the reactor by pumping through an external auxiliary reservoir with a volume of 2 L. An isolation system consisting of a sealed wooden box was used to protect the operator from the radiation of the lamp. In the bench scale, PET bottles exposed to the sun were also used, functioning as photocatalytic reactors (third stage). For the pilot scale (fourth stage), baffled reactors with recirculation and solar radiation were used.

The intensity of the solar radiation was determined by means of a radiometer installed in the INMET meteorological station, near the locale of the experiment. These reactors were built with a  $22^\circ$  slope (approximate latitude of the city Campo Grande-MS), positioned on the roof of the Effluent Laboratory at the Federal University of Mato Grosso do Sul to receive solar radiation.

The use of *Pseudomonas aeruginosa* as an alternative indicator of disinfection in greywater was evaluated through the use of advanced oxidation processes with bench scale and pilot scale reactors, comparing the efficiency among the various processes:  $\text{TiO}_2/\text{UV}$ ,

TiO<sub>2</sub>/UV/H<sub>2</sub>O<sub>2</sub>, foto -Fenton, H<sub>2</sub>O<sub>2</sub>/UV and Photolysis (UV). The experiments were carried out in the following sequence:

- **1<sup>st</sup> Stage:** Bench scale tests with a photochemical reactor and a UV lamp operating in batch; heterogeneous photocatalysis with TiO<sub>2</sub> supported in Pyrex glass microtubes (used as reactor filling) and UV, H<sub>2</sub>O<sub>2</sub>, UV/TiO<sub>2</sub>, UV/H<sub>2</sub>O<sub>2</sub> and UV/TiO<sub>2</sub>/H<sub>2</sub>O<sub>2</sub> processes. The hydrogen peroxide concentration for this stage was 150 mg.L<sup>-1</sup>.
- **2<sup>nd</sup> Stage:** Bench scale tests with a photochemical reactor and a UV lamp operating in batch; homogeneous photocatalysis with the processes photo-Fenton, UV and UV/H<sub>2</sub>O<sub>2</sub>. Two hydrogen peroxide concentrations were used for this test stage: 25 and 150 mg.L<sup>-1</sup>.
- **3<sup>rd</sup> Stage:** Bench scale tests with a solar photochemical reactor (photocatalysis in PET bottles exposed to the sun) operating in batch; homogeneous photocatalysis with the photo-Fenton, UV and UV/H<sub>2</sub>O<sub>2</sub> processes. For this stage, two hydrogen peroxide concentrations were used: 25 and 150 mg.L<sup>-1</sup>.
- **4<sup>th</sup> Stage:** Tests in a pilot reactor in a baffled reactor with acrylic tubes (continuous photochemical solar reactor with recirculation) operating in batch; homogeneous photocatalysis with the UV and UV/H<sub>2</sub>O<sub>2</sub> processes. The hydrogen peroxide concentrations for this stage were 25 and 150 mg.L<sup>-1</sup>.

The greywater used in the experiments consisted of mixing the water from washbasins, washing machines, bathtubs and showers. This water did not contain the kitchen fraction, and was collected after passing through a pretreatment system composed of an evapotranspiration tank followed by a constructed wetland with horizontal flow. The plant species *Heliconia psittacorum* L.f. (popularly known as heliconia or andromeda) was chosen to be used in the constructed wetland. Table 1 shows the mean values of the physical-chemical parameters used for monitoring the greywater treatment system.

**Table 1.** Mean values of the parameters used for monitoring the greywater treatment system.

Parameters	<i>P. aeruginosa</i> (log)	Color (Pt.L <sup>-1</sup> )	COD (mg.L <sup>-1</sup> )	Turb. (NTU)	Surfactants (mg.L <sup>-1</sup> )	pH	Temp. (°C)
1 <sup>st</sup> Stage	3.4	95	120.45	19	2.51	6.95	24
2 <sup>nd</sup> Stage	4.7	72	85.50	15	2.51	7.01	24
3 <sup>rd</sup> Stage	3.4	80	75.00	15	2.31	6.87	26
4 <sup>th</sup> Stage	2.5	52	80.00	7	3.47	7.07	23

For the analysis of *Pseudomonas aeruginosa*, the Pseudalert® method of IDEXX, USA, approved by the United States Environmental Protection Agency (USEPA) and included in the Standard Methods for the Examination of Water and Wastewater (APHA, 2012) was used. All tests were performed in triplicate, with a duration of two hours, and samples were collected for analysis at 20, 40, 60, 90 and 120 minutes for the bench scale and at 30, 60, 90 and 120 minutes for the pilot scale. For the bacterial decay curves, the adjustments were verified through the correlation coefficient in two inactivation models: Chick-Watson and Log-Linear/Caudal. In order to predict the possibility of discharging greywater disinfected by advanced oxidation process (UV/H<sub>2</sub>O<sub>2</sub>) in streams and rivers, ecotoxicological tests were carried out since the reactor in the pilot scale (acrylic tubes) can be installed to disinfect effluents from small condominium treatment systems.

## RESULTS AND DISCUSSION

The disinfection studies performed in this study showed that it is possible to disinfect light greywater for reuse purposes in a sanitary basin, with an alternative disinfection indicator (*Pseudomonas aeruginosa*) in a fast and economical way, by using UV radiation combined with some advanced oxidation processes. In the experiments, both the heterogeneous photocatalysis with titanium dioxide combined with hydrogen peroxide and the homogeneous photocatalysis with hydrogen peroxide and ferrous ion were able to inactivate significant amounts of *Pseudomonas aeruginosa*. The use of hydrogen peroxide without exposure to UV/solar radiation (blank) was ineffective for disinfection, with a reduction of less than one log unit for *Pseudomonas aeruginosa*. The results are presented below.

### • 1st Stage

It was possible to obtain a homogeneous layer of TiO<sub>2</sub> deposited in the small Pyrex glass tubes (used as reactor filling), with a mean thickness of 35.3 μm. However, only the use of TiO<sub>2</sub> with UV radiation was not able to promote an increase in the inactivation of *Pseudomonas aeruginosa*. The photolysis performance (UV radiation only) was similar to the UV/TiO<sub>2</sub> process (Fig. 3, first stage), with slightly higher inactivation for *Pseudomonas aeruginosa* (0.7 log unit). In studies by Robertson et al. (2005), the direct UV radiation was also more effective for the removal of *Pseudomonas aeruginosa*. On the other hand, the processes with hydrogen peroxide were much more efficient, with complete inactivation of the alternative indicator within one hour of the experiment. *Pseudomonas aeruginosa* disinfection processes without the addition of hydrogen peroxide had a better fit to the classic Chick-Watson model (1<sup>st</sup> order), with higher correlation coefficients (R<sup>2</sup>) (Table 2). The process with added hydrogen peroxide had the same adjustment for both models. This is because the process has reached the complete inactivation of *Pseudomonas aeruginosa*, with no remaining population of microorganisms. Without the remaining microorganisms' component in the equation, the log-linear/caudal model becomes identical to the Chick-Watson model. For the processes with titanium dioxide, the unviability in the conditions tested in this study was due to the difficulty in obtaining a homogeneous and consistent layer of TiO<sub>2</sub> deposited in the small Pyrex glass tubes. Even reaching optimum deposition of this layer, the UV/TiO<sub>2</sub> process did not achieve complete inactivation of the indicator microorganisms. For this, it was necessary to add hydrogen peroxide combined with titanium dioxide (UV/TiO<sub>2</sub>/H<sub>2</sub>O<sub>2</sub> process).

### • 2<sup>nd</sup> Stage

The tests showed that the systems with the highest hydrogen peroxide concentration (150 mg.L<sup>-1</sup>) were the most efficient, reaching complete inactivation of *Pseudomonas aeruginosa*. It is believed that the generation of hydroxyl radicals by the Fenton reaction was responsible for the total inactivation, since even the H<sub>2</sub>O<sub>2</sub>/UV system without the addition of iron also reached this condition. This is due to iron present in the cellular metabolism of *Pseudomonas* reacting with the peroxide and producing HO· radicals (Ortega-Gómez et al., 2012; Agulló-Barceló et al., 2013). The UV experiments had efficiency very close to the systems with low peroxide concentrations, reaching a maximum of 3 log units of inactivation (Figure 1, second stage). The Fenton reaction with low peroxide concentrations was not so favored due to the peroxide consumption by organic matter contained in the effluent. In this case, we can observe that the disinfection reached was mainly through UV radiation. These results differ from those presented in some studies with gram-negative pathogenic bacteria, spores and bacteriophage viruses, in which the synergistic effect of low H<sub>2</sub>O<sub>2</sub> and UV radiation concentrations are highlighted, reaching up to 6 log units of inactivation (Fisher et al., 2008; Polo-López et al., 2011). The best adjustments to the log-linear/caudal model, with



the remaining microorganisms at the end of the experiments, were found with the photo-Fenton and UV/H<sub>2</sub>O<sub>2</sub> processes, both with a hydrogen peroxide concentration of 25 mg.L<sup>-1</sup> (Table 2). For the tests with a concentration of 150 mg.L<sup>-1</sup> in which total inactivation occurred, it was not possible to adjust the bacterial decay curve to the models compared in this study.

- **3<sup>rd</sup> Stage**

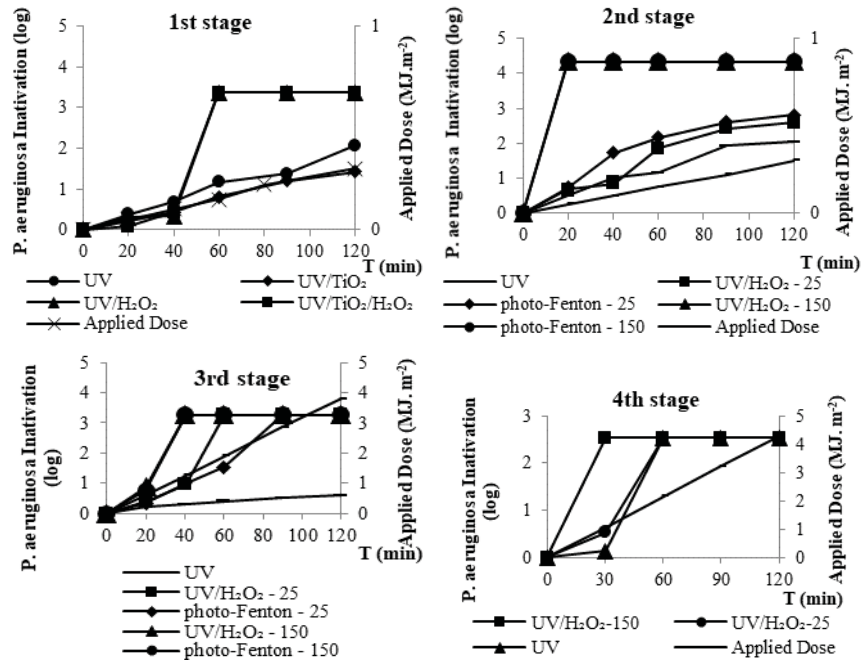
On a bench scale, with PET bottles functioning as photocatalytic reactors, the tests showed that for the highest hydrogen peroxide concentrations used in the experiments there was no difference in the levels of disinfection between the UV/H<sub>2</sub>O<sub>2</sub> and photo-Fenton processes. The UV process (photolysis) was not able to fully inactivate *P. aeruginosa*. Only a small inactivity occurred (less than one log unit). For the UV/H<sub>2</sub>O<sub>2</sub> and photo-Fenton processes, both with a hydrogen peroxide concentration of 150mg.L<sup>-1</sup>, the inactivation of *P. aeruginosa* showed a low active initial phase followed by a marked development in the disinfection curve until complete inactivation occurred (Figure 1, third step). The low activity in the beginning of the test can be attributed to the resistance of bacteria to oxidative stress. It has also been observed in some cases that increasing the H<sub>2</sub>O<sub>2</sub> concentration to 150 mg.L<sup>-1</sup> broke the initial bacterial resistance and can achieve total disinfection in less time. The tests carried out showed that for the highest hydrogen peroxide concentrations used in the experiments there was no difference in the levels of disinfection between the UV/H<sub>2</sub>O<sub>2</sub> and photo-Fenton processes. These processes with the highest hydrogen peroxide concentration (150 mg.L<sup>-1</sup>) were the most efficient in all tests, reaching total inactivation of the microorganisms in less time, in the same way as in the previous stages. As in the second stage of the tests, again the processes with hydrogen peroxide in the concentration of 150 mg.L<sup>-1</sup> were the most efficient in the disinfection of the pretreated greywater. The processes with hydrogen peroxide concentrations of 25 mg.L<sup>-1</sup> also reached total inactivation, however, in a longer time. In general, the processes did not have a good fit to the compared decay models, being the photo-Fenton process with a hydrogen peroxide concentration of 25 mg.L<sup>-1</sup> that was better adjusted with the same correlation coefficients for total inactivation of *P. aeruginosa* (Table 2). It is believed that this is due to the smaller experimental control, mainly to the variations of solar radiation in this stage of the tests. It was also not possible to adjust the bacterial decay curve to the models compared in the hydrogen peroxide concentration of 150 mg.L<sup>-1</sup>.

- **4<sup>th</sup> Stage**

In this stage, the UV/H<sub>2</sub>O<sub>2</sub> process with the hydrogen peroxide concentration of 150 mg.L<sup>-1</sup> was also the most effective, reaching complete inactivation of *P. aeruginosa* in 30 minutes of solar exposure, with an applied dose of 1.08 MJ.m<sup>-2</sup>. Photolysis tests (UV process) were effective for the inactivation of *P. aeruginosa* (Fig. 3, fourth stage), in which complete inactivation occurred in only one hour of sun exposure. Studies by Ubomba-Jaswa et al., (2009) have shown that the use of the highest UV radiation over a short period of time is more advantageous than a lower intensity over long periods in terms of the bacteria's ability to respond and repair the damage caused by UV incidence. High UV radiation acts to negatively affect the efficiency of cell repair enzymes, attacking the defense mechanisms and preventing photoreception (Rincón & Pulgarin, 2006). For the tests with UV and H<sub>2</sub>O<sub>2</sub> processes with a hydrogen peroxide concentration of 25 mg.L<sup>-1</sup>, an initial soft decay was observed, followed by an inactivation region with log-Linear until the total inactivation of the microorganisms, without any remaining population. As in the previous stages, it was not possible to adjust the bacterial decay curves to the inactivation models compared in the hydrogen peroxide concentrations at 150 mg.L<sup>-1</sup>. It is observed that for the conditions tested in this study, hydrogen peroxide in a synergistic effect with UV radiation was the key factor



for the increased disinfection rate. Although the processes did not present a good fit to the decay model for the 4<sup>th</sup> stage, it was possible to confirm the high disinfection efficiency of the UV/H<sub>2</sub>O<sub>2</sub> process, with simple use and low cost.



**Figure 1.** Inactivation of *Pseudomonas aeruginosa* for the four experimental stages. The hydrogen peroxide concentrations of 150 mg.L<sup>-1</sup> and 25 mg.L<sup>-1</sup> were used for stages 2, 3 and 4. For the first stage, only the concentration of 150 mg.L<sup>-1</sup> was used.

After the experiments, the samples kept at room temperature without the presence of light did not show bacterial regrowth within 24 hours of storage, thus showing the possibility of using treated greywater in domestic reuse.

**Table 2.** *Pseudomonas aeruginosa* inactivation constants for the various disinfection stages.

		Bacterial Decay Models			
		$C/C_0 = e^{-k.t}$ (Chick-Watson)		$(C - C_{rem})/(C_0 - C_{rem}) = e^{-k.t}$ (Log-Linear/Caudal)	
	Process	k (min <sup>-1</sup> )	R <sup>2</sup>	k (min <sup>-1</sup> )	R <sup>2</sup>
1 <sup>st</sup> stage	UV	0.04	0.98	0.05	0.88
	UV/TiO <sub>2</sub>	0.03	0.99	0.05	0.86
	UV/TiO <sub>2</sub> /H <sub>2</sub> O <sub>2</sub>	0.08	0.77	0.08	0.77
2 <sup>nd</sup> stage	UV	0.04	0.94	0.05	0.96
	UV/H <sub>2</sub> O <sub>2</sub>	0.06	0.96	0.07	0.97
	photo-Fenton	0.06	0.85	0.09	0.99
3 <sup>rd</sup> stage	UV	0.02	0.88	0.03	0.90
	UV/H <sub>2</sub> O <sub>2</sub>	0.08	0.80	0.08	0.80
	photo-Fenton	0.07	0.94	0.07	0.94
4 <sup>th</sup> stage	UV	0.06	0.76	0.06	0.76
	UV/H <sub>2</sub> O <sub>2</sub>	0.06	0.78	0.06	0.78

- Ecotoxicity tests**

For UV and UV/H<sub>2</sub>O<sub>2</sub> processes with hydrogen peroxide concentrations at 25 mg.L<sup>-1</sup> all test organisms survived. Only samples with a higher H<sub>2</sub>O<sub>2</sub> concentration (150 mg.L<sup>-1</sup>) showed toxicity in the preliminary tests (100%). With this positive immobilization result, the dilutions were carried out at 50, 25, 12.5 and 6.25%. For the first three dilutions, no microorganisms

exposed to disinfected greywater survived. Only the 6.25% dilution decreased the immobility rate, with a value reduced to 90%. According to the results, the dilution of 6.25% of the greywater sample disinfected by the UV/H<sub>2</sub>O<sub>2</sub> process with the hydrogen peroxide concentration of 150 mg.L<sup>-1</sup> is no more toxic to the microorganism in question. Anionic surfactants are probably the main compound present in greywater capable of offering toxicity to *Daphnia*. However, the raw greywater used in this work presented a mean anionic surfactant concentration of 2.31 mg.L<sup>-1</sup>, below the lethal concentration range that according to the US Environmental Protection Agency (EPA, 2007) is 5.8 - 9.5 mg.L<sup>-1</sup> for anionic surfactants regarding dodecylbenzene sulfonate. In general, greywater treatment reduces the acute toxic effect, as in studies by Hernández Leal et al., (2012). However, in the present study, the treatment applied with the UV/H<sub>2</sub>O<sub>2</sub> process in the hydrogen peroxide concentration of 150 mg.L<sup>-1</sup> was the only one that presented acute toxicity, even though it removed a good part of the concentration of surfactants from the raw greywater. This toxicity was probably due to the use of hydrogen peroxide, which is still present in greywater samples after sun exposure.

## CONCLUSIONS

In general, the processes with hydrogen peroxide (150 mg.L<sup>-1</sup>) mixed in the pretreated greywater and exposed to solar radiation or artificial radiation from UV lamps were the most efficient in the disinfection experiments, with total inactivation of *P. aeruginosa*. These processes (UV/H<sub>2</sub>O<sub>2</sub> and photo-Fenton) were better fitted to the log-linear/caudal decay model with remaining microorganisms using the hydrogen peroxide concentration of 25 mg.L<sup>-1</sup>. The use of *P. aeruginosa* as an alternative greywater disinfection indicator was very promising due to its higher resistance and higher natural concentration in the effluent used in the experiments. The treatment applied with the UV/H<sub>2</sub>O<sub>2</sub> process in the hydrogen peroxide concentration of 150 mg.L<sup>-1</sup> was the only one that showed acute toxicity, even though it removed a good part of the surfactant concentration from the raw greywater. This toxicity was probably due to the use of hydrogen peroxide, which is still present in greywater samples after sun exposure. For safety, reuse of greywater disinfected with UV radiation combined with advanced oxidation processes, it is recommended that disinfection tests should be carried out with other indicator microorganisms such as *S. aureus*, *C. perfringens* and *S. faecalis*, in addition to a microbiological risk analysis.

## ACKNOWLEDGEMENTS

This work was supported by FINEP, a Brazilian Funding Authority for Studies and Projects under grant n° 01.12.0112-00.

## REFERENCES

- Allen L., Smith J.C., Palaniappan M. 2010 Overview of gray water reuse: the potential of gray water systems to aid sustainable water management, Pacific Institute.
- Agulló-Barceló M., Polo-López M.I., Lucena F., Jofre J., Fernandez-Ibañez P. 2013 Solar Advanced Oxidation Processes as disinfection tertiary treatments for real wastewater: implications for water reclamation. *Applied Catalysis B: Environmental*, **136–137**, 341– 350.
- Chin W. H., Roddick F.A., Harris J.L. 2009 Greywater treatment by UVC/H<sub>2</sub>O<sub>2</sub>. *Water Research*, **43**, 3940-3947.
- Dewil R., Mantzavinos D., Poulios, I., Rodrigo, Manuel A. 2017 New perspectives for Advanced Oxidation Processes. *Journal of Environmental Management*, **195**, Part 2, 93-99.
- Fisher M. B., Keenan C. R., Nelson K. L., Voelker B. M. 2008 Speeding up solar disinfection (SODIS): effects of hydrogen peroxide, temperature, pH, and copper plus ascorbate on the photoinactivation of *E. coli*. *Journal of Water and Health*, **31**, 45-55.

- Guidelines for drinking-water quality: incorporating first addendum* 2006 3rd ed. WHO, Geneva, Switzerland.
- Harris G. D., Asce M., Adams V. D., Moore W. M., Sorensen D. 1987 Potassium ferrioxalate as chemical actinometre in ultraviolet reactors. *Journal of Environmental Engineering*, **113**, 612-627.
- Hernández Leal, L., Soeter A. M., Kools S. A. E., Kraak M. H. S., Parsons J. R., Temmink H., Zeeman G., Buisman C. J. N. 2012 Ecotoxicological assessment of grey water treatment systems with *Daphnia magna* and *Chironomus riparius*. *Water Research*, **46**, 1038 – 1044.
- Jones, R. M., Liu L., Dorevitch S. 2013 Hydrometeorological variables predict fecal indicator bacteria densities in freshwater: data-driven methods for variable selection. *Environmental monitoring and assessment*, **185**, 2355-2366.
- Machulek A. Jr, Oliveira S.C., Ferreira V.S., Osugi M.E., Quina F.H., Dantas R.F., Oliveira S.L., Casagrande G.A., Anaissi F.J., Silva V.O., Cavalcante R.P., Gozzi F., Ramos D.D., Rosa A.P.P., Santos A.P.F., Castro D.C., Nogueira J. A. 2013 Application of different advanced oxidation processes for the degradation of organic pollutants. In: *Organic Pollutants - Monitoring, Risk and Treatment*, 1st edn, Nageeb Rashed, InTech, pp. 141–166.
- Malato, S., Fernández-Ibáñez, P., Maldonado, M.I., Blanco, J., Gernjak, W. 2009 Decontamination and disinfection of water by solar photocatalysis: Recent overview and trends. *Catalysis Today*, **147**, 1–59.
- Methods for measuring the acute toxicity of effluents and receiving waters to freshwater and marine organisms* 2007, Environmental Protection Agency - USA., Washington, D.C.
- Mohammed A. F., Abdul-Wahid A., Huang E. H., Bolewska-Pedyczak E., Cydzik M., Broad A. E., Gariépy J. 2012 The *Pseudomonas aeruginosa* exotoxin A translocation domain facilitates the routing of CPP-protein cargos to the cytosol of eukaryotic cells. *Journal of Controlled Release*, **164**, 58-64.
- Ortega-Gómez E., Fernández-Ibáñez P., Ballesteros Martín M.M., Polo-López M.I., Esteban García B., Sánchez Pérez J.A. 2012 Water disinfection using photo-Fenton: Effect of temperature on *Enterococcus faecalis* survival. *Water Research*, **46**, 6154–6162.
- Pitten F. A., Suresh C. P., Michael K. S. 2001 Transmission of a multiresistant *Pseudomonas aeruginosa* strain at a German University Hospital. *Journal of Hospital Infection*, **47**, 125-130.
- Polo-López M. I., García-Fernández I., Oller I., Fernández-Ibáñez P. 2011 Solar disinfection of fungal spores in water aided by low concentrations of hydrogen peroxide. *Photochemical & Photobiological Sciences*, **10**, 381-388.
- Polo-López M. I., García-Fernández I., Velegraki T., Katsoni A., Ollera I., Mantzavinos D., Fernández-Ibáñez P. 2012 Mild solar photo-Fenton: An effective tool for the removal of *Fusarium* from simulated municipal effluents, *Applied Catalysis, B Environmental*, **111– 112**, 545 – 554.
- Ridderstolpe P. 2004 *Introduction to Greywater Management*. EcoSan Publication series. EcoSanRes Programme and Stockholm Environment Institute (SEI). Report 2004-4. WRS Uppsala AB.
- Rincón A. G., Pulgarí, C. 2006 Comparative evaluation of Fe<sup>3+</sup> and TiO<sub>2</sub> photoassisted processes in solar photocatalytic disinfection of water. *Applied Catalysis B: Environmental*, **63**, 222-231.
- Robertson J. M. C., Robertson P. K. J., Lawton L. A. 2005 A comparison of the effectiveness of TiO<sub>2</sub> photocatalysis and UVA photolysis for the destruction of three pathogenic micro-organisms. *Journal of Photochemistry and Photobiology A*, **175**, 51–56.
- Standard Methods for the Examination of Water and Wastewater* 2012 21th edn, American Public Health Association/American Water Works Association/Water Environment Federation, Washington DC, USA.
- Toledo M. R. F., Trabulsi L. R. 2002 *Pseudomonas*. In: *Microbiologia*, 3 ed., São Paulo: Atheneu, pp. 586.
- Tsoumachidou S., Velegrakia T., Antoniadisa A., Poullos I. 2017 Greywater as a sustainable water source: A photocatalytic treatment technology under artificial and solar illumination. *Journal of Environmental Management*, **195**, Part 2, 232-241.
- Ubomba-Jaswa E., Navntoft C., Polo-López M. I., Fernandez-Ibáñez, P., McGuigan K. G. 2009 Solar disinfection of drinking water (SODIS): an investigation of the effect of UV-A dose on inactivation efficiency. *Photochemical & Photobiology Science*, **8**, 587–595.

# Greenhouse gas emissions from soil treatment units of on-site domestic wastewater treatment systems in Ireland

Somlai-Haase, C.<sup>1</sup>, Knappe, J.<sup>1,2</sup>, Gill, L.<sup>1</sup>

<sup>1</sup> Department of Civil, Structural and Environmental Engineering, Trinity College Dublin, The University of Dublin, Ireland

<sup>2</sup> MACSI, University of Limerick, Ireland

**Keywords:** Carbon Dioxide, Methane, Soil flux, Septic systems

## Introduction

38% of the Irish population lives in rural areas and nearly 30% of Irish households rely on individual domestic on-site wastewater treatment systems (DWWTS). In DWWTS most commonly, wastewater from single households is initially treated by a septic tank, in which organic matter of the influent is converted into carbon dioxide (CO<sub>2</sub>) and methane (CH<sub>4</sub>) by microbial processes. The effluent from the tank is released into the soil treatment unit (STU) where additional CO<sub>2</sub> and CH<sub>4</sub> are emitted to the atmosphere as well as nitrous oxide (N<sub>2</sub>O) from the partial denitrification of nitrate. Additional secondary treatment packaged units (e.g. coconut/peat filter, rotating biological contractor) can be installed prior to the STU to provide further treatment of the wastewater. In older systems the STU is often a simple soakaway, a pit back-filled with rubble and fed from the septic tank by a single effluent pipe, but more optimally now an STU should be constructed as a larger percolation area where the effluent is distributed over a wider area through a network of percolation trenches.

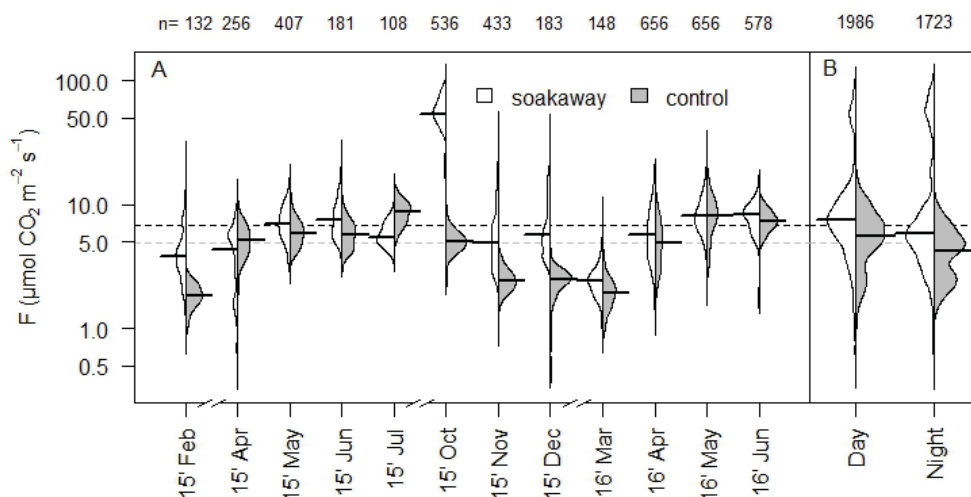
Considering the large number of DWWTS in Ireland and internationally, septic systems are potential significant sources of greenhouse gas (GHG) emissions. However, there have been a limited number of direct field studies and existing inventories are based on the assumption of the conversion rate of organic matter entering the systems in the septic tank excluding the potential emissions from the STU. Here we present long-term and diurnal variations of soil fluxes from STU at different DWWTS in Ireland.

## Material and Methods

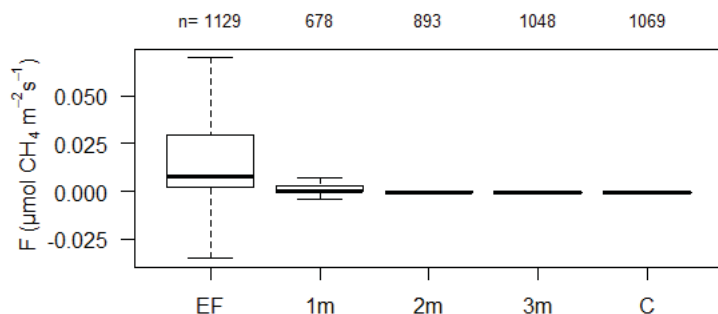
Long-term soil flux measurements of CO<sub>2</sub> and CH<sub>4</sub> were carried out using automated chambers and a closed-transient measurement approach (LI-8100 Automated Soil CO<sub>2</sub> Flux System, Li-Cor<sup>®</sup>) with an additional GHG analyzer (Ultra-Portable GGA, model 915-0011, Los Gatos Research<sup>®</sup>). During incubation, a chamber is moved by a non-flexible arm over a collar which is inserted into the soil creating a closed gas loop between the chamber and the GHG analyser to measure the change in gas concentration under the chamber. Multiple chambers were deployed over the STU and control site, each recording hourly flux measurements. GHG emissions were correlated against different meteorological and soil parameters. The soil flux system has been rotated between different sites from February 2015 ongoing.

## Results and Discussion

We observed seasonal (Figure 1) and spatial variations (Figure 2) of GHG fluxes at multiple sites. While temperature, soil water content, and atmospheric pressure were identified as the most significant environmental factors correlated to the release of CO<sub>2</sub> from the control site, fluxes from the soakaway showed weaker correlations in regard to environmental factors.



**Figure 1.** Over a period of 17 months, CO<sub>2</sub> fluxes were recorded semi-continuously over a soakaway and control. The monthly (A) and diurnal (B) variation of log-scaled CO<sub>2</sub> fluxes from a soakaway (white) and control (grey) as density curve bean plots with median values (black lines) for each group. Dashed lines represent median soil gas flux from the soakaway (black) and control (grey).



**Figure 2.** Boxplots of spatial variation of CH<sub>4</sub> fluxes from a soakaway at the effluent (EF), 1 meter stepwise away from the soakaway (1m, 2m, 3m) and at the control site (C) over a period of 2 and half month in 2016.

## References

- CSO (2011) This is Ireland - Highlights from Census 2011, Part 1. Central Statistics Office, 2011.
- IPCC (2006). 2006 IPCC Guidelines for National Greenhouse Gas Inventories, Prepared by the National Greenhouse Gas Inventories Programme. Eggleston H.S., Buendia L., Miwa K., Ngara T. and Tanabe K. (eds). Published: IGES, Japan.
- Somlai-Haase C., Knappe J. Gill L.W. (2017). Carbon dioxide emissions from a septic tank soakaway in a northern maritime climate. *Science of the Total Environment* 586, 485-491.

## The performance of a self-contained recirculating evapotranspiration system in tropical and temperate climates

Kele, B.<sup>1,2</sup>, Midmore, D.<sup>1</sup>, Walsh, K.<sup>1</sup>, Gardner, T.<sup>1,2</sup>, Kelly, J.<sup>1,2</sup>

<sup>1</sup> Central Queensland University, Bruce Highway, Rockhampton, Queensland, 4702, Queensland, Australia

<sup>2</sup> Arris Pty/Ltd, Building 11B, Gate 2C, Hartley Grove, University of Adelaide, Waite Campus, Urrbrae SA 5064, Australia

**Keywords:** plant selection, soil type, environmental set-back distances, sodicity, salinity, rhizopod

### Introduction

Some sites are very difficult to service successfully with on-site wastewater treatment and dispersal systems. The soil types may be unsuitable (heavy clays), the available land area too small, there may be nearby waterways or bores/wells, or environmental and/or building code set-back distances may limit available space. We developed a self-contained recirculating evapotranspiration trench that could be used with any standard on-site wastewater treatment system (Kele 2005, Kele *et al*, 2005). Pods made from either plastic or concrete were filled with soil suitable for the long-term application of effluent. Plants were grown in the top of the pods and they used the effluent via evapotranspiration. The number of pods and plants were calculated using the Penman-Monteith equation (Allen, *et al*, 1998). The pods stop the effluent from leaching into the local environment and the water usage by the plants means that no discharge/dispersal occurs into the external soil.

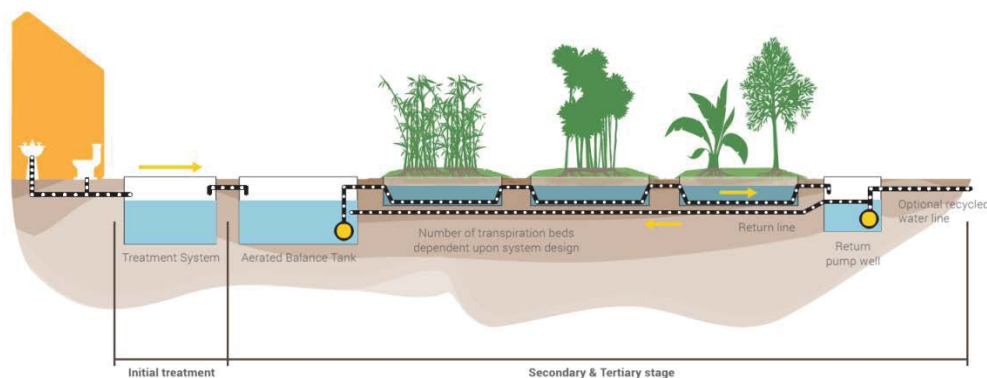


Figure 1: Schematic of the self-contained evapotranspiration trenches

### Material and Methods

Research on the RET system began in July 1997 in tropical Australia. The data collected from the research sites included plant growth, water usage via evapotranspiration, and soil health. Particular focus was on potential limiting factors in a self-contained system such as accumulations of salinity, sodicity, nitrogen, phosphorus, and heavy metals (VanDeGraff and Patterson, 2001). The original research sites now have 20 years worth of data. Australia



has tropical, sub-tropical, and temperate climate zones. The initial research was conducted in tropical and sub-tropical areas with a summer wet season and minimal frost in winter. New research sites have been installed in southern Australia where the wet season is in winter with significant frost and snow conditions. Comparisons are being made in regards to the effect of climate on water usage via evapotranspiration, impact on plant selection, and soil health.

## Results and Discussion

The 20 year observation trial has shown that with maintenance the limiting factors can be controlled ensuring that a self-contained system is sustainable (see Figure 1). Accumulations of salinity and sodicity can be managed with a fresh water flush through the system and the salt being transported away with the sludge from the treatment system (septic or package plant). Nutrient use can be increased via the selective pruning on the plants in the pods. This encourages new growth, which lowers the concentrations of the nitrogen and phosphorus in the effluent and the soil in the pods.



**Figure 2: 20 year growth comparison of bamboo in self-contained evapotranspiration trench**

The research sites in the temperate climates of southern Australia have shown that overcast and cooler conditions during winter significantly reduce the evapotranspiration volumes of the plants in the pods. Rainfall intrusions mechanisms on the pods mean that the plants do use effluent as they cannot easily access groundwater. The prevalence of cloud cover has a greater impact than the amount of rain. A model has been developed that uses climatic data and plant selection to determine the number of pods required in a system, the surface area of evapotranspiration material, and the volume required in the balance tank for wet weather storage.

## References

- Allen, R. G., et al. (1998). *Crop Evapotranspiration*. Rome, Food and Agriculture Organization of the United Nations: 1-281.
- Kele, B. (2005). *Onsite Wastewater Treatment and Reuse Using Recirculatory Evapotranspiration Channels* In Regional Queensland. *PSG - Master of Applied Science*. Rockhampton, CQU: 1-338.
- Kele, B., et al. (2005). "An Overview of the CQU Self-Contained Evapotranspiration Beds." *Water Science and Technology* **51**(10): 273-281.
- VanDeGraaff, R. and R. A. Patterson (2001). *Explaining the Mysteries of Salinity, Sodicty, SAR and ESP in On-site Practice*. On-site '01, University of New England Armidale, Lanfax Laboratories.

# **Willow evapotranspiration systems to mitigate surface water pollution from domestic wastewater in rural areas with low permeability soils**

Ref # S2SMALL- 46679

L.Gill<sup>1\*</sup>, S. Curneen<sup>1</sup>

<sup>1</sup> Dept. Civil, Structural and Environmental Engineering, Trinity College Dublin, Ireland

\* Presenting Author: laurence.gill@tcd.ie

**Keywords:** on-site wastewater, septic tank, low permeability, evapotranspiration, willow.

## **INTRODUCTION / MAIN METHODS**

The domestic wastewater of approximately one third of the population in Ireland (~500 000 dwellings) is treated on-site by domestic wastewater treatment systems (DWTS) of which more than 87% are septic tanks (CSO 2016). If situated and constructed incorrectly the potential impacts of such on-site effluent include the pollution of either groundwater and/or surface water. Areas with inadequate percolation due to low-permeability subsoils and/or high water tables present the greatest challenge whereby ponding and breakout of untreated effluent at the surface may occur with a risk of effluent discharge/runoff of pollutants to surface waters and to wells (Hynds et al. 2012) with associated serious health risks. It is estimated that the overall proportion of the country with inadequate conditions for DWTS (all year round or intermittently during wet weather conditions) is 39% (EPA 2013). Hence, the use of sealed basin evapotranspiration (ET) systems using willows has been trialled as a potential solution for such areas.

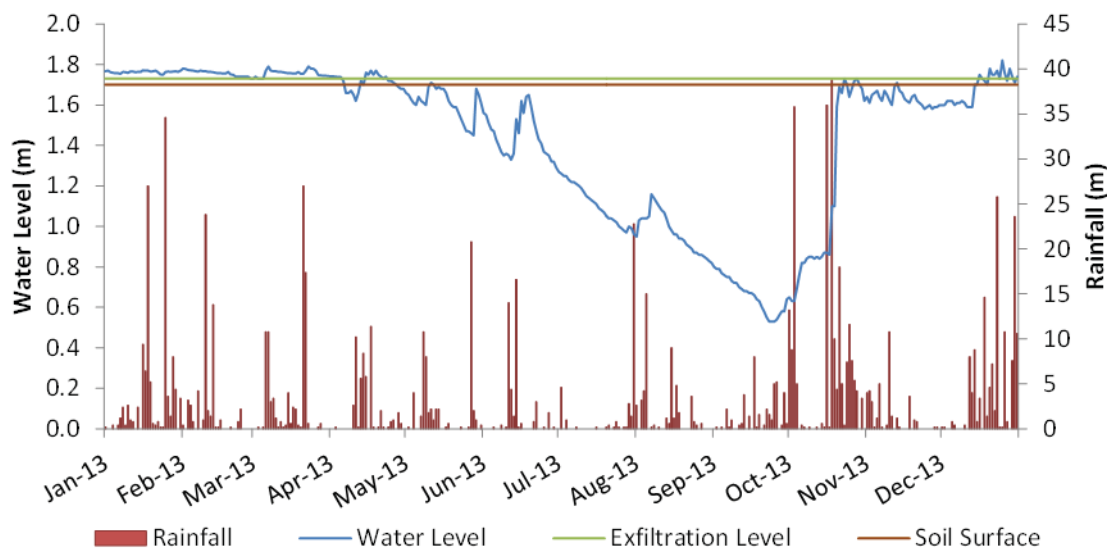
Fourteen full scale willow ET systems were constructed to treat domestic wastewater effluent from single house dwellings across Ireland, located in areas with very low permeability (i.e. clayey) subsoils, in which effluent percolation would not be a feasible for on-site effluent. The area and depth were based upon a modeled water balance between the expected wastewater production, local rainfall and estimated evapotranspiration from the basin over a four year period. The basins were excavated to a depth of 1.8 m and lined with an impermeable butyl rubber or low-density polyethylene membrane. The effluent was distributed either by pumping or gravity flow into pipes along the base of the basins bedded in 300 mm depth of gravel. The excavated soil was then back-filled into the basins up to ground level. Several different varieties of willow cuttings were then planted at a density of 3 per m<sup>2</sup>. The systems were designed with variations between key parameters (effluent type, willow species, plan area, aspect ratio), in order to compare overall performance.

Effluent flow into the basins, water level, rainfall and potential evapotranspiration have all been continuously monitored over four years to determine the water budget and crop coefficients at each site. The available pore space in the soil within each system was also determined via removal of replicate soil samples. The wastewater effluent and stored water in each system was also periodically tested for quality (organics, nutrients and indicator bacteria).

## MAIN RESULTS AND CONCLUSIONS

Evapotranspiration results varied greatly between sites, with some sites exhibiting excellent willow tree establishment and correspondingly high ET rates, while other sites showed much poorer performance. No system managed to achieve zero discharge in any year remaining at maximum levels for much of the winter months, indicating some loss of water by lateral exfiltration at the surface (see Fig. 1). One significant problem identified was the usable void ratio in the basins that had been refilled with the excavated low permeability subsoil was much lower than expected thereby leaving little room for effluent storage over the winter periods. In addition, the ET rates were lower when compared to other countries where these systems have been used, which was attributed mainly to the predominantly high relative humidity of the Irish climate. Water availability was determined to strongly influence the ET rate from a system, while the addition of effluent into the systems was shown to have had a positive effect on willow tree development. Pollutant uptake / removal was found to be very high on the systems with well-established willow trees and sampling and analysis of the surface overflow quality from the systems showed that it was similar to rainfall runoff in the adjacent fields, indicating that the systems act as very effective passive treatment systems.

The performance results (crop coefficients etc.) have been used to formulate national design guidelines for ET systems in such a temperate, maritime, Irish climate. Realistic dimensions have been established in order to minimise the number of days of potential overflow while keeping within the boundaries of reasonable practical and financial constraints.



**Figure 1.** Water level and daily rainfall for willow ET system in County Wexford, Ireland.

## REFERENCES

Central Statistics Office 2016 *Census 2016, Principal Demographic Results*; Central Statistics Office, Government of Ireland, Stationery Office: Dublin, Ireland, 2017.

EPA 2013 *A Risk-Based Methodology to Assist in the Regulation of Domestic Waste Water Treatment Systems*; Environmental Protection Agency: Wexford, Ireland, 2013.

Hynds PD., Misstear BDR., & Gill LW. 2012 Development of a microbial contamination susceptibility model for private domestic groundwater sources. *Water Resources Research* 48(12), W12504.

# Effects of nitrogen and organic shock loadings on a soil filter treating matured landfill leachate

Yidong Guan<sup>1</sup>, Dongye Zhao<sup>2</sup>, Xiaoru Fu<sup>1</sup>, Haiou Zhang<sup>1</sup>, Yaqian Zhao<sup>3</sup>

<sup>1</sup> Collaborative Innovation Center of Atmospheric Environment and Equipment Technology, School of Environmental Science and Engineering, Nanjing University of Information Science and Technology, Nanjing 210044, China

<sup>2</sup> Department of Civil Engineering, Auburn University, Auburn, AL 36849, USA

<sup>3</sup> Dooge Centre for Water Resources Research, School of Civil Engineering, University College Dublin, Belfield, Dublin 4, Ireland

**Keywords:** Shock loading, Ammonia shock, Nitrification, Landfill leachate, Soil filter, Free ammonia

## Introduction

The study is mainly aimed to elucidate the long-term (over 90 days) performance of a multi-soil-layering (MSL) filter system, in response to the nitrogen and organic shock loadings, especially under the impact of high influent ammonia loadings, ranging from 100 to >1000 mg NL<sup>-1</sup>, which would be helpful to further expand the utilization scope of the soil filter. In addition, this study attempts to quantitatively classify the low-, medium- and high-strength stabilized landfill leachate (LL) based on more objectively and mechanistically sounder LL quality parameters.

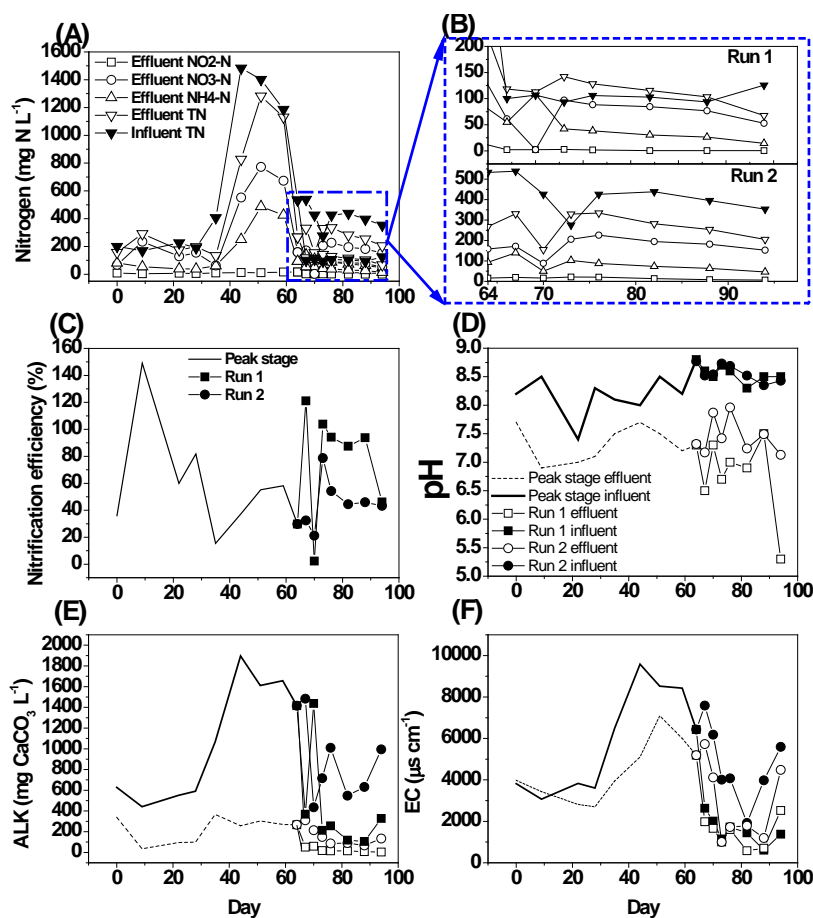
## Material and Methods

Leachate was collected from a 10-year old matured municipal landfill site in Zhejiang Province, China. The LL was then fed into the two MSLs (runs 1 and 2), which were operated with a HLR of 200 L m<sup>-2</sup> d<sup>-1</sup> and a HRT of 31.7 hours for the shock loading trials lasted for 94 days. The trials on the effects of nitrogen and COD shock loadings were divided into three stages: Peak stage: medium- to high-strength LL (days 0–64), Run 1: low- strength LL (days 64–94), and Run 2: medium-strength LL (days 64–94). The average intensity of matured low-, mid-, and high-strength, which was initially classified based on the total nitrogen (TN) level and the corresponding TN, NH<sub>4</sub>-N, and COD values, was calculated as 88, 79, and 264 mg L<sup>-1</sup> for low strength; 352, 316, and 1056 mg L<sup>-1</sup> for mid-strength, and 880, 792, and 2640 mg L<sup>-1</sup>, for high-strength, respectively.

A modified sensitivity index of the reactors has been used to indicate the operating conditions, while the linear regression and one-way analysis of variance (ANOVA) were performed at the 0.05 significance level.

## Results and Discussion

The main results (Fig. 1) showed: (i) the MSL systems could effectively absorb the low-, mid- and high-strength shock loadings (equivalent to 71 HRT) while treating matured landfill leachate. The MSL reactors exhibited a better denitrification capacity while treating the mid- and high-strength LL at 30 and 18 HRT, respectively; (ii) among the sensitivity indices of pH, TN, NH<sub>4</sub>-N and COD, pH was the most sensitive index, while its index value was much larger under low- and mid-strength shocks than that of high-strength shock. The sensitivity index of COD showed a most retarded response under the three stages of exposure conditions; (iii) high levels of free ammonia (0 to 67.2 mg N L<sup>-1</sup>) were associated with the high influent nitrogen shocks and high pH. Yet, high concentrations of free ammonia showed little inhibition on the nitrification process of the MSL systems.



**Fig. 1** Variation of various nitrogen compounds (TN, NH<sub>4</sub>-N, NO<sub>2</sub>-N, and NO<sub>3</sub>-N), nitrification efficiency, pH, ALK and EC evolutions in response to nitrogen shock loadings over time. (A) TN, NH<sub>4</sub>-N, NO<sub>2</sub>-N, and NO<sub>3</sub>-N in the shock loading (Peak Stage); (B) TN, NH<sub>4</sub>-N, NO<sub>2</sub>-N, and NO<sub>3</sub>-N in Runs 1 and 2; (C) nitrification efficiency; (D) pH; (E) ALK (in CaCO<sub>3</sub>); (F) EC. The error bars in Peak Stage are not shown for clarity.

## References

Guan, Y.D., X. Chen, S. Zhang and A.C. Luo, 2012. Performance of multi-soil-layering system (MSL) treating leachate from rural unsanitary landfills. *Science of Total Environment*, 420: 183-190.

# Combination of constructed wetlands and photocatalysis processes for the elimination of persistent organic pollutants from municipal wastewater

O.G. Gonzalo<sup>a</sup>, Z. Marín<sup>b</sup>, M.I. Fernández<sup>b</sup>, J.A. Santaballa<sup>b</sup>, I. Ruiz<sup>a</sup>, E. Torres<sup>c</sup>, M. Canle<sup>b</sup>, M. Soto<sup>a\*</sup>

<sup>a</sup>Environmental and Chemical Engineering Group, <sup>b</sup>Chemical Reactivity & Photoreactivity Group, Dept. of Chemistry, <sup>c</sup>Study and Applications of Microalgae Group, Dpt. of Biology. Faculty of Sciences & CICA. University of A Coruña, E-15071, A Coruña, Galiza, Spain. \*m.soto@udc.gal

**Keywords:** persistent organic pollutants, PPCPs, constructed wetlands, heterogeneous photocatalysis, green chemistry.

## Abstract

This research is part of a project devoted to the study of a combination of constructed wetlands with a post-treatment of heterogeneous photocatalysis, aiming to keep a reduced surface for the wetland and to increase the quality of the effluent, keeping a complete elimination of the presence of persistent pollutants.

Persistent organic pollutants (POPs) include a variety of chemicals that threaten both the environment and living organisms. Among the most relevant, agrochemicals, pharmaceuticals, personal care products (PPCPs), and others can be included. POPs show large differences in bioavailability and bioaccessibility (Dean, 2007), for which attention should be paid to methods for their abatement and / or degradation. Some of the POPs under study in this project are herbicides: atrazine and analogous; fungicides: imazalil; anti-pyretics: paracetamol; anti-inflammatories: ibuprofen, diclofenac, ketoprofen; anxiolytics: carbamazepine; Antihistamines: diphenhydramine; beta-blockers: propranolol; among others.

Conventional wastewater treatment plants (WWTPs) are not economically feasible for sanitation of sparsely populated areas. Consequently, cost-effective decentralized and/or individual household treatment solutions are typically preferred, such as constructed wetlands (CWs), which are receiving increasing attention due to their ability to remove a large variety of pollutants, including PPCPs (Verlicchi and Zambello, 2014). Their behaviour has been evaluated in pilot horizontal subsurface flow (SSF), vertical flow, and surface flow (SF) CWs because they constitute a cost-effective decentralized and/or individual household treatment solution. Although the removal efficiency of PPCPs in CWs is usually high, some POPs are poorly removed, and hybrid systems consisting of different configurations of multistep wetlands and/or ponds perform better than individual systems.

PPCPs removal from urban wastewater have been studied in a hybrid pilot plant consisting of an up-flow anaerobic sludge blanket reactor (UASB), followed by two sequentially horizontal flow constructed wetlands: a surface flow wetland (SF CW) and a subsurface flow wetland (SSF CW). The efficiency of the different treatment steps was compound-dependent, but the SF CW generally exhibited the highest removal efficiency for most contaminants. Photochemical degradation mechanisms are present in SF CWs and thus in some types of hybrid CWs. However, in order to maintain and strengthen this mechanism and reduce the footprint and complexity of hybrid systems, we propose the combination of VF and SSF CWs with an ultraviolet photocatalysis post-treatment unit. The use of TiO<sub>2</sub> as photocatalyst is one of the most promising advanced-oxidation processes, due to its low toxicity, chemical stability and capacity to produce highly oxidant species by UV-Vis light absorption, including



sunlight (Martinez et al., 2013). Nowadays, these processes can be improved by using irradiation systems capable of reducing energetic consumption, such as UV-LEDs.

A compact two-step CW system consisting of a SSF unit and a VF unit with effluent recirculation, followed by an UV FC unit is being tested at lab-scale. The recirculating SSF-VF system was selected because of its excellent performance in achieving total nitrogen removal (Torrijos et al., 2016). These units provide the aerobic and anaerobic conditions required for advanced nitrogen removal, but also for the removal of most PPCPs. On the other hand, the UV FV unit provides photocatalysis mechanisms in order to complete PPCPs and pathogen removal. Removal efficiency relative to suspended solids, organic matter, nutrients, PPCPs, pathogen agents and ecotoxicity (algae testing) is being assessed.

**Acknowledgments.** The authors acknowledge financial support by the Spanish *Ministerio de Economía y Competitividad* (MinEco) and FEDER through project CTQ2015-71238-R.

### References.

Dean, J., 2007. Bioavailability, Bioaccessibility and Mobility of Environmental Contaminants. John Wiley & Sons, Chichester, UK.

Martinez, C.; Canle L, M.; Fernandez, M. I.; Santaballa, J. A.; Faria, 2013. Kinetics and mechanism of aqueous degradation of carbamazepine by heterogeneous photocatalysis using nanocrystalline TiO<sub>2</sub>, ZnO and multi-walled carbon nanotubes–anatase composites. *J. Applied Catalysis B-Environmental* 102, 563-571.

Reyes-Contreras, C., Matamoros, V., Ruiz, I., Soto, M., Bayona, J.M., 2011. Evaluation of PPCPs removal in a combined anaerobic digester-constructed wetland pilot plant treating urban wastewater. *Chemosphere* 84, 1200-1207.

Torrijos, V., Gonzalo, O.G., Trueba-Santiso, A., Ruiz, I., Soto, M., 2016. Effect of bypass and effluent recirculation on nitrogen removal in hybrid constructed wetlands for domestic and industrial wastewater treatment. *Water Res.* 103, 92-100.

Verlicchi, P., Zambello, E., 2014. How efficient are constructed wetland in removing pharmaceuticals from untreated and treated urban wastewaters? A review. *Science of The Total Environment*, 470–471, 1281-1306.

# Constructed wetlands planted with willow for domestic wastewater treatment under cold climate

Zhanna Grebenshchykova, Jacques Brisson, Florent Chazarenc, Yves Comeau

## Introduction

Treatment wetlands (TWs) represent an alternative popular extensive process to treat municipal wastewater in small communities. One of the most widespread TWs in Europe is the French vertical unsaturated flow (VF) planted with *Phragmites australis australis* with more than 4000 systems in operation. This type of design naturally allows the good oxygen transfer needed for a treatment to the deep layers. Despite its good treatment performances this system has never been developed in North America mostly because the operation in winter is difficult in very cold temperature and because *Phragmites australis australis* are considered as invasive species (Kadlec and Wallace, 2009).

The saturated mode of operation can be the solution to protect the TW from freezing. This type of flow must be applied with forced aeration (Wallace et al., 2001; Ouellet-Plamondon et al., 2006) to bring the oxygen. Willow sp. present a special interest for this type of TW in North America because of the fast biomass development with an important evapotranspiration capacity. Moreover, this species has an important rhizome that participates to the oxygen transfer and to the nutrient uptake (Kuzovkina and Quigley, 2005). A pilot-scale experiment is needed to approve previous optimizations.

The aim of this study was (i) to evaluate the performances of willows (*Salix miyabeana* SX67) TW instead of *Phragmites australis australis* into the VF system (ii) to develop an operating mode adapted to harsh winter conditions by using saturated flow coupled with forced aeration (iii) to compare percolated and saturated flow mode during the winter.

## Material and Methods

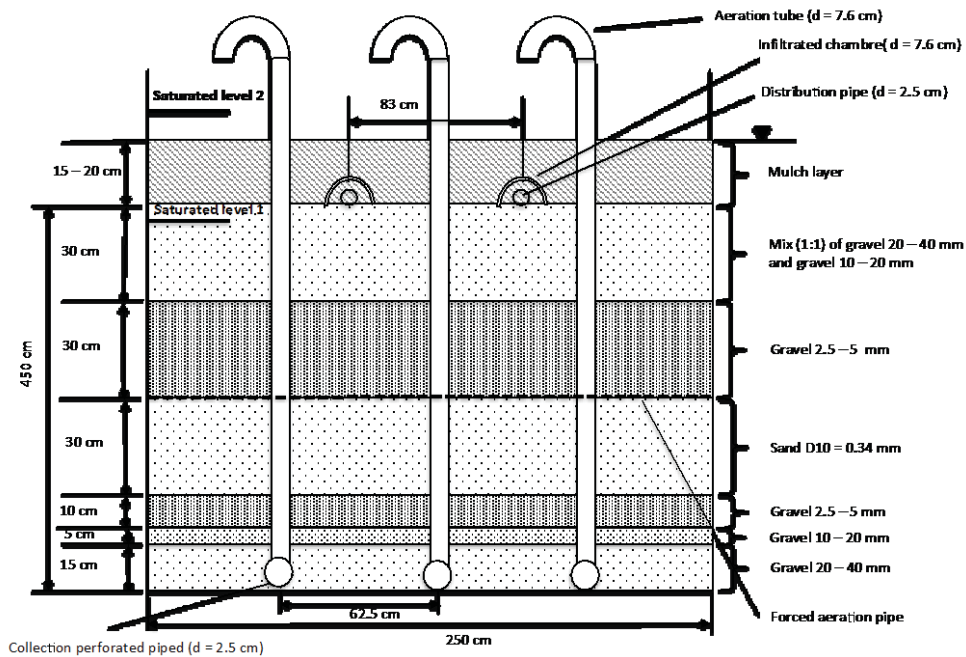
Four pilot-scale units of single stage VF TW were implemented inside the wastewater treatment plant of the village of Saint-Roch-de-l'Achigan (5000 hab.) in Quebec, Canada. The climate in this region is semi-continental with the mean monthly temperatures reaches a minimum of -10.8°C in January and a maximum of 21.3°C in July (Environnement Canada, climate normal 1981-2010).

Each unit having surface of 1.3 m<sup>2</sup> (4.5 m x 2.5 m) contains 1.2 m of different type of media (Fig. 1) and was planted using 45 plants of willow (*Salix miyabeana* SX67). A soil moisture and temperature sensors were installed in different layers of each unit of TW (Fig.1). A weather station was implemented near the TW system.

The filters were fed with primary settled domestic wastewater effluent from July 2016 to September 2017. Two organic loadings, representing 5 and 10 m<sup>2</sup>/PE were tested. The saturated operation mode including forced aeration was applied for two filters during four months of winter.

Inflow and outflow samples were collected twice a month. Monitoring included the following pollutants as chemical oxygen demand (COD); total suspended solids (TSS); total Kjeldahl nitrogen (TKN) – ammonia (NH<sub>4</sub>) – nitrogen (NO<sub>3</sub>); total phosphorus (TP) – orthophosphate (PO<sub>4</sub>) were made according to Standard Methods (APHA, 1998). Furthermore, some others physico-chemical analyses were made (turbidity, pH, electro-conductivity, calcium, magnesium, potassium, sodium, chloride, sulfate).

Plant morphological traits development (Stem length, Nitrogen foliar content, Phosphorus foliar content) were analysed.



**Fig. 1 – Cross-section of the VF TW, with the detailed granular size of each filtration layer**

## Results and Discussion

The main results from August 2016 to January 2017 showed:

- (i) The COD removal was from 82% to 96%. The TSS removal was from 74% to 100%. Removal efficiency was not affected by the concentration variations of primary effluent.
- (ii) The Phosphorus removal was from 52% to 94% with reduction of efficiency during the experiment.
- (iii) The Nitrogen removal was from 87% to 98%.
- (iv) No significant difference for COD, TSS, Phosphorus and Nitrogen removal efficiency between units.

## References

- ALPHA, 1998. Standard Methods for the Examination of Water and Wastewater, twentieth ed. American Public Health Association, Washington, DC, USA.
- Chazarenc, F., Gagnon, V., Comeau, Y., Brisson, J. (2009) Effect of plant and artificial aeration on solids accumulation and biological activities in constructed wetlands. *Ecol. Eng.* 35(6), 1005-1010.
- Environment Canada, climate normals, 1981 – 2010. National Data and Information Archive Website. [www.climate.weather.gc.ca/climate\\_normals/index\\_e.html](http://www.climate.weather.gc.ca/climate_normals/index_e.html)
- Kadlec, R.H., Wallace, S.D. (2009) *Treatment Wetlands*. 2<sup>nd</sup> ed. CRC Press, Boca Raton, FL.
- Kuzovkina, Y.A., Quigley, M.F. (2005) Willows beyond wetlands: Uses of *Salix L.* species for environmental projects. *Water Air & Soil Pollut.* 162(1-4), 183-204.
- Ouellet-Plamondon, Claudiane, et al. "Artificial aeration to increase pollutant removal efficiency of constructed wetlands in cold climate." *Ecological Engineering* 27.3 (2006): 258-264.
- Wallace, S., G. Parkin, and C. Cross. Cold climate wetlands: design and performance. *Water Science and Technology* 44.11-12 (2001): 259-265.

# Efficiency of a short rotation willow coppice for the treatment of municipal wastewater under a North American humid continental climate

Lachapelle-T., X.<sup>1</sup>, Labrecque, M.<sup>2</sup>, Comeau, Y.<sup>1</sup>

<sup>1</sup>Department of Civil, Geological and Mining Engineering, Polytechnique Montréal, Montréal, Québec, H3C 3A7 Canada

<sup>2</sup>Institut de Recherche en Biologie Végétale, 4101 Sherbrooke Est, Montréal, Québec, H1X 2B2 Canada

**Keywords:** willow; short rotation coppice; land irrigation; municipal wastewater; treatment

## Introduction

The objective of this study was to evaluate the treatment efficiency of a short rotation willow coppice for the treatment of wastewater from a municipal primary effluent in a humid continental climatic context. The research was carried out at pilot scale in the summer of 2016 on a two-hectare willow (*Salix miyabeana* SX67) experimental plantation located near the municipal wastewater treatment plant of Saint-Roch-de-l'Achigan, Quebec, Canada.

A number of small urban and northern Canadian communities fail to effectively treat their wastewater due to lack of funds, skilled personnel or maintenance experts (Joy et al. 2003). In response to this issue there is a need to continue to develop extensive wastewater treatment systems that require low construction and operating costs. Using short rotation coppice for the treatment of wastewater represent a potential solution to this problem. These filters can remove organic matter and nutrients from wastewater (Miguel et al., 2014), in addition to making possible the valorization of a woody biomass (Guidi et al., 2013). The use of certain willow cultivars with a high evapotranspiration potential can also considerably reduce the soil infiltration flowrate (Nissim et al., 2014).

## Materials and Methods

Nine experimental plots of 100 m<sup>2</sup> (10 m x 10 m) were delineated within an existing experimental willow plantation. Two loadings of primary effluent (D1, 1 cm/d and D2, 1.5 cm/d) and one loading of potable water (PW; 1 cm/d) serving as a nutrient-poor control were used to irrigate the nine plots (3 plots per dose) for 115 days. A total of 27 suction cup lysimeters (3 per plots) installed at a depth of 60 cm and five observation wells were used to monitor vadose zone and groundwater quality (COD, NH<sub>4</sub>, NO<sub>x</sub>, TKN TP, o-PO<sub>4</sub>), respectively. Willows evapotranspiration was modelled for the duration of the experiment using the Penman-Monteith equation and crop coefficients associated with the *Salix* genus. Mass balances of the monitoring parameters were carried out using this evapotranspiration data.

## Results and Discussion

Efficient removal of COD and o-PO<sub>4</sub> (96% and 99% loading removal, respectively) was observed for all plots irrigated with D1 and D2. The low average concentration of o-PO<sub>4</sub> (< 0.1 mg P/L) measured from these plots is probably due to the adsorption of phosphorus near the soil surface above the sampling point of the lysimeters. Phosphorus soil saturation rate should certainly be taken into account in determining the lifetime of irrigation sites. Total nitrogen loading removal efficiencies of 94% and 96% were observed for D1 and D2, respectively. High concentrations of nitrate, however, were measured during the experiment during dry weather periods (Figure 1). The concentration effect that results from dry weather conditions, a high evapotranspiration rate and a decrease in soil denitrification during periods of lower soil moisture can explain these higher concentrations. Modulation of irrigation flow according to the evapotranspiration rate that are highest between July and September, could allow to avoid high groundwater nitrate concentration during dry weather periods. This would also allow to maximize the amount of water irrigated, reducing the required volume for a winter wastewater storage basin.

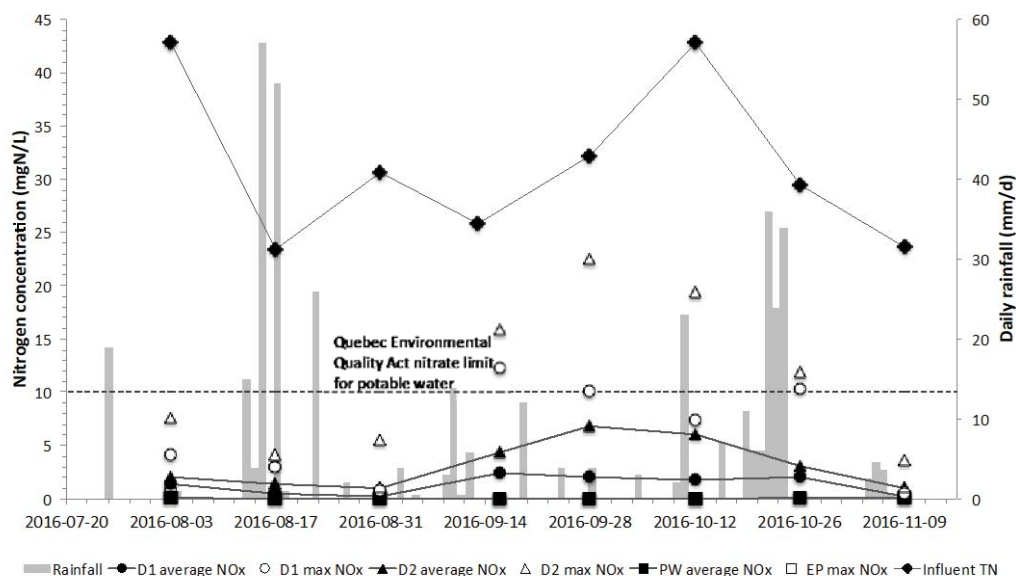


Figure 1. Influent total nitrogen, rainfall and nitrate in lysimeters

## References

- Guidi, W., Pitre, F. E., & Labrecque, M. (2013). Short-rotation coppice of willows for the production of biomass in eastern Canada. *Biomass Now—Sustainable Growth and Use*, 421–448.
- Joy, D., Kingsley, C., Schaefer, K., Pileggi, V., Skog, S., Kok, S. (2003) *Traitement des eaux usées dans les petites collectivités*. Conseil canadien des ministres de l'environnement (CCME), Winnipeg, MA. Série des ateliers du CCME sur les sciences de l'eau et les politiques, Compte rendu no. 4, 18p.
- Miguel, A. de, Meffe, R., Leal, M., González-Naranjo, V., Martínez-Hernández, V., Lillo, J., ... Bustamante, I. de. (2014). Treating municipal wastewater through a vegetation filter with a short-rotation poplar species. *Ecological Engineering*, 73, 560–568.
- Nissim, W. G., Voicu, A., & Labrecque, M. (2014). Willow short-rotation coppice for treatment of polluted groundwater. *Ecological Engineering*, 62, 102–114.

# Domestic wastewater treatment by using a two stages subsurface vertical flow constructed wetland: removal efficiency.

Ref # S2SMALL-99709

Segura, I.<sup>1\*</sup>, Vázquez, V.<sup>1</sup>

<sup>1</sup>Mexican Institute of Water Technology, Paseo Cuauhnáhuac 8532 Progreso, Jiutepec, Morelos, México.

\* Presenting Author: [irleth\\_segura@tlaloc.imta](mailto:irleth_segura@tlaloc.imta).

**Abstract:** Constructed wetlands are a sustainable way for the treatment and reuse wastewater; this is because of their contaminant's high removal efficiency, easy construction, low cost of operation and maintenance compared with conventional systems for wastewater treatment. Constructed wetlands have been classified according to their flow in surface flow constructed wetlands and subsurface flow constructed wetlands; these last are classified in vertical and horizontal due to the water flow inside the system. The vertical constructed wetlands can work with a superior organic mass than horizontal constructed wetlands in a less area with the same flow to treat. This research has been focus on determine the removal of Biochemical Oxygen Demand and fecal coliforms from a domestic wastewater by using a two stages subsurface vertical flow constructed wetland which is planted with *Scirpus ssp* (tule); and its's fluctuation stability in the input concentration, obtaining as a result a global removal of fecal coliforms of 99.99% (4.81 logarithmic units), a Biochemical Oxygen Demand removal of 94.46% and a constant removal even when it was a variation in the input concentration of these contaminants.

**Keywords:** constructed wetland, domestic wastewater, fecal coliforms, organic mass.

## INTRODUCTION

Constructed wetlands (CW) has been defined as engineering systems, designed and constructed to use the natural functions of the wetlands, vegetation, ground and microbial population for the wastewater treatment, where each one of these functions occur in a more controlled and efficient way (Karathasis *et al.* 2003, Vymazal 2010, Brix *et al.* 2005). Their use has been principally focus on wastewater treatment and its's reuse in developing cities, in which the poor soil conditions predominate, high phreatic level, prohibition of the discharge of waste water in areas of adsorption; As well as cities that do not have sufficient resources to implement costly technologies (Vacca *et al.* 2005, Karathanasis *et al.* 2003, Gopal, 1999). In this last point the use of a CW is a high viable alternative due to the Low energy and maintenance costs compared to conventional technologies; also with zero environmental impact and low waste production (Wang *et al.* 2013, Ávila, 2014).

The importance and significance of these systems is that they are more economical and provide benefits from reuse, since they are very efficient in the removal of organic matter, suspended solids, metals, excess nutrients (e.g. nitrogen, phosphorus, etc.) and pathogenic organisms (Jin *et al.* 2001, Wang *et al.* 2013, Garcia *et al.* 2008). Additionally the CW has presented economic and operational advantages during operation.

The removal of contaminants is done by mechanisms that have place between the vegetation, ground and microorganisms (Khatiwada *et al.* 1999).

On the other hand, the CW have been classified in wetlands of surface flow (SFCW) and subsurface (SSFCW), these last are classified according to the movement of water in horizontal (SSHFCW) and vertical (SSVFCW). The SSVFCW can operate with loads



exceeding the s SSHFCW, occupying less space to treat the same flow rate which represents an advantage over others (Garcia *et al.* 2008).

The aim of this was focus on determining the Biochemical Demand of Oxygen (BOD<sub>5</sub>) and a residual water fecal coliform removal household type by means of a two-stage SSVFCW which is planted with vegetation type *Scirpus spp* (tule); and its stability in terms of fluctuations in the input concentration.

## MATERIALS AND METHODS

### Constructed wetland description

This study has been made in 8.5 weeks in an experimental physical model of a two-stage SSVFCW in the Mexican Institute of Water Technology (IMTA), it has an effective total area for treatment of 5 m<sup>2</sup> (2.5 m<sup>2</sup> each stage) and a time of hydraulic retention (THR) of 7 days in the system (Table 1). The bed is divided in 3 layers of stone material with a height of 30, 20 and 20 cm (ascending), and material diameters of 20, 5 and 2 mm respectively (García *et al.* 2008). The vegetation in this system was planted with *Scirpus spp.* (tule).

**Table 1.** Dimensions of the stage.

Dimensions (m)	
Lenght	2.79
Width	0.90
Deep	0.70

The two cells that forms the system has a network of polyvinylchloride (PVC) piping for the distribution of the residual water and a PVC pipe grooved to the bottom of the wetland for the collection of water (Table 2). The wetland is located under a roof of polycarbonate in order to avoid influence of variables by precipitation.

**Table 2.** Characteristics of distribution and collection pipes.

Characteristic	Distribution system	Collection system
Kind of pipe	PVC	PVC
Pipe diameter	2"	2"
Number of rows	3	1
Type of perforation	holes	grooves
Number of perforations	27	7
Length of perforation	-	0.05 m
Thickness of each perforation	0.003 m	0.003 m

In addition, the system has 3 PVC pipes 2" diameter for the aeration of the substrate in each one of the cells. These tubes are 0.003 m thick grooves to effect the transfer of oxygen to the inside of the system (Figure 1).



**Figure 1.** Distribution systems and aeration pipes.

### Operation

The system was powered with domestic wastewater entering the treatment plant of the IMTA, which comes mainly from the health services of the different buildings of the institute, dining room and laboratories. Residual water has a BOD<sub>5</sub> average of 142 mg/L and  $1.8 \times 10^4$  MPN/100 mL fecal coliform (FC); this is powered by 2 pulses per day (75 L each pulse) which are controlled through a system of valves that operate manually.

### Efficiency of the constructed wetland

The FC during the experimentation of our work was determined by the method of simultaneous determination of total and fecal coliform using the technique of substrate chromogenic specific (Colilert) (Figure 2), while to the BOD<sub>5</sub> was determined by the norm NMX-AA-028-SCFI-200. Known values proceeded to determine the efficiency of removal of these parameters in the two stages and was subsequently performed a linear regression with previously transformed data [ $\log(x+1)$ ] to determine the stability of the system by fluctuations of the load of pollutants.



**Figure 2.** Technique of substrate chromogenic specific.

## **RESULTS AND DISCUSSIONS**

The presence and removal of BOD<sub>5</sub> and FC are monitoring for 8.5 weeks after the stabilization of the system. No significant differences in the number of FC with respect to different sampling points, registering a gradual reduction in the point of sampling next to the output were. The system showed an efficient removal of FC 99.99% (4.81 logarithmic units) and BOD<sub>5</sub> a 94.46% (Table 3). These results coincide with those reported by Arias *et al.* (2003) in has two stages, which recorded a removal of indicator bacteria between 99.5 -

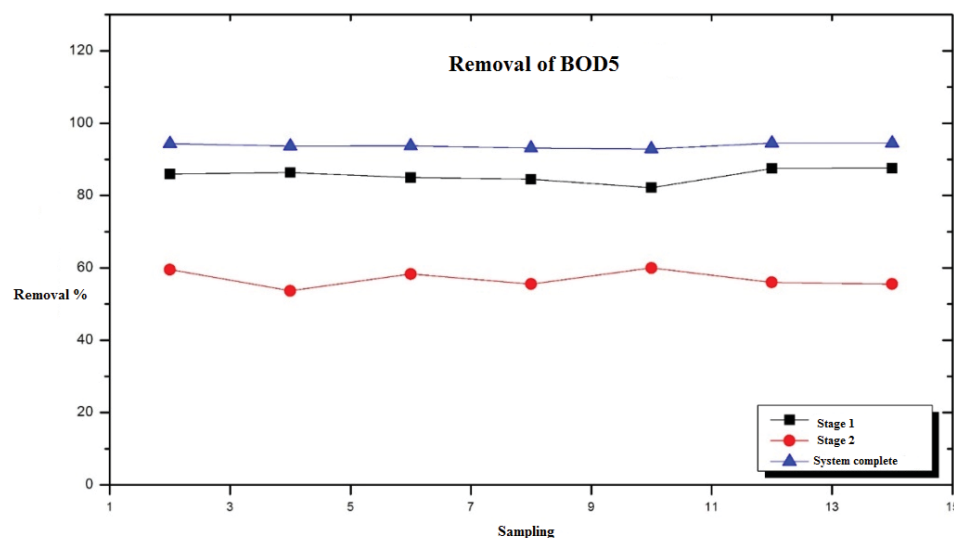
99.9%, and by Li *et al.* (2012) in its work related to sand filters, which recorded values of removal of FC of 99.9%.

Contrary to the proceeds by Song *et al.* (2006) who reported percentages less removal than those obtained in our study, since they recorded a removal of FC of 99.6%.

**Table 3.** Removal of FC and BOD<sub>5</sub> for stage.

Parameter	Stage 1			Stage 2			System complete
	Inlet flow	Flow rate	Removal (%)	Inlet flow	Flow rate	Removal (%)	Removal (%)
FC (NMP/100 mL)	$1.50 \times 10^6$	$2.12 \times 10^2$	99.94	$2.12 \times 10^2$	$9.38 \times 10^0$	94.75	99.99
BOD <sub>5</sub> (mg/l)	151.3	19.65	86.58	19.65	8.1	58.72	94.46

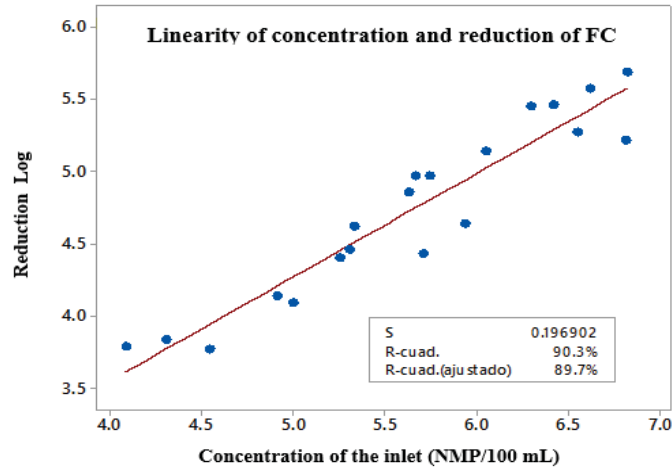
On the other hand, regarding the BOD<sub>5</sub> results are similar to those obtained in this work (94.46%) (Figure 3), for example Langergraber *et al.* (2014) obtained a percentage of 95% in vertical wetlands in two stages and Jong *et al.* (2016) obtained values of 92-96%.



**Figure 3.** Removal of BOD<sub>5</sub>.

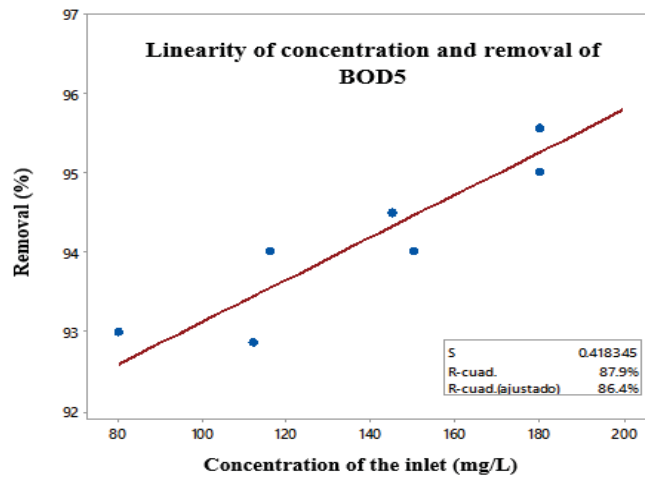
During the operation of the SSVFCW were presented different concentrations of FC, which ranged from  $3.38 \times 10^5$  -  $3.89 \times 10^7$  MPN/100 mL and BOD<sub>5</sub> of 150 - 250 mg/L; however the system was kept in an average percentage of removal from the order of 99.99% for FC and a 94.46% for the BOD<sub>5</sub>. These results corroborate cited by several authors (Kadlec *et al.* 2008, Garcia *et al.* 2008, Molleda 2011) that assume that the CW are able to withstand fluctuations in loading of contaminants.

To corroborate this information a linear regression was made in which you can see that the data between the concentration of FC and reduction of logarithmic units follow a pattern similar to the linear with a value ( $R^2$ ) close to 1 (0.90), which indicates that there is a high correlation coefficient between the concentration of input and the reduction of FC log units throughout the system (Figure 4); This data is similar to that obtained by Molleda (2011), whose correlation coefficient  $R^2 = 0.99$ , was between the burden of FC and its rate of removal in a SSVFCW of urban and livestock waste water treatment with high concentrations of pathogens.



**Figure 4.** Linearity of concentration and reduction of FC.

On the other hand, the results obtained regarding the BOD<sub>5</sub>, shows a linearity with a coefficient of  $R^2 = 0.87$  (Figure 5), is not ideal but it is an acceptable result; being this coefficient less than introducing Molleda (2011), between the load to the wetland and its elimination rate ( $R^2 = 0.98$ ).



**Figure 5.** Linearity of concentration and removal of BOD<sub>5</sub>.

## CONCLUSIONS

Indicator bacteria (FC) are effectively reduced by a SSVFCW reaching removals of 99.99%, i.e. in the order of 4.8 logarithmic units (MPN/100 mL); and regarding the BOD<sub>5</sub> removal average of 94.46% values are reached. These results are lower than those recorded in similar wetlands of horizontal type with HRT.

The system is not destabilized in terms of FC and BOD<sub>5</sub> removal by fluctuations in concentration of input, which corroborates that this type of wetlands can withstand pollutants concentration peaks without affecting its efficiency.

The removal of indicator bacteria and BOD<sub>5</sub> in this paper was conducted mainly in stage 1, so it is recommended to do a deeper analysis in terms of the size of such systems.

Organic loading rates analyzed in the present work are low compared with rates that use systems on a large scale, so it is still studying whether the concentration of output reaches similar values of clearance when the organic rate increases.

## REFERENCES

- i. Arias C.A., Cabello A., Brix H., Johansen N.H. 2003. Removal of indicator bacteria from municipal wastewater in an experimental two-stage vertical flow constructed wetland system. *Wat. Sci. Tech.*, **48**(5), 35-41.
- ii. Ávila S., Estupiñan S., Mejia A. y Mora L. 2014. La calidad bacteriológica del agua del humedal Jaboque (Bogotá, Colombia) en dos épocas contrastantes. *Caldasia*, **36**(2), 323-329. DOI: 10.15446/caldasia.v36n2.47490.
- iii. Brix H. and Arias C. 2005. Danish Guidelines for small-scale constructed wetlands systems for onsite treatment of domestic sewage. *Water Sci. Tech.*, **51**(9), 1-9.
- iv. García J. and Corzo A., 2008. *Depuración con Humedales Construidos*. Departamento de Ingeniería Hidráulica, Marítima y Ambiental de la Universidad Politécnica de Catalunya, Barcelona, España.
- v. Gopal B. 1999. Natural and constructed wetlands for wastewater treatment: potentials and problems. *Water Sci. Tech*, **40**(3), 27-35. DOI: 10.1016/S0273-1223(99)00468-0.
- vi. Jin S., Lin Y., Lee D. and Wang T. 2001. Using constructed wetland systems to remove solids from highly polluted river water. *Wat. Sci. Tech: Water Supply*, **1**(1), 89-96.
- vii. Karathanasis A., Potter C. and Coyne M. 2003. Vegetation effects bacteria, BOD, and suspended solid removal in constructed wetlands treating domestic wastewater. *Ecological Engineering*, **20**(2) 157-16. DOI: 10.1016/S0925-8574(03)00011-9.
- viii. Kadlec R. and Wallace S. 2008. *Treatment wetlands (2da Ed.)*. United States of America: Taylor y Francis Group.
- ix. Khatiwada N., Polprasert C. 1999. Kinetics of fecal coliform removal in constructed wetlands, *Water Sci. Tech*, **40**(3), 109–116. DOI: 10.1016/S0273-1223(99)00446-1.
- x. Langergraber G., Pressi A. and Haberl R. 2014. Experiences from the full-scale implementation of a new two-stage vertical flow constructed wetland desing. *Wat. Sci. Tech.*, **69**(2), 335-342. DOI: 10.2166/wst.2013.708.
- xi. Li Y., Yu J., Lui Z. and M. T. 2012. Estimation and modeling of direct rapid sand filtration for total fecal coliform removal from secondary clarifier effluents. *Wat. Sci. Tech*, **65** (9), 1615-1623. DOI: 10.2166/wst.2012.054.
- xii. Molleda M. P. 2011. Aplicación de humedales construidos en la reducción de patógenos y otros contaminantes en agua residual urbana y ganadera. Tesis, Universidad de Leon, pp.150.
- xiii. Song Z. W., Zheng Z.P. and Li J. 2006. Seasonal and annual performance of a full-scale constructed wetlands system for sewage treatment in China. *Ecol. Eng.* **26**(3), 272–282. DOI: 10.1016/j.ecoleng.2005.10.008.
- xiv. Vacca G., Wand H., Nikolausz M.Kuschk P. and Kastner M. 2005. Effect of plants and filter materials on bacteria removal in pilot-scale constructed wetlands. *Water Research*, **39**(7), 1361-1373. DOI: 10.1016/j.watres.2005.01.005.
- xv. Vymazal J. 2010. Constructed wetlands for wastewater treatment. *Water*, **2**(3), 530-549. DOI: 10.3390/w2030530.
- xvi. Wang H., Jiang D., Yang Y. and Cao G. 2013. Analysis of chemical reaction kinetics of depredeating organic pollutants from secondary effluent of wastewater treatment plant in constructed wetlands. *Wat. Sci. Tech.*, **67**(2), 353-358. DOI: 10.2166/wst.2012.521.

**Parallel session 4 - Treatment wetlands 2**

**14:00-15:20**

Session chair: Thomas Aubron

**588 - Onsite one stage constructed wetland fed by raw wastewater: performances and resilience of the system**  
DUBOIS Vivien - *Irstea*

**296 - The new draft German constructed wetland guideline for treatment of domestic and municipal wastewater**

RUSTIGE Heribert - *AKUT Umweltschutz Ingenieure Burkard und Partner*

**496 - On-site wastewater treatment in France: statistical analysis of the outlet effluent quality of 240 facilities**  
OLIVIER Laurie - *Irstea*

**439 - Green Bio-sorption Reactor: Making wastewater treatment plant an attractive scenario**  
ZHAO Yaqian - *Xi'an University of Technology*

**Parallel session 5 - Treatment wetlands 3**

**15:40-17:00**

Session chair: Mathieu Gautier

**690 - Nkolfoulou landfill leachate treatment performances in VFCWs planted with *Echinochloa Pyramidalis* during dry season**

FENDOUNG Guy - *IMT Atlantique*

**689 - Design parameters influence on pollution removal performance of full-scale constructed-wetlands treatments plants for domestic wastewater**

RODRIGUEZ VASQUEZ Sebastian - *IMT Atlantique*

**641 - Electroactive Biofilm-based Constructed Wetland (EABB-CW): Testing of an innovative setup for wastewater treatment**

ARIAS Carlos - *Aarhus University*

**498 - Nutrients removals in vertical flow constructed wetlands combined or not with biological and/or chemical treatment processes**

KIM Boram - *INSA Lyon, DEEP laboratory*

**Parallel session 6 - Treatment Wetland 4**

**17:20-18:20**

Session chair: Tjaša Griessler Bulc

**443 - The key factors of building a microbial fuel cell in a pilot-scale constructed treatment wetland**

TANG Cheng - *Chang'an University*

**631 - Peat as substrate for small-scale constructed wetlands polishing secondary effluents**

CHAMPAGNE Pascale - *Queen's University, Department of Civil Engineering*

**688 - The effect of nitrification-denitrification process in one single stage Vertical Flow Constructed Wetlands (VFCW) treating domestic wastewater**

RUIZ Hernan - *Institute Mines Telecom Atlantique*



# Onsite one stage constructed wetland fed by raw wastewater: performances and resilience of the system.

Ref # S2SMALL-83775

V. Dubois<sup>1</sup> and P. Molle<sup>1</sup>.

<sup>1</sup> Irstea, Freshwater Systems, Ecology and Pollutions Research Unit, 5 rue de la Doua, BP 32108, 69616 Villeurbanne, France

\* Presenting Author: [vivien.dubois@irstea.fr](mailto:vivien.dubois@irstea.fr)

**Keywords:** onsite sanitation, constructed wetlands, performances robustness.

## INTRODUCTION

Onsite sanitation systems in Europe are evaluated through a EU labeled procedure done on a platform test under a specific schedule of loads (EN 12566). Nevertheless this test procedure conditions does not represent the real conditions of treatment systems in term of wastewater characteristics and loads. On another angle, in France, systems implemented for capacities above 20 p.e. do not need EU labeled procedure but have to comply with performances requirements. For constructed wetlands, it leads to a situation where design for 21 p.e. can be more compact than for 15 p.e.. Some companies have fulfil EU labeled procedure for one stage vertical flow constructed design between 1.2 and 2 m<sup>2</sup> per habitant to implement more compact system. This study aims at evaluating, under real conditions the behaviour of a one stage unsaturated/saturated vertical flow constructed wetlands (as designed for small communities, Pringent et al., 2013; Silveira et al., 2015) and fed by raw wastewater (no septic tank). The objectives were to evaluate performances, robustness and resilience of the system when facing load variations.

## MATERIAL AND METHODS

The monitoring have been conducted on a unsaturated/saturated vertical flow constructed wetland treating the wastewater from 6 habitants family in the south of France (Crest, Drôme department). The system consists in:

- A pumping station receiving all wastewaters from the house (no screening) and delivering batches to the treatment system. The batch feeding flow is of 3 m<sup>3</sup>/h for an average batch volume of 80 liters.
- A unsaturated/saturated vertical flow constructed wetlands divided in two filters in parallel to implement feeding and resting periods (one week/one week). The filters comprises a 70 cm of 2/6 mm crushed and washed gravel (unsaturated layer), an aeration pipe and a saturation layer composed of pea gravel (20/40 mm). The saturation layer has been tested between 22 and 40 cm of depth. Each filter has a surface of 7 m<sup>2</sup>.

Treated wastewaters are infiltrated into the ground in winter and reused for brush irrigation the rest of the year.

The monitoring, over one year and half, started after 3 years of operation and consisted in:

- Counting the number of people present in the house for the night, the lunch and the dinner, every days.
- Measuring the daily flow by a pressure probe (STS) in the pumping station measuring on a one minute time step
- Performing 24 h flow proportional samples at the inlet/outlet of the system to analyse global parameters (COD, dissolved COD, TOC, DOC, TSS, BOD<sub>5</sub>, KN, N-NH<sub>4</sub>, N-NO<sub>2</sub>, N-NO<sub>3</sub>, P-PO<sub>4</sub>, TP). 31 campaigns have been done in different seasons.
- For some campaigns outlet online measurement of N-NO<sub>3</sub>/N-NH<sub>4</sub> have been done (WTW Varion).

## RESULTS AND DISCUSSION

### Characterization of habitant pollutant production

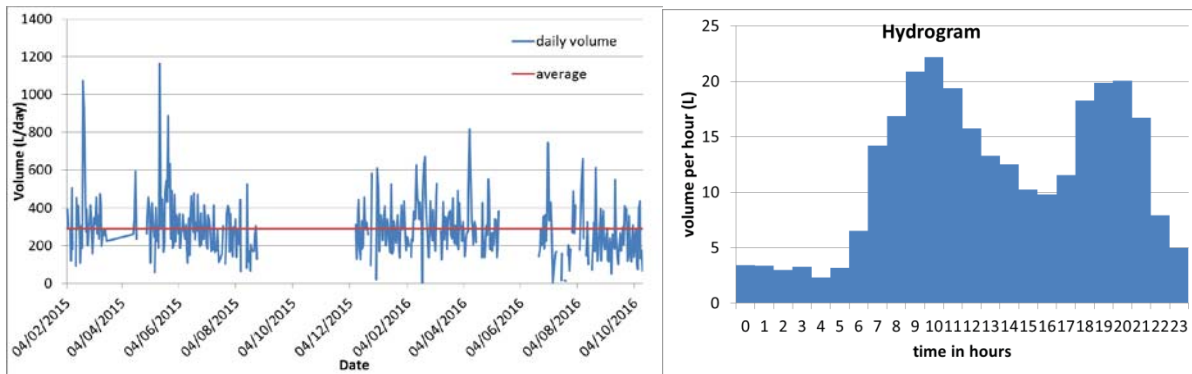
Wastewater characteristics observed on the site reveals that concentrations are much higher than the one usually used in EU labeled tests (see Table 1).

**Table 1: Wastewater characteristics**

	Volume (L)	COD (mg/l)	dCOD (mg/l)	TSS (mg/l)	BOD <sub>5</sub> (mg/l)	KN (mg/l)	N-NH <sub>4</sub> (mg/l)	TP (mg/l)
average	521	1853	467	1032	767	209	152	29
median	347	1780	470	1065	784	207	148	29
min	67 (150)*	358 (300)*	53	213 (200)*	530 (150)*	29 (25)*	16.8 (22)*	5.5 (5)*
max	4397 (150)*	2750 (1000)*	708	1590 (700)*	1100 (500)*	330 (100)*	252 (80)*	43.6 (20)*

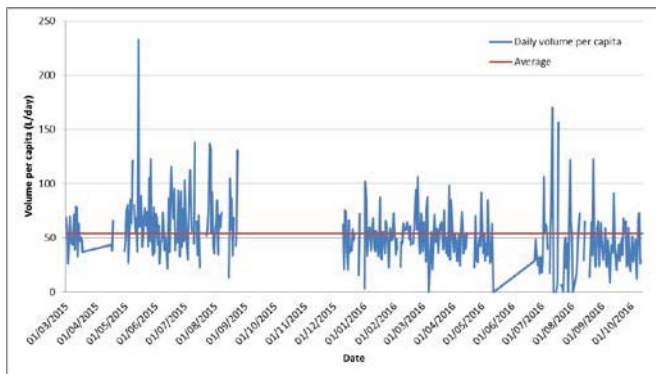
(XX)\*: Reference values for EU labeled tests

The hydraulic load received varies significantly with some huge loads (maximum of 4.4 m<sup>3</sup>/d representing a hydraulic load on the filter in operation of 63 cm/d) for very special events. Excepting the specials events, the daily volume production and classical variation within a day can be seen on Figure 1.



**Figure 1.** daily hydraulic load (left) and average hydraulic load distribution during the day (right)

The average daily flow volume is of 290 liters per day. When comparing to human presence in the house each day, the generated daily volume per capita is of 54 liters in average (Figure 2).



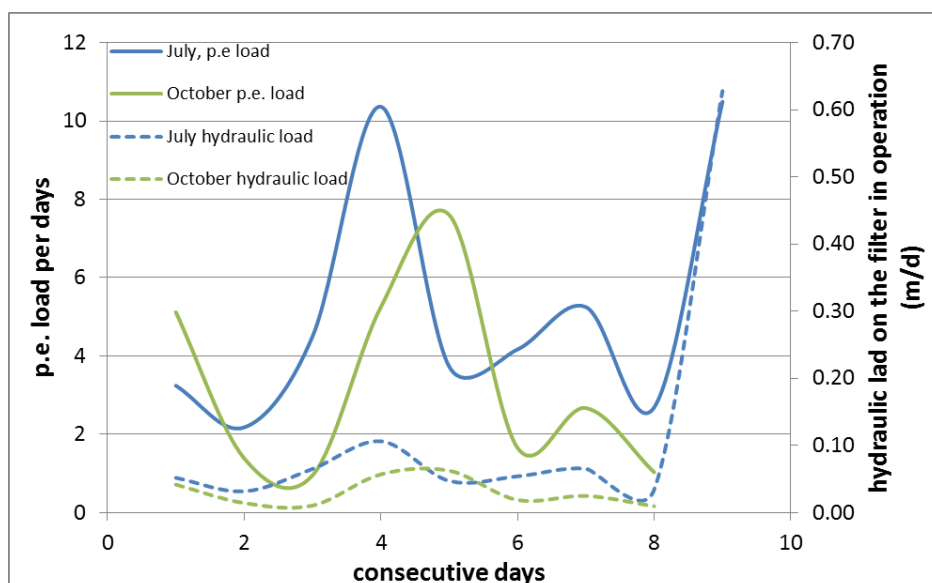
**Figure 2.** daily generated volume per capita

The measurements allow quantifying volume variations, which can double quite often even, for special events, be multiplied by 3 or more. The unique special event, with more than ten times the average hydraulic load, corresponds to a forgotten open tap associated with more people in the house. If this event can be seen as an accident and unusual situation it is important to evaluate if such an event can be accepted by the system or damage its functioning.

### Treatment performances

Based on a 60g of BOD<sub>5</sub>/p.e./d and 150 g of COD/p.e./d the system received an corresponding organic load of about 4 p.e. (one habitant is not equal to a people equivalent) with a maximum monitored load of 10.5 p.e. Even in term of organic load, variations are important and sudden.

Inlet outlet concentrations for all measured parameters are presented in Table 2. Whatever inlet concentration variations, outlet concentrations remain always low for carbon pollutant parameters, solids and nitrification. It allows realize the stability of the system regarding inlet hydraulic and organic load variations. Indeed, Figure 2 presents the organic and hydraulic load variations over consecutive days for two seasons. If hydraulic load remains globally low compared to what such system can accept (Molle et al., 2006), except for the exceptional event, the organic load vary a lot which could affect biological stability and efficiency.



**Figure 3** : organic and hydraulic loads variations over consecutive monitoring days for two seasons

**Table 2** : Inlet – outlet concentrations during 24 h proportional flow composite samples campaigns

	TSS (mg/l)		COD (mg/l)		CODd (mg/l)		BOD <sub>5</sub> (mg/l)		TOC (mg/l)		DOC (mg/l)		KN (mg/l)		N-NH <sub>4</sub> (mg/l)		N-NO <sub>2</sub> (mg/l)		N-NO <sub>3</sub> (mg/l)		TP (mg/l)		P-PO <sub>4</sub> (mg/l)	
	in	out	in	out	in	out	in	out	in	out	in	out	in	out	in	out	in	out	in	out	in	out	in	out
average	1032	10	1853	62	467	49	767	7	578	25	163	19	209	12	152	7.8	0.08	0.19	1.4	69	29	17	10	14
Median	1065	9	1780	57	470	49	784	7	588	24	157	19	207	9	148	5.4	0.04	0.16	0.5	62	29	20	9	15
Min	213	2	358	23	53	20	530	3	435	19	116	14	29	3	17	0.3	0.02	0.02	0.5	15	6	8	2	7
Max	1590	22	2750	100	708	82	1100	16	762	30	240	24	330	29	252	22.5	0.51	0.53	5.1	148	44	23	20	21
Nb of value	30	30	31	31	31	31	13	13	17	17	13	13	31	22	31	31	31	31	31	31	28	28	28	28

Despite these high load variations, performances removal stay stable as it can be seen on Figure 3. It appears that removal performances are extremely stables with, on average, more than 98 %, 99 %, 94 % and 97 % for TSS, BOD<sub>5</sub>, COD and KN respectively. Even if the hydraulic load is usually low, organic load can reach values similar to nominal design of French vertical flow constructed wetlands (Molle et al., 2005).

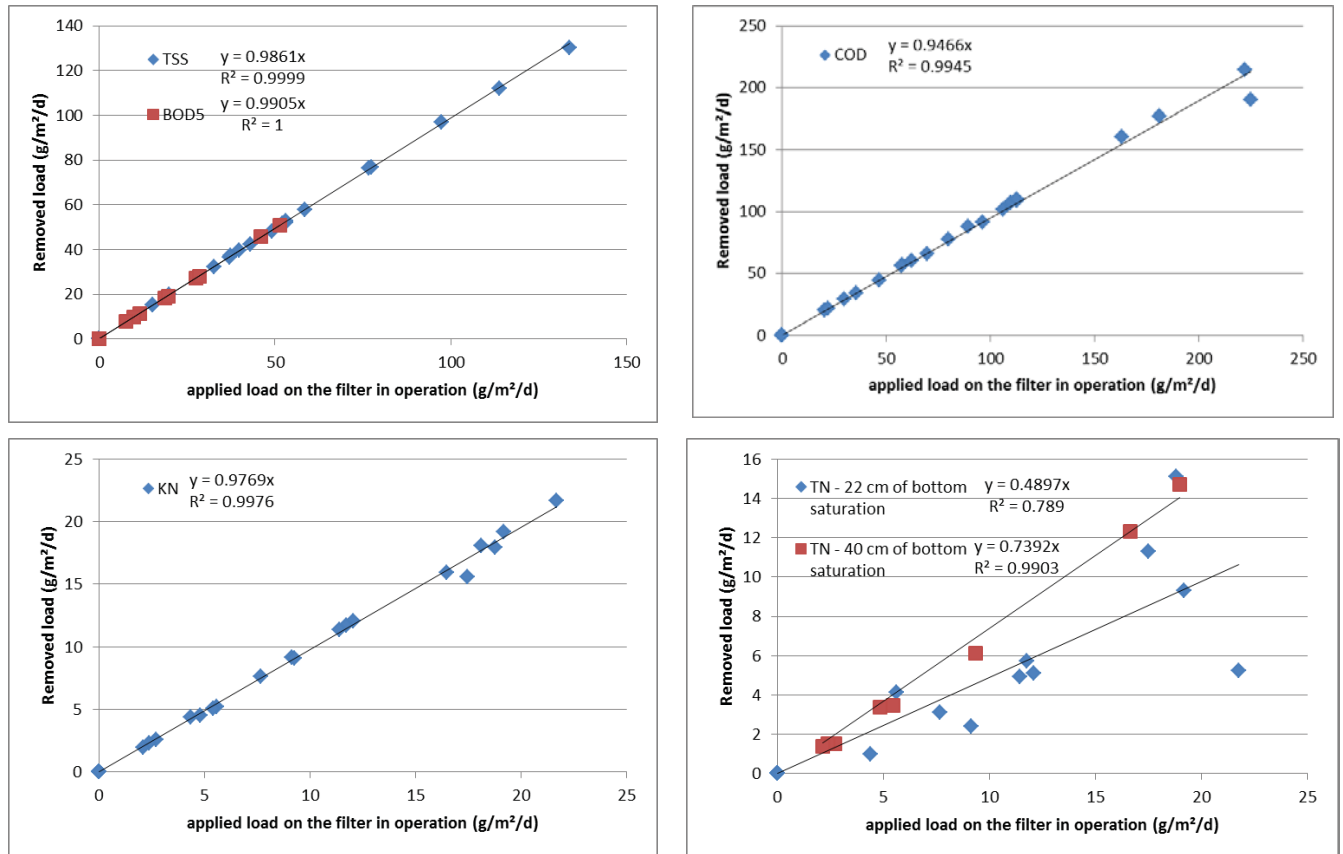


Figure 4: applied and treated loads on the filter in operation.

TN removal still not complete and no clear correlation can be done according to season. It appears that increasing the depth of the bottom saturation from 22 cm to 40 cm allowed to improve total nitrogen removal (Figure 3). With 22 cm of saturation TN removal is about 45 % and not stable, while with 40 cm total nitrogen removal reached around 70 %. It is likely not possible, with such a unsaturated layer (70 cm), to reach better TN performances as the outlet available carbon is very low. Average and median outlet COD concentrations were of 68 and 69 mgCOD/l when implementing a 22 cm saturation and of 46 and 45 mgCOD/l when implementing a 40 cm saturation depth. It is likely that those last values are close to the non-biodegradable part of COD.

Phosphorus is not correctly treated in the filter as no specific materials are implemented. Only 40 % on average is removed and correspond mainly to the particulate form of P that is filtrated by the system.

Feeding the system with raw wastewater should lead to an organic deposit accumulation on the filter's surface (Molle et al., 2005). Due to the low load applied, and despite that reeds are cut but not removed from the filter, it is not possible to measure a deposit layer depth after 5 years of operation. Main of the deposit is mineralized, which eases the sludge management and confirms the interest in feeding the system with raw wastewater.

## CONCLUSIONS

The real scale monitoring over one year and half of an onsite constructed wetlands system allows to draw some global information.

In terms of wastewater production and variation on a single house:

- Wastewater concentration characteristics are much higher than the one used in EU labeled tests. Onsite system needs to face higher concentrations.
- There is not a proportional relation between the number of people in the house and the amount of emitted water. The emitted volume per person is on average three times lower than the reference value used in the EU labeled tests but can vary between 4 and 304 liters.

This could question the relevance of the EU test and the difference of treatment systems behavior between labelled test and real life.

- Organic load variation can vary up to a ten factor from one day to another one and requires treatment system to be robust and resilient to un-expected events.

In terms of performances of the unsaturated/saturated vertical flow constructed wetlands tested, we noted that the system stays very stable whatever the variations observed during the monitoring. Removal performances are very high and outlet concentrations low and stable despite inlet variations. If performances are high for solids, carbon removal and nitrification, TN removal is impacted by the depth of the saturation level. The designed implemented seems not able to go higher than 70 % of TN removal as it doesn't still carbon source for denitrification at the outlet. To reach higher level, design should be modified, balancing nitrification performances and TN removal.

## REFERENCES

Prigent, S., Paing, J., Andres, Y., Chazarenc, F., 2013. *Effects of a saturated layer and recirculation on nitrogen treatment performances of a single stage verticalflow constructed wetland (VFCW)*. *Water Sci. Technol.* 68 (7), 1461–1467.

Silveira D.D., Belli Filho P., Philippi L.S., Kim B., Molle P. (2015) *Influence of partial saturation on total nitrogen removal in a single-stage French constructed wetland treating raw domestic wastewater*. In *Ecological Engineering*, 77, pp. 257-264.

Molle P., Liénard A., Grasmick A., Iwema A., (2006). *Effect of reeds and feeding operations on hydraulic behaviour of vertical flow constructed wetlands under hydraulic overloads*. *Water research*, Vol 40 (3), pp. 606-612

Molle P., Liénard A., Boutin C., Merlin G., Iwema A., (2005), *How to treat raw sewage with constructed wetlands: An overview of the French systems*. *Wat. Sci. & Tech*, vol 51, n°9, pp 11-21



## The new draft German constructed wetland guideline for treatment of domestic and municipal wastewater

Nowak J.<sup>1,2</sup>, van Afferden M.<sup>3</sup>, Albold A.<sup>4</sup>, Bernhard K.<sup>4</sup>, Fehr G.<sup>5</sup>, Galander C.<sup>6</sup>, Hasselbach R.<sup>7</sup>, Heise B.<sup>8</sup>, Kühn V.<sup>9</sup>, Langergraber G.<sup>10</sup>, Molle P.<sup>11</sup>, Nivala J.<sup>3</sup>, Rustige H.<sup>2</sup>, Stockbauer M.<sup>12</sup>

<sup>1</sup> Fachhochschule Potsdam, Potsdam, Germany

<sup>2</sup> AKUT Umwelt, Berlin, Germany

<sup>3</sup> Helmholtz Center for Environmental Research– UFZ, Leipzig, Germany

<sup>4</sup> Otterwasser GmbH, Lübeck, Germany

<sup>5</sup> KED GmbH & Co., Langenhagen, Germany

<sup>6</sup> Umweltbundesamt – UBA, XXXXX, Germany

<sup>7</sup> Entsorgungsverband Saar – EVS, Saarbrücken, Germany

<sup>8</sup> Staatliches Amt für Landwirtschaft und Umwelt, Neubrandenburg, Germany

<sup>9</sup> Stadtentwässerung Dresden GmbH Technical University of Dresden, Dresden, Germany

<sup>10</sup> Universität für Bodenkultur Wien – BOKU, Vienna, Austria

<sup>11</sup> Irstea, Lyon, France

<sup>12</sup> Bayerisches Landesamt für Umwelt, Augsburg, Germany

**Keywords:** constructed wetland, design, guideline

### Abstract

The German guideline for the dimensioning, construction, and operation of constructed wetlands for biological treatment of domestic and municipal wastewater, which last published in March 2006, is being updated. The guideline applies to small wastewater treatment systems of less than 50 Person Equivalents (PE) apart from EN 12566-3, municipal treatment plants (with combined or separated sewers), treatment systems which use constructed wetlands as a polishing step, and small wastewater treatment systems which are operated seasonally (summer months only).

The revision is based on a wide range of experience gained in recent years in the use of treatment wetlands in Germany and in Europe. Prior to the revisions, the proposed changes were discussed in a public hearing in Potsdam, Germany in January 2014. The final revisions were released for public review in April 2016. The comments from the public review were submitted in written form to the DWA working group in late 2016, and a follow-up meeting was held in early 2017. The finalized document is anticipated to be put into effect in mid-2017.

Several constructed wetland designs appear for the first time in the new guideline. Two-stage unsaturated vertical flow gravel filters which receive raw wastewater in the first stage (based on experience in France) as well as two-stage unsaturated vertical flow filters receiving primary-treated wastewater (based on experience in Austria) are now included. The revisions also include new dimensioning for unsaturated vertical flow filters with lava sand as the main treatment media, as well as aerated treatment wetlands, both as secondary treatment steps.

Recommendations are also provided for seasonally operated constructed wetlands, as well as constructed wetlands for graywater treatment. With the publication of the new guideline, horizontal subsurface flow constructed wetlands are no longer supported as a secondary treatment stage in Germany, and are recommended only as a tertiary or polishing stage. Existing horizontal subsurface flow wetlands may continue operation, provided the systems are not hydraulically or organically overloaded, and that they continue to receive routine operations and maintenance. This presentation will outline the key points of the newly revised DWA-A 262 German constructed wetland guideline.

# On-site wastewater treatment in France: statistical analysis of the outlet effluent quality of 240 facilities

Ref # Olivier\_S2Small2017

L. Olivier<sup>1\*</sup>, C. Boutin<sup>1</sup>

<sup>1</sup> Freshwater systems, ecology and pollution research unit, IRSTEA, 5 rue de la Doua, CS 70077, 69626 Villeurbanne, France

\*Corresponding author: laurie.olivier@irstea.fr

**Keywords:** COD, Comparison, Nitrogen, On-site treatment, Statistic, Wastewater treatment.

## INTRODUCTION

On-site sanitation refers to systems used for the treatment of wastewater from individual houses. Almost 5 million of on-site wastewater treatment systems are listed in France.

France issues approvals based on a close analysis of the European Commission (EC) marking test results (EN 12566-3) or following a similar procedure for systems without EC marking. Until 2009, only 4 “traditional” systems using soil treatment, sand or zeolite filters were allowed. Latest changes in French regulation have permitted the commercialization of new systems: in 2017, more than 600 approvals from 60 constructors were issued in France. All systems are based on known processes in wastewater treatment and can be gathered in 3 processes families: Attached Growth Systems on Fine Media (AGSFM), Biofilm Systems (BS), or Activated Sludge Systems (ASS).

An assessment of on-site sanitation systems began in 2011 to evaluate their efficiency. Data were collected from 240 on-site sanitation facilities in 22 French departments which cover 5 of the 6 Water Agency territories. The parameters analysed at the outlet are TSS, COD, BOD<sub>5</sub>, NH<sub>4</sub><sup>+</sup>-N, NO<sub>3</sub><sup>-</sup>-N and TKN.

The aim of this article is to describe the outlet effluent quality and explain the data dispersion by analyzing the impact of explanatory variables such as i) the sampling method, ii) the treatment processes, iii) the applied organic load, iv) the aging and v) the maintenance.

## MATERIAL AND METHODS

During 6 years, more than 1300 data were collected under standard conditions with two different sampling methods: 24h composite sample or punctual sample.

A methodology to validate data was developed by Irstea and has permitted to remove 11.8% of data; therefore the data analysis was carried out on 1286 validated data.

Among the 3 families (AGSFM, BS and ASS), 13 treatment processes were identified to gather systems based on common design characteristics such as the media (sand, zeolite, rock wool...).

The organic load was not measured. Therefore, the daily load (in COD) has been recalculated based on the number of inhabitants, their activities (at home all day or outside) and the amount of pollution per person per day. A loading rate is established from the nominal capacity.

The studied facilities are between 1 year and 12 years old which permits to study the aging of the systems over time.

The dataset obtained is heterogeneous i.e. different sampling methods, different wastewater treatment processes and a variability in the number of data per installation. Therefore, a statistical methodology has been implemented to compare systems within each other via an analysis of outlet concentrations of 6 parameters also called dependent variables (TSS, COD, BOD<sub>5</sub>, NH<sub>4</sub><sup>+</sup>-N, NO<sub>3</sub><sup>-</sup>-N and TKN).

The two types of sampling, the different treatment processes, the recalculated loading rate and the aging are identified as explanatory variables; they enable to explain the outlet effluent quality.

Each dependent variable has a quantification limit below which no value can be measured (i.e. left-censored data). The only statistical methodology which allows to process left-censored data is the analysis of generalized log-linear model.

The equation of the model is:

$$\log(Y) = \mu + s \times \omega$$

With:

- Y : dependent variable
- $\mu$  : regression line ( $\beta_0 + \beta_1.X_1 + \dots$ ) where  $X_i$  are explanatory variables and  $\beta_i$  are the model coefficients
- s : dispersion parameter
- $\omega$  : normal residual error

In each subset of data (3 families, 13 processes, 32 systems), the model will identify the significant effects of explanatory variables for each of the 6 dependent variables.

Another methodology has been implemented to assess the frequency of the sludge emptying and the corrective maintenance of 170 facilities based on the analysis of qualitative data by the “fuzzy logic”. This method analyzes rules created from sanitation expert judgment and compares the different levels of maintenance from each family, process and system.

## MAIN RESULTS AND CONCLUSIONS

Table 1 presents the number of validated data collected until 2016 for each process and family (1286). Between 2011 and 2016, 778 punctual samples and 508 24h composite samples have been collected. These processes have already been compared in terms of infiltration surface and daily applied surface organic load (Dubois 2017).

**Table 1: Number of data collected until 2016 for each family and each type of process**

Attached Growth Systems on Fine Media		Biofilm Systems		Activated Sludge Systems	
Media	Number	Types	Number	Types	Number
Sand	149	Fixed bed	368	Classical*	37
Constructed wetlands	126			Without I settlement tank	84
Zeolite	139	Fluidized bed	13	With additional treatment	26
Rock wool	102				

Coconut shaving	93	Biological discs	7	SBR	139
Pine barks	3				
<b>TOTAL</b>	<b>612</b>	<b>TOTAL</b>	<b>388</b>	<b>TOTAL</b>	<b>286</b>

\*Classical = I settlement tank + biological reactor + II clarifier

High variability in outlet concentrations was observed; the TSS concentration can be 160 times higher than the median value and 33 times higher for COD concentration.

The model shows significant differences between the 3 families, 13 processes and 32 systems. These results are easily explained by the pollution degradation processes.

Due to a large amount of data and a wide range of stakeholders involved, this study would have a large impact on on-site sanitation in France and in Europe.

Data processing and results interpretation will be completed in September. Results of the study will be presented for the first time during the on-site sanitation conference (Assises de l'ANC) in September 2017 in France and will be published shortly afterwards.

## REFERENCES

Boutin, C. Dubois, V. and Lassablière, C. 2013 *Comparaison théorique de dispositifs d'ANC: les cultures fixées sur support fin autorisées au 1er novembre 2013 (Theoretical comparison of on-site sanitation systems: Attached Growth Systems on Fine Media approved before 1st of November 2013)*, Onema publication. 104 p.

Dubois, V., Boutin, C. 2017 A Comparison of the Design Criteria of 141 On-Site wastewater Treatment Systems Available on the French Market, *Journal of Environmental Management* (article in press)

Dubois, V., Chavarria, R., Boutin, C. 2014 *Comparaison théorique de dispositifs d'ANC: les filières par "cultures libres" autorisées au 1 août 2014 (Theoretical comparison of on-site sanitation systems: Activated Sludge Systems approved before 1st of August 2014)*, Onema publication. 74 p.

Guillaume Serge et Charnomordic Brigitte. 2011 Learning interpretable Fuzzy Inference Systems with FisPro, *International Journal of Information Sciences*, doi:10.1016/j.ins.2011.03.025, 181(20), 4409-4427.

Hill Catherine, *Analyse statistique des données de survie (Statistical analysis of survival data)*, Médecine-Sciences, Paris, 1999, ISBN 2257123107, 190 p.

MEDDE 2014 Agréments des dispositifs de traitement en France : site du Ministère de l'Environnement (Approvals of on-site sanitation systems in France: website of the Ministry of the Environment), <http://www.assainissement-non-collectif.developpement-durable.gouv.fr/agrement-des-dispositifs-de-traitement-r92.html> (accessed 06 July 2017)

# Green Bio-sorption Reactor: Making wastewater treatment plant an attractive scenario

Zhao, Y.Q.<sup>1,2</sup>, Liu, R.B.<sup>2</sup>

<sup>1</sup> Institute of Water Resources and Hydro-electric Engineering, Xi'an University of Technology, Xi'an 710048, Shaanxi, P.R. China

<sup>2</sup> UCD Dooge Centre for Water Resources Research, School of Civil Engineering, University College Dublin, Belfield, Dublin 4, Ireland

**Keywords:** Green bio-sorption reactor; Aesthetic value; Eco-friendly technology; Nutrients enhancement;

## Introduction

Since the invention of the activated sludge (AS) process in 1914, it has been hitherto the mainstream process in urban wastewater treatment plants (WWTPs). Actually, the evolution and improvement based on this technology has been ongoing along the industrialization and urbanization in the last 100 years. For instance, the introduction of the carriers, i.e., biological contact oxidation process (BCOP), moving bed biofilm reactor (MBBR), and integrated fixed-film activated sludge (IFAS), really enhances the performance and capacity of the conventional AS in accordance with the increasing wastewater quantity (Lewkowska et al., 2016). Recently, a novel Green Bio-sorption Reactor (GBR) was proposed and studied in University College Dublin and its partner university in China. The GBR integrates an alum sludge-based constructed wetland with the AS but far more than their simple combination. As depicted in Fig. 1, this GBR comes in direct line of succession with the previous AS systems but with superior features (Liu et al., 2017).

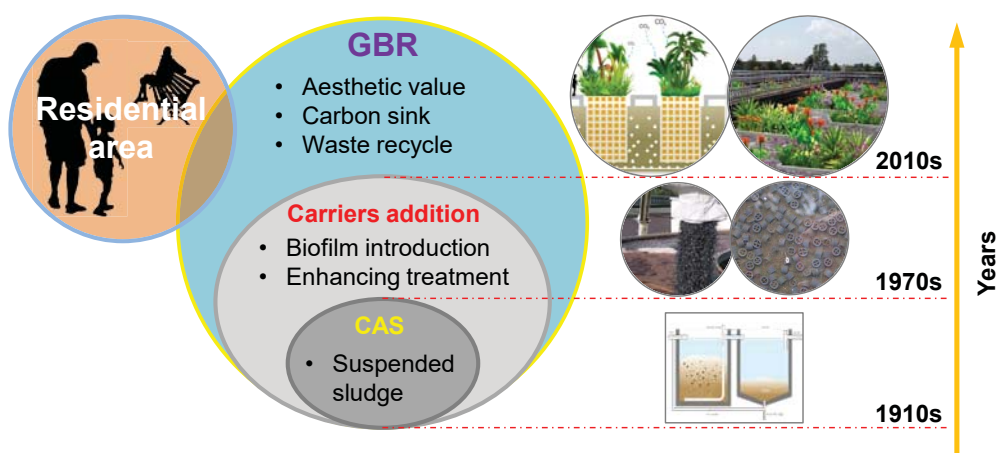


Fig. 1 Schematic diagram of the evolution of activated sludge systems and interaction with the residents



## Highlighted features of the GBR

The integration of constructed wetland and AS achieves “1+1>2” scenario. Specifically, the inherited and exclusive features of the GBR are summarized as follows: 1) Enhancing capacity/efficiency; The alum sludge acts as bacteria carriers to sustain more biomass, which undoubtedly increase the treatment capacity/efficiency. Moreover, some well-developed roots of the wetland vegetation are conducive to the biomass quantity; 2) Adsorptive material; In the current study of GBR, alum sludge, a robust phosphorus (P) adsorption material, was used as matrix in constructed wetland to enhance the P and/or other pollutants’ immobilization; 3) Carbon saving; The introduction of the P-adsorptive material (alum sludge) bears the possibility to replace the biological P removal process in AS, thereby saving the carbon source for nitrogen removal; 4) Aesthetic value & Carbon sink; The outstanding feature of GBR lies in its highly aesthetic value because of the vegetation (flowers and plants). The GBR creates a pleasing appearance of the wastewater treatment facilities, instead of ugly concrete in normal sense in people’s eyes. Moreover, the introduction of the plants makes this facility potential carbon sink and contributes to the carbon neutralization; 5) Bring harmony; As illustrated in Fig. 1, GBR holds the potential to be involved and incorporated into the residential area, rather than reserve a buffer zone or in an isolated area; 6) Waste recycle; The utilization of the alum sludge is in line with the theory of “recycle, reuse and reduce”. It is noteworthy that the alum sludge could be replaced by other functional waste materials.

## Lab performance of the GBR

A lab-scale trial of GBR was preliminarily investigated based on a sequencing batch reactor. It has demonstrated a satisfying performance for domestic wastewater treatment, depicted in Fig. 2.

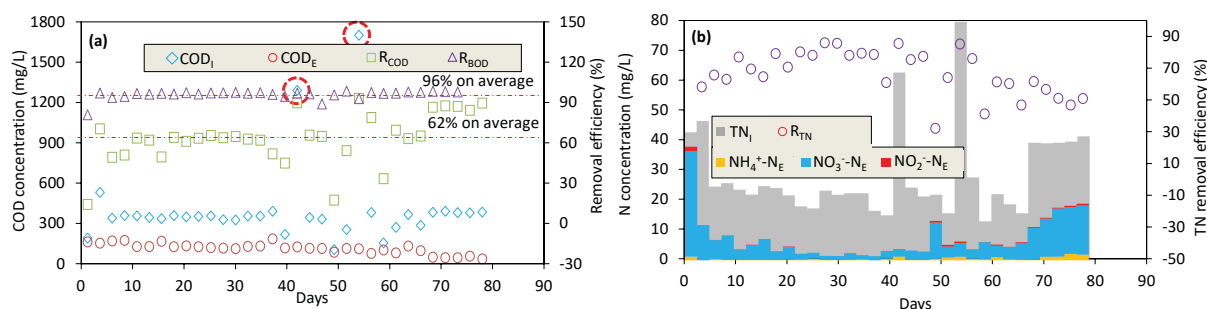


Fig. 2 COD and nitrogen removal performance in the lab-scale GBR

## References

- Lewkowska, P., Cieřlik, B., Dymerski, T., Konieczka, P., Namieřnik, J., 2016. Characteristics of odors emitted from municipal wastewater treatment plant and methods for their identification and deodorization techniques. *Environ. Res.* 151, 573–586.
- Liu, R., Zhao, Y., Zhao, J., Xu, L., Sibille, C., 2017. Embedding constructed wetland in sequencing batch reactor for enhancing nutrients removal: A comparative evaluation. *J. Environ. Manage.* 192, 302–308.

## **Nkolfoulou landfill leachate treatment performances in VFCWs planted with *Echinochloa Pyramidalis* during dry season**

**Fendoung, G.<sup>1</sup>, Sieliechi, J.<sup>2</sup>, Ngassoum, M.<sup>2</sup> and, Chazarenc, F.<sup>1</sup>**

<sup>1</sup> L'UNAM Université, IMT Atlantique, CNRS, GEPEA, UMR 6144, 4 rue Alfred Kastler, 44307 Nantes, France

<sup>2</sup> UN, ENSAI, BP 454 Bini Ngaoundéré, , Cameroun

**Keywords:** vertical flow, Constructed wetlands; landfill leachate, treatment performance

### **Introduction**

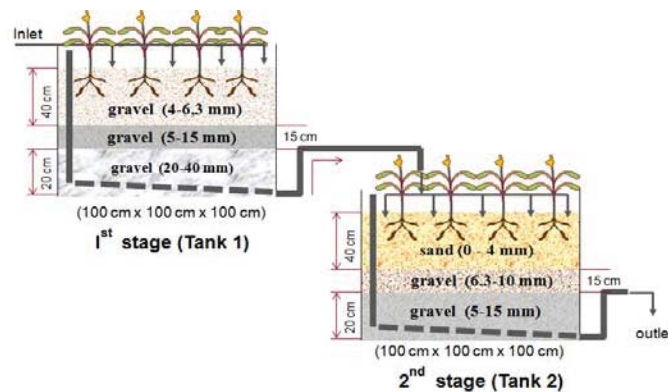
In Cameroon, as many other cities in Sub-Saharan African Countries, land filling of Municipal solid wastes still the best waste disposal techniques. Alongside with high rainfall (1600mm/year) in the region, this generates landfill leachate worldly recognised as one of the major water pollutant source. Indeed, Nkolfoulou landfill leachate contributed to burn product in the gardens surrounding the site. Moreover, it was listed as the potential hazard for the population living around. According to that situation, the Yaounde city council exposed the wheal for improvement. Organics and nitrogen are the main compounds contained in landfill leachate that can contribute to water quality degradation when discharges in the environment. Since 1990s, Vertical Flow Constructed Wetlands (VFCWs) have been more and more popular in treating small scale domestic wastewater of less than Pe (> 2500 units in 2012) in temperate climate. However, few investigations were conducted on landfill leachate in subequatorial tropical countries like Cameroon. Furthermore, no reported study was made on the use of *Echinichloa Pyramidalys* to treat landfill leachate in VFCWs. However, *Echinochloa Pyramidalis*, local forage plant in Cameroon, was previously and successfully sequestrated COD and N in sludge bed dehydration (Kegne, 2008).

The aim of this work was then to implement a small wastewater treatment plants (< 2000 Pe) made of a vertical flow constructed wetland (VFCWs) planted with *Echinochloa Pyramidalis* to treat Nkolfoulou landfill leachate in Yaounde, Cameroon. The scientific approach consisted in monitoring pilot field scale during long dry season. Treatment performances (pH, Conductivity, MES, COD and N) were weekly monitored.

### **Material and Methods**

The experimental mesocosm consisted of 2 cubic plastic containers combined in series and filled with gravel and sand based on the vertical flow French system (fig 1). 12 rizhomes of *Echinochloa pyramidalis* were planted in each tank. The system has been monitored weekly during 5 weeks From 03 december 2017 till 01 january 2017. Leachates coming from the storage pond in Nkolfoulou landfill site were fed with effluent according to batch loads (10 batches of 20L per day during 3 days per week). Tank 2 was fed by gravity with outlet of tank1.

Sample was collected at 3 different points: inlet of tank1 (EF1); inlet of tank2 (EF2) and outlet of tank2 (SF2). Analyses have been done according to standard method.



## Results and Discussion

The main results showed: (i) the fluctuation of temperature was stable between 26 and 33 °C. The pH at the outlet of tank2 were lower compare to inlet of tank1 and inlet of tank12 and the evolution in time flow the evolution at the inlet of tank1. The maximum efficiency for COD was observe during the first three weeks and decreased later.

## References

Kengne N. Ives. M. (2008) Potentials of sludge drying beds vegetated with *Cyperus papyrus* L. and *Echinochloa pyramidalis* (Lam.) Hitchc. & Chase for faecal sludge treatment in tropical regions, Ph.D THESIS, University of Yaoundé 1

# **Design parameters influence on pollution removal performance of full-scale constructed-wetlands treatments plants for domestic wastewater.**

**Rodriguez Vasquez, S.<sup>1,3</sup>, Viguiet, J.<sup>3</sup>, Chazarenc, F.<sup>1</sup>, Sperandio, M.<sup>2</sup>**

<sup>1</sup> L'UNAM Université, IMT Atlantique, CNRS, GEPEA, UMR 6144, 4 rue Alfred Kastler, 44307 Nantes, France

<sup>2</sup> INSA de Toulouse, 135 Avenue de Rangueil, 31400 Toulouse

<sup>3</sup> SADE Company, 15 Avenue Gustave Eiffel. Pessac, France

**Keywords:** Constructed wetlands; vertical flow, horizontal flow, design parameters

## **Introduction**

The aim of this work is to evaluate the influence of different design parameters on the performance of full-scale constructed wetland treatment plants. Performance data was recovered for 159 sites in France. The configurations of these plants are distributed as follows: 119 sites with the “French System” configuration, two vertical flow stages of treatment with 2-2.5 m<sup>2</sup>/PE, 27 sites with the “Compact System” configuration, one vertical flow stage of treatment with 1.5 m<sup>2</sup>/PE, and 13 sites with several combinations of vertical and horizontal flow constructed wetlands and/or ponds. All the sites are for domestic wastewater treatment.

## **Material and Methods**

The data relating to the performance of each of the sites was obtained by contacting the local authorities, SATESE, in charge of the monitoring and controlling of wastewater treatment plants in each department. The number of results for each site varied according to the capacity of the treatment plant and the local policies of the SATESEs, with an average of 4 results per site. The performance parameters considered in the survey were: TSS, COD, BOD<sub>5</sub>, TKN and, when available, TN, NH<sub>4</sub>, Nitrite, Nitrate and TP.

As for design parameters, for each treatment plant the following information was recorded: location, start-up year, configuration, capacity (PE), type of sewer system (combined or separate), recirculation, nominal daily inflow, nominal loading rate and the characteristics of each constructed-wetland stage of the system: type of flow, area by PE, depth of the filtering layer and type of substrate.

## **Obtained and Expected Results**

A total of 655 results were obtained for the 159 constructed-wetland treatment plants. The results for the sites with the “French System” configuration correspond with current literature, with very good performances (>90%) for TSS, DCO, BOD<sub>5</sub> and TKN, but lacking for TN and TP. A more detailed analysis of the data will be carried out with the aid of statistical software such as R or Minitab, to have a clear understanding of the influence of each of the design parameters in the treatment performance. This will allow for the formalisation of design criteria

for responding to more restrictive performance demands and to identify potential leads for future research.

## References

- Molle, P., Liénard, A., Boutin, C., Merlin, G., & Iwema, A. (2004). Traitement des eaux usées domestiques par marais artificiels: état de l'art et performances des filtres plantés de roseaux en France. *Ingénieries*, 23-32.
- Groupe Macrophytes et Traitement des Eaux, Agence de l'eau Rhône, Méditerranée et Corse. (2005). *Epuration des eaux usées domestiques par filtres plantés de roseaux. Recommandations techniques pour la conception et la réalisation* .
- Paing, J., Guilbert, A., Gagnon, V., & Chazarenc, F. (2015). Effect of climate, wastewater composition, loading rates, system age and design on performances of French vertical flow constructed wetlands: A survey based on 169 full scale systems. *Ecological Engineering*, 46-52.
- Tanner, C. C., Sukias, J. P., Headley, T. R., Yates, C. R., & Stott, R. (2012). Constructed wetlands and denitrifying bioreactors for on-site and decentralised wastewater treatment: Comparison of five alternative configurations. *Ecological Engineering*, 112-123.
- Vymazal, J. (2013). The use of hybrid constructed wetlands for wastewater treatment with special attention to nitrogen removal: A review of a recent development. *Water research*, 4795-4811.

# Electroactive Biofilm-based Constructed Wetland (EABB-CW): Testing of an innovative setup for wastewater treatment

Carlos A. Ramírez-Vargas<sup>a</sup>, Carlos A. Arias<sup>a</sup>, Pedro Carvalho<sup>a</sup>, Liang Zhang<sup>a</sup>,  
Abraham Esteve-Núñez<sup>b</sup>, Hans Brix<sup>a</sup>

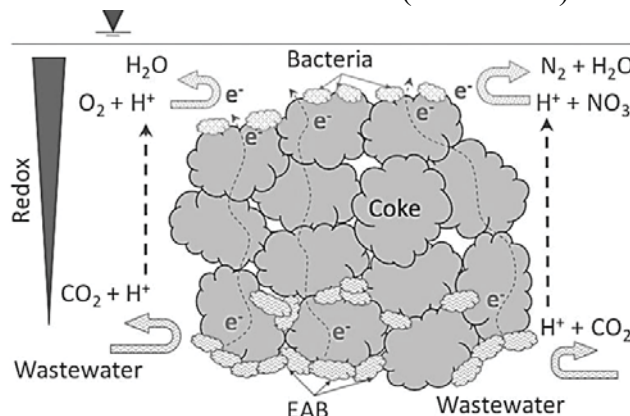
<sup>a</sup>Department of Bioscience – Aquatic Biology, Aarhus University, DENMARK  
(c.a.ramirez@bios.au.dk)

<sup>b</sup>Department of Chemical Engineering – Universidad de Alcalá, SPAIN

## INTRODUCTION

Constructed wetlands (CWs) performance enhancement can be achieved through the coupling with Microbial Electrochemical Technologies (MET) (Doherty et al., 2015). MET are setups designed to mimic metabolic electrons exchange with insoluble donors and acceptors with the aid of electroactive bacteria (EAB) and external electrical circuits (Rabaey et al., 2007). Esteve-Núñez (2015) proposed an alternative system using electro-conductive biofilters instead of the electrodes and circuits used in MET, resulting in the development of a Microbial Electrochemical-based Constructed Wetland (METland).

The system relies on EAB metabolism to release/transfer electrons to an electro-conductive material that acts as an unlimited electron acceptor (Fig.1), thus boosting substrate consumption, and diminishing electron availability for biomass build-up and methane generation. Aguirre-Sierra et al (2016) tested a subsurface flow METland and reached removals up to 91% and 96% for COD and BOD<sub>5</sub> (0.5 d HRT), and 97% and 69% for NH<sub>4</sub> and TN (3.4 d HRT), suggesting that the system can enhance the biodegradation rates. Based on these findings, this work aimed to establish the capacity and removal rate kinetics for organic matter and nutrients in an Electroactive Biofilm-Based CW (EABB-CW).



**Fig. 1. Concept of Electroactive Biofilm-based Constructed Wetland.**

## METHODS

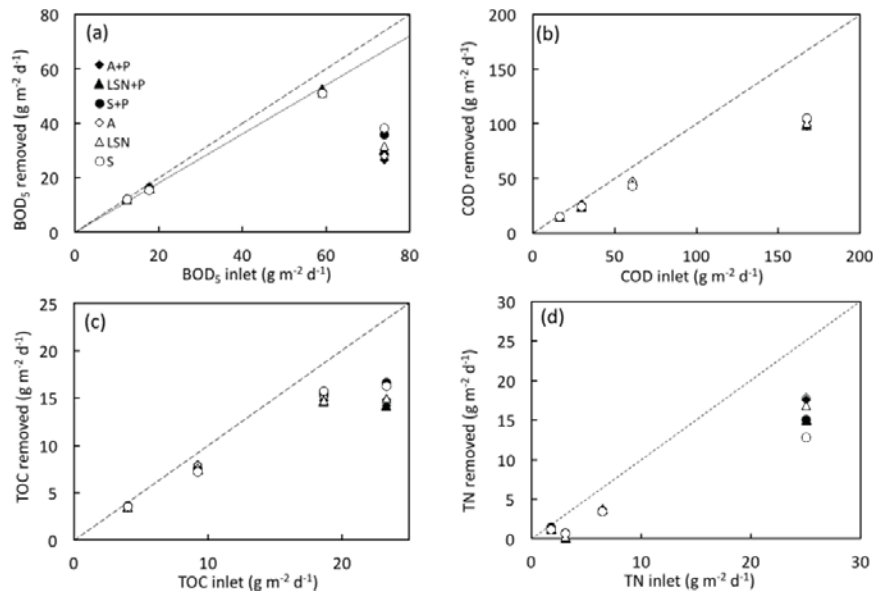
The experimental setup consisted of 16 columns (h: 50 cm; Ø: 16 cm; packed vol.: 8.44 L) installed in a greenhouse at Aarhus University, Denmark. Twelve of the columns were filled with two types of electro-conductive materials (6 columns each) and 4 columns filled with sand as a control. Half of the columns were planted with *Juncus effusus* to determine the effects of the plant. The setup was up-flow fed with primary settled pig manure supplemented with starch and molasses as extra carbon source ( $\pm 600$  mg COD L<sup>-1</sup>). The test ran for 16 weeks, with 4 different organic loading rates (OLR) with 4 weeks of acclimation before sampling. Grab samples were taken from the inlet, outlet and along three different points of the column's height for 3 consecutive days. pH, EC, T°, DO, ORP, COD, BOD<sub>5</sub>, TOC, NH<sub>4</sub>, NO<sub>3</sub>, TN and PO<sub>4</sub>



were analysed following standard methods. Additionally, molecular techniques are being used to identify the presence of EAB.

## RESULTS AND DISCUSSION

The results (Fig. 2) show BOD<sub>5</sub> mass removal rates > 90% for OLR of 60 g m<sup>-2</sup> d<sup>-1</sup>. From that point on, removal rates fell indicating the maximal capacity of the tested set-up. For COD the removal rates are > 80% for OLR up to 30 g m<sup>-2</sup> d<sup>-1</sup>, and reaching 60% at the highest OLR (170 g m<sup>-2</sup> d<sup>-1</sup>). TOC removal followed a similar pattern, showing removal rates > 70% for a maximum inlet load of 23 g m<sup>-2</sup> d<sup>-1</sup>. TN removal showed an erratic behaviour which could be related to the nitrifying limitations of the saturated flow systems. No differences were found between planted and non-planted columns. Further results of removal rates for NH<sub>4</sub>, NO<sub>3</sub>, PO<sub>4</sub>, profiles of all the parameters and molecular analysis will be presented at the conference.



**Fig. 2. Load rate at inlet vs. removed for (a) BOD<sub>5</sub>, (b) COD, (c) TOC and (d) TN. Caption: A = coke PK-A; LSN = coke PK-LSN; S = Sand; +P = planted**

## CONCLUSIONS

The EABB-CW profiles as a suitable innovation for wastewater treatment, reaching removal rates of organic matter like in HSSF-CW but at OLR 10 times higher, and comparable with the performance of VF-CW. Further conclusions regarding the removal of nutrients and their relation with the presence of EAB will be presented in the conference.

## ACKNOWLEDGEMENTS

PhD scholarship granted by COLCIENCIAS (Colombia). The iMETland project has received funding from the European Union's Horizon 2020, grant agreement No. 642190.

## REFERENCES

- Aguirre-Sierra, A., et al (2016). Microbial Electrochemical Systems outperform fixed-bed biofilters for cleaning-up urban wastewater. *Environ. Sci.: Wat. Res. Technol.*, 2, 984–993.
- Doherty, L., et al (2015). A review of a recently emerged technology : Constructed wetland - Microbial fuel cells. *Water Research*, 85, 38–45.
- Esteve-Núñez, A. (2015). Electricity-generating bacteria Bioelectrogenesis: sustainable biotechnology. *International Innovation*, 181, 109–111.
- Rabaey, K., et al (2007). Microbial ecology meets electrochemistry: electricity-driven and driving communities. *The ISME Journal*, 1 (1), 9–18.

# Nutrients removals in vertical flow constructed wetlands combined or not with biological and/or chemical treatment processes

Ref # S2SMALL-04481

B. Kim<sup>1\*</sup>, M. Kania<sup>1,2</sup>, M. Gautier<sup>1</sup>, P. Michel<sup>1,2</sup>, R. Gourdon<sup>1</sup>

<sup>1</sup> Univ Lyon, INSA Lyon, DEEP, EA7429, 20 Av. Albert Einstein, 69621 Villeurbanne cedex, France

<sup>2</sup> SCIRPE Company, 5 Allée Alban Vistel, 69110 Sainte-Foy-Lès-Lyon, France

\* Corresponding Author: [boram.kim@insa-lyon.fr](mailto:boram.kim@insa-lyon.fr)

**Abstract:** The main objective of the present study was to perform statistical data analysis of several classical French vertical flow constructed wetlands (VFCW) combined or not with biological trickling filter and/or ferric chloride addition processes. Results of inlet/outlet 24h composite samples monitoring were collected from 14 full-scale treatment plants in operation for up to 12 years. The compilation of data was conducted to compare the treatment efficiencies with respect to the treatment plant size and the variations in the inflow wastewater composition. The results showed a relatively high homogeneity in the quality of the effluents released into the environment from different treatment plants, regardless of the surface size and inlet loads. This observation underlined the robustness of the treatment operations conducted in the different configurations of the plants.

**Keywords:** constructed wetlands; ferric chloride; nitrogen; phosphorus; statistical analyses; trickling filter

## INTRODUCTION

The use of vertical-flow constructed wetlands (VFCW) for the treatment of domestic wastewater from small communities has been growing fast in France since the 1980s until recent years where the growth started to level off. This system has proven its good performances in organic matter removal and nitrification (Kim et al., 2014; Morvannou et al., 2015). Recent research and development efforts have been essentially devoted to (i) design optimization (additional treatments, compact systems, etc.), (ii) total nutrient removals (nitrogen and phosphorus) and (iii) water reuse and sustainable resource recovery (Carvalho et al., 2017; Kim et al., 2015; Millot et al., 2016; Molle, 2014; Morvannou et al., 2017; Wu et al., 2014).

Compact VFCW systems combining trickling filter and ferric chloride injection to classical French-VFCW design, have been developed and patented by SCIRPE company under the general registered trademark AZOE<sup>®</sup> (Fig. 1). Kim et al. (2014) reported good efficiencies of nutrient removal in the oldest full-scale AZOE<sup>®</sup> treatment plant in operation. Nevertheless, the specific roles of the trickling filter stage and ferric chloride injection with regards to the site-dependent characteristics of the inflow are not yet fully known. In addition, the effects of the nature and composition of the inflow wastewater on the formation and evolution of the surface deposit layer, and the effects induced on the treatment performance, are also almost ignored (Kania et al., 2016).

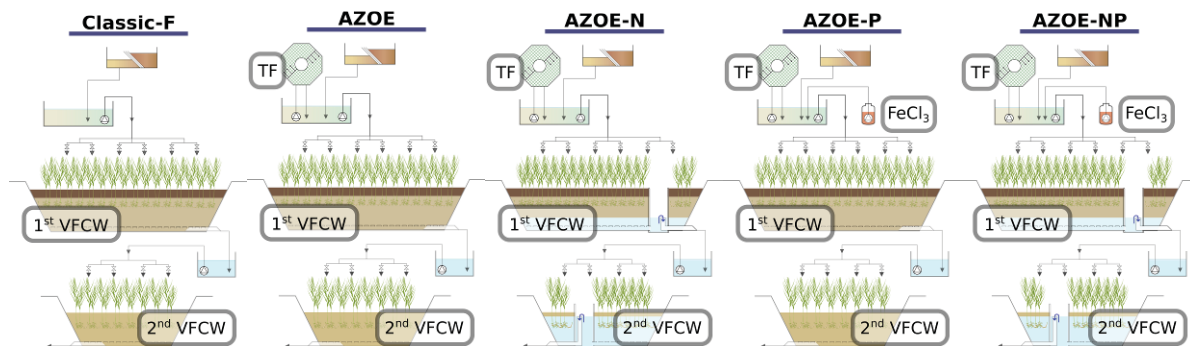
The objective of the present study was therefore to analyze series of inlet-outlet data collected from several classical and AZOE<sup>®</sup> French VFCW treatment plants, with regards to the characteristics of the feed and the treatment performance of the considered systems.

## MATERIALS AND METHODS

In the first place, 14 full-scale treatment plants (named as BAG1, BAG2, BAG3, SABAG, VIL, PRE, RAM, BAY, MIN, NEU, VER, ORB, COR and MAT) aged from 1 to 12 years were selected. The treatment capacities of these plants vary from 133 to 1100 people equivalent (PE). Data were gathered from existing available studies. The following parameters were analysed on 24h composite samples from the inlet and outlet of the plants according to standard methods: TSS, BOD<sub>5</sub>, COD, KN, NH<sub>4</sub>-N, NO<sub>3</sub>-N, TP and PO<sub>4</sub>-P.

The selected plants were representative of 5 different categories of process chains (Fig. 1). The first category, corresponding to the basic design of “classical French VFCWs” (Classic-F in Fig. 1), included treatments that were common to all 5 categories, namely two successive stages of VFCWs composed of two or three filter cells alternatively fed by batches. The four other categories, corresponding to the different AZOE<sup>®</sup> treatment chains all included an additional stage of aerobic biological trickling filter, and defined by the following specificities:

- AZOE<sup>®</sup> was characterized by unsaturated filters designed to optimize OM mineralization and nitrification;
- AZOE<sup>®</sup>-N was characterized by partly saturated filters designed to optimize nitrogen removal via nitrification / denitrification
- AZOE<sup>®</sup>-P, was characterized by FeCl<sub>3</sub> addition for phosphorus precipitation after treatment on trickling filter
- AZOE<sup>®</sup>-NP combined partly saturated VFCWs and FeCl<sub>3</sub> addition to optimize both nitrogen and phosphorus removals.



**Figure 1.** Simplified diagrams of the five different process categories represented in the selected plants. [TF] and [FeCl<sub>3</sub>] show the “trickling filter” and “ferric chloride injection” stages, respectively.

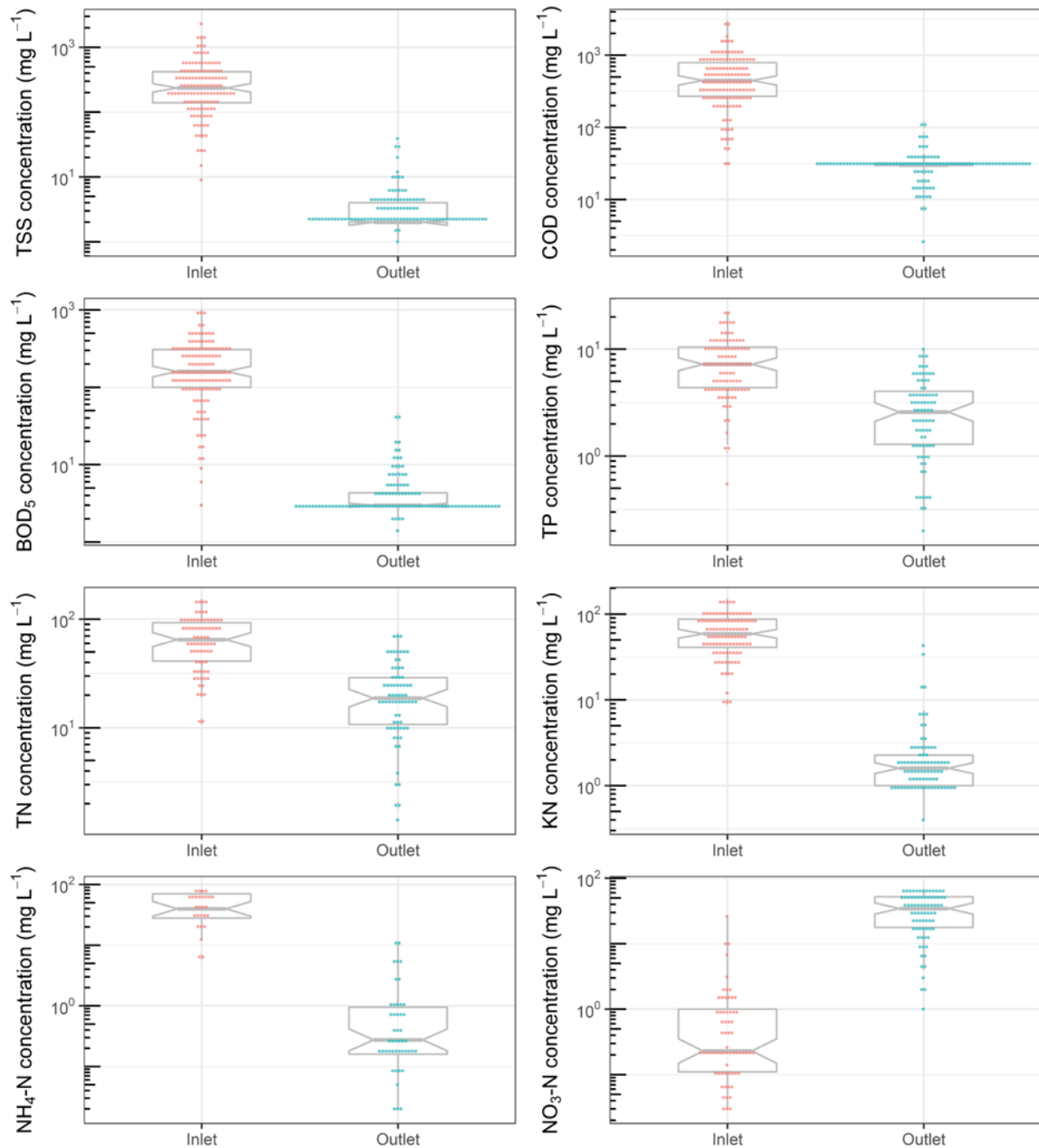
The following parameters were gathered to characterize the different plants: date of implementation, sampling dates, inflow wastewater composition, nominal capacity (PE), total surface area of filters (m<sup>2</sup>), nominal ratio (m<sup>2</sup> PE<sup>-1</sup>), hydraulic and organic loads on the operating bed (cm d<sup>-1</sup> and g BOD<sub>5</sub> m<sup>-2</sup> d<sup>-1</sup>).

For statistical data analyses and visualisation, Pearson correlation coefficients and Principal Component Analysis (PCA) were performed using the R software package v 3.3.2.

## RESULTS AND DISCUSSION

### I. Performance evaluation

The distributions of the different analytical parameters at inlet/outlet of studied treatment plants are shown in Figure 2. Despite various general characteristics (the process type, the dimension, the age of the plant and possible particularities of each territory) and non-negligible variations of inlet effluent concentrations, the performance of the selected plants were good and stable. The average removal efficiency for TSS, BOD<sub>5</sub>, COD, KN, TN and TP were found to be 98.1%, 98.1%, 96.5%, 91.2%, 96.2%, 61.6% and 53.8%, respectively. Those observations were comparable to classical performance of French VFCW (Morvannou et al., 2015; Paing et al., 2015).

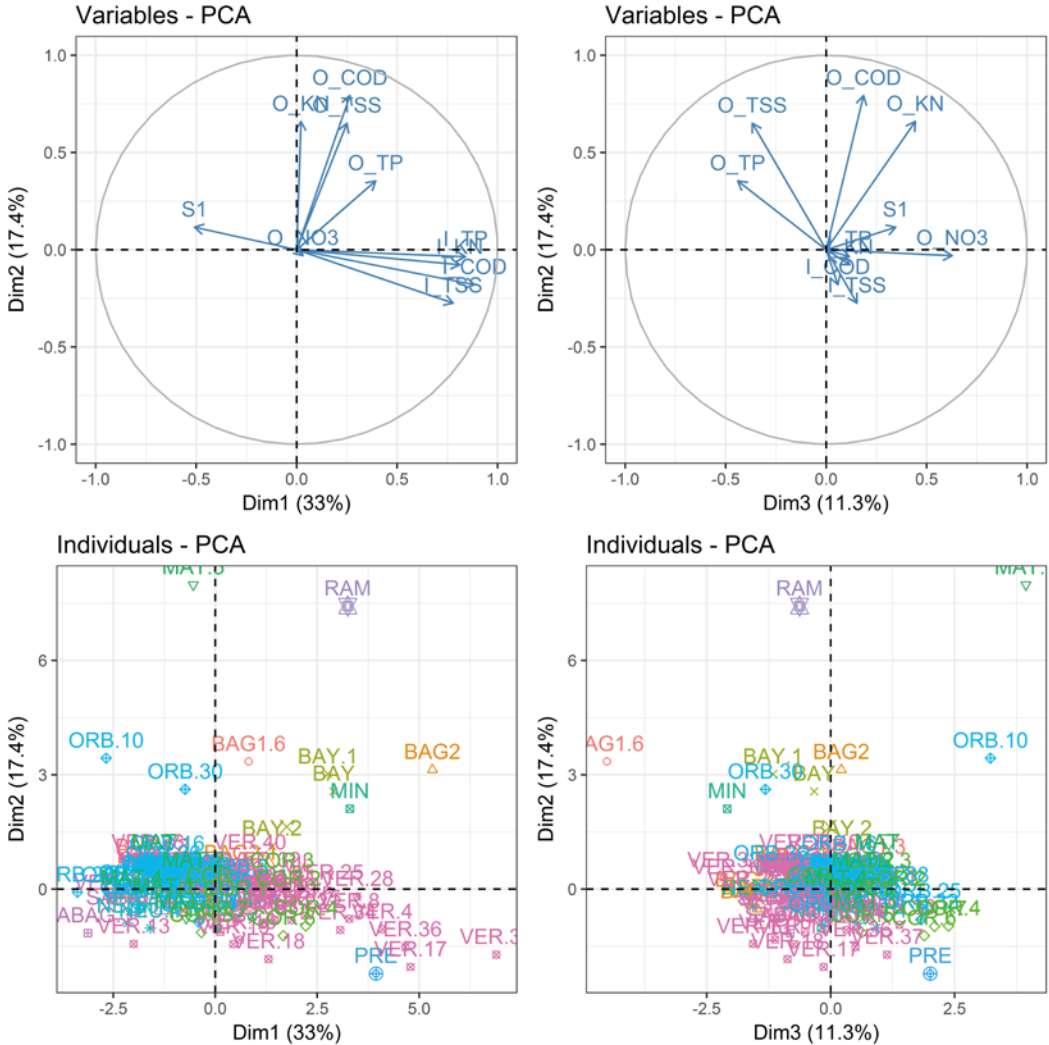


**Figure 2.** Compilation of inlet/outlet parameters of treatment performance gathered from different monitoring of 14 full-scale French VFCW treatment plants integrating or not additional treatments.

As expected nutrients were well retained and/or removed along the treatment chain. Outlet TSS, COD and BOD<sub>5</sub> concentrations were found to be very homogenous. The possible influence of the additional treatments was not very visible. However small disparities observed in the concentrations of TP, TN, KN, NO<sub>3</sub><sup>-</sup> and NH<sub>4</sub><sup>+</sup> at outlet of the treatment plants compared to TSS, COD and BOD<sub>5</sub> could be in part attributed to the difference of the treatment chain. More data would be necessary to explore the actual influence of the additional treatments and verify previous results obtained at pilot-scale (Kim et al., 2015a, b).

**II. Principal Component Analysis of the dataset**

In order to better detect possible differences in the performance of the treatment plants, a Principal Component Analysis (PCA) was performed. Preliminary study (results not shown) allowed to select 10 relevant variables namely: S1 (total surface of VFCW); inlet concentrations for TSS, COD, KN and TP; outlet concentrations for TSS, COD, KN, NO<sub>3</sub>-N and TP. Results showed that the first three principal components were statistically significant with Eigen values > 1 and accounted for 61,7% of the inertia (Figure 3).



**Figure 3.** PCA plots in the subspace defined by the first three principal components illustrating different parameters at inlet/outlet of 14 studied treatment plants: (top left) variables on dimension 1 vs 2; (top right) variables on dimension 3 vs 2; (bottom left) individual data on dimension 1 vs 2; (bottom right) individual data on dimension 3 vs 2.

Main observations obtained from this PCA were that the outlet concentrations of the treated effluents were relatively stable despite non-negligible variations of inlet concentrations and a positive correlation between outlet concentrations of COD and KN. Outlet concentration of nitrate nitrogen could not be well represented by available dataset for the moment.

Individuals PCA highlighted particular parameters at inlet/outlet of treatment plants. Effluents from RAM and MAT were found to be particularly different from others. Effluents from all other treatment plants were very similar with few disparities for ORB, BAY, BAG1, BAG2 and MIN in a less extent. VER which was the treatment plant with the highest number of monitoring by 24h composite sampling exhibited horizontal spread of individual data on dimension 1 vs 2 highlighted the changes of the quality of the inlet wastewater with time.

## CONCLUSIONS

The compilation of data from several monitoring (in total 135 of 24h samplings) of 14 full-scale French VFCW treatment plants was conducted to compare the treatment efficiencies with respect to the variations in the inflow wastewater composition. The results showed a relatively high homogeneity in the quality of the effluents released into the environment from the treatment plants, regardless of the fluctuations observed in the quality of the inlet wastewater. This observation underlined the robustness of the treatment operations conducted in the different configurations of the plants.

The data gathered in this study should provide relevant information related to the possible relationships between the characteristics of the treatment plants, their treatment performance and the properties of their surface sludge layer, which controls at least in part the efficiency of the treatment.

## REFERENCES

- Carvalho, P. N., Arias, C. A. & Brix H. (2017) Constructed Wetlands for Water Treatment: New Developments. *Water*, **9**(6), 397.
- Kania, M., Gautier, M., Aubin, J.B., Michel, P. & Gourdon, R. (2016) Comparative characterization of sludge surface layer samples from different types of VFCWs plants. *Proceeding of the 14th International Conference Wetland Systems for Water Pollution Control*, Gdańsk, Poland, September 4-9, 11p.
- Kim, B., Gautier, M., Prost-Boucle, S., Molle, P., Michel, P., & Gourdon, R. (2014) Performance evaluation of partially saturated vertical-flow constructed wetland with trickling filter and chemical precipitation for domestic and winery wastewaters treatment. *Ecol. Eng.*, **71**, 41–47.
- Kim B., Gautier M., Molle P., Michel P. & Gourdon R. (2015a) Influence of the water saturation level on phosphorus retention and treatment performances of vertical flow constructed wetland combined with trickling filter and FeCl<sub>3</sub> injection. *Ecol. Eng.*, **80**, 53-61
- Kim B., Gautier M., Olvera Palmaa, G., Molle P., Michel P. & Gourdon R. (2015b) Pilot-scale study of vertical flow constructed wetland combined with trickling filter and ferric chloride coagulation. Influence of irregular operational conditions. *Water Sci. Technol.* **71**(7), 1088-96.
- Millot Y., Troesch S., Esser D., Molle P., Morvannou A., Gourdon R. & Diederik P.L. R. (2016) Effects of design and operational parameters on ammonium removal by single-stage French vertical flow filters treating raw domestic wastewater. *Ecol. Eng.*, **97**, 516-23.



Molle, P. (2014) French vertical flow constructed wetlands: a need of a better understanding of the role of the deposit layer. *Water Sci. Technol*, **69**(1), 106–112.

Morvannou, A., Forquet, N., Michel, S., Troesch, S., & Molle, P. (2015) Treatment performances of French constructed wetlands: results from a data base collected over the last 30 years. *Water Sci. Technol*, **71**(9), 1333–1339.

Morvannou, A., Troesch, S., Esser, D., Forquet, N., Petitjean A. & Molle, P. (2017) Using one filter stage of unsaturated/saturated vertical flow filters for nitrogen removal and footprint reduction of constructed wetlands. *Water Sci. Technol*, **76**(1), 124-133.

Paing, J., Guilbert, A., Gagnon, V. & Chazarenc, F. (2015) Effect of climate, wastewater composition, loading rates, system age and design on performances of French vertical flow constructed wetlands: A survey based on 169 full scale systems. *Ecol. Eng*, **80**, 46-52.

Wu S., Kusch P., Brix H., Vymazal J. & Dong R. (2014) Development of constructed wetlands in performance intensifications for wastewater treatment: A nitrogen and organic matter targeted review. *Water Research*, **57**, 40-55.

# The key factors of building a microbial fuel cell in a pilot-scale constructed wetland

Ref # S2SMALL-04638

C. Tang<sup>1,2</sup>, L. Xu<sup>2</sup>, C. Kang<sup>2</sup>, Y.Q. Zhao<sup>1,2\*</sup>

<sup>1</sup> Key Laboratory of Subsurface Hydrology and Ecology in Arid Areas, Ministry of Education, Chang'an University, Xi'an 710054, PR China

<sup>2</sup> UCD Dooge Centre for Water Resources Research, School of Civil Engineering, University College Dublin, Belfield, Dublin 4, Ireland

\* Corresponding Author: yaqian.zhao@ucd.ie

**Keywords:** Bioelectricity generation, Constructed Wetlands, Microbial fuel cell

## INTRODUCTION

Constructed wetland (CW) is a kind of environmental friendly technology for wastewater treatment. Pollutants in many kinds of wastewater can be removed by CWs efficiently (Vymazal 2009). Microbial fuel cell (MFC) is a developing technology that generating electric power depended on electricity generating microbes. Waste water treated by MFC can be regarded as energy saving strategy in waste water treatment. The integrated system of microbial fuel cell-constructed wetland (MFC-CW) is a promising two-prong technology for wastewater treatment and simultaneous bioenergy generation (Yadav 2012). Therefore, maintenance of desirable conditions for MFC is very important.

According to basic principle of MFC, it's essential to build a potential gap between anode and cathode in MFC. In up-flow CW, the potential of water body keeping reducing because of low level of dissolved oxygen (DO). Water body on the top level where embedded cathode in CW contact with air directly and oxygen in the air may increase the potential of water body (Zhao 2013). Increasing and maintaining the potential of cathode compartment is one of the key factors for building MFC in CW.

Increased studies have reported the enhanced performance of MFC-CW. Up to now, lab-scale MFC-CW with net liquid volume fewer than 30L were built in most of these studies (Fang 2016; Xu 2016). The size of MFC-CW must to be enlarged for practical application. Pilot-scale MFC-CW is one of important fields to be studied in the future.

## MAIN METHODS

A pilot-scale MFC-CW was built in a plastic bucket with the size of 330mm in length and width, 800mm in height. CW was designed as the up-flow mode while dewatered alum sludge (DAS) from drinking water treatment plant was employed as the wetland substrate. Gravel in diameter of 50mm in the bottom of CW was the support medium for influent distribution. Substrate layer was on the top of support medium with 700mm depth. The net liquid volume of MFC-CW was 30L. Synthetic waste water (480mg/L COD, 30mg/L ammonium, 24mg/L phosphate) was feed continuously from bottom of CW by a peristaltic pump and went out from the top with hydraulic retention time (HRT) of 1.5 days.

MFC was consist of four anodes and one cathode. All of anodes were made of stainless steel mesh (SSM) and the cathode was made of SSM attached carbon felt. Four anodes of MFC embedded in different depths (600, 500, 400, 300mm for Anode 1, 2, 3, 4) in CW. The cathode was curved to reversed U shape and was fixed on the top of CW. Anodes were connected to cathodes with insulated copper wires through a 12.6K  $\Omega$  external resistor. There was a Water flow recirculation from interface of water and air to the top of cathode electrode. Air sparger was installed under cathode section as optional aeration. The MFC-CW was operated in three conditions in cathode section: 1) circulation of wastewater flow in cathode section; 2) aeration in cathode section; and 3) circulation with aeration in cathode section. MFC-CW operated without wastewater flow circulation and aeration in cathode section was regarded as control. Voltage across the external resistor was measured daily using a handheld multimeter. Potentials of electrodes were measured by a reference electrode (Ag/AgCl reference).

## MAIN RESULTS

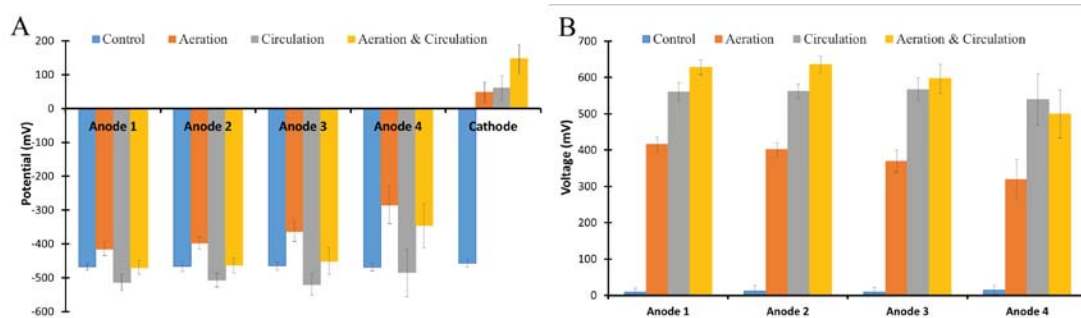
MFC-CW was running under continuous flow mode for more than 200 days. The potentials of each electrode and voltage drop across each resistor under different cathode conditions are shown in Fig. 1. The potentials of all anodes and cathode were similar in control system (Fig. 1A). Potentials of all electrodes under -400mV show that the whole system was in anaerobic environment (Oon 2015). There was no obvious difference of potential gap between anodes and cathode. Voltage between any anodes and cathode was below 100 mV even in open circuit. Heterotrophic microbe was growing up on cathode electrode and interface of water and air after one week after CW started running. The microbe had a negative affect for maintaining low voltages between anodes and cathode in control system. So it's very hard to build MFC in the control system.

The electrical potential of cathode increased dramatically after aeration was added. Increasing DO concentration could level up potential of water body in cathode section. Each anode was connected to cathode individually. The maximum voltage was generated between Anode 1 and cathode which is close to 400mV because Anode 1 situated in the lowest level among all anodes. DO diffusion by aeration could affect desirable reducing environment of anodes section which situated closer to aeration position. The anodes in higher level got higher electrical potential (Fig. 1A). This leaded a decreasing trend of voltage generated in different anodes between the cathode which shown in Fig 1B. There was a descending order of voltage generation from Anode 1 to Anode 4. The fluctuation of voltage between Anode 4 was larger than Anode 1 also proved the effect of aeration.

Water flow circulation in cathode section increased potential of cathode without affect any anodes. The potentials of all anodes were keeping in -500mV similarly while cathode remained higher. Potentials of Anode 1,2,3 kept in same level all the time which slightly lower than Anode 4 (Fig. 1A). Voltages between different anodes and cathode were much higher than aeration. The maximum voltage generated in Anode 1 was about 560mV (Fig. 1B). In this operating condition, cathode surface was kept damp. Protons could move everywhere on cathode through water flow. Damped cathode enlarged active contact area of water body and oxygen which following basic principles of MFC. Oxygen could be reacted with protons on surface of cathode more easily than aeration because of larger reactive surface area. On the other hand, continuous water flow circulation in cathode section promoted oxygen diffusion but not as strong as aeration. So potential of cathode kept in 50mV which regarded as oxidized redox condition. Circulation didn't affect redox conditions

of anodes too much even Anode 4 which the potentials of anodes were close to control system or even lower. All of these completed active circuit of MFC in CW that enhanced bio-electrical reaction.

Aeration and water flow circulation have synergistic effect on enhancing potential of cathode. Potential of cathode increased to maximum which was about 150mV while aeration and circulation were running simultaneously (Fig. 1A). Compared to aeration condition, potentials of all four anodes were lower because of stronger MFC reaction promoted by aeration and circulation, but higher anodic potentials than circulation system as oxygen diffusion by aeration. Maximum voltage was 680mV which generated between Anode 1 and cathode. Voltage between Anode 4 and cathode in circulation condition was larger in aeration and circulation (Fig. 1B). Potential fluctuation of Anode 4 was larger than other three anodes in the three conditions (aeration, circulation, aeration and circulation). These reflect aeration has negative effect on MFC reaction where anode is close to aeration position.



**Figure 1.** Potential (A) and voltage (B) generation of each anode at different cathode conditions

## CONCLUSIONS

Overall, the results showed: (i) With regard to the different depth of the anodes in vertical flow CW, redox condition of cathode in the CW remained the same; (ii) Both aeration and circulation could bring about the favourable operation of CW-MFC. (iii) Aeration added with circulation in cathode section in CW-MFC could lead to the highest voltage (680mV) generation in this study; (iv) Circulation damped cathode surface that enlarging active area and complete better circuit of MFC. Aeration has negative effect on anodes where close to it which lead higher and more fluctuation in anodic potential.

## REFERENCES

- Fang, Z., Song, H., Yu, R., & Li, X. 2016 A microbial fuel cell-coupled constructed wetland promotes degradation of azo dye decolorization products. *Ecological Engineering*, 94, 455-463.
- Oon, Y. L., Ong, S. A., Ho, L. N., Wong, Y. S., Oon, Y. S., Lehl, H. K., & Thung, W. E. 2015 Hybrid system up-flow constructed wetland integrated with microbial fuel cell for simultaneous wastewater treatment and electricity generation. *Bioresour Technol*, 186, 270-275.
- Vymazal, J. 2009 The use constructed wetlands with horizontal sub-surface flow for various types of wastewater. *Ecological Engineering*, 35(1), 1-17.

Xu, L., Zhao, Y. Q., Doherty, L., Hu, Y. S., & Hao, X. D. 2016 Promoting the bio-cathode formation of a constructed wetland-microbial fuel cell by using powder activated carbon modified alum sludge in anode chamber. *Scientific reports*, 6,1- 9.

Yadav, A. K., Dash, P., Mohanty, A., Abbassi, R., & Mishra, B. K. 2012 Performance assessment of innovative constructed wetland-microbial fuel cell for electricity production and dye removal. *Ecological Engineering*, 47, 126-131.

Zhao, Y., Collum, S., Phelan, M., Goodbody, T., Doherty, L., & Hu, Y. 2013 Preliminary investigation of constructed wetland incorporating microbial fuel cell: Batch and continuous flow trials. *Chemical Engineering Journal*, 229, 364-370.

# Peat as substrate for small-scale constructed wetlands polishing secondary effluents from municipal wastewater treatment plant

Ref # S2SMALL-99808

M. Jin<sup>1</sup>, P. Champagne<sup>2\*</sup>, J. Carlos<sup>1</sup>, G. Hall<sup>1</sup>

<sup>1</sup> Civil Engineering, Queen's University, 99 University Ave., Kingston, Canada

<sup>2</sup> Civil Engineering/Chemical Engineering, Queen's University, 99 University Ave., Kingston, Canada

\* Presenting Author: pascale.champagne@queensu.ca

**Keywords:** Algae, Constructed Wetland, Nutrients, Organics, pH, Substrate

## INTRODUCTION

Constructed wetlands are considered to be a green and naturalized passive wastewater treatment technology, and has been used to treat different kinds of wastewaters for decades, such as domestic or municipal wastewater (Jácome et al., 2016; Pandey et al., 2013), industrial wastewater (Paing et al., 2015; Saeed & Sun, 2013), river and lake water (Martín et al., 2013; Mawuli et al., 2015; Rai et al., 2013; Saeed et al., 2016), groundwater (Stefanakis et al., 2016), landfill leachate (Sim et al., 2013), highway runoff (Zhao et al., 2016), and airport runoff (Murphy et al., 2015). They take advantage of many of the same processes that occur in natural wetlands, but do so in a more controlled system (Kadlec & Wallace, 2008). Up to date, surface flow and subsurface flow constructed wetlands are the two main categories that separate constructed wetland applications (Pandey et al., 2013). In recent years, subsurface flow constructed wetlands have been extensively studied, as the treatment efficiency (in terms of pollutant mass removal per unit area) is typically higher than that of surface flow wetlands. Alternative influent feeding modes, such as tidal flow, step feed, and upflow mode, have also been invented to further enhance removal performance. However, free water surface (surface flow) constructed wetlands represent the oldest wetland configuration, and have proved to be an effective treatment method for a variety of wastewaters. Despite the relatively low treatment efficiency compared to subsurface flow constructed wetlands, the low construction cost and low maintenance requirements are desirable for small municipalities with restricted financial ability, especially when dealing with micro-polluted wastewater or secondary effluent from a treatment plant.

Peat is an organic substrate with a dynamic structure containing mostly humic substances. Previous studies (Gunes, 2007; Kasak et al., 2015; Lizama Allende et al., 2012; Saeed et al., 2012) have been done applying peat in constructed wetlands, but most of them only focus on the nutrients removal. As an organic substrate with acidic properties, peat could be used to attenuate high pH wastewater such as alkaline mine drainage and algal-induced elevated pH secondary effluent. A study conducted by Jin et al. (2017) concluded that peat is a great option in terms of attenuating wastewater pH level by using a wetland system.

*T. latifolia* (Cattail, Broad-leaved cattail) is a common emergent plant which has been reported in CWs from all continents except Central and South America, and it is the most widely presented vegetation species across North America (Vymazal, 2013). They can grow aggressively and tend to out-compete other species planted in constructed wetlands. However, their relatively short growing period and advanced extensive branching horizontal rhizome system are ideal for constructed wetlands as they can significantly reduce the nutrients



concentrations through nutrient uptake and increase the rate of sedimentation by reducing current velocity.

Quite a few comparative studies of constructed wetlands were published to compare the treatment performance attained by applying different substrates or vegetation, and most of these studies were focused only on the comparison between either substrate or vegetation solely (Calheiros et al., 2009; Saeed & Sun, 2011; Saeed & Sun, 2013; Schierano et al., 2016; Sehar et al., 2015; Toscano et al., 2015). Very few comparative studies were concentrated on comparing the effects of substrate and vegetation both alone and together. This kind of study could identify the role that substrate and vegetation plays in constructed wetland applications as well as further understand the treatment process that occurs in wetlands.

The objective of this paper was to assess the ability of peat and *T. latifolia* to attenuate the secondary effluent with elevated pH levels in small-scale surface flow constructed wetlands to attenuate the secondary effluent with elevated pH levels at the Amherstview Water Pollution Control Plant (WPCP) in southern Ontario, Canada. The individual treatment contributions of *T. latifolia* L. and peat to this treatment system, as well as the treatment efficiency of the two components combined, were also analyzed and compared in this study. One outcome of this research is to provide design recommendations for those who would like to both reduce the nutrient concentrations and pH level in surface flow constructed wetlands.

## **METHODS**

There are three consecutive wastewater stabilization ponds following the extended aeration biological treatment cells at the Amherstview WPCP (Figure 1), and the wastewater applied in this study was from the influent of the second wastewater stabilization pond, which was deemed to be a secondary effluent from the treatment plant. The wastewater was pumped into three wetland reactors using a Pentair centrifugal pump at the field.

Three outdoor small-scale surface flow wetland reactors were built on-site at the Amherstview WPCP, and each wetland reactor was constructed within an open top cylindrical high-density polyethylene (HDPE) tank with a volume of approximately 6485L (diameter: 2.13m, height: 1.82m). Three 5cm holes were made at three separate sides of each tank using a hole saw to act as the inlet, outlet, and drain. The height of the inlet, outlet, and drain of each reactor are 200mm, 600mm, and 50mm, respectively. The inlets and outlets were located opposite to each other, and the drain was located at the other side of the tank.

Locally available substrate and vegetation were used in this study. Sphagnum peat moss was purchased from the Home Depot in Kingston, Canada, and was applied in this experiment as substrate that could potentially attenuates high pH effluents. The porosity was determined by dividing the volume of water required to fill the void spaces in the substrate by the volume of the substrate. *Typha latifolia* was collected from the Bayview Bog Field Site (BBFS), which is a natural wetland complex located in Loyalist Township and governed by the Cataraqui Region Conservation Authority (CRCA). They were transplanted to the wetland reactors immediately after the collection. It was recognized that because the *Typha latifolia* was transplanted from a natural wetland, some of the native soil was inevitably brought to the reactors to hold down the plants during the transplantation process. The amount of native soil in the reactor was minimized by cleaning off the roots of the stalks as well as possible without causing damage.

The configurations of each wetland reactor are listed above.

Treatment 1 (T1) - Sphagnum peat moss and *Typha latifolia* treatment

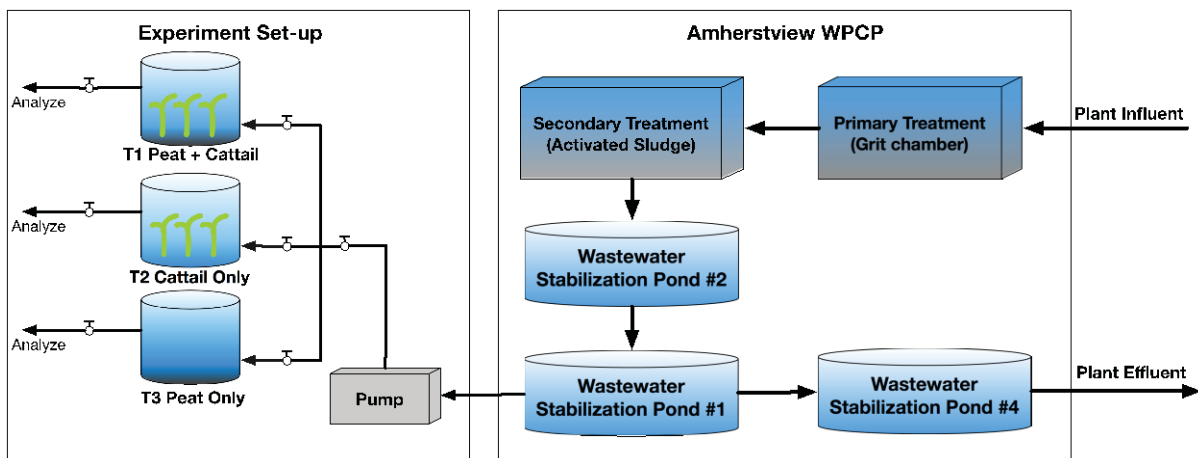
Treatment 2 (T2) - *Typha latifolia* only treatment

Treatment 3 (T3) - Sphagnum peat moss only treatment

Reactor T2 contained Sphagnum peat moss substrate only, and the height of the substrate level was 20 cm. Reactor T3 contained *Typha latifolia* only, and approximately 20 stalks of *Typha latifolia* were transplanted to this reactor. Reactor T1 contained both a 20 cm Sphagnum peat moss layer as well as approximately 20 stalks of *Typha latifolia* in the reactor. All three wetland reactors had a same free water level of 40 cm on top of either substrate or bottom of the tank (Figure 1 and 2).



**Figure 1.** Experiment set-up at the Amherstview WPCP



**Figure 2.** Schematic design of the experiment and treatment processes flow of the Amherstview WPCP

Wastewater was pumped into the system from the influent of the second wastewater stabilization pond of the Amherstview WPCP using a Pentair centrifugal pump. Wastewater flowed from this pump and distributed equally into the three wetland reactors, which were set up in parallel. 2" and 1" polybutylene pipes were used to connect the influent and effluent tubing near the location of the reactors, and 1" PVC pipes were applied to connect the polybutylene pipes and the reactors. A ball valve was placed before the inlet and after the outlet of each wetland reactor to control the flow.

The hydraulic residence time (HRT) of each cell was set to a constant value of 2.5 days for the duration of the experiment. After the establishment of the substrates and vegetation, the systems were operated and fed with secondary effluent wastewater. The experiments were

separated into two seasons as the systems were frozen during the entire winter, and sampling was not available in that period. In the first experimental season, the system was fully operational on September 29th, 2016, and samples were collected between October 3rd and November 17th, 2016. In the second experimental season, the system was fully operational on May 10th, 2017, and data were collected between May 17th and July 5th, 2017.

During experimental analyses, wastewater samples were collected on a bi-weekly basis every Monday and Thursday during the first period of the experiment, and on a weekly basis every Wednesday during the second period of the experiment. Samples were kept in a refrigerator at 4°C until all laboratory testing could be completed, and were analysed in duplicate. For each sample, analysis was carried out for pH, chemical oxygen demand (COD), ammonium (NH<sub>4</sub>-N), nitrate (NO<sub>3</sub>-N), phosphate (PO<sub>4</sub>-P), total nitrogen (TN), and total phosphorous (TP). During the second period of the experiment, alkalinity, and total suspended solids (TSS) were also measured. pH was analysed using a Fisher Scientific accumet XL60 benchtop meter with Fisher Scientific pH probes. NH<sub>4</sub>-N, NO<sub>3</sub>-N, and PO<sub>4</sub>-P concentrations were analyzed using a Hach model DR 2800 spectrophotometer according to APHA Standard Methods. TN was measured using the Hach TNT Persulfate Digestion Method no. 10072. TP was measured using the Hach PhosVer® 3 with Acid Persulfate Digestion Method 8190. COD was analyzed with the same spectrophotometer according to APHA Standard Methods.

Normality tests were performed to verify whether the distribution of data approximated normality. Both graphical (histogram and normality plot) and statistical (skewness and kurtosis) methods were used to determine the data distribution. When data approximated normality, the data were analyzed through one-way analysis of variance (ANOVA) to illustrate the statistically significant difference (p value < 0.05) of the means across all treatments at a significant level of 0.05. When significant difference was observed, post-hoc comparison analysis (Bonferroni test) was performed to determine the statistically significant difference between treatments at a significant level of 0.05 as well. When the data did not approximate normality was observed, a non-parametric statistical analysis, Mann-Whitney test, was performed to determine the variance between treatments.

## MAIN RESULTS

Table 1 and Table 2 provide the mean effluent pollutant concentrations and mean pollutant removal efficiency in three wetland reactors during season 1 and season 2, respectively. Standard deviations are indicated in the bracket. The average HRT is 2.5 days, and the average influent hydraulic loading rate is 0.16 m<sup>3</sup>/m<sup>2</sup>d for each reactor.

Overall, the results showed pH can be effectively reduced in all reactors in both experiment seasons. Higher NO<sub>3</sub>-N and TN removal percentages were recorded in season 2 compared to season 1. Also, PO<sub>4</sub>-P and TP removal efficiencies were significantly enhanced in reactors where peat is presented in season 2 as well. However, due to the low influent COD concentrations, introduction of peat and cattails increased the effluent COD levels in all reactors. The wetland achieved better overall performance across the reactors in season 2 compared to season 1, as more acclimate time might be required at the beginning of the experiment to allow the reactors to perform. Detailed performance comparison of the removal of each individual pollutant is discussed in the following sections.

Table 1 and Table 2 showed that pH can be effectively reduced across the reactors in both experiment periods. T3 demonstrated the best overall pH attenuation performance as its reduced the pH from 7.43 to 6.39 and 8.73 to 7.08 in two treatment seasons, respectively. Promising pH attenuation was showed in T1 in the first treatment season, but the performance went down in the second treatment season compared to other treatments, though it is still able

to reduce the pH from 8.73 to 7.90. The pH attenuation performance was stable in T2 and T3, and the pH level of both increased approximate 0.7 when the influent pH level rise from 7.43 to 8.73. However, there was a significant pH increment in T1 as the pH level increased by 1.65.

**Table 1.** Mean pollutant removal performances across the wetland reactors (Treatment season 1). Please note that the standard deviation of pollutant concentration is indicated in the bracket

	Unit	Influent	Peat + Cattails		Cattails		Peat	
			T <sub>1</sub>		T <sub>2</sub>		T <sub>3</sub>	
			Effluent Conc.	Efficiency %	Effluent Conc.	Efficiency %	Effluent Conc.	Efficiency %
pH		7.43 (0.41)	6.25 (1.09)		7.12 (0.24)		6.39 (1.27)	
COD	mg/L	14.15 (14.55)	49.15 (39.59)		15.90 (5.66)		44.02 (42.24)	
NH <sub>4</sub> -N	mg/L	0.10 (0.08)	0.23 (0.22)		0.09 (0.04)	10%	0.22 (0.22)	
NO <sub>3</sub> -N	mg/L	0.83 (0.32)	0.61 (0.26)	26.5%	0.52 (0.20)	37.3%	0.71 (0.31)	14.4%
TN	mg/L	8.75 (2.80)	8.21 (2.11)	6.17%	5.14 (2.58)	41.2%	8.68 (1.56)	0.8%
PO <sub>4</sub> -P	mg/L	0.71 (0.13)	0.70 (0.28)	1.4%	0.59 (0.13)	16.9%	0.82 (0.22)	
TP	mg/L	2.90 (1.83)	3.42 (2.29)		2.27 (2.47)	18.2%	3.74 (1.95)	

**Table 2.** Mean pollutant removal performances across the wetland reactors (Treatment season 2). Please note that the standard deviation of pollutant concentration is indicated in the bracket

	Unit	Influent	Peat + Cattails		Cattails		Peat	
			T <sub>1</sub>		T <sub>2</sub>		T <sub>3</sub>	
			Effluent Conc.	Efficiency %	Effluent Conc.	Efficiency %	Effluent Conc.	Efficiency %
pH		8.73 (0.11)	7.90 (0.90)		7.85 (0.86)		7.08 (0.36)	
DO	mg/L	6.00 (1.13)	6.95 (1.48)		7.05 (2.19)		6.55 (0.07)	
COD	mg/L	12.20 (7.60)	49.00 (13.62)		24.40 (4.76)		49.80 (13.13)	
NH <sub>4</sub> -N	mg/L	0.20 (0.32)	0.97 (0.33)		0.47 (0.36)		1.69 (0.53)	
NO <sub>3</sub> -N	mg/L	7.50 (1.26)	1.90 (1.64)	74.7%	1.56 (1.67)	79.2%	1.90 (1.18)	74.7%
TN	mg/L	10.14 (0.80)	2.59 (1.85)	74.5%	1.73 (0.99)	82.9%	3.33 (1.31)	67.2%
PO <sub>4</sub> -P	mg/L	0.75 (0.14)	0.31 (0.22)	58.7%	0.67 (0.23)	10.7%	0.38 (0.21)	49.3%
TP	mg/L	1.29 (0.33)	0.77 (0.32)	40.3%	1.13 (0.25)	12.4%	0.87 (0.27)	32.6%

Due to the natural of shallow wastewater stabilization pond, which aerobic condition is prevailed at the Amherstview WPCP, NH<sub>4</sub>-N can be easily oxidized to nitrite (NO<sub>2</sub>-N) or NO<sub>3</sub>-N. Therefore, influent NH<sub>4</sub>-N concentrations was consistently low throughout the seasons. As a result, removal of NH<sub>4</sub>-N in the following treatment process is very hard to achieve. In this experiment, only T2 was able to further remove the NH<sub>4</sub>-N in season 1, and only 10% of removal efficiency was registered. Other than that, NH<sub>4</sub>-N concentrations were increased in all other scenarios. Dissimilatory nitrate reduction is a reduction process that could reduce NO<sub>2</sub>-N and NO<sub>3</sub>-N to NH<sub>4</sub>-N under carbon-rich environments (Kadlec & Wallace, 2008), and this process could well occur in reactors with peat.

Despite the limited ability to remove  $\text{NH}_4\text{-N}$  from the secondary effluent, high  $\text{NO}_3\text{-N}$  and TN removal efficiency were recorded. Maximum  $\text{NO}_3\text{-N}$  and TN removal efficiency of 37.3% and 41.2% in season 1, and 79.2% and 82.9% in season 2 were achieved across the reactors, respectively. The results indicated that plants have bigger impact than substrate in term of nitrogen removal in wetland reactors. The nitrogen removal performance of T1 and T2 was always better than T3. In a typical wetland reactor, denitrification and plant uptake are two main pathways to remove  $\text{NO}_3\text{-N}$  and TN, and it seems plant uptake could significantly enhanced nitrogen removal in this study. Although no negative  $\text{NO}_3\text{-N}$  and TN removal efficiency was observed, nitrogen leaching might still occur during the season 1 as both T1 and T3 had very low TN removal compared to T2. One possible explanation could be the free nitrogen attached to the peat was flushed to the reactors during the first season, which comprises the nitrogen removal ability in T1 and T3 in the first season. In addition to leaching, cold climate might also contribute the low nitrogen removal in constructed wetland reactors in the first season as both  $\text{NO}_3\text{-N}$  and TN had significant higher removal efficiency in season 2 than season 1 across all reactors. Several studies have reported low nitrogen removal efficiency in cold climate, and the result from our study in accord with their results. In season 1, most of the transplanted cattails began to switch to the dormant status, therefore, decaying plant materials accumulated in the reactors could release nutrient back to the water column that reduce the removal efficiency as well. However, season 2 was the growing season for cattails, and they required more nutrients from water to support their growth, which enhance the nitrogen removal.

The overall phosphorous removal efficiency was weak in season 1, and only T2 manage to reduce both  $\text{PO}_4\text{-P}$  and TP concentrations. T1 was only able to remove  $\text{PO}_4\text{-P}$  by 1.4%, and T3, even worse, had higher effluent concentration than influent. The introduction of peat was responsible for the low removal efficiency in the first season as the mobile phosphorous that loosely attached to the peat can be easily released to water phase, which contributed to a higher effluent phosphorous concentration. The decaying plant material might also release phosphorous to the effluent as well, but this has less impact to the reactors compared to peat as T2 was able to remove both  $\text{PO}_4\text{-P}$  and TP from the reactor in the first season. However, in season 2, T1 and T3 were more effective than T2, and they were able to reduce both  $\text{PO}_4\text{-P}$  and TP with a maximum  $\text{PO}_4\text{-P}$  and TP removal efficiency at 58.7% and 32.7%, respectively.

Peat is well-known to be a phosphorous sink, and this porous material has strong phosphorous retention ability benefits from their physical and chemical properties. Our previous bench-scale study (Jin et al., 2017) demonstrated that both  $\text{PO}_4\text{-P}$  and TP can be effectively removed by wetland configuration reactor under different HRT and organic loadings. The phosphorous removal results in accordance with other studies that seasonal variations do occur, and the most efficient reduction occurs in summer, whereas the least efficient reduction occurs in winter. Also, various forms of phosphorous exists (orthophosphates, organic soluble phosphates, and particulate phosphorous), and not all of them were removed in the same way by plants and substrates (Ciria et al., 2005).

The influent secondary effluent from wastewater stabilization pond has a relatively low COD level, and all reactors were unable to further remove COD concentrations. The results indicated that the presence of peat had a bigger impact than cattails. T2 only slightly increased the COD level in season 1, whereas T1 and T3 significantly rise the COD level to 49.15 mg/L and 44.02 mg/L, respectively. The COD level was maintained in season 2 and only slightly increased occurs in T3. Although peat properties various depends on the location they come from, typically, peat has a high organic as well as carbon contents as a result of the formation of peat. Therefore, leaching organic and carbon contents will inevitably happen when you apply organic substrate (peat) in wetland reactors. Because the influent COD level is quite



low in this study, the effluent COD concentrations were significantly higher than influent. The weak ability to remove COD by peat was also concluded by Kõiv et al. (2009), who employed a peat-filled substrate filter to treat landfill leachate and municipal wastewater, and only 17% of COD removal efficiency was recorded when influent COD concentration well above 500 mg/L. Despite the inability to directly remove COD from wastewater, peat can provide additional carbon source to facilitate the removal of nitrogen as additional carbon is required by denitrification process. Our results proved that additional source of carbon did enhance the nitrogen removal efficiency, especially in season 2, as the minimum TN removal efficiency of 67.2% was achieved across all reactors.

## CONCLUSIONS

Overall, all treatments in this study successfully demonstrated their ability to effectively attenuate high pH effluents under both experiment seasons. The presence of cattails had great influence in term of nitrogen removal, whereas the presence of peat had much more impact on phosphorous removal. Due to the low organic loading, COD removal was not achieved in all treatment in both experimental seasons. Climate conditions did affect the overall treatment performance of wetland reactors, and the reactors performed better in warmer conditions.

## REFERENCES

- Calheiros, C. S. C., Rangel, A. O. S. S., and Castro, P. M. L. (2009). Treatment of industrial wastewater with two-stage constructed wetlands planted with typha latifolia and phragmites australis. *Bioresource Technology*, 100(13), 3205-3213.
- Ciria, M. P., Solano, M. L., and Soriano, P. (2005). Role of macrophyte typha latifolia in a constructed wetland for wastewater treatment and assessment of its potential as a biomass fuel. *Biosystems Engineering*, 92(4), 535-544.
- Gunes, K. (2007). Restaurant wastewater treatment by constructed wetlands. *CLEAN – Soil, Air, Water*, 35(6), 571-575.
- Jácome, J. A., Molina, J., Suárez, J., Mosqueira, G., and Torres, D. (2016). Performance of constructed wetland applied for domestic wastewater treatment: Case study at boimorto (galicia, spain). *Ecological Engineering*, 95, 324-329.
- Jin, M., Champagne, P., and Hall, G. (2017). Effects of different substrates in the mitigation of algae-induced high pH wastewaters in a pilot-scale free water surface wetland system. *Water Science and Technology*, 75(1), 1-10.
- Kadlec, R. H., and Wallace, S. (2008). *Treatment wetlands* (2nd Edition ed.). CRC press, Florida.
- Kasak, K., Mander, Ü., Truu, J., Truu, M., Järveoja, J., Maddison, M., and Teemusk, A. (2015). Alternative filter material removes phosphorus and mitigates greenhouse gas emission in horizontal subsurface flow filters for wastewater treatment. *Ecological Engineering*, 77(0), 242-249.
- Kõiv, M., Vohla, C., Mõtsep, R., Liira, M., Kirsimäe, K., and Mander, Ü. (2009). The performance of peat-filled subsurface flow filters treating landfill leachate and municipal wastewater. *Ecological Engineering*, 35(2), 204-212.
- Lizama Allende, K., Fletcher, T. D., and Sun, G. (2012). The effect of substrate media on the removal of arsenic, boron and iron from an acidic wastewater in planted column reactors. *Chemical Engineering Journal*, 179, 119-130.
- Martín, M., Oliver, N., Hernández-Crespo, C., Gargallo, S., and Regidor, M. C. (2013). The use of free water surface constructed wetland to treat the eutrophicated waters of lake l'albufera de valencia (spain). *Ecological Engineering*, 50, 52-61.



- Mawuli, D., Xiaochang, W., Yucong, Z., Yuan, G., Jiaqing, X., and Yaqian, Z. (2015). Characteristics of nitrogen and phosphorus removal by a surface-flow constructed wetland for polluted river water treatment. *Water Science & Technology*, 71(6), 904-912.
- Murphy, C., Wallace, S., Knight, R., Cooper, D., and Sellers, T. (2015). Treatment performance of an aerated constructed wetland treating glycol from de-icing operations at a uk airport. *Ecological Engineering*, 80(0), 117-124.
- Paing, J., Serdobbel, V., Welschbillig, M., Calvez, M., Gagnon, V., and Chazarenc, F. (2015). Treatment of high organic content wastewater from food-processing industry with the french vertical flow constructed wetland system. *Water Science & Technology*, 72(1), 70-76.
- Pandey, M. K., Jenssen, P. D., Krogstad, T., and Jonasson, S. (2013). Comparison of vertical and horizontal flow planted and unplanted subsurface flow wetlands treating municipal wastewater. *Water Sci Technol*, 68(1), 117-123.
- Rai, U. N., Tripathi, R. D., Singh, N. K., Upadhyay, A. K., Dwivedi, S., Shukla, M. K., Mallick, S., Singh, S. N., and Nautiyal, C. S. (2013). Constructed wetland as an ecotechnological tool for pollution treatment for conservation of ganga river. *Bioresource Technology*, 148, 535-541.
- Saeed, T., Afrin, R., Muyeed, A. A., and Sun, G. (2012). Treatment of tannery wastewater in a pilot-scale hybrid constructed wetland system in bangladesh. *Chemosphere*, 88(9), 1065-1073.
- Saeed, T., Paul, B., Afrin, R., Al-Muyeed, A., and Sun, G. (2016). Floating constructed wetland for the treatment of polluted river water: A pilot scale study on seasonal variation and shock load. *Chemical Engineering Journal*, 287, 62-73.
- Saeed, T., and Sun, G. (2011). A comparative study on the removal of nutrients and organic matter in wetland reactors employing organic media. *Chemical Engineering Journal*, 171(2), 439-447.
- Saeed, T., and Sun, G. (2013). A lab-scale study of constructed wetlands with sugarcane bagasse and sand media for the treatment of textile wastewater. *Bioresource Technology*, 128, 438-447.
- Schierano, M. C., Maine, M. A., and Panigatti, M. C. (2016). Dairy farm wastewater treatment using horizontal subsurface flow wetlands with typha domingensis and different substrates. *Environmental Technology*, 1-7.
- Sehar, S., Sumera, Naeem, S., Perveen, I., Ali, N., and Ahmed, S. (2015). A comparative study of macrophytes influence on wastewater treatment through subsurface flow hybrid constructed wetland. *Ecological Engineering*, 81(0), 62-69.
- Sim, C. H., Quek, B. S., Shutes, R. B., and Goh, K. H. (2013). Management and treatment of landfill leachate by a system of constructed wetlands and ponds in singapore. *Water Sci Technol*, 68(5), 1114-1122.
- Stefanakis, A. I., Seeger, E., Dorer, C., Sinke, A., and Thullner, M. (2016). Performance of pilot-scale horizontal subsurface flow constructed wetlands treating groundwater contaminated with phenols and petroleum derivatives. *Ecological Engineering*, 95, 514-526.
- Toscano, A., Marzo, A., Milani, M., Cirelli, G. L., and Barbagallo, S. (2015). Comparison of removal efficiencies in mediterranean pilot constructed wetlands vegetated with different plant species. *Ecological Engineering*, 75(0), 155-160.
- Vymazal, J. (2013). Emergent plants used in free water surface constructed wetlands: A review. *Ecological Engineering*, 61, Part B(0), 582-592.
- Zhao, J., Zhao, Y., Xu, Z., Doherty, L., and Liu, R. (2016). Highway runoff treatment by hybrid adsorptive media-baffled subsurface flow constructed wetland. *Ecological Engineering*, 91, 231-239.

# The effect of nitrification-denitrification process in one single stage Vertical Flow Constructed Wetlands (VFCW) treating domestic wastewater.

Ruiz, H.<sup>1,2</sup>, Paing, J.<sup>2</sup>, Molle, P.<sup>3</sup>, Chazarenc, F.<sup>1</sup>

<sup>1</sup> Institut Mines Telecom Atlantique, GEPEA,UMR CNRS 6144, 4 rue Alfred Kastler 44307 Nantes, France (florent.chazarenc@mines-nantes.fr)

<sup>2</sup> Jean Voisin Company, Les Charmilles Z.A. les Poupinières, 37360 Beaumont-la-Ronce, France (joelle.paing@jean-voisin.fr)

<sup>3</sup> IRSTEA,UR MALY, 5 rue de la Doua, F-69100 Villeurbanne, France (pascal.molle@irstea.fr)

**Keywords:** Treatment wetlands, zeolite, unsaturated-saturated layer

## Introduction

The use of treatment wetlands (TWs) regarding domestic wastewater from small villages (less than 2000 p.e) has followed an exponential increase over the last decades in France. The classical French VFCW fed intermittently with raw wastewater consisting of two stages allows good performance removal in terms of TSS, COD and TKN, but is also known to have low denitrification rates.

The use of a combination of aerobic and anoxic/anaerobic conditions could improve the denitrification activity within TW system (Prigent et al., 2013). Furthermore, the use of reactive materials can increase the ammonium removal and improve nitrification for further denitrification process (Wen et al., 2012).

The aim of the study was to evaluate the efficiency of total nitrogen removal in VFCW combining unsaturated and saturated layers in one single stage. The use of zeolite in the upper part of the filter should enhance the ammonium removal by adsorption process and biological regeneration of zeolite could be achieved by nitrification process. The denitrification process will be influenced by the C/N ratio and the retention time in the saturated layer.

## Material and Methods

The experimental site is located on a full-scale CWs system (L'Encloître, France) which allows the use of real raw domestic wastewater. Experimental setup consisted of two pilot scale VFCW (2.3 m<sup>2</sup>), which were operated during 24 months. An unsaturated-saturated compact vertical flow pilot having gravel as a main filtration layer (Ø 2-4 mm) was compared to a compact vertical flow pilot filled with natural zeolite (Ø 2-5 mm) instead of gravel. Pilots were fed under regular feeding/resting periods (3½/7 days) and the nominal loading rate was of 300 g COD m<sup>-2</sup> d<sup>-1</sup> and 33 g.N.m<sup>2</sup>.d<sup>-1</sup> in the operating filter.

## Results and Discussion

Overall results show a good treatment efficiency of domestic wastewater by the two pilots with more than 90% and 85% removal rate in average for TSS and COD for both filters respectively. Results also showed an increase of 10% on TN and  $\text{NH}_4^+\text{-N}$  with the use of natural zeolite. The overall removal observed for zeolite pilot seems to be linked to the effect of the ion exchange and adsorption properties of zeolite.

## References

- Prigent, S., Paing, J., Andres, Y., Chazarenc, F. (2013) Effect of a saturated layer and recirculation on nitrogen treatment performances of a single stage vertical flow constructed wetland (VFCW). *Water Science & Technology* 68.7, 1461-1467.
- Silveira D., Belli Filho, P., Philippi L.S., Kim B., Molle P. (2015) Influence of partial saturation on total nitrogen removal in a single-stage French constructed wetland treating raw domestic water. *Ecological Engineering* 77, 257-264.
- Wen, Y., C. Xu, G. Liu, Y. Chen, and Q. Zhou, 2012, Enhanced nitrogen removal reliability and efficiency in integrated constructed wetland microcosms using zeolite: *Frontiers of Environmental Science and Engineering in China*, v. 6, p. 140-147.

**Parallel session 1 - State of the art small treatment systems**

**08:10-09:30**

Session chair: Pascal Molle

**436 - Small wastewater treatment plants in Austria – Technologies, management and training of operators**

LANGERGRABER Guenter - *BOKU University*

**721 - High rate algal ponds come of age in rural South Australia**

FALLOWFIELD Howard - *Flinders University*

**532 - New standards for non-sewered on-site sanitation systems**

UDERT Kai M. - *Eawag*

**640 - Ten years of Vertical Flow Constructed Wetlands the experience after the Danish EPA guidelines**

ARIAS Carlos - *Aarhus University*

**Parallel session 2 - Small wastewater treatment systems 1**

**09:50-11:10**

Session chair: Carlos Aragon

**480 - Towards Safe Water and Sanitation in Rural Localities - Applying Water Safety Planning methodology in Manastir, Romania**

VASILESCU Mihaela Nicoleta - *Ecological University of Bucharest*

**620 - Implementation of small wastewater systems in existing centralized water infrastructures - low population density case study**

CAMPUSANO GARCIA Claudia - *University of Kaiserslautern, Institute of Urban Wastewater Management*

**639 - Wastewater treatment for small communities in tropical conditions: performances technologies comparison in real conditions**

LOMBARD-LATUNE Rémi - *Irstea*

**256 - Characterization of the composition of dissolved organic matter during aerobic and anaerobic digestion of excess activated sludge**

LI Fusheng - *Gifu University*

**Parallel session 3 - Small wastewater treatment systems 2**

**14:00-15:20**

Session chair: Simos Malamis

**529 - Planning for achieving resource recovery from small sewage treatment plants: a case study in two watersheds in Minas Gerais, Brazil**

MOTA Cesar - *UFMG/DESA*

**505 - Innovation at scale: the scaling-up process of small-scale sanitation in India**

KLINGER Marius - *Swiss Federal Institute of Aquatic Science and Technology*

**704 - A multi-criteria approach to compare on-site sanitation systems**

VIDAL Brenda - *Luleå University of Technology, Urban Water Engineering group*

**270 - Energy savings at the small-scale wastewater treatment plants**

HOLBA Marek - *ASIO Ltd.*

# Small wastewater treatment plants in Austria – Technologies, management and training of operators

Ref # S2SMALL-58629

Guenter Langergraber \*, Alexander Pressl, Norbert Weissenbacher

Institute for Sanitary Engineering and Water Pollution Control, University of Natural Resources and Life Sciences, Vienna (BOKU), Muthgasse 18, A-1190 Vienna, Austria.

\* Corresponding author: [guenter.langergraber@boku.ac.at](mailto:guenter.langergraber@boku.ac.at)

## Abstract

In Austria, about 95 % of the population are served by 1'840 wastewater treatment plants (WWTPs) with design size > 50 population equivalent (PE). Besides, there are about 27'500 small WWTPs with design size less than 50 PE. Among these small WWTPs, the technologies implemented most frequently are ca. 6'750 activated sludge plants, ca. 5'350 treatment wetlands and ca. 4'250 Sequencing Batch Reactors SBRs. About 45 % of the small WWTPs have a design size between 5 and 10 PE. A permit given from the local authorities is required for operating a small WWTP. Most authorities request that owners of small WWTPs have a maintenance contract with a company and/or that owners/operators have to pass the training courses for operators of small WWTPs offered by the Austrian Wastewater and Waste Association (ÖWAV). Within the 1.5 days long training courses, owners/operators should gain basic knowledge on wastewater treatment and thus better understand their plant and finally resulting in well operated and maintained WWTPs. Since the year 2000, more than 200 training course have been held and more than 5'500 owners/operators of small WWTPs have been trained.

## Keywords

Small wastewater treatment plants, technologies, management, training of operators.

## INTRODUCTION

In Austria, 1'840 wastewater treatment plants (WWTPs) with design size > 50 population equivalent (PE) treat the wastewater of about 95 % of the population. The remaining 5 % of the population live in single houses and small settlements that require on site and decentralized wastewater treatment technologies. There is no common database on small WWTPs with design size < 50 PE thus data had to be collected from the Austrian federal states and compiled in a database. According to Langergraber and Weissenbacher (2017), the total number of WWTPs with design size < 500 PE is about 28'700 comprising of 1'300 WWTPs with design size 51-500 PE and 27'400 with design size < 50 PE, respectively.

Legal requirement for the effluent quality of small WWTPs are only available for WWTPs > 50 PE (1.AEVkA, 1996). For WWTPs with design size < 50 PE, the local authorities usually apply the same requirements for effluent concentrations as for > 50 PE. Since 1991, for organic matter the maximum effluent concentrations are 25 mg BOD<sub>5</sub>/L and 90 mg COD/L. Nitrification is required for all WWTPs, the maximum effluent concentration is 10 mg NH<sub>4</sub>-N/L (however, only for effluent water temperatures > 12 °C). There is no standard for nitrogen and phosphorus removal for the small WWTPs. However, for sensitive receiving water bodies authorities can request removal of nitrogen and phosphorus.

The paper presents the status of small WWTPs with design size < 50 PE in Austria including their management and the provisions taken to train the operators of the small WWTPs.

## Material and Methods

As described by Langergraber and Weissenbacher (2017), there is no general database for WWTPs < 50 PE in Austria. Thus, data were collected from the water information systems of the seven federal states (Carinthia, Lower Austria, Salzburg, Styria, Tyrol, Upper Austria, and Vorarlberg) and for the remaining two federal states with a low number of small WWTPs (Burgenland and Vienna) data have been received from the responsible persons at the federal governments.

Data collected for each WWTP included design size, treatment technology, date of commissioning, etc. As data are recorded slightly different in all federal states especially the categorising of the applied technology had to be checked and made uniform.

## Results and Discussion

### *Technologies for small WWTPs*

Table 1 shows the treatment technologies applied for WWTPs with design size < 50 PE. For more than 2'500 plants (9.3%) the technology is not recorded in the used databases. The highest number of unknown technologies is in Lower Austria (about 1'850 plants, i.e. 40% of the 4'500 plants) and Styria (about 340 plants, i.e. 3% of the 10'650 plants). The main types of technologies for secondary treatment are activated sludge (ca. 6'750 plants or 24.6%), treatment wetlands (ca. 5'350 plants or 19.5%; as nitrification is required, only vertical flow wetlands are implemented in Austria) and Sequencing Batch Reactors (SBRs, ca. 4'250 plants or 15.5%). Still more than 22% of the plants are classified as only primary treatment. These are mainly old septic tanks from which mechanically treated wastewater is discharged. This technology is no longer state-of-the-art. However, most of these WWTPs have been implemented before 1991 and still have a valid operation permit. As mentioned before, since 1991 biological treatment with nitrification is required for all WWTPs.

Table 1: Treatment technologies applied for wastewater treatment plants with design size < 50 PE in Austria (VF = vertical flow).

Federal state	Total	Primary only	Activated Sludge	SBR	Trickling Filter	Fixed bed	Soil Filter	VF wetland	Unknown + other*
Burgenland	20	0	4	1	1	0	0	14	0
Carinthia	6'961	2'248	3'051	566	7	55	308	556	170
Lower Austria	4'515	151	170	1'537	21	10	85	687	1'854
Salzburg	1'655	304	234	274	82	53	368	279	61
Styria	10'665	2'385	2'532	1'044	374	334	378	3'276	342
Tyrol	1'096	660	92	107	39	4	80	61	53
Upper Austria	2'398	381	646	702	100	0	27	475	67
Vienna	13	1	6	3	1	1	0	1	0
Vorarlberg	129	14	7	28	2	4	66	4	4
<b>Total</b>	<b>27'452</b>	<b>6'144</b>	<b>6'742</b>	<b>4'262</b>	<b>627</b>	<b>461</b>	<b>1'312</b>	<b>5'353</b>	<b>2'551</b>
		22.4%	24.6%	15.5%	2.3%	1.7%	4.8%	19.5%	9.3%

\* including 46 Membrane Bioreactor and 135 Rotating Biological Contactor plants.



Table 2 and Figure 1 show the design size of different treatment technologies of WWTPs < 50 PE in Austria. According Langergraber and Weissenbacher (2017), all 2'570 of the WWTPs < 500 PE with unknown design size are assumed < 50 PE. About 45 % of the WWTPs < 50 PE are of design size between 5 and 10 PE, 23 % < 5 PE. Most unknown design sizes are for plants with primary treatment only, indicating that the design size was not recorded as accurate for older WWTPs. For the main technologies used, i.e. activated sludge, treatment wetlands and SBRs, the design size distribution is quite similar.

Table 2: Design size of different treatment technologies of WWTPs < 50 PE in Austria.

Technology	Total	< 5 PE	5-10 PE	11-20 PE	21-50 PE	unknown
Treatment Wetlands	5'353	1'446	2'812	699	309	87
Activated Sludge	6'742	1'399	3'470	1'220	555	98
SBR	4'262	977	2'143	645	465	32
Soil filters	1'312	334	540	292	106	40
Trickling filters	627	167	300	76	69	15
Fixed bed reactor	461	87	281	63	21	9
Primary only	6'144	1'262	1'725	737	502	1'918
Others and unknown*	2'551	532	1'043	371	234	371
<b>Total</b>	<b>27'452</b>	<b>6'204</b>	<b>12'314</b>	<b>4'103</b>	<b>2'261</b>	<b>2'570</b>

\* including 46 Membrane Bioreactor and 135 Rotating Biological Contactor plants.

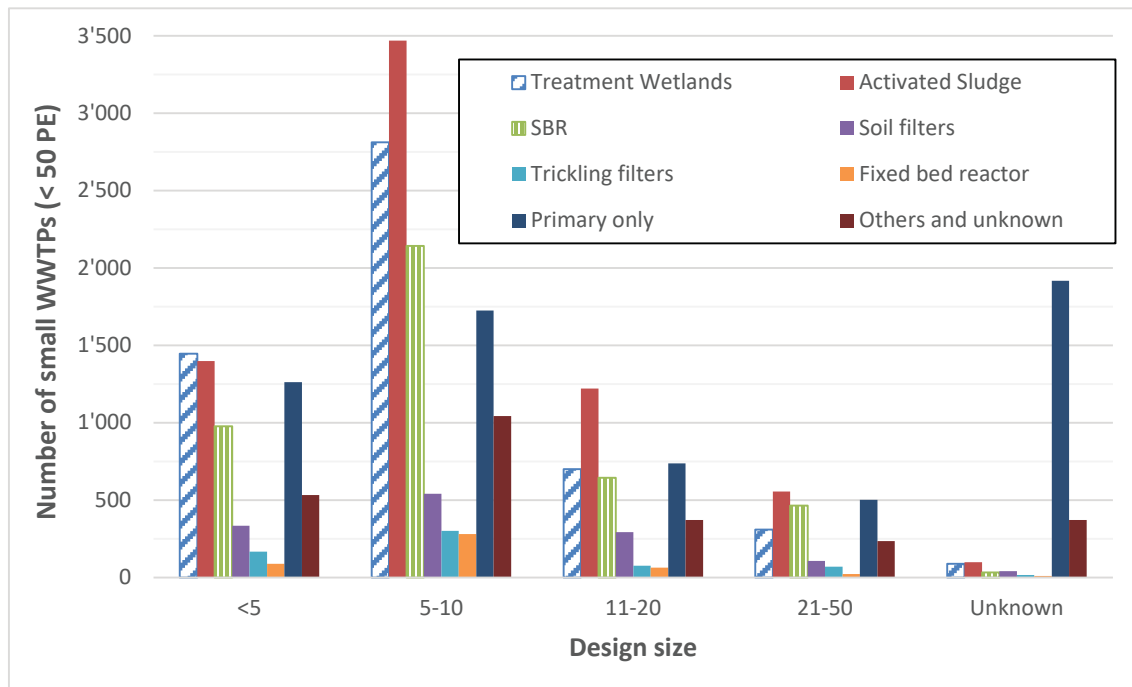


Figure 1. Design size of different treatment technologies of WWTPs < 50 PE in Austria.

Table 3 and Figure 2 show the year of commissioning of different treatment technologies applied for wastewater treatment plants with design size < 50 PE. In the first years after introducing the requirement of nitrification for all WWTPs in the early 1990s mainly activated sludge plants have been implemented. Since about 2000, treatment wetlands and SBRs have become the most popular technology for small WWTPs.

Table 3: Year of comissioning of different treatment technologies applied for wastewater treatment plants with design size < 50 PE in Austria.

Technology	Before 1992	1992-1996	1997-2001	2002-2006	2007-2011	2012-2016	unknown
Treatment Wetlands	77	185	790	1'207	2'166	892	36
Activated Sludge	314	513	2'569	1'373	1'526	396	51
SBR	46	66	480	906	1'644	1'093	27
Soil filters	156	158	375	231	260	126	6
Trickling filters	25	73	113	71	256	85	4
Fixed bed reactor	4	5	55	133	241	23	0
Primary only	5'669	163	82	75	72	47	36
Others and unknown*	533	73	147	431	953	392	22
<b>Total</b>	<b>6'824</b>	<b>1'236</b>	<b>4'611</b>	<b>4'427</b>	<b>7'118</b>	<b>3'054</b>	<b>182</b>

\* including 46 Membrane Bioreactor and 135 Rotating Biological Contactor plants.

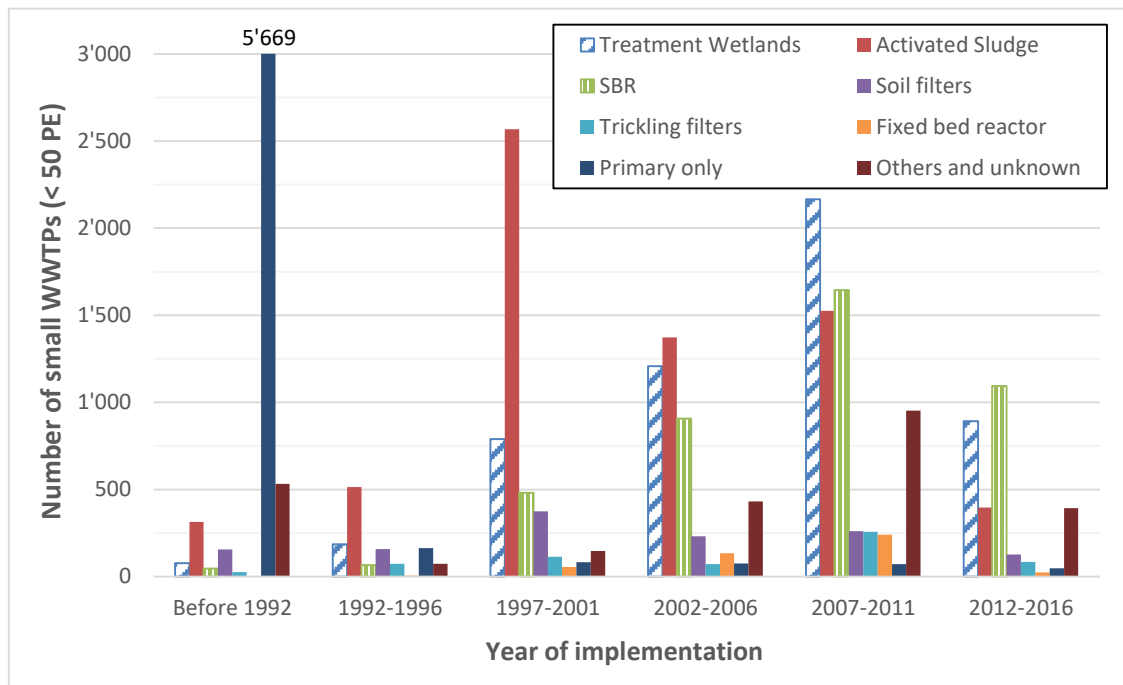


Figure 2. Year of comissioning of different treatment technologies applied for wastewater treatment plants with design size < 50 PE in Austria.

### Management

Permission to operate a small WWTP is given by local authorities on a case-by-case evaluation. The European certification procedure for small WWTPs as described in the standard EN 12556-3 (2005) is not applied in Austria as the plants are currently only tested for their ability to remove organic matter. Nitrification - that is mandatory in Austria - is generally not required for small WWTPs in most other European countries.

Usually the permission for operating a small WWTP is granted for a period of 15 years. After this period, the permission can be extended if the WWTP is still according to the state-of-the-art, meaning it is able to treat the wastewater according to the legal requirements. To get the permission several

local authorities request that owners have a contract for operation and maintenance with a company or that owners of WWTPs take part in the training course for operators (see below).

The permission to operate a small WWTP also includes the frequency in which self-monitoring of the plant has to be carried out by the owner of the WWTP. Below 50 PE, self-monitoring usually includes weekly routine checks if the WWTP is working properly and monthly sampling and analysis of the following parameters: temperature and pH of effluent, effluent concentration of ammonia nitrogen and settleable solids, and (if applicable) the sludge volume. For WWTPs larger than 50 PE, sampling and analysis have to be done on a weekly basis. All results gained from self-monitoring as well as operational and maintenance work have to be documented in an operations diary.

Besides self-monitoring, external monitoring is requested. Usually every two years external monitoring is requested for small WWTPs < 50 PE. In some federal states, the period of the external monitoring will be extended, e.g. to every three years, if owners of WWTPs successfully complete the training course for operators.

During external monitoring, effluent samples are also analysed for BOD<sub>5</sub> and COD. Besides, the operations diary including the data gained from self-monitoring are evaluated. Reports from external monitoring are sent to the local authorities for evaluation.

### ***Training of operators of small WWTPs***

The Austrian Wastewater and Waste Association (Österreichischer Wasser- und Abfallwirtschaftsverband, ÖWAV) is responsible for the training of operators of wastewater treatment plants. A special training course for operators of small WWTPs (less than 50 PE) has started in 2000. The Institute of Sanitary Engineering at BOKU University is responsible for the content of and running the trainings. Between 2000 and 2016, 169 general training courses have been held (about 4'200 participants). Additionally, 42 special courses for owners of treatment wetlands (with about 1'000 participants) and 12 training courses (about 300 participants) for operators of WWTPs at Alpine refuges (in collaboration with the Austrian and German Alpine Associations) were organised.

The training for operators of small WWTPs (< 50 PE) lasts for 1.5 days and comprises

1. theoretical knowledge on biological wastewater treatment, including
  - a. composition of domestic wastewater,
  - b. basic processes for organic matter and nutrient removal from wastewater,
  - c. technical implementation of the basic processes in WWTPs,
  - d. general types of technologies used for domestic wastewater treatment.
2. basics on operation and maintenance requirements,
  - a. why operation and maintenance is important
  - b. basic requirements for operation and maintenance (e.g. operational diary)
  - c. different requirements of operation and maintenance for different technologies
3. practical introduction into sampling and analysis (this part is carried out on a nearby WWTP which has a laboratory)
  - a. carrying out the analyses required for self-monitoring,
  - b. showcasing analysis methods available at larger WWTPs, e.g. cuvette tests, BOD analysis and microscopes.
4. field trips of small WWTPs showcasing different technologies.

5. fundamentals of the legal requirements and subsistence system (this part is given by a person from the local authority with legal experience)

This training course is offered more than 10 times per year in several federal states. The special course for operators of treatment wetland has the same structure; however, the focus on lecturing is on treatment wetlands.

For operators of WWTPs from 51 to 500 PE, a special course has been designed by ÖWAV. However, this course is not held frequently. In rural areas, WWTPs of this size are often organised as cooperative in which all members are responsible for the operation of the plant. Authorities often agree that the members of the cooperative shall participate in the course for operators of small WWTPs with less than 50 PE.

## Conclusions

It can be concluded that:

- The number of small WWTPs (less than 50 PE) in Austria is about 27'500. The most popular technologies for secondary treatment are activated sludge (ca. 6'750 plants), treatment wetlands (ca. 5'350 plants) and SBR (ca. 4'250 plants).
- To guarantee the operation and maintenance of the small WWTPs, authorities often request that owners of small WWTPs must have a contract with a company for operation and maintenance of the plant and/or that the owners have to participate in the training courses for operators of small WWTPs offered by ÖWAV, the Austrian Wastewater and Waste Association.
- These training courses have duration of 1.5 days and aim to provide the owners/operators with basic understanding on how their WWTPs works assuming that basic understanding of the principles of wastewater treatment and pollutant removal raises more awareness and finally encourages owners/operators to better operate and maintain their facility.

## Acknowledgements

The authors thank the master students Iris Dopplinger, Sophia Gerstorfer and Domink Feigl for the base work in collecting the data as well as the responsible persons at the federal governments for supporting the students.

## References

- 1.AEVkA (1996): 1. Abwasseremissionsverordnung für kommunales Abwasser (Austrian regulation for emissions from domestic wastewater). BGBl.210/1996, Vienna, Austria [*in German*].
- EN 12556-3 (2005): Small wastewater treatment systems up to 50 PT. Part 3: Packaged and/or site assembled domestic wastewater treatment plants. Österreichisches Normungsinstitut, Vienna, Austria.
- Langergraber, G., Weissenbacher, N. (2017): Survey on number and size distribution of treatment wetlands in Austria. *Water Sci Technol* 75(10), 2309-2315.

# High rate algal ponds come of age in rural South Australia

Ref # S2SMALL-711351

H. J. Fallowfield\*, P. Young, N.J. Cromar, N. Buchanan

College of Science and Engineering, Health and Environment Group,  
Flinders University, GPO Box 2100, Adelaide, South Australia, 5001

\* Presenting Author: [howard.fallowfield@flinders.edu.au](mailto:howard.fallowfield@flinders.edu.au)

**Abstract:** In 2008, a 200 m<sup>2</sup> high rate algal pond (HRAP) was incorporated into a Community Wastewater Management Scheme (CWMS) at Kingston on Murray in rural South Australia. The performance of the HRAP was evaluated over 4 years at a range of operating configurations (0.32-0.55 m depth, 4.5-10 d hydraulic retention time (HRT)). The results demonstrated that the HRAP could replace the 5 cell waste stabilisation ponds (WSP; 1.2m deep, 66 d HRT). The application of HRAPs significantly reduces the area requirement for treatment and consequently the capital cost of construction. Furthermore, the shorter HRT reduces evaporative losses compared to WSPs resulting in more treated water being available for beneficial reuse. The performance of the HRAP was independently validated and shown to be consistent with the health-based targets required by National Guidelines for water recycling. The validation was accepted by the regulatory agency, and the first design guidelines for HRAP inclusion into CWMS was promulgated in 2016. To the authors' knowledge, this is the first time such guidelines for HRAP design have received regulatory acceptance, enabling wastewater engineers to include them within new CWMS confidently.

**Keywords:** Disinfection, high rate algal ponds, rural communities, wastewater treatment.

## INTRODUCTION / MAIN METHODS

Rural communities in South Australia are largely dependent upon on-site systems e.g. septic tanks, for wastewater treatment. The on-site, subsurface disposal of treated effluent is problematic in areas with low permeability soils e.g. clay, causing surface pooling of effluent, which may increase residents' exposure to human pathogens or during heavy rainfall events, contamination of environmentally sensitive surface waters e.g. the Murray River. In contrast, highly permeable soils e.g. sand, increase the risk of groundwater contamination, a concern in areas where it is a source of potable water. In South Australia, these issues are resolved by the adoption of Community Wastewater Management Schemes (CWMS), wherein 92 out of the 174 schemes operated, the combined septic tank overflow is reticulated to waste stabilisation ponds (WSP) for further treatment. The recommended WSP configuration comprises a facultative pond followed by four in series maturation ponds all operated at 1.2 m depth with a combined hydraulic residence time (HRT) of 66 d. In contrast, high rate algal ponds (HRAPs) are shallow (0.3-0.5 m), serpentine channel, paddlewheel mixed systems with HRTs of 4-10 d; effective HRAPs offer significantly reduced footprint and attendant capital costs for CWMS.

In 2008, a 200 m<sup>2</sup> HRAP was constructed at the Kingston on Murray (KoM; S 34 24', E 140 33') CWMS. The HRAP was operated at 0.32, 0.43 and 0.55m depth with HRTs between 4.5 and 10 d at an influent flow rate of 12 m<sup>3</sup> d<sup>-1</sup>. Wastewater analysis throughout the research was conducted using Standard Methods for the Examination of Water and Wastewater (1998).

Initially, the study compared the performance of the HRAP with the facultative pond (6,300 m<sup>2</sup>, 30 d HRT) at Lyndoch CWMS (S 34 60' E 138 90), both received septic tank overflow from their respective communities (Buchanan *et al*, 2011). Subsequently, the performance of the HRAP operated in series with the facultative pond at KoM was compared with the final effluent from two maturation ponds operated in series at Lyndoch (Buchanan, 2014). The results of this research demonstrated that a HRAP could effectively replace either the facultative or maturation ponds in older CWMS requiring refurbishment. More importantly, it suggests that a HRAP could entirely replace WSPs in newly constructed CWMS.

An independent validation of HRAP performance, consistent with the requirements of the Australian, National Guidelines for Water Recycling: Managing Health and Environmental Risks (Phase 1) (NHMRC, 2006), was conducted by a National Association of Testing Authorities (NATA) accredited laboratory in the winter of 2013. Two HRAPs were operated in series at a depth 0.3 m and a combined HRT of 10 d. On Monday and Thursday each week 20 inlet and 20 outlet 'grab' samples were collected from both HRAPs. *Escherichia coli*, F-RNA bacteriophage and aerobic spore-forming bacteria, used as surrogate indicators of pathogenic bacteria, viruses and protozoa, were enumerated in respective inlet and outlet samples and the log<sub>10</sub> reduction value (LRV) at each stage of passage through the system determined. The results of validation were accepted by the South Australia Department of Health and Ageing, Wastewater Management Group (DoHAWMG) and in 2016, design guidelines were issued for the inclusion of high rate algal ponds in CWMS in South Australia. The authors are unaware of any other published, independent validation of HRAP performance accepted by a regulatory agency leading to their more general application to wastewater treatment. This paper provides an overview of the significant results leading to this outcome.

## MAIN RESULTS AND CONCLUSIONS

### *Wastewater treatment performance of HRAPs compared with WSPs treating septic tank or facultative pond effluent.*

When fed overflow from community septic tanks there was little difference in the performance of the HRAP compared to that of the facultative pond at Lyndoch operated. Over 90% of the incoming 5-day biochemical oxygen demand (BOD<sub>5</sub>) was removed by both systems; the HRAP recorded a 30% higher removal efficiency of total inorganic nitrogen (TIN) than the facultative WSP. The mean LRV for *E.coli* was 1.6 and 2.1 for the Lyndoch facultative pond and the HRAP respectively. The HRAP and the WSP were both less efficient when treating facultative pond effluents rather than septic tank effluent. However, the HRAP maintained a performance which was significantly better than the Lyndoch maturation ponds. The HRAP removed 59% and 58% of the influent BOD<sub>5</sub> and TIN respectively, compared with respective removals of 33% and 34% by the maturation ponds at Lyndoch. The mean *E.coli* LRV was similar for the Lyndoch maturation ponds and the HRAP: 2.0 and 2.7 respectively.

### *Independent validation of HRAP performance.*

The Australian National Guidelines for Water Recycling: Managing Health and Environmental Risks (Phase 1) (NHMRC, 2006) derive health-based performance targets for managing microbial hazards in treated wastewaters intended for various uses. These require compliance with the tolerable risk of 10<sup>-6</sup> disability-adjusted life years (DALYs) per capita



per year, equivalent to an annual risk of diarrhoeal illness of 1 per 1000. Treated effluent from CWMS is usually reused to irrigate non-food crops, commonly woodlots. The National Guidelines for Water Recycling: Managing Health and Environmental Risks (Phase 1) (NHMRC, 2006) derived target LRVs of 4.0, 5.0 and 3.5 for enteric bacteria, viruses and protozoa respectively. Additionally, the median value for *E. coli* in the treated effluent should not exceed  $10^4$  100 mL<sup>-1</sup>.

The HRAP validation was conducted in 2013 between August and October. During this period both the mean daily air temperature and the mean daily global solar exposure were below the yearly means for the region. The quality of the wastewater influent over the 10 week validation period was typical of that of septic tank overflow; with median values of 205 mg BOD<sub>5</sub> L<sup>-1</sup>, suspended solids 61 mg L<sup>-1</sup> and 94 Nephelometric Turbidity Units (NTU).

*E. coli* and F-RNA bacteriophage were used as surrogates to determine the LRV for bacterial and viral enteric pathogens following treatment in the HRAPs. The median LRV was 3.3 and 2.32 for *E. coli* and F-RNA bacteriophage following treatment in the two HRAPs operated in series at a combined HRT of 10 d. The median concentration of *E. coli* in the final treated effluent was 3.3 log<sub>10</sub> MPN 100 mL<sup>-1</sup>. The consensus is lacking on a suitable indicator for pathogenic protozoa. The National Guidelines for Water Recycling: Managing Health and Environmental Risks (Phase 1) (NHMRC, 2006) suggest seeding with the aerobic spore-forming bacterium *Bacillus subtilis*; this was considered impractical for validation of a relatively remote rural CWMS. Consequently, native aerobic spore-forming bacteria were adopted as surrogates for this validation. Subsequently, Young *et al* (2016) reported the unsuitability, for this application, of these organisms as indicators of pathogenic protozoa. Frequently, higher numbers of aerobic spore-forming bacteria were recovered in the treated effluent than in the influent wastewater. It was concluded that this was due to contamination with aerobic spore-forming bacteria from other environmental sources and regrowth within the HRAP. Young *et al* (2016) suggested that since settling is negligible in HRAPs and *E. coli* has a higher resistance to solar radiation than *Cryptosporidium*, it could be used with caution as a conservative surrogate for *Cryptosporidium* in HRAPs.

It was accepted by DoHAWMG that the HRAP, used in conjunction with the on-site controls in place for woodlot irrigation, e.g. exclusion of public during irrigation, extended buffer zones, complied with the 5<sup>th</sup> percentile LRV performance targets for the respective enteric organisms required by the National Guidelines for Water Recycling: Managing Health and Environmental Risks (Phase 1) (NHMRC, 2006). Additionally, the treated wastewater quality objective of a median value of  $<10^4$  *E. coli* 100 mL<sup>-1</sup> was also met.

### ***Design guideline for high rate algal ponds***

In 2016, the Local Government Association of South Australia (LGA SA) published the “Design Guideline for a High Rate Algal Pond – as an element in Wastewater Treatment Trains”. The guideline accepts that a HRAP may be operated in two configurations. Firstly, where an existing CWMS requires an upgrade the HRAP may replace the facultative pond followed by 4 maturation ponds operated in series. The second configuration accepts that a HRAP or two HRAPs operated in series at a depth between 0.3-0.5 m at an effective HRT of 10 d can replace the current WSP design comprising a facultative pond followed by 4

maturation ponds operated in series. This HRAP configuration results in 40-50% reduction in both surface area requirement and construction costs compared with the WSP configuration. The shorter HRAP retention time, compared with the 66 d HRT of the WSP configuration, significantly reduces evaporative losses, resulting in more treated wastewater being available for beneficial reuse in communities often exposed to water scarcity. The guideline (LGA SA, 2016) accepts that for sewage, in the absence of on-site treatment, an anaerobic pond may be used as pre-treatment before a HRAP. The anaerobic pond should be operated at a depth >3 m at temperature dependent volumetric loadings between 0.1-0.35 kg BOD<sub>5</sub> m<sup>-3</sup> d<sup>-1</sup> (Power and Water, 2011). Where treated water can be accessed by stock a minimum of 25 d total retention is required, 10 d in the HRAP with an additional 15 d in open pond storage, to ensure the die-off of helminth eggs.

The guideline (LGA SA, 2016) notes that ideally, influent should be continuously fed to the HRAP at the rate required to achieve the 10 d HRT. In CWMS septic tank effluent from properties within the community is reticulated to a central collection point or sump. The effluent is then pumped to the CWMS lagoon system. The operation of the delivery pump is frequently controlled by liquid level sensors within the sump resulting in random pumping events delivering predictable volumes of influent. However, this may result in unacceptable shock loading of the HRAP. In these situations, an influent feed buffer tank designed to enable continuous feeding of influent may be used. If this is impracticable, the 4% rule included in the guidelines (LGA SA, 2016) should be applied. This recommends that not more than 4% of the HRAP operating pond volume should be introduced over a period shorter than 4% of the residence time. An example is provided for a daily influent volume of 12 m<sup>3</sup> d<sup>-1</sup> and a HRAP operating at an HRT 5 d which requires an operating volume of 60 m<sup>3</sup>. Applying the 4% rule suggests that a single pumping event should deliver ≤2.4 m<sup>3</sup> with a time interval between pumping of ≤4.8h.

## REFERENCES

Buchanan N., Cromar N., Bolton N. & Fallowfield H. 2011 Comparison of a High Rate Algal Pond with a 'standard' secondary facultative Waste Stabilisation Pond in rural South Australia. *Proceedings 10<sup>th</sup> Specialized Conference on Small Water and Wastewater Treatment Systems*, 18-22 April 2011, Venice, Italy, pp 292-299.

Buchanan N. 2014 *Comparing the performance of a high rate algal pond with a waste stabilization pond in rural South Australia*. PhD thesis, School of the Environment, Flinders University, Adelaide, Australia.

Local Government Association of South Australia 2016 *Design guideline for a high rate algal pond (HRAP) – as an element in wastewater treatment trains. High rate algal pond design guideline for inclusion in SA community wastewater management schemes*. Local Government Association of South Australia, Adelaide, Australia.

Power and Water (2011), Waste Stabilisation Pond Design Manual. [http://www.powerwater.com.au/\\_\\_data/assets/pdf\\_file/0008/43946/wsp\\_design\\_manual.pdf](http://www.powerwater.com.au/__data/assets/pdf_file/0008/43946/wsp_design_manual.pdf) (accessed 14 July 2017)

*Standard Methods for the Examination of Water and Wastewater* 1998 20th edn, American Public Health Association/American Water Works Association/Water Environment Federation, Washington DC, USA.

Young P., Buchanan N. & Fallowfield HJ 2016 Inactivation of indicator organisms in wastewater treated by a high rate algal pond *J Applied Microbiology*, **121**, 577 – 586.

## **New standards for non-sewered on-site sanitation systems**

**Udert, K.M.<sup>1</sup>, Deshusses M.A.<sup>2</sup>, Cheng Y.-L.<sup>3</sup>, Cid C.A.<sup>4</sup>, Starkl M.<sup>5</sup>, Julian T.<sup>1</sup>, Rubin A.<sup>6</sup>**

<sup>1</sup> Eawag – Swiss Federal Institute of Aquatic Science and Technology, Dübendorf, Switzerland

<sup>2</sup> Duke University, Dept. of Civil & Environmental Engineering, Box 90287, Durham, NC, USA

<sup>3</sup> University of Toronto, Centre for Global Engineering and Dept. of Chemical Engineering & Applied Chemistry, Toronto, Ontario, Canada

<sup>4</sup> California Institute of Technology, Linde+Robinson Laboratories, Pasadena, CA, USA

<sup>5</sup> University of Natural Resources and Life Sciences (BOKU), Competence Centre for Decision Aid in Environmental Management, Vienna, Austria

<sup>6</sup> North Carolina State University, Biological & Agricultural Engineering Dept., Raleigh, NC, USA

**Keywords: Load reduction, eutrophication, pathogen removal, public health**

### **Introduction**

Effluent standards for wastewater have been tightened over the last decades to ensure public health, prevent environmental pollution, and encourage resource recovery and reuse. The main targets were effluents from sewer-based wastewater treatment plants. Since small scale non-sewered sanitation systems have been recognized as a valid alternative to sewer-based wastewater management, especially for low-income countries, several international commissions including ISO-PC 305 or CEN/TC 165/WG 41 are working to establish suitable standards for small scale non-sewered sanitation systems. One of the goals of this standardization effort is to foster the development of new on-site treatment technologies. Existing standards, which mainly target effluents from sewer-based wastewater treatment plants cannot be used to adequately regulate the new systems. For instance, on-site sanitation systems without water supply will have very different characteristics than conventional sewer-based wastewater treatment plants operated with activated sludge. With this paper, we aim to initiate a discussion among wastewater experts about new approaches to regulate outputs from non-sewered on-site sanitation systems.

### **Material and Methods**

This paper is based on our own experiences with the development of sustainable on-site sanitation systems, which will not rely on piped water supply or sewers. Furthermore, we reviewed current standards for wastewater treatment and reuse, and up-to-date research results on pathogen removal.

### **Results and Discussion**

Conventional sewer-based wastewater treatment plants have two major outputs, liquid effluent and excess sludge. This is due to the fact that human excreta is flushed with high volumes of water. New non-sewered sanitation systems, however, might not have large discharge flows. An example is incineration toilets. For these systems, a more generic definition of the outputs is needed. We propose that this new definition not be based on the characteristics of the output, but on their purpose. Thus, four outputs were defined: (1) valuable products such as fertilizer, (2) reusable products for on-site recycling e.g. flushing water, (3) outputs, that are discharged to the environment, and (4) residual waste recovered during system maintenance.

All four outputs will have to be regulated. Existing standards can be used for specific products

such as fertilizer or flushing water. However, the definition of standards for outputs discharged to the environment is challenging. The type and volume of effluent from the newly developed sanitation systems will differ widely from the effluents of conventional sewerage treatment plants. Furthermore, gaseous outputs are important from some technologies such as stripping or incineration processes. In order to account for this wide range of possible outputs, we suggest limiting overall gaseous, liquid and solid output loads to the environment instead of concentrations in specific outputs.

A primary goal of the new standards will be the prevention of diseases. This goal must be independent of the risk of environmental pollution (see below) We chose four indicator organisms which must be spiked and monitored during testing (Table 1). The indicators are representative for different pathogen classes but also for resistances to different disinfection methods. The load reductions are calculated by comparing all inputs, i.e. urine, feces and additional inputs, with the sum of all outputs.

**Table 1 Dosage and overall reduction of pathogens for testing of non-sewered sanitation systems**

	E.coli	MS2 Coliphage	Ascaris suum	Cryptosporidium parvum oocysts
Pathogen class	bacteria	viruses	helminths	protozoa
High resistance to	-	UV	pH and low moisture	chlorine and heat
Minimum urine spike [#L]	10 <sup>8</sup>	10 <sup>8</sup>	10 <sup>4</sup>	10 <sup>6</sup>
Minimum feces spike [#g]	10 <sup>8</sup>	10 <sup>8</sup>	10 <sup>4</sup>	10 <sup>6</sup>
Overall output log reduction	6	7	4	6

Based on our literature review, we conclude that pollution of receiving waters with nitrogen, phosphorus and organic substances will remain the main negative effect on the environment. To regulate the output of these three substances to the environment, we propose three categories of systems (Table 2). The aim for Category I systems will be maximum environmental protection and maximum nutrient recovery. This category is most likely not achievable for any current on-site sanitation system, but it sets the target for further development. Category II could be achieved with the most effective on-site sanitation systems currently on the market. This category should therefore be used for current systems applied in areas, which have watersheds sensitive to eutrophication, or aquifers used for drinking water production. Category III is the least stringent, and only contains standards for load reduction of organic substances. Systems within this category shall be used, where neither eutrophication nor aquifer pollution is likely.

**Table 2 Suggested load reduction standards in [%].The values are based on current regulation in the Canton of Zurich/Switzerland (Category I, personal communication) and EU legislation (Categories II and III, Council Directive 91/271/EEC and Commission Directive 98/15/EC).**

Parameter	Category I	Category II	Category III
TOC <sup>(1)</sup>	90	75	75
P <sub>tot</sub>	95	80	-
N <sub>tot</sub>	95	70	-

# Ten years of Vertical Flow Constructed Wetlands the experience after the Danish EPA guidelines

Arias C.A.<sup>a</sup>, Kilian R.<sup>b</sup>, Carvalho P.<sup>a</sup>, and Brix H.<sup>a</sup>

<sup>a</sup>Aarhus University, Department of Bioscience, Ole Worms Allé 1, Building 1135, 8000 Aarhus C, Denmark, [carlos.arias@biology.au.dk](mailto:carlos.arias@biology.au.dk),

<sup>b</sup>Kilian Water Ltd, Torupvej 4, Vrads, 8654 Bryrup, Denmark.

## Abstract

Discharges of poorly treated sewage from single households and house clusters in rural areas, not connected to central wastewater treatment plants can pollute watercourses and lakes. Danish legislation changed in the late 80s to demand the removal of >95% of organic matter, and depending on the characteristics of the receiving waters; additional requirements might include >90% nitrification and/or at least 90% removal of total phosphorus to control the discharges of wastewaters from the entire country (Arias C.A. et al., 2005; Brix and Arias 2005).

Several decentralized technologies have been accepted and the Danish EPA supported research to produce national guidelines. Among the systems accepted: constructed wetlands, biological sand filters, willow evapo-transpirative systems and technical compact biological wastewater treatment systems.

Since the production of the guidelines, the number of VFCW built has increased and today more than 1000 VFCW are operating in the country. According to the Danish Guidelines VFCW treatment train must include a pretreatment, a pumping system to feed the bed(s) sequentially at rates of 8 to 12 pulse/d, a 1 meter deep planted sand filled bed with the needed feeding and drainage pipes. To comply with the local discharge limits, most of the systems are fitted with wells to use reactive media or chemical injection units P removal. The guidelines also recommend the installation of recirculation of nitrified waters to enhance performance and increase the removal of total nitrogen (Figure 1).

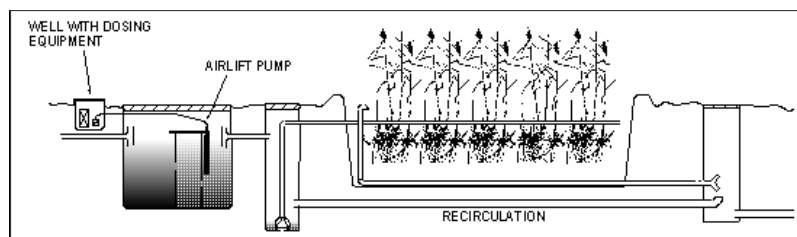


Figure 1 Typical layout of the Danish vertical flow configuration

The local environmental authorities are autonomous and performance evaluation and effluent concentration of the systems is demanded and monitoring of the removal of organic matter, nitrification and P removal. Additionally, several of these VFCW systems have monitored regularly there is variability on the sampling frequency and the parameters measured. The data gathered might include BOD<sub>5</sub>, NH<sub>4</sub>, TP of ca. 600 of the systems. Moreover data for some selected systems includes nitrogen species, TSS, pH, O<sub>2</sub> saturation, EC, emergent pollutants and

TOC, and TN that have been monitored intensively to assess the effect of recirculation in TN removal. Additionally, depletion of pollutants along the depth of the beds has been evaluated.

The results show that only three of the systems presented clogging, explained by pretreatment system failure. Oxygen saturation at the effluent was always above 60%. BOD<sub>5</sub> performance for all the systems show a removal higher than 90% and effluents with concentrations well below 10 mg/l. Nitrification varied among the systems affected by the NH<sub>4</sub>-N inlet concentration but complying with the Danish discharge demands. TP removal varied depending on the technology selected. Reactive media has to be maintained regularly but chemical precipitation even though a reliable method, if the discharge limits are to be fulfilled the dosing has to be adjusted according to the production of P, which demands extra efforts. Regarding TN removal (not demanded by national law), recirculation of treated effluents improves the removal, although removal varied among systems, explained by the fact that the recycling structures in the systems are simple and proper regulation of recirculation flows cannot be guaranteed. For the systems with the possibility of controlling the place of recirculation and the flow the results show that TN removal is greater when recirculation is directed to the sedimentation tank and not to the pumping well. The best recirculation volume seems to be 100% treated water recirculation which provides the best TN removal performance.

The systems sampled for emergent pollutants performance, showed similar and even better removal performance if compared to activated sludge systems. Depletion along the depth showed that most of the nitrification and TOC removal and around 10% of the TN is removed in the top 25 cm of the unsaturated bed. Deeper along the filter, no significant removal of TN occurs.

## Final remarks

VFCW constructed under the Danish standard has shown to be capable of complying with the Danish discharge limits. The results of the VFCW performance suggest that both the area and depth stated by the Danish guidelines (3 m<sup>2</sup>/PE and 1 m deep) might be larger than the actual surface and depth needed, making the systems more expensive and less competitive. Sustainable P removal is still an issue to be solved, and even though chemical precipitation is effective, the proper dosing requires intervention and adjusting which in most cases is neglected and only high P discharges are detected when monitoring is performed.

## References

- Arias C.A., Brix H and Marti (2005) Recirculating of treated effluents enhances removal of total nitrogen in vertical flow constructed wetlands. *Journal of environmental Science and Health Part A Toxic/Hazardous Substances & Environmental Engineering*, Vol. 40, pp1431-1443.
- Brix H. and Arias C.A. (2005). The use of vertical flow constructed wetlands for on-site treatment of domestic wastewater: New Danish guidelines. *Ecological Engineering*, Vol. 25, Issue 5, pp 491-500.
- Miljøministeriet (2004). Retningslinier for etablering af beplantede filteranlæg op til 30 PE. Økologisk byfornyelse og spildevandrensning Nr. 52.



# Towards Safe Water and Sanitation in Rural Localities: Applying the Water Safety Planning Methodology in Mănăștiur, Romania

Ref # S2SMALL-22676

M.N. Vasilescu<sup>1\*</sup>, C. Wendland<sup>2</sup>, M. Isacu<sup>3</sup>

<sup>1</sup> Ecological University of Bucharest, B-dul Vasile Milea, No. 1G, Bucharest, Romania

<sup>2</sup> Women Engaged for a Common Future (WECF), St Jacobs Platz 10, Munich, Germany

<sup>3</sup> Aquademica Association, Str. Georghe Lazar nr. 11 A, Timișoara, Romania

\* Mihaela Nicoleta Vasilescu: [vasilescum13@yahoo.com](mailto:vasilescum13@yahoo.com)

**Abstract:** Water Safety Plan (WSP) is a concept of preventive management raising barriers against water contamination along the supply chain from water source to the consumer, developed by World Health Organization and International Water Association. WSP is a requirement of the Directive 2015/1787/EU amending Directive 98/83/EC for water intended for human consumption. The methodology of the study concerning the development of a WSP for the small centralized drinking water supply in Mănăștiur, Timiș County, is based on field visits, data collection, water sampling, laboratory analysis, risk analysis along the supply system using scores, and recommendations for WSP development and implementation. The source for drinking water in Mănăștiur is ground water. The main hazards in the catchment area are agriculture, animal farms, food and wood processing industry, roads, households, recreational areas. Water is treated in a mono-block container, is stored in a stainless steel tank and is distributed by gravity to 4 villages and 629 households. Hazards were identified for each component of the water supply system, and the risk scores were established. Based on risk analysis, there were recommended control measures, their monitoring, and possible actions in case of exceeding the maximum admissible concentrations of microbiological/ chemical parameters in drinking water.

**Keywords:** enable local community, risk analysis, Water Safety Plan, water and sanitation.

## INTRODUCTION

Water Safety Plan (WSP) is a concept of preventive operational management raising barriers against water contamination along the supply chain from water source to the consumer, developed by World Health Organization (WHO) in cooperation with International Water Association (IWA), (WHO, 2011), (WHO, IWA, 2009). Multiple barrier approach aims to establish risk control measures for all processes in the water supply system: resource protection, water abstraction, water treatment, storage and distribution, water plumbing inside buildings. WSP is a requirement of the Directive 2015/1787/EU amending Annexes II and III to Council Directive 98/83/EC quality of water intended for human consumption (L260/6, 7.10.2015).

Based on its own experience working with local organizations from Eastern Europe and the Caucasus, WECF developed the WSP approach further for small municipalities which often lack capacity and professional know how to manage water and sanitation safely. The WSSP Compendium (M. Samwel, C. Wendland, 2016) explains in a step wise approach how to identify the main sources of pollution, assess the risks, gives ideas for change and to take action to improve the situation.

The study case presented in this paper is a risk analysis of a small water supply system in a rural area of Romania, Mănăștiur village, with the aim to educate and engage the local community in developing and taking the ownership of the operational management of their

drinking water, using the Water Safety Plan as the tool of establishing a preventive management (String G., 2016).

The objectives of the study case are: (i) Raise awareness about WSP and its significance for a good management of drinking water supply system; (ii) Establish the WSP team in Mănăștiur; (iii) Collect the basic information; (iv) Assembly the information in an incipient WSP; (v) Formulate recommendation for completing the information and implementation of WSP.

## MATERIALS AND METHODS

The methodology to achieve the scope of the study concerning the development of a WSP for the small centralized drinking water supply in Mănăștiur, Timiș County, is based on field visits for on-site assessment, data collection based on interviews using the questionnaires included in the WSSP Compendium, water sampling and laboratory analysis of the samples, risk analysis using scores, and recommendations for WSP further development and implementation (Gelting R. J. et al., 2012).

WSP is a way to ensure the safe supply of drinking water by: (i) Knowledge and documentation of the entire supply system; (ii) Identification where and how issues could arise; (iii) Construction of barriers and management systems to stop problems before they arise – anticipation; (iv) Ensure that all system components are working properly. The overview of the development of a WSP is given in table 1 (WHO, 2011).

**Table 1.** Matrix of WSP Development

	<b>Source</b>	<b>Treatment</b>	<b>Distribution</b>	<b>Tap</b>
<b>Information</b>	type of catchment, the water source	charts, treatment processes, capability, control	diagrams, the flow direction, equipment, storage tanks, the status of valves	type of premises, distribution network materials
<b>Hazard Identification</b>	sources of pollution, climate	catchment area, reagents used in treatment, materials used, the ineffectiveness of treatment, power failures	contamination from outside, flow fluctuations, unauthorized connections, back siphonage	siphonage, leakage from pipelines, hygiene
<b>Risk Assessment</b>	the likelihood and consequences of pollution	the likelihood of having an ineffective treatment, the consequences of inefficiency	the likelihood of failure, consequences	the likelihood of occurrence, consequences
<b>Control Measures</b>	catchment and reservoir management	treatment process, process monitoring, warning systems, shutdown of water supply to the network	operational procedures, approved materials, valve status	sealing elements, treatment to remove plumbo solvency, education
<b>Monitoring</b>	pollutants' points of discharge, raw water quality	raw water, treatment process, disinfected water supplied to the network (final product)	flow, pressure, residual disinfectant concentration	inspection of the premises

<b>Actions in case of Maximum Admissible Concentrations (MAC) exceeding</b>	stopping the takeover of water from source, adjusting the treatment process	stopping the takeover from water source, adjust the treatment process, the treatment plant closing	water discharge, flushing pipes, advising people to boil water	advising consumers
---	---	--	--	--------------------

Following the matrix described above, the whole waters supply system is analyzed and risk scores are established for each part of the chain, according to the risk matrix shown in table 2 (WHO, 2011).

**Table 2.** Risk Matrix

			Severity/ Impact of Consequence				
			Insignificant	Minor	Moderate	Major	Catastrophic
			1	2	3	4	5
<b>Likelihood</b>	Almost certain	5	5 (L)	10 (M)	15 (H)	20 (VH)	25 (VH)
	Likely	4	4 (L)	8 (M)	12 (H)	16 (VH)	20 (VH)
	Foreseeable	3	3 (L)	6 (M)	9 (M)	12 (H)	15 (H)
	Unlikely	2	2 (L)	4 (L)	6 (M)	8 (M)	10 (M)
	Most unlikely	1	1 (L)	2 (L)	3 (L)	4 (L)	5 (L)

After the risk assessment of the drinking water supply system, various actions are recommended, according to the range of the risk's scores: low (1-5), medium (6-10), high (12-15) or very high (16-25). If the risk is classified as being low, the management will be carried out according to the routine procedures, which will be regularly reviewed. If the risk is medium, there is a need to act and plan. For a high range of risk, priority actions are needed to immediately reduce the danger. For a very high risk, urgent action is needed to prevent danger, for example water supply interruption, warning people to boil water, restrictions in use, and priority actions for the immediate danger reduction.

## RESULTS AND DISCUSSION

The commune of Mănăștiur is located in Lugoj Plane, Lipova Plateau, on the upper side of Bega River (figure 1), documentary attestation being since 1427 (Monostor). It is formed by four villages Mănăștiur, Pădurani, Remetea Luncă, Topla, with a total number of 1689 inhabitants (2012), and 629 households (2012); the total surface of the commune is 41,86km<sup>2</sup>.



Coordinates: 45°52'45", 22°03'19"



**Figure 1.** Location of Mănăștiur on Romania's map.

The first step of the development of the future WSP in Mănăștiur was to contact the local authorities and the people interested to be involved in the topic, in order to establish the team that will be in charge with the safe supply of drinking water in the village. The team that was assembled includes 7 members as follows: the mayor as the head of the team, the technician in charge with the operation of the drinking water treatment and supply, the school professor of chemistry and biology, local promoter of projects, the manager of the local cake factory, the healthcare assistant, and the environmental protection officer.

The analysis of the water supply system begun with the source of drinking water, the main elements being summarized in table 3 (Vieira J. M. P., 2011).

**Table 3.** Risk analysis of the drinking water source

	<b>WATER SOURCE (catchment) – since 2007</b>
<b>Information</b>	<p><b>Ground water source</b> – 2 deep boreholes located on Bega riverside: (F1 at 152m depth, near the treatment station, F2 at 150m depth, and 206m far from F1, at the village limit. Abstraction layers are separated by clay and sandy clay. The boreholes are covered. Water is pumped. It contains ammonia in range of 2-2,22mg/l.</p> <p>Hydro geological study to determine the sanitary protection zones at 26.07.2012 by Water Basin Administration Banat. There is a 10m sanitary protection area with strict regime, but the fence is broken. Test reports for water characterization since 2005.</p>
<b>Hazard Identification</b>	<p><b>Agriculture</b> – microbiological (cow and sheep farms – manure) and chemical contamination (nitrates, pesticides).</p> <p><b>Industry</b> – chemical and microbiological contamination (factory bakery SC Cornu Boulangerie SRL, wood processing factory SC Pamirco SRL).</p> <p><b>Roads (19km) &amp; Railways and railway station</b> - chemical contamination; pesticides</p> <p><b>Households</b> – microbiological contamination (5-10% septic tanks; sewage system with waste water treatment plant that is not in operation).</p> <p><b>Recreational areas</b> - microbiological contamination (arboretum park and station parks).</p>
<b>Risk Assessment</b>	<p>Microbiological contamination: Severity = 4; Likelihood = 5; <b>Risk score = 20 (VH)</b></p> <p>Chemical contamination: Severity = 3; Likelihood = 4; <b>Risk score = 12 (H)</b></p>
<b>Control Measures</b>	Management of catchment area and reservoir
<b>Monitoring</b>	Points of discharge of pollutants, raw water quality.
<b>Actions in case of MAC exceeding</b>	Adjusting the treatment process.

Water quality at source was characterized by samples taken in October 2005 from a borehole at 83m, located near the Village Hall, and one at 90m, located at school. The samples were analyzed 6 days later in a certified laboratory. The concentration of ammonia was 2mg/l, exceeding the MAC of 0.5 mg/l. Time between sampling and analysis was too long to have accurate results especially for ammonia and COD, and the value of hardness was misinterpreted.

Analysis of data on source and catchment area shows that: (i) Ground water source contains ammonia exceeding MAC; (ii) Boreholes have a fenced sanitary protection zone, but fence is broken; (iii) Test reports from hydro-geological study are incomplete for characterizing raw water quality (e.g. no microbiological test report for water); (iv) There are no test reports to confirm or infirm the real level of contamination. The risk score for microbiological contamination was estimated at 20 (VH), and for chemical contamination at 12 (H).

Very high and high risk scores require urgent/priority actions and control measures such as: (i) Management of polluting activities within the catchment area; continuous communication with National Administration of Romanian Waters (ANAR) and Environmental Protection Agency (APM); (ii) Registration of chemicals that are used; (iii) Control of human activities; (iv) Control of waste water discharge; (v) Regular inspections on catchment area; (vi) Repair the fence of the sanitary protection zone; (vii) Monitoring the water quality at the discharge points of industry; (viii) Monitoring raw water quality more regular and for the parameters of interest (e.g. spring and autumn); (ix) Acquire information to ground the adjustment of the treatment process, especially the disinfection (Wright J. et al., 2003).

The analysis of the water treatment station is summarized in table 4.

**Table 4.** Risk analysis at the drinking water treatment station

	<b>TREATMENT STATION – since 2007</b>
<b>Information</b>	Adduction pipe from borehole to the station (HDPE, 473m); Mono-block treatment plant, flow 3.53 l/s; Container with 2 contact tanks with sodium hypochlorite as disinfectant, and 3 fast filters with granular active carbon.
<b>Hazard Identification</b>	There is an operating manual; maintenance is outsourced to ALEX CARM SRL Oradea. Microbiological and chemical contamination (nitrates and pesticides) from the catchment area; Ammonia exceeding the MAC in the raw water; Power failure once at 3-4 months for 2-3 min to hours; Because of ammonia there is a high consumption of disinfectant being difficult to assure the free residual chlorine (disinfection marker); The use of pesticides in the catchment can generate a situation in which the active carbon is reaching faster its adsorption capacity; Power failure – likelihood of having an ineffective treatment, especially for disinfection with the consequence of supplying into network water that is not under control. Water analysis at the exit of the treatment station is not carried out regularly, not even for free residual chlorine.
<b>Risk Assessment</b>	Microbiological contamination: Severity = 4; Likelihood = 5; <b>Risk score = 20 (VH)</b> Chemical contamination: Severity = 3; Likelihood = 3; <b>Risk score = 9 (M)</b>
<b>Control Measures</b>	Check water demand for chlorine and the efficiency of the sodium hypochlorite; Check if the active carbon is outworn; Daily check (automatic) control of free residual chlorine at the exit of treatment station; Treatment process monitoring, warning systems, automatic/manual shutdown of water supply to the network.
<b>Monitoring Actions in case of MAC exceeding</b>	Raw water, treatment process, disinfected water supplied to the network (final product). Adjusting the treatment process.

Analysis of the data on the treatment station for drinking water shows that: (i) National Regulatory Authority for Community Utilities Services (A.N.R.S.C.) issued the license no.

1907/16.03.2012, class 3 (for a number smaller or equal to 50,000 residents), valid until 16.03.2017 for the water service in Mănăștiur; (ii) Microbiological contamination from catchment area needs careful disinfection; Ammonia exceeding the MAC in raw water, use of sodium hypochlorite and power failures indicate the likelihood of ineffective treatment, especially for disinfection, resulting in water that is not under control being supplied into the network; (iii) Chemical contamination (pesticides) from the catchment area might fasten the reach of adsorption capacity of active carbon; (iv) Estimated microbiological and chemical contamination and its removal by treatment is hard to confirm or deny due to lack of records/test reports on water quality. The risk score for microbiological contamination was estimated at 20 (VH), and for chemical contamination at 9 (M).

Very high risk score for microbiological contamination requires urgent actions, and medium risk score for chemical contamination requires acting, planning and preparing as follows: (i) Optimization of treatment process and automated control; (ii) Approval and control of reagents and materials used in treatment; availability of reserves (including a power generator); (iii) Regular monitoring of quality of raw water and drinking water at the exit of water work, especially for the level of free residual chlorine (Mintz E. et al., 2001).

Length of drinking water supply network is of 19.2km ( Mănăștiur 8,2 km; Remetea Luncă 5 km; Pădurani 2 km; between Mănăștiur and Remetea Luncă 4 km). The analysis of the distribution network is summarized in table 5.

**Table 5.** Risk analysis of the distribution network

<b>DISTRIBUTION NETWORK – since 2007</b>	
<b>Information</b>	Stainless steel storage tank for treated water above the ground (200mc), located in the sanitary protection area; water flows by gravity from storage tank into the distribution network; 8226m distribution network of HDPE; 19 street taps; 90% of the households are connected; maintenance is carried out by 2 persons with high school; electricity interruptions (minutes – 5 hours).
<b>Hazard Identification</b>	Water within the supply network is not protected by the residual disinfectant. Plastic pipes are in favor of the bio film formation, and microbiological growth. Power failures generates interruption in water supply, which can raise a hazard if the pipes of the network are broken (no information about this issue) and the pressure decrease; high water consumption/ day/ person might suggest leaks but also the use of water for irrigation).
<b>Risk Assessment</b>	The description of the situation suggests a risk of microbiological non-compliance (including the exceeding of the oxidability/COD) that is not confirmed by the 2 test reports that were available. The monitoring program approved by public health authority is not followed or the records were not handed to the project team. Microbiological contamination: Severity = 4; Likelihood = ?; <b>Risk score = ? (?)</b> Chemical contamination: Severity = 3; Likelihood = ?; <b>Risk score = 9 (M)</b> the same as at the exit of the treatment station
<b>Control Measures</b>	Operational procedures, approved materials, valve status.
<b>Monitoring</b>	Flow, pressure, residual disinfectant concentration.
<b>Actions in case of MAC exceeding</b>	Discharge, flushing pipes, advising people to boil water.

Analysis of the data on the distribution network shows that: (i) There is no free residual chlorine in the water supplied to the consumers, i.e. there is no protection against microbiological growth; (ii) Test reports for microbiological quality of water show no exceeding of limit values; (iii) The frequency of water quality testing is too low, and too few parameters are checked to really characterize the final product supplied to the consumers; (iv) Although there is no free residual chlorine in the network, the amount of organic matter exceeds the MAC, and plastic pipes favors bio film formation, microbiological parameters show no exceeding; (v) Water consumption based on answers at 18 questionnaires is in range



of 6,66 – 50l/person/day (mean value = 18) by comparison with data from the monitoring program showing a range of 125 – 303 l/person/day, suggesting leaks might exist in the supply network; (vi) Electricity interruption may cause pump failure and pressure drop in the network; (vii) There are no sufficient data to estimate the microbiological risk. The assumption regarding chemical risk is that it stays as it was on exiting water work after treatment stage, in the best case, but can increase (insufficient information). Risk score for microbiological contamination is unknown. For the chemical contamination risk score the assumption is that remains the same as it is on exiting the treatment station 9 (M).

Risk score for microbiological contamination is unknown, and medium risk score for chemical contamination (best scenario) requires acting, planning and preparation as follows: (i) Provide partial protection against microbial contamination by assuring a residual disinfectant; (ii) Maintaining positive pressure in the distribution system; (iii) Maintenance of the distribution system; (iv) Introduction of backflow prevention devices; (v) Ensure the integrity of storage and distribution systems; (vi) Adequate procedures for repairs and subsequent disinfection of piping.

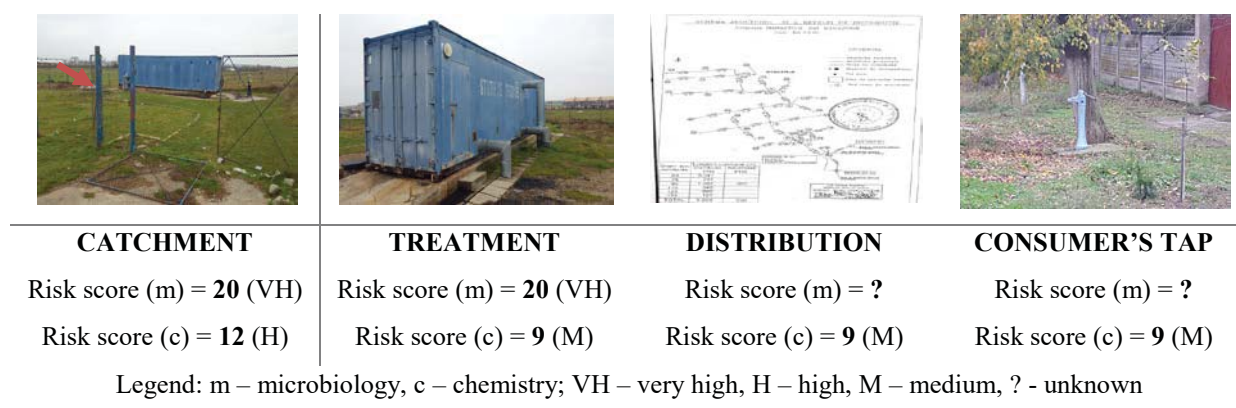
Providing a safety barrier against contamination after treatment during the transport of water is the last chance.

The analysis of the tap water is summarized in table 6.

**Table 6.** Risk analysis at consumers' the tap

	<b>TAP (Consumer)</b>
<b>Information</b>	Type of premises: factory bakery SC Cornu Boulangerie SRL, wood processing factory SC Pamirco SRL, railway station, 2 schools, 2 kindergarten, 5 sanitary institutions, 2 cultural institutions, 629 households (90% of households are connected to centralized water supply), 1689 persons. Distribution network materials: HDPE, 19,2 km.
<b>Hazard Identification</b>	Not identified, no information about siphonage, leakage from pipelines, hygiene.
<b>Risk Assessment</b>	Not enough information. Microbiological contamination: Severity = 4; Likelihood = ?; <b>Risk score = ? (?)</b> Chemical contamination: Severity = 3; Likelihood = ?; <b>Risk score = 9 (M)</b> the same as at the exit of the treatment station
<b>Control Measures</b>	Regulation of sealing elements (gaskets), education.
<b>Monitoring</b>	Inspection of premises.
<b>Actions in case of MAC exceeding</b>	Advising consumers.

The overview of the risk analysis along the drinking water supply system in Mănăștiur is shown in figure 2.



**Figure 2.** Water Supply System in Mănăștiur and Risk Scores along the supply chain

## CONCLUSIONS

The recommendations made to the WSP team were to take immediate measures to control the microbiological risk and to control the free residual disinfectant. For a local form of association undertaking the responsibility for the provision of drinking water to people as in Mănăștiur, regular training of staff and technical assistance on the process of water treatment is recommended (i.g. by the Regional Operating Company Aquatim) in order to build capacity for improved management. Putting into operation the wastewater treatment plant and restricting grazing areas so that animals no longer exist in the catchment area are measures to be taken, as well as communication and cooperation with all stakeholders in the catchment (Smet Jo., 2002). Based on these experiences, the elaboration of an adapted WSP guideline for small drinking water supply systems would be useful in rural areas of Central and Eastern Europe.

This work was developed in the frame of the project FKZ 16EXI119-1 “Water and Sanitation Safety Planning in Romania and FYR Macedonia“, funded by the export initiative Environmental Technologies, German Ministry for Environment, Nature Protection and Nuclear Safety.

## REFERENCES

- Directive 2015/1787/EU, Official Journal of the European Union L260/6, 7.10.2015, <http://eur-lex.europa.eu/legal-content/EN/TXT/> (accessed 12 July 2017).
- Gelting R. J. et al., 2012. A conceptual framework to evaluate the outcomes and impacts of water safety plans. *Journal of Water, Sanitation and Hygiene for Development* **2**(2), 103–111.
- Guidelines for Drinking water Quality* 2011 4<sup>th</sup> Eds, WHO, Geneva, Switzerland.
- Mintz E., Bartram J., Lochery P., Wegelin M. 2001. Not just a drop in the bucket: Expanding access to point of use water treatment systems. *American Journal of Public Health* **91**, 1565-1570.
- Samwel M., Wendland C. Eds., 2016. *Compendium to develop a Water and Sanitation Safety Plan in a Rural Community*. WECF.
- Smet Jo., van Wijk C. Eds., 2002. *Small Community Water Supplies Technology, People and Partnership*. Technical Paper Series 40, IRC International Water and Sanitation Centre, Delft, The Netherlands.
- String G. 2016. A systematic review of outcomes and lessons learned from general, rural, and country-specific Water Safety Plan implementations. *Water Science and Technology: Water Supply* **16** (6), 1580-1594.
- Water Safety Plan Manual, Step-by-Step risk management for drinking-water suppliers* 2009. WHO, IWA, Geneva, Switzerland.
- Vieira J. M. P. 2011. A strategic approach for Water Safety Plans implementation in Portugal, *Journal of Water and Health* **9**(1), 107-116, IWA Publishing.
- Wright J. et al., 2003. Household drinking water in developing countries: a systematic review of microbiological contamination between source and point-of-use. *Trop. Med. & Int'l Health* **9**(1), 106-117.

# Implementation of small wastewater systems in existing centralized water infrastructures - low population density case study

Ref # S2SMALL- 44796

Campusano Garcia, C.<sup>1\*</sup>, Kaufmann Alves, I.<sup>2</sup>

<sup>1</sup> Institute of Urban Water Management, Department of Civil Engineering, University of Kaiserslautern, Paul-Ehrlich-Str. 14, 67663 Kaiserslautern, Germany

<sup>2</sup> Water and Urban Water Management, School of Technology, University of Applied Sciences Mainz, Holzstr. 36, 55116 Mainz, Germany

\* Presenting Author: Claudia Campusano Garcia, [claudia.campusano@bauing.uni-kl.de](mailto:claudia.campusano@bauing.uni-kl.de)

**Keywords:** dynamic modeling; resource-oriented sanitation; rural areas; conventional wastewater infrastructure

## INTRODUCTION / MAIN METHIODES

In low population density areas in Germany existing wastewater infrastructures have been coping for many years with various key challenges such as demographic decline, climate change and stricter discharge standards. Furthermore, the increasing requirements for resource efficiency and environmental sustainability has prompted investigations into the development of adaptation concepts for water supply and wastewater discharge as well as dimensioning methods and assessment variables (cf. Kaufmann Alves, 2013). Even at modified volume flows and compositions water infrastructures must remain reliable at all times in order to guarantee a sustainable urban water management. This work aimed to assess the impact of the implementation of resource-oriented sanitation systems in existing infrastructures. Modeling or simulation of urban water systems by means of detailed numerical models is a key driver for planning and assessing system behaviors (cf. Blumensaat et al., 2012). Yet, only a few studies were carried out as an integrative simulation approach using dynamic models for innovative sanitation concepts (cf. Ormandzhieva et al., 2014); the application focus has been laid so far either on the wastewater treatment or sewer network but not on both. This study intended thus to gain insight into the temporal behavior of wastewater systems within a holistic approach using a simulation model.

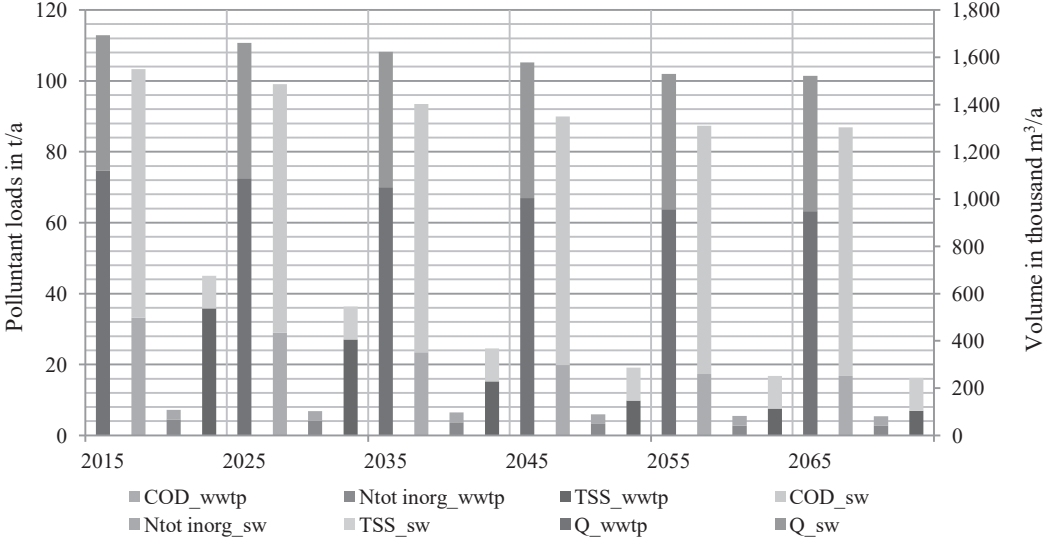
The case study area is a catchment area within a rural community in Germany with 541 ha (correspondingly 227 ha of impervious area), which mainly discharges in a combined sewer system with a stormwater storage volume of 3000 m<sup>3</sup>. The wastewater treatment plant (WWTP) with a capacity of 21.000 population equivalents (PE) was constructed in 1996; currently 17.000 PE, thereof 12.500 inhabitants, are connected to the facility. The catchment area was modelled using the software SIMBA# Version 2.0, in which the sewer hydraulics is represented by a hydrological mathematical data model. Within the sewer system the parameters COD, TKN and P<sub>tot</sub> were modelled and fractionated at the WWTP inlet according to the activated sludge model ASM3 (cf. Gujer et al., 2000). The activated sludge tank consisted of 4,120 m<sup>3</sup> with 805 m<sup>3</sup> Bio-P and a simultaneous denitrification. The model structure was set up according to the recommendations of the Central European Simulation Research Group (cf. Muschalla et al., 2009).

Particular emphasis was placed on examining the temporal dynamic implementation of resource-oriented sanitation systems within five-year intervals between 2015 and 2065 with 0 and 100% feasibility degree of implementation respectively. Four scenarios described esti-

mates for adaptation and transformation pathways within wastewater systems in rural areas to decentralized systems (cf. Schmitt et al. 2016).

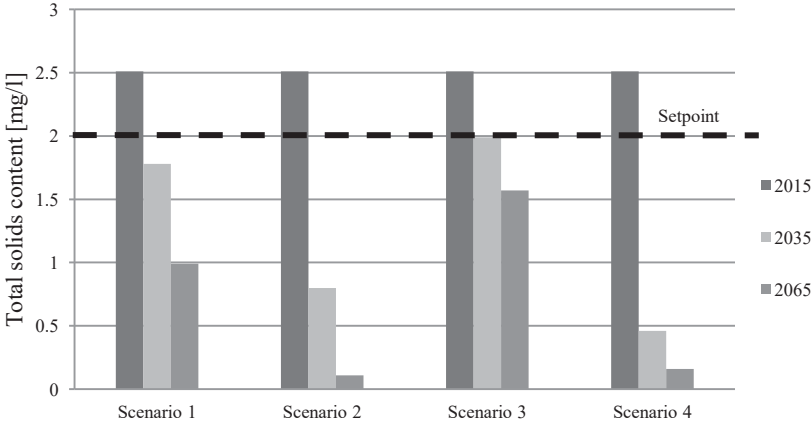
**MAIN RESULTS AND CONCLUSIONS**

Demographic decline and implementation of source-separated sanitation led to a stepwise decrease of the discharge volume flows and pollutant loads (cf. Fig. 1).



**Figure 1.** Total emissions into the receiving body of water the from stormwater and the WWTP outflow

Without the consideration of further planning measures initial results indicated a deterioration of the WWTP operation under all investigated scenarios. The WWTP showed performance constraints already in the midterm of the observation time, e.g. with regard to the total solids content in the biological stage, which was found to be very low and thus taken as a definite set point (cf. Fig. 2). This knowledge may also contribute to a better understanding of the adaptation potentials for wastewater decentralization in rural areas.



**Figure 2.** Total solids content in the activated sludge tank for the years 2015, 2035 and 2065

Further findings for a definite catchment area can only be drawn by consideration of specific boundary conditions.

## REFERENCES

Blumensaat, F.; Wolfram, M.; Krebs, P., 2012. Sewer model development under minimum data requirements. *Environ. Earth. Sci.*, 65, 1427-1437

Gujer, Willi; Henze, Mogens; Mino, Takahashi; van Loosdrecht, Mark (ed.), 2000. *Activated Sludge Models ASM1, ASM2, ASM2d and ASM3*: IWA Publishing

Kaufmann Alves, I., 2013. A mathematical approach to find long-term strategies for the implementation of resource-orientated sanitation. *Wat. Sci. Technol.* 67 (7), S. 1442–1454

Muschalla, D.; Schütze, M.; Schroeder, K.; Bach, M.; Blumensaat, F.; Gruber, G. et al., 2009. The HSG procedure for modelling integrated urban wastewater systems. *Wat. Sci. Technol.* 60 (8), S. 2065–2075

Ormandzhieva, Z., Schütze, M., Alex, J., 2014. Modelling and Simulation of New Sanitation Concepts, *Proceedings of 13th International Conference on Urban Drainage*, Surawak, Malaysia, 7 - 12 September 2014

Schmitt, T.G.; Wölle, J.; Dilly, T.C.; Baron, S.; Knerr, H.; Steinebach, G; Hoek, J.; Rumberg, M.; Krumke, S.O.; Thielen, C.; Holzhauser, M. et al., 2016. Final report of the joint research project: Cross-sectoral optimization of transformation processes in municipal infrastructures in rural areas. University of Kaiserslautern

# Wastewater treatment for small communities in tropical conditions: performances technologies comparison in real conditions.

Ref # S2SMALL- 83806

R. Lombard Latune<sup>1\*</sup>, F. Lericquier<sup>1</sup> and P. Molle<sup>1</sup>.

<sup>1</sup> Irstea, Freshwater Systems, Ecology and Pollutions Research Unit, 5 rue de la Doua, BP 32108, 69616 Villeurbanne, France

\* Presenting Author: [remi.lombard-latune@irstea.fr](mailto:remi.lombard-latune@irstea.fr)

**Keywords:** activated sludge, performances comparison, pond, rotative biological contactor, tropical, vertical flow constructed wetland.

## INTRODUCTION

Wastewater management in the French Overseas Territories (FOT) are lagging behind France mainland and both French and European regulations. Consequences lead to numerous issues regarding environment (the FOT represent 80% of the French national biodiversity), sanitary problems, and socio-economic activities. Municipalities are characterized by resources weakness in terms of self-financing capacities as well as skilled human resources for maintenance. Treatment technologies selection and choices made for systems designs are suffering from missing knowledges on their operation in tropical conditions. When applied by private developers the choices tend towards favoring compact systems, easy to install, more affordable and which are saving space for constructions. Nevertheless, tropical conditions (heat, humidity, salinity, extreme rain events and low redox conditions at the outlet of the sewer), poor maintenance and spares parts importations induce many systems dysfunctions.

Implementing a wastewater treatment plant (WWTP) in tropical conditions requires feedbacks on technologies behaviour under the tropics and knowledge of raw wastewater in order to adjust system design. Consequently a study has been conducted to compare treatments technologies performances, in real operating conditions, in order to optimize public investment by implementing suited systems to local constraints. The study has been focused on the five FOT (Martinique, Guadeloupe, Mayotte and La Réunion islands and French Guyana) and treatment plant capacities between 20 and 2 000 people equivalent (p.e.).

## MATERIAL AND METHODS

A data-base of 24 h flow composite samples has been built with data gathered from 2 different sources:

- According to French regulation, WWTP self-monitoring has to be performed and sent to local water authorities. Those data are available from the FOT since 2012. The number of 24-hours flow-composites sample campaigns depends on plant size: 1 per 2 years from 200 to 500 p.e., 1 per year from 500 to 1 000 p.e. and 2 per year from 1 000 to 2 000 p.e. As there is no obligation for treatments systems below 200 p.e., such plants have been identified, but



few data are available. The following analyses are performing on the samples: COD, BOD<sub>5</sub>, TSS, TKN, N-NH<sub>4</sub>, N-NO<sub>2</sub>, N-NO<sub>3</sub>, P-PO<sub>4</sub>, TP, pH, conductivity and flow measurements.

- Local water authorities had occasionally carried out studies on specific technologies, local area, or precise capacity. When they are based on 24-hours flow-composites sample campaigns, results were added to the data-base.

The database achieved consists of 267 WWTP, and about 1 200 sampling campaigns. A validation step, through raw wastewater data was performed. It aimed at removing inconsistent data or outliers. Reliability has been evaluated statistically (PCA and Chauvenet's criterion tests) on both inlet pollutants concentrations and ratios between them, such as COD/BOD<sub>5</sub>, TKN/COD, TSS/COD and NH<sub>4</sub>-N/TKN. With a small amount of data removed (from 0.59% for COD to 3.29% for NH<sub>4</sub>), the database gained consistency (reduction of standard deviation: from 92.5% for COD to 13.9% for NH<sub>4</sub>).

In order to improve WWTP design, raw wastewater in tropical area has been characterized and a definition of the tropical p.e. is given. Those results are compared to domestic wastewater values defined from a previous study about domestic wastewater characteristics in French rural areas (<2,000 p.e.) (Mercoiret *et al.* 2010).

The second part of the study focuses on treatments systems. The WWTP sample is described regarding the treatment technology, and their performances in terms of removal efficiency and outlet concentrations are compared.

## RESULTS AND DISCUSSION

### Characterization of tropical raw waste water

Regarding the range of variations for the concentrations of pollutants in raw wastewater (Table 1), the differences of mean values between FOT and France mainland are not significantly different, except for BOD<sub>5</sub> and NH<sub>4</sub>. However, carbon and TSS upper bound values are higher in the FOT, showing that highly concentrate wastewater can reach the treatment systems.

**Table 1.** Means and range of variations for the main pollutants concentrations in raw wastewater of small communities (< 2 000 p.e.) in French Overseas Territories (FOT) and France Mainland (FM). Mainland values come from Mercoiret *et al.* 2010. Bounds correspond to the 5th (lower) and 95th (upper) percentiles.

		BOD <sub>5</sub> (mgO <sub>2</sub> /L)		COD (mgO <sub>2</sub> /L)		TSS (mg/L)		TKN (mgN/L)		NH <sub>4</sub> (mgN/L)		TP (mgP/L)	
		FOT	FM	FOT	FM	FOT	FM	FOT	FM	FOT	FM	FOT	FM
<b>Mean</b>		<b>340</b>	<b>265</b>	<b>653</b>	<b>646</b>	<b>300</b>	<b>288</b>	<b>65</b>	<b>67</b>	<b>49</b>	<b>55</b>	<b>8.8</b>	<b>9.4</b>
Range of variations	Upper bound	800	570	1512	1341	825	696	129	123	97	98	19	18
	Lower bound	50	39	125	122	55	53	16	14	11.4	12	2.4	2
Number of values		1425	10491	1464	10491	1439	10470	713	9605	661	4381	798	9374

When flow measurements were available, pollutants fluxes per p.e. were calculated based on the definition of 60 gBOD<sub>5</sub>/p.e./d. Daily p.e. production loads are presented in Table 2. All values are significantly different between tropical and French rural p.e. The main distinction

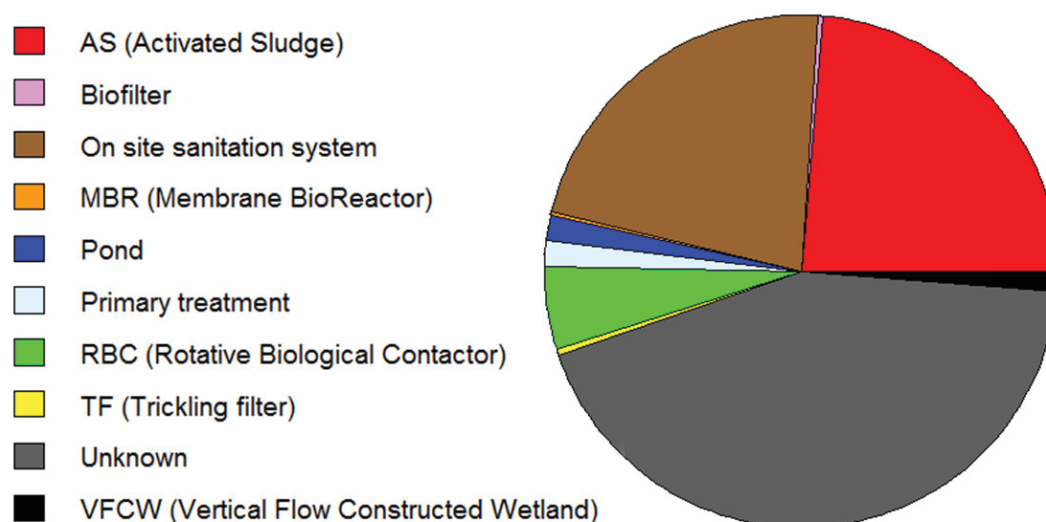
concerns COD production in the FOT (-16%), otherwise pollutants remain by between +/- 10%. Consumption behaviour with fewer chemicals might explain this smaller amount of COD. Based on these considerations, we proposed to use pollutant p.e. production of 60/130/65/17/2.5 g/d for small communities in FOT for BOD<sub>5</sub>/COD/TSS/KN/TP respectively.

**Table 2.** Comparison of the French rural p.e. (Mercoiret et al. 2010) and the tropical p.e.

	BOD <sub>5</sub> (gO <sub>2</sub> /d)	COD (gO <sub>2</sub> /d)	TSS (g/d)	TKN (gN/d)	N-NH <sub>4</sub> (gN/d)	TP (gP/d)
p.e. in French rural areas	60	157	72	15.5	11.,5	2.1
Tropical p.e.	60	133	64	17.7	13	2.8

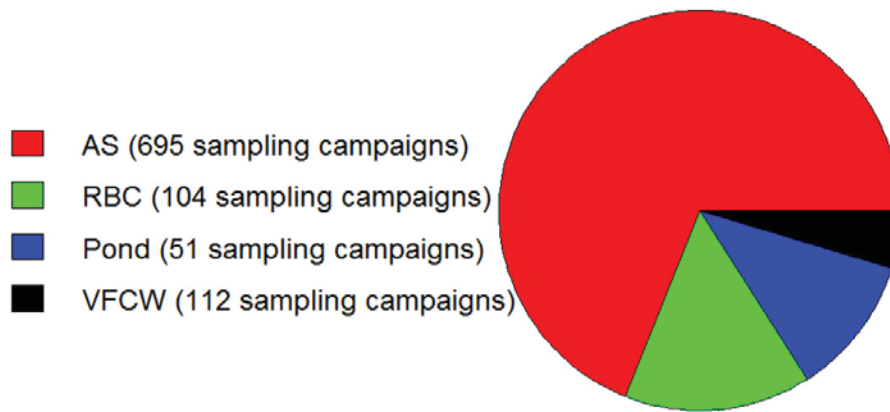
### Small wastewater treatment systems in the FOT (20 to 2 000 p.e.)

About 900 WWTP under 2 000 p.e. have been identified in the FOT (Figure 1). Amongst them, a large part of the treatments systems remains unknown (42%) or belongs to on-site sanitation systems (22%). As no data were available for those categories (no obligation < 200 p.e.), they have not been included in the study. Activated sludge is the main technology implemented in the FOT.



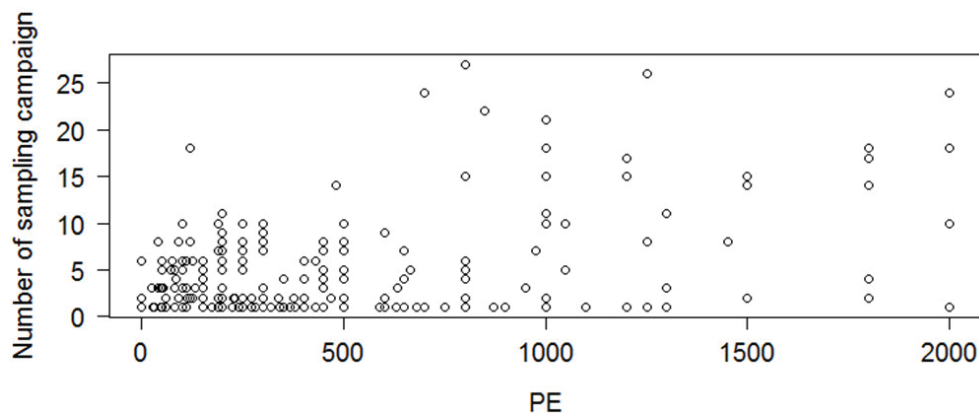
**Figure 1.** Repartition of the different treatment technology in the FOT (900 WWTP identified between 20 and 2 000 p.e.).

The database with consistent information counts 267 WWTP for capacities below 2,000 p.e. Four treatments systems (biofilters, membrane bioreactors, primary treatment, trickling filters) were removed because the corresponding number of units was too low (<10). Due to contradiction or lack of information, uncertainties regarding the treatment types remain for about forty plants. They were also excluded for treatment technology evaluation. Finally, four technologies (activated sludge, pond, rotating biological contactor, single stage vertical flow constructed wetland) representing 213 plants and 962 sampling campaigns were usable for performances assessments (Figure 2).



**Figure 2.** Proportion of the four technologies studied represented in the database (213 WWTP).

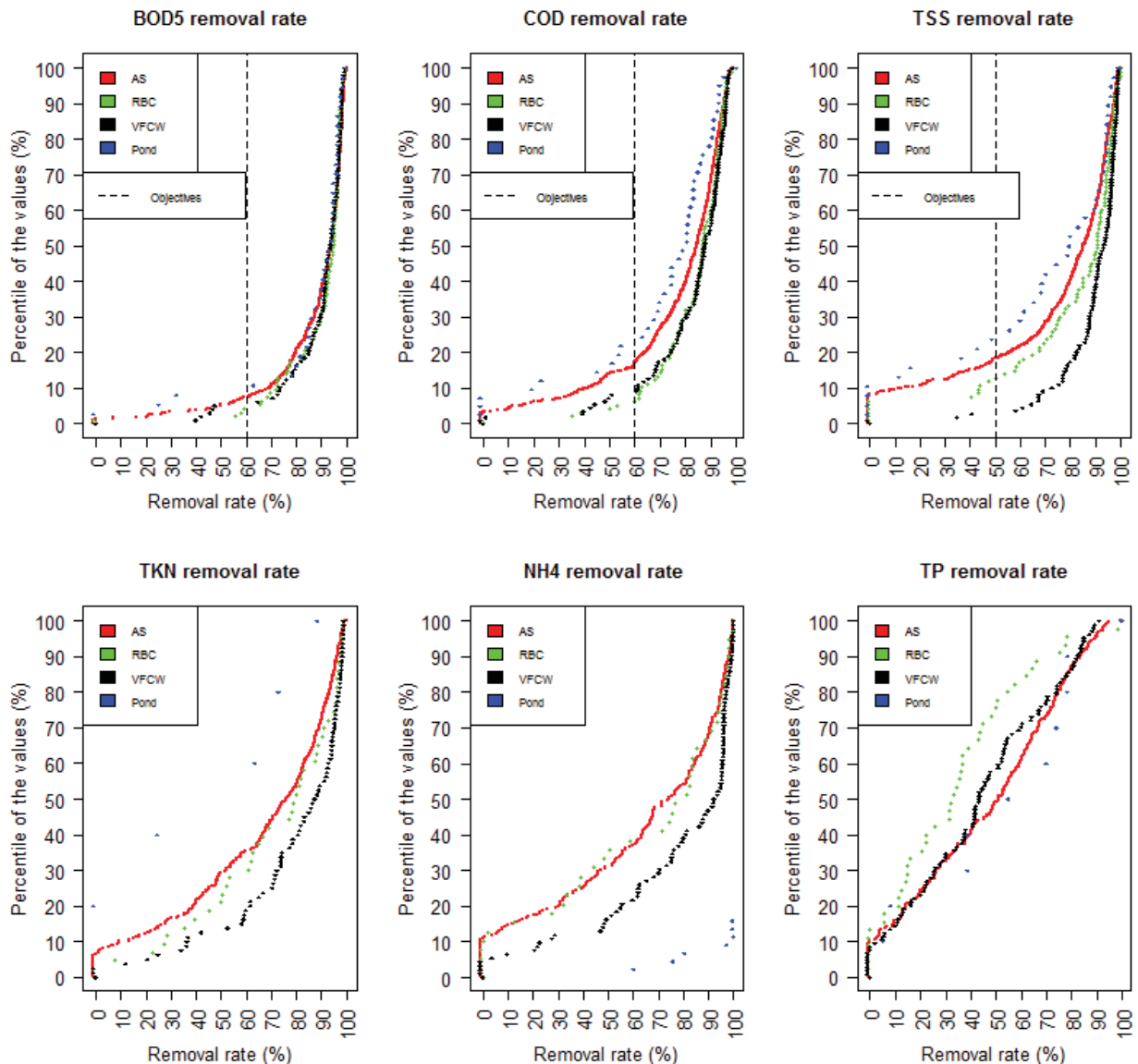
The number of 24-hours flow-composites sample campaigns per WWTP (figure 3) is homogeneous regarding capacities and is below 25. At technology level, average number of sampling campaigns per unit varies from 10 for the VFCW to 3.5 for RBC.



**Figure 3.** Number of sampling campaigns per treatment plant.

Performances of the different treatments technologies are presented in terms of removal efficiency (Figure 4) and outlet concentrations (Figure 5). They are discussed regarding the French minimal regulation objectives (removal rates: 60/60/50% for BOD<sub>5</sub>/COD/TSS or outlet concentrations below 35/200 mg/L for BOD<sub>5</sub>/COD) and classical more ambitious ones (25/125 mg/L for BOD<sub>5</sub>/COD and 70% removal rate for NTK). Values achieved are presented in Table 3.

Despite the fact that activated sludge is the most implemented technology, results show that it is the least reliable one. About 17 – 18 % of the campaigns are below the minimal removal regulatory objectives for TSS and COD and almost 30 % of the BOD<sub>5</sub> outlet concentrations are beyond the regulation. This is mainly due to sludge leakage or washout during the intense tropical rainy events. Removal rates of 0 % are observed for TSS in about 10% of the sampling campaigns sludge due to leakage. AS well, the absence of nitrification on about 12 % of the campaigns shows that maintenance of the systems can suffer from negligence.



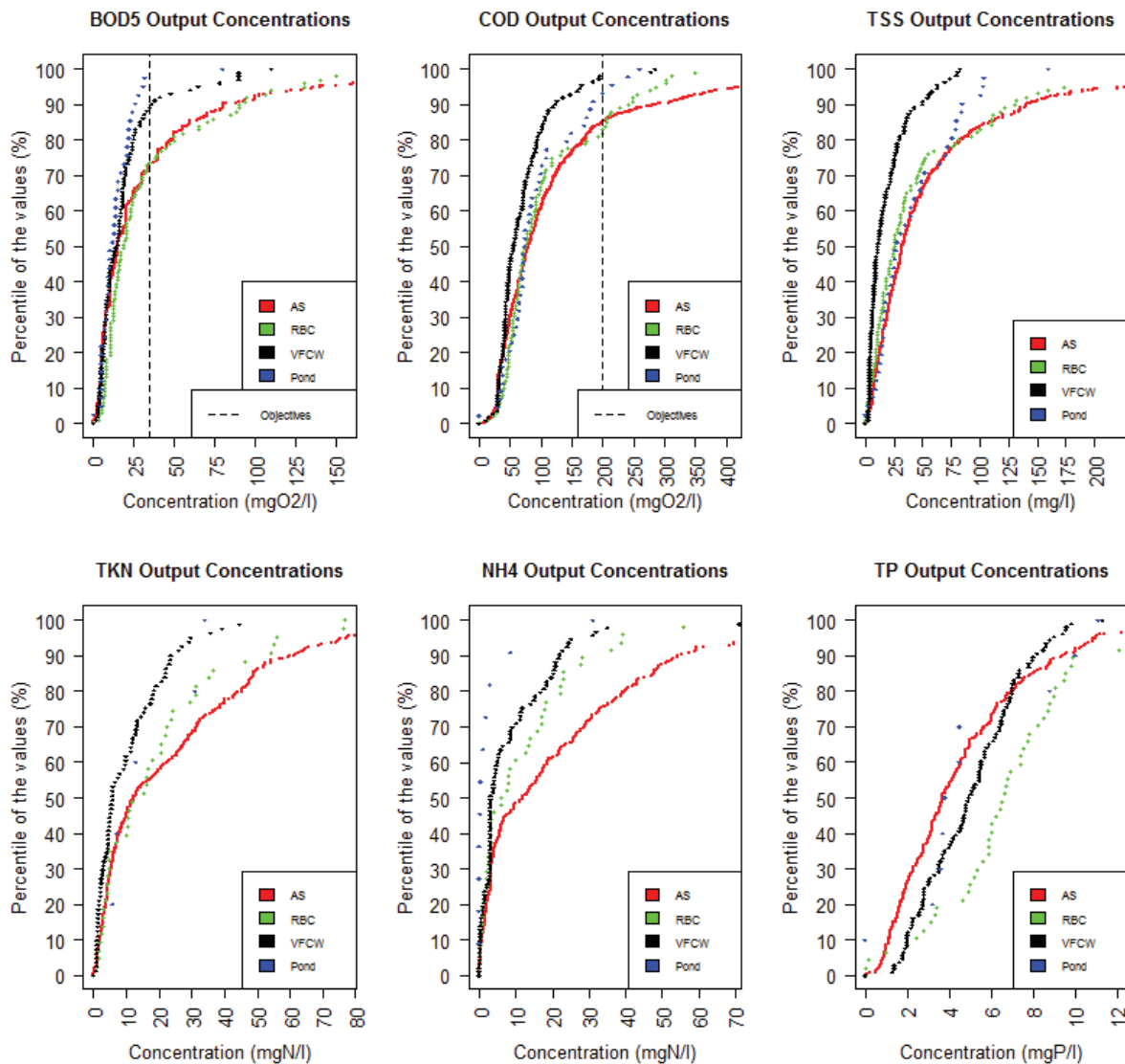
**Figure 4.** Removal efficiency of the treatments technologies for the main pollutants.

Ponds show the same type of pattern: weak removal rates, low removal rate for COD and TSS for about 10% of the campaigns. However outlet concentrations are better (93.2% COD comply with minimal regulation), suggesting period where raw wastewater are diluted and the system still releasing algae. Indeed, effluent of ponds system usually has high concentrations of suspended solids, mainly due to algae production (Luduvicé et al., 2001); it reduces the efficiency when influents are diluted.

Rotatives biologicals contactors have the weakest COD outlet concentration conformity (82%). Their performances in terms of removal rates are much better (close to 95%) for carbon loads, but with 13% of samplings below the regulation objectives for TSS, sludge leakages may occur in the settling stage. The clarifiers are effectively often a sensitive step regarding storm events and sludge management.

Vertical flow constructed wetland is the most reliable technology. It fulfills all the objectives at a frequency of 90 to 95%. The percentages of removal rates below minimal regulation for BOD<sub>5</sub>/COD/TSS are respectively 5/9/3.1%. Regarding outlet concentrations over 90% of the samples achieve a higher standard for COD. Performance on NTK are also the best observed

(75% over 70% removal), even if it is lower than the one usually mentioned on VFCW (Molle et al., 2005). VFCW in the FOT has mainly a single stage; full nitrification is out of range in this configuration.



**Figure 5.** Outlet concentrations of the 4 treatments technologies.

**Table 3.** Compliance percentage by treatment technologies regarding different level of objectives. In grey, the French minimal regulation objectives.

	< 35 mgBOD5/L	< 25 mgBOD5/L	< 200 mgCOD/L	< 125 mg COD/L	BOD Removal > 60%	COD Removal > 60%	TSS Removal > 50%	NTK Removal > 70%
AS	71.6%	65.4%	85.2%	70.6%	92.5%	82.8%	81.5%	56.1%
Pond	96.5%	89%	93.2%	78.4%	89.5%	76.5%	75.8%	-
RBC	73.7%	63.7%	82%	75.3%	95.5%	93.7%	87.1%	57.8%
VFCW	89.1%	81.2%	98.5%	90.7%	95%	91%	96.9%	75.2%

## CONCLUSIONS

Comparison of raw wastewater from small communities in the FOT and in French rural areas shows no major differences in terms of average concentrations. Upper bounds of the ranges of variations suggest that sometimes, highly concentrates influents reach the WWTP. The p.e. pollutants production has been evaluated at 60/130/65/17/2.5 g/d for small communities in FOT for BOD<sub>5</sub>/COD/TSS/KN/TP respectively.

Performances comparison on the 4 treatments technologies gives important feedbacks:

- Activated sludge is the least reliable technology evaluated in the FOT. Sludge leakages are noticeable on 10% of the campaigns. Lack of nitrification observed suggests maintenances troubles.
- At low loads, algae prevent ponds from achieving French minimal regulation objectives for the removal rates.
- Settling troubles have been identified on RBC.
- With all the regulatory objectives fulfill with a 90-95% frequency, VFCW is the most reliable technology. It requires space and can't be implemented everywhere, even if tropical design has reduces the footprint (0.8 m<sup>2</sup>/p.e.). VFCW can reach high level performances (125 mgCOD/L), but shows also its limits (70% of NTK removal achieved by 75% of the sampling campaigns). Designs adjustments like unsaturated/saturated system or higher filtration layer enable adaptation to different objectives.

## REFERENCES

- Luduvicé, M.L., Neder, K.D., Queiroz, T.R. and Souza, M.A.A. (2001). *Sólidos suspensos como indicador da densidade de algas em lagoas de estabilização. The use of TSS as algae growth indicator in stabilization ponds*. 21° CABES, João Pessoa, Brasil, 2001.
- Mercoiret, L., Molle, P. & Forquet, N., 2010. Domestic wastewater characteristics in French rural areas: concentrations and ratios for treatment plant under 2000 population equivalent (120 kg of BOD<sub>5</sub> a day). *3rd International Smallwat Congress*, Seville, Spain.
- Molle P., Liénard A., Boutin C., Iwema A. (2005). How to treat raw sewage with constructed wetlands: an overview of the French systems. *Water Science and Technology*, **51**(9), 11-21.
- Molle P., Lombard Latune R., Riegel C., Lacombe G., Esser D. and Mangeot L. 2015 French vertical-flow constructed wetland design: adaptations for tropical climates. *Water Science and Technology*, **71**(10), 1516-1523.
- Morvannou, A., Forquet, N., Michel, S., Troesch, S. and Molle, P., 2015. Treatment performances of French constructed wetlands: results from a database collected over the last 30 years. *Water Science and Technology*. **71** (9), 1333–1339.



# Characterization of the composition of dissolved organic matter during aerobic and anaerobic digestion of excess activated sludge

Ref # S2SMALL-98430

F.S. Li<sup>1\*</sup>, H.X. Du<sup>2</sup>

<sup>1</sup> River Basin Research Center, Gifu University, 1-1 Yanagido, Gifu 501-1193, Japan

<sup>2</sup> College of Urban Construction, Nanjing Tech University, Nanjing 211800, China

\* Corresponding Author: [lifs@gifu-u.ac.jp](mailto:lifs@gifu-u.ac.jp)

**Abstract:** The characteristics of dissolved organic matter formed in aerobic and anaerobic digestion of excess activated sludge were investigated using ten reactors operated for three total solid concentrations (1.2, 2.3 and 5.2 %) and three temperatures (5, 20 and 35 °C). The obtained TOC results showed significantly higher values in anaerobic digestion than aerobic digestion (2.8 - 6.9 times for TS 1.2 - 5.2 % at 20 °C). Data analysis with a first-order sequential reaction model revealed clear that the higher occurrence of DOM in anaerobic digestion was a combined result of comparatively faster hydrolysis (1.3 - 5.5 times for TS 1.2 - 5.2 % at 20 °C; 1.4 - 49.3 times for temperatures 5 - 35 °C with TS 1.2 %) and slower degradation (0.3 - 1.0 times for TS 1.2 - 5.2 % at 20 °C; 0.5 - 8.3 times for temperatures 5 - 35 °C with TS 1.2 %). More humic-like substances were formed in aerobic digestion and more proteins and aromatic amino acids were formed in anaerobic digestion. The molecular weight distribution indicated that UV-absorbing DOM constituents were highly heterogeneous, and were comparatively larger in anaerobic digestion than in aerobic digestion.

**Keywords:** Dissolved organic matter; biomass; excess activated sludge; aerobic digestion; anaerobic digestion; humic substances.

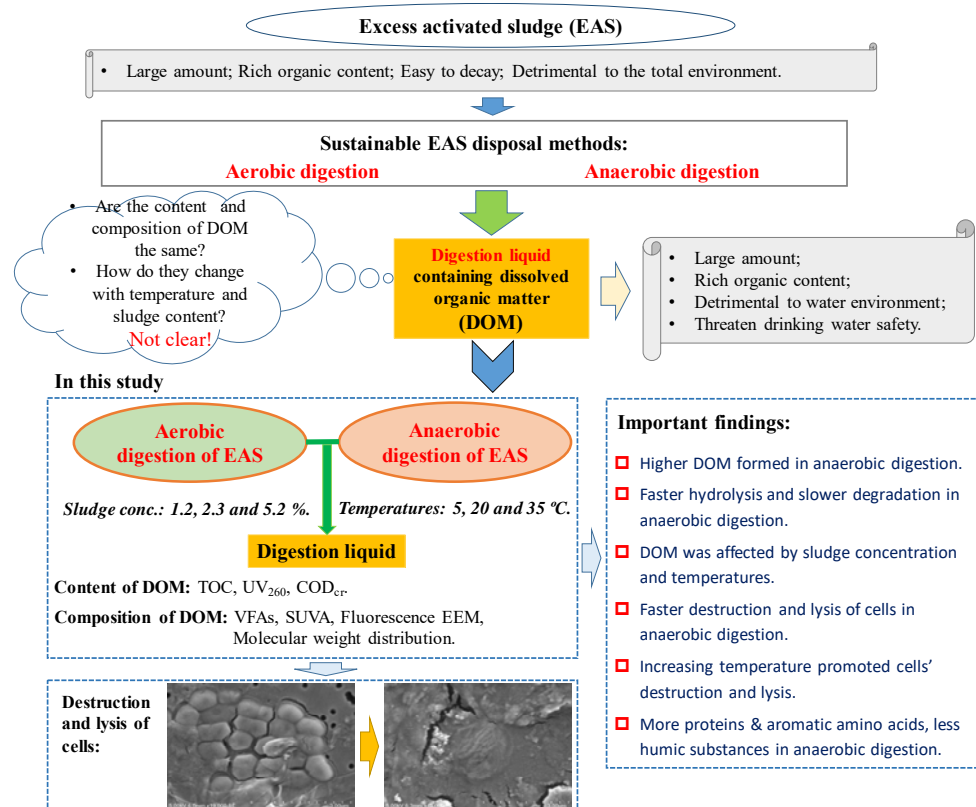
## INTRODUCTION

Population growth and rapid urbanization lead to a marked increase in the number of municipal wastewater treatment plants (WWTPs). For stabilization and effectively utilization of EAS that contains rich content of organic matter, aerobic digestion, anaerobic digestion and composting are considered as sustainable disposal options and their applications are increasing. The leachates or liquids are increasingly concerned when aerobic digestion, anaerobic digestion and composting are adopted for stabilization and effectively utilization of excess activated sludge (EAS) due to the organic matters contained therein worsen the water quality of natural water systems and produce odours (Cheng et al., 2009; Chen et al., 2012). Moreover, for drinking water production using source water merged with the leachates or liquids from the biological EAS treatment systems, the DOM also contributes to the enhanced presence of hazardous disinfection by-products in the water after treatment.

In regard of the characteristics of DOM formed in digestion, many studies have been conducted focusing on the organic constituents that affect the digestion efficiency and gas productivity (Tomei et al., 2011). However, since DOM is a complex and heterogeneous mixture of polydispersed components, further characterization of its composition requires more indexes that are well used in water quality evaluations. Activated sludge is a mixture of living cells, dead cells and some inert organic solids from the wastewater and its biological treatment process. Increasing the sludge concentration brings about more living cells to the digestion process. This may contribute to differences in the increasing extent of the hydrolysis rate, the degradation rate or both, depending on the microbial density and structures in the digestion process. Changing the temperatures of digestion may bring about changes in the

structures and activity of bacteria involved in hydrolysis and degradation of EAS. Responding to such changes, the properties of the formed DOM may change, which remain unclear in available literatures. Accordingly, the main aim of this study is to generate more information for better understanding the characteristics of DOM formed and remaining in the digestion of EAS under aerobic and anaerobic conditions.

In order to generate more information for better understanding the characteristics of DOM formed and remaining in the digestion of EAS under aerobic and anaerobic conditions, in this study, five aerobic and five anaerobic digestion reactors were operated in parallel under three different total solid (TS) concentrations (1.2, 2.3 and 5.2 %) and three temperatures (5, 20 and 35 °C). DOM was evaluated using the overall concentration indexes of total organic carbon (TOC), soluble chemical oxygen demand (SCOD) and ultraviolet absorbance at the wavelength of 260 nm (UV<sub>260</sub>), and the composition related properties, including the specific ultraviolet absorbance (SUVA), VFAs, fluorescence EEM and molecular weight (MW) distribution. Moreover, using scanning electron microscope (SEM), the destruction and lysis of cells during digestion were observed. Principal component analysis (PCA) was performed for better understanding the interrelations among all measured quality indexes and the changes of DOM properties during the digestion process. The whole concept and idea are shown in **Figure 1**.



**Figure 1.** The whole concept and idea of this study.

## MATERIALS AND METHODS

Five aerobic and five anaerobic digestion reactors were operated in parallel under three different total solid (TS) concentrations (1.2, 2.3 and 5.2 %) and three temperatures (5, 20 and 35 °C). Fresh EAS was obtained from the reaction tank of a MWTP operated in the sequential anaerobic/aerobic mode for enhanced removal of phosphorus in Gifu, Japan. The obtained sludge was subjected to concentrating immediately by settling for 4 hours, followed by

centrifuging at 3000 rpm for 5 mins. From the centrifuged sludge, three sludge samples with the total solid (TS) concentration of 1.2, 2.3 and 5.2 % were adjusted by dilution with the supernatant of centrifugation after filtration through 0.2 m membrane filter for direct use in the digestion experiments. The content of organic matter of the EAS measured by incineration loss was 75.2 %. Other measured parameter values for the obtained sludge were: temperature 25 °C, pH 6.75, DO 1.73 mg/L, ORP 159 mV and EC 29.1 mS/m. The concentration of DOM in the supernatant was: 17.7 mg/L as TOC, 13.4 m<sup>-1</sup> as UV<sub>260</sub> and 40 mg/L as SCOD.

Ten digestion reactors (namely R1 - R10), each having a volume of 500 mL, were used for the experiments. R1 - R5 were operated under aerobic condition; while, R6 - R10 under anaerobic condition. The added volume was identical: 300 mL for each reactor. Aerobic digestion was ensured by consistent air bubbling with an air pump (Power: 2.5 W, Air flow: 2 L/min); and anaerobic digestion was ensured by tightly sealing the reactors with rubber stoppers lined with Teflon sheet immediately after addition of the EAS samples. The reactors were placed on three water bath shakers adjusted to 5, 20 and 35 C, respectively, and were shaken gently to ensure uniform reactions within each reactor.

The observed TOC data under each digestion condition were analyzed using a first-order sequential reaction model that considered both hydrolysis and degradation. Based on the magnitudes of estimated rate parameters, the differences between aerobic and anaerobic digestion and the effects of TS concentrations and temperatures were discussed. Moreover, using scanning electron microscope (SEM), the destruction and lysis of cells during digestion were observed.

For simple quantitative comparison of the differences in the digestion rate of EAS under the investigated experiment conditions, the following first-order sequential reaction model was used to describe the observed concentration profiles of DOM:

$$\frac{d(C - C_{BOM})}{dt} = k_h \cdot C_a - k_d \cdot (C - C_{BOM}) \quad (1)$$

$$\frac{dC_a}{dt} = -k_h \cdot C_a \quad (2)$$

where,  $k_h$  is the rate parameter of hydrolysis and  $k_d$  is the rate parameter of degradation;  $C$  is the detected DOM concentration;  $t$  is the reaction time;  $C_{a0}$  is the total concentration subjected to hydrolysis;  $C_a$  is the concentration of the hydrolysis product (i.e., the total concentration of the formed DOM from the EAS due to hydrolysis);  $C_{BOM}$  is the initial concentration of DOM existed in the liquid phase of the EAS supplied to each reactor, referred here as background organic matter (BOM). For fresh EAS, BOM is mainly consisted of the dissolved organic substances remaining in the water after biological treatment and is generally considered least or non-biodegradable. From the above two equations, the following solution can be obtained:

$$C = \frac{k_h \cdot C_{a0}}{k_d - k_h} \cdot (e^{-k_h \cdot t} - e^{-k_d \cdot t}) + C_{BOM} \quad (3)$$

Since TOC is more appropriate than COD and UV<sub>260</sub> for complete quantification of DOM, in this study, the observed concentration profiles of TOC were used for searching the rate parameters  $k_h$  and  $k_d$  under all experiment conditions. The searching was made by minimizing the relative error defined by the following equation (Eq. 4) between the observed TOC concentrations and the calculated ones from Eq. 3. For  $C_{BOM}$ , since the supernatant of the obtained sludge after centrifugation and filtration was used to dilute the centrifuged sludge for the experiment, its value was the TOC concentration of the supernatant (17.7 mg/L).  $C_{a0}$  was

the sum of  $C_{BOM}$  and the converted TS concentration to TOC (4529, 9040 and 20312 mg/L for TS concentrations of 1.2, 2.3 and 5.2 %, respectively) based on the conversion ratio, i.e., the content of organic carbon in TS measured by a C/N analyzer (CN-22F, Shimadzu Co., Japan) (38.4 % for the EAS used in this study).

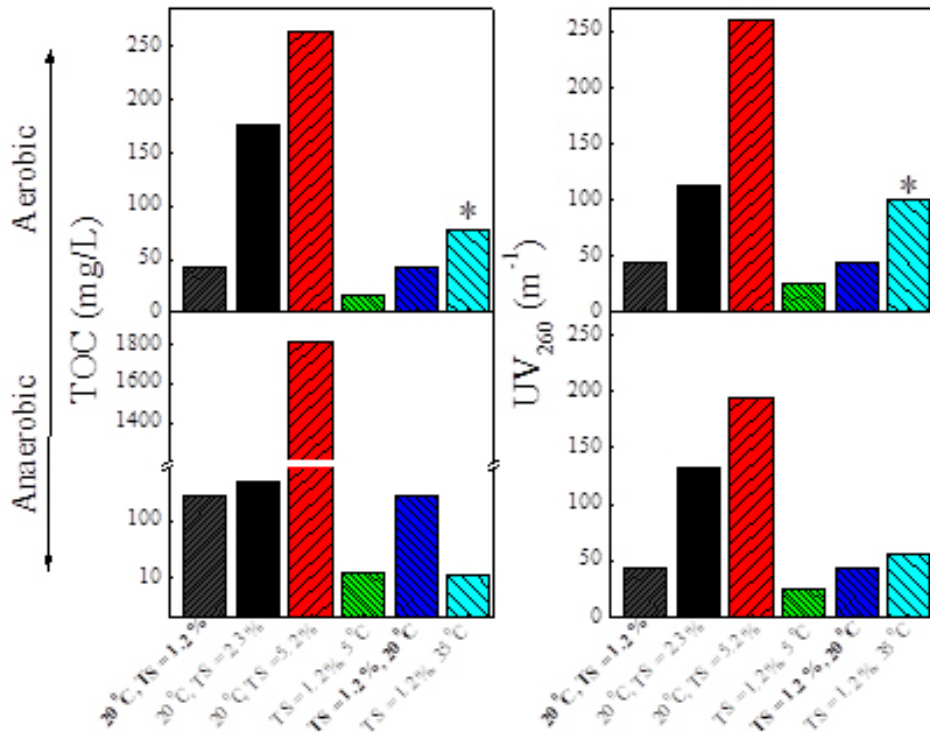
$$Error = \frac{1}{n} \cdot \sum_{i=1}^n \sqrt{\left( \frac{C_{i(obs)} - C_{i(cal)}}{C_{i(obs)}} \right)^2} \quad (4)$$

where,  $C_{i(obs)}$  and  $C_{i(cal)}$  are the observed and calculated TOC concentrations in the liquid phase of each reactor, and n is the number of samples collected for TOC analysis.

## RESULTS AND DISCUSSION

### *Content of DOM assessed by overall quality indexes*

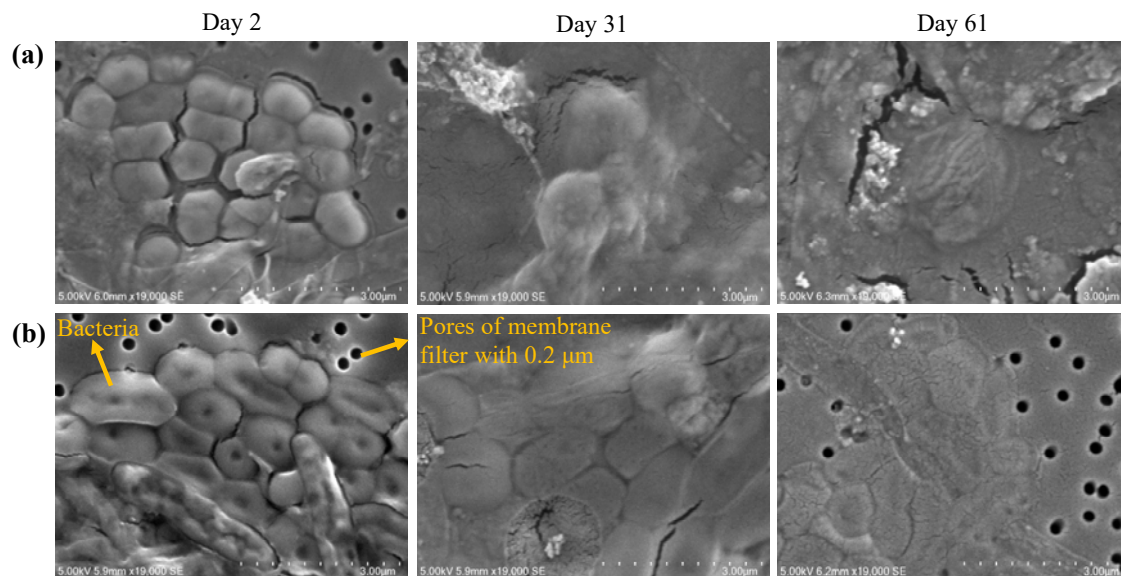
Over the total digestion time for 61 days, a trend of rapid TOC increases followed by either slight increases or gradual decreases was observed (data not shown). The increases reflected the result with the rate of hydrolysis being higher than the rate of degradation. In contrary, the observed decreases reflected the result that the rate of degradation exceeded the rate of hydrolysis or hydrolysis had terminated. After digestion for 61 days, the values of TOC under the anaerobic condition at 20 °C were obviously higher than those under the aerobic condition, as shown in **Figure 2**; however, at 5 °C the differences between the two conditions were becoming smaller. For UV<sub>260</sub>, the value differences between the two conditions were less apparent. A general trend of increases of TOC and UV<sub>260</sub> with increases of either the TS concentration or the temperature was revealed, except for the anaerobic condition with TS of 1.2 % and temperature of 5 °C.



**Figure 2** The concentrations of TOC and UV<sub>260</sub> at the end of digestion for 61 days in the aerobic and anaerobic reactors under different TS concentrations and temperatures. \*The value for day 46.

### *Lysis of the microorganisms*

The observed presence of DOM in the liquid was a combined result of the destruction and lysis of the microorganisms and the breakdown of some of their released organic species. The occurrence of the destruction and lysis of the microorganisms during both the aerobic and anaerobic digestion processes could be clearly seen from the SEM images given in **Figure 3** as examples for the condition with the TS of 1.2 % and temperature of 20 C. Elongated and rod shaped bacteria were evident in the initial period (day 2). However, after 31 days, they looked well swelled, with their shapes becoming irregular. Then, at the end of digestion for 61 days, their shapes became vague and can hardly be distinguished. For all reactors, the changes in the shape of bacteria were found more dramatic for anaerobic digestion, suggesting their faster destruction and lysis than aerobic digestion. Disintegration of sludge flocs in anaerobic fermentation was also found by Pang et al. (2014). In association with the increases of DOM, for both aerobic and anaerobic conditions, increasing the temperature from 5 to 35 C significantly accelerated the destruction and lysis of microorganisms (SEM images not provided here). In a previous study, Climent et al. (2007) reported that higher temperatures could enhance the denaturation of proteins and the permeabilization of cell membrane, resulting in faster leakage of intracellular substances.



**Figure 3** The destruction and lysis of microorganisms observed by SEM ( $\times 19000$ ) during digestion in aerobic (a) and anaerobic (b) reactors operated at 20 °C with the TS concentration of 1.2 %.

### *Rate parameters of hydrolysis and degradation in EAS digestion*

The searched  $k_h$  and  $k_d$  by model fitting the observed TOC data are shown in **Table 1**. Compared to aerobic digestion, anaerobic digestion was found faster for hydrolysis to take place. As shown in this table, for aerobic digestion,  $k_h$  increased from  $0.0005 \text{ day}^{-1}$  to  $0.0010 \text{ day}^{-1}$  as temperature increased from 5 to 35 °C for reactors with the TS concentration of 1.2 %; and from  $0.0007 \text{ day}^{-1}$  to  $0.0205 \text{ day}^{-1}$  as TS increased from 1.2 to 5.2 % for the reactors at 20 C. For anaerobic digestion, the corresponding increase of  $k_h$  with the increase of temperature was from  $0.0007 \text{ day}^{-1}$  to  $0.0493 \text{ day}^{-1}$  and that with the increase of TS concentration was from  $0.0031 \text{ day}^{-1}$  to  $0.0258 \text{ day}^{-1}$ , respectively; with the values being generally higher than those estimated for the aerobic digestion. The trend of increases of  $k_h$  with the increases of temperature supported the result of Lin et al. (2016) that the hydrolysis rate increased as the temperature of digestion increased from 25 to 50 °C.

In regard of the degradation rate,  $k_d$  for the aerobic digestion varied from 0.0407 to 0.0667  $\text{day}^{-1}$  as temperature increased from 5 to 35 C and from 0.0552 to 0.5580  $\text{day}^{-1}$  as TS increased from 1.2 to 5.2 %; with its values being obviously higher than those for the anaerobic digestion (from 0.0201 at 5 C to 0.0464  $\text{day}^{-1}$  at 20 C and 0.0464 to 0.1922  $\text{day}^{-1}$  as TS increased from 1.2 to 5.2 %, respectively). The higher rate of hydrolysis and lower rate of degradation for anaerobic digestion, as compared to aerobic digestion, was the reason for accumulation of DOM in the reactors.

**Table 1** The rate parameters of hydrolysis and degradation of DOM in aerobic and anaerobic digestion of excess activated sludge estimated using a sequential reaction model.

Aerobic		$k_h$	$k_d$	Error
TS = 1.2 %	5 °C	0.0005	0.0407	0.125
	20 °C	0.0007	0.0552	0.153
	35 °C	0.0010	0.0667	0.243
20 °C	TS = 1.2 %	0.0007	0.0552	0.153
	TS = 2.3 %	0.0022	0.1112	0.027
	TS = 5.2 %	0.0205	0.5580	0.136
Anaerobic		$k_h$	$k_d$	Error
TS = 1.2 %	5 °C	0.0007	0.0201	0.014
	20 °C	0.0031	0.0464	0.006
	35 °C	0.0493	0.5513	0.118
20 °C	TS = 1.2 %	0.0031	0.0464	0.006
	TS = 2.3 %	0.0120	0.1097	0.049
	TS = 5.2 %	0.0258	0.1922	0.062

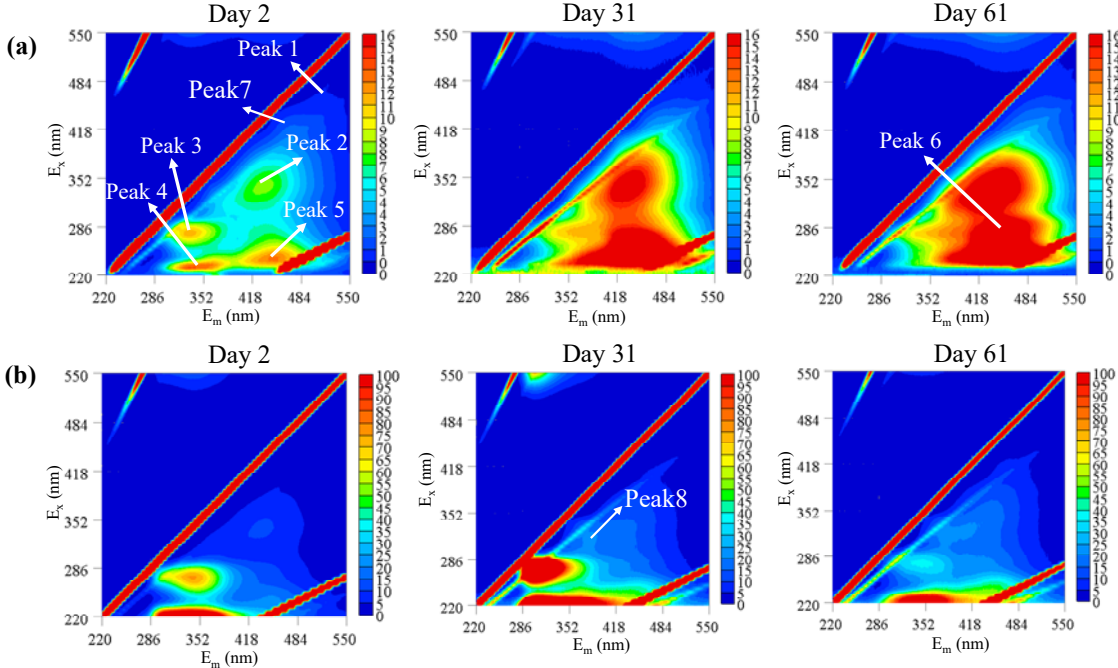
$k_h$ : first-order hydrolysis rate parameter ( $\text{day}^{-1}$ );  $k_d$ : first-order degradation rate parameter ( $\text{day}^{-1}$ ); Error: the difference between calculated and observed TOC concentrations.

### **Composition of DOM assessed by fluorescence EEM**

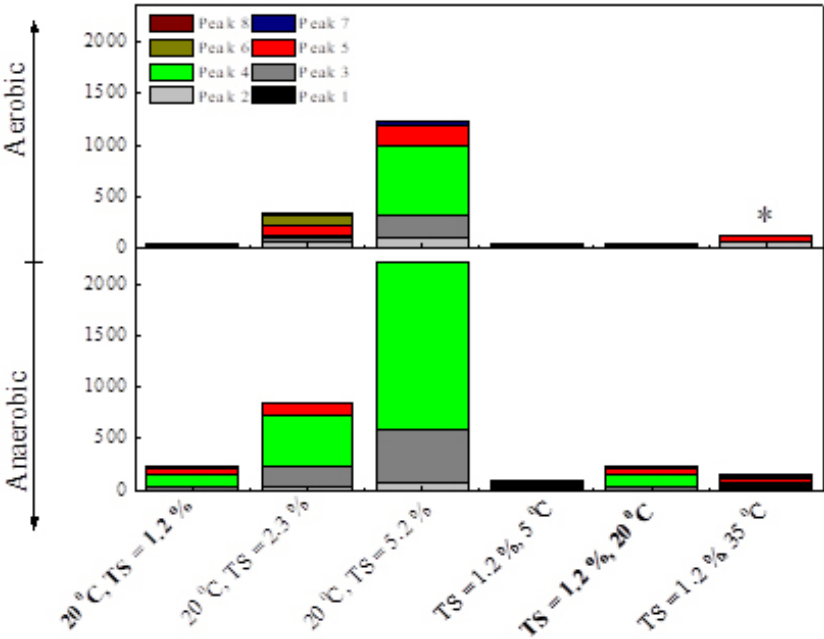
Peak 1 and 2 at the excitation/emission ( $E_x/E_m$ ) wavelengths of 485/514 and 340/428, reported to reflect humic acid-like substances (Chen et al., 2003), were two common peaks emerged during both aerobic and anaerobic digestion, as shown in **Figure 4**. The values of the fluorescence intensity of all peaks remaining at the end of the digestion for 61 days are plotted in **Figure 5**. The total fluorescence intensity was higher for the EAS after anaerobic digestion, suggesting that relatively larger proportions of the hydrolysis products were remaining in the liquid due probably to their slower degradation rate as shown earlier in Table 2. In addition, it is obvious to see that, during the whole operation, Peak 2 and 5 were detected with comparatively higher percentages in the DOM evaluated by the fluorescence intensity in the aerobic reactors; and Peak 3 and 4 in the anaerobic reactors. This indicated that DOM formed and remaining after aerobic digestion contains higher content of humic acid- and fulvic acid-like substances; and that after anaerobic digestion contains higher content of aromatic proteins and tryptophan- and tyrosine- aromatic amino acids. This coincides with the previous result that proteins were the largest organic fraction of EAS (Pang et al., 2014); and more proteins and less humic substances were formed under anaerobic condition (Ramdani et al., 2012; Shao et al., 2013). Composition analysis further indicated that more humic substances were formed in aerobic digestion; while, in anaerobic digestion, proteins and aromatic amino acids were the major constituents. For both digestions, except for a few exceptions, proteins and



humic substances increased as the TS concentration increased; and increasing the temperature led to a decrease in the content of proteins formed in both aerobic and anaerobic digestion, and an increase in the content of humic substances in the aerobic digestion.



**Figure 4** The fluorescence EEM of DOM during digestion in the aerobic (a) and anaerobic (b) reactors operated under 20 °C with the TS concentration of 1.2 %.



**Figure 5** Fluorescence intensity of all peaks of DOM in the aerobic and anaerobic reactors at the end of digestion for 61 days. \*The value for day 46. Peak 1, 2, 6, 7: humic acid-like substances; Peak 3: aromatic proteins; Peak 4: tryptophan-like and tyrosine-like aromatic amino acids; Peak 5: fulvic acid-like substance and Peak 8: peptides and proteins.

## CONCLUSIONS

Using five aerobic and five anaerobic digestion reactors, the characteristics of DOM formed and remaining in the liquid of the digestion treatment of EAS of a representative WWTP were investigated. Compared to aerobic digestion, anaerobic digestion resulted in significantly higher concentrations of DOM. This was due to the accumulation of organic substances brought about by the higher rate of hydrolysis and the lower rate of degradation. A general trend of concentration increases of DOM with the increases of TS and temperature was confirmed. Model simulation indicated that increasing TS could promote both hydrolysis and degradation; however, the effect was more obvious in aerobic than anaerobic digestion. Increasing temperature also promoted hydrolysis and degradation; however, different from the effect of TS, the effect of temperature was found more obvious in anaerobic digestion. In addition to these, the composition analysis by the fluorescence EEM indicated that more humic and fulvic-like substances were formed and remaining during aerobic digestion; while during anaerobic digestion, more proteins and aromatic amino acids were formed. Moreover, the composition analysis based on molecular weight distribution indicated that the UV-absorbing DOM constituents formed in anaerobic digestion had larger molecular weight but was less heterogeneous than those formed in aerobic digestion. In association with the increases of DOM, for both aerobic and anaerobic conditions, increasing the digestion temperature from 5 to 35°C significantly accelerated the destruction and lysis of microorganisms (SEM images not provided here), leading to increases in the hydrolysis rate, with the effect being more obvious in anaerobic digestion.

## REFERENCES

- Chen, H., Yan, S.-H., Ye, Z. L., Meng, H. J. & Zhu, Y. G. 2012 Utilization of urban sewage sludge: Chinese perspectives. *Environmental Science and Pollution Research* 19 (5), 1454-1463.
- Chen, W., Westerhoff, P., Leenheer, J. A. & Booksh, K. 2003 Fluorescence excitation-emission matrix regional integration to quantify spectra for dissolved organic matter. *Environmental Science & Technology* 37 (24), 5701-5710.
- Cheng, H., Hu, Y. & Zhao J. 2009 Meeting China's water shortage crisis: current practices and challenges. *Environmental Science & Technology* 43 (2), 240 - 244.
- Climent, M., Ferrer, I., Baeza, M. D. M., Artola, A., Vazquez, F. & Font, X. 2007 Effects of thermal and mechanical pretreatments of secondary sludge on biogas production under thermophilic conditions, *Chemical Engineering Journal* 133 (1), 335-342.
- Pang, L. N., Ni, J. R. & Tang, X.Y. 2014 Fast characterization of soluble organic intermediates and integrity of microbial cells in the process of alkaline anaerobic fermentation of waste activated sludge. *Biochemical Engineering Journal* 86, 49-56.
- Ramdani, A., Dold, P., Gadbois, A., Deleris, S., Houweling, D. & Comeau, Y. 2012 Biodegradation of the endogenous residue of activated sludge in a membrane bioreactor with continuous or on-off aeration. *Water Research* 46 (9), 2837-2850.
- Shao, L., Wang, T., Li, T., Lu, F. & He, P. 2013 Comparison of sludge digestion under aerobic and anaerobic conditions with a focus on the degradation of proteins at mesophilic temperature. *Bioresour. Technology* 140, 131-137.
- Tomei, M. C., Rita, S. & Mininni, G. 2011. Sequential anaerobic/aerobic digestion of waste activated sludge: analysis of the process performance and kinetic study. *New Biotechnology* 29 (1), 17-22.

# Planning for achieving resource recovery from small sewage treatment plants: a case study in two watersheds in Minas Gerais, Brazil

Ref # S2SMALL-27725

R.L.R. Bortolini<sup>1</sup>, L.A. Chamhum Silva<sup>1</sup>, T. Bressani-Ribeiro<sup>1</sup>, F.J. Bianchetti<sup>1</sup>, C.A.L. Chernicharo<sup>1</sup>, C.R. Mota Filho<sup>1</sup>

<sup>1</sup> Federal University of Minas Gerais, Department of Sanitary and Environmental Engineering, Av. Antônio Carlos 6.627, Campus Pampulha, 31.270-901 - Belo Horizonte - MG – Brazil.

\* Presenting Author: [cesar@desa.ufmg.br](mailto:cesar@desa.ufmg.br)

**Abstract:** Closing the water and nutrient cycles in sewage treatment plants (STPs) can boost local economic activities, ultimately contributing to enhancing sewage collection and treatment in developing countries. However, there is a remarkable challenge to effectively promote resource recovery in small STPs in Brazil, due to large geographical areas, sparsely distributed populations, poor transport links etc. This current study assessed the potential recovery of treatment by-products (sludge and treated effluent) from all small scale (10,000 Pe) STPs, existing and planned, in two different Brazilian watersheds in the state of Minas Gerais. The potential nitrogen and phosphorus supply from sludge and effluent was evaluated for use in agroforestry activities and recovery of degraded areas by iron ore extraction. Additionally, the potential supply of reuse water (treated effluent) for mining dust suppression was assessed. Results showed that the demand for nutrients and water resources would exceed the total potential by-products supply from STPs. Finally, a comparison was made between final disposal costs of sludge on landfills and agricultural areas, the latter being the more economically feasible option.

**Keywords:** Circular economy; nutrient recycling; sewage sludge; treated sewage; water reuse.

## INTRODUCTION

There is a huge sanitation deficit in Brazilian municipalities (only 42.7% of the generated sewage is currently treated (SNIS, 2015)), partly due to the fact that they have difficulty accessing financial resources for implementing infrastructure for sewage collection and treatment (Stepping, 2016). Recovering resources from small sewage treatment plants (STPs) can potentially increase sewage collection and treatment by integrating them to municipal economic activities. The benefits of closing the water and nutrients cycles, as well as minimizing the impact of untreated sewage discharges into water bodies, should all be taken into account by decision makers. The biggest challenge facing initiatives for recovering resources from STPs relies on finding appropriate ways to balance and link resource supply and demand. This can be especially difficult in the case of large geographical areas, sparsely distributed populations, poor transport links etc.

The aim of this study was to evaluate alternatives for sludge and treated wastewater usage as resources recovered from existing and planned small STPs (< 10,000 Pe) in two watersheds of the São Francisco River (SF), which is one of the most important Brazilian rivers, which crosses five federal states. These watersheds - Rio das Velhas (SF5) and Jequitaiá-Pacuí (SF6) - were chosen due to their remarkable importance and socioeconomic and environmental diversity. Mining (iron ore) and agriculture are of major economic importance in watersheds SF5 and SF6, respectively.

The potential for recycling nutrients (nitrogen and phosphorus) recovered from sludge and treated effluent from STPs was evaluated for use in agroforestry activities and recovery of

degraded areas by the iron ore mining sector. Additionally, the potential of water reuse for dust suppression through treated effluent spraying on roads in mined areas was evaluated, as this is one of the main uses of water by the local mining sector (Freitas, 2012).

## **MATERIALS AND METHODS**

### **Study area and evaluated scenarios**

The study area comprises two important watersheds in the *São Francisco* river (SF), called Rio das Velhas (SF5) and Jequitaiá-Pacuí (SF6), both located in the state of Minas Gerais. The municipalities in which there were small sewage treatment plants (< 10,000 Pe) already installed, being built or would be implemented in the short term (designs approved by local authorities) were selected. Sanitation service providers, municipal plans for sanitation and other official sanitation reports (FEAM, 2010; CBH Velhas 2015) were assessed to effectively select the STPs.

According to the status of the STP (operating, in construction or to be implemented), three scenarios were defined: *S*<sub>1</sub>) existing STPs in their current operational average flow; *S*<sub>2</sub>) existing STPs in their maximum design flow; and *S*<sub>3</sub>) existing and predicted STPs in their maximum design flow. *S*<sub>1</sub> and *S*<sub>2</sub> scenarios comprise 19 municipalities, with a total area of 12,148 km<sup>2</sup> and 30 STPs. Scenario *S*<sub>3</sub> is composed of 35 municipalities, with a total area of 25,830 km<sup>2</sup> and 47 STPs.

### **Estimated supply of nutrients and water for reuse from STPs**

Nutrients supply was estimated individually for each sewage treatment plant, considering both the nutrient availability in the sludge (solid phase) and the treated effluent (liquid phase). Therefore, the following data were assessed:

- Main design characteristics of the STPs: treatment flow-sheet and installed capacity;
- Monitoring data from service providers: average operational flow, sludge production, average effluent concentration of N and P;
- Parameters from the literature: per capita sludge production and related nutrients (N and P) and solids content according to the treatment technology applied (e.g. UASB reactor with drying beds) (Andreoli *et al.* 2014; Rosa *et al.* 2015; Nascimento, 2016).

In summary, the estimation of nutrient supply in the sludge consists in multiplying the annual STP production of sludge by its typical concentrations of N and P. The estimation of nutrient supply in the treated effluent consists in multiplying the STP flow rate by the typical concentrations of N and P in treated effluent. The potential for wastewater reuse was considered to be equivalent to the sewage flow rate for each of the scenarios evaluated.

### **Estimated nutrient demand for agroforestry and mining activities**

The nutrient demand for agroforestry activities (pastures, forestry, temporary and permanent crops) was estimated by multiplying the total intended area for such economic activity in the study region by the specific need for fertilization of each established crop. Nutrient demand for the recovery of degraded areas by iron ore mining was calculated by multiplying the total estimated degraded area by the specific need for fertilization of the crop to be established.

The area of each municipality associated to agroforestry was assessed by using surveys published by the Brazilian Institute of Geography and Statistics (IBGE 2015a; 2015b). The main mines in the studied region were identified (Minérios & Minerais, 2016) and the areas degraded by extraction of iron ore were estimated using GIS methods (spatial delimitation of

mines by visual interpretation and on-screen scanning of satellite images). A total of 13 mining areas were identified in the study area.

Finally, the need for fertilization required by each crop was based on official agronomic recommendations for the State of Minas Gerais (Ribeiro *et al.* 1999).

### **Estimated demand for treated wastewater in mines**

The demand for treated sewage for dust suppression in mining activities was estimated based on an average water consumption of  $4 \text{ L.d}^{-1}.\text{m}^2_{\text{road}}$  (Mills, 2010). Dust suppression is one of the main uses of water resources by the mining sector and does not require water of high quality (Freitas 2012). Internal traffic roads were assessed using satellite images to determine the typical width of the mining roads in the study area.

### **Comparison between supply and demand for nutrients and treated wastewater by agroforestry and mining activities**

The comparison of nutrients supply and demand for agroforestry activities in the studied area was done in terms of total values and also broken down by municipality. In this case, the corresponding radius around the STP that could be fertilized with the by-products (sludge and treated effluent) was estimated, taking into account the unitary nutrients demand ( $\text{kg}_{\text{nutrients}}.\text{km}^{-2}$ ).

For mining activities, the supply of nutrients and treated wastewater from STPs located at a maximum distance of 25 km from each mine were considered. It is important to emphasize that only the nutrient content of sludge was considered, since the treated effluent would be used as water source for dust suppression.

### **Economic assessment**

An economic assessment was performed considering Scenario 1 by comparing the costs of final disposal of sludge on landfills and agricultural use of sludge. The available landfills in the study area were selected based on the Integrated Environmental Information System of the State of Minas Gerais (SEMAD, 2017). The average cost of landfilling was determined based on actual costs obtained from three different local companies (US\$  $19.09.\text{t}^{-1}$ , US\$  $28.10.\text{t}^{-1}$  e US\$  $30.09.\text{t}^{-1}$ ). For each STP, the sludge transport distance to the nearest landfill site was determined, as well as the estimated number of trips necessary to dispose of the material, considering a truck capacity of 12 t. Transportation costs were proportional to the distances travelled, as follows: US\$  $0.19.\text{km}^{-1}.\text{t}^{-1}$  up to 50 km, and US\$  $0.06.\text{km}^{-1}.\text{t}^{-1}$  between 50 and 200 km (SIFRECA-ESALQ-LOG, 2017).

For agricultural use of sludge, the cost of sanitization (with addition of CaO at 30% of the dry sludge mass (Andreolli *et al.* 2014)) was considered. The cost of lime was US\$  $120.85.\text{t}^{-1}$  (reference month: July 2017). The costs for transportation were estimated using the same methodology aforementioned for landfilling. Transportation distances were defined assuming the radius of the potential area of fertilization from each STP, as previously described. As the obtained radius represent linear segments (actual road networks were not considered), an increase factor was applied, based on the difference between actual and linear distances of STPs to final disposal sites.

## **RESULTS AND DISCUSSION**

### **Assessment of by-products utilization in agroforestry activities**

The demand and supply of nutrients for agroforestry activities (permanent and temporary crops, silviculture and pasture) are summarized in Table 1. The presented values comprise the

total nutrient demand of the municipalities in each scenario, as well as the total possible nutrient supply for STPs in each scenario.

**Table 1.** Demand and supply of nutrients for agroforestry activities

Scenario	Nitrogen (t.year <sup>-1</sup> )		Phosphor (t.year <sup>-1</sup> )	
	Demand	Supply	Demand	Supply
1	19,979	229	6,278	29
2	19,979	317	6,278	45
3	49,534	584	14,580	76

The percentage of all nitrogen and phosphorus demand that could be supplied from the STPs by-products is relatively low: less than 2% for nitrogen and 1% for phosphorus in all of the considered scenarios. Nevertheless, it should be noted that this source of nutrients could represent an important supply for the studied region. If the total treated sludge and effluent were destined for agricultural use in permanent crops, for example, it would be possible to meet their entire phosphorus requirements in all of the scenarios. In this case, half of the nitrogen demand would also be accomplished.

In regards to STP management and environmental issues, the high existent local demand for by-products stands out, as it brings important benefits, such as the elimination of sludge disposal on landfills, for example.

Considering the nutrient demand of the associated agroforestry activities, highest demand was for pastures, followed by forestry, temporary and permanent crops. The lack of nutrients in pastures can be justified by the existence of large areas destined to livestock, which implies low rate of pasture occupation in the studied region.

Results show that the largest portion of the nutrients available in treatment by-products (sludge and treated effluent) was present in the treated effluent rather than in the sludge. The nitrogen and phosphorus content available in the sludge for the different scenarios were between 5-10% and 12-18%, respectively.

The radiuses that could be fertilized using recovered nitrogen from STPs were 1.3, 1.6 and 1.7 km in scenarios S1, S2 and S3, respectively. As for phosphorus supply, these values were 0.9, 1.2 and 1.2 km, respectively. Therefore, to effectively achieve agricultural recycling of the sludge and treated effluent it is not expected that large distances will have to be reached. The demand by agricultural activities in the immediate vicinities of STPs would be enough to absorb the entire supply.

#### **Assessment of STP by-products utilization in iron ore mining activities**

The demand and supply of nutrients and treated sewage for iron ore mining activities (recovery of degraded areas and dust suppression) are summarized in Table 1. The presented values comprise the total nutrient demand of all degraded areas as well as the total demand for water resources for dust suppression. The estimated nutrient supply by sludge and treated sewage took into account STPs located at a maximum distance of 25 km from the mines, for each proposed scenario. This led to a total of 9 sewage treatment plants.



**Table 2.** Demand and supply of nutrients for iron ore mining activities

Scenario	Nitrogen		Phosphor		Treated sewage (l.s <sup>-1</sup> )	
	Demand (t)	Supply (t.year <sup>-1</sup> )	Demand (t)	Supply (t.year <sup>-1</sup> )	Demand	Supply
1	318	1.9	222	0.6	204	28
2	318	2.7	222	0.8	204	31
3	318	4.8	222	1.4	204	61

Following the previously observed trend for agroforestry activities, the nutrients requirement for recovery of degraded areas far exceeds the local supply. Considering scenario 3, which has the largest amount of sludge produced and available nutrients, the use of this by-product in mines would supply about 0.6% and 1.5% of the annual demand for phosphorus and nitrogen, respectively.

Nutrients demand for recovery of degraded areas is only associated with the establishment of the forage crop. In contrast, agricultural crops need regular maintenance fertilization (side-dressing fertilization). Therefore, the nutritional requirement for recovery of degraded areas refers to a total value for revegetation of the area and not to a need to be supplied annually. This implies that the recovery of these areas through the use of sewage sludge could be done in a gradual manner, considering several consecutive applications.

The supply of treated effluent exceeded the demand for dust suppression. Nevertheless, it can represent an important relief in the pressure for water resources exerted by this industrial sector. In the third scenario, for example, almost 30% of water demand could be met with the use of treated effluent.

### Economic assessment

The costs associated with sludge disposal on landfills and agricultural use are summarized in Table 3. The relation between the total cost of disposal in landfill and agricultural use varied between 1.56 and 2.47.

**Table 3.** Transport and disposal costs of sludge on landfill and agricultural use.

Costs	Landfill		Agricultural Use	
	Disposal (US\$.year <sup>-1</sup> )	Transport (US\$.year <sup>-1</sup> )	Lime (US\$.year <sup>-1</sup> )	Transport (US\$.year <sup>-1</sup> )
Total	37,010	1,345	17,947	98
Min.	190	5	94	< 1
Max.	4,505	207	2,219	11
Mean	1,234	46	598	3

The costs for landfilling and acquisition of lime are the most representative of the total costs of each final disposal method. It was found that the cost of landfilling is, on average, 2.1 times that of lime acquisition.

It is worth mentioning that the area that could potentially be fertilized with sludge was estimated based only on the N and P content in the sludge. Therefore, this current analysis did not take into account additional costs related to transport to longer distances, due to restrictions on land use and occupation in the vicinity of the STPs and other legal restrictions.

Although transport costs may have been underestimated in the case of agricultural use, they were considerably lower than the total cost in both cases. In regards to landfill disposal, the cost of transportation varied between 0.3% and 7.7% of the total costs, while in agricultural costs ranged from 0.2% to 1.0%.

Sludge sanitization with lime causes an increase in the amount of material to be transported and disposed of, besides promoting the reduction of nutrient availability in the sludge, such as nitrogen and potassium (Lu *et al.* 2012). Additionally, the aspects related to the infrastructure and equipment for the application of lime were not evaluated.

## CONCLUSIONS

- The demand for nutrients and treated wastewater resources by the assessed economic activities far exceeds the existing supply from local small STPs in the studied area. However, the use of by-products in the vicinity of STPs would provide economic and environmental gains associated with the reduction of sludge landfilling, for instance.
- The costs associated with sludge disposal on landfills reached values up to 2.47 times higher than the costs of agricultural disposal, demonstrating the economic potential of agricultural use for the assessed scenarios.

## ACKNOWLEDGMENTS

The authors would like to acknowledge the support obtained from the Prosperity Fund (United Kingdom) and the following Brazilian institutions: *Conselho Nacional de Desenvolvimento Científico e Tecnológico – CNPq; Coordenação de Aperfeiçoamento de Pessoal de Nível Superior – CAPES; Fundação de Amparo à Pesquisa do Estado de Minas Gerais – FAPEMIG; Instituto Nacional de Ciência e Tecnologia em Estações Sustentáveis de Tratamento de Esgoto – INCT ETEs Sustentáveis (INCT Sustainable Sewage Treatment Plants).*

## REFERENCES

Andreoli, C.V.; Von Sperling, M.; Fernandes, F. 2014 *Lodo de esgotos: tratamento e disposição final (Sewage sludge: treatment and final disposal)*. Departamento de Engenharia Sanitária e Ambiental – UFMG, Companhia de Saneamento do Paraná, Belo Horizonte, Brazil.

CBH Velhas 2015 *Plano Diretor de Recursos Hídricos da Bacia Hidrográfica do Rio das Velhas: Resumo Executivo (Master Plan of Water Resources of Rio das Velhas Watershed)*. Report from Comitê da Bacia Hidrográfica do Rio das Velhas, Belo Horizonte, Brazil.

Ribeiro A.C.; Guimarães P.T.G.; Alvarez, V.H. 1999 *Recomendações para o uso de corretivos e fertilizantes em Minas Gerais (Recommendations for soil amendment and fertilization in Minas Gerais)*. Report from Comissão de Fertilidade do Solo de Estado de Minas Gerais, Viçosa, Brazil.

FEAM 2010 *Plano para incremento do percentual de tratamento de esgotos sanitários na Bacia do Rio das Velhas (Plan for increasing the percentage of sewage treatment in Rio das Velhas Watershed)*. Report from Fundação Estadual do Meio Ambiente, Belo Horizonte, Brazil.

Freitas, S. P. de 2012 *O impacto do uso e consumo de água na mineração sobre o bloco de energia assegurada em empreendimentos hidrogeradores: estudo de caso da PCH Bicas (The*

*impact of water use and consumption in mining on the block of assured energy in hydrogeneration enterprises: case study of the PCH Bicas*). MsC thesis, Postgraduate programme on Sanitation, Environment and Water Resources, UFMG, Belo Horizonte, Brazil.

IBGE 2015a *Pesquisa Pecuária Municipal (Municipal Livestock Research)*. Report from Instituto Brasileiro de Geografia e Estatística. <https://sidra.ibge.gov.br/pesquisa/ppm/quadros/Brazil/2015> (accessed 05 October 2016)

IBGE 2015b *Produção da Extração Vegetal e da Silvicultura (Production of Vegetable Extraction and Forestry)*. Report from Instituto Brasileiro de Geografia e Estatística. <https://sidra.ibge.gov.br/pesquisa/pevs/quadros/Brazil/2015> (accessed 05 October 2016).

LU, Q., HE, Z.L., STOFFELLA, P.J. 2012 Land application of biosolids in the USA: A review. *Applied and Environmental Soil Science*. 1-11.

Mills, M. 2010 Wasting water on dust control. *Australian Mining*. September 15, 2010. <https://www.australianmining.com.au/features/wasting-water-on-dust-control> (accessed 14 March 2017)

Minérios & Minerales 2016 200 Maiores Minas Brasileiras (200 Largest Brazilian Mines). *Minérios & Minerales*, v. XL, n. 384, p. 68, Nov/Dez 2016.

Nascimento, A.L. 2016. *Caracterização microbiológica, química e presença de poluentes orgânicos em amostras de lodo de esgoto de São Paulo (Microbiology and chemistry characterization and presence of organic pollutants in sludge samples from São Paulo)*. PhD thesis, Escola Superior de Agricultura "Luiz de Queiroz", Universidade de São Paulo, Piracicaba, Brazil.

Rosa, A.P.; Chernicharo, C.A.L.; Melo, G.C.B. 2015 *Contribuição para o aproveitamento energético do lodo de ETEs em processos térmicos (Contribution to the energy recovery of sludge from STPs in thermal processes)*. *Revista DAE*. **198**(63), 55-62.

SEMAD 2017 *Sistema Integrado de Informação Ambiental (Integrated system of environmental information)*. <http://www.siam.mg.gov.br/siam/processo/index.jsp> (accessed 06 July 2017).

SIFRECA-ESALQ-LOG 2017 *Frete rodoviário de fertilizantes (Road freight of fertilizers)*. Freight Information System. <http://sifreca.esalq.usp.br/> (accessed 05 July 2017).

SNIS 2015 *Diagnóstico do serviços de água e esgotos*. Report from Sistema Nacional de Informações sobre Saneamento. <http://www.snis.gov.br/diagnostico-agua-e-esgotos/diagnostico-ae-2015> (accessed 15 March 2017)

Stepping, K.M.K 2016 Urban sewage in Brazil: drivers of and obstacles to wastewater treatment and reuse, Governing the Water-Energy-Food Nexus Series. Discussion Paper 26/2016, German Development Institute, DIE, Bonn, Germany.

## **Innovation at scale: the scaling-up process of small-scale sanitation in India**

**Ulrich, L.<sup>1</sup>, Chandragiri, R.<sup>1</sup>, Reymond, Ph.<sup>1</sup>, Shrestha, R.<sup>2</sup>**

<sup>1</sup> Swiss Federal Institute of Aquatic Science and Technology (Eawag), Department Sanitation, Water and Solid Waste for Development, Überlandstrasse 133, 8600 Dübendorf, Switzerland

<sup>2</sup> Bill & Melinda Gates Foundation, 500 Fifth Avenue North, Seattle, WA 98109, USA

**Keywords:** Decentralised sanitation; scaling-up; India

### **Introduction**

In 2006 the Government of India issued a notification requiring the installation of on-site sewage treatment plants (STPs) for construction projects >20'000 m<sup>2</sup> (MoEF, 2006). In parallel, states like Karnataka have made the policy more stringent (STP required in buildings with >50 apartments) and introduced Zero Liquid Discharge (ZLD). ZLD insists on the reuse of all the treated water that is being generated on site. These policies have resulted in the installation of several thousand small-scale sanitation systems in urban India, a majority of them in metropolitan areas. Most of the STPs are variations of the activated sludge process.

In the past decade small-scale sanitation systems have proven to be a viable alternative to conventional large-scale centralised systems in certain contexts (Wilderer et al., 2000; Parkinson et al., 2003; Larsen et al., 2013). International experience shows that successful at-scale implementation entails more than replicating a large number of discrete projects (Eales et al., 2013). Scaling-up requires effective management, innovative financing plans and, often, inclusion of the private sector (Abey Suriya et al., 2007; Evans, 2013). It also requires different institutional arrangements, depending on the location, to make the most efficient use of available resources (Reymond et al., 2016).

At a time where the number of small STPs is growing rapidly in India, it is crucial to check if these requirements are met and if the new policies have translated into functioning systems on the ground.

### **Material and Methods**

This study combines the analysis of existing systems in the field with a review of the enabling environment for small sanitation systems. Lüthi et al. (2011) structure the enabling environment in six categories: (i) government support; (ii) legal and regulatory framework; (iii) institutional arrangements; (iv) skills and capacity; (v) financial arrangements; and (vi) socio-cultural acceptance. A policy and social network analysis was carried out to characterise institutional arrangements and formal/informal relationships between stakeholders, via semi-structured interviews and fully structured questionnaires. An exhaustive evaluation questionnaire was used to collect information on the implementation, operation and management of about 400 small-scale STPs. In parallel, an in-depth sampling campaign was carried out to assess the technical performance of 40 units, representing a sample of the more widely implemented technologies. This methodology allowed an integrated assessment from policy to the realities on the ground.

## Results and Discussion

This research shows an uncontrolled development of small-scale sanitation in India. There is no unified and comprehensive listing of small STPs installed in different states. In the city of Bangalore alone, more than 640 STPs have officially been built until today (KSPCB, 2016). The authors' database, however, suggests a figure that is six times higher. Hundreds of private suppliers are implementing a mosaic of solutions, with little control by authorities. While the policies succeeded in fostering the construction of a large number of on-site STPs, the state governments do not have the capacity to monitor and enforce the correct design and performance of all these installations. This allows building owners to minimise operational costs (e.g. through intermittent running of systems or by hiring unskilled operators) and to neglect STP maintenance. Consequently, an estimated two-thirds of the systems in Bangalore are out of service or underperforming. A similar situation prevails all over the country.

It appears that the high discharge standards are not pragmatic when compared to the performance of many available STP technologies. Only energy-intensive systems can meet the standards. However, many real estate developers rather select technologies based on low capital cost, and owners develop strategies to circumvent performance monitoring attempts.

The ZLD policy is innovative and targets the increasing water scarcity in Indian cities. However, it faces practical challenges, due to insufficient potential for on-site reuse of the treated water, and the absence of collection and transport initiatives to link producers with consumers of reclaimed water. Planning beyond installation level is needed to ensure reuse.

The analysis of the enabling environment shows that legal and regulatory frameworks are in place to some extent, but they have not been followed by appropriate financial and human resources for the responsible agencies to be able to enforce the law and monitor the systems. This study highlights the bottlenecks of the current scaling-up of small STPs in India, but also provides evidence of success and failure factors, on the technical and management side. Besides, it pinpoints the strengths and weaknesses of the institutional arrangements. These findings should allow to improve the scaling-up process of small-scale sanitation in the future.

## References

- Abey Suriya, K., Mitchell, C. & White, S. 2007. Can Corporate Social Responsibility resolve the sanitation question in developing Asian countries? *Ecological Economics*, vol. 62, no. 1, pp. 174-183.
- Eales, K., Siregar, R., Febriani, E. & Blackett, I. 2013. Review of Community Managed Decentralized Wastewater Treatment Systems in Indonesia. Report of WSP. Indonesia.
- Evans, B. 2013. Cities of the global South – is decentralized sanitation a solution? In: *Source Separation and Decentralization for Wastewater Management* (Larsen, T.A., Udert, K.M., Lienert, J., eds.). IWA Publishing, London, pp. 117-132.
- KSPCB 2016. Karnataka State Pollution Control Board, personal communication, 15. Nov. 2016.
- Larsen, T.A., Udert, K.M. & Lienert, J. (eds) 2013. *Source Separation and Decentralization for Wastewater Management*. IWA Publishing, London.
- Lüthi, C., Morel, A., Tilley, E. & Ulrich, L. 2011. *Community-Led Urban Environmental Sanitation Planning (CLUES)*. Eawag, Dübendorf, Switzerland.
- MoEF 2006. EIA Notification, dated 14 September 2006. Available at: <http://envfor.nic.in/legis/eia/so1533.pdf>
- Parkinson, J. & Tayler, K. 2003. Decentralized wastewater management in peri-urban areas in low-income countries. *Environment and Urbanization*. 15, 75–90.
- Reymond Ph., Renggli S. & Lüthi C. 2016. *Towards Sustainable Sanitation in an Urbanising World*. In Ergen, M. (ed): *Sustainable Urbanization*, pp. 115-134. ISBN 978-953-51-2653-9
- Wilderer, P.A. & Schreff, D. 2000. Decentralised and centralised wastewater management: a challenge for developers. *Water Sci. Technol.* 41, 1-8.

# An environmental approach to compare on-site sanitation systems

Ref # S2SMALL- 241221

B. Vidal,<sup>1\*</sup> E. Kärrman<sup>2</sup>, A. Hedström<sup>1</sup>, I. Herrmann<sup>1</sup>

<sup>1</sup> Luleå University of Technology, Department of Civil, Environmental and Natural Resources Engineering, 97187 Luleå, Sweden

<sup>2</sup> RISE Research Institute of Sweden, Urban Water management, SE-114 86 Stockholm, Sweden

\* Corresponding Author: [brenda.vidal@ltu.se](mailto:brenda.vidal@ltu.se)

**Keywords:** decentralized sanitation, multi-criteria analysis, sustainability, small-scale wastewater systems

## INTRODUCTION / MAIN METHIODES

About 700,000 on-site wastewater treatment systems (OWTS) have been installed in Sweden, serving both year-round and summer houses (Olshammar et al., 2015). Their treatment efficiency is often questioned, because they may contribute considerably to eutrophication of natural surface waters. It is estimated that the phosphorus (P) discharge of all the OWTSs accounts for 15% of the total anthropogenic P emissions to Swedish surface waters; the same amount as all municipal wastewater treatment plants combined (Ejhed et al., 2011). About half of the existing facilities are not built according to the guidelines (Ek et al., 2011) and discharge higher levels of nutrients into the receiving waters than suggested by the current recommendations. When new OWTS need to be built, or old ones upgraded because of facility ageing, or population dynamics or the need for legal compliance, it is often difficult for operators (usually house owners) and the supervising authority (the municipalities) to discern among the different available options and their sustainability.

The aim of this study is to benchmark different on-site wastewater treatment solutions using a multi-criteria analysis (MCA) and sustainability indicators. Both, the OWTS options commonly used in Sweden and other less common options, such as source-separation systems, are included. The present paper focuses on the environmental indicators.

Eleven alternatives (general systems types) were analyzed by the MCA, including five soil-based treatment combinations, such as septic tanks, drain fields, sand filters, alkaline filters for P removal, and P removal by precipitation. Furthermore, three source-separation alternatives were chosen, consisting of greywater (sand filter treatment) and blackwater separation (anaerobic digestion treatment and/or urine diversion with different treatments). Finally, three packaged plants closed the list of alternatives, selected mainly on the basis of differences in their technological characteristics and commercial availability in Sweden.

The criteria and indicators used in the MCA were defined on the basis of discussions with experts in the field and the earlier research, and estimated both qualitatively and quantitatively from the available literature data (see Table 1). The scores based on constructed scales (that represent relative preferences for the consequences) were calculated for each indicator to make them mutually comparable. The result of such analysis is a performance matrix that rates the performance of the alternatives against each indicator. Furthermore, a reference



group, consisting of researchers, authorities and consultants, will discuss and assign additive weights to each criterion to reflect the relative importance and stakeholders' interests.

**Table 1.** Criteria and indicators selected for the multi-criteria analysis. The focus of this paper will only cover the environmental indicators. Qual. = quality indicator, quant. = quantity indicator.

Criteria type	Indicator	Units	Qual. (L)/ Quant. (T)	Aim
Environmental	Emissions to surface waters	%	T	High reduction
	Potential for nutrients recycling	%	T	High potential
	Emissions to air	Kg CO <sub>2</sub> - eq/year	T	Low emissions
	Energy use	MJ/year	T	Low energy use
	Energy recovery	H-M-L (3,2,1)	L	High energy recovery
Economic	Investment costs (capital cost)	SEK/life expectancy	T	Low cost
	Operation & maintenance costs	SEK/year	T	Low cost
Socio-cultural	Social acceptance	H-M-L (3,2,1)	L	High social acceptance
	Complexity of technique	H-M-L (1,2,3)	L	Low technical complexity
Technological	Robustness	H-M-L (3,2,1)	L	High robustness
	Resilience (Upgradability/flexibility)	H-M-L (3,2,1)	L	High resilience

## MAIN RESULTS AND CONCLUSIONS

Preliminary results show that the three source-separation options contribute least emissions to surface waters with respect to P and especially N. Soil-based systems that include the septic tank, P precipitation, sand filter and drain field also show high reduction rates for BOD and P, but lower for N as compared to source separation systems.

The calculation of the potential for nutrients recycling was challenging, because various assumptions substantially influenced the results. Two indicators for potential recycling of nutrients were considered; the total recoverable fraction, assuming that nutrients are recovered from most of the materials (sand filters, P filters, and sludge), and the more "realistic" fraction that is potentially recoverable according to the current practice.

The expected results consist in a ranking of the selected alternatives, on the basis of their performance against the environmental criteria, and stakeholders' preferences that can be used in support of the decision-making processes. Multi-criteria analysis was found to be a useful tool to compare a range of criteria of different nature, support complex decisions and provide informed preferences.

## REFERENCES

Ejhed, H., Olshammar, M., Brånvall, G., Gerner, A., Bergström, J., Johnsson, H., Blombäck, K., Nisell, J., Gustavsson, H., Persson, C. and Alavi, G. (2011) *Beräkning av kväve - och fosforbelastning på vatten och hav för uppföljning av miljökvalitetsmålet ” Ingen övergödning” (Estimating nitrogen and phosphorus load to water and sea to monitor the environmental quality objective "Zero Eutrophication). Report 56 for the Swedish Environmental Protection Agency. Norrköping, Sweden.*

Ek, M., Junestedt, C., Larsson, C., Olshammar, M. and Ericsson, M. (2011) *På uppdrag av Naturvårdsverket Tekniskät -enskilda avlopp 2009 (A technical survey on on-site wastewater treatment 2009). Report 44 for the Swedish Environmental Protection Agency. Norrköping, Sweden.*

Olshammar, M., Ek, M., Rosenquist, L., Ejhed, H., Sidvall, A. and Svanström, S. (2015) *På uppdrag av Havs-och vattenmyndigheten Uppdatering av kunskapsläget och statistik för små avloppsanläggningar (The state of knowledge and statistics for small sewage plants). Report 166 for the Swedish Agency for Marine and Water Management. Norrköping, Sweden.*

## Energy savings at the small-scale wastewater treatment plants

Holba, M.<sup>1</sup>, Matysíková, J.<sup>1</sup>.

<sup>1</sup> ASIO, spol. s r.o., Kšírova 552/45, 619 00 Brno, Czech Republic

**Keywords:** energy savings, small-scale wastewater treatment plant, operational optimization

### Introduction

The cut off of operational costs at the wastewater treatment plants via energy optimization is recently focused not only in the Czech Republic but also worldwide. The benchmarking tool is applied to establish austerity measures. Bigger wastewater treatment plants (generally, more than 10 000 PE) already implement those cost saving scenarios. Recent small-scale wastewater treatment plants less than 10 000 PE were built together with sewerage via grant funding with investment costs as key indicator in the Czech Republic. Those plants have usually very high operational costs and created the cost burden for the municipalities that operate it. There is big demand for technological retrofit leading towards austerity measures. Also the increasing price of energy leads operators to optimize existing energy plant streams and discover alternative energy sources. Cost savings scenarios are recently focused not only for wastewater, but throughout all industries. Therefore, we will focus on the smaller wastewater treatment plants (less than 10 000 PE) to create and design novel modular wastewater treatment plant and also optimization scenarios for the retrofit of existing wastewater treatment plants.

### Material and Methods

Our solution needs thorough identification and specification of local conditions and requirements to analyze wastewater treatment plant design, calculations, dimensions and construction in the view of small renewable energy sources. The detailed approach of technical solution supported by municipality needs and economic analyses will be introduced. The holistic innovative solution interlinks technologies described by mathematical-physical models. Interconnection between models will lead to the architecture of data control system, predictions, system optimizations and algorithm testing and development. Algorithms will be incorporated into software application that will perform operational management and optimization for whole small-scale wastewater treatment plant. Last step will be successful validation, technical documentation and overall evaluation. Overall approach will be verified and evaluated at municipal wastewater treatment plant for 1200 PE.

### Results and Discussion

Project started in January 2017 and therefore thorough analysis of the testing place with suggested manual will be introduced in the full-text. The plan of next validation steps will be introduced too.

### **Acknowledgements**

Project TH02020518 – “A modular wastewater treatment plant for municipalities using its energy potential to minimize operating costs” is supported by the Technology Agency of the Czech Republic.

**Parallel session 4 - Phosphorus Treatment and recovery 2**

**14:00-15:20**

Session chair: Cristian Barca

**433 - Phosphorus removal in small catchments – A case study from Austria**

LANGERGRABER Guenter - *BOKU University*

**538 - Phosphorus removal from secondary effluent using chemically modified zeolite**

MALAMIS Simos - *National Technical University of Athens*

**309 - Alumina-based adsorbant for Phosphorus removal and recovery on small wastewater treatment plants**

CORNET François - *SAS MAANEO*

**874 - Tertiary nitrification and phosphorus removal from domestic wastewater with constructed wetlands**

DOTRO Gabriela - *Cranfield University*

# Phosphorus removal in small sensitive catchments – A case study from Austria

Ref # S2SMALL-58629

Niklas Langitz, Sophia Gerstorfer, Guenter Langergraber \*

Institute for Sanitary Engineering and Water Pollution Control, University of Natural Resources and Life Sciences, Vienna (BOKU), Muthgasse 18, A-1190 Vienna, Austria.

\* Corresponding author: [guenter.langergraber@boku.ac.at](mailto:guenter.langergraber@boku.ac.at)

## Abstract

In this paper, we studied the phosphorus balance of a small nutrient sensitive catchments in Austria, we estimated the costs of different options to remove phosphorus from small wastewater treatment plants (WWTPs), and estimated the number of small WWTPs with less than 500 person equivalents (PE) for which phosphorus removal could be relevant in Austria. In the Wambach catchment, a case study in Upper Austria south of Linz, the phosphorus emissions from the small WWTPs are relatively low when compared to those from agricultural run-off. However, as emissions from WWTPs occur continuously, they are the main source of high phosphorus concentration in the receiving water, especially during low flow periods. Phosphorus removal from small WWTPs is thus a relevant goal in nutrient sensitive catchments. When considering a period of 30 years, the yearly costs of post-treatment filters for phosphorus removal (using Phosclean® as filter material and dimensioned for a lifetime of 10 years) are 34.60 EUR per person and for phosphorus precipitation and 37.40 EUR per person, respectively. Post-treatment filters have higher investment costs compared to phosphorus precipitation; however, the operational costs of the filters are significantly lower (and limited to the exchange of the filter material at the end of its lifetime). Additionally, post-treatment filters do require almost no maintenance work whereas precipitation requires continuous operational and maintenance efforts from the operator. Thus, post-treatment filters are a favourable technology for small WWTPs that usually lack of operation staff. Additionally, Phosclean® give the potential for recovering the phosphorus from the filter material once the lifetime of the filter is over. Yearly, 21.5 tons phosphorus could be recovered in Austria from the around 3'900 small WWTPs in nutrient sensitive catchments alone for which phosphorus should be removed from an environmental perspective. If phosphorus recovery is aimed for on a larger scale, post-treatment filters would be a suitable and easy to implement technology that is also applicable for larger WWTPs.

## Keywords

Nutrient sensitive receiving waters, Phosclean®, phosphorus, post-treatment filters.

## INTRODUCTION

For small wastewater treatment plants (WWTPs) in Austria, no standard for nitrogen and phosphorus removal exists (1.AEVKA, 1996). Nitrogen removal is generally required at WWTPs larger than 5,000 person equivalents (PE), phosphorus removal at plants larger 1,000 PE. However, for sensitive receiving water bodies authorities can request removal of nitrogen and phosphorus. Many small WWTPs in Austria are located in rural areas with small sensitive receiving waters. For most of the small sensitive catchments in Austria, phosphorus is the limiting nutrient.

In this paper, we focus on small WWTPs with less than 500 PE and phosphorus removal. According to Langergraber and Weissenbacher (2017), the number of small WWTPs in Austria is about 28'700. The most popular technologies applied are conventional activated sludge systems, treatment wetlands



and sequencing batch reactors (SBRs) with about 7'000, 5'500 and 4'500 plants in operation, respectively.

For larger WWTPs, phosphorus precipitation is state-of-the-art and commonly applied. It has been shown that phosphorus removal is also technologically feasible for small WWTPs. Lauschmann et al. (2013) presented results from applying pre-precipitation to a vertical flow wetland in Austria. However, due to the operational requirements of phosphorus precipitation and the relatively high costs, these technology is not suitable for very small WWTPs (less than 50 people connected).

Practical experience of the local authorities that are giving the permission for operating WWTPs shows that phosphorus precipitation at WWTPs with design size < 50 PE does not work over a longer period. Thus, local authorities hardly request phosphorus removal for small WWTPs even for very sensitive catchments.

The application of post-treatment filters with high phosphorus adsorbing filter materials has been investigated during the last 20 years and a large number of potential filter materials has been studied (e.g. Loderer, 2005; Vohla et al., 2011). The filter materials studied for phosphorus removal include natural materials (e.g. apatite, oyster shells), industrial by-product (e.g. oil shale ash blast furnace slags) and manufactured products (such as Filtralite P<sup>®</sup>, Ferrosorp<sup>®</sup>, LECA<sup>®</sup>, Phosclean<sup>®</sup>). As phosphorus is a limited mineral resource, filter materials from which phosphorus can be finally reused as fertilizer in agriculture are preferable. Thereby, the effects of high phosphorus binding capacity for high removal and high plant availability of phosphorus as fertilizer might be contradictory (Jenssen et al., 2010).

For this study, we investigated crashed concrete, Ferrosorp<sup>®</sup> and Phosclean<sup>®</sup> as potential filter materials post-treatment filters. In a previous study (Loderer, 2005), crashed concrete and Ferrosorp<sup>®</sup> have been shown to be the best materials in terms of adsorption capacity, whereas Phosclean<sup>®</sup> is a relatively new product that is based on apatite and is already used in France since about 10 years (Molle et al., 2011). The producers of Phosclean<sup>®</sup> aim to use the bound phosphorus as fertilizer once the filter saturation is reached.

In this study, we investigate the use of post-treatment filters for phosphorus removal from small WWTPs within the specific Austrian context. The specific objectives of the work are:

1. To investigate the effect of phosphorus removal in small WWTPs on the phosphorus balance of a small catchment.
2. To compare the costs of different solutions for phosphorus removal for small WWTPs, i.e. phosphorus filters and precipitation.
3. To estimate the number of small WWTPs in Austria for which phosphorus removal is relevant based on immission-related criteria.

## **Material and Methods**

### ***Phosphorus balace of a small catchment***

As case study for a small sensitive catchment, the Wambach stream south of Linz in Upper Austria was selected. The Wambach stream has a length of 8 km with mean water 0.11 m<sup>3</sup>/s, its catchment is 14.4 km<sup>2</sup>. In the Wambach catchment there is no sewer system, 15 small WWTPs treat the wastewater of about 180 persons (Figure 1). 8 WWTPs in the Wambach catchment have biological treatment with nitrification (as requested by the Austrian regulation) whereas the remaining 7 WWTPs are old plants with only primary treatment.

Besides the WWTPs, other sources for phosphorus considered in the catchment are erosion from agricultural fields, drainages, and fishponds. Data from literature and from the Government of Upper Austria have been used as basis for estimating the phosphorus balance of the catchment.

Besides for the actual status (i.e. 8 WWTPs with biological treatment and 7 WWTPs with primary treatment), phosphorus emissions from WWTPs have been calculated for three further scenarios:

1. The 7 WWTPs with primary treatment are upgraded to biological treatment with nitrification.
2. Phosphorus removal is only applied for the 8 WWTPs that already have biological treatment.
3. Phosphorus removal is applied for all 15 WWTPs, i.e. the 7 WWTPs with primary treatment are upgraded to biological treatment with nitrification.

The phosphorus load of raw wastewater is assumed to be  $1.8 \text{ g P.person}^{-1}.\text{day}^{-1}$ , the daily water consumption  $100 \text{ L.person}^{-1}.\text{day}^{-1}$ , resulting in a concentration of  $18 \text{ mg P/L}$  in raw wastewater. Based on measurements of the local authorities, the average effluent concentration of small WWTPs in this area is  $9.6 \text{ mg P/L}$ , thus the average P removal for small WWTPs with nitrification was assumed to be 47 %, i.e. the effluent load from the WWTPs is  $0.96 \text{ g P.person}^{-1}.\text{day}^{-1}$ . For scenarios with phosphorus removal, the maximum phosphorus an effluent concentration of  $2 \text{ mg P/L}$  was assumed (the effluent standard for WWTPs  $>1,000 \text{ PE}$  according to 1.AEVkA, 1996), i.e. the effluent load is reduced to  $0.20 \text{ g P.person}^{-1}.\text{day}^{-1}$ .

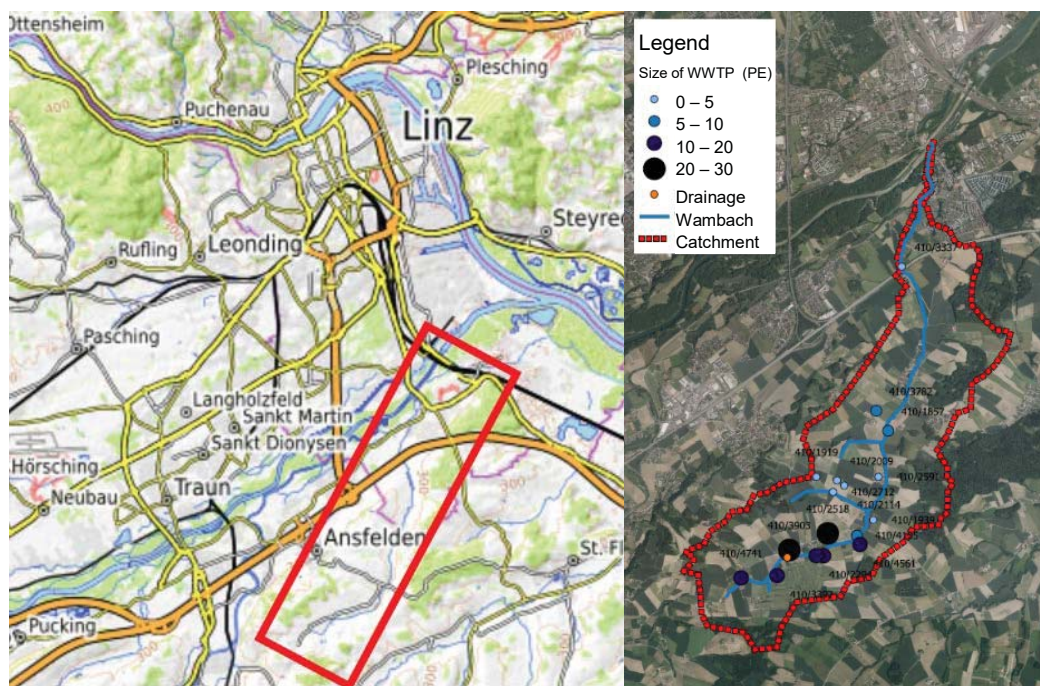


Figure 1. Wambach stream catchment (left) and small WWTPs in the catchment (right) (adapted from Langitz, 2017).

### *Costs of different solutions for phosphorus removal for small WWTPs*

Costs have been calculated for different technological solution for phosphorus removal, i.e. phosphorus precipitation and post-treatment filters with different reactive media (crashed concrete, Ferrosorp ® and Phosclean ®).

For the estimation of costs, a WWTP with 15 PE has been used. This is the average size of a WWTP in the Wambach catchment. Post-treatment filters have been dimensioned assuming a typical influent concentration of  $9.6 \text{ mg P/L}$  and a maximum effluent concentration of  $2.0 \text{ mg P/L}$  for three different

lifetimes of the filter material, i.e. 1, 7.5 and 10 years, respectively. 7.5 years have been chosen as the typical duration for permits for small WWTPs in Austria is 15 years and thus one change of filter material with the permit duration occurs.

The yearly costs have been calculated for all alternatives according to LAWA (2005). Investment, operational and reinvestment costs have been considered. The net present values have been calculated for 15 and 30 years duration using an interest rate of 3 %.

Costs for phosphorus precipitation have been calculated based on data from Lauschmann et al. (2013), cost for the post-treatment filters are based on the data from Loderer (2005). More details on the cost calculations can be retrieved from Langitz (2017).

### ***Number of small WWTPs in Austria with requirement for phosphorus removal***

Gerstorfer (2017) overlapped the location of the 28'700 small WWTPs (Langergraber and Weissenbacher, 2017) with the map of Austrian surface waters that have issues with nutrients (NGP, 2015). Based on the number of small WWTPs and the occurrence of nutrient sensitive water bodies this analysis could be restricted to the federal states Upper Austria, Lower Austria and Styria (more than 60 % of the small WWTPs are located in these three states). In the other federal states, either the number of nutrient sensitive water bodies and/or the number of small WWTPs is low.

## **Results and Discussion**

### ***Phosphorus balance of a small catchment***

Table 1 summarises minimum and maximum yearly phosphorus loads to the Wambach catchment. The analysis showed that erosion from agricultural fields is the main source of phosphorus emission. However, this emission only occurs during rain events. The second largest proportion of phosphorus emission originates from the WWTP effluents. As the small WWTPs are not obliged to remove phosphorus the emissions are relatively high. Especially at low water flows, small WWTPs are the main source for phosphorus emissions and result in concentrations in the Wambach of about 0.2 mg P/L. Other phosphorus emission pathways have shown to be of minor importance.

Table 1: Phosphorus loads to the Wambach catchment in kg P.year<sup>-1</sup> (Langitz, 2017).

<b>Source</b>	<b>Minimum</b>	<b>Maximum</b>
<b>Erosion from fields</b>	252	2,516
<b>Small WWTPs</b>	82	94
<b>Drainages</b>	7	19
<b>Fishponds</b>	0	10

Table 2 shows the yearly phosphorus emissions from the small WWTPs. By up-grading the 7 WWTPs that currently have primary treatment only to the state-of-the-art, the emissions can be reduced by 22 % compared to the current status. When phosphorus removal is additionally applied at the 8 WWTPs that have nowadays biological treatment the emissions can be reduced by 43 %. Finally, when all 15 WWTPs have biological treatment plus phosphorus removal, 83 % of the current phosphorus emissions can be avoided.

Table 2: Phosphorus emissions from small WWTPs to the Wambach catchment for different szenarios (Langitz, 2017).

Szenario	biological treatment	WWTPs with primary treatment	P-removal	P emission (kg P.year <sup>-1</sup> )	Reduction
Base	8	7	0	88	-
1	15	0	0	69	22 %
2	8	7	8	50	43 %
3	15	0	15	15	83 %

### *Costs of different solutions for phosphorus removal for small WWTPs*

Yearly costs for the different technological options are presented in Table 3 for a period of consideration of 15 years and in Table 4 for a period of consideration of 30 years, respectively. It can be clearly seen that a shorter lifetime of the filter, i.e. a smaller filter volume that is exchanged more often, is favourable compared to a larger filter volume. This is mainly because the investment costs are much less for smaller filters. However, this strategy is not applicable for some filter materials that require a higher hydraulic retention time of in the post treatment filter (e.g. Phosclean®). Crashed concrete is the cheapest filter material, however, there is no supplier to date that provides and guarantees quality of the material in relation to grain size and composition and thus, finally also phosphorus adsorption. As Ferrosorp® is about three-times more expensive compared to Phosclean® and additionally requires the largest filter volumes it is economically not feasible. The yearly costs of Phosclean® filter dimension of 7.5 or 10 year lifetime are similar as the yearly costs of phosphorus precipitation. For Phosclean® filters investment costs are higher but operational cost (only the periodically exchange of filter material) are lower compared to precipitation.

Table 3: Yearly cost in EUR.person<sup>-1</sup>.year<sup>-1</sup> for the different technical options for phosphorus removal from a WWTP with 15 PE over a 15-year period of consideration.

Life time of filter	Costs	Post-treatment filter of			Precipitation
		crashed concrete	Ferrosorp®	Phosclean®	
1 year	Investment	1.52	4.53	2.48	5.33
	Operational	4.79	31.09	14.59	19.53
	<b>Total</b>	<b>6.32</b>	<b>35.62</b>	<b>17.07</b>	<b>24.86</b>
7.5 years	Investment	10.40	32.93	17.56	5.33
	Operational	2.60	16.15	7.02	19.53
	<b>Total</b>	<b>12.99</b>	<b>49.08</b>	<b>24.57</b>	<b>24.86</b>

Table 4: Yearly cost in EUR.person<sup>-1</sup>.year<sup>-1</sup> for the different technical options for phosphorus removal from a WWTP with 15 PE over a 30-year period of consideration.

Life time of filter	Costs	Post-treatment filter of			Precipitation
		crashed concrete	Ferrosorp®	Phosclean®	
1 year	Investment	1.52	4.53	2.48	5.33
	Operational	7.87	51.05	23.96	32.07
	<b>Total</b>	<b>9.39</b>	<b>55.57</b>	<b>26.43</b>	<b>37.40</b>
7.5 years	Investment	10.40	32.93	17.56	5.33
	Operational	4.77	37.26	16.25	32.07
	<b>Total</b>	<b>15.17</b>	<b>70.19</b>	<b>33.80</b>	<b>37.40</b>
10 years	Investment	13.81	43.86	23.36	5.33
	Operational	3.34	24.86	11.29	32.07
	<b>Total</b>	<b>17.15</b>	<b>68.72</b>	<b>34.64</b>	<b>37.40</b>

### ***Number of small WWTPs in Austria with requirement for phosphorus removal***

Table 5 summarises the number of small WWTPs in Lower Austria, Styria and Upper Austria and shows the percentage of those WWTPs located in nutrient sensitive catchments. From the 18'100 small WWTPs in the three federal states, about 3'900 or 21% are located in nutrient sensitive catchments. The highest share can be found in Upper Austria where 41 % of the small WWTPs are located in nutrient sensitive catchments, i.e. in total about 1'000 plants. The highest number with about 1'900 small WWTPs is found in Styria. As mentioned above, the number of WWTPs in nutrient sensitive catchments in Carinthia, Salzburg, Tyrol and Vorarlberg is negligible as there are almost no nutrient sensitive catchments, in Burgenland and Vienna, the number of small WWTPs is very low (Gerstorfer, 2017).

Table 5: Number of WWTPs smaller than 500 PE in Lower Austria, Styria and Upper Austria located in nutrient sensitive catchments.

<b>Federal state</b>	<b>Total number</b>	<b>Located in nutrient sensitive catchments</b>	
Lower Austria	4'900	940	19%
Styria	10'700	1'900	18%
Upper Austria	2'500	1'040	41%
Total	18'100	3'880	21%

The spatial distributions of these WWTPs in Upper Austria is shown in Figure 2. Most small WWTPs in nutrient sensitive catchments are located in the districts north of the Danube (i.e. the districts Rohrbach, Urfahr-Umgebung and Freistadt) and in the districts Schärding, Ried/Innkreis and Linz-Land. The highest share can be found in Ried/Innkreis, where 227 or 95 % of the 238 small WWTPs are located in nutrient sensitive catchments. Due the more mountainous landscape, the share of small WWTPs in nutrient sensitive catchments is low in the districts with the most small WWTPs (i.e. Kirchdorf and Steyr-Land). In the other two investigated federal states, Lower Austria and Styria, the results have been similar. Most small WWTPs in nutrient sensitive catchments have been found in the lowlands and almost none in the more mountainous regions.

When considering the average size of the 3'880 small WWTPs of 20 PE, there is demand for phosphorus removal from WWTPs that treat the wastewater of about 77'600 persons. When considering an inflow concentration to the post-treatment filters of 7.9 mg P/L, the maximum allowed effluent concentration of 2.0 mg P/L and a daily water use of 100 L per person and day, the theoretical recovery potential of phosphorus from small WWTPs is about 21.5 tons per year.



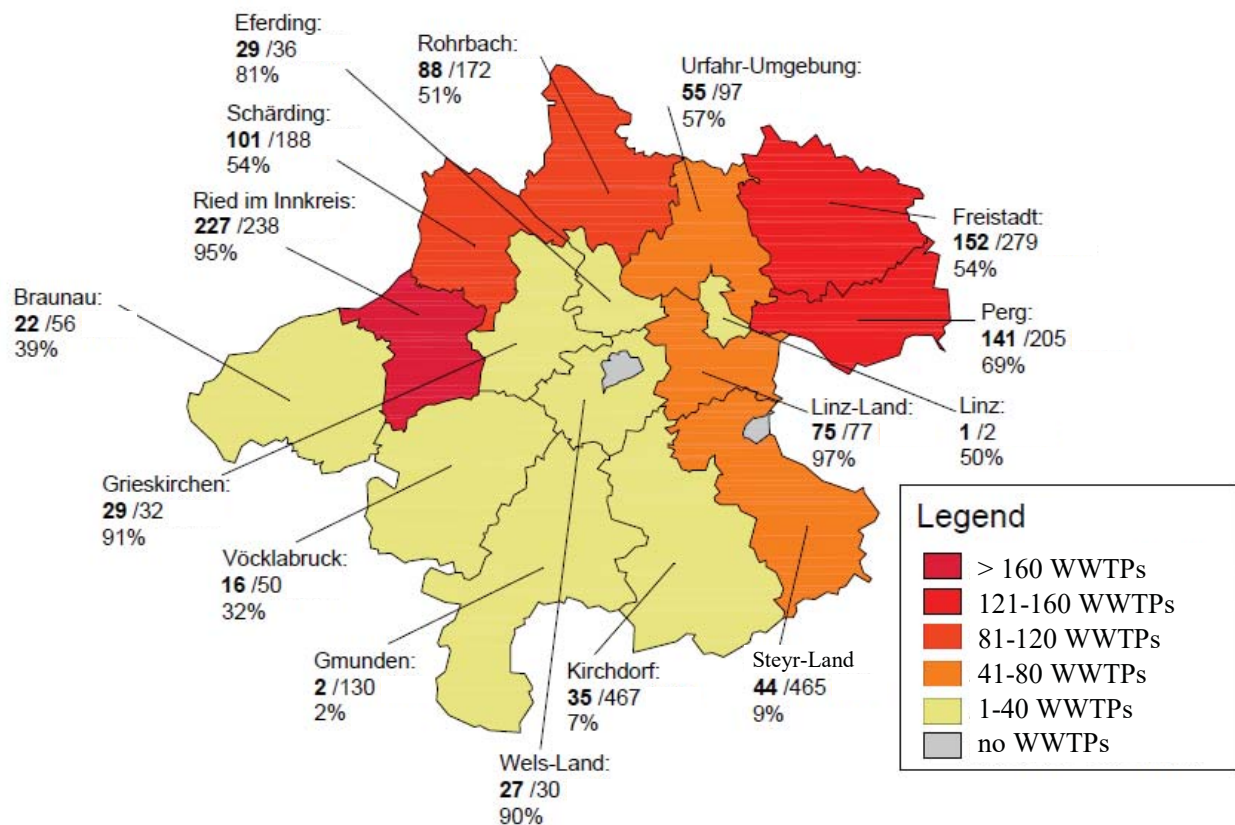


Figure 2: Distribution of small WWTPs in nutrient sensitive catchments in the districts of Upper Austria (meaning of the numbers e.g. for Freistadt district: 152 small WWTPs of in total 279 small WWTPs are located in nutrient sensitive catchments, i.e. 69 % of the total number).

## Conclusions

It can be concluded that:

- Phosphorus released from small WWTPs in the Wambach catchment only contributes little to the overall phosphorus emissions when compared to agricultural run-off.
- However, emissions from small WWTPs occur continuously and not only during storm events. Thus, WWTP emissions are mainly responsible for the phosphorus emissions in the stream during low flow periods.
- Phosphorus removal at small WWTPs in a sensible catchment can significantly reduce the concentration in the receiving waters.
- Post-treatment filters for phosphorus removal using Phosclean® as filter material that are designed for a lifetime of 7.5 or 10 years have comparable yearly costs when compared to phosphorus precipitation.
- These post-treatment filters have significantly higher investment costs; however, they have almost no operational requirements during the lifetime of the filter media whereas phosphorus precipitation requires constant operational efforts, which is a problem especially for small WWTPs.
- Additionally, Phosclean® filters give the opportunity to recover the phosphorus from the wastewater thus being an interesting alternative when resources should be recovered.



- The total amount of phosphorus that can be recovered from the around 3'900 small WWTPs in nutrient sensitive catchments only is about 16.7 tons per year.

## Acknowledgements

The authors thank the colleagues from the local authority in Upper Austria (Amt der oberösterreichischen Landesregierung) for providing data on the Wambach catchment.

## References

- 1.AEVkA (1996): 1. Abwasseremissionsverordnung für kommunales Abwasser (Austrian regulation for emissions from domestic wastewater). BGBl.210/1996, Vienna, Austria [*in German*].
- Gerstorfer, S. (2017): Immissionsorientierte Studie der Phosphorelimination bei Kleinen Kläranlagen und Kleinkläranlagen in Österreich (Study on immission-related phosphorus removal requirements for small wastewater treatment plants in Austria). *Master thesis*, Institute of Sanitary Engineering, BOKU University Vienna, Austria [*in German, in preparation*].
- Jenssen, P.D., Krogstad, T., Paruch, A.M., Mæhlum, T., Adam, K., Arias, C.A., Heistad, A., Jonsson, L., Hellström, D., Brix, H. (2010) Filter bed systems treating domestic wastewater in the Nordic countries – Performance and reuse of filter media. *Ecol Eng* 36(12), 1651-1659.
- Langergraber, G., Weissenbacher, N. (2017): Survey on number and size distribution of treatment wetlands in Austria. *Water Sci Technol* 75(10), 2309-2315.
- Langitz, N. (2017): Möglichkeiten zur Phosphorentfernung in einem kleinen Flusseinzugsgebiet (Possibilities of phosphorus removal in a small catchments). *Master thesis*, Institute of Sanitary Engineering, BOKU University Vienna, Austria [*in German*].
- Lauschmann, R., Lechner, M., Ertl, T., Langergraber, G. (2013): Experiences with pre-precipitation of phosphorus in a vertical flow constructed wetland in Austria. *Water Sci Technol* 67(10), 2337-2341.
- LAWA (2005): Leitlinien zur Durchführung dynamischer Kostenvergleichsrechnungen (Guidelines for the implementation of dynamic cost comparisons). Länderarbeitsgemeinschaft Wasser (LAWA), Berlin, Germany [*in German*].
- Loderer, C. (2005): Optimisation of phosphorus-removal in constructed wetlands. *Diploma thesis*, FH Pinkafeld, Austria.
- Molle, P., Martin, S., Esser, D., Besnault, S., Morlay, C., Harouiya, N. (2011): Phosphorus removal by the use of apatite in constructed wetlands: Design recommendations. *Water Practice & Technology* 6(3), doi:10.2166/wpt.2011.046.
- NGP (2015): Entwurf Nationaler Gewässerbewirtschaftungsplan (NGP) 2015 (Draft of national water management plan). <https://www.bmlfuw.gv.at/wasser/wisa/fachinformation/ngp/ngp-2015.html> (last access: 26 July 2017) [*in German*].
- Vohla, C., Kõiv, M., Bavor, H.J., Chazarenc, F., Mander, Ü. (2011): Filter materials for phosphorus removal from wastewater in treatment wetlands—A review. *Ecological Engineering* 37 (2011) 70–89.

# Phosphate removal from secondary effluent using chemically modified zeolite

Malamis, S.<sup>1</sup>, Agryropoulou, K.<sup>1</sup>, Egas Galarza, D.<sup>2</sup>, Katsou, E.<sup>2</sup>

<sup>1</sup>National Technical University of Athens, Department of Water Resources and Environmental Engineering, School of Civil Engineering, 5 Iroon Polytechniou, Zografou Campus, 15780, Athens, Greece

<sup>2</sup>Brunel University, Department of Mechanical, Aerospace and Civil Engineering, Uxbridge, London, UK

**Keywords:** phosphate; adsorption; secondary effluent; modified zeolite

## Introduction

In cases where very low (<0.2 mgP/L) phosphorus concentrations are required, advanced tertiary treatment options are required (Metcalf and Eddy, 2003). Adsorption of phosphate using low-cost minerals can be a cost effective process. Zeolites are hydrated alumina-silicate minerals; they have a defined framework structure with micropores and mesopores which are filled with water and cations (Król et al., 2012). Due to its negative surface charge, this material has not been widely used to remove phosphate (Jiang et al., 2013). The modification of its anionic species can enhance the characteristics of this material and improve its sorption capacity for anions. The modified zeolite can be an attractive option to remove low phosphate concentrations (Kim et al., 2013; Lů et al., 2013). In this work chemically modified zeolite was used as an adsorbent to remove and recover phosphate from secondary effluent.

## Material and Methods

Natural zeolite (85% clinoptilolite) from Greece was used as an adsorbent. Zeolite was washed with deionized water, and dried at 180°C. 10 g/L of zeolite was placed in FeCl<sub>3</sub> and CaCl<sub>2</sub> solution containing 425 mgFe(III)/L and 250 mgCa/L respectively for 2 days to produce the Fe-modified zeolite (Fe-Z) and the Ca-modified zeolite (Ca-Z). The sorption tests were carried out in batch reactors having a working volume of 500 mL. The effect of a number of parameters on the sorption process was tested, including the type of chemical modification (Fe-Z, Ca-Z), sorbent concentration (0.5-10 g/L), the pH of the solution (4-9), and the liquid medium (aqueous solution, secondary effluent). Phosphate sorption kinetics and equilibrium were examined. EDS was used to analyse the natural zeolite, the Fe-Z and Ca-Z. The measurement of phosphate concentration was done according to the standard methods.

## Results and Discussion

The EDS characterisation shows that the primary constituents of natural zeolite are Si and Al. After the modification of the material with Fe(III), Si remains the main constituent of the adsorbent followed by Al, Ca and Fe, as presented in Table 1. The iron content in the adsorbent after the modification is increased due to the ion exchange between Mg and Ca as evidenced by the decrement of the Mg/Si and Ca/Si ratios after de modification. Also, it is possible to

determine that the aluminosilicates properties of N-Z were not affected by the modification because the Al/Si ratio remains practically the same for N-Z, Fe-Z and Ca-Z (Table 2).

**Table 2:** Chemical characteristics of the adsorbent materials (%w)

Element (%w)	Adsorbent		
	N-Z	Fe-Z	Ca-Z
Mg	3.53	2.99	3.15
Al	16.07	15.33	15.17
Si	59.02	55.6	56.22
S	0.42	0.17	0.38
K	1.01	2.24	0.97
Ca	9.43	7.47	<b>14.29</b>
Fe	8.59	<b>15.84</b>	8.07
others	1.93	0.36	1,75

**Table 1:** Al/Si, Fe/Si, Ca/Si and Mg/Si ratios of natural and modified zeolite (N-Z and FeZ)

Adsorbent	Element Ratio			
	Al/Si (% wt)	Fe/Si (% wt)	Ca/Si (% wt)	Mg/Si (% wt)
N-Z	0.272	0.146	0.160	0.059
Fe-Z	0.276	<b>0.285</b>	0.134	0.054
Ca-Z	0.270	0.143	<b>0.254</b>	

The equilibrium data fitted very well to Freundlich's equation  $R^2 \geq 0.93$  for all the examined cases. Therefore, a multilayer adsorption could be ruling the process for the two concentrations. Several authors have also reported that Freundlich is the best model to explain the P-adsorption isotherms for chemically modified zeolite. The examination of the process kinetics showed that the pseudo-second order provided the best fit to the experimental data with  $R^2 > 0.97$ ; this revealed that chemical sorption is the dominant phosphate removal mechanism. As the dosage of the chemically modified zeolite was increased the phosphate removal efficiency increased, while the sorption capacity at equilibrium  $q_e$ . The sorption of phosphate followed the order Fe-Z > Ca-Z > N-Z, with N-Z resulting in negligible sorption. Low pH (=4-5) resulted in enhanced P removal by Fe-Z compared to pH=8-9; this showed that  $H_2PO_4$  was more effectively sorbed to Fe-Z than  $HPO_4^{2-}$ . The secondary effluent resulted in similar and in some cases high sorption capacity compared to aqueous solutions, showing that the presence of other cations such as nitrates, sulphates and chlorides did not adversely affect the P sorption process.

## References

- Metcalf & Eddy (ed.), Tchobanoglous, G., Burton, F.L., Stensel, H.D. Wastewater engineering: treatment and reuse. 4<sup>th</sup> ed. New York; London: McGraw-Hill; 2003.
- Król, M., Mozgawa, W., Jastrzębski W, Barczyk K., 2012. Application of IR spectra in the studies of zeolites from D4R and D6R structural groups. *Micropor. Mesopor. Mater.* 156, 181-188.
- Jiang, C., Jia, L., He, Y., Zhang, B., Kirumba, G., Xie, J., 2013. Adsorptive removal of phosphorus from aqueous solution using sponge iron and zeolite. *J. Colloid. Interface. Sci.* 402, 246-252.
- Kim, K.S., Park, J.O., Nam, S.C., 2013. Synthesis of iron-loaded zeolites for removal of ammonium and phosphate from aqueous solutions. *Environ. Eng. Res.* 18, 267-276.
- Lü, J., Liu, H., Liu, R., Zhao, X., Sun, L., Qu, J. 2013. Adsorptive removal of phosphate by a nanostructured Fe–Al–Mn trimetal oxide adsorbent. *Powder Technol.* 233, 146-154.

# Alumina-based adsorbants for Phosphorus removal and recovery on small wastewater treatment plants

Ref # S2SMALL-92501

Cornet, F.<sup>1\*</sup>, Barthelet, K.<sup>2</sup>, Richard, D.<sup>2</sup>, Reyt, J-P.<sup>2</sup>

<sup>1</sup> SAS MAANEO, 10 Avenue de l'Europe, 31520 Ramonville Saint Agne, France

<sup>2</sup> IFPEN - Institut Français du Pétrole-Energies Nouvelles, 1-4 Avenue de Bois Préau, 92852 Rueil Malmaison, France

\*Corresponding author : francois.cornet@maaneo.com

**Keywords:** phosphorus removal, phosphorus recovery, alumina-based adsorbant, small wastewater treatment plants

## Introduction

The European Directive 2000/60/EC, which established a framework for Community action in the field of water policy, aimed to achieve good surface water status for all Member States before December the 22<sup>nd</sup>, 2015. Despite its commitment to reach this goal, over 75% of France's continental area is still classified today as sensitive to eutrophication. Phosphorus is recognized as the main factor responsible for fresh water eutrophication (Barroin, 2003). For example, it is the first cause of the downgrading in quality of surface fresh water bodies in the Loire watershed (Agence de l'Eau Loire-Bretagne, 2015). A specific demand for P removal is presently developing in France, from water regulation authorities towards small communities, in order to comply with EC Directives.

During the last 15 years, various processes have been specifically designed for P removal in small community effluents, mainly using natural compounds, such as Apatite (Troesch and al., 2016), or industrial by-products, such as electric-arc furnace slags (Prigent, S., 2012). However, our benchmarking of tenders published in 2016 in France shows that, whenever P removal is required for a small wastewater treatment plant (capacity < 2000 PE), FeCl<sub>3</sub> precipitation on activated sludge plants remains the adopted solution in 86% of cases (28 plants in 2016). Nonetheless, activated sludge is the most expensive process for small units (Observatoire de l'eau en Seine et Marne, 2011). This fact indicates that, in spite of all the research work which has already been done, a strong need remains for a P removal process that would be specifically adapted to small communities, in terms of efficiency, ease of operation, and cost. Our work presents an innovative answer to this problem, using adsorption on custom-designed aluminas.

## Material and Methods

We specifically designed alumina-based adsorbants for Phosphorus removal using a simple filtration process. We first characterized their Phosphorus adsorption capacities through batch experiments, using both synthetic solutions with P concentrations between 2 and 100 mg/l (dissolution of NaH<sub>2</sub>PO<sub>4</sub> in demineralized water), and a real effluent sampled at the outlet of a reed bed sewage treatment plant. We then performed dynamic experiments on columns filled with 0.60 ml of the best solids, in order to confirm their P-binding capacities at hydraulic residence times of 0.25, 0.5, and 1.0 hour. Outlet P concentration was monitored at regular intervals during 200, 100, and 50 hours, respectively. The adsorbants' ability to be regenerated was also investigated by testing different regeneration protocols involving acid and basic solutions. Presently, this new dephosphatization process is under evaluation at pilot scale in real conditions, in order to determine its scalability to full size units.

## Results and Discussion

Among the tested solids, some reach a P-binding capacity of between 12 and 15 mgP/g in jar tests. Their capacities in column experiments are nevertheless smaller than in batch experiments, with capacities of between 2.6 and 6.1 mgP/g. This reduction of capacity was predictable as we chose to stop the experiment when the outlet concentration of phosphorus reached 2 mgP/L. Due to the mass transfer zone in the column, part of the adsorbant remains unsaturated under these conditions. However, these capacities are still highly interesting for waste-water dephosphatization, especially since we succeeded in regenerating them. The graphs in figure 1 show breakthrough curves after four successive cycles. Despite a totally inefficient regeneration procedure in cycle 3, the P-binding capacity is almost fully restored in cycle 4. These results prove the efficiency of regeneration process, when adequately conducted, and present a new means of P-recovery from small communities' wastewater treatment plants. Pilot-scale experiments in representative conditions are presently being monitored in order to confirm these results.

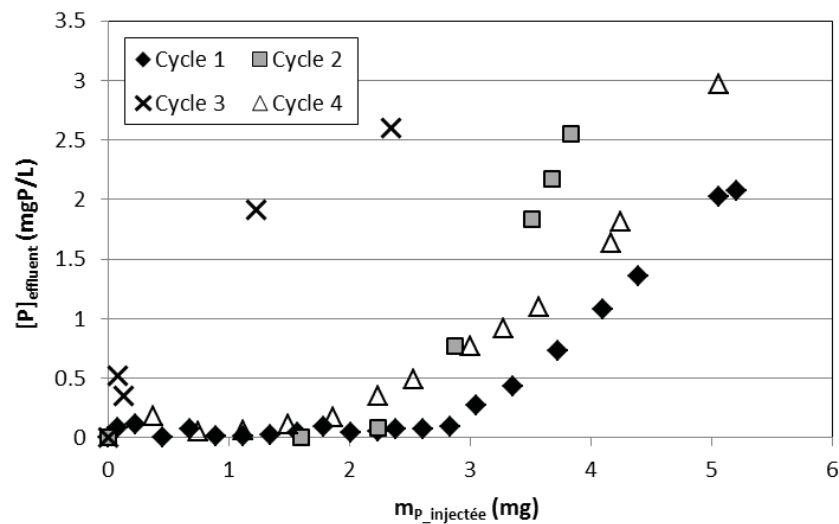


Figure 1. Comparison of initial Phosphorus breakthrough curve with curves obtained after one, or several, regeneration cycles. Filtration on mixed oxide-alumina adsorbant media.

## References

- Barroin, G.**, 2003, *Phosphore, azote et prolifération des végétaux aquatiques (Phosphorus, nitrogen and aquatic plants proliferation)*, Le Courrier de l'Environnement 48.
- Agence de l'Eau Loire-Bretagne**, 2015, *Etat 2013 des masses d'eau en bassin Loire Bretagne (Quality status of water bodies in the Loire-Brittany bassin in 2013)*, p.5.
- Troesch, S.**, 2016, *Natural rock phosphate: a sustainable solution for phosphorous removal from wastewater*, Procedia Engineering 138, pp. 119 – 126.
- Prigent, S.**, 2012, *Optimisation du traitement de l'azote et du phosphore des eaux usées domestiques adapté aux filtres plantés de Roseaux (Optimization of nitrogen and phosphorus removal in constructed wetland)*, Ecole des Mines de Nantes, 229 p.
- Observatoire de l'eau en Seine et Marne**, 2011, *Performance des filières de traitement adaptées aux petites collectivités en Seine-et-Marne (Performances of wastewater treatment process adapted to small communities in Seine et Marne)*, 72 p.

*This project is funded by the Agence de l'Eau Adour-Garonne and the Regional Council of Occitanie.*

# Tertiary nitrification and phosphorus removal from domestic wastewater with constructed wetlands

Ref # S2SMALL-621771

G. C. Dotro <sup>1\*</sup>, E. Butterworth, N. Jenkins, J. Barak, B. Jefferson

<sup>1</sup> Cranfield University, College Road, Cranfield, Bedfordshire, MK43 0AL, United Kingdom

\* Presenting Author: [g.c.dotro@cranfield.ac.uk](mailto:g.c.dotro@cranfield.ac.uk)

**Keywords:** ammonia, iron, nitrogen, phosphorus, reed beds, tertiary treatment.

## INTRODUCTION AND MAIN METHODS

Whilst municipal wastewater treatment plants (WwTPs) serving less than 2,000 population equivalents (PE) were traditionally designed to treat organics and suspended solids, in recent years legislation worldwide is requiring even these rural works to deliver effluents with low levels of ammonia (NH<sub>4</sub>-N) and phosphorus (TP). These can be as low as less than 3 mgNH<sub>4</sub>-N/L and less than 1 mg TP/L. As a result, WwTPs operators need upgrading technology options that can be easily retrofitted into existing flowsheets. Tertiary constructed wetlands (CWs) can be one such technology.

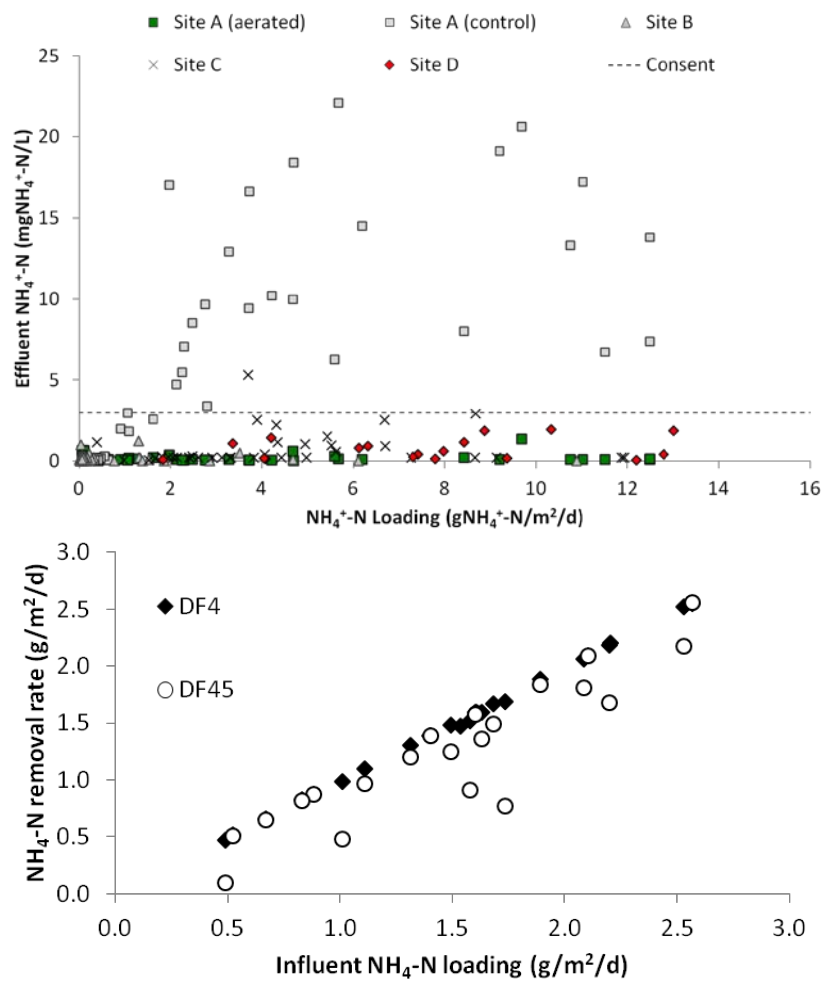
This presentation will summarise three different research projects that examined the potential of CWs to provide tertiary nitrification and remove residual TP from chemically-dosed effluents. The work includes the monitoring of five full-scale aerated horizontal flow (AHF) CWs, two conventional tertiary HF CWs, and eight pilot-scale tertiary vertical flow (VF) CWs installed at an operational WwTP. Effluent were monitored with a combination of composite and grab samples that were analysed following *Standard Methods* (2005) at Cranfield University laboratory facilities; in-situ measurements of relevant environmental parameters including dissolved oxygen (DO), pH, and sludge levels; sludge digestion for determination of total content of TP and iron (Fe); and particle size fractionation analysis of water samples to distinguish between suspended, colloidal and dissolved species of TP and Fe (Dotro et al 2015).

## MAIN RESULTS AND CONCLUSIONS

### Tertiary nitrification

The introduction of aeration, either passively in VF or forced in AHF systems, ensured DO was no longer a limiting variable in achieving tertiary nitrification. Both types of wetlands showed an increase in nitrification capacity commensurate with the increase in influent ammonia concentration, suggesting the systems were load limited rather than oxygen limited (Figure 1). Effluent concentrations achieved in both types of CWs were well below 3 mg/L, thereby enabling the existing works to meet new consents. Nitrification rates were likely limited by the availability of nitrifier population, which relates to load profile of the individual sites. The maximum nitrification capacity was not reached in either type of system during either the full scale (AHF) and pilot scale (VF) trials.

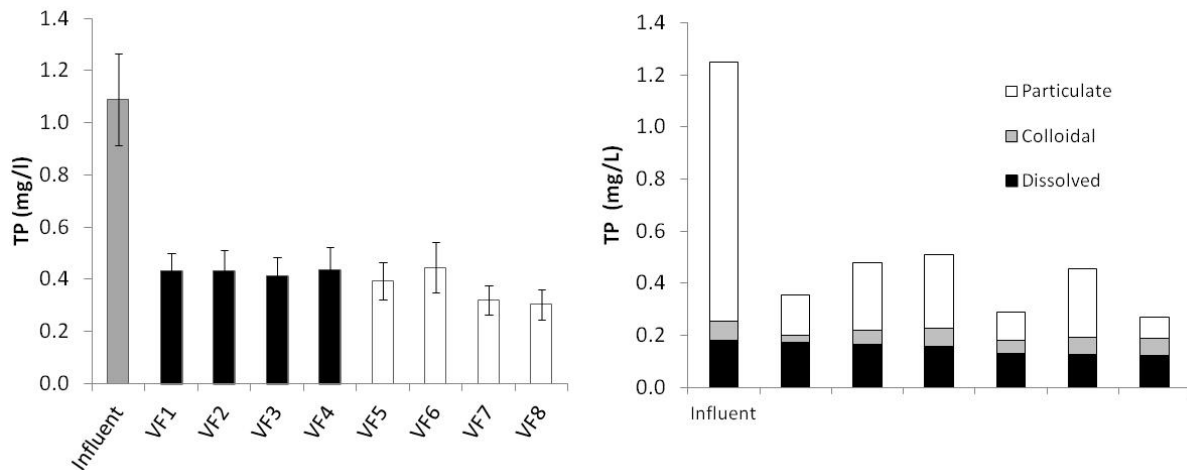




**Figure 1.** Ammonia removal as a function of ammonia load in (a) aerated horizontal flow and (b) vertical flow CWs. Figure 1a adapted from Butterworth et al (2016).

### Phosphorus removal

Both tertiary CWs were able to retain phosphorus. Size fractionation of the samples indicated phosphorus was retained primarily from the particulate fraction ( $>0.45 \mu\text{m}$ ), as expected from a chemically-dosed effluent. Both aerobic CWs were able to produce treated effluents of  $<0.5 \text{ mg TP/L}$ , whereas effluents from conventional (anoxic) HF systems were more dynamic and had some events of P release (Figure 2).



**Figure 2.** Total phosphorus concentrations and size fractionation in influent and effluent wastewater samples in VF wetland pilots. Adapted from Jenkins (2017).

## REFERENCES

Butterworth E., Richards A., Vale P., Mansi G., Ranieri E., Dotro G., Jefferson B. 2016 Ammonia removal at four full-scale artificially aerated horizontal flow constructed wetlands. *Water*, **8**(9), 365.

Dotro G., Fort R., Barak J., Jones M., Vale P., Jefferson B. 2015 Long-term performance of constructed wetlands with chemical dosing for phosphorus removal. In: *The Role of Natural and Constructed Wetlands in Nutrient Cycling and Retention on the Landscape*, J Vymazal (ed.), Springer Science + Business Media B.V., Dordrecht, Netherlands, pp. 273-292.

*Standard Methods for the Examination of Water and Wastewater*. 2005. 21st ed. American Public Health Association/American Water Works Association/Water Environment Federation, Washington DC, USA.

Jenkins N. 2017. *Vertical Flow Wetlands for Tertiary Wastewater Treatment*. EngD thesis, School of Water, Energy and Environment, Cranfield University, United Kingdom.

**Parallel session 1 - Small water treatment systems 1**

**08:10-09:30**

Session chair: Mei Yee Chan

**313 - UV LEDs for small systems: a revolution in robust and effective disinfection?**

HULL Natalie - *University of Colorado Boulder*

**458 - Moringa oleifera functional sand: a practical, reusable water treatment option**

WILLIAMS Frances - *The University of Adelaide*

**293 - An evaluation of small drinking water systems in a region of Brazil**

BENETTI Antonio - *Federal University of Rio Grande do Sul, Hydraulics Research Institute*

**456 - The Defluoridation Mechanism of Hydroxyapatite/Attapulgit Composite Beads**

FENG Li - *School of Chemical Engineering and Technology, China University of Mining & Technology*

**Parallel session 2 - Onsite Sanitation systems**

**09:50-11:10**

Session chair: Sinha Susmita

**542 - Development of a Solar Heating System for Improving Performance of On-site Sanitation Systems**

POLPRASERT Chongrak - *Thammasat University*

**311 - Isolation of butyric acid-degrading bacterium from pit latrine faecal sludge**

NJALAM'MANO John - *University of Pretoria*

**659 - Empowered septic tank as decentralized treatment system for a single household and for a community**

TALEKAR Guruprasad - *Birla Institute of Technology and Science - Pilani KKBirla Goa campus*

**Parallel session 3 - Environmental Assessment**

**14:00-15:20**

Session chair: Kai M. Udert

**314 - Stoichiometric life-cycle assessment for smart sewage treatment**

ALVARADO ROMAN Valeria Isabel - *The Hong Kong Polytechnic University*

**511 - Influence of pre-treatment on the attenuation performance of soil receiving on-site effluent**

KNAPPE Jan - *Trinity College Dublin*

**642 - Real-time-monitoring of water quality parameters for identification of the origin and the pathways of impacts in small and middle scale rivers**

MEYER Angelika - *Saarland University - Institute for Inorganic and Analytical Chemistry*

**517 - Chemical fingerprinting of on-site wastewater effluent contamination of small rivers and wells in Ireland**

GILL Laurence - *Trinity College Dublin*

# UV LEDs for small systems: a revolution in robust and effective disinfection?

Linden, K.<sup>1</sup>, Hull, N.M.<sup>1</sup>, Sholtes, K.<sup>1</sup>, Beck, S.,<sup>1,2</sup>

<sup>1</sup> Environmental Engineering, University of Colorado Boulder, Boulder CO 80303, USA

<sup>2</sup> Department of Environmental Microbiology, Eawag, Dübendorf, Switzerland

**Keywords:** Ultraviolet Light; Water Treatment

## Introduction

Conventional UV lamp technology used for municipal applications utilizes either LP or MP mercury vapor lamp sources, with the majority of small systems utilizing LP lamps as these can be easily used in a normal electrical system and the low flows result in a small UV system footprint.

While LP sources are more germicidally efficient, they lack any polychromatic nature which is now known to have advantages for inactivation of pathogens, specifically for viruses such as adenoviruses (Yates et al., 2006; Linden et al., 2007).

Recent advances in UVLED technology now offer the opportunity to create a tailored wavelength-specific disinfection system, with greatly improved efficiency over MP systems (Lawal, 2012) and no use of mercury in the lamp construction. Improved efficiency is due to better power conversion to light emission, emission targeted to the action spectra of pathogens, and potential for improved architecture in UV system design. UVLEDs are now available in wavelengths below 250 nm and gains in efficiency are increasing and expected to follow trends of other visible light LEDs. For small system disinfection, UVLEDs offer the potential for a low-power, high efficiency, pathogen targeted disinfection system. The first such commercial UVLED disinfection system, the UV Pearl (Aquionics, Earlsanger, KY) is recently available for purchase for industrial use. The objectives of this work were to evaluate the use of UVLEDs for disinfection of pathogens and surrogates by combining various wavelength specific UVLEDs, based on pathogen action spectra, and evaluate disinfection efficiency in comparison to conventional UV sources on the bench and pilot scale.

## Material and Methods

UVLEDs of varying wavelengths were tested in combinations for inactivation of indicators and pathogens and evaluated based on UV dose and energy consumption compared to UV 253.7 nm LP UV sources. UVLEDs are being evaluated in pilot studies at a small water treatment plant in Colorado for efficacy of disinfection and operations, including investigation of sustainability.

## Results and Discussion

Efficacy in inactivating common water-borne pathogens, fecal indicators, and surrogates *E. coli*, MS2 coliphage, adenovirus 2, and *Bacillus pumilus* spores by LEDs emitting at 260 nm, 280 nm, and the combination of 260|280 nm together was compared with the efficacy of the medium-pressure (MP) UV lamp as well as with low-pressure (LP) UV irradiation. Figure 1 illustrates the emission spectra of the LEDs and mercury lamps. Evaluation was for potential synergistic effects for both inactivation and the DNA and RNA damage level. For *E. coli*, the results showed similar inactivation rates among all five UV sources. For MS2 coliphage, the 260 nm LED was most effective, followed by the equally effective 260|280 nm combination and MPUV, and subsequently the 280 nm and LP UV sources. For adenovirus 2, the MPUV was significantly more effective than the other four UV sources. For *B. pumilus* spores, the MPUV was most effective, followed by the equally effective 260 nm and 260|280 nm LEDs with the 280 nm LED and LPUV irradiation the least effective. Each scenario was also compared for electrical energy per order of log reduction. No dual-wavelength synergy was detected in all four microorganisms and viruses nor in the DNA and RNA measured. The flow-through UV reactor system is currently installed and being evaluated for another 6 months.

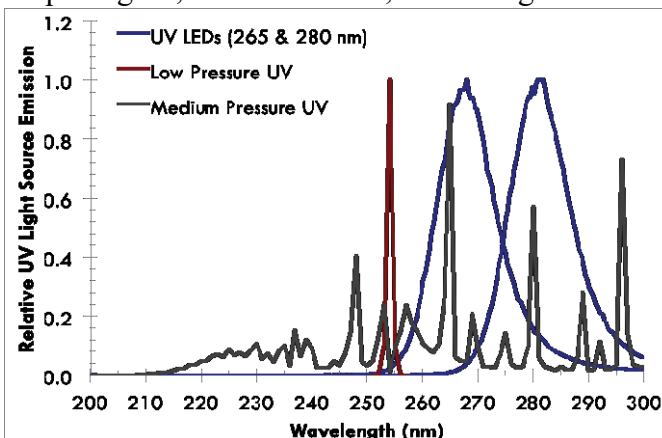


Figure 1. Emission of two common UV LEDs in comparison to LP and MP mercury vapor lamps.

## References

- Lawal, O. (2012) Today's Real World Applications for UV-C LED Light Sources: Next Gen UV Disinfection Today! IUVA Regional Conference, Washington DC, August 12-14 2012
- Linden, K.G., Thurston, J., Schaefer, R., Malley, J.P. Jr. (2007) "Enhanced UV Inactivation of Adenoviruses under Polychromatic UV Lamps" *Applied and Environmental Microbiology*, 73, 23, pp. 7571–7574
- Yates, M., J. P. Malley, Jr., P. Rochelle, and R. Hoffman (2006) Impact of adenovirus resistance on UV disinfection requirements: A report on the state of adenovirus science. *Journal AWWA* 98, 6, pp. 93–106

## ***Moringa oleifera* functional sand: a practical, reusable water treatment option**

Ref # S2SMALL-82653

F. E. Williams<sup>1\*</sup>, A. Lee<sup>1</sup>, S. Orandi<sup>1</sup>, D. M. Lewis<sup>1</sup>

<sup>1</sup> The University of Adelaide, School of Chemical Engineering, Adelaide 5005, Australia

\* Corresponding Author: frances.e.williams@adelaide.edu.au

### **Abstract**

*Moringa oleifera* functional sand (*f*-sand) can effectively remove bacteria from water by immobilizing and inhibiting *Escherichia coli* onto a polypeptide attached to the sand surface. The aim of this work was to investigate whether the *f*-sand could be regenerated by subjecting the inhibited bacteria to either heated water or a non-ionic surfactant solution. The initial method trialed involved washing *f*-sand with water heated between 60°C and 100°C. The second method trialed involved washing the sand with 0.001 M, 0.01 M and 0.1 M dodecyl glucoside. The use of the 60°C water and the 0.01 M dodecyl glucoside to regenerate *f*-sand was successfully demonstrated.

**Keywords:** dodecyl glucoside, functional sand, *Moringa oleifera*, MO<sub>2.1</sub> polypeptide, reuse

## **INTRODUCTION**

*Moringa oleifera* seeds are traditionally used for water treatment due to its ability to visibly clarify turbid water (Jahn & Dirar 1979). This effect is due to MO<sub>2.1</sub>, a water soluble, cationic polypeptide that inhibits bacterial organisms, and coagulates suspended particles. MO<sub>2.1</sub> has been observed to adsorb electrostatically onto the negatively charged surface of silica sand particles. This functional sand (*f*-sand) can be used to attach and inhibit *E. coli* (Jerri *et al.* 2012). The inhibition of the *E. coli* by MO<sub>2.1</sub> occurs via penetration into the bacterial membrane by a hydrophobic kink in the amino acid sequence of the polypeptide and is separate to that part of the sequence which initiates coagulation (Suarez *et al.* 2005). The interaction between the *E. coli* and MO<sub>2.1</sub> leads to fusion of the inner and outer membrane, causing the antimicrobial effect (Shebek *et al.* 2015). The MO<sub>2.1</sub> is reported to adsorb to a range of surfaces including rice husk ash and granular activated carbon (Barajas & Pagsuyoin 2017).

In practice this attachment of *E. coli* to the *f*-sand prevents any further bacterial inhibition and the *f*-sand cannot be reused. This study investigates the effect that heat and two surfactants have on the attachment of MO<sub>2.1</sub> to the sand surface and whether either of these methods can be used to separate inhibited *E. coli* from the MO<sub>2.1</sub> without desorbing the MO<sub>2.1</sub> from the sand. The MO<sub>2.1</sub> polypeptide is reported to be thermoresistant and able to withstand heating to 95°C for 5 hours without loss of activity (Ghebremichael *et al.* 2005). In this study, the effect of water heated between 60 °C and 100 °C on the *f*-sand was determined. So was the effect of this heated water on the inhibited *E. coli*. This was compared to the effect of the non-ionic surfactant dodecyl glucoside as investigated previously (Williams Submitted). Dodecyl glucoside is a non-ionic surfactant. It is non-hazardous, biodegradable and rapidly degrades in aquatic environments (Gamia *et al.* 1997) and is known by the trade names lauryl glucoside and coco glucoside. Dodecyl glucoside is derived from glucose and fatty alcohol and is use in a wide range of household products including shampoos, clothes washing detergents and dishwashing detergents. In our previous work we determined that exposing 1 g samples of *f*-sand to the dodecyl glucoside resulted in a 10% reduction in the amount of polypeptide on the



sand surface and that no further loss of MO<sub>2.1</sub> occurred despite repeat washing (Williams Submitted).

## MATERIALS AND METHODS

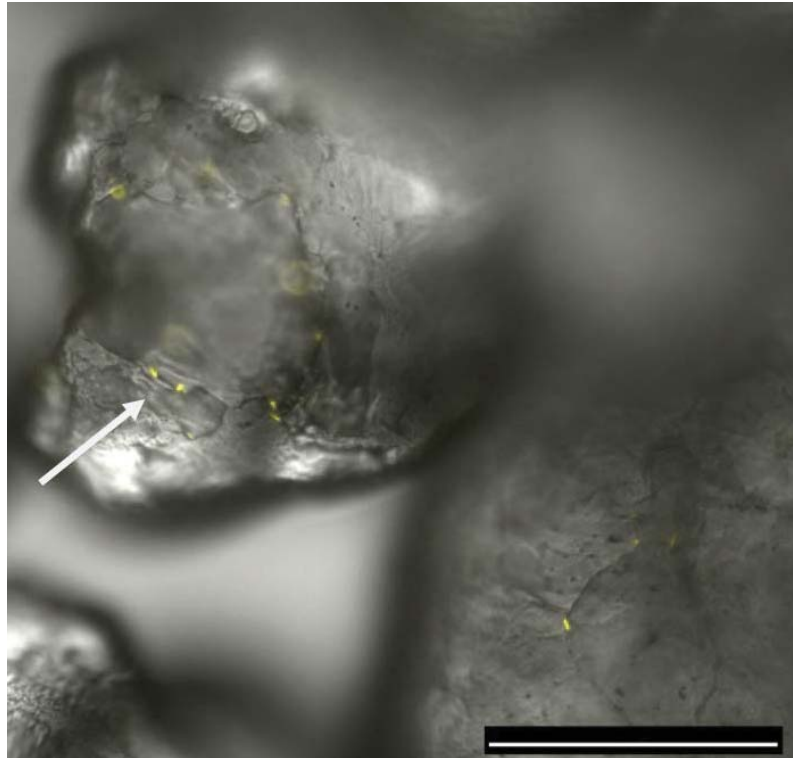
A 0.05 g/mL crude *M. oleifera* solution was prepared by mixing 20 g of dry, powdered *M. oleifera* seed with 400 mL of a 0.1 M sodium chloride solution for one hour. The crude solution was sieved and filtered through 0.45µm filter paper (Millipore) to remove any seed particles and bacteria. 100 g of commercially available, fine grained silica sand was thoroughly rinsed with deionised water, dried then autoclaved. The sand was combined with 400 mL of the filtered crude extract solution and mixed on a shaker plate for one hour. The *f*-sand was thoroughly rinsed with deionised water and dried overnight at 50°C.

Initial tests were performed to determine the effect of heat on the attachment of MO<sub>2.1</sub> to the sand. Dry 1g samples of *f*-sand were heated between 50 °C and 100 °C for 5 to 60 minutes. The *f*-sand was then rinsed and the remaining MO<sub>2.1</sub> eluted using a 0.6 M NaCl solution. The amount of polypeptide remaining on the *f*-sand after heating was determined by measuring the absorbance of the filtered solution at 280 nm using UV-visible spectroscopy (Shimadzu, 1601 UV-visible spectrophotometer). The concentration of polypeptide was determined using the Beer-Lambert law,  $Abs = \epsilon lc$ , with a path length (*l*) of 1 cm and an extinction coefficient ( $\epsilon$ ) of 1520 (Aitken & Learmonth 1996). The mass of MO<sub>2.1</sub> on the sand surface was then determined in mg per g sand using a molecular weight of 6781.6 g/mol, based upon the reported amino acid sequence of MO<sub>2.1</sub> (<http://www.uniprot.org/>).

The temperatures which did not significantly affect the attachment of the MO<sub>2.1</sub> to the sand surface were tested to elucidate their effect on the attachment of bacteria to the MO<sub>2.1</sub>. This was compared to the effect of different concentrations of the non-ionic surfactant dodecyl glucoside (CAS 11061-47-9, Ingredients Plus Australia) For this, 40 mL of a sterile 0.85% NaCl solution dosed with 1x10<sup>8</sup> CFU/mL *Escherichia coli* (ATCC® 25922™) was run through 50 g of *f*-sand contained in a glass column. Unattached *E. coli* was removed by rinsing the column twice with sterile Milli-Q water. The immobilised *E. coli* was exposed to either 80 mL heated water or 40 mL of surfactant solution (0.01 M, 0.001 M or 0.0001 M dodecyl glucoside) followed by two to four 40 mL rinses with sterile Milli-Q water. The entire process was repeated three times with the same *f*-sand sample to determine the reusability and the amount of *E. coli* removed each time was recorded. For the heated water tests, a uniform *f*-sand temperature was achieved by packing the *f*-sand into a glass condenser fitted with a filter and pumping heated water around the outside of the columns while the heated water passed through the centre. The column was then rinsed twice with sterile Milli-Q water. Fluorescence imaging was performed on the *f*-sand at initial bacteria attachment using a Nikon live cell microscope. The *E. coli* cells were stained with propidium iodide; a fluorescent stain which only attaches to membrane-compromised bacterial cells.

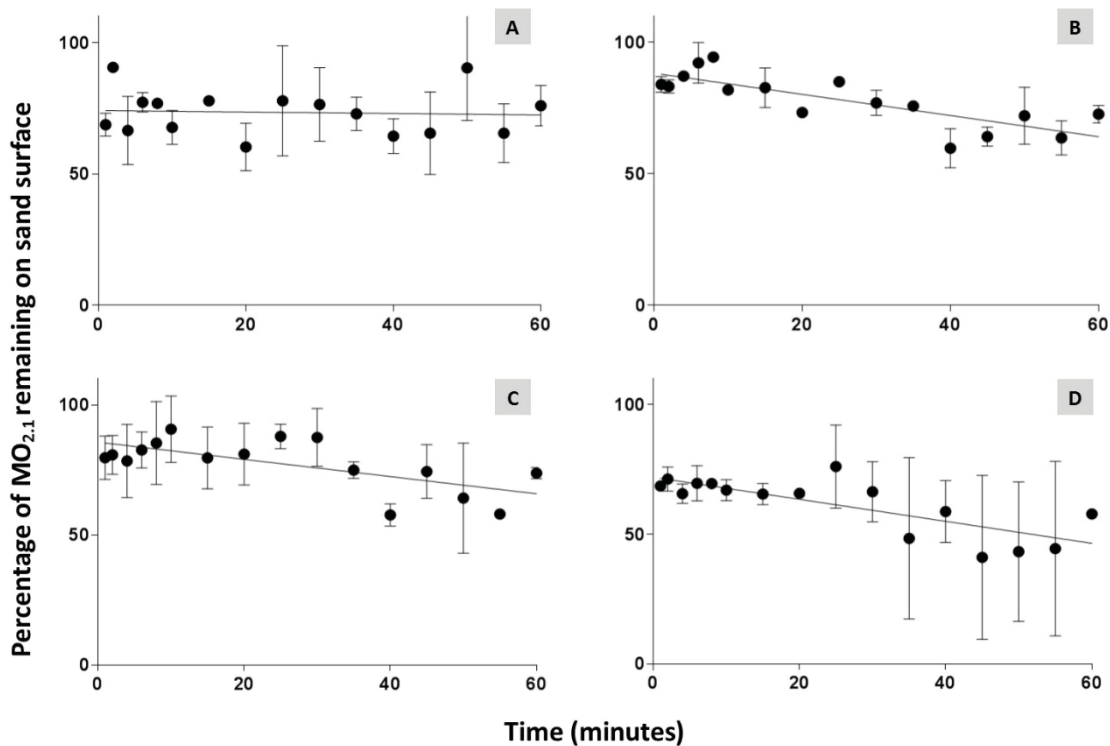
## RESULTS AND DISCUSSION

The attachment of *E. coli* to the *f*-sand surface was confirmed via elution and imaging (Figure 1). The inhibited *E. coli* is visible as fluorescent ovals across the sand surface and confirm the result that the bacteria is inhibited by the MO<sub>2.1</sub> as the dye used does not stain living cells.



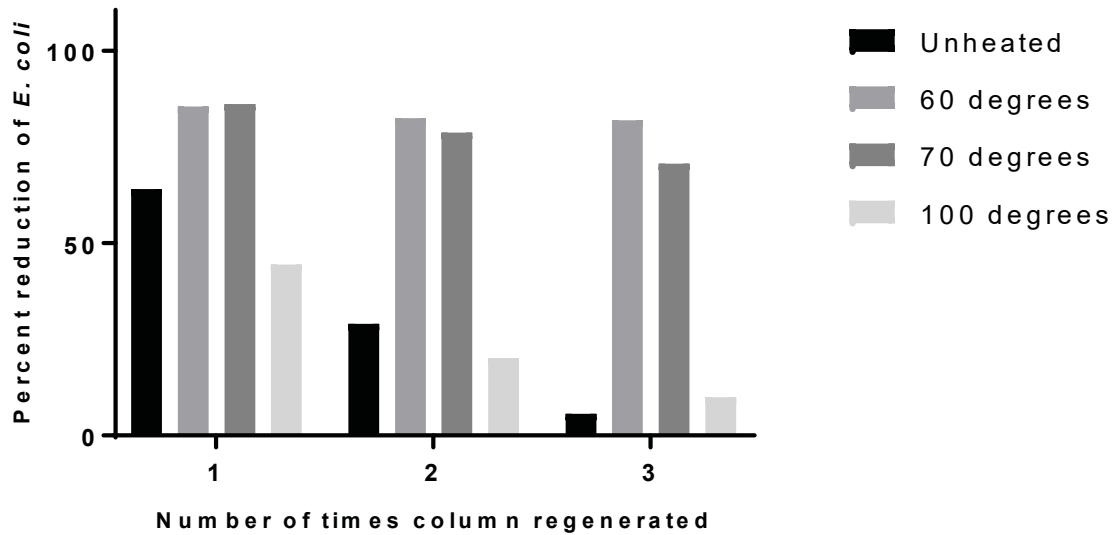
**Figure 1. Fluorescence image of *E. coli* on *f*-sand surface. Scale bar 100 $\mu$ m**

Heating the 1g samples affected all samples with immediate reduction in the amount of MO<sub>2.1</sub> attached to the sand surface (Figure 2). At 70°C and below, no further loss was recorded. At 80°C and 90°C there was consistent loss of polypeptide over the hour and at 100°C there was an immediate loss of MO<sub>2.1</sub> however, the amount lost after varied much more than the other temperatures tested.



**Figure 2. Effect of heat on *f*-sand. A: 70°C, B: 80°C, C: 90°C, D: 100°C**

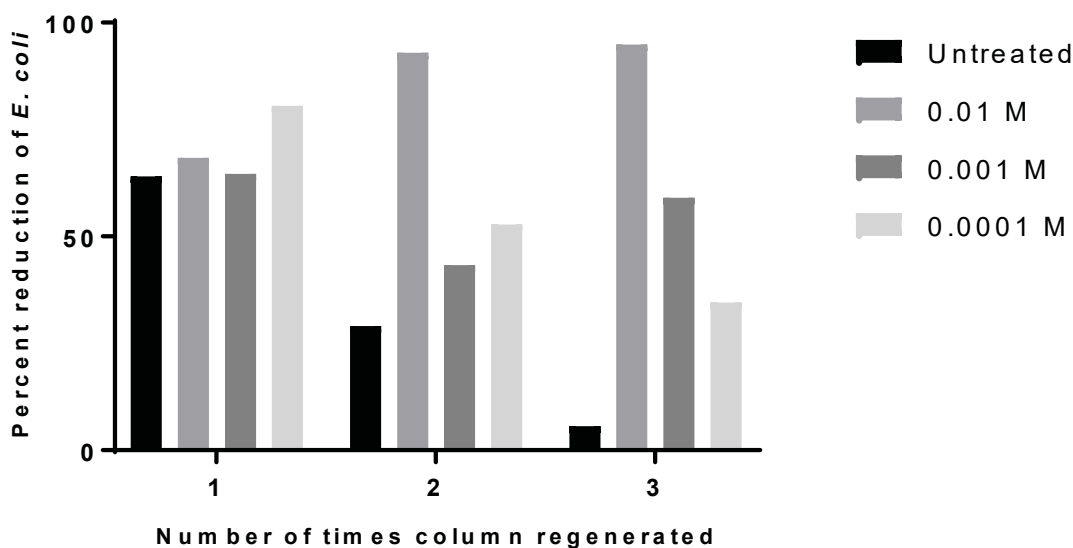
The efficacy of water heated to 60°C, 70°C and 100°C for removal of the inhibited *E. coli* was then tested in columns containing *f*-sand (Figure 3). Water heated to 60°C was effective at regenerating the column and allowed for repeated bacterial removal across the three treatments. At 70°C and above the *f*-sand column lost efficiency on each subsequent run with the greatest loss occurring at 100°C. The reduction in  $MO_{2.1}$  seen at the higher temperatures on the sand surface was expected to correlate to a reduction in column efficacy.



**Figure 3. Effect of heat on *f*-sand column regeneration.**

The use of *M. oleifera f*-sand is an emerging technology for water treatment. It has the scope to be used on both large and small scales and in rural and remote communities. The simplicity of the system removes the need for experienced operators, making it easier to disseminate into communities; especially in regions where *M. oleifera* seeds are already used in water treatment. Heating the column to 60°C regenerated the *f*-sand. This method would also remove non-inhibited *E. coli* caught in the column and depending on the length of time, also assist in inhibition (WHO 2015).

A second regeneration method involves washing the *f*-sand with the non-ionic surfactant dodecyl glucoside. The three concentrations of 0.0001 M, 0.001 M, and 0.01 M were compared against *f*-sand exposed to three runs of the *E. coli* without the dodecyl glucoside wash and are presented in Figure 4. Washing the *f*-sand with 0.01 M dodecyl glucoside increases the bacterial removal on subsequent washes whereas the lower concentrations either maintain (0.001 M) or was not effective at regenerating the *f*-sand (0.0001 M). The increased efficiency of the *f*-sand after exposure to the surfactant and is due to the surfactant removing excess biological material which caused a slight increase in *E. coli*. This increase was enough to impact the overall capacity of the *f*-sand to inhibit bacteria and may be overcome by exposing the *f*-sand to 0.01 M dodecyl glucoside before its initial treatment of the bacteria.



**Figure 4. Effect of surfactant on *f*-sand column regeneration.**

One of the uses of surfactants is to solubilise the lipid membrane of bacteria via integration of the surfactant into the membrane, extraction of the lipids and formation of micelles (le Maire *et al.* 2000). For dodecyl glucoside at concentrations of 0.01 M and below this occurs without affecting the attachment of the  $MO_{2-1}$  to the sand surface. Unexpectedly, the bacterial reduction in the *f*-sand columns was not standard for the first use and significant variability was observed. This presents a problem with the use of the *f*-sand as a primary treatment as it was not standard. One way to overcome this would be to pre-wash with the 0.01 M dodecyl glucoside even when subsequent washes would be heat-treated.

## CONCLUSIONS

This study demonstrates the capacity of *f*-sand for *E. coli* reduction, the behavior of *f*-sand in the presence of heated water, and the use of heated water and dodecyl glucoside to remove the *E. coli* post-inhibition. Further work is required to develop this technology into a water treatment system which could be used in non-ideal conditions. However, it is a significant step in the development of an alternative treatment method to combat bacterial contamination of water. One which promises an effective alternative for water treatment in regions where accessible, affordable water treatment is required.

## REFERENCES

- Aitken A. and Learmonth M. (1996). Protein determination by UV absorption. In: *The protein protocols handbook*, Springer, pp. 3-6.
- Barajas J. R. and Pagsuyoin S. (2017). Assessment of Moringa-functionalized carbon based biofilter for disinfection through column experiments. In: *2017 Systems and Information Engineering Design Symposium (SIEDS)*, pp. 5-9.
- Gamia M. T., Ribosa I., Campos E. and Sanchez Leal J. (1997). Ecological properties of alkylglucosides. *Chemosphere* **35**(3), 545-56.
- Ghebremichael K. A., Gunaratna K. R., Henriksson H., Brumer H. and Dalhammar G. (2005). A simple purification and activity assay of the coagulant protein from *Moringa oleifera* seed. *Water Research* **39**(11), 2338-44.
- UniProt <http://www.uniprot.org/> UniProt. In. (accessed 10/06/2017)
- Jahn S. A. A. and Dirar H. (1979). Studies on Natural-Water Coagulants in the Sudan, with

- Special Reference to *Moringa oleifera* Seeds. *Water Sa* **5**(2), 90-7.
- Jerri H. A., Adolfsen K. J., McCullough L. R., Velegol D. and Velegol S. B. (2012). Antimicrobial Sand via Adsorption of Cationic *Moringa oleifera* Protein. *Langmuir* **28**(4), 2262-8.
- le Maire M., Champeil P. and Møller J. V. (2000). Interaction of membrane proteins and lipids with solubilizing detergents. *Biochimica et Biophysica Acta (BBA) - Biomembranes* **1508**(1-2), 86-111.
- Shebek K., Schantz A. B., Sines I., Lauser K., Velegol S. and Kumar M. (2015). The flocculating cationic polypeptide from *Moringa oleifera* seeds damages bacterial cell membranes by causing membrane fusion. *Langmuir* **31**(15), 4496-502.
- Suarez M., Haenni M., Canarelli S., Fisch F., Chodanowski P., Servis C., Michielin O., Freitag R., Moreillon P. and Mermoud N. (2005). Structure-function characterization and optimization of a plant-derived antibacterial peptide. *Antimicrobial Agents and Chemotherapy* **49**(9), 3847-57.
- Williams F. L., Andrew; Orandi, Sanaz; Lewis, David M (Submitted). *Moringa oleifera* functional sand: reuse with non-ionic surfactant dodecyl glucoside.
- World Health Organization (WHO). (2015). Technical brief: Boil water. [http://www.who.int/water\\_sanitation\\_health/publications/boiling-water/en/](http://www.who.int/water_sanitation_health/publications/boiling-water/en/) (accessed 13/06/2017)

# An evaluation of small drinking water systems in a region of Brazil

Ref # S2SMALL- 43485

R. Debiase<sup>1</sup>, A.D. Benetti<sup>2\*</sup>

<sup>1</sup> Rio Grande do Sul State Regulatory Agency (AGERGS), Av. Borges de Medeiros, 659/13 - 90020-023 - Porto Alegre - RS – Brazil.

<sup>2</sup> Hydraulics Research Institute, Federal University of Rio Grande do Sul (IPH/UFRGS), Av. Bento Gonçalves, 9500 - 91501-970 - Porto Alegre - RS - Brazil

\* Presenting Author: benetti@iph.ufrgs.br

**Abstract:** Small systems are important suppliers of drinking water in rural areas and villages around the world. They are usually comprised of a pumping system and a simplified treatment followed by distribution. Small systems frequently have limitations with respect to personnel, maintenance and financial sustainability. For these reasons, some systems are vulnerable for the provision of safe drinking water. This study evaluated the vulnerability of small drinking water systems in a region of Brazil, the southern state of Rio Grande do Sul. The state has 6,276 small systems, each serving up to 2,000 inhabitants. Sixty systems from this universe were selected for on-site visits and water quality data examination from the surveillance database. Data were evaluated with respect to ten indicators within the dimensions water resources, institutional, social and economics. A vulnerability index was proposed to characterize the small systems as having high, intermediate or low vulnerabilities. The conclusion of the study was that 67 percent of the small systems in the state of Rio Grande do Sul had high or intermediate vulnerabilities. Lack of adequate water treatment was the main reason for the systems to be classified as vulnerable, although there were other contributing factors.

**Keywords:** community drinking water systems, small drinking water systems, small water supply systems, vulnerability index, vulnerability assessment.

## INTRODUCTION

Small drinking water systems plays an important role in the provision of drinking water for people in villages and rural areas. Small systems usually don't have the resources and infrastructure that are available to systems providing water to larger cities and might be more vulnerable to deficiencies that put the safety of drinking water at risk. For instance, in 2015, 1,838 small communities drinking water systems in Canada were under drinking water advisories due to failures in the treatment systems (Lui 2015). The topic is very relevant to Brazil, as there are 29 million people that are not supplied by piped drinking water (ABES, 2016). Also, in rural areas, only 28 per cent of the population are regularly supplied by water systems. In accordance with the importance of the subject, the World Health Organization published a guidance manual for developing water safety plans for small communities drinking water systems (WHO 2012).

In the State of Rio Grande do Sul (RS), Brazil, there are 6,276 systems, each providing drinking water to populations up to 2,000 inhabitants. These systems are usually less supervised and controlled by public regulatory agencies and are more prone to present problems with respect to water quality. However, no study was yet done to evaluate the extent of the problems. This article describes a study that was planned and performed to evaluate the vulnerability of the small drinking water systems in RS. For this purpose, 60 systems were chosen for on-site inspections. The systems were evaluated according to ten indicators that were classified into four dimensions.



## MATERIALS AND METHODS

Each indicator was graded according to a scale that ranged from zero (more vulnerable) to one (less vulnerable). Table 1 presents the four dimensions and the ten indicators that were used to assess the small water systems.

**Table 1.** Dimensions, vulnerability indicators and definitions

Dimension	Indicator	Definition
Water resources	Water resources availability	Occurrence of events such as droughts and floods that affects the continuity of the water supply.
	Water source	Type of water source used for supply.
	Level of treatment	Adequacy of the treatment technology to the source water quality.
	Drinking water quality	Water quality characteristics.
	Operations & maintenance	O&M conditions of the water supply system infrastructure.
Economic	Water distribution network	Occurrence of problems in the water distribution network.
	Economic sustainability	Economic sustainability for the system O&M and investments.
Social	Technical capacity	Technical capacity of the system personnel.
Institutional	External support	Support from health agencies, local government, and/or non-governmental organizations.
	Surveillance and control: water quality monitoring	Surveillance and control monitoring of the drinking water quality in compliance with health regulations.

The proposed vulnerability index (VI) was the weighted average of the indicators ratings by dimension (Equation 1).

$$VI = \sum \frac{I_k \cdot W_k}{n_k} \quad (1)$$

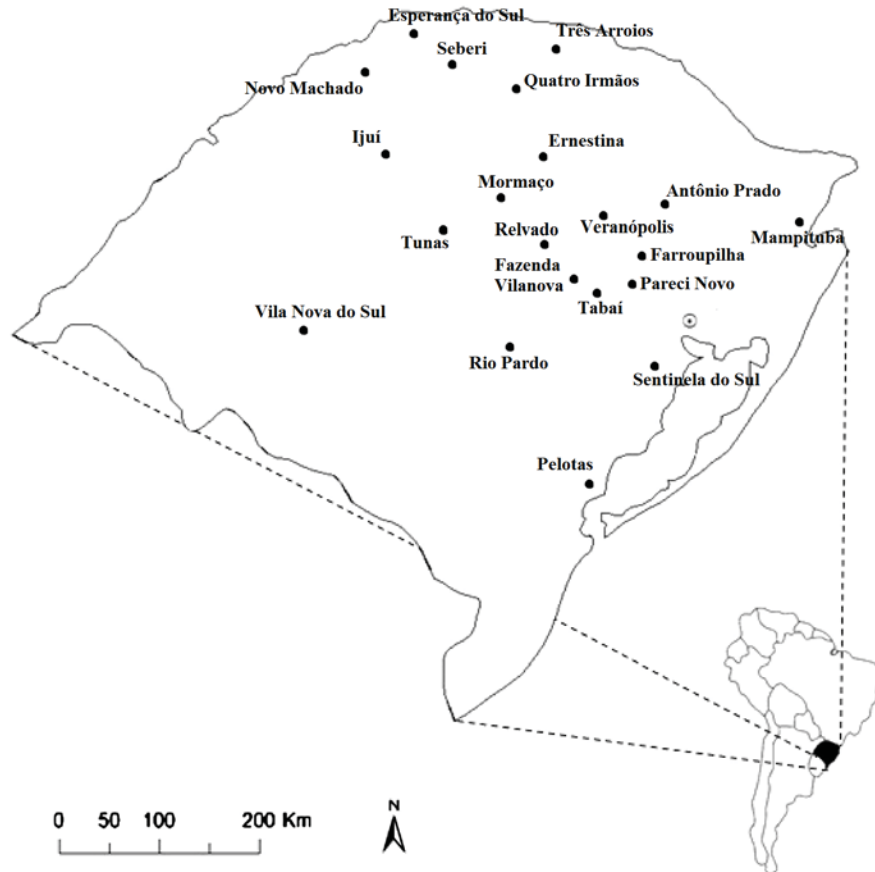
Where:  $I_k$  is the sum of ratings associated to the vulnerability indicators in the dimension  $k$ ;  $W_k$  is the weight assigned to the dimension  $k$  ( $\sum W_k = 1$ );  $n_k$  is the number of indicators analyzed in the dimension  $k$ . The drinking water systems were classified as having low ( $0.65 < VI \leq 1.00$ ), intermediate ( $0.40 \leq VI \leq 0.65$ ) or high ( $0.00 \leq VI < 0.40$ ) vulnerabilities.

The 60 systems selected for on-site inspection were chosen using probabilistic sampling design in order to represent the universe of drinking water systems in RS. The details of the sampling procedure are described in Debiase & Benetti (2017). The area of RS was divided into five regions, and each region had at least six small systems selected for on-site visits. Figure 1 shows the location of the state of RS with respect to Brazil and South America, as well as the municipalities with small systems selected. Besides the visits, the Brazilian Drinking Water Quality System database was consulted for water quality information (SISAGUA 2015).

For each region, the mean vulnerability was calculated using Equation 2. It represented the weighted average of the individual vulnerability indexes.

$$\overline{VI} = \frac{\sum_{j=1} w_j \cdot VI_j}{\sum_{j=1} w_j} \quad (2)$$

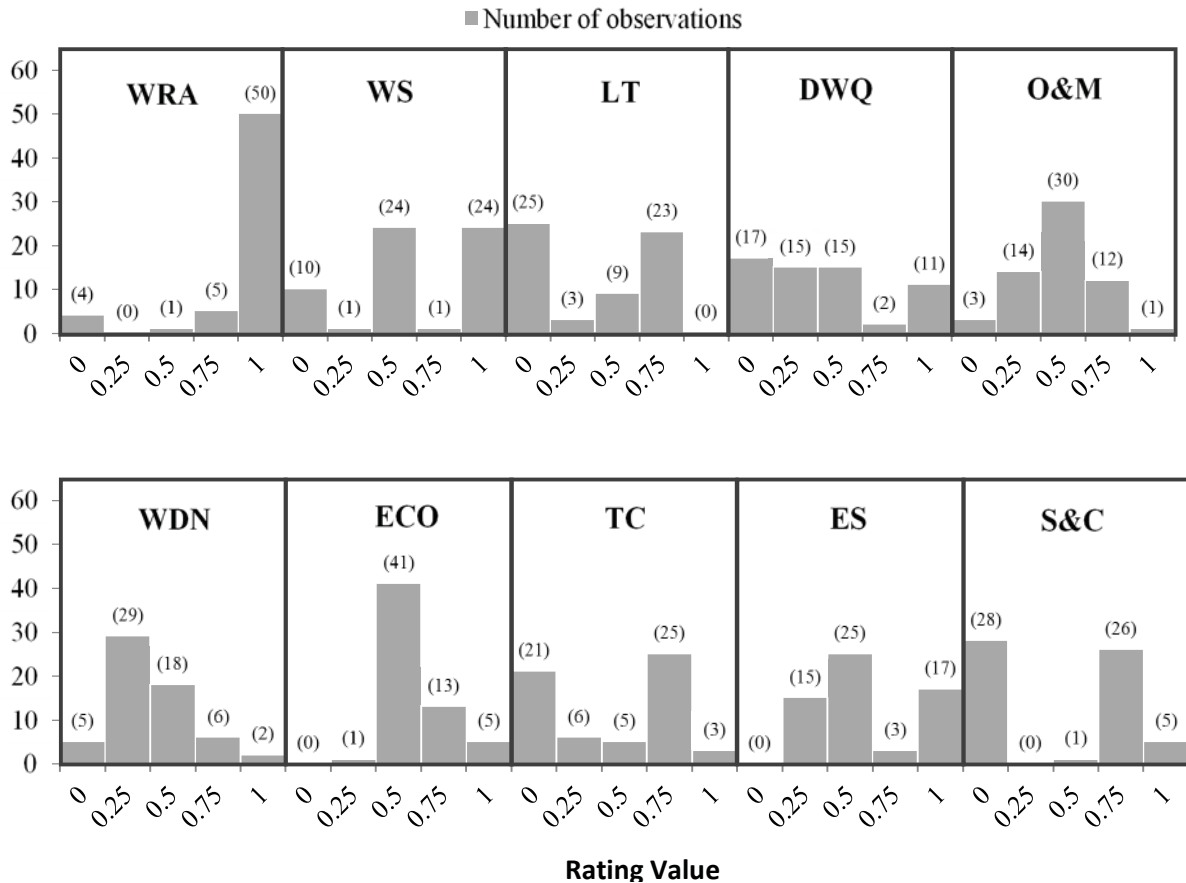
Where:  $\overline{VI}$  is the mean vulnerability index of the surveyed systems;  $w_j$  is the sample weight of unit  $j$ ; and  $VI_j$  is the vulnerability index value of the sampled unit  $j$ .



**Figure 1.** Location of the state of RS in Brazil and South America, and the municipalities which had small drinking water supply systems selected for on-site visits.

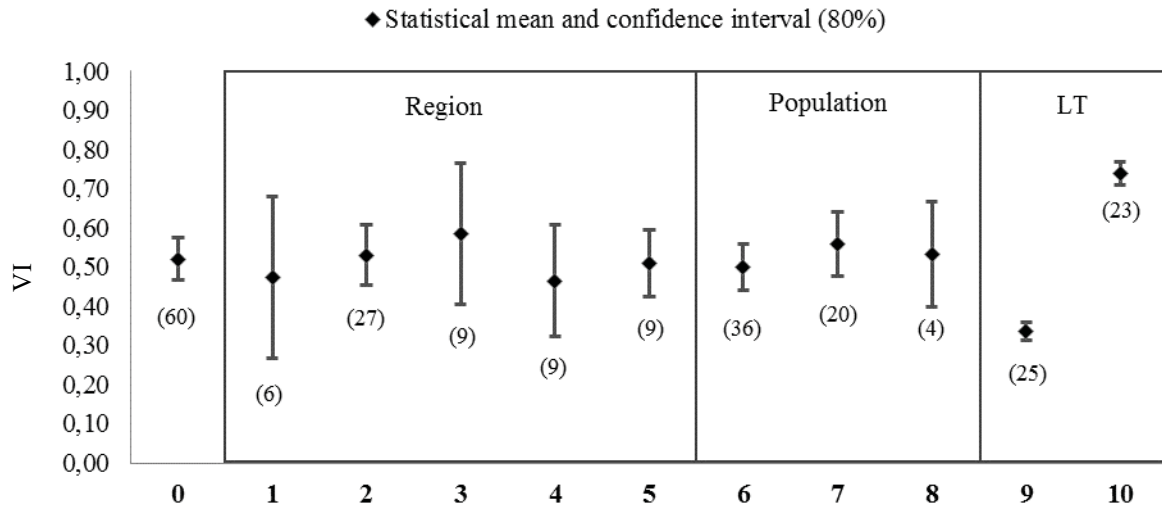
## RESULTS AND DISCUSSION

Figure 2 presents, for each of the ten indicators, the number of systems classified in accordance with the rating scale proposed. Water resources availability (WRA) was not a problem in 55 of the 60 systems evaluated (values 0.75 and 1.0 in the scale). With respect to water source (WS), 24 systems used protected artesian wells (value 1,0) while 10 used unprotected surface or phreatic wells (value 0.0). The level of water treatment (LT) was considered adequate in 23 of the 60 systems. In only 13 of the 60 systems, the quality of the drinking water (DWQ) was classified as good or excellent (values 0.75 and 1.0). Thirteen systems had O&M considered sufficient and adequate. Problems in the water distribution networks (WDN) were high, as 34 out of the 60 systems were in the lowest scale (0.25 and 0.0). Only 18 of the 60 systems had economic sustainability (ECO) in a way that would allow investments in the systems' upgrade. With respect to technical capacity (TC), operators in 28 systems were proficient in operation. Twenty systems had external support (ES) considered to be sufficient. Surveillance and control (S&C), which encompasses monitoring, either complied with official regulations (values 0.75 and 1.0) or were inexistent (value 0.0).



**Figure 2.** Number of observations in the rating scale (0 to 1) for the indicators WRA (water resources availability), WS (water source), LT (level of treatment), DWQ (drinking water quality), O&M (operations & maintenance), WDN (water distribution network), ECO (economic sustainability), TS (technical capacity), ES (external support), S&C (surveillance and control: water quality monitoring).

In Figure 3, it is presented the mean vulnerability index  $\overline{VI}$  for the state of RS (number 0) and for each of the five regions into which the state was divided (numbers 1 to 5). The mean vulnerability index in the state of Rio Grande do Sul was 0.52 with a confidence interval of 0.47 and 0.58 for 80% significance. In the five regions, the mean vulnerabilities ranged from 0.47 to 0.58. The  $\overline{VI}$  indicated an overall vulnerability at intermediate level. The analysis also considered when the systems were divided according to the number of population served by the water system (number 6 to 8 in Figure 2). There weren't significant differences in the vulnerability indexes for systems serving less than a 100, between 100 and 500 and 500 to 2,000 people. When vulnerability is associated to the level of treatment, it was observed that systems that have an adequate water treatment (number 10) are much less vulnerable than systems that don't provide proper treatment (number 9).



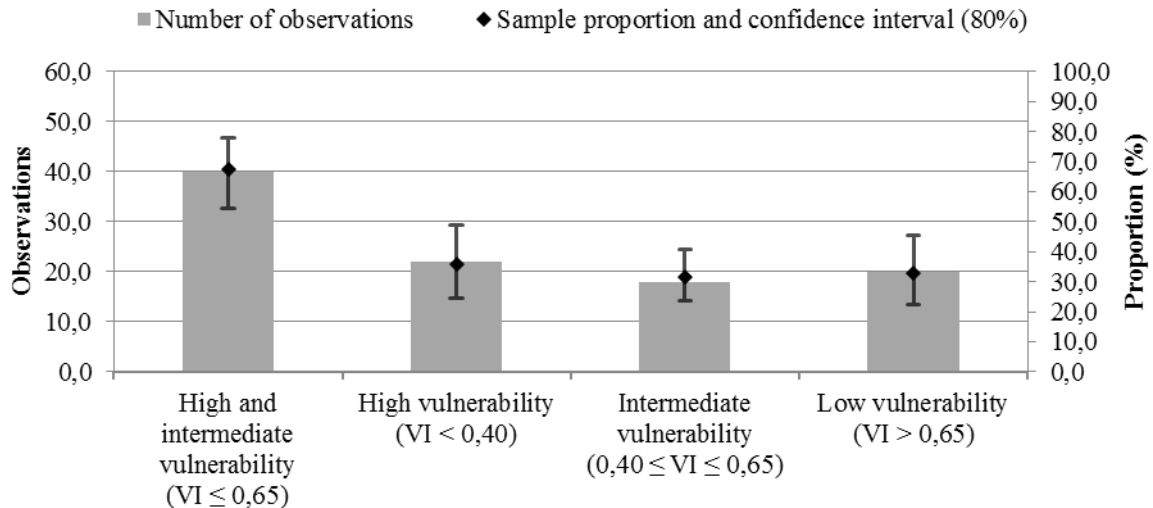
**Figure 3.** Water supply systems mean vulnerability index (*VI*) and confidence intervals for the state of Rio Grande do Sul (0), Region (1. Central West, Southeast and Southwest, 2. Northwest, 3. Metropolitan, 4. Center East, 5. Northeast); Population (6. Less than 100, 7. Between 100 and 500, 8. Between 501 and 2000); Level of Treatment (9. None, 10. Proper treatment technology). The number below the lines indicates the sample size in each subpopulation.

Another approach to analyze the data was in terms of the proportion of systems that were classified in each of the vulnerability levels, i.e., low, intermediate and high, as shown in Figure 4. It can be seen that the largest proportion of systems (almost 40 percent) were classified as having high vulnerability, while only one-third of the systems had low vulnerability. About 67% of the small drinking water systems had either high or intermediate vulnerability.

Results shown in Figures 2 to 4 indicate that a significant number of small community drinking water systems in the state of Rio Grande do Sul are at risk of providing water that is not safe for drinking. It is estimated that between 3,428 and 4,880 of the 6,276 systems that serve less than 2,000 people have either high or intermediate levels of vulnerability for 80% significance. In most of the systems at risk, inadequate water treatment was the main cause of vulnerability. In terms of population at risk, it is estimated that between 300 and 470 thousand people are having drinking water coming from vulnerable systems.

## CONCLUSIONS

In the study of the small drinking water systems in the state of RS, Brazil, it was shown that about 67 percent of the systems had either high or intermediate levels of vulnerability, therefore at risk of distributing water that is not safe for drinking. This conclusion is important because there are thousands of people that rely on these sources for drinking water. The inadequate treatment of the water was the main cause of vulnerability among the systems. On the other hand, a proper water treatment, an efficient management, the presence of qualified operators, the good maintenance of the physical structure, the charging of a fair fee, and the availability of external support were factors that fostered low vulnerability.



**Figure 4.** Proportion of systems in the high, intermediate and low vulnerability levels according to the Vulnerability Index (VI) values.

Information provided by this study can be used to plan policies and actions that aim to reduce the vulnerability of small drinking water systems and, consequently, the acquisition of diseases associated with contaminated water. It would also be valuable for setting priorities. For instance, it was observed that the lack of proper water treatment was the main reason for vulnerability in systems.

## REFERENCES

- ABES (Associação Brasileira de Engenharia Sanitária e Ambiental) 2016 *Situação do Saneamento Básico no Brasil. Uma Análise com Base no PNDA 2015. (Report on the Sanitary Infrastructure in Brazil)*. ABES, Rio de Janeiro. <http://abes-dn.org.br/?p=7010> (accessed between December 2016 and January 2017)
- Debiase R. & Benetti, A. D. 2017 Assessing the vulnerability of small community drinking water systems. Submitted to *Water Science and Technology: Water Supply*
- Lui E. 2015 *On Notice for a Drinking Water Crisis in Canada*. The Council of Canadians, Ottawa.
- SISAGUA. Brasil. Ministério da Saúde 2015 *Sistema de Informação de Vigilância da Qualidade da Água para Consumo Humano (Drinking Water Quality System Information)*. DATASUS, Brasília. <http://sisagua.saude.gov.br/sisagua> (accessed between March 2015 and May 2015).
- WHO (World Health Organization). 2012 *Water Safety Planning for Small Community Water Supplies: Step-by-Step Risk Management Guidance for Drinking-Water Supplies in Small Communities*. World Health Organization, Geneva.

# The Defluoridation Mechanism of Hydroxyapatite/Attapulgit Composite Beads

Ref # S2SMALL-93650

Ma Zilong, Feng Li \*, Chen Zhenzhen, Liu Zeshan

Key Laboratory of Coal Processing and Efficient Utilization of Ministry of Education, School of Chemical Engineering and Technology; National Engineering Research Center of Coal Preparation and Purification, China University of Mining and Technology, 221116, Xuzhou, P.R.China

\* Presenting Author: Feng Li: cumthgfl@163.com

**Abstract:** Hydroxyapatite/ attapulgit composite beads (HAP/ATT) were made through mixing hydroxyapatite and attapulgit at certain ratio and spheroidizing. Hydroxyapatite was synthesized by wet chemical methods at different calcium phosphorous ratio, and the product with the highest defluoridation capacity was selected as material of ball. The spheroidization process hasn't changed the structure and properties of hydroxyapatite characterized by FTIR and XRD. The adsorption process of HAP/ATT is influenced by adsorption time, temperature and pH value. The adsorption approaches to equilibrium within 80mins. High temperature is conducive to the adsorption process. The pH value does not effect the defluoridation process of drinking water system when the pH value is between 5 and 9. The defluoridation mechanism was researched by adsorption thermodynamics and characterization analysis of zeta potential changes, FTIR and XPS. The adsorption process is close to the monolayer adsorption. HAP undertake the main defluoridation role in HAP/ATT composite beads. The defluoridation mechanism includes physical adsorption and ion exchange reaction in normal water of pH=6-8. The defluoridation process is a spontaneous endothermic process ( $\Delta H^\theta > 0$ ,  $\Delta G^\theta < 0$ ).

**Keywords:** hydroxyapatite/ attapulgit composite beads; defluoridation mechanism; hydroxyapatite; adsorption performance

## INTRODUCTION

Drinking water is the major contributor of fluoride in the human body, accounting for 75–90% of daily intake. (Feng L et al., 2012). In general, a small amount of fluoride in drinking water is conducive to the teeth and bone development. Excess fluorine content in water can damage tooth enamel, affect the growth of bone. High fluoride in drinking water can cause dental fluorosis, skeletal deformation, even skeletal fluorosis (Fan X et al., 2003; Sairam S C et al., 2009). According to the standard made by the World Health Organization, the fluorine content in drinking water can not exceed 1.5mg/L.

At present, fluoride removal methods include physical adsorption, coagulation sedimentation method, electro dialysis, reverse osmosis (Jadhav S. V. et al., 2015; Singh J. et al., 2016; Bhatnagar A., et al., 2011; Mohapatra M. et al., 2009). Wherein the coagulation sedimentation method is relatively simple, but the process will bring other ions and make the water taste bad. The electro dialysis method consumes a lot of power and removal of some beneficial mineral ions. The reverse osmosis is a kind of advanced membrane separation technology, which is a physical process, but the membrane is too expensive to use widely, and the large wastewater produced is also a big problem.

The absorption method is the most commonly used method for fluoride removal from drinking water compared with other methods. It is easy to operate, more convenient and practical, but the defluoridation capacity is low. The general adsorbents include activated carbon, activated alumina (Yin Guoxun, 2007; Qiu van Loosdrecht M C M., 2002; Zhang



Yan, 2005), bone charcoal (King, 2008; Wang Yong, 2003), hydroxyapatite (Ying Bo, 2001; Wang Ping, 2009; Liu Haibo et al., 2001) or other low cost materials.

Hydroxyapatite (HAP;  $\text{Ca}_{10}(\text{PO}_4)_6(\text{OH})_2$ ) has been found to be a better sorbent because of its low cost, ready availability and higher defluoridation capacity. In order to further improve the defluoridation capacity of HAP, the research of nano-HAP (Prabhu S. M. et al., 2016; Gao S. et al., 2009; Poinern G. E. J. et al., 2011; He J. Y. et al., 2016) and doping modification (He J., et al., 2016; Chen L. et al., 2016; Gong L. Y. et al., 2015) are also a trend that draws the academic attention. The large surface area of nano-material makes it possible to improve its defluoridation capacity, but since the nano-particles are too small to be intercepted easily, potential threats exist for real that these nano-particles would enter human bodies via drinking water. Doping modified filter materials are also mostly used in powder form. Filter materials in powder form cannot be used either in fixed bed columns or in any other flow-through system because it would cause excessive pressure drop during filtration (Liu H B et al., 2007).

To overcome this limitation, we studied the preparation, structure and adsorption properties of hydroxyapatite/attapulgite (HAP/ATT) composite beads as a possible alternative method so as to use fully their hardness, high defluoridation capacity and regeneration performance, and improve the practical application.

ATT is a fiber-like hydrated magnesium aluminum silicate clay mineral, which has good plasticity and strong bonding ability. In composite beads, ATT acts mainly as a bonding agent for granulation of ceramic powdered HAP. HAP cannot be formed into beads itself without ATT. Of course, the defluoridation capacity of the composite beads decreases with increasing amounts of added ATT. Interestingly, the exhausted composite beads can be regenerated many times through heating. The total defluoridation capacity and effective utilization efficiency of these composite beads are both greatly improved after regeneration.

HAP/ATT composite beads have been used in many water treatment plants and have successful application effects. For example, the fluorine content in drinking water decreased from 11 mg/L to 0.2-0.5 mg/L treated by three-stage series system of HAP/ATT composite beads in Muke spring water treatment plant in Xiuyan county, Anshan city, Lianning Province, China. But the defluoridation mechanism of HAP/ATT composite beads is not clear.

A novel filter material, hydroxyapatite/attapulgite (HAP/ATT) composite beads is reported here. The preparation, structure and adsorption properties are discussed. A possible mechanism is also investigated by zeta potential changes, FTIR, X-ray photoelectron spectroscopy (XPS).

## **MATERIALS AND METHODS**

### **1. Preparation of HAP/ATT Composite Beads**

HAP was synthesized by wet chemical methods at different calcium phosphorous ratio. The ratio of Ca/ P ratio were 2.3, 2.04, 1.92, 1.84, 1.67, 1.6, 1.55, and 1.5 respectively. The product with high properties chose by structure and defluoridation capacity was mixed with attapulgite at a certain proportion and sintered under 350°C.

### **2. Structural Characterization**

The surface functional groups of HAP/ATT composite beads were characterized by FTIR (Nicolet-380, Scientific Instruments department) and XRD (D/Max-3B, Japan Science Co. (Rigaku)). The bonding way of fluoride ions with hydroxyl apatite particles was studied by means of XPS (ESCALab250, Thermo Scientific Corporation).

### 3. Adsorption Experiment

The fluoride concentration in stock standard solution prepared was 100mg/l. The stock standard solution was diluted to 5mg/L when doing the adsorption experiment. The HAP/ATT composite beads (particle size: 0.5 to 1mm) of 0.1g was immersed into 150mL fluoride solution for a different time at certain conditions in a thermostat shaker, then the fluoride concentration in the solution is tested by ion chromatography. The effect of solution pH value (2.0-11.0) on defluoridation capacity was studied by adjusting solution pH value using 1 M HCl or 1M NaOH. The effect of temperature was studied from 15°C to 75°C, the interval is 10°C. Adsorption isotherms, adsorption thermodynamics and adsorption kinetics were obtained by batch experiments. Defluoridation capacity (DC (mg/g)) was calculated using the following relationship:

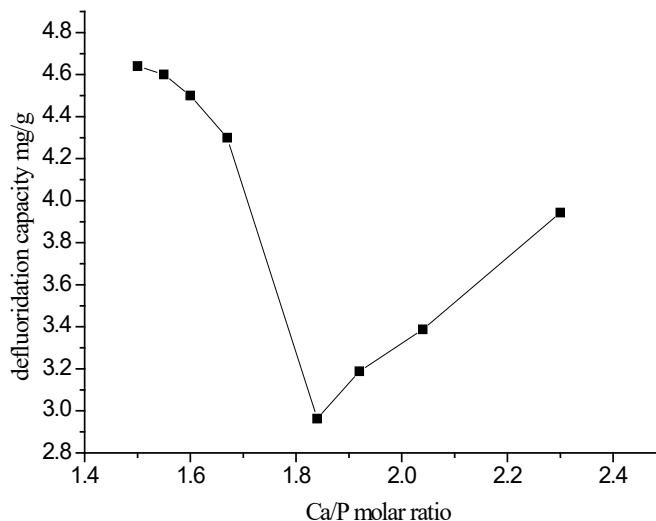
$$DC = \frac{C_0 - C}{m} \times V \quad (1)$$

Where  $C_0$  is the initial concentration of fluoride ions (mg/L);  $C$  is the residual concentration of fluoride ions after adsorption (mg/L);  $V$  is the volume of the solution (L);  $m$  is the quality of beads (g).

## RESULTS AND DISCUSSION

### 1. Preparation of HAP/ATT Composite Beads

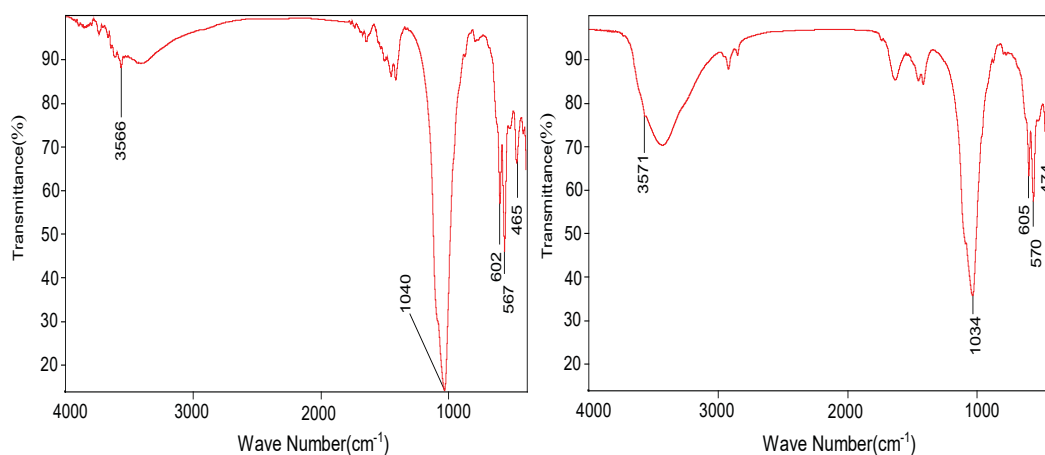
Fig.1 shows the defluoridation capacity of the products which were synthesized under different Ca/P molar ratio. The result shows that the defluoridation capacity decreases with the declining of the Ca/P molar ratio and to the lowest when the Ca/P molar ratio is 1.84, then increases gradually. When the Ca/P molar ratio is from 1.50 to 1.55, the defluoridation capacity varies from 4.64mg/g.to 4.6mg/g, the change is not obvious. So the Ca/P molar ratio of 1.5 is an optimizing value chose in the actual manufacture. Then the HAP powder was mixed with attapulgite at certain ratio in a balling machine. Finally, the particles obtained were sintered under 350°C.



**Fig. 1** Influence of different Ca/P molar ratio on DC

### 2. Characterization of HAP and HAP/ATT Composite Beads

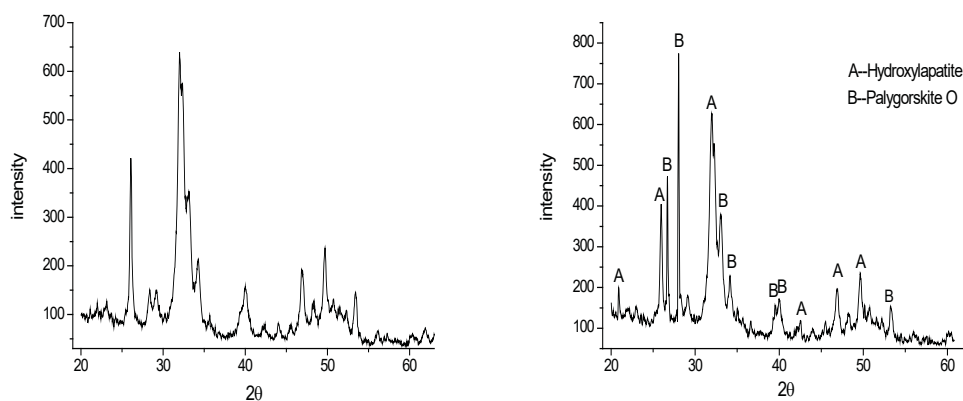
Fig.2 shows nearly the same HAP characteristic FTIR peaks, i.e., O-H stretching vibration at near  $3566\text{ cm}^{-1}$  and a strong band of  $\text{PO}_4^{3-}$  group peaks at near  $1040\text{ cm}^{-1}$ ,  $602\text{ cm}^{-1}$  and  $567\text{ cm}^{-1}$ . It indicates that the preparation process of HAP/ATT composite beads is only a physical mixture and hasn't affected the structure of HAP.



**Fig.2a** FTIR spectra of HAP powder

**Fig.2b** FTIR spectra of HAP/ATT composite beads

XRD patterns of HAP powder and HAP/ATT composite beads are shown in Fig.3. As shown in Fig.3a, the peaks at  $2\theta=26^\circ$ ,  $32^\circ$ ,  $33^\circ$ ,  $40^\circ$  are correspond to the characteristic diffraction peaks of HAP, so the main component of the product is HAP (Sairam S C et al., 2008). Fig.3b shows that the main components of HAP/ATT composite beads are HAP and attapulgite. It indicates that the structure of HAP has not changed during the preparation process of HAP/ATT composite beads.

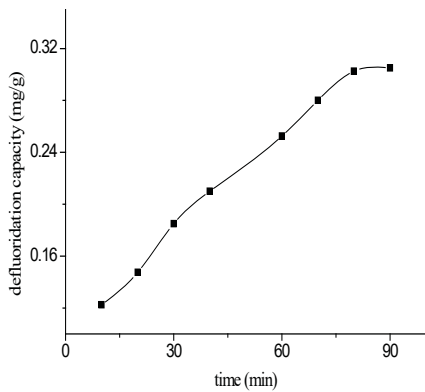


**Fig.3a** XRD pattern of HAP powder

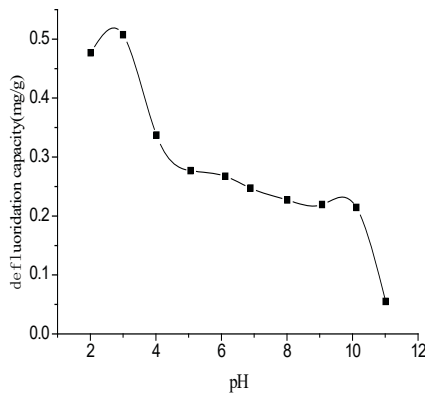
**Fig.3b** XRD pattern of HAP/ATT composite beads

### 3. Effect Factors of the Adsorption Process

Fig.4 shows that defluoridation capacity increased gradually along with the time increase when the adsorption time is less than 80 min. The adsorption process takes about 90min to reach the equilibration, which indicates that the adsorption process is relatively slow. This is because the particle's surface area decreases compared with HAP powder, so the contact time between fluorine ion and particles decreases and the adsorption time becomes longer.

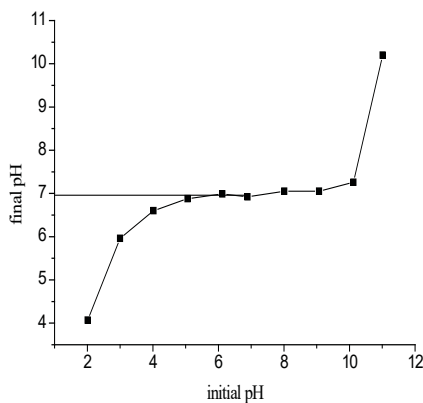


**Fig.4** Effect of sorption time on DC

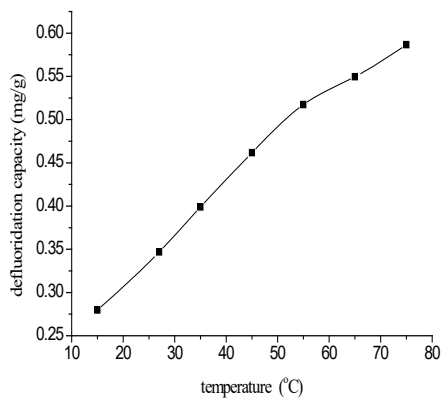


**Fig.5** Effect of pH value on DC

Fig.5 shows the effect of pH value on defluoridation process. The defluoridation capacity decreases gradually along with the rise of pH value. The defluoridation capacity reaches a maximum when the pH value is 3. Under acidic condition, HAP/ATT surface with positive charge is conducive to the adsorption of  $F^-$ . The defluoridation capacity changes a little and when the pH value between 5 and 9. Fig.6 also shows that the pH value changes little before and after adsorption between pH 5 and pH 9. This is very important because the pH value of almost all drinking water system is between 5 and 9. That is mean the effect of the pH value is none on the defluoridation process of drinking water system. When the pH value rises to 11, the defluoridation capacity is only 0.055mg/g. HAP/ATT surface with negative charge is not conducive to the adsorption of  $F^-$ . The competitive adsorption between  $OH^-$  and  $F^-$  will happen.



**Fig.6** The change of pH value before and after adsorption



**Fig.7** Effect of temperature on DC

Fig.7 shows the effect of temperature on defluoridation capacity. The defluoridation capacity increases with the increase of temperature, it indicates that the adsorption process is endothermic and high temperature is beneficial to adsorption process.

#### 4. Regeneration of HAP/ATT Composite Beads

HAP/ATT composite beads easily realized regeneration using boiling water. The defluoridation capacity after regenerated 10 times is listed in table 1. Though the exhausted beads were regenerated 10 times, the value of every DC varied around 0.300mg/g, which indicated that the exhausted beads have been recovered with the same adsorption properties as the new beads, and the surface of beads has the same amount of active sites for adsorbing

fluoride after a sufficiently long period of time for regeneration and adsorption 3.270mg/g of the total DC approaches the DC of HAP powder (3.46mg/g).

**Table 1.** Results of heat regeneration using boiling water

Regeneration times	0	1	2	3	4	5	6	7	8	9	10	total
DC (mg/g)	0.284	0.293	0.293	0.247	0.300	0.354	0.281	0.310	0.310	0.320	0.271	3.263

#### 4 Adsorption Isotherm

Adsorption isotherms describe the adsorption equilibrium of a material at a surface boundary at constant temperature. Langmuir adsorption isotherm and Freundlich isotherm (Yue Wenwen, 2006; Zhang Xiaoxuan, 2007) were applied to test the fitness of experimental data.

Linear formula of Langmuir adsorption is represented as:

$$\frac{C_e}{q_e} = \frac{C_e}{q_0} + \frac{1}{q_0 b} \quad (2)$$

Where  $q_e$  is the equilibrium adsorption value of the sorbent (mg/g),  $C_e$  is the equilibrium fluorine concentration (mg/L),  $q_0$  is the maximum adsorption capacity of the adsorbent (mg/g),  $b$  is adsorption constant.

Linear formula of Freundlich adsorption isotherm is as follows:

$$\log q_e = \frac{1}{n} \log C_e + \log k_F \quad (3)$$

Where  $q_e$  is the equilibrium adsorption value of the sorbent (mg/g);  $C_e$  is the equilibrium fluorine concentration (mg/L);  $k_F$ ,  $1/n$  are constants.

**Table 2.** Adsorption isotherm parameters

isotherm	parameter	283K	293K	303K
Langmuir	b	0.327	0.186	0.260
	$q_0$	0.372	0.644	0.791
	$R^2$	0.978	0.987	0.990
Freundlich	$k_F$	0.006	0.005	0.020
	n	2.308	1.487	1.878
	$R^2$	0.893	0.973	0.977

The values of adsorption isotherm parameters results are listed in Table 2. The adsorption behavior of fluorine fits the Langmuir isotherm and Freundlich isotherm well. There is not only monolayer adsorption process but also chemical adsorption process existing in adsorption process.

## 5 Adsorption Thermodynamics

Thermodynamic parameters associated with the adsorption, namely standard free energy change ( $\Delta G^\theta / \text{kJ} \cdot \text{mol}^{-1}$ ), standard enthalpy change ( $\Delta H^\theta / \text{kJ} \cdot \text{mol}^{-1}$ ) and standard entropy change ( $\Delta S^\theta / \text{J} \cdot \text{mol}^{-1} \cdot \text{K}^{-1}$ ), were calculated from the variation of thermodynamic distribution coefficient  $K$  with changes of temperature (Eq. (4),(5)). The values of  $K^\theta$  can be calculated by plotting  $C_e$  vs.  $\ln q_e/C_e$  and extrapolating  $C_e$  to zero (Khan A et al., 1987).

$$\Delta G^\theta = -RT \ln K^\theta \quad (4)$$

$$\ln K^\theta = -\frac{\Delta H^\theta}{RT} + \frac{\Delta S^\theta}{R} \quad (5)$$

Where  $T$  is the Kelvin temperature (K);  $R$  is the universal gas constant ( $8.314 \text{ J} / (\text{mol} \cdot \text{K})$ );  $K^\theta$  is thermodynamic equilibrium constant (L/g).

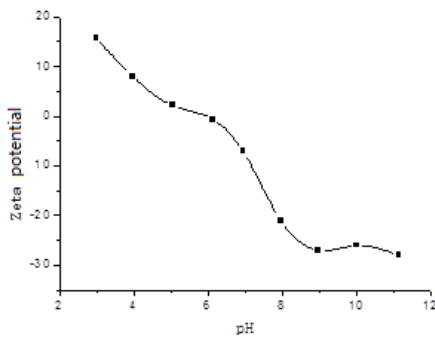
**Table 3.** Thermodynamic parameters of adsorption

T (K)	$\Delta G^\theta$ (KJ/mol)	$\Delta S^\theta$ (KJ/ (mol.K) )	$\Delta H^\theta$ (KJ/mol)
299	-3.90		
308	-4.28	0.0292	4.77
318	-4.55		

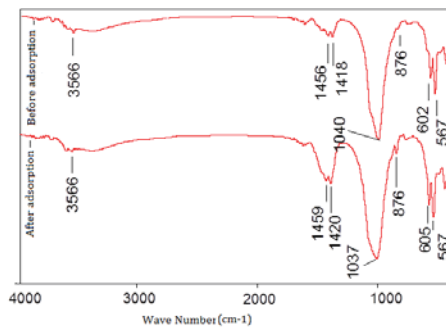
As the table 3 shown, the value of  $\Delta G^\theta$  of HAP/ATT composite beads in adsorption process is less than zero, so the adsorption process is spontaneous. The value of  $\Delta S^\theta$  is more than zero, it shows the increasing randomness at the solid/liquid interface during sorption of fluoride. It also indicates that the adsorption sites of fluorine ions are randomly distributed throughout the beads surface (Alagumuthu G et al., 2010). The positive value of  $\Delta H^\theta$  shows that the adsorption process is endothermic process.

## 6 Defluoridation Mechanism

Fig.8 shows Zeta potential changes of the surface of HAP/ATT composite beads at different pH value. The surface of HAP/ATT composite beads charges positive charge when the pH value is lower than 5, which is conducive to the electrostatic adsorption of  $\text{F}^-$ . The surface charges negative charge when the pH value is larger than 5, which is not conducive to the electrostatic adsorption of  $\text{F}^-$ . The pH zero point charge is 5.



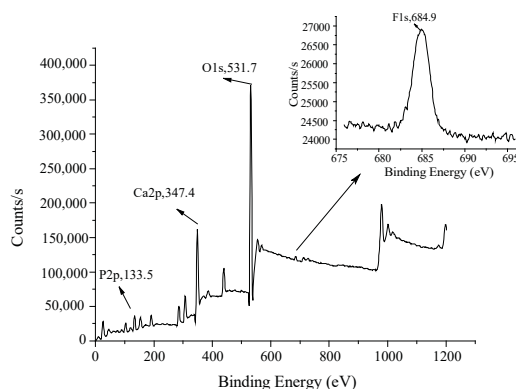
**Fig. 8** Zeta potential changes at different pH



**Fig. 9** FTIR spectrum before and after defluoridation



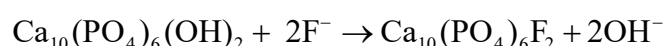
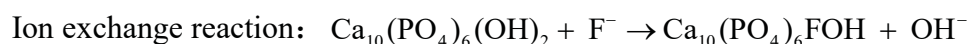
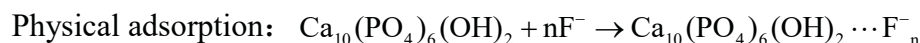
Fig.9 shows FTIR spectrum of HAP/ATT composite beads before and after defluorination. O-H stretching vibration at near  $3566\text{ cm}^{-1}$  and a strong band of  $\text{PO}_4^{3-}$  group peaks at near  $1040\text{ cm}^{-1}$ ,  $602\text{ cm}^{-1}$  and  $567\text{ cm}^{-1}$  have not changed obviously, but the vibration peak of  $\text{O-H}\cdots\text{F}$  at  $876\text{ cm}^{-1}$  appears after filter material adsorbing  $\text{F}^{-1}$ .



**Fig. 10** XPS spectra of the HAP/ATT powder after defluorination

Fig.10 illustrates the XPS spectra of the HAP/ATT powder after defluorination. The binding energy of F1s is about 685 eV which represented the presence of  $\text{F}^{-}$  ( $\text{M-F}$ , namely chemical bond combination). This confirmed that the defluorination process of HAP/ATT composite beads is a chemical process, not only a simple physisorption process.

In conclusion, HAP undertake the main defluorination role in HAP/ATT composite beads. The mechanism includes physical adsorption and ion exchange reaction in normal water of  $\text{pH}=6-8$ .



## CONCLUSIONS

(1) In the HAP synthesis process, the optimized Ca/P molar ratio is range from 1.5 to 1.6, and the defluorination capacity of HAP is highest.

(2) In adsorption process, adsorption time, temperature and pH value are main effect factors for the defluorination capacity of HAP/ATT composite beads. The adsorption approaches to equilibrium within 80mins, defluorination capacity increases with the increase of temperature and the pH value does not effect the defluorination process of drinking water system when the pH value is between 5 and 9.

(3) The adsorption behavior of fluorine fits the Langmiur isotherm and Freundlich isotherm well. The adsorption process is a monolayer adsorption reaction. HAP undertake the main defluorination role in HAP/ATT composite beads. The mechanism includes physical adsorption and ion exchange reaction in normal water of  $\text{pH}=6-8$ .

(4) The adsorption process of HAP/ATT composite beads is endothermic and spontaneous. The value of  $\Delta H^{\theta}$  is  $4.77\text{KJ/mol}$ ; The value of  $\Delta S^{\theta}$  is  $0.0292\text{ KJ}/(\text{mol}\cdot\text{K})$ .

## REFERENCES

- Alagumuthu G, Rajan M. 2010. Equilibrium and kinetics of adsorption of fluoride onto zirconium impregnated cashew nut shell carbon [J]. *Chemical Engineering Journal*, (158):451-457
- Bhatnagar A., Kumar E., Sillanpaa M. 2011. Fluoride removal from water by adsorption: a review[J]. *Chemical Engineering Journal*, 171(3): 811-840.
- Chen L., Zhang K. S., He J. Y., Xu W. H., Huang X. J., Liu J. H. 2016. Enhanced fluoride removal from water by sulfate-doped hydroxyapatite hierarchical hollow microspheres[J]. *Chemical Engineering Journal*, 285: 616–624
- Fan X, Parker D J, Smith M D. 2003. Adsorption kinetics of fluoride on low cost materials [J]. *Water Research*, (37):4929-4937
- Feng L, Xu W H, Liu T F, *et al.* 2012. Heat regeneration of hydroxyapatite/attapulgitic composite beads for defluoridation of drinking water [J]. *Journal of Hazardous Materials*, (221– 222) : 228-235
- Gao S., Sun R., Wei Z., Zhao H., Li H., Hu F. 2009. Size-dependent defluoridation properties of synthetic hydroxyapatite [J]. *Journal of Fluorine Chemistry*, 130(6): 550-556
- Gong L. Y., Feng L. 2015. Preparation and Defluorination Mechanism of a Novel Copolymerized Hydroxyapatite-aluminium Chloride Material [J]. *Rsc Advances*, 5(115): 95334-95343
- He J., Chen K., Cai X., Li Y., Wang C., Zhang K., Jin Z., Meng F., Wang X., Kong L., Liu J. H. 2016. A biocompatible and novel defined Al-HAP adsorption membrane for highly effective removal of fluoride from drinking water [J]. *Journal of Colloid & Interface Science*, 490: 97-107
- He J. Y., Zhang K. S., Wu S. B., Cai X. G., Chen K., Li Y. L., Sun B., Jia Y., Meng F. L., Jin Z., Kong L. T., Liu J. H., 2016. Performance of novel hydroxyapatite nanowires in treatment of fluoride contaminated water [J]. *Journal of Hazardous Materials*, 303 (16): 119-130
- Jadhav S. V., Bringas E., Yadav G. D. 2015. Arsenic and fluoride contaminated groundwaters: A review of current technologies for contaminants removal [J]. *Journal of environmental management* , 162: 306-325
- Khan A, Singh R. 1987. Adsorption thermodynamics of carbofuran on Sn (IV) arsenosilicate in  $H^+$ ,  $Na^+$  and  $Ca^{2+}$  forms. *Colloid and Surf*, (24): 421-427
- Liu H B, Zuo W W, Lin W Z. 2007. A study on removing  $F^-$  ions by synthesized hydroxyapatite. *Journal of University of South China (Science and Technology)* , 21 (4): 61-63
- Mohapatra M., Anand S., Mishra B. K., Giles D. E., Singh P. 2009. Review of fluoride removal from drinking water[J]. *Journal of Environmental Management*, 91(1):67-77.
- Poinern G. E. J., Ghosh M. K., Ng Y. J., Issa T. B., Anand S., Singh P. 2011. Defluoridation behavior of nanostructured hydroxyapatite synthesized through an ultrasonic and microwave combined technique [J]. *Journal of Hazardous Materials*, 185(1): 29-37
- Prabhu S. M., Lee G., Khan A., Meenakshi S. 2016. Assembly of nano-sized hydroxyapatite onto graphene oxide sheets via in-situ fabrication method and its prospective application for defluoridation studies [J]. *Chemical Engineering Journal*, 300: 334-342

- Qiu F G, Wang X C. 2002. Analysis on the fluoride removal capacity of activated alumina [J]. J. Xi'an Univ. of Arch. & Tech. (Natural Science Edit ion), 34(2):141-144
- Sairam S C, Natrayasamy V, Meenakshib S. 2009. Defluoridation of water using magnesia/chitosan composite[J]. Journal of Hazardous Materials, (163):618-624
- Singh J., Singh P., Singh A. 2016. Fluoride ions vs removal technologies: A study [J]. Arabian Journal of Chemistry, 9(6): 815-824
- Wang D. 2008. Experimental study on the removal of fluorine in drinking water by powder bone black. Water Resurces Protection, 24 (1) : 63-64, 68
- Wang P., Li G. C. 2009. Study on preparation and fluoride removal performance of hydroxyapatite. Chinese Journal of Environmental Engineering, 3 (3) : 564-568
- Xue Y W, Yang K, Mei J. 2008. Study of influence factor of fluorine removal from fluorinated water using coagulating sedimentation method [J]. Engineering Journal of Wuhan University, 43(4) : 477-480,493
- Yin G X, Jiang X, Zhu L X. 2007. Applilication of active alumina method for groundwater treatment of high fluoride area [J]. Journal of Henan Polytechnic University (Natural Science), 26(7):32-25
- Yue W W, Wang Y, Gao B Y, *et al.* 2006. Adsorption of phosphate from aqueous solution by modified wheat residue [J]. Acta Scientiae Circumstantiae, 26 (12) : 1983-1986
- Zhang Y, Xie H, Jia W B, *et al.* 2005. Regeneration performance of activated aluminum oxide as a fluorine-removal agent [J]. J. Wuhan Univ. (Nat. Sci. Ed.), 51(4):457-460

# Development of a Solar Heating System for Improving Performance of On-site Sanitation Systems

Koottatep, T<sup>1</sup>, Pussayanavin, T, <sup>1,2,a</sup>, Polprasert, C.<sup>3</sup>

1 School of Environment, Resources and Development, Asian Institute of Technology, P.O. Box.4, Klong Luang, Pathumthani, 12120, Thailand.

2 Faculty of Science and Technology, Phranakhon Rajabhat University, Thailand

3 Department of Civil Engineering, Faculty of Engineering, Thammasat University, Pathumthani 12120, Thailand.

<sup>a</sup> corresponding author: email: poktatchai@gmail.com, tatchai@pnru.ac.th

## Abstract

Application of solar energy for thermal disinfection of onsite wastewater treatment was developed in this study. This experimental study was conducted with a pilot-scale of septic tank equipped with a solar water heating device (called solar septic tank) for the treatment black water, located at a housing community, Samutprakarn province, central Thailand. The aim of this research was to investigate performance of the solar septic tank by emphasizing on quantity of energy supply and pathogen inactivation efficiency. During the 270 days of operation, the pilot-scale solar septic tank could perform successfully as liquid pasteurization and requiring the solar energy of about 6 kW/day.

**Keywords:** Septic tank performance, Solar energy heating system, Black water, Pathogen inactivation

## Introduction

Currently about 2.5 billion people still lack access to improved sanitation and more than 1 million people may have died prematurely per year from improper sanitation. Due to high investment cost and requirement of skilled operation, the conventional sanitation technology is unsuitable for addressing these environmental and health issues. Thammarat et al. 2014 found that effluent from most on-site sanitation system contained higher concentrations of pathogens and organic matter than the acceptable guidelines. To improve performance of the on-site sanitation systems, an innovative and practical technique using solar energy in the septic tank is considered an effective sanitation technology for pathogens inactivation. Nowadays, application of solar energy for thermal disinfection of onsite wastewater treatment has been developed for wastewater disinfection due to its economical benefits and suitable operation and maintenance of facilities. Operating a septic tank at temperatures higher than ambient condition resulted in better pathogen die-off (Thammarat et al, 2013). The aim of this research was to investigate performance of a conventional septic tank equipped with a solar

water heating device called solar septic tank by emphasising on quantity of energy supply and pathogen inactivation efficiency.

### **Material and Methods**

A pilot-scale solar septic tank testing, installed at a housing community, in Samutprakarn province, central Thailand, consisted of 2 main component i) a 1000 L-conventional septic tank and ii) 6 m<sup>2</sup>-solar water heating device. The field testing of the solar septic tank was conducted for 8 months during March - October 2015. A hot water storage tank, made of stainless steel insulated with polyurethane, had a working capacity of 100 L. Temperatures inside the solar septic tank were maintained above 40-50 °C by circulating the hot water generated from the solar water heating device through a heat transfer equipment (copper coil) at the rate of 5 L/min (Figure 1). To evaluate the technical feasibility of heating the septic tank content, on-line temperature sensors were installed in 3 main positions: (1) the hot water generating from the solar water heating device, (2) inside the solar septic tank and (3) ambient condition.



**Figure 1 Modified conventional septic tank with solar heated water**

Flow rate and hydraulic retention time of the solar septic tank were about 100-300 L/d and 3-10 days. The influent and effluent samples of the solar septic tank were collected for analysis of total coliforms and E.coli concentrations according to APHA, AWWA and WEF (2005). Quantity of solar energy or heat supplied to the solar septic tank was calculated from the specific heat and change in temperature data, shown in equation (1)

$$Q = mc\Delta t \quad (1)$$

where, Q = quantity of solar energy (kJ), m = mass of a substance (kg), c = specific heat coefficient (4.187 kJ/kg· °C) and ΔT = change in temperature (°C)

### Results and Discussion

During the operation period, the average ambient temperature and solar radiation were about 32 °C and 200 J/m<sup>2</sup>.min, respectively. The temperature range in the solar septic tank equipped with the solar water heating device was about 40-45 °C, while the hot water temperatures were 27-65 °C (Figure 2). It is technically possible to raise the solar septic tank temperature to 60 °C or more by adjusting the heated water circulation rate or adding more solar collectors and better insulation system of the solar septic tank.

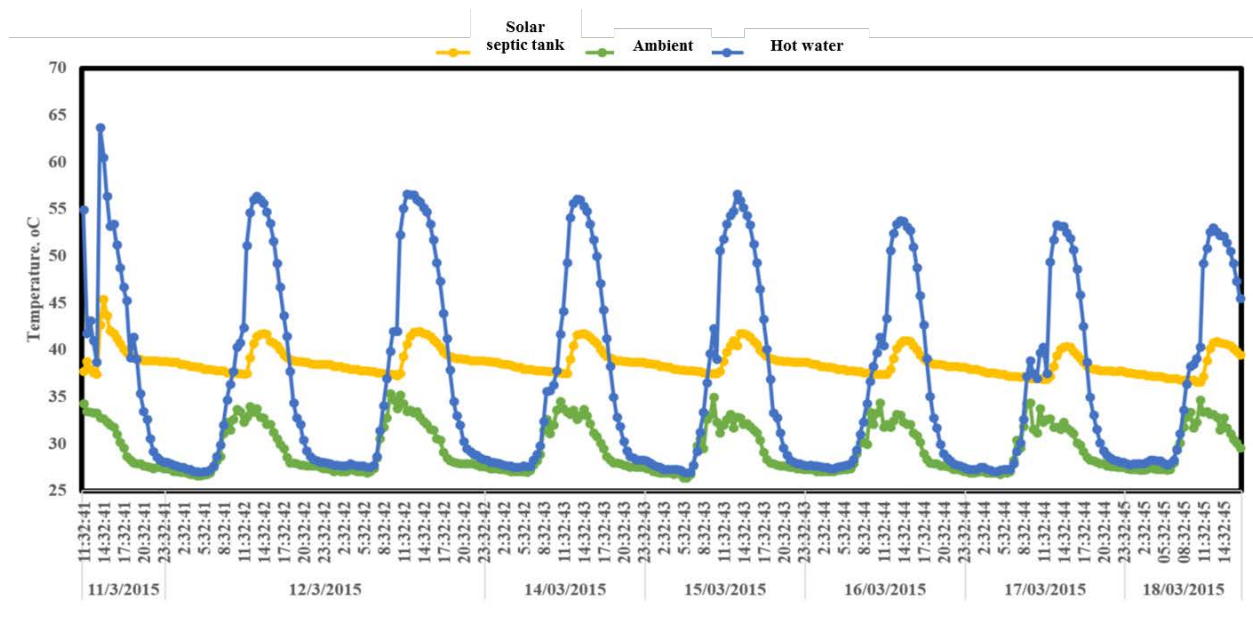
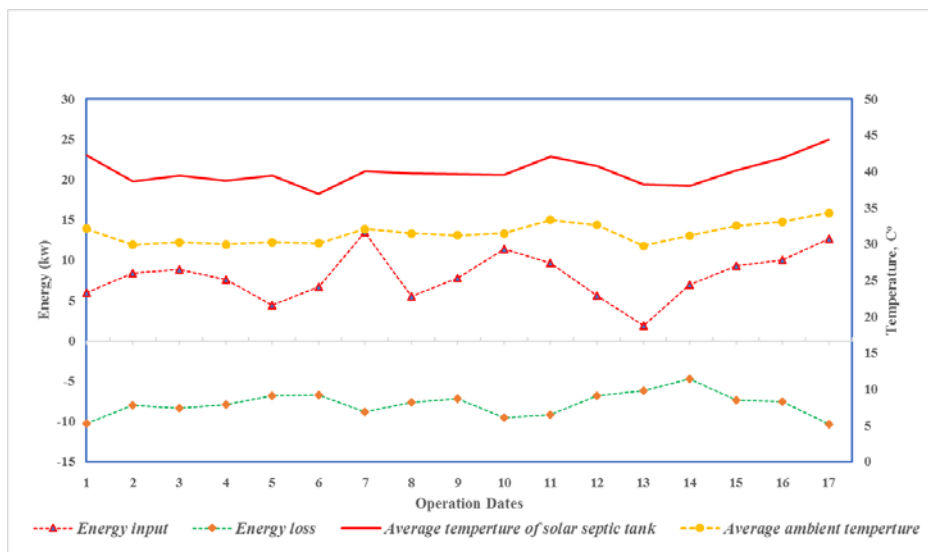


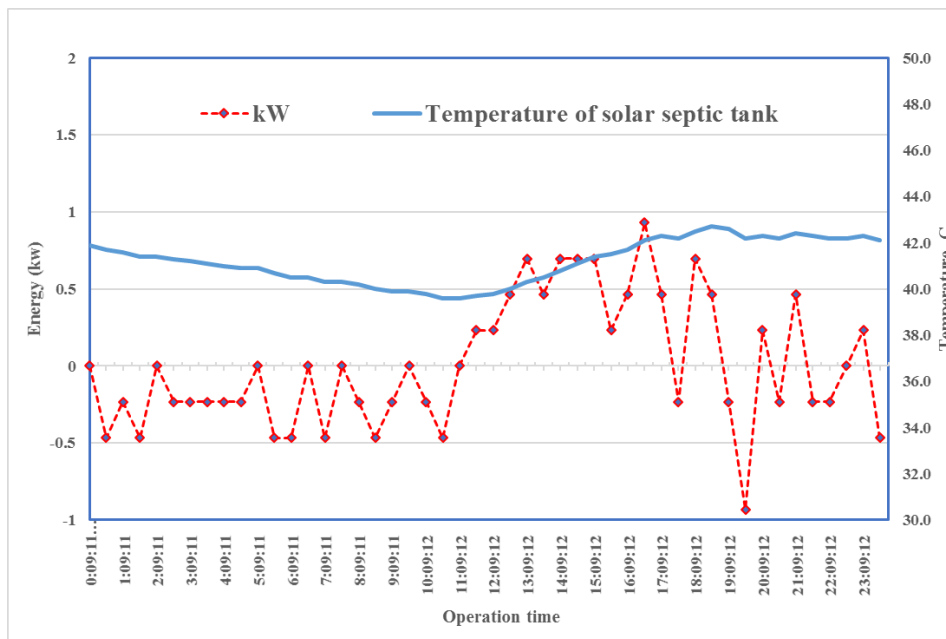
Figure 2. Temperature sensors



Figure 3 shows a relationship between solar energy input and loss (calculated from equation 1) and temperature inside the solar septic tank. With the solar energy input of about 6kW/day, the temperature inside the solar septic tank were found to be higher than the ambient temperature. With respect to a daily temperature profile, Figure 4 shows the net energy supply (input minus loss) to the solar septic tank to vary from -1 to 2 kw, but the temperatures of the solar septic tank were found to be above 40 °C. The data shown in Figures 3 and 4 suggest the technical feasibility of using solar energy to raise temperatures inside the septic tank.

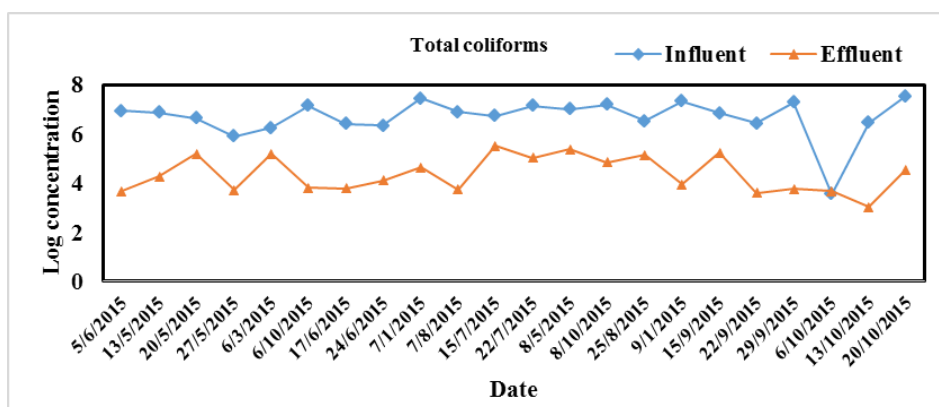


**Figure 3 Temperature and quantity of energy**

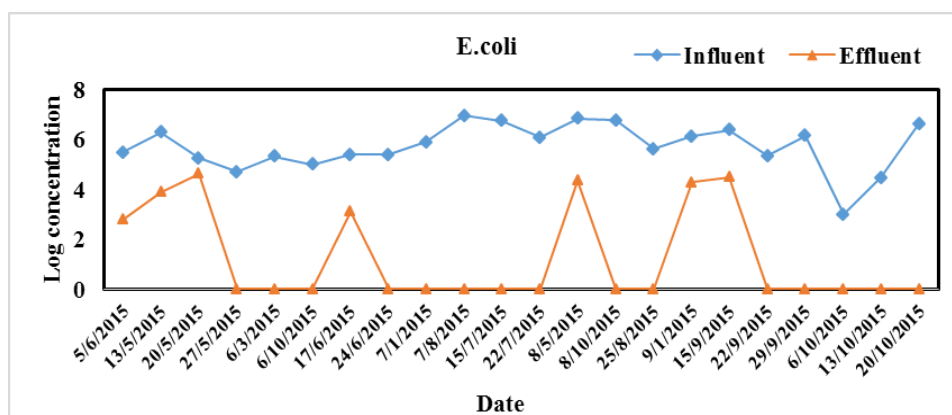


**Figure 4 Daily temperature and energy profile**

The inactivation efficiencies of total coliforms and E.coli in the solar septic tank were be about 2-5 log reduction (Figure 5). The effluent concentrations of E coli, the pathogen indicator, were less than  $10^3$  no/100 mL, suitable for re-use and discharge to the environment (PCD, 2014). However, during the raining period (June to August), solar energy alone could not increase the temperature above 40 °C, hence, low inactivation efficiencies were observed. Therefore, additional heating source should be provided to the solar septic tank during the raining period to maintain the temperatures above 40 °C.



(a)

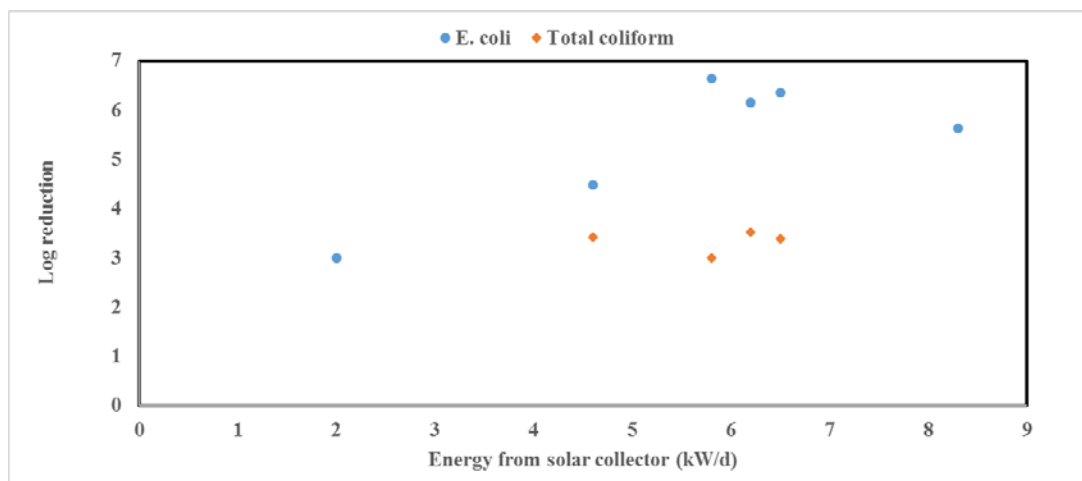


(b)

**Figure 5 Pathogen inactivation in Modified conventional septic tank with solar heated water:**

**(a) Total coliforms and (b) E. Coli**

Figure 6 shows a relationship between log reduction of total coliforms and E.coli and the energy input from the solar collector. It is clearly seen that increasing solar energy from 4.5 to 8 kW/day resulted in increased log reduction of total coliforms and E.coli. These results indicated more than 3 log reduction of pathogens could be achieved, when the solar collector produced more than 6 kW/d of energy input.



**Figure 6 Energy and pathogen inactivation**

## Conclusions

The findings of this study suggested the technical feasibility of applying the solar water heating device to inactivate pathogens of in the septic tanks without other supplementary sources of energy. With the solar energy input of about 8 kW/day, temperature inside the solar septic tank were maintained above 40 °C. The average log reduction of total coliforms and E.coli during the operation period of 280 days were about 2 and 4 log reductions, with less than 1000 no./100 mL suitable for safe discharge to the environment.

## Acknowledgements

This study was financially supported by the Bill & Melinda Gates Foundation and Kurita Water and Environment Foundation for which grateful acknowledgment is made.

## References

- American Public Health Association, 2005. APHA (2005) Standard methods for the examination of water and wastewater.
- PCD, Pollution Control Department. (2014). Retrieved November 29, 2014 from [www.pcd.go.th](http://www.pcd.go.th)
- Koottatep, T., Phuphisith, S., Pussayanavin, T., Panuvatvanich, A. and Polprasert, C. (2013). Modelling of Pathogen Inactivation in Thermal Septic Tanks. *Water Sanitation Hygiene Development*, 4(1), 81–88.
- Koottatep T., Eamrat. R., Pussayanavin, T. and Polprasert C., 2014, Hydraulic Evaluation and Performance of On-Site Sanitation Systems in Central Thailand: *Environ Eng Res.* 2014;19(3):269-274

# Isolation of butyric acid-degrading bacterium from pit latrine faecal sludge

Ref # S2SMALL-36503

J.B.J. Njalam'mano\*, E.M.N. Chirwa

University of Pretoria, Department of Chemical Engineering, Water Utilisation and Environmental Engineering Division, Private Bag X20, Hatfield, Pretoria 0002, South Africa

[chinamvuu@yahoo.co.uk](mailto:chinamvuu@yahoo.co.uk)

**Abstract:** Offensive smells from pit latrines is one of the factors that discourage their usage as well as adoption. Butyric acid is one of the chemical compounds that significantly contribute to these noxious smells. In this study, butyric acid degrading bacteria strain designated as B5a was isolated from pit latrine faecal sludge. In accordance with the 16S rRNA sequence analysis the strain was identified as *Achromobacter xylosoxidans*. The strain has the capability to grow without complete inhibition up to 12000 mgL<sup>-1</sup> of butyric acid. Further experiments showed that the cell growth was optimal at pH 7. The isolation of the strain from indigenous pit latrine faecal sludge shows that there is significant potential for application of microbes to reduce or eliminate offensive smells from the pit latrines.

**Keywords:** *Achromobacter xylosoxidans*, biodegradation, butyric acid, odour, pit latrine

## 1. INTRODUCTION

Pit latrines are still dominant basic minimum acceptable forms of sanitation in low income communities of developing countries, particularly in the rural areas and unplanned areas of the developing cities (Jenkins *et al.*, 2015; Thye *et al.*, 2011). There is a growing concern, however, that offensive smells-malodours released from the pit latrines, which elicit disgusting or repulsive response, are one of the factors that thwart adults and children to use latrines and encourage to opting for open defecation. Besides, some people have a miasmatic view that associates malodorous emissions with conditions of 'unhealthy' air that causes diseases (Drangert, 2004; Jorgensen, 2013) and noxious smell from the latrines has always been proxy for their filthiness (Irish *et al.*, 2013). This offers an important but often overlooked major impediment, dissuading people from adoption and usage of the pit latrines hence affecting successful effective sanitation promotion (Rheinländer *et al.*, 2013).

Recent studies performed by Chappuis *et al.* (2014) and Chappuis *et al.* (2016) have revealed that butyric acid (C<sub>4</sub>H<sub>8</sub>O<sub>2</sub>) is one of the key chemical components that has considerable contribution to pit latrine noxious odours and is usually found in high concentrations. Butyric acid, a 4-carbon volatile organic compound (VOC), is an intermediate product generated in the anaerobic bioconversion of complex organic matter to methane(CH<sub>4</sub>) and carbon dioxide (CO<sub>2</sub>) (Lin *et al.*, 1998). Butyric acid exhibits a distinctive sour, sweaty smell (Otten *et al.* 2004).

In an attempt to eliminate or reduce these offensive smells several techniques such as addition of carbonaceous or absorbent materials (Moe and Rheingans, 2006; Canady, 2011), use of ventilation systems (Mara, 1984), use of water seal (Tilley *et al.*, 2008) and urine separation (Münch and Dahm, 2009) are currently available. These techniques continue to occupy their niche, but social, economic, environmental and technological shortfalls remain. In recent times, biological methods, which deal with treatment of a wide range of chemical compounds, converting, for instance, volatile organic compounds (VOCs) to biomass and carbon dioxide, have been gaining wide popularity. This is because they are inexpensive, versatile and environmentally sound compared to conventional chemical and physical treatment techniques.

Thus, the present work reports on the isolation of a bacterial strain that that the ability to utilise high concentrations of butyric acid in the batch system and to determine the effects of initial concentration and pH on bacterial utilisation of this compound. The study goal is to elucidate a potential application for biodegradation of butyric acid in pit latrine faecal sludge.

## **2. MATERIALS AND METHODS**

### **2.1 Chemicals**

All chemicals used in this study were of analytical grade. Butyric acid ( $\geq 99\%$ ) was purchased from Sigma Aldrich Inc., St Louis, MO, USA. Sodium hydroxide was purchased from Merck Chemical (Pty) Ltd, Gauteng, South Africa. Distilled water was prepared by Water Still system (Daihan Labtec. Co. Ltd, Kyonggi-Do, Korea).

### **2.2 Source, collection and storage of samples**

Faecal sludge samples used in this study were collected from pit latrines in a semi-rural mining area of Kendal in Mpumalanga Province in South Africa ( $26^{\circ}5'24''S$   $28^{\circ}58'17''E$ ). The samples were obtained from top 0 to 0.1 m depth using prestilised auger-like equipment. All non faecal- waste (such as diapers, stones, clothes, metals, plastic bags etc.) were removed. The samples were then poured into a sterile zip-lock polythene bag, which was later put in a presterilised 5L container at  $4^{\circ}C$ . The samples were immediately transported to the laboratory and preserved at  $4^{\circ}C$  prior to use.

### **2.3 Preparation of faecal sludge samples for enrichment**

Faecal sludge sample (100g) was put in a pre-sterilised 2L Schott bottle and 1L of sterile distilled water was added. The mixture was shaken at 150 rpm for 1 h at  $37^{\circ}C$  in a shaking incubator (Labcom, South Africa). The mixture was filtered through sterilised cotton wool to remove solid materials. The supernatant was preserved at  $4^{\circ}C$ .

### **2.4 Growth media**

Bacteria was grown in different media such nutrient broth, nutrient agar and mineral salt medium (MSM) dependent upon the purpose as in Section 2.5.

### **2.5 Preparation of MSM, nutrient Agar, nutrient broth and glassware**

MSM had the following components in 1 L of distilled water: 10mM  $NH_4Cl$ ; 30mM  $Na_2HPO_4$ ; 20mM  $KH_2PO_4$ ; 0.8mM  $Na_2SO_4$ ; 0.2mM  $MgSO_4$  and 1 mL of trace element solution. The trace element solution contained the following components: 50  $\mu M$   $CaCl_2$ ; 25 $\mu M$   $FeSO_4$ ; 0.1 $\mu M$   $ZnCl_2$ ; 0.2 $\mu M$   $CuCl_2$ ; 0.1 $\mu M$   $NaBr$ ; 0.05 $\mu M$   $NaMoO_2$ ; 0.1 $\mu M$   $MnCl_2$ ; 0.1 $\mu M$   $KI$ ; 0.2  $\mu M$   $H_3BO_3$ ; 0.1 $\mu M$   $CoCl_2$  and 0.1 $\mu M$   $NiCl_2$  in 1L of deionised water (Roslev et al., 1998). The media was then autoclaved at  $121^{\circ}C$  at 2 atm for 15min in order to render the medium free from all forms of life and was then cooled down to room temperature. This was amended with butyric acid with pH adjusted to 7.0. prior to inoculating with faecal culture.

Nutrient agar was prepared by dissolving 31 g in 1 L of distilled water. The pH of the medium was adjusted to 7.0 and autoclaved at temperature of  $121^{\circ}C$  and pressure of  $115kg/cm^2$  for 15 min. It was then cooled down to a temperature of  $40-50^{\circ}C$  prior to dispensing in pre-sterilised petri dishes for colony development. The prepared nutrient agar could be kept in the refrigerator for a maximum of two weeks for use.

Nutrient broth was prepared by dissolving 16 g in 1 L of distilled water. The pH of the medium was adjusted to 7 and autoclaved at temperature of  $121^{\circ}C$  and pressure of  $115kg/cm^2$  for 15 min. It was then allowed to cool down to room temperature prior to use.

All the glassware were thoroughly cleaned with soap and rinsed with distilled water followed by acetone. The glassware was covered with aluminum foil before sterilising them in the autoclave at temperature of 121°C and pressure of 115kg/cm<sup>2</sup> for 15 min.

### **2.6 Enrichment and isolation of butyric acid degrading bacterial isolates**

Bacterial strains were isolated by enrichment culture. 1 mL of supernatant obtained as described above was aseptically inoculated into each sterile 250mL Erlenmeyer volumetric flask with 100mL of the MSM amended with 1000mgL<sup>-1</sup> of butyric acid. The MSM was adjusted to pH 7.0. The flasks were cotton plugged and incubated at 30°C for 24-48 hours under shaking at 150 rpm in the shaking incubator in the dark. From then on, a series of four consecutive enrichments in the fresh medium were carried out under the same condition as above to enrich a butyric acid-degrading microbial consortium. Then a series of dilution of the enriched inoculums from the flask were conducted. Ten 10 ml sterile test tubes were obtained and labelled test tube 1 through 10 and then 4.5 ml of MSM was added to each test tube and then 0.5 ml of the inoculums with bacterial suspension into test tube 1. At each step the solution was thoroughly mixed using the vortex before proceeding to the next step. This continued in this fashion until the original bacterial suspension was serially diluted into test tube 10. Then 0.1mL of serially diluted bacterial suspension from the 7<sup>th</sup> to the 10<sup>th</sup> test tube was spread on nutrient agar plates to obtain single colonies after the sterile nutrient agar plates were incubated at 30°C for 24-48 hours in the dark.

### **2.7 Purification of bacterial culture**

Single and phenotypically different colony loopfuls from each nutrient agar plates as described above was streaked onto other fresh sterile nutrient agar plates to check for purity. Dependent upon the exhibited colours and morphologies that were identified from the cultures or after obtaining individual pure colonies, these were individually streaked onto the fresh nutrient agar plates. This was followed by incubation at 30°C for 24-48 hours. The process was done successively for at least three times in order to realise near pure culture of each identified colony. All the pure isolates were aseptically cultivated in nutrients broth at 30 °C for 24 hours. The bacterial cells were harvested at the speed of 6000 rpm at 4°C for 10 min. using Sorvall Lynx 600 centrifuge (ThermoFisher Scientific, Osterode am Harz, German). The cells were preserved in 2 mL of MSM with 30% glycerol at -80°C until use.

### **2.8 Characterisation of bacterial isolates**

A 16 Svedburg unit ribosomal Ribo-Nucleic Acid (16S rRNA) genotype fingerprinting was applied to acquire DNA sequences of pure bacteria isolates. Genomic DNA extraction was done on the distinct recognizable colonies according to the protocol defined in the Wizard Genomic DNA Purification Kit from Promega Cooperation, Madison, USA. A 16S rRNA gene was amplified by reverse transcriptase-polymerase chain reaction (RT-PCR) using primers pA and pH1. PCR fragments were then cloned into pGEM-T-easy. Partially sequenced amplified 16 rDNA fragment was compared with other gene sequences in Gen Bank using a basic BLAST of the National Center for Biotechnology Information (NCBI) gene library. This was aligned with gene sequence of the isolates.

### **2.9 Bacterial cell growth studies**

Prior to inoculation of the cultures in the flask for bacterial cell growth studies the culture was acclimatised by cultivating the cultures at 30 °C in 150 ml MSM amended with 500mgL<sup>-1</sup> of butyric acid in 250 ml Erlenmeyer flasks in an aseptic condition. Sub-culturing of the cells was done by transferring the cells at exponential phase to fresh MSM amended with 500mgL<sup>-1</sup> butyric acid. This was to ensure the glycerol used for the preservation of the pure culture was completely eliminated prior to cell growth studies. Eventually the cells were harvested. Cell suspension for the experiments was prepared by dissolving 100mg of the harvested cells in



10mL of sterile MSM to ensure that the flasks are inoculated with well homogenised cell suspensions. In each of 250 ml Erlenmeyer flasks containing 150 ml sterile MSM 100 $\mu$ L of the aliquot was transferred aseptically. The flasks were plugged with sterile cotton wool and incubated in the dark at 30 °C at agitation rate of 150 rpm till the cell growth reached the death phase.

### **2.10 Analytical method**

Evaluation of cell growth was spectrophotometrically conducted at single wavelength  $\lambda = 600\text{nm}$  using a UV Lightwave II spectrophotometer (Labotec, South Africa). The cuvette of 10 cm path length was used to carry the cell suspension in the sample chamber of the spectrophotometer. The measurements were blanked to zero using sterile MSM as a reference. All the tests were conducted in triplicates.

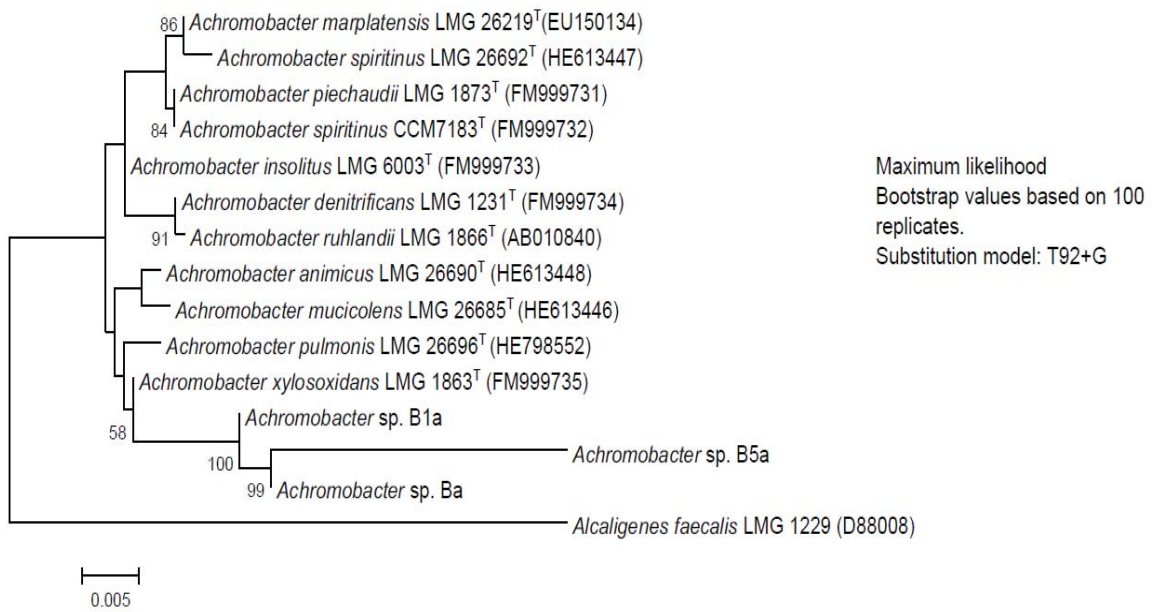
## **3. RESULTS AND DISCUSSION**

### **3.1 Isolation and screening of the butyric acid-degrading strain**

A total of nine bacterial strains were isolated from the pit latrine faecal sludge samples by the method mentioned in Section 2.6. The butyric acid degradation activity was not confirmed by the measurement of butyric acid degradation. However, the cell growth kinetic studies were done in which butyric acid was utilised as the sole source of carbon and energy. All isolates were established to possess the ability to utilise the odorous compound (butyric acid) as their source of carbon and energy. Among all the isolates tested, the isolate designated as B5a, exhibited the ability to utilise butyric acid even at very high concentrations. This characteristic prompted the researchers to subject it for further investigation.

### **3.2 Identification on the basis of phylogenetic analyses**

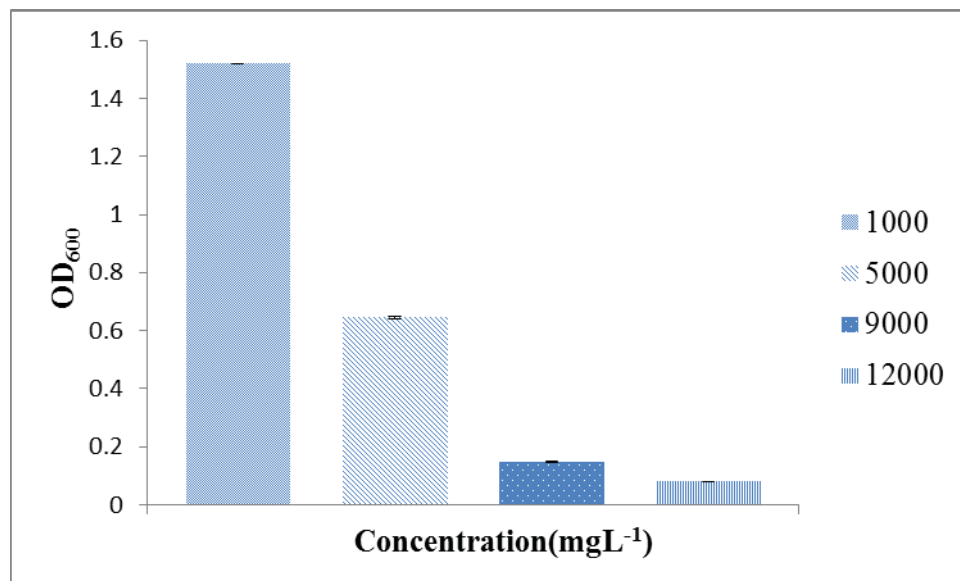
The 16S rRNA gene sequences of strain B5a were obtained, submitted and compared with other genes in GenBank using a basic BLAST of the National Center for Biotechnology Information (NCBI) (<http://www.ncbi.nlm.nih.gov>). The phylogenetic tree generated based on 16S rRNA gene sequences of the isolate B5a revealed that the bacterium has the highest sequence homology (93%) clearly marched with *Achromobacter xylosoxidans* LMG1863 (Gen- Bank Accession No.: FM999735) as shown in Fig. 1. Henceforth, on the basis of this method the bacterial strain was identified as *Achromobacter xylosoxidans*.



**Figure 1:** Phylogenetic tree based on 16S rRNA gene sequences showing genetic relationship of strain B5a with taxonomically related strains. GeneBank access number of each isolate is given in parentheses.

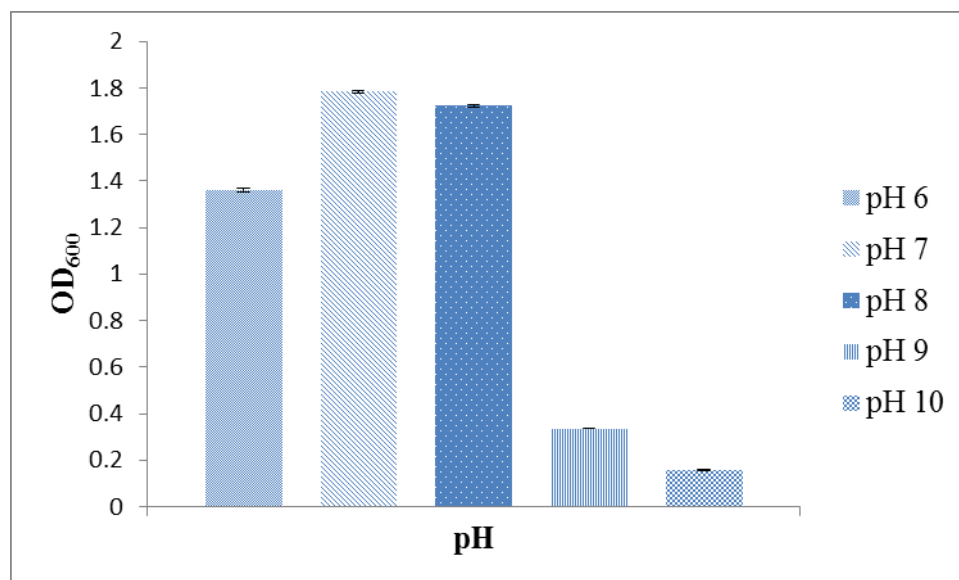
### 2.3 Effects of initial substrate concentration

In order to examine the probable inhibitory effect of butyric acid on cell growth, *A. xylosoxidans* B5a was cultivated in MSM amended with butyric acid. The initial concentrations evaluated were between  $1000\text{mgL}^{-1}$  and  $13,000\text{mgL}^{-1}$  (1000, 5000, 9000, 12000 and 13000) at pH 7.0 and  $30\text{ }^{\circ}\text{C}$ .



**Figure 2:** Effect of initial substrate concentration on bacterial growth of strain B5a.

The results of the effect of the initial concentration are presented in Figure 2. The measurement of optical density was done till the death phase is reached. Results of these studies show that the higher is the concentration of butyric acid, the longer time it takes to reach the maximum optical density. At initial concentrations of  $1000\text{mgL}^{-1}$ ,  $5000\text{mgL}^{-1}$ ,  $9000\text{mgL}^{-1}$  and  $12000\text{mgL}^{-1}$  the maximum optical density was reached at the end of 42, 68 and 136 hours respectively. This indicates that any increase in concentrations result in increased inhibition of the cell growth of *A. xylosoxidans* B5a. This could be because the strain needed some time to get acclimatised to the environment to produce required degrading enzymes. The cell growth could be observed up to the concentration of  $12000\text{mgL}^{-1}$ . Past this concentration the cell growth was absolutely inhibited which might be an indication of toxicity. Fan *et al.*(2012) found that the growth of *Bacillus cereus* CB4 was positively related to degradation of glyphosate as its sole source of carbon, energy and nitrogen. In this study, it was also observed that the pH of the medium at the conclusion of the incubation period was higher than the initial pH. The measured final pH was positively related to the initial substrate concentration. Thus, the higher the concentration the higher was the observed final pH. This phenomenon could be due to the intermediates product which might be basic in nature hence increasing the pH of the medium.



**Figure 3: Effect of initial pH on bacterial growth of strain B5a.**

### 3.4 Effects of initial pH

The MSM solution amended with  $1000\text{mgL}^{-1}$  were inoculated with 0.1mL of cell suspension and cultivated in the shaking incubator at 30 °C and agitation rate of 150 rpm. The initial pH was adjusted to 6.0, 7.0, 8.0, 9.0 and 10.0.

As indicated in Fig.3 bacterial cell growth increased with the increase in pH and reached the maximum at pH7 and thereafter the bacterial cell growth drastically decreased with increase in pH. This implies that the bacterial strain has its growth optimum between pH 6 and pH 8. Hence, the bacterial strain B5a can be classified as neutrophile, thus, the butyric-degrading enzymes have their optimum enzymatic activity in neutral environments. This consequentially suggests that when the pH of fecal sludge or wastewater becomes too basic or acidic the bacterial strain B5a growth and metabolic processes would be hindered. Similar to our

observation, Zhang et al. (2007) reported that *A. xylosoxidans* strain B-16 could degrade bisphenol A within the pH range of 5 and 9. The maximum bisphenol A degradation and cell growth was realised at pH 7.

#### 4. CONCLUSIONS

Bacterial strain utilising butyric acid even at concentration as high as 12000mgL<sup>-1</sup> was isolated from pit latrine faecal sludge. The bacterium has been identified as *Achromobacter xylosoxidans* B5a based on 16S rRNA sequence analysis. To the best of our knowledge, this is the first report about *A. xylosoxidans* isolated with the ability to utilise up to 12000mg L<sup>-1</sup> of butyric acid. The bacterial cell growth's dependence on butyric acid as a sole source of carbon and energy is a clear evidence for the degradation of the compound. Initial butyric acid concentration and pH also influences the bacteria growth. Butyric acid utilising activity and bacterial cell growth were inhibited at high substrate concentrations. The optimal bacterial cell growth was obtained at pH 7.

Further studies are needed to determine the butyric acid degradation efficiency of the strain to confirm if the cell growth of strain B5a is positively related to degradation of butyric acid. Also the metabolic intermediates in the cell free extracts of *A. xylosoxidans* B5a that are responsible for the change in the pH during the degradation process as observed from the study should be identified. The successful isolation of bacteria strain B5a capable of utilising butyric acid indigenous to the pit latrine faecal sludge reflects the significant potential of de-odourisation of pit latrines with microorganisms.

#### ACKNOWLEDGEMENTS

The authors would like to acknowledge University of Pretoria for the financial support to first author (JBJN) through UP Commonwealth Doctoral Scholarship to undertake this study. The authors are also extremely grateful to Professor S.N. Venter of the Department of Microbiology and Plant Pathology, University of Pretoria for his timely assistance in the determination of the 16S rDNA sequences.

#### REFERENCES

- Canady,C. 2011 Simple urine-diverting dry toilets built with recycled or readily available materials. *Sustainable Sanitation Practice* Issue 6/2011 [http://www.sswm.info/sites/default/files/reference\\_attachments/CANADAY%202011Simpl%20UDDTs%20Built%20with%20Recycled%20or%20Readily%20Available%20Materials.pdf](http://www.sswm.info/sites/default/files/reference_attachments/CANADAY%202011Simpl%20UDDTs%20Built%20with%20Recycled%20or%20Readily%20Available%20Materials.pdf) (accessed 15 July 2016)
- Chappuis C.J-F., Niclass Y., Cayeux I. & Sarkenmann C. 2016 Sensory survey of key compounds of toilet malodour in Switzerland, India and Africa, *Flavour and Fragrance Journal*, 31(1), 95–100.
- Chappuis C. J.-F. ,Niclass Y., Vuilleumier C.& Starckenmann C. 2015 Quantitative headspace analysis of selected odorants from latrines in Africa and India. *Environmental Science and Technology*, 49(10), 6134–6140.
- Drangert, J-O. 2004 *Norms and attitudes towards ecosan and other sanitation systems*. EcoSan Publication Series. Stockholm Environment Institute, Stockholm, Sweden

Fan J., Yang G., Zhao H., Shi G., Geng Y., Hou T. & Tao K. 2012 Isolation, identification and characterization of a glyphosate-degrading bacterium, *Bacillus cereus* CB4, from soil. *Journal of General Applied Microbiology*, **58**, 263–271

Irish S., Aiemjoy K., Torondel B., Abdehali F. & Ensink J.H.J. 2013 Characteristics of latrines in Central Tanzania and their relation to fly catches. *Plos One*. **8** (7):e67951. 67910.61371/journal.pone.0067951

Jenkins M.W, Cumming O. & Cairncross S 2015 Pit latrine emptying behavior and demand for sanitation services in Dar Es Salaam, Tanzania. *International Journal of Environmental Research Public Health* **12**(3), 2588-2611

Jorgensen, D. (2013) “The medieval sense of smell, stench and sanitation” In *Les cinq á nos jours.ed. Ulrike*. Robert Beck and Emmanuelle Retillaud-Bajac, 301-313 (Tours: Presses Universitaires, François-Rabelais)

Mara, D. (1984). *The design of ventilated improved pit latrine, TAG Technical Note13*. The International Bank for Reconstruction and Development and the World Bank, Washington DC.

Moe, C.L. and Rheingans, R.D. (2006) Global challenges in water, sanitation and health. *Journal of Water and Health*. 04 Supplementary. IWA Publishing

Münch E. V. & Dahm, P. 2009 *Waterless Urinals: A Proposal to Save Water and Recover Urine Nutrients in Africa*. A Paper presented at 34<sup>th</sup> WEDC International Conference , Addis Ababa, Ethiopia.

Rheinländer T., Keraita B., Konradsen F., Samuelsen H., Dalsgaard A. 2013 Smell: An overlooked factor in sanitation promotion, *Waterlines*, **32** (2), doi: 10.3362/1756-3488.2013.012.

Roslev P., Madisen P.L., Thymes J.B. & Henriksen K. 1998 Degradation of phthalate and di-(2-ethylhexyl) phthalate by indigenous and inoculated microorganisms in sludge amended soil. *Applied and Environmental Microbiology*. **64** (12) 4711-4719.

Thye Y.P., Templeton M.R. & Ali M. 2011. A critical review of technologies for pit latrine emptying in developing countries, *Critical Reviews in Environmental Science and Technology*, **41** (20), 1793-1819.

Tilley E., Lüthi C., Morel A., Zurbrugg C. & Schertenleib R. 2008 *Compendium of sanitation systems and technologies*. Swiss Federal Institute of Aquatic Science and Technology (Eawag). Dübendorf, Switzerland

Zhang C., Zeng G., Yuan L., Yu J., Li J., Huang G., Xi B. & Liu H. 2007 Aerobic degradation of bisphenol A by *Achromobacter xylosoxidans* strain B-16 isolated from compost leachate of municipal solid waste. *Chemosphere* **68**: 181–190

## **Empowered septic tank as decentralized treatment system for a single household and for a community**

**Guruprasad V Talekar<sup>1</sup>, Priya sharma<sup>1</sup>, Anant Yadav<sup>1</sup>, Peter Clauwaert<sup>2</sup>, Korneel Rabaey<sup>2</sup> and Srikanth Mutnuri<sup>1</sup>**

*1 - Applied and Environmental Biotechnology Laboratory, Department of Biological Sciences, Birla Institute of Technology and Science –Pilani, K. K .Birla Goa campus, Goa, India  
Tel: 0091 832 2580125, Fax: 0091 832 2557033, Email: [srikanth.mutnuri@gmail.com](mailto:srikanth.mutnuri@gmail.com), [srikanth@goa.bits-pilani.ac.in](mailto:srikanth@goa.bits-pilani.ac.in)*

*2 - Center for Microbial Ecology and Technology - FBE - Ghent University  
Coupure Links 653, 9000 Gent, Belgium - Phone: +32 (0)9 264 59 76 Email: [Korneel.Rabaey@ugent.be](mailto:Korneel.Rabaey@ugent.be)*

### **Introduction**

The centralized sewage treatment technologies have proven to be expensive, complex and are failing to cater the total wastewater generated. During 2015, in India, the estimated sewage generation was 61754 MLD as against the developed sewage treatment capacity of 22963 MLD, about 38791 MLD of untreated sewage (62% of the total sewage) is discharged directly into nearby water bodies [1]. The untreated/partially treated wastewater makes its way to the water bodies causing immense degradation of the ecosystem and the environmental health. In urban India, 37% of human excreta generated is unsafely disposed, imposing significant effect on public health, working man days and environmental costs which results in loss of national revenues [2]. Inadequate and un-safe discharge of untreated domestic/ municipal wastewater has resulted in contamination of 75 % of all surface water across India [2]. Hence there is urgent need for up gradation in the capacity of wastewater treatment to cater to the needs of ever increasing wastewater production. Decentralization of wastewater treatment is a sustainable solution to address this problem that locally treats the sewage and also reuse/recycle [3].

The present study focuses on design of a novel electrochemical treatment process and design of electrochemical reactors for single household – 4 P. E. and for a community – 100 P.E. to treat black water, evaluation of their performance and advantage of their integration with Vertical flow constructed wetland [4] to ultimately develop a decentralized wastewater treatment system (single household scale and Community scale) that can be integrated to toilet with septic tank.

### **Material and Methods**

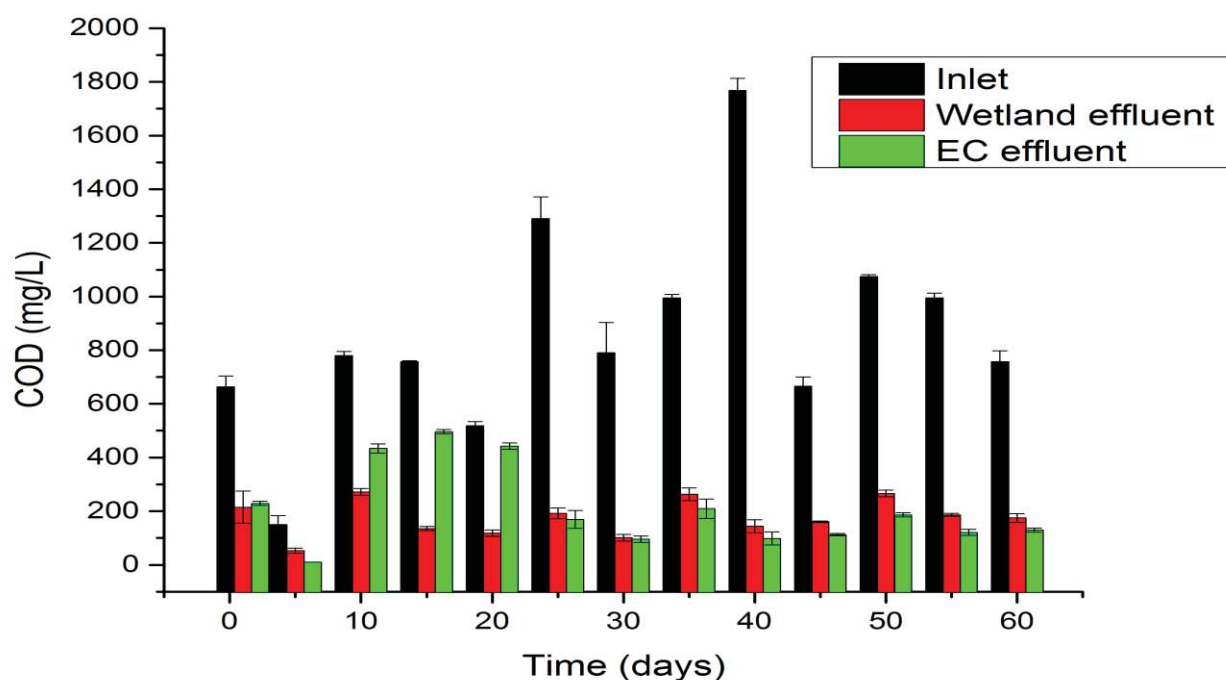
Laboratory scale experiments were conducted on a double chamber membrane separated electrochemical cell [5] for the studying the pH changes, energy requirements, disinfection, wastewater parameter reduction to obtain the design parameters for the household scale and the community scale reactor design.

Performance analysis of the single household scale reactor combined with the VFCW and the community scale treatment system was done on regular basis during which the samples at every stage (septic tank, wetland treated, EC treated) in the treatment system was collected and analyzed for COD,TKN, TAN,TP and coliform count.

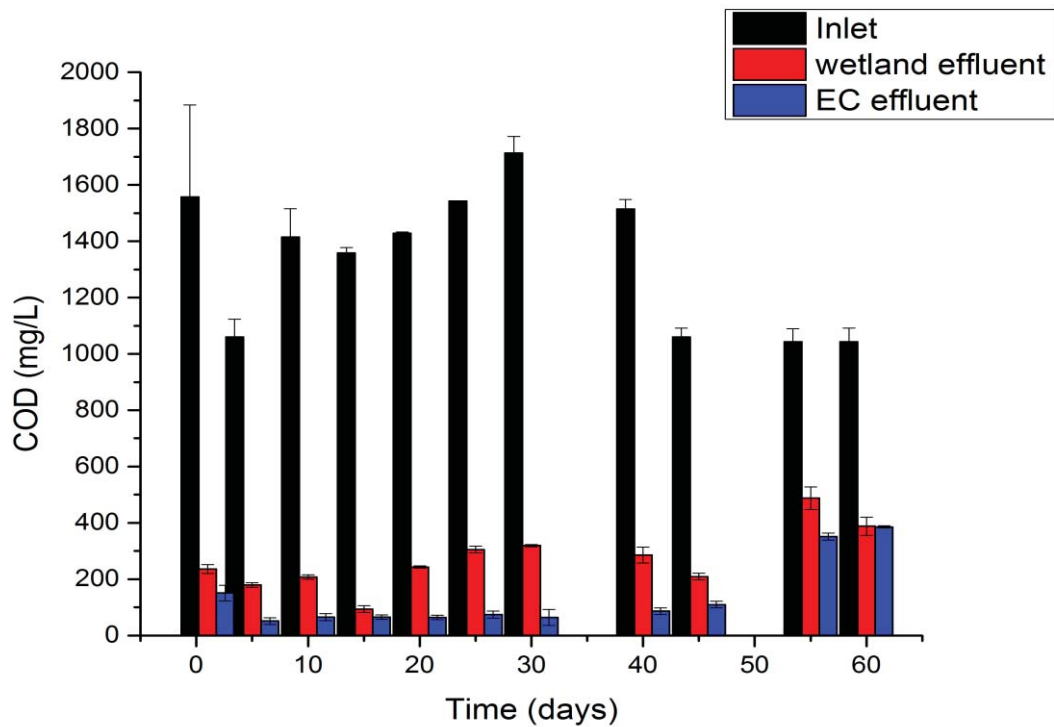


## Results and Discussion

Single household integrated system included vertical flow constructed wetland was introduced between septic tank and the electrochemical reactor to remove the organics from the septage. Average COD, TKN,  $\text{NH}_4\text{-N}$  and  $\text{PO}_4\text{-P}$  reduction by the constructed wetland over a trail period of 60 day was 73.84%, 46.74%, 83.94% and 93.11%. Average log reduction in coliform number after wetland passage was 0.556. Average COD, TKN,  $\text{NH}_4\text{-N}$  and  $\text{PO}_4\text{-P}$  reduction by the integrated system was 73.99%, 42.87%, 81.12% and 99.3%. Log reduction in coliform count was 5.8. Treatment rate, charge supplied and power consumption in EC was  $0.180 \text{ m}^3/\text{day}$ ,  $2400 \times 10^3 \text{ coulombs}/\text{m}^3$  and  $25.625 \text{ KWhr}/\text{m}^3/\text{day}$ . Community scale treatment system treating 100 people equivalent backwater ( $3 \text{ m}^3$ ) which was direct scale up of the hybrid single household scale treatment system showed similar percentage reductions of wastewater parameters. Average COD,  $\text{PO}_4\text{-P}$ ,  $\text{NH}_4\text{-N}$  and TKN reduction over a trail period of 60 day by constructed wetland was 78.94%, 77.31%, 58.20% and 29.73% while the average reduction by integrated system was found to be 88.76 %, 83.59 %, 69.80% and 36.13%. Log reduction in coliform count by VFCW and integrated system was 0.85 and 3.6. Treatment rate, charge supplied and power consumption was  $3 \text{ m}^3/\text{day}$ ,  $1152 \times 10^3 \text{ coulombs}/\text{m}^3$  and  $9.6 \text{ KWhr}/\text{m}^3/\text{day}$ .



a)



b)

Figure 1: COD of influents and effluents of Single household (a) and Community scale treatment system (b).

### References

- 1] National status of wastewater generation and treatment. 2016. Sulabh ENVIS.
- 2] Nayeem Showkat, 2016. Coverage of Sanitation Issues in India, SAGE open, 1-6.
- 3] Massoud et. al. 2009. "Decentralized approaches to wastewater treatment and management: Applicability in developing countries". Journal of environmental management, 90, 1, 652-659.
- 4] Volker Luederitz, Elke Eckert, Martina Lange-Weber, Andreas Lange, Richard M Gersberg, 2001. "Nutrient removal efficiency and resource economics of vertical flow and horizontal flow constructed wetlands", 18, 2, 157-171.
- 5] Korneel Rabaey and Willy Verstraete, 2005. "Microbial fuel cells: novel biotechnology for energy generation", TRENDS in Biotechnology, 23, 6.

## Reviewer Comments

Interesting paper for oral presentation

- The style of affiliation for laboratories appears in italics for one and in normal for the other. Thank you for standardizing. - Please use the same number of significant digits for the percentages or for the concentrations. - Besides, in the part results and discussion, is it really appropriate to put as many significant digits for percentages or high concentration values? - Please introduce the quotation of Figure 1 somewhere in the text. - References quoted in the introduction (Sulabh ENVIS, 2017; Nayeem Showkat, 2016) are not listed in the references. Moreover all the references at the end of the abstract are not quoted in the text. Please change.

# Stoichiometric life-cycle assessment for smart sewage treatment

Alvarado, V.<sup>1</sup>, Lam, C.M.<sup>1</sup>, Leng, L.<sup>1</sup>, Lee, P.H.<sup>1</sup>, Hsu, S.C.<sup>1</sup>

<sup>1</sup> Department of Civil and Environmental Engineering, The Hong Kong Polytechnic University

**Keywords:** Staged anaerobic fluidized membrane bioreactor, anammox, co-digestion, stoichiometry, life-cycle assessment

## Introduction

Climate change has constrained water grid systems; thus, the greenhouse gases (GHG) emissions from energy consumption and inherent to the treatment process have gained more attention from the international community. In response to the need for energy savings and reduction of GHG emissions in high density cities with limited space, some countries have developed on-site sewage treatment facilities for water reuse and resource recovery. These cutting-edge technologies for sewage treatment have been widely studied for design, operation and optimization. Yet, diverse comparison tools and specific-case approach have complicated the decision-making process to implement them.

The aim of this paper is to develop a stoichiometric life-cycle assessment (S-LCA) that provides a biochemical baseline for comparison between treatment and resource recovery technologies, to save both the time and costs of lab-scale tests. The stoichiometric framework is designed for comparing different treatment technologies for any specific sewage sample based on their chemical characterization, flows and concentrations. The technologies reviewed from a dominant biochemical pathway were activated sludge (AS), anaerobic digestion (AD), combined heat and power (CHP), dual fuel engine (DFE), and smart technologies such as staged anaerobic fluidized membrane bioreactor (SAF-MBR) and co-digestion (Co-D). The state-of-the-art technologies are characterized by their significant reduction of aeration due to their anaerobic/anoxic nature with lower retention times which reduce the reactors footprints. In addition, SAF-MBR produces methane (CH<sub>4</sub>) with potential for energy production; while Co-D enhances the carbon to nitrogen ratio for improved CH<sub>4</sub> yield. The S-LCA was used to evaluate the net environmental impact of the chosen technologies based on the sewage influent information from a sewage treatment works (STWs) in Hong Kong.

## Methodology

The stoichiometric life-cycle assessment (S-LCA) framework (Figure 1) used laboratory results to construct the specific empirical formula for microbial cells. Two sewage treatment works (STWs) configurations were studied. The business-as-usual (BAU) scenario consists of activated sludge (AS), anaerobic digestion (AD), and the use of combined heat and power (CHP) and dual fuel engine (DFE) for energy production (Tchobanoglous, et al., 2014). The scenario with smart sewage treatment technologies (S1) consists of a staged anaerobic fluidized membrane bioreactor (SAF-MBR) and co-digestion (Co-D). The SAF-MBR involves two reactors (Yoo, et al., 2012). The first reactor is an anaerobic fluidized-bed bioreactor (AFBR), followed by a fluidized-bed membrane bioreactor (F-MBR). Based on the different STWs configurations and the empirical formula, the general stoichiometric framework was developed based on the substrate partitioning and cellular framework established (Eq.1) in Rittmann & McCarty (2001).

$$R = f_e R_a + f_s R_c - R_d \quad (\text{Eq. 1})$$

where,  $f_e$  is the electron portion for energy generation,  $R_a$  is the electron-acceptor equation,  $f_s$  is the electron portion used for cell synthesis,  $R_c$  is the cell synthesis equation, and  $R_d$  is the electron-donor equation.

The stoichiometric results and the energy requirements of the technologies were integrated to the life-cycle inventory (LCI) in combination with the Ecoinvent database to develop the life-cycle impact assessment

(LCIA). The last step of the LCA provides an interpretation of the different scenarios evaluated from an environmental impact perspective.

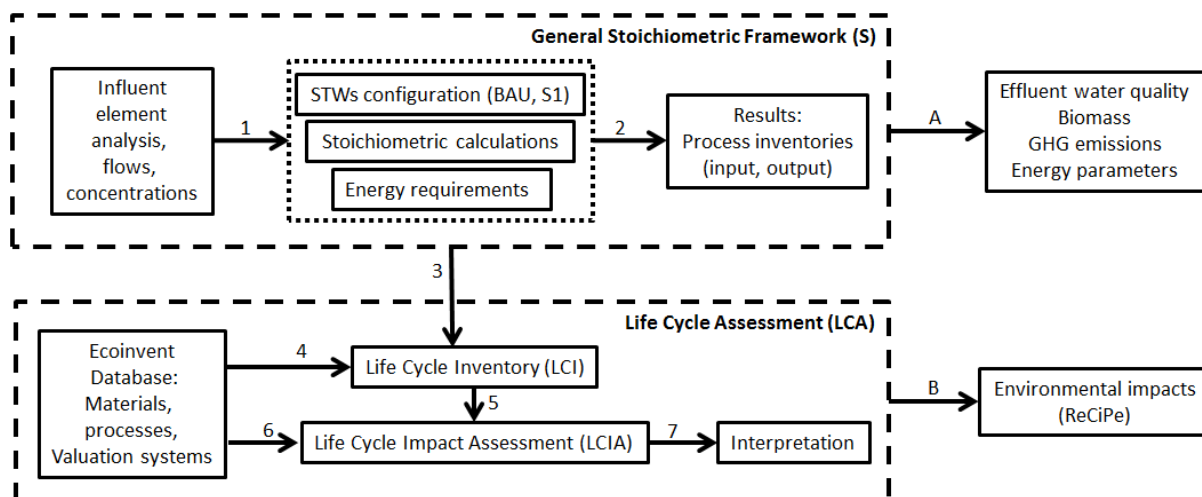


Figure 1. S-LCA framework modified from Bisinella de Faria, et al. (2015)

## Results and Discussion

The empirical data used to evaluate the Hong Kong STWs included the elemental analysis of the sewage sample, flows of two influent points, ammonium ( $\text{NH}_4^+$ ) and solids concentrations at the influent points, solids retention times, and the number of existing CHP and DFE. The preliminary results showed that: (i) the smart treatment technologies represent a reduction of up to 30% in the oxygen ( $\text{O}_2$ ) needed compared to the AS treatment, which saves energy for aeration and reduces carbon dioxide ( $\text{CO}_2$ ) indirect emissions from energy consumption (ii) the new technologies increase the  $\text{CO}_2$  direct emissions up to 6%, but recovers 50% more electricity than conventional systems, which represents reduced indirect  $\text{CO}_2$  emissions by electricity consumption avoided, (iii) the SAF-MBR doubles the methane ( $\text{CH}_4$ ) production for the S1, while the Co-D increase the  $\text{CH}_4$  yield production up to 30% compared to the sole-substrate AD, (iv) the effluent biomass and  $\text{NH}_4^+$  concentrations are higher for the new technologies compared to the conventional treatment, (v) the proposed S-LCA will account for the trade-off of both systems to obtain a comprehensive result on the environmental impact of the system, especially in the acidification and eutrophication categories.

## References

- Bisinella de Faria, A. B., Sperandio, M. Ahmadi, A., & Tiruta-barna, L. (2015). Evaluation of new alternatives in wastewater treatment plants based on dynamic modelling and life cycle assessment ( DM-LCA ). *Water Research*, 84, 99–111. <http://doi.org/10.1016/j.watres.2015.06.048>
- Rittmann, B. E., and McCarty, P. L. (2001). *Environmental Biotechnology: Principles and Applications*. McGraw-Hill.
- Tchobanoglous, G., Stensel, H. D., Tsuchihashi, R., and Burton, F. (2014). *Wastewater Engineering. Treatment and Resource Recovery* (5th ed.). METCALF & EDDY| AECOM.
- Yoo, R., Kim, J., McCarty, P. L., & Bae, J. (2012). Bioresource Technology Anaerobic treatment of municipal wastewater with a staged anaerobic fluidized membrane bioreactor ( SAF-MBR ) system. *Bioresource Technology*, 120, 133–139. <http://doi.org/10.1016/j.biortech.2012.06.028>

# Influence of pre-treatment on the attenuation performance of soil receiving on-site effluent

Ref # S2SMALL-24706

Knappe, J.<sup>1,2\*</sup>, Somlai-Haase, C.<sup>1</sup>, Fowler, A.C.<sup>2</sup>, Gill, L.W.<sup>1</sup>

<sup>1</sup> Department of Civil, Structural and Environmental Engineering, Trinity College Dublin, The University of Dublin, Dublin 2, Ireland

<sup>2</sup> MACSI, University of Limerick, Ireland

\* Presenting Author: [jan.knappe@tcd.ie](mailto:jan.knappe@tcd.ie)

**Keywords:** environmental sustainability, groundwater pollution, septic tank, soil treatment unit, unsaturated zone

## INTRODUCTION / MAIN METHIODES

With nearly 500,000 septic systems currently installed in Ireland, approximately one third of its domestic wastewater is treated on-site by means of a settling tank and/or packaged treatment plant (CSO, 2011) before being discharged into a soil treatment unit consisting of several percolation trenches. At the infiltrative surface, a biological clogging zone – also known as microbial biomat – forms over time, providing additional treatment and facilitating the required distribution of effluent over the entire percolation area (McKinley & Siegrist, 2011).

Previous research has indicated that the development of such a biomat along the base and wetted sides of the percolation trenches influences the hydraulic loading rate and subsequent attenuation of pollutants in the unsaturated zone. Irish studies on different subsoil permeabilities found higher nitrogen loading to the groundwater under percolation areas fed with secondary treated effluent compared to primary septic tank effluent, likely due to significantly reduced biomat formation (Gill *et al.*, 2009).

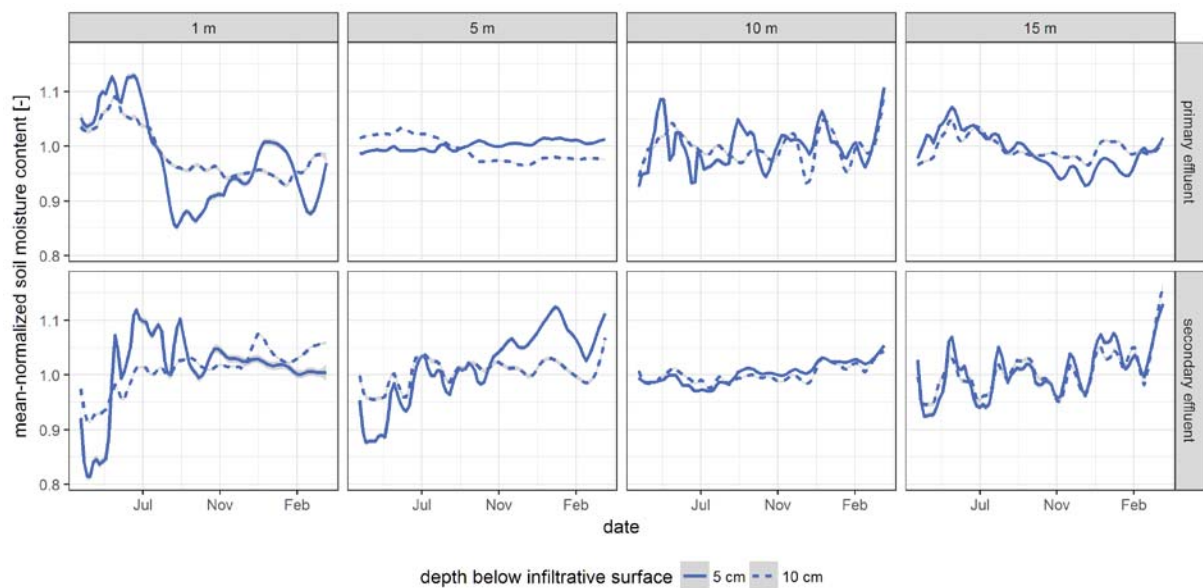
Based on experimental field studies, this study aims at developing effective mathematical models for describing the growth and interaction of soil biomass with nutrients and environmental factors as well as the contaminant transport and attenuation through the variably saturated soil within the percolation area (Winstanley & Fowler, 2013) in order to improve the understanding of the long-term environmental sustainability of septic systems, and will, in turn, contribute to a more insightful assessment of the cost-effectiveness of existing design guidelines and regulations.

Three field research sites have been set-up to treat the domestic effluent of individual households (2 to 4 PE) in rural Ireland. Following a conventional two-chamber septic tank, the partially treated wastewater is then split equally into two streams: (a) direct discharge of primary effluent into one half of the percolation area (two percolation trenches of 18 m length), and (b) further treatment in a packaged treatment unit (rotating biological contactor or coco peat filter) before being discharged into the other half of the percolation area (additional two percolation trenches of 18 m length). Meteorological data, wastewater flow, and moisture content, temperature and electric conductivity in the percolation area are continuously recorded on site and related to effluent quality data from soil moisture samples collected in suction cup lysimeters installed at various positions and depths in the percolation area.



## MAIN RESULTS AND CONCLUSIONS

The data from the three-dimensional sensor networks monitoring soil moisture conditions and chemical characteristics of the effluent plume within the soil treatment unit express distinct responses to hydraulic and organic loading patterns, and temporarily saturated conditions following heavy rainfall events both in areas receiving primary and secondary effluent, respectively (as indicated in Fig. 1). Additionally, greenhouse gas emissions resulting from microbial activity in the soil are quantified. The data from this study will be used to inform mathematical and computational finite elements models of the variably saturated zone beneath the infiltrative surface in order to simulate contaminant transport and attenuation, and assess the influence of pre-treatment on the overall performance of soil treatment units receiving on-site effluent to support more informed decision making in drafting guidelines and regulations for designing environmentally sustainable septic systems.



**Figure 1.** Mean-normalized soil water content over time in the soil treatment unit at 5 cm and 10 cm below the infiltrative surface and 1 m, 5 m, 10 m, and 15 m along the percolation trenches for primary and secondary effluent.

## REFERENCES

- CSO, 2011. This is Ireland - highlights from census 2011, part 1. Central Statistics Office. <http://www.cso.ie/en/census/census2011reports/census2011thisisirelandpart1/> (accessed 15 July 2017)
- Gill, L.W., O’Luanaigh, N., Johnston, P.M., Misstear, B.D.R., O’Súilleabháin, C., 2009. Nutrient loading on subsoils from on-site wastewater effluent, comparing septic tank and secondary treatment systems. *Water Research*, 43 (10), 2739-2749. doi: 10.1016/j.watres.2009.03.024
- McKinley, J.W., Siegrist, R.L., 2011. Soil Clogging Genesis in Soil Treatment Units Used for Onsite Wastewater Reclamation: A Review. *Crit Rev Environ Sci Technol*, 41 (24), 2186-2209. doi: 10.1080/10643389.2010.497445
- Winstanley, H.F., Fowler, A.C., 2013. Biomat Development in Soil Treatment Units for On-site Wastewater Treatment. *Bull Math Biol*. 75, 1985-2001. doi: 10.1007/s11538-013-9881-y

# **Real-time-monitoring of water quality parameters to identify of the origin and the pathways of impacts in small and middle scale rivers**

Angelika M. Meyer, Horst P. Beck

Institute of Inorganic and Analytical Chemistry Saarland University. Zeile 5 Saarbruecken, Germany

## **Keywords**

Diffuse and point sources, mobile stations, online measurements, pollution pathways, sensors, wet chemical analysers

## **Abstract**

The quality standards of surface waters increase steadily bearing new challenges for water policy. For any management activities in a catchment, it is of particular importance to know the origin and pathways of the various impacts in a catchment area very precisely. Especially in small and middle scale catchments, online measurements with high time resolution are particularly suited for this purpose. In this paper a concept of mobile measuring stations is presented, in which sensors and wet chemical analyzers are combined to provide data of various parameters allowing the identification of pollution situations in a river. Some examples of impacts from diffuse and point sources are given to illustrate the high information density realised by the system.

## **Introduction**

As a consequence of the demands of the EU-Water Framework Directive (WFD), the status of small and middle scale rivers was more intensively put into focus. In order to assess different impacts on a river and thus its status it is very useful to evaluate both pollution sources and transport pathways in a combined approach (see e.g. LEONE ET AL 2008). Especially in smaller catchments real time monitoring using online measurements with high temporal resolution is very suitable for this purpose because of the intensive dynamic and high reaction rate of small rivers impacts and their effects become apparent immediately and distinctively. Online measurements allow to depict the real quality status of a river and to detect short-term events as well as long lasting changes.

Up to now, numerous kinds of online monitoring systems were realised. Most of them are designed to analyse special issues such as the estimation of nutrient fluxes (see e.g. SHORE ET AL 2017; MELLANDER ET AL 2012), assessment of the ecological status (see e.g. DESMET ET AL 2011) or detection of domestic wastewater impacts (see e.g. BOËNNE ET AL 2014). The better part of the studies are based on the use of in-situ sensors (see e.g. GLASGOW ET AL 2004; O'FLYNN ET AL 2010; UNGUREANU ET AL 2010; JIANG ET AL 2009). However, more elaborated devices like wet chemical analyzers are rarely used because of high investment and maintenance costs.

In the Saarland (Germany) mobile measuring stations equipped with both sensors and wet chemical analyzers have been operated since many years. In this context, different parameter combinations in high time resolution turned out to be a very useful tool for the identification as well as the assessment of impacts in small and middle scale rivers.

The purpose of this paper is to present the potential of this system for water quality monitoring. In order to illustrate this approach, a few examples of impacts from point sources and from diffuse (or non-point) sources are presented in the following.

## Methods

The Saarland is the smallest German Federal State and located at the French and Luxembourgian border in the West. Because of its situation in a low mountain range area there are numerous small and middle scale rivers. The Saarland has a very high population density (387 people per km<sup>2</sup>), and the region is characterized by intensive agricultural and industrial activities. Of course this generally creates a high environmental pressure. Especially for the surface waters a number of conflicts of interest exist considering different aspects such as drinking water supply, waste water discharge, transport, fishery, agricultural irrigation, recreation, tourism and many more.

In order to monitor most of these surface waters and to identify those factors endangering the water quality several mobile measuring stations were developed as mobile trailers (l: 6.1 m, w: 2.1 m, h: 2.8 m) which can be installed on site nearby the river. The water is transported by a pump submerged in the river into a sample basin in the station from where the overflow is drained back into the river by an outlet on the opposite side (see fig. 1). Measuring devices for oxygen (O<sub>2</sub>), temperature, pH value, conductivity, turbidity and nitrate (in fact total oxidized nitrogen, NO<sub>3</sub> and NO<sub>2</sub>) are immersed into this basin. In addition three wet chemical analysers (self-calibrating online-photometers) are installed in the station to measure ammonia (NH<sub>4</sub>), TOC (total organic carbon) and total phosphorous (TP: unfiltered and digested) and total reactive phosphorous (TRP: unfiltered and undigested). For the determination of ammonia the water is pulled through a filter, for TOC and TP / TRP the sample first passes an ultrasonic homogenisation unit (see fig. 1). Thus the actual water quality can be analysed automatically in a 5 to 10 minutes frequency. The collected data are stored in a data logger from where they are transferred to a central computer via GSM and stored in a database.

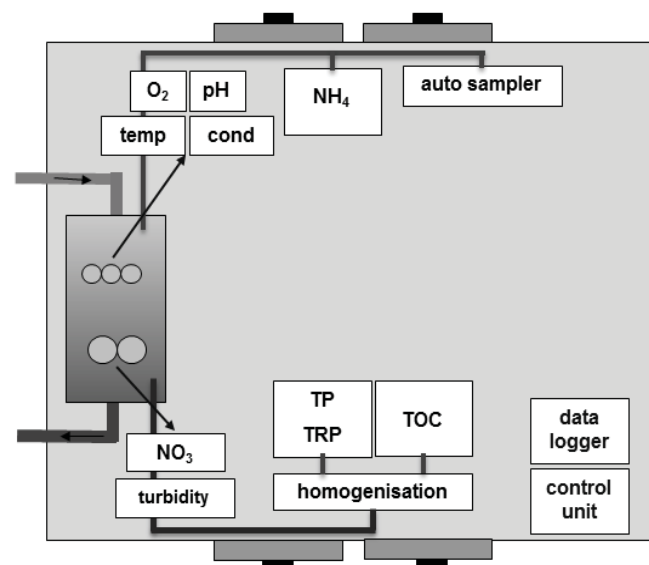


Figure 1: Scheme of a measuring station with sensors in the sample basin (left side) and wet chemical analyzers for NH<sub>4</sub>, TOC, TRP and TP

The pump and all measuring devices are cleaned and maintained at least once a week, at the same time control samples are taken from the river and in the sample basin and analysed at the home lab to ensure the quality of the continuous data. To evaluate and especially to interpret the data, all available information about the catchment such as geological and hydrogeological characteristics, land use, domestic and industrial wastewater

discharges, data of other monitoring programmes (e.g. by the state office or by local water companies) are taken into consideration. All representative climatic data and river discharge data which are indispensable for the data treatment and interpretation are delivered from the Saarland Agency for Environmental Protection and Customers Safety (LUA).

Thus regarding different parameter combinations over various time periods allows drawing conclusions about the pollution's origin and intensity. To this the data sets always have to be combined with water amount and precipitation values.

Up to now we have run three large stations and two smaller ones (without photometric devices), one of them with solar power supply (see also KHALID ET AL 2016). The stations are very flexible considering spatial as well as methodological aspects and can easily be adapted to different requirements and applied to various investigation issues. The rivers which are to be monitored, as well as measuring sites and time periods are decided on in intensive discussion with the Saarland Environmental Ministry (MUV) and the agencies in charge. Any site chosen has to be accessible by car, for operation and maintenance of the station a power supply (1 x 400 V or 2 x 220 V each) is required. Depending on investigation issues and significance of the water body one measuring period can last between 6 months and 1.5 years.

## **Results and discussion**

One of the most important demands of the WFD is the so called "combined approach for point and diffuse sources" set out in Article 10. According to this article, all EU-Member States are requested to ensure the control of all discharges emitted in the rivers based on best available techniques. This claim can often not be realised by simple grab sampling.

### **Diffuse pollution**

According to the European Environment Agency (EEA 2017) "agriculture is a key source of diffuse pollution" and its control can only be realised by help of continuous measurements on a high frequency. In agricultural catchments, nitrate, TOC and phosphorous are the relevant parameters which can actually be detected online. The knowledge of quantity and pathways of the diffuse impacts of these three substances will also point to other potential contaminants (for pesticides e.g. see CRUZEIRO ET AL 2016).

#### **Impacts via surface runoff**

Diffuse pollution triggered by rainfalls on agricultural areas is very often dominated by erosion effects leading to increasing turbidity values. Different substances such as phosphorous brought out in synthetic and natural fertilisers are bound to these turbidity causing particles which are transported via surface runoff. Depending on the soil characteristics the portion of phosphorous being dissolved or adsorbed on particles can differ.

Figure 2 shows an example of several consecutive erosion events in the river Blies in Reinheim in the Saarland in spring season. One can see that with every increase of turbidity the concentration of TP rises accordingly. Thus particle bound phosphorous (which is calculated as the difference between dissolved TRP and TP) make up most of the TP amount. The concentration of TRP stagnates or is even diluted during these events.

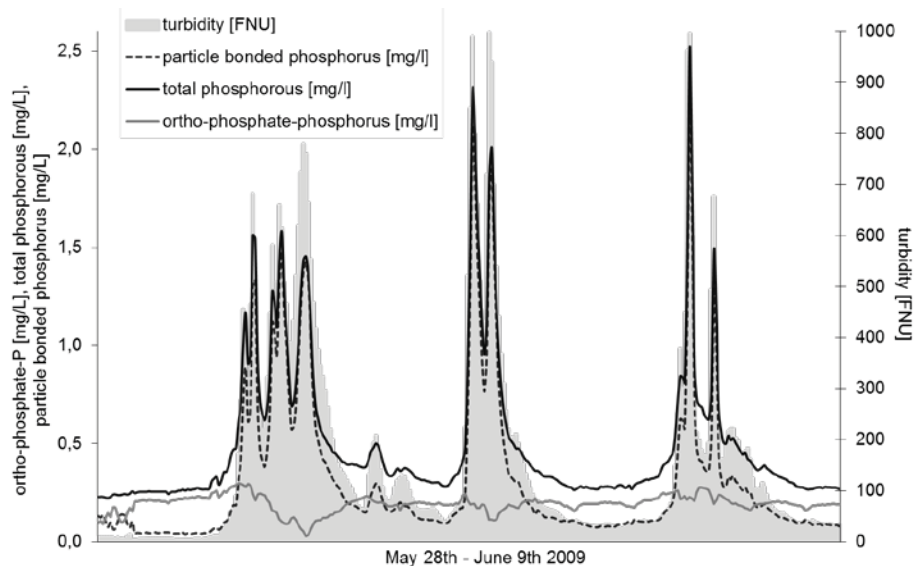


Figure 2: Impacts of particle bounded P and increase of turbidity caused by surface runoff in river Blies (Reinheim) (May 28<sup>th</sup> – June 9<sup>th</sup> 2009)

In most cases these phenomena occur during the autumn season after harvesting. In numerous agricultural catchments we could define such P impacts during stormflow events as the most important source for P pressures (cf. for instance SHORE ET AL (2017) who observed higher P concentrations during low-water discharge than during stormflow).

#### Impacts via interflow

In most agricultural catchments diffuse sources are the main impact sources for nitrate. Surplus nitrate from fertilizers applied on the fields is dissolved in rain water. In many cases the water infiltrates the unsaturated soil zone (interflow), and dissolved nitrate is laterally transported through the soil before the water again exfiltrates into the surface water. This transportation process results in a time lag between the maximum of river discharge and the maximum of nitrate concentration. Figure 3 illustrates an example of several interflow events in the agricultural catchment of the river Seffersbach in the Saarland. In this catchment two measuring stations were installed: one in the upstream area of the river (station 1 in Bachem) and the other one close to the mouth into the river Saar (station 2 in Merzig). In both stations basic concentrations of nitrate were about 3.5 mg/L and were diluted during rainfalls. With declining river discharge the nitrate contents in the upstream area of the river immediately, however, nitrate contents in the downstream area jumped to very high maximum values. There is an obvious time lag between the river discharge maxima and the concentration maxima at station 2 caused by the interflow transport of nitrate in this area.

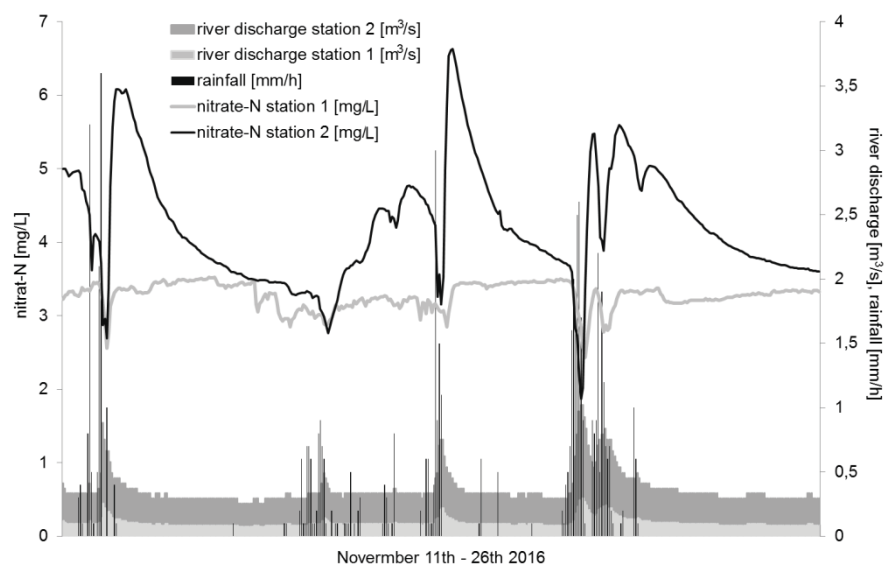


Figure 3: Dilution and impacts of nitrate in two measuring stations at river Seffersbach (Bachem – station 1, Merzig – station 2) (November 11<sup>th</sup> – 6<sup>th</sup> 2016) (rainfalls are marked as thin lines)

In groundwater-fed agricultural catchments these phenomena are rarely seen.

### Point source pollution

Continuous measurements also serve to identify point source pollution. Not only short time events can reliably be detected by them. Medium term observations can also help to identify different impacts and their pathways.

#### Impacts from waste water treatment plants (WWTPs)

Impacts of domestic and industrial treatment plants can be detected very well especially during dry weather periods. In order to estimate these impacts, the loads of different substances can be analysed in high temporal resolution in addition to the concentrations irrespectively of any weather conditions. In figure 4a concentrations of TRP and TP are shown during a dry weather period with declining river discharge in river Ill in Eppelborn. In this period the concentrations of both TRP and TP increase constantly. When plotting the loads of these two substances for the same time period (see figure 4b) one can see that loads almost stagnate around 0.25 kg/h for TP and 0.2 kg/h for ortho-phosphate-P. So it can be concluded that these loads represent the basic amounts emitted by the treatment plants in this catchment.

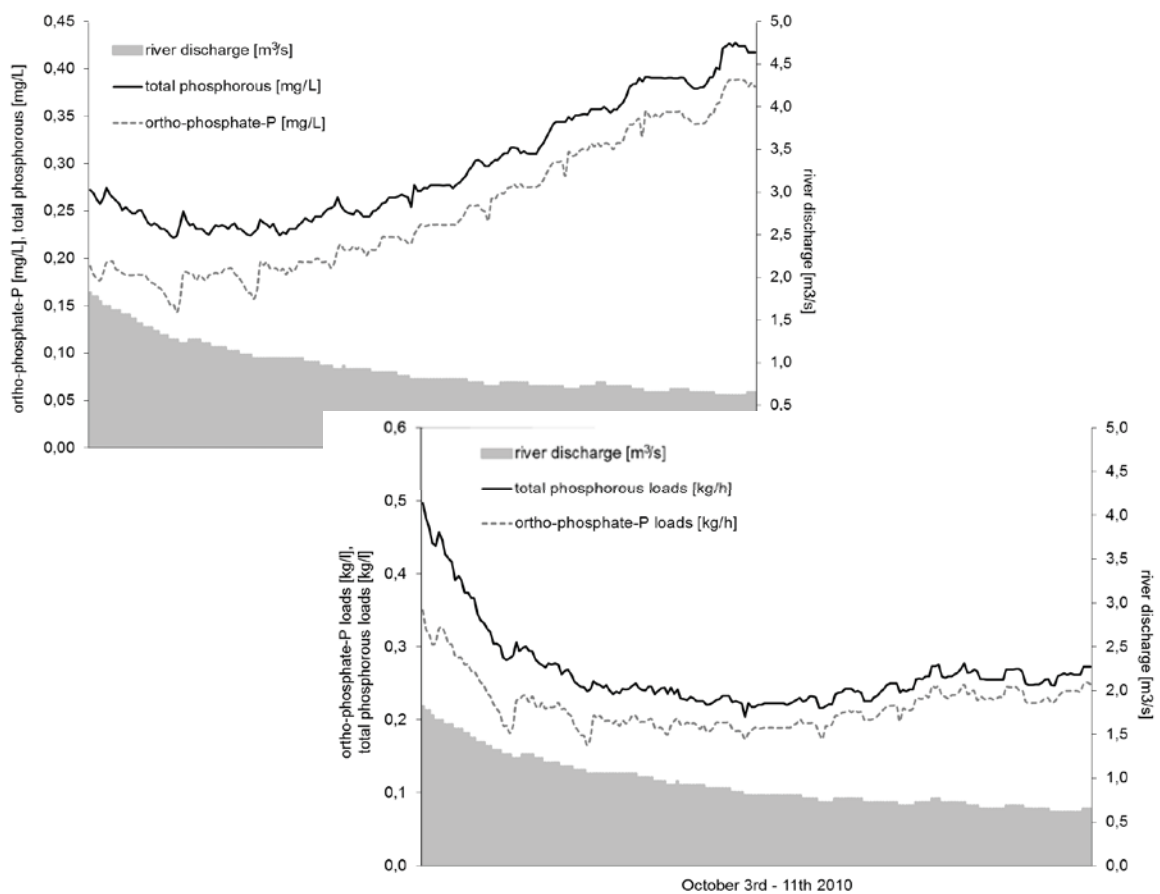


Figure 4a: Concentrations and b: loads of TP and ortho-phosphate-P during a dry weather period in river Ill (Eppelborn). (October 4<sup>th</sup> - 11<sup>th</sup> 2010)



## Impacts from CSOs

One of the most pressing problems in many urban or settlement areas are incidents caused by combined sewer overflows (CSOs). During rainfalls these discharges can occur very suddenly when surface flows exceed the capacities of channels and treatment plants. Even though these events normally only last few hours, they cause harmful hydraulic stress and pollution impacts. While grab sampling is unsuitable to detect and to qualify especially such incidents, numerous strategies have been tested for doing so by using different aspects of continuous measurements (see e.g. BOËNNE ET AL 2014).

The effects of a CSO's discharge are shown in figure 5, giving an example of two events in river the Bist in Wadgassen. During the first incident, ammonia concentrations rose to 1.97 mg/L NH<sub>4</sub>-N and TOC concentrations to 14.6 mg/L leading to a 56 hours lasting reduction in dissolved oxygen (< 7 mg/L O<sub>2</sub>) in the river. The smaller events did not affect the oxygen content so much. It must be noted that such low NH<sub>4</sub>-concentrations cannot be monitored by other measuring methods like e.g. ion sensitive sensors (ISE) (see also e.g. BOËNNE ET AL 2014).

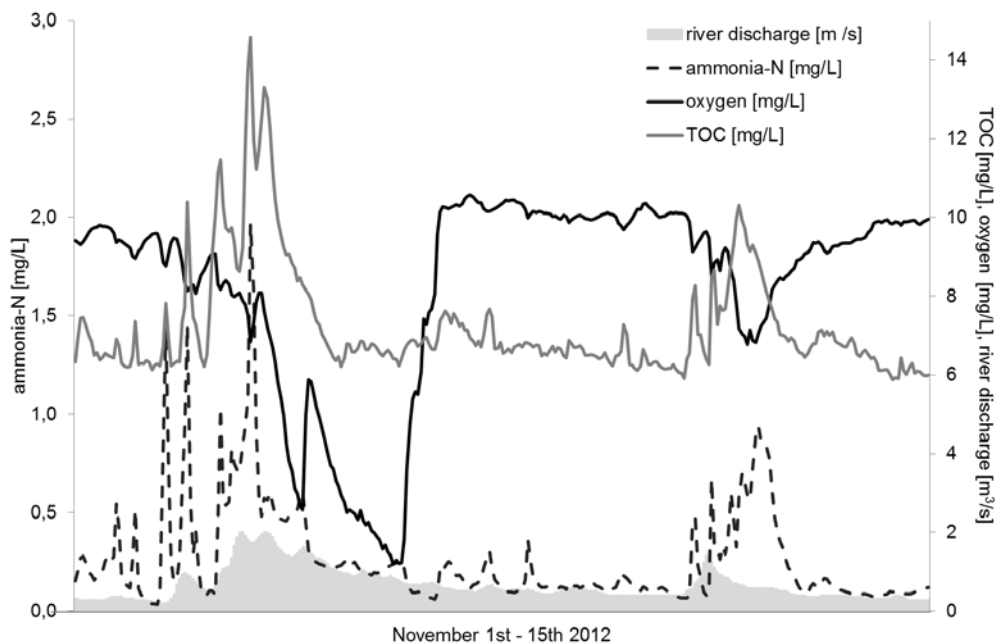


Figure 5: Raising concentrations of ammonia-N and TOC and oxygen reduction caused by impacts from a COS in the river Bist (Wadgassen) (November 1<sup>st</sup> - 15<sup>th</sup> 2012)

Online measurements can also help to detect impact duration, discharge frequency and loads of each CSO. Similar observations are also reported by e.g. by FU & BUTLER 2012.

## Parameter combinations

For the interpretation of continuous measurements it is essential to look at various combinations of different parameters at the same time in order to identify sources and pathways of pollution (see also e.g. ANGULO ET AL 2012). This should be applied for short term events as well as for mid-term or even long term periods. A look at the correlation between different parameters helps to better understand the situation in the river. To give an example, a low mathematical correlation factor of TRP and T is a strong indication for agricultural impacts (as shown in figure 2). In contrast a high correlation between TRP and ammonia is significant for discharges of domestic wastewater. Figure 6 gives an example for such a correlation for a nearly six month's period at river Seffersbach in Merzig. (It must be

mentioned that some of the ammonia values were beyond the detection limit of the analyser (2 mg/L) and could thus not be measured correctly. Otherwise the correlation coefficient would have been even higher.)

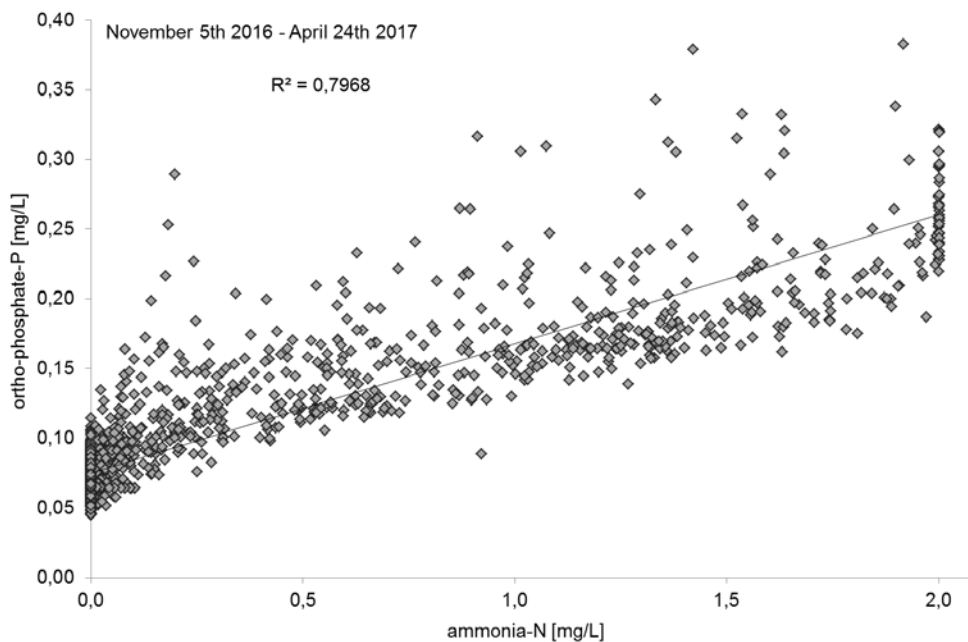


Figure 6: High correlations between ortho-phosphate-P concentrations and ammonia-N concentrations in the river Seffersbach (Merzig). (November 5<sup>th</sup> 2016 – April 24<sup>th</sup> 2017)

## Conclusions

To this day the mobile measuring stations have been operated at 38 sites monitoring 27 different small and middle scale rivers all over the Saarland. The real-time measurements give a clear picture of the situation at all times and they allow more than the control of threshold values. Due to the combination of sensors and wet chemical analyzers a number of different parameters can be measured reliably. A detailed study of these data together with their diverse correlations over various time scales allows us to draw very general conclusions as well as catchment- or site-specific ones. Thereby the entire number of impacts, their origin and emission pathways into the river as well as the geological background and other natural characteristics can be identified and described.

It has to be underlined that the system presented in this paper turned out to be a very useful tool to provide relevant information for all stakeholders involved in integrated catchment management. The results enable authorities to plan and take effective measures to improve the water quality and to support and control the implementation of the European Water Framework Directive and other demands of water management, especially in small and middle scale catchments.

## Acknowledgments

This study is financed by the Ministry of Environment and Consumer Protection of Saarland State.

## References

- Angulo, C., Cabestany, J., Rodríguez, P., Batlle, M., González, A., de Campos, S. (2012) Fuzzy expert system for the detection of episodes of poor water quality through continuous measurement. *Expert Systems with Applications* 39, 1011–1020
- Boëne, W., Desmet, N., Van Looya, S., Seuntjens, P. (2014) Use of online water quality monitoring for assessing the effects of WWTP overflows in rivers. *Environ. Sci.: Processes Impacts* 16, 1510–1518
- Cruzeiro, C., Rocha, E., Pardal, M.A., Rocha, M.J. (2016) Seasonal-spatial survey of pesticides in the most significant estuary of the Iberian Peninsula - the Tagus River estuary. *Journal of Cleaner Production* 126, 419-427
- Desmet, N.J.S., Van Belleghem, S., Seuntjens, P., Bouma, T.J., Buis, K., Meire, P. (2011) Quantification of the impact of macrophytes on oxygen dynamics and nitrogen retention in a vegetated lowland river. *Physics and Chemistry of the Earth* 36, 479–489
- European Environment Agency, Diffuse sources (2017) URL: <https://www.eea.europa.eu/themes/water/water-pollution/diffuse-sources>
- O'Flynn, B., Regan, F., Lawlor, A., Wallace, J., Torres, J., O'Mathuna, C. (2010) Experiences and recommendations in deploying a real-time, water quality monitoring system. *Meas. Sci. Technol.* 21, 124004 (10pp)
- Fu G., Butler D. (2012) Frequency analysis of river water quality using integrated urban wastewater models. *Water Science and Technology* 65 (12), 2112-2117
- Glasgow, H.B., Burkholder, J.M., Reed, R.E., Lewitus, A.J., Kleinman, J.E. (2004) Real-time remote monitoring of water quality: a review of current applications, and advancements in sensor, telemetry, and computing technologies. *Journal of Experimental Marine Biology and Ecology* 300, 409– 448
- Jiang, P., Xia, H., He, Z., Wang, Z. (2009) Design of a Water Environment Monitoring System Based on Wireless Sensor Networks. *Sensors* 9, 6411-6434
- Khalid, R.R., Meyer, A., Meiers, J., Beck, H.P., Frey, G. (2016) Predictive Power Management for a Solar-Powered Off-Grid Surface Water Quality Monitoring System. 11th IEEE Conference on Industrial Electronics and Applications (ICIEA 2016) Hefei, China
- Leone, A., Ripa, M.N., Boccia, L., Lo Porto, A. (2008) Phosphorus export from agricultural land: a simple approach. *biosystems engineering* 101, 270-280
- Mellander, P.-E., Melland, A. R., Jordan, P., Wall, D.P., Murphy, P.N.C., Shortle, G. (2012) Quantifying nutrient transfer pathways in agricultural catchments using high temporal resolution data. *Environmental Science and Policy* 24, 44-57
- Shore, M., Murphy, S., Mellander, P.-E., Shortle, G., Melland, A.R., Crockford, L., O'Flaherty, V., Williams, L., Morgan, G., Jordan, P. (2017) Influence of stormflow and baseflow phosphorus pressures on stream ecology in agricultural catchments. *Science of the Total Environment* 590–591, 469–483
- Ungureanu, F., Lupu, R.G., Stan, A., Craciun, I., Teodosiu, C. (2010) Towards Real Time Monitoring of Water Quality in River Basins. *Environmental Engineering and Management Journal* 9, 9, 1267-1274

# Chemical fingerprinting of on-site wastewater effluent contamination of small rivers and wells in Ireland

Ref # S2SMALL-46679

L.Gill<sup>1\*</sup>, C. Fennell<sup>1</sup>, L. Brophy<sup>1</sup>, D. Dubber<sup>1</sup>, D. O'Connell<sup>1</sup>, B. Misstear<sup>1</sup>

<sup>1</sup> Dept. Civil, Structural and Environmental Engineering, Trinity College Dublin, Ireland

\* Corresponding Author: laurence.gill@tcd.ie

**Abstract:** no more than 200 words briefly specifying the aims of the work, the main results obtained, and the conclusions drawn. Citations must not be included in the Abstract.

**Keywords:** on-site wastewater, septic tank, low permeability, tracers.

## INTRODUCTION / MAIN METHODS

The domestic wastewater of approximately one third of the population in Ireland, ~500 000 dwellings, is treated by on-site domestic wastewater treatment systems (DWTS) of which more than 87% are septic tanks (CSO 2016). The potential impacts of such on-site effluent are the pollution of either groundwater and / or surface water. If the effluent loading on the subsoil is too high, the permeability of the subsoil excessive or there is an insufficient depth of subsoil then the groundwater beneath a percolation area is at risk of pollution, in particular from microbiological pathogens and / or nutrients. Alternatively, if there is insufficient permeability in the subsoil to take the effluent load, surface ponding may occur with associated health risks, and there will be a risk of effluent discharge / runoff of pollutants to surface water and also wells.

Recent research has highlighted the potential for DWTS to act as a source of pollution to surface waters (Arnscheidt et al. 2007; Withers et al. 2007; Deal 2012), particularly in terms of phosphorus (P) loading. Low baseflow during dry periods and ecologically sensitive seasons means that chronic P inputs to small headwater (low order) streams become more significant due to reduced dilution capacity (Jarvie et al. 2008). Equally, studies of private wells in Ireland and elsewhere have shown a significant proportion to be contaminated, with sources of microbial contamination known to include DWTS, as well as practices associated with intensive agricultural production. While the microbial quality of private well water is commonly assessed using faecal indicator bacteria (FIB), such as *E. coli*, FIB are not source-specific, and provide no information as to the origin of the contamination, making remedial actions challenging. This research has therefore applied and evaluated a range of chemical fingerprinting techniques in an attempt to identify a robust method for apportioning contamination of surface waters and private wells to a specific source.

Four suitable study catchments were selected based on a list of priority characteristics. The aim was to identify small catchments (<10 km<sup>2</sup>) in areas with high likelihood of inadequate percolation to ground and with a high density of DWTS. Instrumentation was installed at the upstream and downstream of the clusters of DWTS sites in all study catchments to measure conductivity, temperature and water levels continuously. Furthermore weather stations at both upstream sites recorded meteorological data for the catchments. Water quality monitoring was performed over a 1-year period capturing periods of baseflow as well as storm events.

For the assessment of well contamination, 212 Irish households that depend on both private wells and DWTS (mainly septic tanks) were selected and evaluated by site assessment surveys. Approximately half of the wells were located in the catchments being monitored for

surface water quality (as discussed) whilst the other half were in areas of Extreme groundwater vulnerability. One-off water quality monitoring was carried out on all wells and a subset of 24 was then chosen for monthly sampling for a period of 12 months.

All water quality samples were also analysed for prospective tracers of human effluent which included: FIB, ionic ratios, fluorescent whitening compounds (FWCs), faecal sterol profiles, artificial sweeteners, caffeine and 5 different pharmaceuticals

## MAIN RESULTS AND CONCLUSIONS

With respect to private well contamination, the once-off sampling of the 212 selected wells found that 15% were contaminated with *E. coli*. Subsequent monitoring of 24 selected wells found 45% to be contaminated with *E. coli* at least once. The application of fingerprinting techniques to these monitored wells found that ionic ratio analysis, specifically the use of chloride/bromide and potassium/sodium ratios, to be a useful low cost fingerprinting technique capable of identify impacts from human wastewater and organic agricultural contamination respectively. The artificial sweetener acesulfame was detected on several occasions in a number of monitored wells, suggesting its conservative nature and potential use as fingerprinting technique for human wastewater. However, FWCs, faecal sterols and caffeine were not detected in any wells, suggesting low suitability.

With respect to the surface water contamination, sterol profiles and the presence of FWCs indicated impacted sites by the discharge of septic tank effluent which was supported by other microbial source tracking methods. FWCs discharged into rivers by DWTS could be detected during low flow conditions and where septic tank effluents have a high contribution to the river flow, although the fluorometric detection limits for FWCs in river water did depend on organic matter content. A recommended tired approach for surface water was devised to first sample upstream and downstream of a suspected source of contamination for ammonia and *E. coli*. If there is a significant difference, then FWC analysis should be carried out which will determine the proximity of pollution. If further confirmation is needed, following a detailed site survey, then more specific analysis of caffeine, sweeteners, and/or pharmaceutical compounds could be carried out, moving finally onto faecal sterols

## REFERENCES

- Arnscheidt J., Jordan P., Li S., McCormick S., McFaul R., McGrogan H.J., Neal M. & Sims JT. 2007 Determining the sources of low-flow Phosphorus in complex catchment. *Science of the Total Environment*, **382**, 1–13.
- Central Statistics Office 2016 *Census 2016, Principal Demographic Results*; Central Statistics Office, Government of Ireland, Stationery Office: Dublin, Ireland, 2017.
- Deal N. 2012 Nutrient emissions to water from septic tank systems in rural catchments: Uncertainties and Implications for policy. *Environmental Science and Policy*, **24**, 71 – 81.
- Jarvie H.P., Withers P.J.A., Hodgkinson R., Bates A., Neal M., Wickham H.D., Harman S.A. & Armstrong L. 2008 Influence of rural landuse on streamwater nutrients and their ecological significance. *Journal of Hydrology*, **350**, 166-186.
- Withers P.J.A., Jarvie, H.P. & Stoate C. 2011 Quantifying the impact of septic tank systems on eutrophication risk in rural headwaters. *Environment International*, **37**, 644-653.

**Aquavalens special sessions**

**14:00-18:00**

**Developments in the microbial monitoring of small water supplies:  
A series of linked talks from 7 Researchers in this EU FP7 funded research**

Chair: Ricardo Santos - Instituto Superior Tecnico

**Protecting the health of Europeans by improving methods for the detection of pathogens in drinking water and water used in food preparation. How to better assess risk and control safety in water supplies**

Robert Pitchers - WRC plc

**Small water systems across Europe: overview and technical approach**

Ricardo Santos - Instituto Superior Tecnico

**Integrated Stand-alone Treatment Stations: a solutions for microbiological problems in Small Water Systems**

Ana Pereira - Enkrott, S.A.

**Microbiological quality of small water supplies across Europe: can we trust the traditional indicators?**

Silvia Monteiro - Instituto Superior Tecnico

**Do AQUAVALENS analytical methods meet the expectations of both the users of the technologies and water consumers? Talk based on large water and small water users**

Alma López-Avilés - University of Surrey

**Epidemiological studies of health risks associated with small drinking water supplies**

Paul Hunter - University of East Anglia

**Water safety plans in small water supplies. Using a WSP to safeguard water in rural communities of less than 5,000 inhabitants**

Maria Gunnarsdottir - University of Iceland



## **NANTES – WP11 Summary of presentations – 11 Oct 2017 version**

Robert Pitchers, WRC, UK

### **Aquavalens - Protecting the health of Europeans by improving methods for the detection of pathogens in drinking water and water used in food preparation**

This presentation will introduce the AQUAVALENS project which has brought together SMEs, Industries, Universities and Research Institutes with the aim of protecting the health of European Citizens from exposure to waterborne pathogens through drinking water and water used in food processing. We have developed sustainable technologies to enable water system managers whether in large or small water systems or within food growers or manufacturers to better assess the risk and improve control of the safety of their water supplies.

Ricardo Santos, Instituto Superior Técnico, Portugal

### **Small water systems across Europe: overview and technical approach**

This presentation will describe the different scenarios of small water systems across different European countries. Different local conditions and constraints will lead to different sampling and options being chosen in these systems. This talk will give an outline of the objectives, sampling, and solutions uses by Aquavalens for Small Water Systems.

Ana Pereira, Enkrott, Portugal

### **Small Systems integrated and stand-alone water microbiological treatment, monitoring and sampling solutions**

This talk will focus on how Integrated Stand-alone Treatment Stations can be a solution for the promotion of a better microbiological water quality among the populations using Small Systems. The approach described combines the water treatment, with monitoring of critical parameters (like turbidity), which are triggers for automatic sampling and for the implementation of preventive countermeasures.

Silvia Monteiro, Instituto Superior Técnico, Portugal

**Microbiological quality in small water supplies: are the traditional indicators enough?**

One third of the population in Europe do not receive their water from strictly controlled large water companies, depending instead on small water systems. The water quality of these small systems is very often problematic because undertrained personnel manage them and have little access to funding. Therefore, higher levels of indicator bacteria are often associated with small water systems. The work developed within Aquavalens in small water systems will provide us with a better knowledge of the water quality in Eastern, North and South Europe. We will present the results of the microbial water quality testing done in small water supplies. This covers traditional indicators, and also the analysis of enteric viruses (Norovirus GI and GII, Hepatitis A and E viruses, and Enteroviruses), protozoa (*Cryptosporidium* spp. and *Giardia* spp.) and *Campylobacter coli* and *jejuni*. The usefulness of pathogen detection will also be discussed.

Alma López-Avilés, University of Surrey, UK

**Do AQUAVALENS analytical methods meet the perception and expectations of both the users of the technologies and water consumers?**

This talk presents results from the analysis of data collected via two questionnaires distributed to: 1) users of AQUAVALENS technologies in Portugal, Scotland, Ireland, Spain and Serbia; and 2) users of small water supplies in Portugal, Scotland and Serbia. In Scotland, residents connected to 'mains' water supplies were also surveyed for comparison.

Paul R Hunter, East Anglia University, UK

**Epidemiological studies of health risks associated with small drinking water supplies.**

It is well known that small water supplies are more likely to be contaminated with indicator bacteria than larger supplies and this is especially the case for very small supplies providing water to just a few households. In these very small supplies, indicator bacteria can be present in very high concentrations. However, epidemiological evidence of disease is sparse as is the evidence on the presence of specific pathogens. This presentation will review the

epidemiological evidence of adverse human health effects in people consuming unsatisfactory drinking water from small water supplies. This review will cover evidence from reports of outbreaks and from prospective cohort studies.

María J. Gunnarsdóttir, University of Iceland, Iceland

### **Water safety plans in small water supplies**

To deal with challenges to water safety the water sector is addressing the problem by using systematic preventive management called a Water Safety Plan (WSP). This approach is now widely practiced globally and is used in over 90 countries. In many countries it is also applied in small supplies. Many studies have shown that non-compliance of drinking water quality is much higher in small water supplies than in large ones and waterborne disease outbreaks are more common in the small supplies. Hence there is a need for action to improve risk assessment and risk management in small supplies. Iceland has implemented the WSP approach in many small system and it has been demonstrated to improve both water quality and public health as well as management of the system. At least 23 small towns with less than 5000 inhabitants have a WSP in place. A number of small towns worked together on the implementation process and it has been shown to be beneficial for three communities. It is also seen as a great advantage to have “approved water” when attracting enterprises to the towns as having safe water is a prerequisite for much commercial activity and especially for all food production. The improved and tested Aquavalens molecular methods of detecting waterborne pathogens quickly and effectively as well as on-line water testing will support WSP implementation and operation in the water sector as a whole. These methods have also the potential to support good risk management in small supplies and thereby improve public health.

**Keynotes 3**

**08:00-09:30**

Session chair: Guenter LANGERGRABER

**INV903 - Small wastewater treatment plant in France: what have constructed wetlands changed?**

MOLLE Pascal - *Irstea, France*

**INV902 - How resource recovery and energy efficient technologies should be deployed in the cities? Small or big?**

SPERANDIO Mathieu - *Toulouse University, France*

**INV906 - Decentralized Systems Engineering Course Delivery in U.S. Higher Education - Past, Present and Future**

SIEGRIST Robert - *Colorado School of Mines, USA*

**Parallel session 7 - Nitrogen treatment and recovery 1**

**09:50-11:10**

Session chair: Johannes Kisser

**300 - The use of different types of zeolite and scoria as filtration and treatment media in small wastewater treatment systems**

KELE Ben - *Central Queensland University and Arris Pty Ltd*

**501 - Performance of a continuous-flow single stage deammonification system with mesh separated compartments**

WEISSENBACHER Norbert - *University of Natural Resources and Life Sciences, Vienna*

**278 - Intelligent control for ammonia compliance in small works receiving variable loads, a case study**

BLANCO Ivan - *Severn Trent Water*

**707 - Optimal Selective pressures to achieve partial nitrification in continuously fed activated sludge reactors**

EUSEBI Anna Laura - *Università Politecnica delle Marche*

**Parallel session 8 - Nitrogen treatment and recovery 2**

**11:30-12:50**

Session chair: Mathieu Sperandio

**308 - Denitrifying Downflow Hanging Sponge (DDHS) reactors reduce total nitrogen and antibiotic resistance genes for decentralized wastewater treatment applications**

BUNCE Joshua - *MR JT BUNCE*

**474 - Combined Ion Exchange and Biological Nitrogen Removal in a Novel Two-stage Biofiltration system**

RODRIGUEZ-GONZALEZ Laura - *University of South Florida*

**298 - Two-Step Denitrification with Elemental Sulfur: Kinetic Tests and Dynamic Mathematical Modeling**

KOSTRYTSIA Anastasiia - *University of Cassino and Southern Lazio*

**465 - Nitrogen removal in single chambered batch fed microbial electrolysis cell (MEC) operated with combined landfill leachate and dairy wastewater**

YOGALAKSHMI K N - *Central University of Punjab*

Keynote speaker:  
MOLLE Pascal, Irstea, France

Bio:

Pascal Molle, Senior Researcher at Irstea (France), MSc in environmental engineering and a PhD in chemical engineering for wastewater treatment, with 19 years of experience in the development of eco-technological systems for the wastewater treatment for small and medium size communities, sludge treatment and storm waters. Molle oversees the research for waste water treatment for small and medium size communities. He created and is leading a French national group on the evaluation of new treatment processes for small communities ([www.epnac.irstea.fr](http://www.epnac.irstea.fr)) involving all French public institutions implied in sanitation issues. His research focuses on the development and optimization of processes of treatment wetlands for different kind of influent (domestic WW, sludge, storm waters) and climate conditions (tropical, mountain areas). Using a specific research platform (REFLET) dedicated to treatment wetlands, and full scale experiments, research has been devoted to improve performances (phosphorus, nitrogen ...) intensify systems (compactness), develop associations of conventional systems with treatment wetlands and modeling design tools. He's driving research and expertise to develop sustainable treatment systems in French outermost tropical islands and southern countries (Morocco, Tunisia, Costa Rica ...). His research includes knowing water and nutrient reuse objectives. He is the author of more than 100 scientific publications dealing with wastewater treatment.



# Technological evolution of wastewater treatment plant for small communities in France: what constructed wetlands have changed

MOLLE Pascal, Irstea

With 31,772 communities below 2,000 habitants, France had to implement many small wastewater treatment plants (WWTP) over the last decades. These communities' sizes represent around 25 % of the population. Around 20,000 treatment plants are in operation for capacities below 2,000 p.e. The technologies applied are mainly dominated by 3 processes as activated sludge, waste stabilization ponds and constructed wetlands (around 20 % of small WWTP each one). Others classical technologies are in operation as well nowadays like trickling filters (around 7 %), rotating disks, biofilters and sand filters (around 2 % each one).

The actual distribution of treatment plant technologies does not reflect the evolution of applied technologies over time. Forced by regulation, small communities had to implement treatment system from the 70s, starting from the biggest capacities, with a real push from the late 80s. Since 2010, WWTP implementation for small communities represents mainly retrofitting of old systems. During these decades, technologies and knowledge evolved resulting in different technologies waves. If in the 70s activated sludge were mainly implemented, due to maintenance difficulties for small communities (and sludge losses), waste stabilization ponds and sand filters became the main technologies to be applied below 2,000 p.e. and especially for the smallest ones. Nevertheless, these two last technologies were not totally satisfactory.

Despite precise rules for sand quality sand filters suffered from clogging due to bad sand choice quality or unstable performances of primary treatments (basically septic or Imhoff tanks). Waste stabilization ponds were conformed to expected performances but became less attractive due to their foot print (11 m<sup>2</sup>/p.e. under French climate) as well as their incapacity to fulfil a more stringent regulation. Both technologies led to specific research programs to i) retrofit sand filters systems, ii) improve water quality from waste stabilization ponds (TSS, BOD<sub>5</sub> and ammonia).

At the end of the 90s, beginning 2000, a new technology started to be implemented after some research works done by Irstea (formerly Cemagref): Constructed wetlands French style. They consist in two stages of vertical flow treatment wetlands. The first stage treats sludge and wastewater in a single step. Each stage contains alternately operated cells. In the first stage, sludge treatment, partial removal of organic matter and nitrification takes place. In the second stage, final organic matter removal and nitrification occurs. The treated sludge from the first stage collects at a rate of approximately two to three cm per year when the system is operated at design load. The deposit layer must be removed once it reaches a depth of 20 cm, which in practice, generally is every 10 to 15 years. This technology known a big success in France and became the main technology implemented for small communities since 2005. The success comes from a robust and reliable aerobic treatment, an easy sludge management as well as a good acceptance from communities thanks to their green aspect.

From this success, researches started to focus on the main disadvantages of the system: how to treat total nitrogen, phosphorus and reduce the footprint? As well, researches tried to better define the limits of the technology regards to cold climate, acceptance of storm events and organic overloads. These researches allowed increasing the development of treatment wetlands in France. As a consequence, treatment wetlands became a first-choice technology for small communities and many specialized companies developed. The technology has been widely implemented using only wetlands systems or associated with conventional technologies (trickling systems, rotating disks).

Nowadays, researches focus on applying treatment wetlands in some extreme conditions defined by very low footprint, high treatment levels (for instance micro pollutants or pathogen) and high loads variations. In such conditions, intensified treatment wetlands appear to be a, interesting technology that could increase their domain of application while allowing stable and reliable performances.



Keynote speaker:

SPERANDIO Mathieu, Toulouse University, France

Bio:

Mathieu SPERANDIO is Professor at Toulouse University, in Chemical Engineering department of INSA of Toulouse, in France. He holds a PhD in chemical engineering in 1998. He is leading a research group at laboratory LISBP, in biosystems engineering. He has 20 year research experience dedicated to sustainable technologies for wastewater treatment and nutrient recovery, including optimization and modelling aspects. He managed recent research programs on granular sludge systems, anammox process, phosphorus recovery and nitrous oxide emissions. He is a member of the management board of IWA specialist group on Nutrient Removal and Recovery. He is currently supporting and coordinating innovative R&D programs with public-private partnerships in France, for developing and demonstrating new management strategies in wastewater field.



# How resource recovery and energy efficient technologies should be deployed in the cities? Small or big?

SPERANDIO Mathieu, Toulouse University, France

Up to now wastewater treatment has been developed with a centralized vision mainly for preserving public health in our developed countries. But wastewater management has now to consider new challenges: recovery of nutrients, water, and energy. The conversion of wastewater treatment plants (WWTP) into water resource recovery facilities (WRRF) is now needed but can be complex and costly, because of multiple constraints: wastewater dilution, low flexibility of existing facilities, and low discharge limits. Source separation approach could offer a new solution in urban area with differentiated collection and treatment for black, grey or yellow water. Between fully centralized or fully decentralized treatment, technologies can be declined at different scales as soon as optimal threshold would be found based on technical, environmental and economical assessments. From construction field the demand for innovative water solutions that address technical issues in a cost-effective way is now growing. Recent experience on recovery techniques and energy saving technologies as well as development of integrative modelling will help us to compare wastewater management scenarios, promoting eco-conception and helping decision makers in future water smart cities.

Keynote speaker:

SIEGRIST Robert, Colorado School of Mines, USA

**Bio:**

**Robert L. Siegrist, PhD, PE, BCEE** is University Professor Emeritus of Environmental Science and Engineering at the Colorado School of Mines and also a Professor of Civil and Environmental Engineering. He is the former Director of the Environmental Science and Engineering Division at CSM and founding Director of the Small Flows Program. Before joining CSM in 1995, Prof. Siegrist held academic and research positions with the University of Wisconsin, Norwegian Institute for Georesources and Pollution Research, Ayres Associates Inc., and Oak Ridge National Laboratory. He earned his BS (High Honors) and MS in Civil Engineering and his PhD in Environmental Engineering at the University of Wisconsin where he conducted research within the Small Scale Waste Management Project. Prof. Siegrist is an internationally recognized expert in decentralized water reclamation and in situ remediation of contaminated land. During his 40-year career he has published over 300 technical papers and 3 books and was awarded 2 patents. His new textbook, **Decentralized Water Reclamation Engineering**, was just published by Springer ([www.springer.com/us/book/9783319404714](http://www.springer.com/us/book/9783319404714)). He has given invited keynote lectures at more than 100 workshops and conferences in more than 30 countries worldwide. He has also served as a science and engineering advisor to private and government agencies and organizations in the United States and abroad and has been a Fellow with the NATO Committee for Challenges to Modern Society.



Contact information:

Robert L. Siegrist, PhD, PE, BCEE  
University Professor Emeritus of Environmental Science and Engineering  
Research Professor, Civil and Environmental Engineering  
Colorado School of Mines, Golden, Colorado USA 80401  
2770 Iliff Street, Boulder, Colorado USA 80305  
Email: [siegrist@mines.edu](mailto:siegrist@mines.edu) Cell phone: 303.359.8427

# Decentralized Systems Engineering Course Delivery in U.S. Higher Education – Past, Present and Future

**R.L. Siegrist**

Colorado School of Mines, Department of Civil and Environmental Engineering, Golden, Colorado 80401-1887, USA. [siegrist@mines.edu](mailto:siegrist@mines.edu)

**Abstract:** For nearly a generation now, the virtues and benefits of decentralized systems for water supply and sanitation have been widely recognized and approaches, devices, and technologies have been advocated as critical components for a sustainable 21<sup>st</sup> Century. Yet, the principles and practices of modern decentralized systems have not been broadly incorporated into curriculum within U.S. higher education. The vast majority of undergraduate and graduate students have not had access to semester-long courses focused on decentralized systems that serve as electives or required courses for juniors/seniors and graduate students. To date, only a few universities have been successful in developing semester-long courses that have been sustainably delivered. For example, an engineering course was developed and has been delivered for more than a decade at the Colorado School of Mines and a textbook, slide set and solutions manual were recently published. This paper describes past and present activities and outcomes related to higher education concerning decentralized wastewater systems engineering and highlights lessons learned. It also describes potential impediments that need to be overcome to enhance course development and delivery across a greater number of universities in the United States and potentially elsewhere.

**Keywords:** Onsite and decentralized wastewater systems, water reclamation and reuse

## INTRODUCTION

In the United States, systems for water supply and sanitation evolved during the 20<sup>th</sup> Century in response to a growing recognition that providing safe drinking water and adequate treatment of wastewaters were needed to protect public health and preserve water quality. During this evolution there was always a mix of 1) onsite systems serving individual homes and businesses in rural and peri-urban areas, 2) decentralized systems serving suburban residential and mixed-use developments, and 3) large to very large centralized systems serving densely populated urban areas. However, the relative proportion of the U.S. population and development served by the different system types has varied and evolved over time. With respect to sanitation, by the end of the 20<sup>th</sup> Century about 25% of the U.S. population was served by onsite and decentralized wastewater systems (hereafter referred to collectively as decentralized systems) and approximately 35% of new development was being supported by such systems. This amounted to roughly 25 million existing systems with about 200,000 new systems being installed each year.

Near the end of the 20<sup>th</sup> Century and into the 21<sup>st</sup>, a series of activities and events in the United States helped catalyze a reevaluation of how systems for water supply and sanitation could be made more sustainable and what role decentralized systems might play (USEPA 1997, WERF 1999, Siegrist 2001, Tchobanoglous 2002, Daigger 2008, WERF 2009). There was growing interest in how decentralized systems could contribute to sustainability by: 1) reducing the use of drinking water to flush toilets and transport waste to centralized treatment plants, 2) preventing pollutant discharges from collection system sewer overflows and leaking pipes, 3) recharging water near the point of water extraction and avoiding water export and depletion of local water resources, 4) enabling recovery and reuse of wastewater resources including water, organic matter, nutrients and energy, 5) lowering consumption of energy and

chemicals, and reducing greenhouse gas emissions, and 6) providing systems that would be more robust and resilient to natural disasters and climate change. There was also a growing awareness that decentralized systems were critical to providing safe drinking water and adequate sanitation in developing regions of the world.

During this period there was also a growing recognition in the United States that the capabilities of 21<sup>st</sup> Century decentralized systems should not be judged based on the performance of older 20<sup>th</sup> Century systems. The older systems (e.g., cesspools, seepage pits, leachfields, septic systems) were typically designed to be simple and cheap methods of wastewater disposal. During the latter decades of the 20<sup>th</sup> Century, increased water use and wastewater generation and more widespread use of disposal-based systems in a growing suburban America, contributed to occurrences of hydraulic malfunctions, groundwater contamination, and surface water quality deterioration. To properly distinguish and refer to these older disposal-based systems, they became known as ‘legacy systems’. In contrast to the legacy systems, modern decentralized systems can be designed for effective treatment as well as resource conservation and recovery.

Based on major research and development efforts over the past two decades or more, modern decentralized systems have evolved to include a growing array of approaches, devices and technologies (Figs. 1 and 2) that can be used to serve buildings and developments with design flows of less than 0.40 to 400 m<sup>3</sup>/day or more. Common and emerging applications within the United States include one or more of the following purposes: 1) to provide effective wastewater treatment for homes and businesses in rural and peri-urban areas and residential, commercial and mixed-use developments in suburban areas, 2) to provide effective wastewater treatment for buildings and developments while also producing a reclaimed water for nonpotable reuse purposes such as toilet flushing or irrigation, 3) to recover valuable wastewater resources including nutrients, organic matter, and energy, and 4) to earn points for a green building or sustainability rating through the low impact water and wastewater management options enabled by decentralized systems.

Given the evolution of decentralized system approaches, devices, and technologies in the United States, it is necessary and appropriate to question if and how curriculum in higher education has evolved to help educate undergraduate and graduate students who have or will become design professionals and decision makers of the future. This paper describes past and present activities and outcomes in higher education focused on decentralized systems engineering and it highlights lessons learned. Potential impediments to course delivery at more universities are presented along with recommendations to enhance future course development and sustained delivery within higher education. While the focus of this paper is on U.S. higher education the information presented is potentially relevant to other countries.

## **COURSE DELIVERY IN U.S. HIGHER EDUCATION – PAST AND PRESENT**

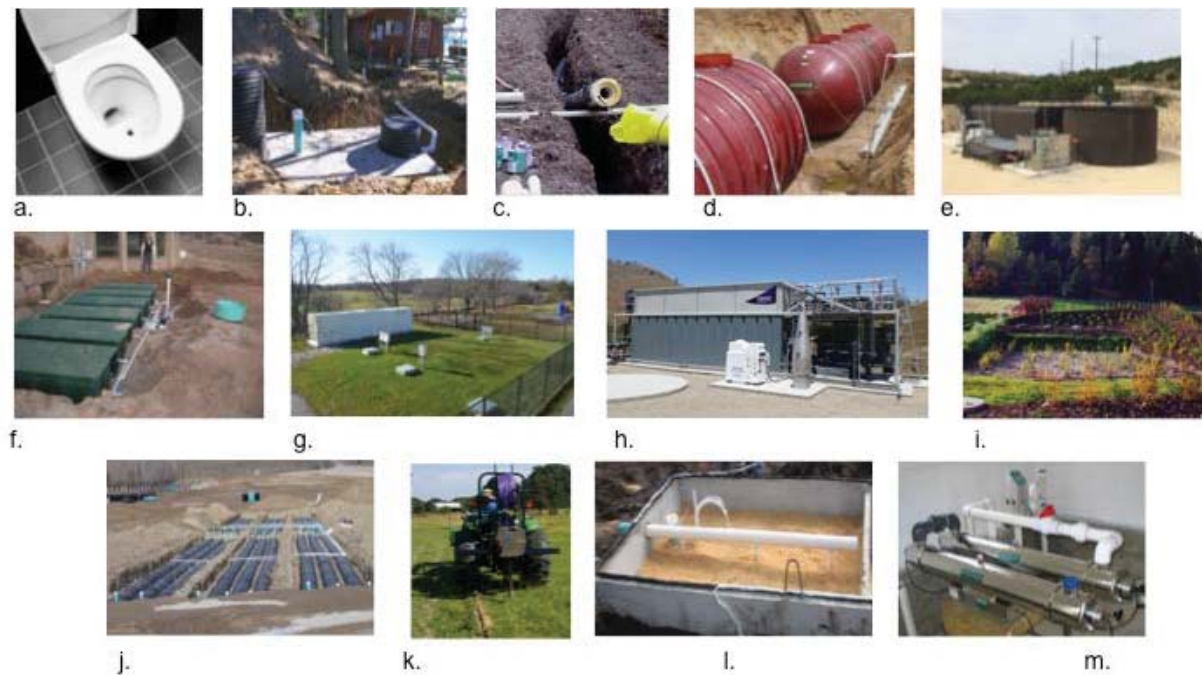
During the 20<sup>th</sup> Century, in U.S. higher education the curriculum concerning wastewater systems engineering was predominantly focused on the design and operation of wastewater collection systems and centralized treatment plants for cities and other urbanized areas. Education concerned with decentralized systems was also available but to a very much lesser extent, particularly within higher education (Table 1). In some respects this is not surprising since Federal research and educational funding was focused on centralized wastewater systems and that is where jobs and careers were most widely available for university graduates.

Recognizing the need for enhanced education and training, the Consortium of Institutions for Decentralized Wastewater Treatment (CIDWT) carried out a project during the early 2000s to

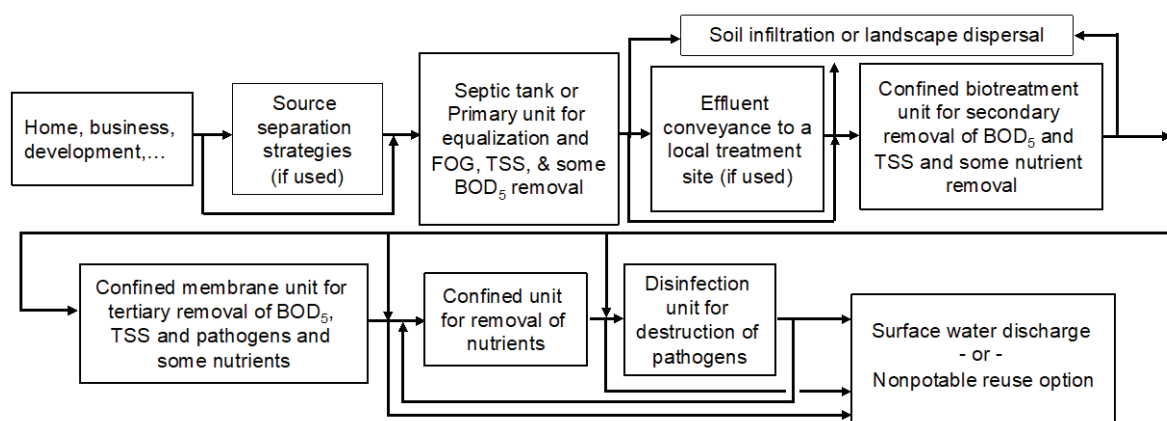


develop educational materials, including modules to support university curriculum (Gross et al. 2005, CIDWT 2014). The target audience included 3<sup>rd</sup>- and 4<sup>th</sup>-year engineering students. The materials developed did facilitate delivery of one or more modules within current course offerings and provided a starting point for development of a stand-alone course.

To get an impression of how higher education has evolved into the 21<sup>st</sup> Century, Siegrist (2014) completed a survey of faculty at 27 universities across the United States to determine the number of universities delivering a semester-long course focused on decentralized systems engineering as an elective or requirement in one or more degree programs. A summary of the results of that survey is presented here while details may be found in Siegrist (2014).



**Fig. 1.** Examples of decentralized system components: a. urine diverting toilet, b. septic tank and pump vault, c. small diameter sewer, d. primary settling and recirculation fiberglass tanks, e. aerobic treatment unit, f. recirculating textile media biofilters, g. recirculating foam filter in a shipping container, h. membrane bioreactor, i. subsurface flow constructed wetland, j. chamber-equipped subsurface soil treatment unit, k. landscape drip dispersal unit, l. denitrifying wood chip biofilter, m. ultraviolet light disinfection unit (Siegrist 2017).



**Fig. 2.** Generalized sequence of strategies and unit operations that could be used to configure one or more viable decentralized systems for a particular project (Siegrist 2017).



Table 1. Highlights of current U.S. higher education concerned with decentralized systems.

Activity	Description
Education and training of practitioners and regulators and potentially students	Professional organizations and universities offer short courses and training sessions. For example, the National Association of Wastewater Technicians (NAWT) provides installer training, operation and maintenance training, and inspector training and certification. The National Onsite Wastewater Recycling Association (NOWRA) and state organizations, often affiliated with NOWRA offer annual conferences and education and training in these areas. Universities also offer continuing education courses for practitioners and regulators (e.g., Univ. of Minnesota, Univ. of Rhode Island, North Carolina State Univ.) and in some cases students can sit in on a course.
Education of university students outside of a course	Outside of a stand-alone course, university-level education occurs through student research experiences and attendance at seminars, guest lectures, short courses, and conferences. Relevant educational experiences also occur through senior design projects and participation in projects sponsored by Engineers Without Borders or other organizations.
Education of university students in a stand-alone course	Siegrist (2014) conducted a survey of faculty at 27 U.S. universities and reported that many universities had some aspect of their undergraduate and graduate curriculum that addressed decentralized systems. However, of the 27 universities surveyed, only a few had sustained delivery of a stand-alone course focused on decentralized systems (e.g., Colorado School of Mines, Univ. of Wisconsin, Univ. of Washington, Univ. of Arizona).

Today many U.S. universities have some aspect of their undergraduate and graduate curriculum that addresses decentralized systems. This typically involves mentoring of students involved in research or delivery of one or several lectures on topical areas of interest to a faculty member within other undergraduate or graduate courses (e.g., within courses on water supply and wastewater treatment). In a few cases, lectures on decentralized water and wastewater systems have been delivered in courses within specialty programs (e.g., a Water and Sanitation for Health (WASH) program). Some students also receive relevant education through projects sponsored by Engineers Without Borders (EWB) or other aid organizations.

At a few universities serious efforts have been made during the past decade to develop new courses focused on decentralized systems. In some cases course development was started but for various reasons, the course did not get fully developed and established and never became a routine offering (e.g., Michigan State University). In some cases a course was developed and approved for routine delivery, but after it was delivered once or a few times, it was no longer offered (University of Arkansas, University of Tennessee). This was often the result of the faculty member responsible for the course having to deal with other demands or because he/she left the university. At a number of universities, a faculty member has had an interest in developing a course but has not yet had the time or resources to do so.

A few universities have developed and sustained stand-alone courses focused on decentralized systems. These courses are generally offered within Agricultural and Biosystems Engineering (ABE) or Civil and Environmental Engineering (CEE) although they are often cross-listed in other departments (e.g., Soil Science, Natural Resources Science, Water Resources Management). Some courses are delivered through classroom lectures complemented by laboratory or field sessions (e.g., Colorado School of Mines (CSM), University of Wisconsin, University of Washington) while others are delivered as online courses (e.g., University of Arizona). Courses that are housed in engineering departments or programs generally satisfy ABET criteria (ABET = Accreditation Board for Engineering and Technology).

Developing a semester-long course focused on modern decentralized systems, which would be successfully and sustainably delivered is a necessary and appropriate goal for higher education in the United States and elsewhere. However to achieve this goal it can take a major effort under the right circumstances. To illustrate the process and level of effort involved, this

section describes a course that was developed by Prof. R.L. Siegrist (author) at the Colorado School of Mines in Golden, Colorado. This semester-long course was developed as an extension of the Small Flows Program, a research program focused on advancing the science and technology of decentralized systems (Siegrist et al. 2013). This course has been offered every year for the past 12 years and some of the lessons learned are summarized in Table 2.

The course at CSM was developed over several years and offered for the first time during the spring semester of 2006 as a ‘special topics’ course within the Environmental Science and Engineering Division (ESE). The course number and name were *ESGN498A–Onsite Wastewater Reclamation and Reuse* and it was offered as a 3-credit course available to juniors and seniors as well as graduate students. The course was scheduled with 75-min classroom periods on Tuesday and Thursday afternoons during a 17-wk spring semester and 9 students enrolled. The course was offered again during the spring semesters of 2007 and 2008 under the same circumstances and 7 and 15 students enrolled, respectively. During the first three deliveries the course was very well received and in early 2008 it was officially approved by CSM for continued delivery as *ESGN460–Onsite Water Reclamation and Reuse*. Since 2009 the course has been offered at least once each academic year and enrollments have ranged from 15 to 30 students with roughly 1/3 of those being graduate students and 2/3 being junior and senior undergraduate students. Due to a university reorganization where ESE was merged with Civil Engineering to form a new Department of Civil and Environmental Engineering (CEE), the course was renumbered as CEEN472 for spring 2014. During the 2015 academic year, another faculty member took over course delivery. The course continues to be an elective within several CSM degree programs including: Environmental Engineering Science (EES), CEE, Hydrologic Science and Engineering (HSE), and Humanitarian Engineering (HE). CEEN472 course outcomes have been mapped against ABET (a) through (k) outcomes.

While the breadth and depth of coverage has evolved, the course has remained focused on the engineering of decentralized systems for rural and urban settings that can achieve effective wastewater treatment as well as resource conservation and recovery goals. Topics covered include: decentralized system selection and planning, contemporary water use and wastewater generation, water use efficiency and waste stream source separation, alternative collection and conveyance, treatment using tank-based units (septic tanks and anaerobic units, aerobic units and biofilters, membrane bioreactors) and natural landscape units (constructed wetlands, subsurface infiltration, landscape drip dispersal), treatment for nutrients and pathogens, and management of process solids, sludges and residuals. To aid course delivery a set of slides and notes were prepared and along with other reference materials and these were made available to students enrolled in the class. These course materials evolved and were used as the basis for a textbook, *Decentralized Water Reclamation Engineering*, which was published in 2017 (including a downloadable set of slides and a problem solutions manual) (Siegrist 2017). Learning has typically been assessed through five design problems, two examinations, and a class project (which includes a written report and oral presentation). Students normally complete the design problems and class project in teams of 2 to 4 students each but the exams are completed individually.

## **COURSE DELIVERY IN U.S. HIGHER EDUCATION – FUTURE?**

It is likely that educational activities will continue in U.S. higher education consistent with the nature and extent of past efforts and activities (Table 1). However, it is uncertain how many U.S. universities will begin to offer courses that are focused on decentralized systems engineering and where the courses are electives or requirements for one or more degree programs. Expanding the number of universities offering successful courses is essential to realizing the potential benefits of decentralized systems in the United States and elsewhere.

Table 2. Observations and lessons learned based on a decade of delivery of a semester-long course on decentralized systems engineering at CSM (after Siegrist 2014).

Area	Observations, lessons learned and recommendations
University and department context and fit	An interested faculty member needs to consider the mission of the department and its degree programs, and how a new course focused on onsite and decentralized systems could “fit in” to areas of emphasis or concentration.
Faculty lead	An inspired faculty member needs to champion the course, develop it and get it approved, and deliver it several times to help establish it as a needed and valued course offering. A faculty member or group that has an active research program in areas relevant to onsite and decentralized systems can greatly enable development and delivery of a well-received and well-enrolled course. Early on, a 2 <sup>nd</sup> or 3 <sup>rd</sup> faculty member should become engaged in supporting and delivering the course. Adjunct faculty can also make valuable contributions.
Course purpose and scope	A stand-alone course can cover different aspects of onsite and decentralized systems that are targeted for the U.S. and similar industrialized nations, but also have wide applicability in the developing world. The scope should cover key topics spanning the source character and modification, treatment unit operations, and selection and design of resource-efficient recovery/reuse approaches and systems. In my view, a course should be an engineering design course and go beyond a conceptual description of approaches and technologies to one of engineering principles and processes and system selection and design. In general a course worth 3-credits is reasonable and appropriate.
Regulatory issues	System selection and design covered in the course should not be unduly constrained by current regulations and requirements, though students should be informed about the role they play in real-life projects. Students should be made aware of prescriptive vs. performance-based design.
Course title and mode of delivery	A course title should be carefully developed to reflect contemporary and future issues and concerns and to stimulate faculty and student interest in the course and its content. Depending on course purpose and scope, the mode of delivery needs to be determined. There are pros and cons to classroom versus online delivery modes.
Target audience and enrollment	A mix of juniors and seniors plus graduate students seems to work well. Students pursuing degrees in many disciplines in science and engineering can contribute to, and benefit from, an onsite and decentralized systems course. An optimum enrollment seems to be in the range of 15 to 25 students.
Pre-requisites	Students need to have an introduction to environmental science and engineering that covers the basics of environmental chemistry and biology, mass balances, water supply and water and waste treatment technologies. Due to time limitations, basic science and engineering subjects cannot be covered during a course focused on engineering of onsite and decentralized systems.
Credible and rigorous delivery	The course materials and delivery should be commensurate with the intellect and creativity of the students enrolled and on par with other science and engineering courses offered at a similar level. Terminology matters and precise and consistent use is important across the different topics covered. Introducing unit process and design equations as well as modeling tools is important to convey the degree of understanding and rigor underlying the subject. Educating students on when and how to acquire necessary and appropriate information (including parameter estimation) that enables system selection and design is very important.
Guest lectures and field trips	Guest lectures by practitioners and design professionals are almost always well received by students and help reinforce material covered in class as well as enlighten students about the complexities of real-world projects. Field trips to operating systems are good but have certain logistical and timing issues.
Work requirements (and learning assessment)	Assigning design problems to be done in teams of 2 to 4 students is well received and provides a good learning experience for students. Making the design problems realistic and challenging is important but requires time and effort both to develop and grade. Using a development complex on or near campus that the students are familiar with can help elevate the students’ interest in the design problems assigned and enable clear comparisons of approaches or technologies. A class project done in a team and which results in a written report and an oral presentation is well received by most students and clearly valuable to their learning.

To enable the sustained delivery of a semester-long course in decentralized systems at a particular university in the United States and potentially elsewhere, there are potential impediments that may need to be overcome. Some of these potential impediments are tied up in the specific circumstances at a particular university such as: 1) having a tenure-line faculty member who has expertise and a passion for the topic and the time and support to develop and establish a course(s), 2) having a receptive administration that will recognize the value and need for a course and support sustained delivery of it, 3) having credit-hour space in one or more degree programs to make the course a valued elective or requirement, 4) stimulating interest in the course, attracting an adequate number of students to enroll in it, and getting high course reviews, and 5) having other faculty become actively involved in course delivery. Beyond these five impediments, two other general impediments include: 6) systemic changes that are needed in the field to help increase student job and career opportunities and 7) greater access to textbooks and associated materials to aid course development and enhance course delivery (Table 3).

Course development does take a major effort by one or more faculty members over a period of time under the right circumstances. To facilitate course development and delivery, faculty can take advantage of the experiences at other universities (e.g., Table 2) and the growing base of resources available (e.g., Gross et al. 2005, Gaulke et al. 2008, Strande al. 2014, Siegrist 2017). To improve the likelihood of successful and sustained course delivery, faculty can develop a course to serve degree programs in multiple departments on campus (e.g., CEE, HSE, HE) as this can help garner administrative support and build student enrollments.

Table 3. Need for systemic changes and course development and delivery aids to support U.S. higher education focused on decentralized systems.

Area	Description of potential impediments to more widespread course delivery
Systemic changes can help create jobs and careers which require higher education	<p>Modern systems need to be differentiated from legacy systems and legacy system performance should not cloud 21<sup>st</sup> Century views. Modern 21<sup>st</sup> Century systems are designed for effective treatment, water reclamation, and resource recovery. Similarly, legacy terminology should not misrepresent 21<sup>st</sup> Century systems. For example, we could use “Water reclamation and reuse” NOT “Wastewater treatment and disposal”.</p> <p>Existing regulations and requirements are often based on 20<sup>th</sup> Century understanding and experiences, often with legacy systems, and they are often prescriptive, constraining and very conservative. In the 21<sup>st</sup> Century, modernized regulations and requirements will help facilitate creative engineering to realize the full benefits of decentralized systems.</p> <p>More sustainable funding is needed. Course offerings would grow if there were greater sustained funding at the national, state and local level, including: grants for research and student fellowships and traineeships and funding for new infrastructure construction and rehabilitation of aging infrastructure.</p>
Modern course development and delivery aids are needed	<p><i>Decentralized Water Reclamation Engineering</i> (Siegrist 2017) is one example of a contemporary textbook available in eBook and hard cover versions that also includes a solutions manual and comprehensive slide set. Other course development and delivery aids are also available (e.g., Gross et al. 2005, Gaulke et al. 2008, Strande al. 2014).</p>

## CONCLUSIONS

The virtues and benefits of decentralized systems have been widely recognized and approaches, devices, and technologies continue to be advanced and promoted for widespread use across the United States and abroad. Yet, the principles and practices of modern decentralized systems have not been broadly incorporated into curriculum within U.S. higher education. Among the thousands of U.S. universities, only a few have so far been successful in developing and incorporating semester-long courses that are focused on engineering of

decentralized systems. As noted in this paper, there can be several impediments that may need to be overcome to enable more widespread delivery of decentralized systems courses in higher education. Realizing this outcome is critical to help educate the next generation of undergraduate and graduate students so they can become properly informed design professionals and decision makers.

## REFERENCES

- CIDWT. 2014. Education Curriculum: CIDWT University Curriculum. Consortium of Institutes for Decentralized Wastewater Treatment. [http://www.onsiteconsortium.org/univ\\_curric.html#aero](http://www.onsiteconsortium.org/univ_curric.html#aero). Accessed 21Feb14.
- Daigger G. 2008. New approaches and technologies for wastewater management. In: The Bridge, U.S. National Academy of Engineering, 38(3), pp. 38-45.
- Gaulke L.S., Borgford-Parnell J.L., Stensel H.D. 2008. A decentralized and onsite wastewater management course: bringing together global concerns and practical pedagogy. *Water Science and Technology*, 58(7):1397-1404.
- Gross, M.A., Deal N.E., Buchanan J.R., Kenimer A., Lesikar B.J., Loudon TL., Oakley S., Seabloom R.W., Trotta P., Wallace S.D. 2005. University Curriculum Development for Decentralized Wastewater Management. Project No. WU-HT-01-06. [http://ndwrcdp.werf.org/documents/WU-HT-01-06/WUHT0106\\_Summary.pdf](http://ndwrcdp.werf.org/documents/WU-HT-01-06/WUHT0106_Summary.pdf) 10 pp.
- Siegrist R.L. 2001. Advancing the science and engineering of onsite wastewater systems. In: Onsite Wastewater Treatment. Publ. 701P0101, ASAE, St. Joseph, MI. pp.1-10.
- Siegrist R.L., Lowe K.S., McCray J.E., Cath T.Y., Munakata-Marr J. 2013. Onsite and decentralized wastewater systems - advances from a decade of research and educational efforts. *Australian Water Association journal, Water*, Vol. 40, No. 1, pp. 77-84.
- Siegrist R.L. 2014. Onsite and decentralized systems water and wastewater engineering: course development and delivery experiences in higher education. In: Innovations in Soil-based Onsite Wastewater Treatment, Proc. Soil Science Society of America Conference, Albuquerque, NM, April 6-7, 2014. 13 pp.
- Siegrist, R.L. 2017. *Decentralized Water Reclamation Engineering – A Curriculum Workbook*. Springer Int. Pub. 947 pp. [www.springer.com/us/book/9783319404714](http://www.springer.com/us/book/9783319404714).
- Strande L., Ronteltap M., Brdjanovic D. 2014. *Faecal Sludge Management: Systems Approach for Implementation and Operation*. IWA Publishing, London. 427 pp.
- Tchobanoglous G. 2002. The role of decentralized wastewater management in the 21<sup>st</sup> Century. The AEESP/WEF Lecture at WEFTEC 75<sup>th</sup> Annual Conf. & Exhibition, Sept. 28-Oct. 2. Chicago, IL.
- USEPA. 1997. Response to Congress on Use of Decentralized Wastewater Treatment Systems. U.S. Env. Protection Agency, Washington, D.C. EPA832/R-47/001b.
- WERF. 1999. Research Needs to Optimize Wastewater Resource Utilization. Final report for Project 98-CTS-1, Water Environment Research Foundation. Alexandria, VA. 63 pp.
- WERF. 2009. Smart, Clean & Green: 21<sup>st</sup> Century Sustainable Water Infrastructure. Agency briefing and research planning workshop, February 25-26, 2009, Washington, D.C.



## The use of different types of zeolite and scoria as filtration and treatment media in small wastewater treatment systems

Kele, B.<sup>1,2</sup>, Midmore, D.<sup>1</sup>, Walsh, K.<sup>1</sup>, Gardner, T.<sup>1,2</sup>, Kelly, J.<sup>1,2</sup>

<sup>1</sup> Central Queensland University, Bruce Highway, Rockhampton, Queensland, 4702, Queensland, Australia

<sup>2</sup> Arris Pty/Ltd, Building 11B, Gate 2C, Hartley Grove, University of Adelaide, Waite Campus, Urrbrae SA 5064, Australia

**Keywords:** Zeolite, scoria, cation exchange, nitrogen, salinity, sodicity, and mixed media filtration

### Introduction

Historically there has been a disposal mentality towards the treated effluent from on-site systems (Siegrist et al., 2007). The ability to recycle water *in-situ* from on-site systems is technically and economically feasible; especially for garden irrigation (Lesikar et al., 1998). Recycled water must be 'fit for purpose'; that is, it must pose no undue risk to public or environmental health when it is used to perform a task (Ohgaki and Sato, 1991). Nitrogen is an identified risk in water recycling. However on-site and decentralised water recycling is predominately into soil, so the nitrogen risks have been traditionally more concerned with run-off or leaching into waterways rather than direct injection into a water body (Naji, 2006). Two contaminants of concern that are prevalent in most recycled waters, and a specific risk to the soil environment are salinity and sodicity (Toze, 2006). The concentration of all salts present in a soil or water is the definition of salinity (VanDeGraaff and Patterson, 2001). Sodicity can be defined as when sodium is the dominant cation in a soil or a water (Asano et al., 2007). Most on-site wastewater treatment technologies cannot treat salinity and sodicity risks as they do not reduce the amount of sodium ions or lower the concentration of salts in the water. Sodium removal and salinity adjustment is possible through the cation exchange processes of certain volcanic rocks; zeolite and scoria (Kele, 2005). This study investigates how media filter using volcanic rocks can improve nitrogen removal, and lower the sodicity and salinity risk of on-site recycled water.

### Material and Methods

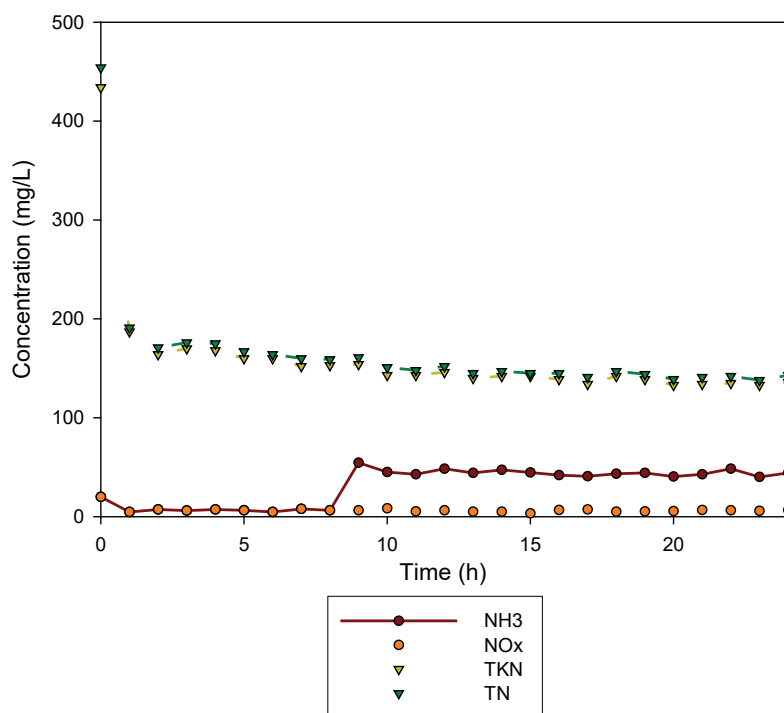
Columns studies were conducted with different types of zeolite and scoria using both a real and a synthetic wastewater. The volcanic filter media underwent geochemical analysis using X-ray fluorescence spectrometry on fused bead samples. The performance of each filter media was assessed in relation to nitrogen species removal, changes in sodicity risk (sodium, calcium, and magnesium concentrations), and the impact on hydraulic retention time.

### Results and Discussion

The geochemical data showed differences between each of the volcanic media. The scoria data also indicates that the silicon-aluminium framework found in zeolites may not be present in the same format/structure as in zeolite due to the differences in silicon concentration. All of



the volcanic media did cation exchange and have impact on the total nitrogen concentration, the sodicity, and the salinity. In Figure 1, the column trials using black scoria and the nitrogen species data is shown. The reduction in total nitrogen (TN) and total Kjeldahl nitrogen (TKN) started to occur very quickly. At the 9 hour mark some nitrogen transformation began to occur with the formation of  $\text{NH}_3$ .



**Figure 1. Variation of Nitrogen species concentration during a 24 hour trial with Black Scoria**

The sodicity of the effluent was reduced by the media cation exchanging the sodium out of solution and replacing it with calcium and magnesium ions. All five volcanic media could reduce the sodicity and the salinity risk of the real and synthetic wastewater.

## References:

- Asano, T. (1998). Wastewater Reclamation and Reuse. Lancaster, Technomic Publishing Company.
- Kele, B. (2005). Onsite Wastewater Treatment and Reuse Using Recirculatory Evapotranspiration Channels In Regional Queensland. PSG - Master of Applied Science. Rockhampton, CQU: 1-338.
- Lesikar, B. J., et al. (1998). Subsurface Drip Systems for the Disposal of Residential Wastewater. On-Site Wastewater Treatment - Eighth National Symposium on Individual and Small Community Sewage Systems, USA.
- Naji, F. and T. Lustig (2006). "On-site water recycling - a total water cycle management approach." Desalination **188**: 195-202.
- Ohgaki, S. and K. Sato (1991). "Use of Reclaimed Wastewater for Ornamental and Recreational Purposes." Water, Science and Technology **23**: 2109-2117.
- Siegrist, R. L., et al. (2007). Advancing the Science and Engineering and Integration of On-site Wastewater Systems. On-site '07, University of New England, Lanfax Laboratories.
- Toze, S. (2006). "Reuse of effluent water - benefit and risks." Agricultural Water Management **80**(1-3): 147-159.
- VanDeGraaff, R. and R. A. Patterson (2001). Explaining the Mysteries of Salinity, Sodicity, SAR and ESP in On-site Practice. On-site '01, University of New England Armidale, Lanfax Laboratories.

## Performance of a continuous-flow single stage deammonification system with mesh separated compartments

Weissenbacher, N.<sup>1</sup>, Schoepp, T.<sup>1</sup>, Bousek J.<sup>2</sup>, Fuchs, W.<sup>2</sup>

<sup>1</sup> University of Natural Resources and Life Sciences, Institute of Sanitary Engineering and Water Pollution Control, 1190 Vienna, Austria

<sup>2</sup> University of Natural Resources and Life Sciences, Institute of Environmental Biotechnology, 3430 Tulln, Austria

**Keywords:** deammonification; single-stage; mesh compartment

### Introduction

Since its discovery in the early 1990s the anaerobic ammonia oxidation or in short anammox process has gained significant attention. In comparison to the standard approach, nitrification-denitrification, the combination of anammox with partial nitritation (PNA) provides two major advantages: a reduced oxygen demand and the independence of availability of easily accessible BOD (Jetten et al. 1997). Generally the applied processes can be divided into two categories (Jaroszynski and Oleszkiewicz 2011, Lackner et al. 2014): two step processes where nitration and anammox occur in two separate reactors and single stage processes working in a sequential mode (SBR). The later has the advantage of being a single unit process of technical simplicity. The sequential operation of the two processes in a single reactor leads to lower pH fluctuations resulting in a typical pattern of the pH course which can be used for process control (Wett, 2007). Further, adequate sequential execution, as performed in single-stage systems, avoids accumulation of inhibitors (nitrite and ammonia) whereas in two stage-systems high concentrations occur in the outflow of the nitritation stage making process disturbance more likely. However, the disadvantage is that reaction conditions periodically switch from being either favourable for nitritation (aeration phase) or for anammox. In consequence, the volumetric turnover rates are typically inferior to two stage processes. The approach chosen here tries to combine the advantages of both types of reactors by the installation of a semi-permeable barrier made of mesh material. By such means two separate reaction zones, aerated and non-aerated, can be maintained. At the same time the permeable mesh allows passage of dissolved ions and such a balancing of the different pH levels as well as the rapid transfer of the produced nitrite. Although, woven or non-woven filter cloths are already applied in wastewater treatment e.g. for separation in filter presses or belt filters, removal of fine suspended solids for effluent polishing or even for biomass retention (Grabbe et al. 1998, Fuchs et al. 2005) the idea of using mesh filters to establish two different reaction zones for compact deammonification systems has not been studied yet. The present study describes the investigation and optimization of the described approach in a 13 L lab reactor and in 375 L pilot scale system. The goal was to investigate the performance and stability of the development for the application at smaller activated sludge plants with limited personnel capacities.

## Material and Methods

The investigations were carried out at a 13 L reactor system and a 375 L pilot scale system. Both systems were run in continuous mode. Both reactors had a mesh separated nitrification and anammox compartment (double chamber) with different geometry and volume to mesh surface ratios. Aeration control was based on fixed pH including acid/base dosing and pH variation within a narrow bandwidth, respectively. Additionally, a second 375 L pilot single chamber SBR was operated to compare the performance of the new reactor design to standard configuration as it is present at many full scale deammonification plants. The systems treated digester supernatant from two activated sludge plants (500 - 1.400 mg/L NH<sub>4</sub>-N). The inoculum was PNA biomass from a 500 m<sup>3</sup> single-stage side stream deammonification plant. Reactor performance was monitored using standard lab analyses for nitrogen, inorganic and organic carbon parameters with additional monitoring of the anammox activity. In order to evaluate the system stability and the performance of the control concept, several additional experiments (e.g. alkalinity variation) were carried out.

## Results and Discussion

Both systems reached stable operation after a start-up period of one month. The performance of the 13 L reactor reached an almost complete reduction of ammonia and a total nitrogen elimination between 80% and 85% at a maximal volumetric loading rate (VLR) of 1.5 kg N m<sup>-3</sup> d<sup>-1</sup>. The 375 L pilot system reached comparable degradation rates at maximal VLR of 0.7 kg N m<sup>-3</sup> d<sup>-1</sup>. Differences in the performance can be attributed to the different control strategies as well as the influent characteristics. Additionally, the volume to mesh surface area impacted the transfer of process intermediates. The treatment performance of the 375 L standard SBR setting showed comparable results (Figure 1), however higher variations in effluent concentrations. In comparison to the standard SBR configuration, the mesh separated double chamber system with continuous flow and the simple control concept showed higher stability at lower operational efforts.

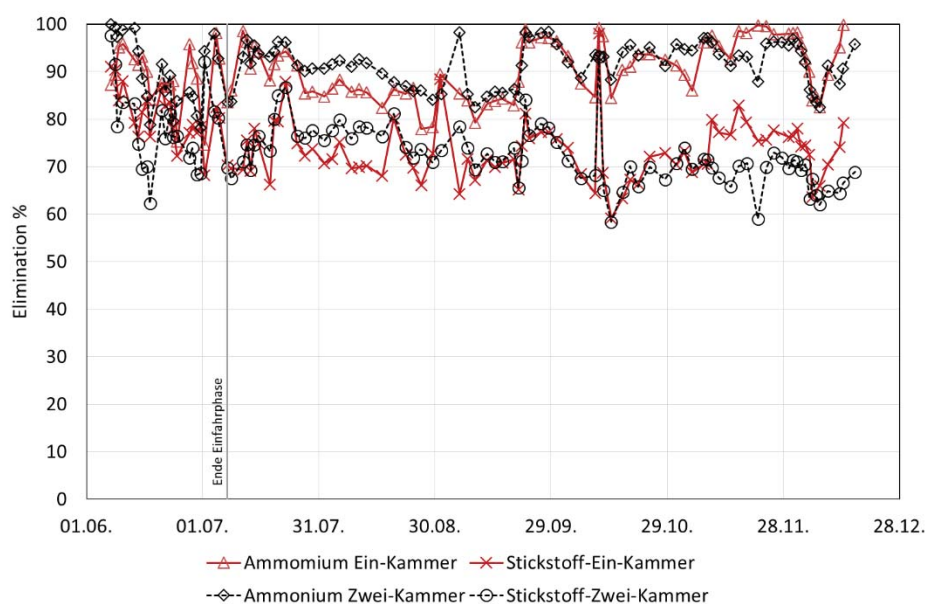


Figure 1. Comparison of ammonium and total nitrogen removal for the mesh separated two chamber

**reactor (black) and the single chamber SBR (red).**

## **References**

- Fuchs W., Resch C., Kernstock M., Mayer M., Schoeberl P. & Braun R. 2005 Influence of operational conditions on the performance of a mesh filter activated sludge process. *Water Research* 39(5): 803-810
- Grabbe U., Seyfried C.F. & Rosenwinkel K.-H. 1998 Upgrading of waste water treatment plants by cloth-filtration using an improved type of filter-cloth. *Water Science and Technology*, 37(9): 143-150
- Jaroszynski L.W. & Oleszkiewicz J.A. 2011 Autotrophic ammonium removal from reject water: partial nitrification and anammox in one - reactor versus two - reactor systems. *Environmental Technology*, 32:3, 289-294
- Jetten M.S.M., Logemann S., Muyzer G., Robertson L.A., De Vries S., van Loosdrecht, M.C.M & Kuenen J.G. 1997 Novel principles in the microbial conversion of nitrogen compounds. *Antonie van Leeuwenhoek*, 71(1-2): 75-93
- Lackner S., Gilbert E.M., Vlaeminck S.E., Joss A., Horn H. & van Loosdrecht M.C.M. 2014 Full-scale partial nitritation/anammox experiences—an application survey. *Water Research* 55: 292-303
- Wett B. 2007, Development and implementation of a robust deammonification process. *Water Sci. Technol.* 56: 81-88

# Intelligent control for ammonia compliance in small works receiving variable loads, a case study.

Ref # S2SMALL-16465

I. Blanco\*, F. Sutton, E. Ruswa, A. Richards

Severn Trent Water, 2 St. John's Street, Coventry CV1 2LZ, West Midlands, UK

\* Corresponding Author: [ivan.blanco@severntrent.co.uk](mailto:ivan.blanco@severntrent.co.uk)

**Abstract:** This work presents the successful upgrade of a small sewage treatment works consisting of rotating biological contactors (RBCs) and constructed wetlands (CWs). The site was struggling to meet its NH<sub>3</sub>-N permit due to variable loads and population increase in the catchment. Investment was focused on controlling inlet flows, refurbishing and upgrading CWs with an aeration system, and incorporating a balancing tank with an intelligent control system.

The site performed well below the 10 mg/L permit during Winter, even during periods of sustained wet weather. The site also kept below the 5 mg/L permit during Summer when RBC effluent concentrations increased over the detection limit of the monitoring instrument (20 mg/L). Although a few NH<sub>3</sub>-N spikes still occurred during periods of low flow, the site remained within compliance on a 95%ile basis. Tankering was not required during 2016.

Upgrade with aeration system allows CWs to perform above their original design capacity. The intelligent control system is able to provide longer time for the treatment process to treat strong loads and can now give early warning if tinkering operations are required. This is a successful integration of low cost technologies with intelligent control systems while reducing investment and operational costs.

**Keywords:** Nitrogen, Rotating Biological Contactors, Constructed Wetlands, Small Works, Aeration.

## INTRODUCTION

In order to achieve a good ecological status as required by the Water Framework Directive, several sewage treatment works (STWs) will require upgrading in order to discharge NH<sub>3</sub>-N levels lower than 5 mg/L into the receiving waters (Pearce, 2013). The main challenge is to maintain or improve the treatment performance of STWs without causing an excessive increase in energy usage or costs. This is particularly challenging for small STWs serving less than 2,000 population equivalents (PE) as they employ technologies with low energy, operation and maintenance requirements (Butterworth *et al.*, 2016).

This work presents the case study of a small STW which required investment in order to comply with its NH<sub>3</sub>-N permit. Blymhill is a small STW located in Staffordshire (West Midlands, England) overloaded due to population increase in the catchment (from originally design of 440 to 551 PE) and the increasing events calendar at Weston Park which is a local hotel and conference centre, estimated to receive 400 PE from visitors, doubling the load to the works particularly during weekends and holiday periods. Once a year, a famous music festival (V-Festival) is also held within the site's catchment attracting thousands of visitors to the local bars and hotels.

Population increase over the original design capacity has resulted in the site struggling to meet its NH<sub>3</sub>-N permit (5 mg/L Summer; 10 mg/L Winter on a 95%ile basis). Sanitary

compliance was kept on site by tankering all flows away from the works during vulnerable periods at an average cost of 52,000 €/year; an unfavourable long term solution.

The standard solution for the site would have involved the construction of an additional integral Rotating Biological Contactor (RBC) and additional Constructed Wetland (CW) surface area. The preferred option however, considered refurbishment of the existing works and the implementation of an intelligent control system that relies on a final effluent NH<sub>3</sub>-N monitor. The rationale for this option was to optimize existing RBCs and CWs residual asset life while reducing significant project costs (up to a third of the standard solution).

This work summarizes the findings from operation at Blymhill STW since late 2015, after refurbishment of the existing works.

## **MATERIALS AND METHODS**

### **Site Description pre refurbishment**

The original design of the existing works at Blymhill STW (Fig 1) is about 25 years old, and was designed to cater for a design population of 444 PE. Increasing population in the catchment resulted in the works being hydraulically and organically overloaded and depending on non-compliant effluent being tankered away in order to avoid pollution of the nearby Lincoln Brook.

Existing works pre refurbishment consists of an inaccurate inlet flow split that feeds 2 similarly sized RBCs with storm overflows, a combined maximum hydraulic capacity of 7 L/s and a disc area of 8,880 m<sup>2</sup>. The RBCs are hydraulically and organically overloaded with respect to the increased design population of 844 PE by non-resident domestic load.

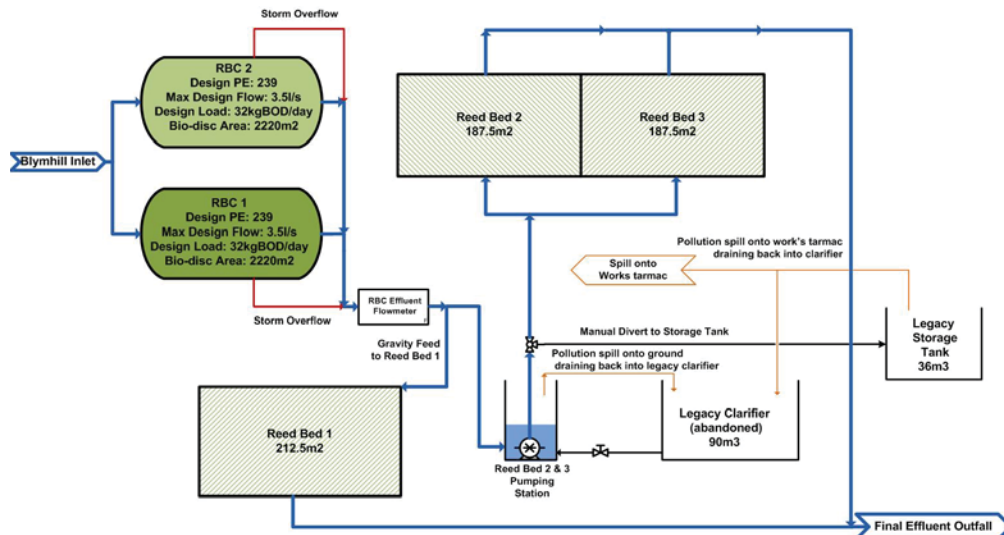
Storm flows and RBC effluent are combined ahead of the 3 CWs which have a combined surface area of 588 m<sup>2</sup>. The CWs are also undersized for the design PE and as such they suffer with overloading, blocking, reed mortality and subsequently poor performance.

An inaccurate flow split distributes the flows to CWs of different surface areas. CW1 is fed by gravity, whereas a pumping station pumps flows into CWs 2 & 3.

A 36 m<sup>3</sup> legacy storage tank is used on site to divert all flows from the pumping station for subsequent tankering in case of pollution. This storage volume allows for about 3.5 h onsite storage at 15 L/s. Non-compliant effluent was tankered away on 91 out of 267 days monitored between July 2011 and June 2012.

There is an abandoned clarifier with a volume capacity of 90 m<sup>3</sup>.





**Figure 1.** Process Flow Diagram of existing works at Blymhill STW pre refurbishment.

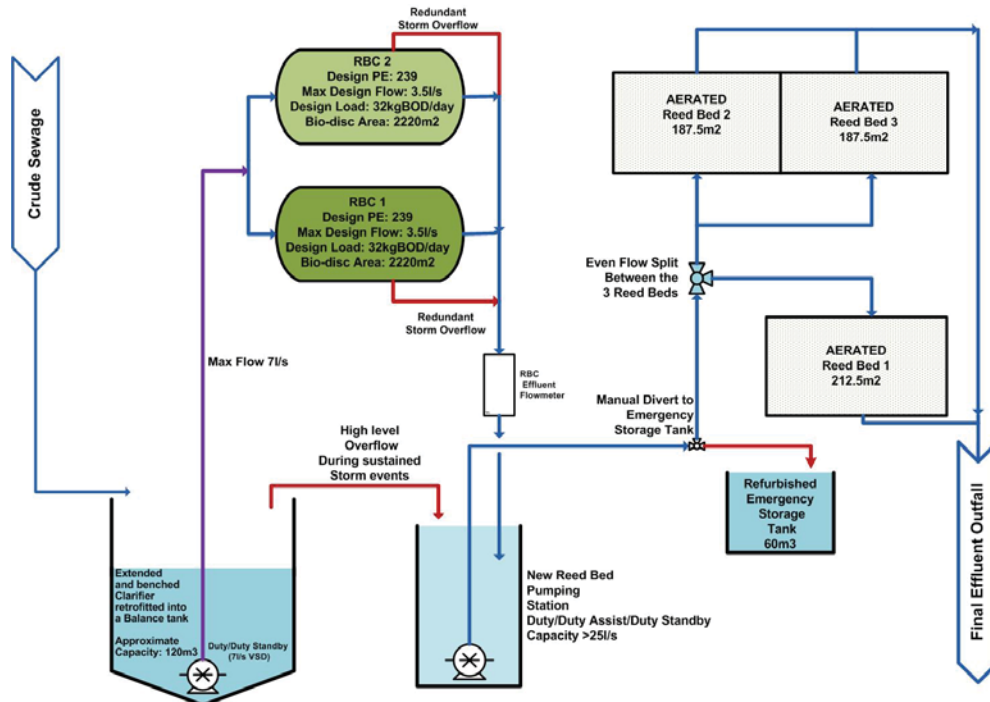
### Site Description after refurbishment

Refurbishment of existing works consisted of (Fig 2):

- New modulating penstock and flow measurement at the inlet works. This installation now limits the flows to the RBCs to 7 L/s. Flows greater than 7 L/s are now sent to a new balancing tank.
- Refurbishment of CWs and upgrade with a new aeration system.
- New flow split arrangement to CWs.
- Conversion of existing clarifier into a balancing tank that receives overflows from the new inlet works during storm conditions or crude sewage as controlled by the NH<sub>3</sub>-N monitor in the Final Effluent (FE).

The intelligent control system required the installation of actuated valves to divert crude sewage flows to either the treatment process or the balancing tank depending in the NH<sub>3</sub>-N concentrations measured by the monitor in the FE. When NH<sub>3</sub>-N concentrations in the FE exceed 50% of NH<sub>3</sub>-N permit, the crude sewage is directed to the balancing tank by closing the RBC inlet actuators. Once the NH<sub>3</sub>-N monitor indicates that the site is within permit, it allows the flows to pass through the RBCs and back into the reed beds resuming the original treatment process.

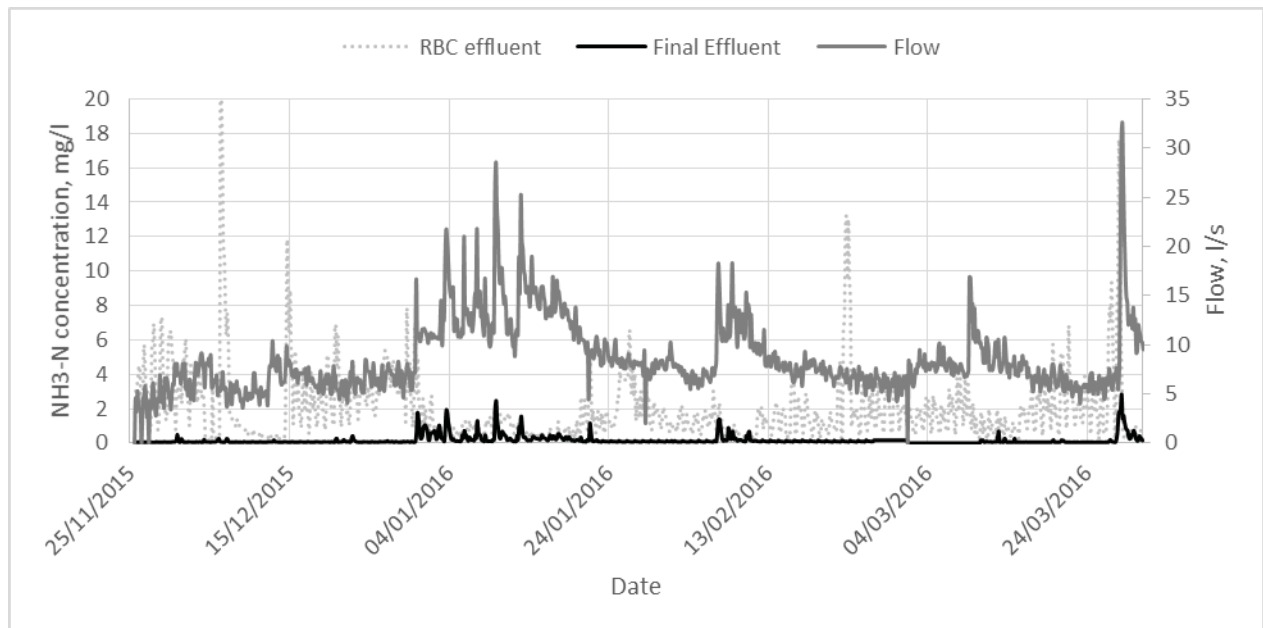
Diversion also gives operators remote early warning if tankering operations are likely to be required. (Green, 2016).



**Figure 2.** Process Flow Diagram of existing works at Blymhill STW after refurbishment.

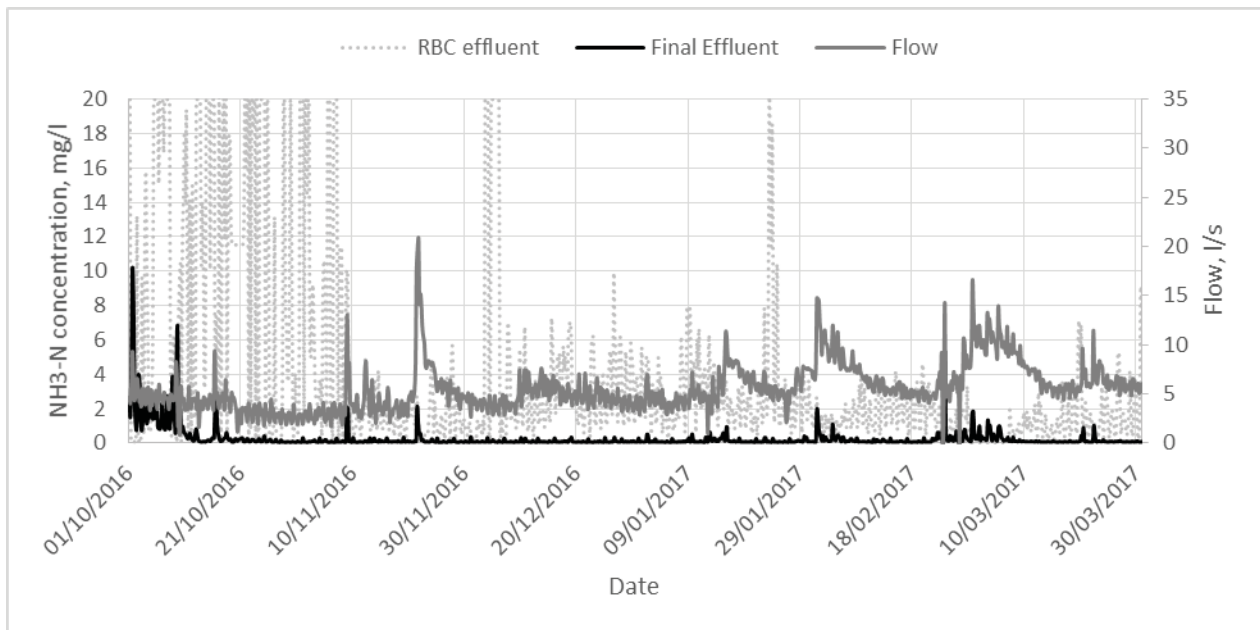
## RESULTS AND DISCUSSION

Figures 3 and 4 show flows and  $\text{NH}_3\text{-N}$  trends at Blymhill STW during the Winter periods.  $\text{NH}_3\text{-N}$  concentrations in the RBC effluent seem to be strongly related to flow conditions. Maximum RBC effluent  $\text{NH}_3\text{-N}$  concentrations were registered during periods of lower flows. Dry weather condition periods result in lower infiltration in the network, lower dilution of sewage and stronger loads into the RBCs. Overall, higher RBC effluent  $\text{NH}_3\text{-N}$  concentrations during the Winter period 2016-17 (Fig 4) could be attributed to drier weather when compared to the previous Winter 2015-16, that resulted in lower flows and higher incoming loads.



**Figure 3.** Flow values (L/s) and  $\text{NH}_3\text{-N}$  concentrations (mg/L) at the RBC effluent and FE

during the first Winter period (25<sup>th</sup> Nov 2015 – 31<sup>st</sup> Mar 2016; NH<sub>3</sub>-N permit 10 mg/L) after refurbishment.

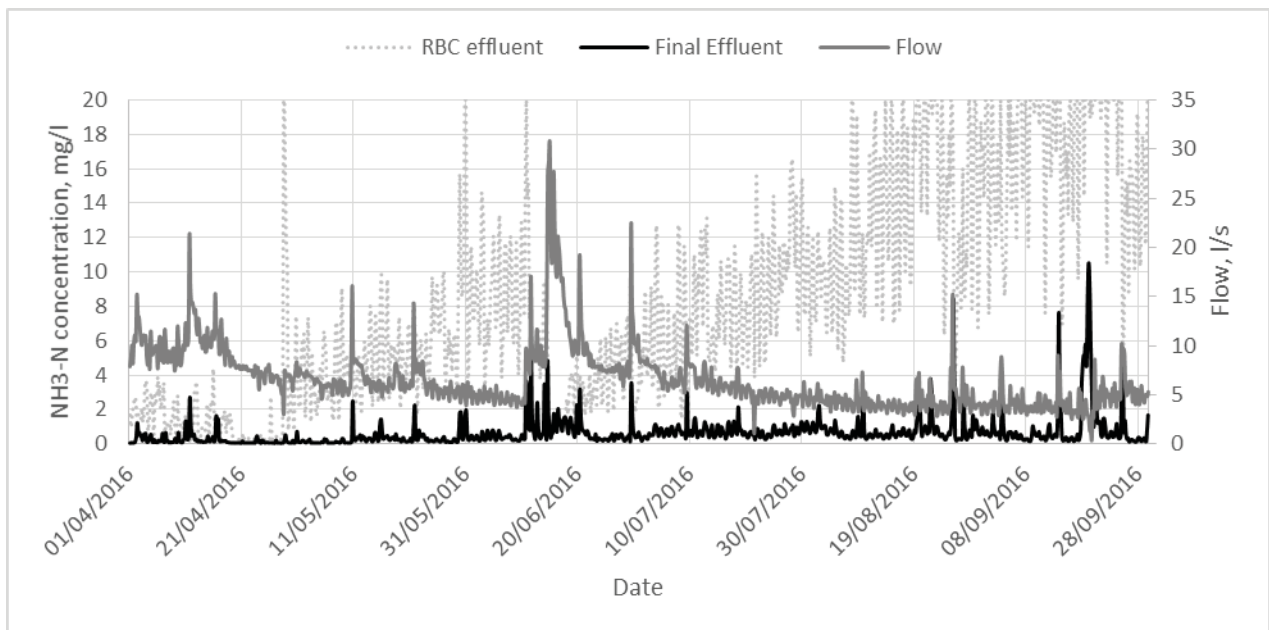


**Figure 4.** Flow values (L/s) and NH<sub>3</sub>-N -N concentrations (mg/L) at the RBC effluent and FE during the second Winter period (1<sup>st</sup> Oct 2016 – 31<sup>st</sup> Mar 2017; NH<sub>3</sub>-N permit 5 mg/L) after refurbishment.

The site is now within permit during periods of high flows. The new inlet works now limit flows to the RBCs according to their hydraulic capacity. Flows greater than 7 L/s are sent to the balance tank and, in periods of sustained wet weather, balance tank effluent is sent directly to the aerated CWs. This results in low NH<sub>3</sub>-N concentrations in the RBC effluent due to diluted incoming NH<sub>3</sub>-N loads, and in slightly higher NH<sub>3</sub>-N concentrations in the FE due to bypassing of RBC units.

Final Effluent (FE) NH<sub>3</sub>-N concentrations were well below the Winter permit of 10 mg/L. The aerated CWs have been able to sustain an active community of nitrifying bacteria to cope with RBC effluent concentrations even when they went above 20 mg/L NH<sub>3</sub>-N in periods of low incoming flows (Fig 4).

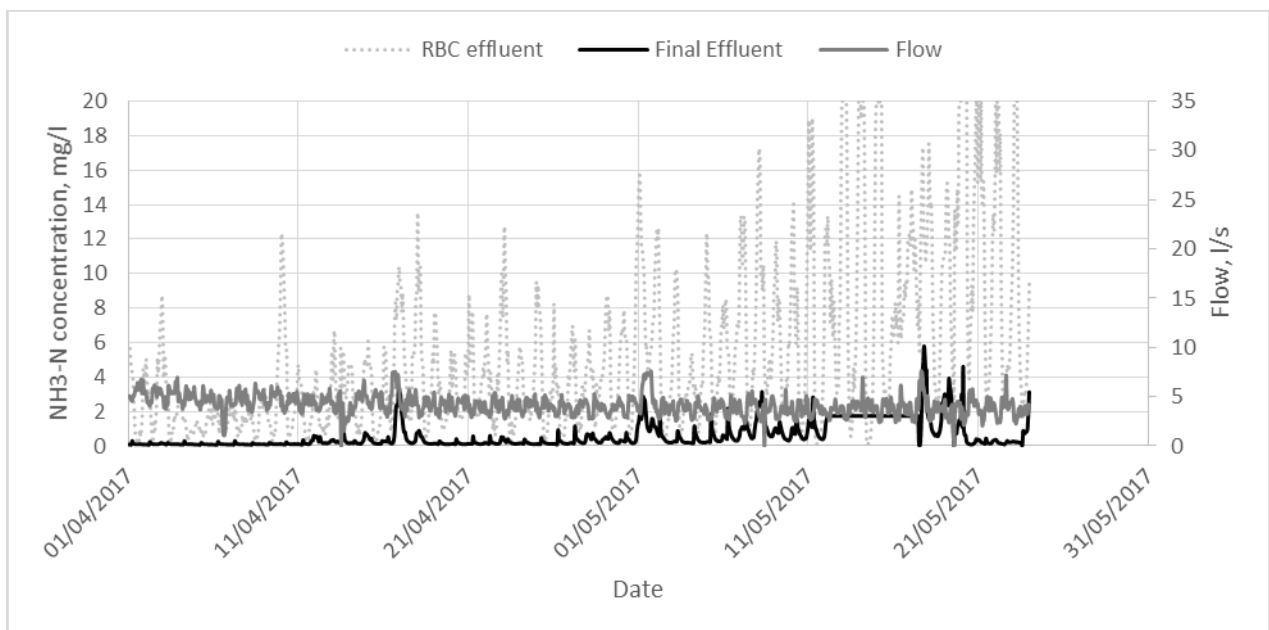
Figures 5 and 6 show flows and NH<sub>3</sub>-N trends at Blymhill STW during the Summer periods. Sustained dry weather conditions resulted in lower incoming flows and higher loads. It is possible to see increasing RBC effluent NH<sub>3</sub>-N concentrations that decrease suddenly after a wet period likely due to load dilution and flushing of remaining load within the RBCs (Fig 5). RBC effluent NH<sub>3</sub>-N concentrations continue increasing until reaching values above the detection limit (20 mg/L) of the monitoring instrument.



**Figure 3.** Flow values (L/s) and NH<sub>3</sub>-N concentrations (mg/L) at the RBC effluent and FE during the first Summer period (1<sup>st</sup> Apr – 31<sup>st</sup> Sep 2016; NH<sub>3</sub>-N permit 5 mg/L) after refurbishment.

Despite high RBC effluent concentrations, the site is within permit during sustained dry weather periods. In the case that NH<sub>3</sub>-N concentrations in the FE exceed the action limit of 2.5 mg/L (50% of the Summer permit), the inlet flows are directed to the balancing tank by closing the RBC inlet valves. This allows the RBCs and aerated CWs more time to treat the sewage, attenuating the NH<sub>3</sub>-N concentrations in the final effluent.

Although a few NH<sub>3</sub>-N spikes still occurred during periods of low flow, Blymhill STW remained within compliance, with FE NH<sub>3</sub>-N concentrations below the Summer permit of 5 mg/L on a 95%ile basis.



**Figure 4.** Flow values (L/s) and NH<sub>3</sub>-N concentrations (mg/L) at the RBC effluent and FE

during the second Summer period (1<sup>st</sup> Apr – 24<sup>th</sup> May 2017; NH<sub>3</sub>-N permit 5 mg/L) after refurbishment.

In the event that the site remains uncompliant the system alarms and calls for tankering to intercept non-compliant flows. Whereas in the past tankering in Blymhill STW was performed routinely at significant average cost of 54,000 € / year, there has been no requirement in 2016. The reduction in need for tankering confirms the success of the works refurbishment and the incorporation of the intelligent control system to keep Blymhill STW within compliance.

## **CONCLUSIONS**

The solution implemented at Blymhill STW allows the site to remain compliant throughout the year. RBCs continue providing treatment according to their original design capacity, but the aeration upgrade has resulted in the CWs being now able to reliably provide tertiary treatment above their original design capacity, even during periods with high NH<sub>3</sub>-N loads from the RBCs.

The incorporation of balancing tanks has been key to provide treatment during periods of variable loads. During sustained wet weather conditions the site now diverts storm flows to the balancing tank, allowing RBCs and CWs to remain within their hydraulic design capacity. During sustained dry weather conditions when NH<sub>3</sub>-N concentrations exceed 50% of the permit in the FE, the site now diverts crude flows to the balancing tank, allowing longer time for the treatment process, and giving early warning if tankering operations are required.

In summary, the present work shows the successful case study of the integration of low cost technologies with intelligent control systems to improve the treatment capacity of a small STW. This option has required up to a third lower investment than a standard one, and has reduced the need for tankering, resulting in an important reduction of operational costs.

## **REFERENCES**

- Butterworth, E., Richards, A., Jones, M., Dotro, G. and Jefferson, B. 2016. Assessing the potential for tertiary nitrification in sub-surface flow constructed wetlands. *Env Tech Reviews*. 5(1), 68-77.
- Green, S. 2016. Blymhill STW innovative ammonia treatment design. *UK Water Projects 2016*. 129-131. Online: [www.WaterProjectsOnline.com](http://www.WaterProjectsOnline.com) (accessed 14 July 2017)
- Pearce, P. 2013. Sustainable processes to meet low ammonia consents – the small works challenge. In: *Proceedings of the 2<sup>nd</sup> Conference on Low Energy Wastewater Treatment Systems*; 24<sup>th</sup> September, Solihull, United Kingdom.

# Optimal selective pressures to achieve partial nitrification in continuously fed activated sludge reactors

Spinelli, S.<sup>1</sup>, Cingolani, D.<sup>1</sup>, Fatone, F.<sup>1</sup>, Battistoni, P.,<sup>1</sup> Frison, N.<sup>2</sup>, Eusebi, A.L.\*<sup>1</sup>

<sup>1</sup> SIMAU Department, Università Politecnica delle Marche, Via Brecce Bianche, 12, Ancona 60100, Italy. E-mail: a.l.eusebi@univpm.it

<sup>2</sup> Department of Biotechnology, University of Verona, Strada Le Grazie 15, Verona, Italy

**Keywords:** Nitrite, Free Ammonia, Activated Sludge, Urban Wastewater, NOB inhibition

## Introduction

To date the via nitrite route is relatively easy to achieve for nitrogen removal from high nitrogenous wastewater such as anaerobic supernatant or landfill leachate. On the other hand, low strength wastewater such as municipal sewage requires more complex start-up methods. In fact, one of the most applied strategy for the inhibition of NOB bacteria (Nitrate Oxidising Bacteria) is the free ammonia concentration in the reactor (FA mg/l). The typical minimal NOB inhibition range observed in conventional plants is as low as 0.1-1 mgFA/l. Higher FA concentrations and NOB inhibition rate are obtained by controlling ammonia concentration, temperature and/or pH. However, in municipal wastewater treatment where ammonia concentration is low additional parameters need to be synergic to the FA concentration. Some authors (Kornaros et al., 2008) showed results to treat urban wastewater by FA inhibition but in SBR configuration process and not in continuous modality. Usually low sludge age or limiting concentrations of DO increase the NOB inhibition and wash-out. In addition, influent substrate is an important factor. In fact, the Ammonium Oxidizing Bacteria (AOB) with fast growth (r-AOB) are characterized by value of ammonia semi-saturational constant higher than the one of the AOB bacteria with slow growth (k-AOB) (Khan et al., 2016). For this reason, faster AOB growth is easily obtainable in presence of high concentration of ammonia and is less common in urban wastewater. In this scenario, inhibition tests of biomasses of real urban wastewater treatment plant were carried out to identify the optimal operative process conditions for NOB inhibition. The results supported the design of the selector in the demonstration plant.

## Material and Methods

Real conventional activated sludge was daily collected from the municipal wastewater treatment plant of Falconara Marittima (Ancona, Italy) (80,000 population equivalent). Fifty batch tests were carried out in 8 L reactor. Free Ammonia in the range of 1.5-10 mgFA/l was applied to study the inhibition effect. The FA values were obtained by manipulating the following parameters: pH (7.5-9), temperature (10-30°C) and ammonia concentrations (15-80 mgNH<sub>4</sub>-N/l). Each FA concentration was applied for different contact times from 0.5 to 8 hours. The MLSS ranged between 3000 and 8000 mgMLSS/l. After each selective test the Ammonia Utilization Rate was measured for NO<sub>2</sub>-N and NO<sub>3</sub>-N productions. The optimal selective parameters were applied to design and operate the demo scale selector operated for about two years in real environment.



## Results and Discussion

The batch tests for the inhibition of NOB showed the crucial effect of the FA. In fact, incrementing the free ammonia (1.5-10 mgFA/l) the produced NO<sub>2</sub>-N percentages increased from 0% to 21%. Moreover, not specific effect in the nitrite production was found by changing the combination of the variables of the FA (pH, Temperature and Ammonia Concentrations). Therefore, not net priority cause was identified in terms of NOB inhibition. In this sense, the pH was detected as main control parameter for possible phase of scale up. Differently, double percentages of nitrites were detected at low MLSS concentrations (low SRT) by incrementing from 11±3% (3000 mgMLSS/l) to 22±6% (8000 mgMLSS/l). Differently, net differences were found at more elevated influent ammonia concentrations (30-80 mgNH<sub>4</sub>-N/l) in terms of kinetic rates. In fact,  $k_n$  values up to 0.225±0.05 kgNO<sub>x</sub>.N/kgMLVSS/d were obtained by demonstrating the possible speciation of r-AOB at higher substrate influent load. Finally, the effect of the contact time was demonstrated (Figure 1). In fact, elevated increment of NO<sub>2</sub>-N production could be obtained by working both at lower FA concentrations and longer contact time. Limit value of 400 mgFA/l/min was identified for inhibition of NOB. This operative approach (increment of contact time) does not determine variations of nitrification rates but causes the possible reduction of reagents in the scale up phase. The data was elaborated in multivariate analysis and used to design the selector in demonstrative scale.

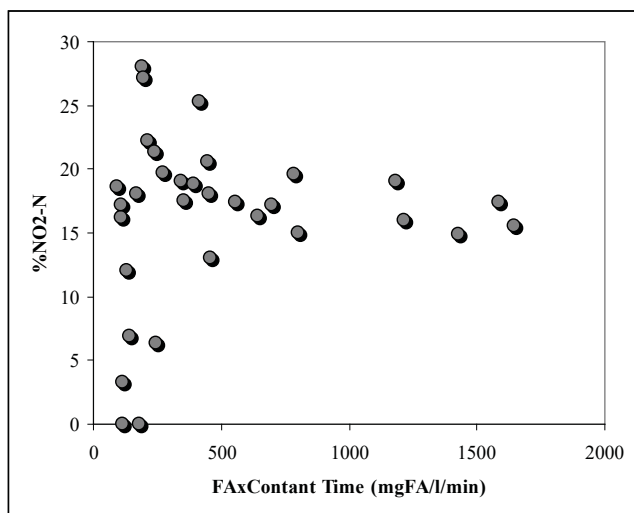


Figure 1. Percentages of nitrite and FA at different contact times

Therefore, the start up in demonstrative scale was realized by initial inhibition selector and set the product FA x Contact Time at found limit value of 400 mgFA/l/min. The main influent and effluent macropollutants were analysed. Long time for stationary condition was need. In fact, nitrites percentages raised up to 20% after 4 times of SRT (20 d). Moreover, slight increment of  $k_n$  was identified up to 0.150±0.02 kgNO<sub>x</sub>.N/kgMLVSS/d according to the batch tests. Finally, the gravitational behaviour of the biomasses was studied and the specific dose of reagents was calculated to evaluate the applicability of the proposed flow scheme.

## References

- Khan H., Bae W., 2016. Optimized operational strategies based on maximum nitrification, stability, and nitrite accumulation potential in a continuous partial nitrification reactor. *Process Biochemistry* 51 (2016) 1058–1068.
- Kornaros, M., Marazioti, C., Lyberatos, G., 2008. A pilot scale study of a sequencing batch reactor treating municipal wastewater operated via the UP-PND process. *Water Science Technology* 58 (2), pp. 435–438.

# Denitrifying Downflow Hanging Sponge (DDHS) reactors reduce total nitrogen and antibiotic resistance genes for decentralized wastewater treatment applications

Mui-Choo, J.<sup>1</sup>, Joshua, B.<sup>1</sup>, Jian-Qiang, S.<sup>2</sup>, Colin, H.<sup>3</sup>, Jason, S.<sup>4</sup>, Yong-Guan, Z.<sup>2</sup>, David, G.<sup>1</sup>

<sup>1</sup> School of Civil Engineering and Geosciences, Newcastle University, Newcastle upon Tyne, UK

<sup>2</sup> Institute of Urban Environment, Chinese Academy of Science, Xiamen, China

<sup>3</sup> Institute for Cell and Molecular Biosciences, Newcastle University, Newcastle upon Tyne, UK

<sup>4</sup> AstraZeneca UK Limited, Global Environment, Alderley Park, UK

**Keywords:** Wastewater shunting; Denitrification; TN removal; antibiotic resistance genes

## Introduction

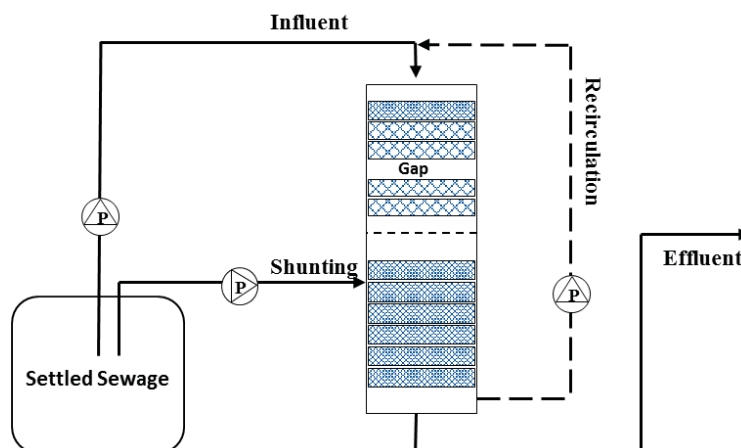
Waste management often lags behind economic growth, especially in rapidly urbanising emerging countries (e.g. India and China). In many sub-urban areas which are remote from central collection, direct discharge of domestic wastewater into the river system is common, resulting in contaminated surface water, elevated total nitrogen (TN) releases (Liu et al., 2013; Jin et al., 2014), and increased exposure to waterborne diseases (Graham et al., 2014; WHO, 2015). Unfortunately, there is also a lack of affordable treatment options that can reduce both organic pollutants and emerging pathogens (e.g. antibiotic resistance bacteria). Decentralised, small-scale systems present a viable alternative (Massoud et al., 2009), but appropriate technologies need to be effective, inexpensive, and readily available to communities with under-invested wastewater treatment to improve water quality and community health.

Denitrifying Downflow Hanging Sponge (DDHS) bioreactors that employ porous sponges and passive aeration to treat wastes are a promising option. Previous DHS reactors have proven effective in removing carbon (C) and ammonia (NH<sub>3</sub>) (Uemura et al., 2010; Mahmoud et al., 2011; Onodera et al., 2014), but display limited total nitrogen (TN) removal due to a design that fully exposes the system to air. Here, we developed a novel aerobic-anoxic DHS configuration that integrates a submerged anoxic sponge section and wastewater shunting, to promote denitrification. The main results show reproducible, enhanced TN removal with increasing percent shunting. High-throughput quantitative PCR array also revealed substantial antibiotic resistance genes (ARGs) removal. Incidentally, a pilot-scale field trial to upscale the biotechnology is underway.

## Material and Methods

Quadruplicate bench-scale bioreactors (0.50 m tall x 0.14 m diameter PVC cylinders) were operated in parallel for 210 days. DDHS design includes 1) an upper hanging sponge layer exposed to air, to allow passive aeration for nitrification; and 2) a lower sponge layer, partially submerged by effluent from the preceding aerobic layer, to create anoxic conditions for

denitrification. The design assessed also includes a wastewater shunting that provides additional carbon to the lower layer to promote denitrification (see Figure 1).



**Figure 1.** Schematic of DDHS bioreactors used in this study.

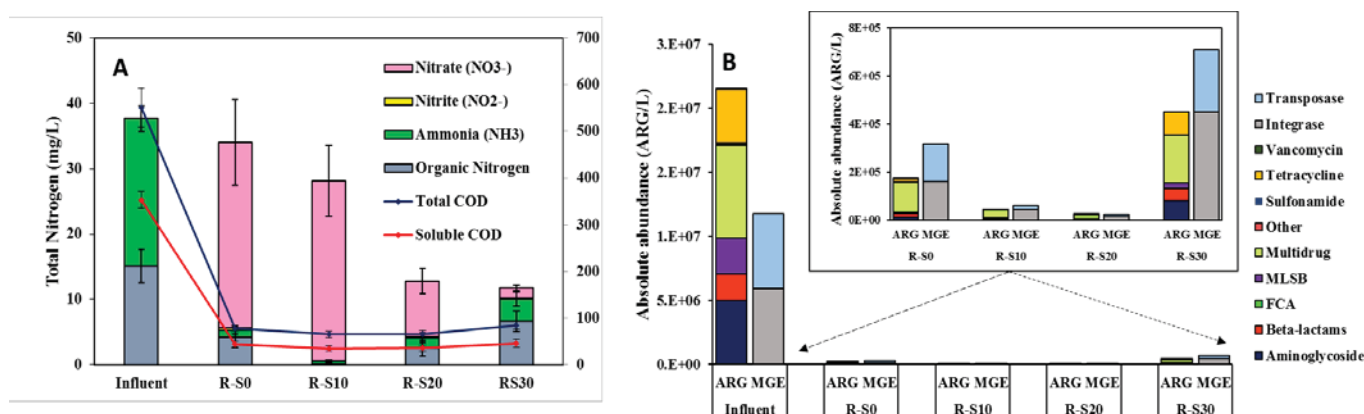
Reactors R-S0, R-S10, R-S20 and R-S30 corresponding to four varying percent shunting (0%, 10%, 30% and 40% by volume) from the total wastewater input were investigated to determine the optimum shunting amount for enhanced denitrification. Designated shuntings were introduced directly to the anoxic sponge layers, bypassing the aerobic sponge section, while an equal organic loading rates (OLR = 0.4 kg COD/m<sup>3</sup>-sponge/day) were applied to all DHS units; R-S0 with no wastewater shunting was the control unit.

Antibiotic resistance gene (ARG) abundances of the influent and effluents across bioreactors were quantified using the high-throughput quantitative PCR (HT-qPCR) method, which can simultaneously screen 284 ARGs conferring resistance to major classes of antibiotics, and exemplar mobile genetic elements (MGEs) consisting 8 transposases and two Class 1 associated integron-integrase gene (*intI*), as previously reported (Su et al., 2015).

## Results and Discussion

The new DDHS design showed COD and NH<sub>3</sub> removal rates were consistently > 79% and > 84%, respectively for all reactors; and a discernible increase in TN removal in parallel with the increased wastewater shunting to the anoxic sponge layers (Figure 2A). Statistically significant TN removal occurs in R-S20 and R-S30 (paired t-test;  $p < 0.05$ ). While COD and NH<sub>3</sub> removal resembled typical removal rate in DHS-type reactor, DDHS design promotes denitrification as a result of enhanced anoxic conditions and supplementary carbon source from the shunted wastewater into the submerged sponge core. Increased shunting has positive influence on TN removal as reflected by the significantly reduced NO<sub>3</sub><sup>-</sup> levels in R-S20 and R-S30. This is further supported by the COD levels in the final effluent whereby only a slight difference exists across reactors despite untreated COD being shunted into the submerged sponge layer. The final TN concentration in R-S30 was close to satisfying the EU effluent guidelines of 10 mg-N/L, and did satisfy the Chinese standard of 15 mg-N/L.

DDHS reactors were generally effective at reducing ARGs (see Figure 2B), although specific ARGs removed and the fate of MGEs differed slightly as a function of shunting percent. Preliminary results show promising reduction with all configurations achieved >90% total reduction of ARG levels from untreated wastewater. A total of 59 unique ARG ( $2.2 \times 10^7 \pm 4.9 \times 10^6$  copies/L) were detected in the wastewater used in this study with dominant resistance subtype including multiple drug resistance (33.8%), aminoglycosides (23.2%) tetracycline (19.6%), Macrolide-Lincosamide-Streptogramin B (MLSB; 12.9%) and  $\beta$ -lactam (9.5%). In general, the abundance of ARGs in reactor effluents decreased as bypass percent was increased (from 0% - 20% shunting), with similar pattern observed for MGEs levels. Interestingly, R-S30 has higher effluent ARG levels, which indicates lower ARG removal impacted by higher wastewater shunting despite higher TN removal. Nevertheless, DDHS bioreactors show high ARG removal (>90%) which is a novel advantage of the system potentially useful for public health defence. The new results further support the potential of the DDHS system for application in decentralised use and an ongoing pilot test will validate the new design for real-world applications.



**Figure 2. DDHS Reactor mean performance as a function of percent wastewater shunting. (A) TN concentrations subdivided among Organic-N and Ammonia-N (soluble TKN), nitrite and nitrate constituents in the settled wastewater and effluents of reactors ( $n = 12$  per reactor) over 90 days of steady-state operation after acclimation. Error bars show standard error. (B) Total abundance of ARGs and mobile genetic elements (MGEs) detected in wastewater and effluent samples.**

While further optimisation for field application is necessary, this study shows that the new DDHS configuration can remove TN and ARG simultaneously. However, trade-offs between the two constituents exist and thus, its application will depend on local priorities and the quality of the receiving water.

## References

Graham, D.W., Collignon, P., Davies, J., Larsson, D.G.J., Snape, J., 2014. Underappreciated Role of Regionally Poor Water Quality on Globally Increasing Antibiotic Resistance. *Environmental Science & Technology* 48, 11746-11747.

Jin, L., Zhang, G., Tian, H., 2014. Current state of sewage treatment in China. *Water Research* 66, 85-98.

Liu, B.B., Liu, H., Zhang, B., Bi, J., 2013. Modeling Nutrient Release in the Tai Lake Basin of China: Source Identification and Policy Implications. *Environ. Manage.* 51, 724-737.

Mahmoud, M., Tawfik, A., El-Gohary, F., 2011. Use of down-flow hanging sponge (DHS) reactor as a promising post-treatment system for municipal wastewater. *Chemical Engineering Journal* 168, 535-543.

Massoud, M.A., Tarhini, A., Nasr, J.A., 2009. Decentralized approaches to wastewater treatment and management: Applicability in developing countries. *J. Environ. Manage.* 90, 652-659.

Onodera, T., Yoochatchaval, W., Sumino, H., Mizuochi, M., Okadera, T., Fujita, T., Banjongproo, P., Syutsubo, K., 2014. Pilot-scale experiment of down-flow hanging sponge for direct treatment of low-strength municipal wastewater in Bangkok, Thailand. *Bioprocess and biosystems engineering* 37, 2281-2287.

Su, J.Q., Wei, B., Ou-Yang, W.Y., Huang, F.Y., Zhao, Y., Xu, H.J., Zhu, Y.G., 2015. Antibiotic Resistome and Its Association with Bacterial Communities during Sewage Sludge Composting. *Environmental Science & Technology* 49, 7356-7363.

Uemura, S., Suzuki, S., Abe, K., Kubota, K., Yamaguchi, T., Ohashi, A., Takemura, Y., Harada, H., 2010. Removal of organic substances and oxidation of ammonium nitrogen by a down-flow hanging sponge (DHS) reactor under high salinity conditions. *Bioresource technology* 101, 5180-5185.

WHO, 2015. Lack of sanitation for 2.4 billion people is undermining health improvements.

# Combined Ion Exchange and Biological Nitrogen Removal in a Novel Two-Stage Biofiltration System

Ref # S2SMALL-40670

L.C. Rodriguez-Gonzalez<sup>1\*</sup>, K. Payne<sup>1</sup>, M. Henderson<sup>1</sup>, D. Anderson<sup>2</sup>, M. Trotz<sup>1</sup>, S. Ergas<sup>1</sup>

<sup>1</sup> Department of Civil and Environmental Engineering, University of South Florida, Tampa, Florida, USA

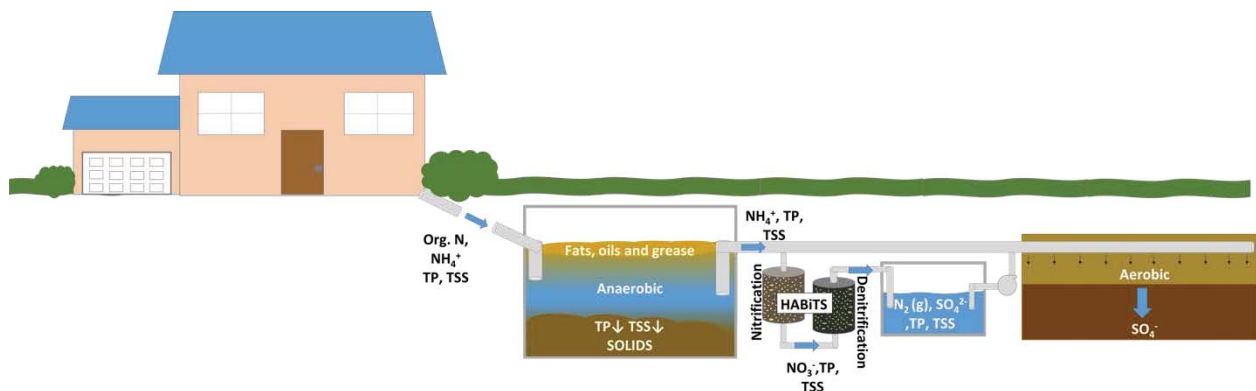
<sup>2</sup> Hazen and Sawyer, Tampa, Florida, USA

\* Presenting Author: [lauracamille@mail.usf.edu](mailto:lauracamille@mail.usf.edu)

**Keywords:** ion exchange, biological nitrogen removal, onsite wastewater systems

## INTRODUCTION / MAIN METHODS

Onsite wastewater treatment systems (OWTs) are both simple and relatively inexpensive but have been found to have significant impacts in some watersheds due to their limited nitrogen removal. Packed bed bioreactors are often applied in OWTs to achieve biological nitrogen removal (BNR) but their performance can be hindered by the highly transient loadings typical of these systems. Previous studies have investigated the addition of IX and adsorptive materials within BNR processes with promising results. The addition of clinoptilolite has been found to improve nitrogen removal in passive nitrification OWTs resulting in enhanced  $\text{NH}_4^+$  removal (FOSNRS, 2015; Rodriguez-Gonzalez et al., 2016). Krayzelova et al. (2014) combined  $\text{NO}_3^-$  sorption onto scrap tire chips and sulfur oxidizing denitrification in a bench-scale biofilter and effectively removed 90% of nitrate under steady state, variable flow and concentration influent conditions. This study investigates a Hybrid Adsorption and Biological Treatment System (HABiTS) that combines ion exchange (IX) materials and BNR to effectively remove nitrogen and buffer transient loadings. In HABiTS, ionic forms of nitrogen ( $\text{NH}_4^+$ ,  $\text{NO}_3^-$ ) exceeding the system's biodegradation capacity are adsorbed during high loading periods, while desorption occurs during low or no loading periods. The desorbed nitrogen is then utilized by the microbial population, effectively regenerating the material. The overall goal of this research is to apply HABiTS for total nitrogen removal in OWTs under controlled conditions. This paper discusses a two-stage HABiTS treatment and evaluates its performance under transient loading conditions.



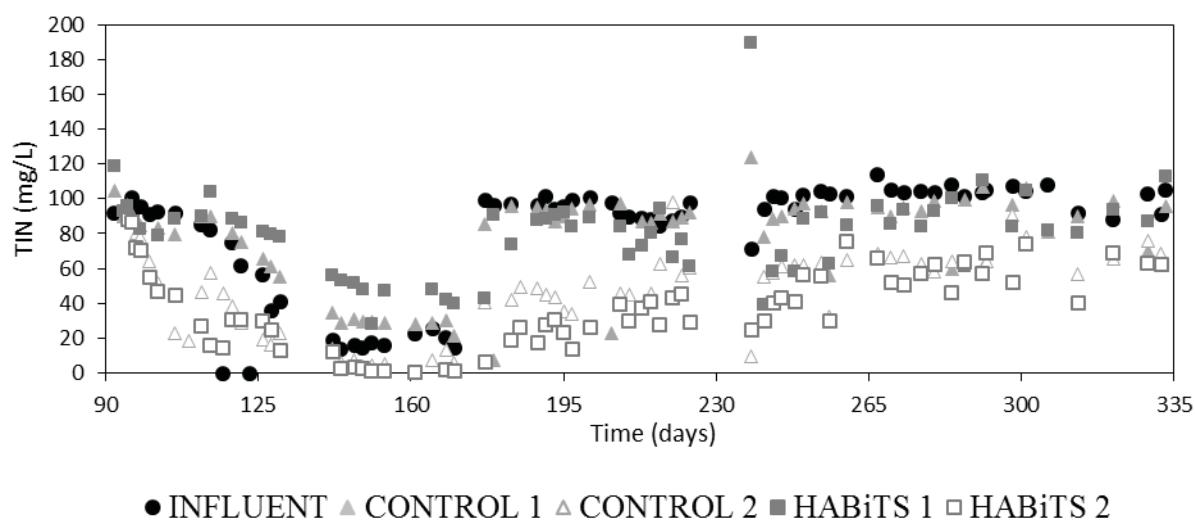
**Figure 1.** HABiTS enhanced OWTs



Two side-by-side biofilters were constructed, both with a passive aerobic column for nitrification (Stage 1; 88.9 mm D, 406 mm L) and an anoxic column for denitrification (Stage 2; 52 mm D, 350 mm L). The HABiTS treatment contained 20% clinoptilolite and 80% expanded clay for Stage 1 and tire chips, sulfur pellets and oyster shells for Stage 2. The control treatment employed only the expanded clay medium as a biofilm carrier in Stage 1 and non-sorptive plastic carriers instead of the tire scraps for Stage 2. For both treatments, Stage 1 was operated for 80 days prior to Stage 2 integration to ensure proper nitrification conditions (Rodriguez-Gonzalez et al., 2016). An 8 L bench-scale septic tank fed both biofilters at a rate of 1.3 L/day. The influent to the septic tank was screened raw domestic wastewater amended with urea to increase  $\text{NH}_4^+\text{-N}$  concentration. The influent was applied per the National Sanitation Foundation Standard 40, where 35%, 25% and 45% of the daily volume was distributed between 6 to 8am, 11 to 2pm and 6 to 8pm, respectively. Samples were collected three times per week and analyzed for N species and other water quality parameters.

## MAIN RESULTS AND CONCLUSIONS

Total Inorganic Nitrogen (TIN) concentrations for the influent, control, and HABiTS treatments are shown in Figure 1. On average,  $\text{NH}_4^+\text{-N}$  concentration in the influent was  $80.56 \pm 30.66$  mg/L (Table 1). From day 106 to 168 a drop in TIN in the influent was observed. This drop resulted in improved performance for both treatments with effluent TIN concentrations below 5 mg/L. On day 177 influent concentrations reached the desired 100 mg/L resulting in a sharp increase in the effluent of the control treatment (40 mg/L) while HABiTS only increased to 7 mg/L. Concentrations continued to climb for both treatments but were noticeably slower for HABiTS. Under these conditions nitrification was the predominant treatment over the IX resulting in similar  $\text{NH}_4^+\text{-N}$  removal and  $\text{NO}_3^-\text{-N}$  production in the first stage of both treatments.



**Figure 2.** TIN daily variation in the influent, control and HABiTS columns effluent under variable HLR. (Rodriguez-Gonzalez, 2017)

Startup of Stage 2 was observed between day 95 and 113. Transient  $\text{NO}_2^-\text{-N}$  production was observed for the effluent of HABiTS Stage 2 but not for the control Stage 2 column during this period. In HABiTS, leaching of carbon from the tire mulch, as reported by Krayzelova et al. (2014), could have allowed partial heterotrophic denitrification to occur resulting in high  $\text{NO}_2^-\text{-N}$  production. In time and due to the high availability of elemental sulfur, SOD startup was observed and  $\text{NO}_2^-\text{-N}$  concentrations dropped to below 1 mg/L. Samples collected on day

113 showed that HABiTS Stage 2 removed 97% of the  $\text{NO}_3^-$ -N while only 64% of it was removed in the control Stage 2 column, indicating faster denitrification in HABiTS possibly due to the partial heterotrophic denitrification as discussed previously. The high removal of  $\text{NO}_3^-$ -N correlated with increased  $\text{SO}_4^{2-}$ -S in the effluent resulting in a productivity of 2.30 mg  $\text{SO}_4^{2-}$ -S/mg  $\text{NO}_3^-$ -N. This calculated productivity is higher than that from the stoichiometric value of 1.6 mg  $\text{SO}_4^{2-}$ -S/ mg  $\text{NO}_3^-$ -N. Overall, HABiTS outperformed the control column by removing 53.94% of the  $\text{NO}_3^-$ -N produced compared to 40.94% removed in the control treatment, possibly due to adsorption onto the tire chips. No significant difference was observed in the production of  $\text{SO}_4^{2-}$ -S. Due to this versatility, HABiTS presents a feasible alternative for the enhancement of OWTS.

**Table 1.** Average water quality results for influent, control and HABiTS columns.

Parameter	Influent	Control Stage 1	Control Stage 2	HABiTS Stage 1	HABiTS Stage 2
pH	7.52 ±0.41	6.21 ±0.77	6.54 ±0.32	5.91 ±1.29	6.64 ±0.33
DO (mg/L)	0.85 ±0.49	5.06 ±1.06	3.53 ±1.45	4.87 ±1.51	3.34 ±1.68
$\text{NH}_4^+$ -N (mg/L)	80.56 ±30.66	19.79 ±17.07	21.82 ±16.08	21.51 ±13.99	20.25 ±12.90
$\text{NO}_2^-$ -N (mg/L)	0.97 ±0.91	0.50 ±0.54	0.67 ±0.74	0.57 ±0.75	1.49 ±2.98
$\text{NO}_3^-$ -N (mg/L)	0.07 ±0.17	58.96 ±21.86	25.68 ±15.12	58.60 ±23.47	16.17 ±15.96
TIN (mg/L)	81.59 ±31.74	79.25 ±39.47	48.18 ±31.94	80.68 ±38.21	37.91 ±31.84
$\text{SO}_4^{2-}$ -S (mg/L)	22.48 ±16.22	42.31 ±16.79	74.14 ±23.62	43.48 ±9.02	70.90 ±22.48
COD(mg/L)	88.75 ±33.50	22.00 ±14.79	42.59 ±26.42	28.40 ±7.27	45.44 ±24.06

## REFERENCES

FOSNRS, (2015). *Florida Onsite Sewage Nitrogen Reduction Strategies Study: Final Report*. Retrieved from the Florida Department of Health (FDOH) website: [www.floridahealth.gov](http://www.floridahealth.gov)

Krayzelova, L., Lynn, T.J., Banihani, Q., Bartacek, J., Jenicek, P., Ergas, S.J. (2014). A Tire-Sulfur Hybrid Adsorption Denitrification process for decentralized wastewater treatment. *Water Research* 61, 191-199.

Rodriguez-Gonzalez, L., Payne, K., Trotz, M., Anderson, D., Ergas, S.J. (2016) Hybrid Adsorption and Biological Treatment System (HABiTS) for enhanced nitrogen removal in onsite wastewater treatment systems. In *Proc. at the 13th IWA Specialized Conference on Small Water and Wastewater Systems (SWWS) and the 5th IWA Specialized Conference on Resources-Oriented Sanitation (ROS)*. Athens, Greece on Sept. 14 to 16.

## ACKNOWLEDGEMENTS

This publication was made possible by USEPA grant 83556901 and NSF grant 1243510. Its contents are solely the responsibility of the grantee and do not necessarily represent the official views of these agencies. Further, these agencies do not endorse the purchase of any commercial products or services mentioned in the publication.

# A sensitivity analysis for sulfur-driven two-step denitrification model

Ref # S2SMALL- 94490

A. Kostrytsia<sup>1\*</sup>, S. Papirio<sup>2</sup>, M. R. Mattei<sup>3</sup>, L. Frunzo<sup>3</sup>, P. N. L. Lens<sup>4</sup>,

G. Esposito<sup>1</sup>

<sup>1</sup> Department of Civil and Mechanical Engineering, University of Cassino and Southern Lazio, via Di Biasio 43, 03043 Cassino (FR), Italy

<sup>2</sup> Department of Civil, Architectural and Environmental Engineering, University of Naples Federico II, via Claudio 21, 80125 Naples, Italy

<sup>3</sup> Department of Mathematics and Applications Renato Caccioppoli, University of Naples Federico II, via Cintia, Monte S. Angelo, 1-80126 Naples, Italy

<sup>4</sup> UNESCO-IHE, Institute for Water Education, PO Box 3015, 2601 DA Delft, The Netherlands

\* Corresponding Author: [kostritsia@gmail.com](mailto:kostritsia@gmail.com)

**Abstract:** A local sensitivity analysis was performed for a S<sup>0</sup>-driven two-step denitrification model, accounting for NO<sub>2</sub><sup>-</sup> accumulation, biomass growth and S<sup>0</sup> solubilization. The model sensitivity was aimed at verifying the model stability, understanding the identifiability of the model structure and evaluating the model parameters to be further optimized. The sensitivity analysis identified the mass specific area of the sulfur particles ( $a^*$ ) and hydrolysis kinetic constant ( $k_l$ ) as the dominant parameters. Additionally, the maximum growth rate of the denitrifying biomass on NO<sub>3</sub><sup>-</sup> ( $\mu^{max}_{2,3}$ ) and NO<sub>2</sub><sup>-</sup> ( $\mu^{max}_{2,4}$ ) were detected as the most sensitive kinetic parameters. Further calibration would be performed for the sensitive model parameters to optimize the quality of the model.

**Keywords:** biological surface based hydrolysis; elemental sulfur; modeling; sensitivity analysis; two-step autotrophic denitrification.

## INTRODUCTION

Both nitrate (NO<sub>3</sub><sup>-</sup>) and nitrite (NO<sub>2</sub><sup>-</sup>) are considered as environmental pollutants in groundwater and surface water (Kilic et al., 2014). High NO<sub>3</sub><sup>-</sup> and NO<sub>2</sub><sup>-</sup> concentrations are associated with various negative environmental and human health impacts. An elevated NO<sub>3</sub><sup>-</sup> concentration in fresh waters leads to many environmental problems, such as eutrophication, loss of crop productivity and aquatic biodiversity. Also, a high NO<sub>3</sub><sup>-</sup> concentration has an adverse effect on human health. It might cause methemoglobinemia (also known as "blue baby" disease) and bring higher risk of cancer (Liu et al., 2016). Thus, the guidance value of 50 mg/l for NO<sub>3</sub><sup>-</sup> was set for drinking water (WHO, 2011). The highly toxic nature of NO<sub>2</sub><sup>-</sup> to both humans and aquatic life resulted in a stringent limit as low as 3 mg/l in drinking water (WHO, 2011).

$\text{NO}_3^-$  and  $\text{NO}_2^-$  removal from wastewaters and drinking water can be performed by physico-chemical or biological processes. However, physico-chemical processes, including ion exchange, reverse osmosis and chemical reduction, are quite costly and energy-demanding (Sierra-Alvarez et al., 2007). Therefore, biological removal of  $\text{NO}_3^-$  (denitrification) and  $\text{NO}_2^-$  (denitritation) from waters could be applied.

Depending on the type of energy source used, denitrification can be maintained heterotrophically by using organic compounds, or autotrophically with inorganic compounds. Heterotrophic denitrification is a proven technology, widely applied at the industrial scale. However, autotrophic denitrification has been suggested as an alternative treatment for those waters poor in carbon content (e.g. drinking water) due to the costly supplementation of organics (Sierra-Alvarez et al., 2007). Moreover, autotrophic denitrification shows the following advantages 1) reduced sludge production and handling; 2) decreased risk of bacterial contamination; and 3) lower operating cost of the process due to use of inorganic carbon compounds as a carbon source (Sierra-Alvarez et al., 2007; Zhou et al., 2015). Therefore, autotrophic denitrification is a promising and sustainable process to treat  $\text{NO}_3^-$  and  $\text{NO}_2^-$  pollution not only from industrial wastewaters, but also small drinking water systems.

Elemental sulfur ( $\text{S}^0$ ) is one of the most promising electron donor for autotrophic denitrification due to its low cost, non-toxicity and easy handling (Christianson et al., 2015; Di Capua et al., 2015; Kilic et al., 2014; Soares, 2002). However, chemically produced  $\text{S}^0$  has a low solubility, which limits its application in autotrophic denitrification and denitritation and the scale-up of the processes. To guarantee higher denitrification rates, smaller  $\text{S}^0$  particles, with a higher specific surface area, can be used (Di Capua et al., 2016). Therefore, the specific surface area of the  $\text{S}^0$  particles is one of the key parameters to be considered during  $\text{S}^0$  solubilization in the autotrophic denitrification and denitritation processes (Sierra-Alvarez et al., 2007).

When  $\text{NO}_3^-$  and  $\text{NO}_2^-$  are removed in the presence of elemental  $\text{S}^0$ , pH decreases and this may result in an inhibitory effects for autotrophic denitrifiers if the system is not adequately buffered (Soares, 2002). Therefore, the use of limestone as a buffering agent and inorganic carbon source is a common practice within the so-called 'sulfur-limestone autotrophic denitrification (SLAD)' process (Sahinkaya et al., 2015).

Over the last decades, several mathematical models accounting for  $\text{S}^0$ -driven autotrophic denitrification have been proposed. In most of them, zero- or half-order reactions have been applied to describe the simplified  $\text{S}^0$ -driven autotrophic denitrification kinetics without accounting for microbial growth (Koenig and Liu, 2001; Moon et al., 2004; Qambrani et al., 2015; Zhang and Zeng, 2006). The two-step autotrophic denitrification with thiosulfate ( $\text{S}_2\text{O}_3^{2-}$ ) and  $\text{S}^0$  was described by Monod equations (Mora et al., 2015). However,  $\text{NO}_2^-$  evolution has been poorly predicted in the models. Xu et al. (2016) established a kinetic model for two-step autotrophic denitrification with hydrogen sulfide ( $\text{H}_2\text{S}$ ) that accurately predicted the concentration of intermediate  $\text{NO}_2^-$  as well as  $\text{SO}_4^{2-}$  as end product. Recently, Liu et al. (2016) have developed a model for three-step autotrophic denitrification linked to  $\text{H}_2\text{S}$  and  $\text{S}^0$  oxidation with a focus on  $\text{N}_2\text{O}$  accumulation. However, none of the developed models distinctly accounted for  $\text{S}^0$  solubilization as a prior step to autotrophic denitrification and denitritation (Sierra-Alvarez et al., 2007).

In a recent study, a mechanistic model accounting for  $\text{NO}_2^-$  accumulation, biomass growth and  $\text{S}^0$  solubilization has been proposed (Kostrzytsia et al., 2017). As demonstrated through numerical simulations, the developed model could serve as a tool to predict the performance of SLAD biofilm systems and assess their process efficiency when compared to other denitrification systems. In the present work, the model developed in (Kostrzytsia et al., 2017)

was recalled and a sensitivity analysis was applied to verify the model stability as well as define the model parameters to be further optimized. Specifically, our focus was to use local sensitivity analysis to better understand the dominant parameters of the process and possibly reduce the complexity of the model.

## MATERIALS AND METHODS

### Mathematical model overview

A mathematical model was developed in (Kostrysia et al., 2017) to dynamically simulate the main processes occurring during the two-step denitrification with  $S^0$  ( $S_1$ ). The proposed model takes into account the activities of autotrophic denitrifying bacteria ( $X_2$ ) using  $NO_3^-$  ( $S_3$ ) or  $NO_2^-$  ( $S_4$ ) as electron acceptors and a hydrolytic biomass ( $X_1$ ) growing on  $S^0$  lentils. It evaluates the interactions between the related processes:  $S^0$  solubilization,  $S^0$ -based denitrification and denitrification.  $S^0$  uptake was modeled by introducing a new variable, the bioavailable sulfur ( $S_2$ ), a soluble compound that can be directly uptaken by denitrifying bacteria for further oxidation to  $SO_4^{2-}$  ( $S_6$ ). A modified surface based kinetics equation was introduced to account for the hydrolysis of  $S^0$  (Esposito et al., 2011). The model equations were derived from mass balances and expressed as double-Monod kinetics (Eq. 1-8). They can be written as follows:

$$\frac{dS_1}{dt} = -k_1 \frac{S_1}{K_{1/2} + S_1} X_1, \quad (1)$$

$$\frac{dS_2}{dt} = k_1 \frac{S_1}{K_{1/2} + S_1} X_1 - \frac{r_1}{Y_{2,3}} \mu_{2,3}^{max} \frac{S_2}{K_{2,2} + S_2} \frac{(S_3 - S_3^*)}{K_{2,3} + (S_3 - S_3^*)} \frac{S_3}{S_3 + S_4} X_2 - \frac{r_2}{Y_{2,4}} \mu_{2,4}^{max} \frac{S_2}{K_{2,2} + S_2} \frac{(S_4 - S_4^*)}{K_{2,4} + (S_4 - S_4^*)} \frac{S_4}{S_3 + S_4} X_2, \quad (2)$$

$$\frac{dS_3}{dt} = -\frac{1}{Y_{2,3}} \mu_{2,3}^{max} \frac{S_2}{K_{2,2} + S_2} \frac{(S_3 - S_3^*)}{K_{2,3} + (S_3 - S_3^*)} \frac{S_3}{S_3 + S_4} X_2, \quad (3)$$

$$\frac{dS_4}{dt} = \frac{1}{Y_{2,3}} \mu_{2,3}^{max} \frac{S_2}{K_{2,2} + S_2} \frac{(S_3 - S_3^*)}{K_{2,3} + (S_3 - S_3^*)} \frac{S_3}{S_3 + S_4} X_2 - \frac{1}{Y_{2,4}} \mu_{2,4}^{max} \frac{S_2}{K_{2,2} + S_2} \frac{(S_4 - S_4^*)}{K_{2,4} + (S_4 - S_4^*)} \frac{S_4}{S_3 + S_4} X_2, \quad (4)$$

$$\frac{dS_5}{dt} = \frac{1}{Y_{2,4}} \mu_{2,4}^{max} \frac{S_2}{K_{2,2} + S_2} \frac{(S_4 - S_4^*)}{K_{2,4} + (S_4 - S_4^*)} \frac{S_4}{S_3 + S_4} X_2, \quad (5)$$

$$\frac{dS_6}{dt} = \frac{r_1}{Y_{2,3}} \mu_{2,3}^{max} \frac{S_2}{K_{2,2} + S_2} \frac{(S_3 - S_3^*)}{K_{2,3} + (S_3 - S_3^*)} \frac{S_3}{S_3 + S_4} X_2 + \frac{r_2}{Y_{2,4}} \mu_{2,4}^{max} \frac{S_2}{K_{2,2} + S_2} \frac{(S_4 - S_4^*)}{K_{2,4} + (S_4 - S_4^*)} \frac{S_4}{S_3 + S_4} X_2, \quad (6)$$

$$\frac{dX_1}{dt} = K_0 k_1 \frac{S_1}{K_{1/2} + S_1} X_1 - k_{d,1} X_1, \quad (7)$$

$$\frac{dX_2}{dt} = \mu_{2,3}^{max} \frac{S_2}{K_{2,2} + S_2} \frac{(S_3 - S_3^*)}{K_{2,3} + (S_3 - S_3^*)} \frac{S_3}{S_3 + S_4} X_2 + \mu_{2,4}^{max} \frac{S_2}{K_{2,2} + S_2} \frac{(S_4 - S_4^*)}{K_{2,4} + (S_4 - S_4^*)} \frac{S_4}{S_3 + S_4} X_2 - k_{d,2} \cdot X_2, \quad (8)$$

where  $K_0$  denoted the efficiency growth coefficient for hydrolytic biomass;  $Y_{2,3}$  and  $Y_{2,4}$  represented the denitrifying biomass yield coefficients on  $NO_3^-$  and  $NO_2^-$  respectively;  $a^*$  denoted the mass specific area of the sulfur particles;  $k_1$  denoted the hydrolysis kinetic constant;  $K_i$  indicated the volume specific half-saturation constants for  $S^0$ ;  $\mu_{2,3}^{max}$  and  $\mu_{2,4}^{max}$

represented the maximum growth rate for denitrifying biomass on  $\text{NO}_3^-$  and  $\text{NO}_2^-$ , respectively;  $k_{d,1}$  and  $k_{d,2}$  represented the decay constants for  $X_1$  and  $X_2$  biomass, respectively;  $K_{2,2}$ ,  $K_{2,3}$  and  $K_{2,4}$  denoted the half-saturation constants for  $\text{S}^0$ ,  $\text{NO}_3^-$  and  $\text{NO}_2^-$ , respectively;  $S_3^*$  and  $S_4^*$  indicated the lowest  $\text{NO}_2^-$  and  $\text{NO}_3^-$  concentrations that enable metabolic activities of  $X_2$ . The obtained ordinary differential equations were integrated by using an original software developed on the MATLAB platform and based on the Runge-Kutta method.

### Sensitivity analysis

The proposed model requires a high dimensional (stoichiometric and kinetic) parameter space to be explored. To estimate each parameter, excessive experimental results should be provided to avoid ill-conditioning of the parameter estimation (Kesavan and Law, 2005). Therefore, a model sensitivity analysis was performed to reduce the parameter space of the model as well as identify parameter targets for experimental exploration (Jarrett et al., 2015). The change of the dominant parameters resulted in a high sensitivity of the model outputs. In contrast, the variation of the non-significant parameters indicated a low sensitivity.

In this model, a local sensitivity analysis was applied to compute sensitivity functions for the dynamic simulations. The sensitivities were calculated in terms of the effect of the perturbation on the model output over a time span because of the change in the input parameters.

An automatic differentiation tool SENS\_SYS coupled with the ordinary differential equation (ODE) solver of MATLAB was used to predict local sensitivity. SENS\_SYS tool is an extension of the ODE15s tool that allows to solve ODE system while compute derivatives (sensitivities) of the solution with respect to parameters (Molla and Padilla, 2002). The accuracy of the SENS\_SYS tool is controlled by the default relative tolerance of  $1e^{-6}$ . The sensitivity analysis of the system  $F$  (Eqs. 3-4,6) was calculated by differentiating the system with respect to kinetic parameter  $u$ , as illustrated in **Eq. (9)**.

$$F(t, y, y', u) = 0 \tag{9}$$

where  $t$  denoted the time interval for the integration (days),  $y$  represented input state variables,  $y'$  the first derivative of  $y$  with respect to  $t$  and  $u$  denoted the parameter.

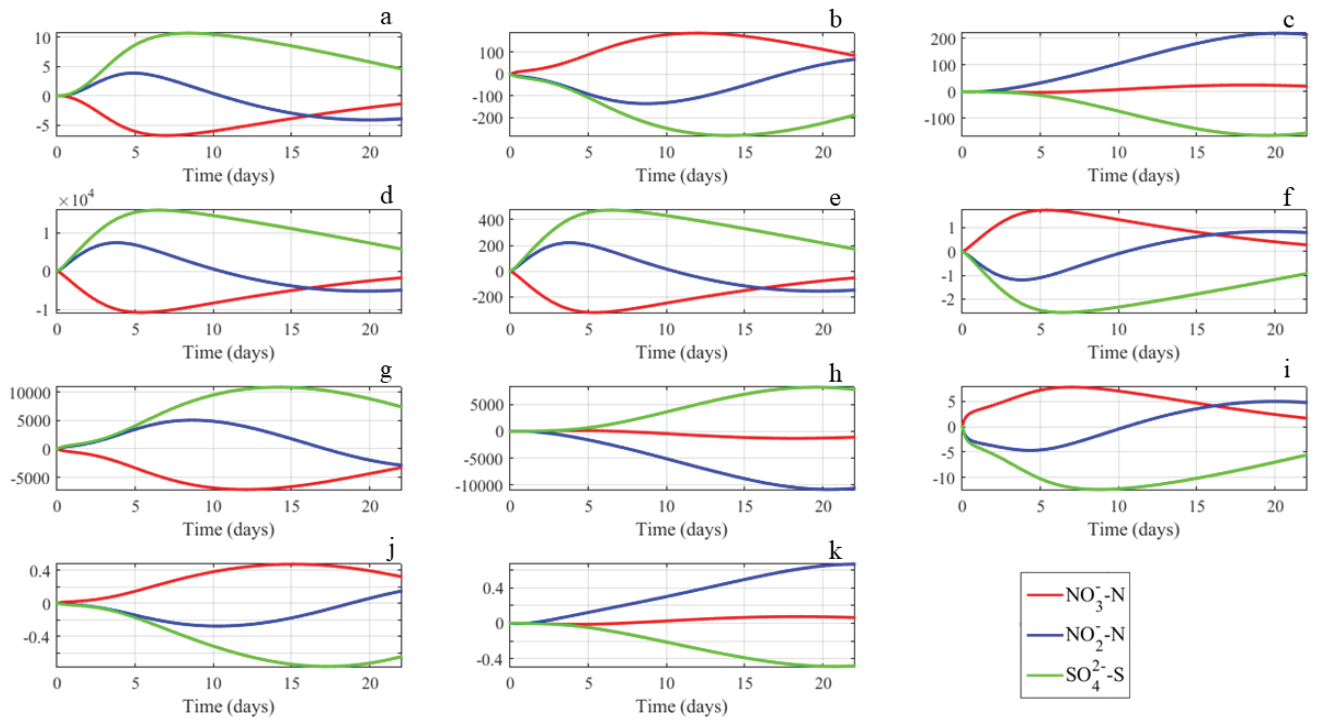
The stoichiometric parameters of the model were based on the biotransformation mechanism and determined in the previous experimental studies (Sierra-Alvarez et al., 2007). The biomass decay rate for most autotrophic microorganisms are very low. The threshold values for substrates ( $\text{NO}_3^-$  and  $\text{NO}_2^-$ ), which represented the inability of microorganisms to grow below these values, described the characteristics of the enriched microbial community and were determined experimentally. Therefore, in the proposed model the above-mentioned parameters were not considered for the sensitivity analysis and the remaining 11 kinetic parameters were tested.

## RESULTS AND DISCUSSION

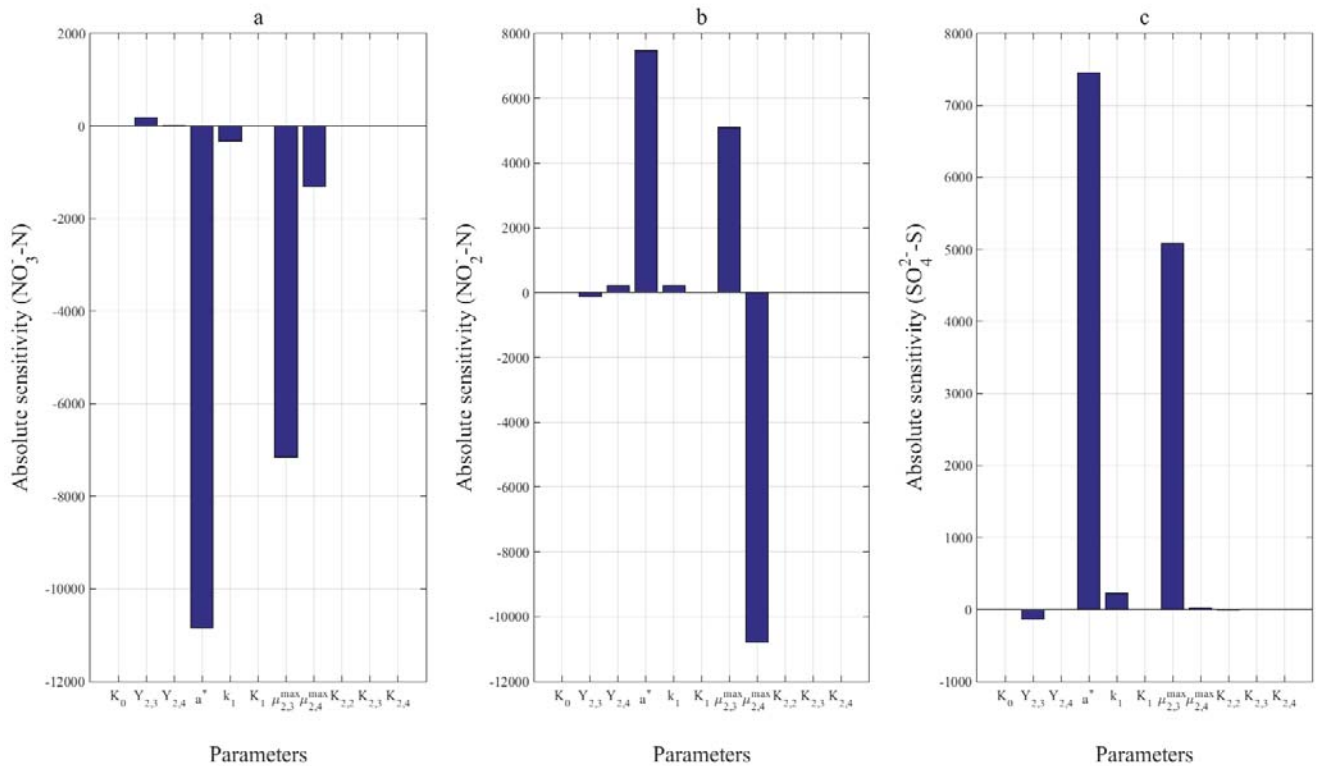
A series of sensitivity curves were obtained by changing the 11 kinetic parameters one by one in the simulation and absolute sensitivity was calculated, as illustrated in **Figure 1**. The greater parameter line slope indicates the more significant role of the parameter on the autotrophic denitrification process. **Figure 2** demonstrates the absolute sensitivities of the kinetic parameters for the input state variables of 210, 0 and 0, for  $\text{NO}_3^-$ -N,  $\text{NO}_2^-$ -N and  $\text{SO}_4^{2-}$ -



S, respectively. The values of the parameters (stoichiometric and kinetic) used for the model (Eqs.1 - 8) are reported in (Kostrzytsia et al., 2017).



**Figure 1.** Output absolute (or local) sensitivity of different parameters: (a)  $K_0$ , (b)  $Y_{2,3}$ , (c)  $Y_{2,4}$ , (d)  $a^*$ , (e)  $k_1$ , (f)  $K_1$ , (g)  $\mu^{max}_{2,3}$ , (h)  $\mu^{max}_{2,4}$ , (i)  $K_{2,2}$ , (j)  $K_{2,3}$  and (k)  $K_{2,4}$ .



**Figure 2.** Absolute (or local) sensitivities of kinetic parameters during the simulation time for the degradation of (a)  $\text{NO}_3^-$ -N, (b)  $\text{NO}_2^-$ -N and (c)  $\text{SO}_4^{2-}$ -S production.

Apparently, the mass specific area of the sulfur particles ( $a^*$ ) possessed a major influence on the model outputs and was ranked as a first dominant parameter (**Figure 2**). Parameter  $a^*$  accounts for the overall surface area of the sulfur particles to be microbially solubilized prior to denitrification and denitritation. Additionally, the parameter considers the particle size distribution. As illustrated in **Figure 1d**,  $\text{NO}_3^-$ -N output is more sensitive to the change in parameter  $a^*$ , compared to  $\text{NO}_2^-$ -N. The latter might be attributed to the higher stoichiometric S/N ratio required for complete denitrification than for denitritation.

These results were consistent with the literature, where the impact of the specific surface area of sulfur particles was suggested as a prerequisite of  $\text{S}^0$  oxidation coupled to denitrification. Therefore, the proposed model was able to successfully describe  $\text{S}^0$  solubilization as an inevitable aspect and limiting step in the denitrification and denitritation processes.

Among the other parameters related to the  $\text{S}^0$  solubilization step, the hydrolysis kinetic constant ( $k_I$ ), being dependent on the nature of the sulfur, could be considered as a sensitive one. The absolute sensitivity of both parameters,  $a^*$  and  $k_I$ , showed a peak between 5 and 10 days, and then slowly dropped. Consequently, the model predictions are crucial during that phase. On the other hand, the efficiency growth coefficient for hydrolytic biomass ( $K_0$ ) and volume specific half-saturation constant for  $\text{S}^0$  ( $K_I$ ) did not significantly influence the model outputs.

The second and third most sensitive kinetic parameters were the maximum growth rate for denitrifying biomass on  $\text{NO}_3^-$  ( $\mu^{max}_{2,3}$ ) and  $\text{NO}_2^-$  ( $\mu^{max}_{2,4}$ ), as illustrated in **Figure 2**. As expected,  $\mu^{max}_{2,3}$  played a crucial role for model outputs (**Figure 1g**). However,  $\mu^{max}_{2,4}$  had a high sensitivity only for  $\text{NO}_2^-$ -N and  $\text{SO}_4^{2-}$ -S outputs (**Figure 1h**). The  $\text{SO}_4^{2-}$ -S absolute sensitivity of 10000 was reached for  $\mu^{max}_{2,3}$  compared to that of 7500 for  $\mu^{max}_{2,4}$ . That might be attributed to the higher metabolic activities rates, in particular  $\text{S}^0$  oxidation to  $\text{SO}_4^{2-}$ , of denitrifying bacteria growing on  $\text{NO}_3^-$  ( $\mu^{max}_{2,3}$ ) than  $\text{NO}_2^-$ .

Denitrifying biomass yield coefficient on  $\text{NO}_3^-$  ( $Y_{2,3}$ ) possessed high sensitivity for  $\text{NO}_3^-$ -N,  $\text{NO}_2^-$ -N and  $\text{SO}_4^{2-}$ -S outputs (**Figure 1b**). Instead, yield coefficients on  $\text{NO}_2^-$  ( $Y_{2,4}$ ) affected only  $\text{NO}_2^-$ -N and  $\text{SO}_4^{2-}$ -S outputs (**Figure 1b**). On the other hand, half-saturation constants for  $\text{S}^0$  ( $K_{2,2}$ ),  $\text{NO}_3^-$  ( $K_{2,3}$ ) and  $\text{NO}_2^-$  ( $K_{2,4}$ ) had a minimal impact for the model outputs (**Figure 1i-k**). To get an accurate evaluation of the half-saturation constants, a larger set of experimental data would be required; for example, they could be obtained from kinetic tests with different initial substrate concentrations.

Therefore, the sensitive parameters, such as  $a^*$ ,  $k_I$ ,  $\mu^{max}_{2,3}$  and  $\mu^{max}_{2,4}$  were indicated for model outputs by sensitivity analysis. Further calibration is required for the most sensitive model parameters to improve the quality of the model.

## CONCLUSIONS

In this work, the results of a local sensitivity analysis performed for the newly developed model (Kostrysia et al., 2017) were presented. The model was able to dynamically describe the biological and physico-chemical processes occurring during autotrophic denitrification with  $\text{S}^0$ , such as  $\text{NO}_2^-$  accumulation, biomass growth and  $\text{S}^0$  surface based solubilization. The sensitivity analysis demonstrated that the model was more sensitive to  $a^*$ ,  $k_I$ ,  $\mu^{max}_{2,3}$  and  $\mu^{max}_{2,4}$ . The model calibration will be performed only for the dominant parameters to increase the quality of model and reduce its complexity.

## REFERENCES

- Christianson, L., Lepine, C., Tsukuda, S., Saito, K., Summerfelt, S., 2015. Nitrate removal effectiveness of fluidized sulfur-based autotrophic denitrification biofilters for recirculating aquaculture systems. *Aquac. Eng.* 68, 10–18. doi:10.1016/j.aquaeng.2015.07.002
- Di Capua, F., Papirio, S., Lens, P.N.L., Esposito, G., 2015. Chemolithotrophic denitrification in biofilm reactors. *Chem. Eng. J.* 280, 643–657. doi:10.1016/j.cej.2015.05.131
- Esposito, G., Frunzo, L., Panico, A., Pirozzi, F., 2011. Model calibration and validation for OFMSW and sewage sludge co-digestion reactors. *Waste Manag.* 31, 2527–2535. doi:10.1016/j.wasman.2011.07.024
- Jarrett, A.M., Liu, Y., Cogan, N.G., Hussaini, M.Y., 2015. Global sensitivity analysis used to interpret biological experimental results. *J. Math. Biol.* 71, 151–170.
- Kesavan, P., Law, V.J., 2005. Practical identifiability of parameters in Monod kinetics and statistical analysis of residuals. *Biochem. Eng. J.* 24, 95–104.
- Kilic, A., Sahinkaya, E., Cinar, O., 2014. Kinetics of autotrophic denitrification process and the impact of sulphur/limestone ratio on the process performance. *Environ. Technol.* 35, 2796–804. doi:10.1080/09593330.2014.922127
- Koenig, A., Liu, L.H., 2001. Kinetic model of autotrophic denitrification in sulphur packed-bed reactors. *Water Res.* 35, 1969–1978. doi:10.1016/S0043-1354(00)00483-8
- Kostrysia, A., Papirio, S., Frunzo, L., Mattei, M.R., Porca, E., Collins, G., Lens, P.N.L., Esposito, G., 2017. Two-step autotrophic denitrification kinetics and microbially catalyzed sulfur solubilization (submitted).
- Liu, Y., Peng, L., Ngo, H.H., Guo, W., Wang, D., Pan, Y., Sun, J., Ni, B.J., 2016. Evaluation of nitrous oxide emission from sulfide- and sulfur-based autotrophic denitrification processes. *Environ. Sci. Technol.* 50, 9407–9415. doi:10.1021/acs.est.6b02202
- Molla, V.M.G., Padilla, R.G., 2002. Description of MATLAB functions SENS\_SYS and SENS\_IND. Universidad Politecnica de Valencia, Spain.
- Moon, H.S., Ahn, K.H., Lee, S., Nam, K., Kim, J.Y., 2004. Use of autotrophic sulfur-oxidizers to remove nitrate from bank filtrate in a permeable reactive barrier system. *Environ. Pollut.* 129, 499–507. doi:10.1016/j.envpol.2003.11.004
- Mora, M., Dorado, A.D., Gamisans, X., Gabriel, D., 2015. Investigating the kinetics of autotrophic denitrification with thiosulfate: Modeling the denitrification mechanisms and the effect of the acclimation of SO-NR cultures to nitrite. *Chem. Eng. J.* 262, 235–241. doi:10.1016/j.cej.2014.09.101
- Qambrani, N.A., Jung, Y.S., Yang, J.E., Ok, Y.S., Oh, S.-E., 2015. Application of half-order kinetics to sulfur-utilizing autotrophic denitrification for groundwater remediation. *Environ. Earth Sci.* 73, 3445–3450. doi:10.1007/s12665-014-3641-7
- Sahinkaya, E., Yurtsever, A., Aktaş, Ö., Ucar, D., Wang, Z., 2015. Sulfur-based autotrophic denitrification of drinking water using a membrane bioreactor. *Chem. Eng. J.* 268, 180–186. doi:10.1016/j.cej.2015.01.045
- Sierra-Alvarez, R., Beristain-Cardoso, R., Salazar, M., Gómez, J., Razo-Flores, E., Field, J. a., 2007. Chemolithotrophic denitrification with elemental sulfur for groundwater treatment. *Water Res.* 41, 1253–1262. doi:10.1016/j.watres.2006.12.039
- Soares, M.I.M., 2002. Denitrification of groundwater with elemental sulfur. *Water Res.* 36, 1392–1395. doi:10.1016/S0043-1354(01)00326-8
- WHO, 2011. Nitrate and nitrite in drinking water - Background document for development of WHO Guidelines for drinking water quality.
- Xu, G., Yin, F., Chen, P.S., Xu, Y., Yu, P.H., 2016. Mathematical modeling of autotrophic denitrification (AD) process with sulphide as electron donor. *Water Res.* 91, 225–234. doi:10.1016/j.watres.2016.01.011
- Zhou, W., Liu, X., Dong, X., Wang, Z., Yuan, Y., Wang, H., He, S., 2015. Sulfur-based autotrophic denitrification from the micro-polluted water. *J. Environ. Sci. (China)* 44, 180–188. doi:10.1016/j.jes.2016.01.002

## **Nitrogen removal in single chambered batch fed microbial electrolysis cell (MEC) operated with combined landfill leachate and dairy wastewater**

Lakhwinder Kaur, Gini Rani and Yogalakshmi K N\*

Centre for Environmental Science and Technology, Central University of Punjab, Bathinda, Punjab, India.

\* Presenting author email: yogalakshmi25@gmail.com

**Abstract:** Nitrogen removal efficiency was investigated in the single chamber membrane less MEC operated with combined leachate and dairy wastewater. The MEC was operated with simulated leachate diluted with dairy wastewater in the ratio of 16:84 (i.e 54 ml of leachate with 296 ml of dairy wastewater). The OLR, HRT and applied voltage of MEC was 24 gCOD/L/d, 2 days and 0.8 V, respectively. The MEC showed 90% removal efficiency for nitrate, 100% removal of nitrite, 50% ammonia removal and 72.2% COD removal. The cumulative bio gas production during the process was around 10mL/L/d.

**Keywords:** Microbial electrolysis cell; Dairy wastewater; landfill leachate; nitrogen removal

### **INTRODUCTION**

Landfill leachate is a highly toxic but organic rich liquid generated during waste degradation. The toxicity associated with leachate resists it from being treated by conventional and advanced treatment methods. Recently the advent of a new technology, the Microbial electrolysis cells have paved a way for leachate treatment. MEC is a sustainable technology that produces renewable hydrogen from wastewater as substrate. The MEC uses less energy input and produces a clean fuel, the hydrogen. But like any other biological system MEC is also dependent on microorganisms. The toxicity of leachate does not allow it to be directly applied as substrate to MEC without dilution. In an era of water crisis, it is difficult to use fresh water for dilution. Henceforth, wastewater can be used for diluting the toxicity of landfill leachate. Dairy wastewater, a major wastewater discharging industry with biodegradable pollutants can be used as the best option for diluting the toxicity of leachate. MEC has already proved its potential in reduction of organic matter. Exploration of its role in nutrient removal is very limited. Thus, the present study would aim to investigate the potential of single chamber membrane less microbial electrolysis cell to remove nitrogen from combined leachate and dairy wastewater.

### **MATERIALS AND METHODS**

**Wastewater:** Dairy industry wastewater and simulated leachate was used as a substrate. The composition of simulated leachate was as follows (mg/L): Ammonium bicarbonate 2500, Antimonic acid 1, Calcium chloride 6000, Cupric sulfate pentahydrate 15, Dipotassium

**Table 1** Physio-chemical characterization of the combined dairy industry wastewater and simulated leachate

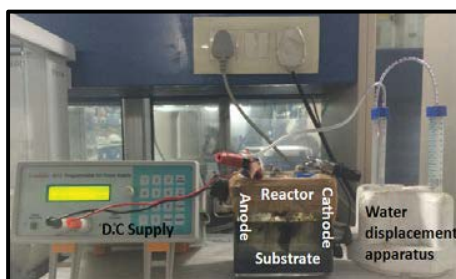
S.No.	Parameters	Value
1.	pH	8.5

2.	Chemical Oxygen Demand (mg/L)	8500±20
3.	Electrical Conductivity (µS/cm)	1440
4.	Ammonia (mg/L)	524±10
5.	Nitrate (mg/L)	3.2±0.5
6.	Nitrite (mg/L)	88.1±5
7.	Phosphate (mg/L)	5.1±0.5

phosphate 1400, Magnesium sulphate 250, Manganese sulfate monohydrate 14, Magnesium chloride hexahydrate 180, Nickle sulphate hexahydrate 0.6, Potassium bicarbonate 780, Sodium bicarbonate 960. The physio-chemical characterization of the combined dairy industry wastewater and simulated leachate is summarized in Table 1.

### MEC operation

A membrane-less single chamber reactor of dimensions 7.8cm x 11.3cm x 10cm and working volume of 350 mL was used in the study (Figure 1). Carbon cloth was used as anode and cathode. To increase the bacterial growth and power density, the anode was pretreated with nitric acid and acetone (Mahmoud et al., 2013). The pretreated anode was dipped in the mixture of volatile fatty acids and biogas digester slurry and incubated at 35 °C for 10-15 days for the development of biofilm over the anode. The bioanode and the cathode were placed at a distance of 4.5 cm to avoid short circuiting. The MEC was inoculated with biogas digester slurry and operated with combined simulated leachate and dairy wastewater in the ratio of 16:84. The OLR, HRT and applied voltage of MEC was 24 gCOD/L/d, 2 days and 0.8 V, respectively. The reactor was flushed with N<sub>2</sub> gas to maintain anaerobic conditions. The gas generated during the experiment was collected in a gas tight syringe fixed on top of the reactor. A methanogenesis inhibitor 2-Bromoethansulphonate was added to the MEC reactor to ensure the production of pure hydrogen. The performance of MEC was assessed in terms of COD and nitrogen (Ammonia, nitrate and nitrite) removal, current and gas generation.



**Figure 1 Microbial Electrolysis cell - Experimental Setup**

### Analytical methods and calculations

All the parameters were examined as per the standard methods APHA (2012). The current generation was measured by using multimeter. Current and power density was calculated as per the formula 1 and 2.

$$\text{Current density} = I/A \quad \dots\dots\dots (1)$$

Where,  $I$  denotes current and  $A$  is area of cross action of electrode.

Power density was calculated by multiplying the current density with the applied voltage.

$$\text{Power density} = \text{current density} \times \text{voltage} \quad \dots\dots\dots (2)$$

The hydrogen was determined as per the formula mentioned below by converting it into molar mass.

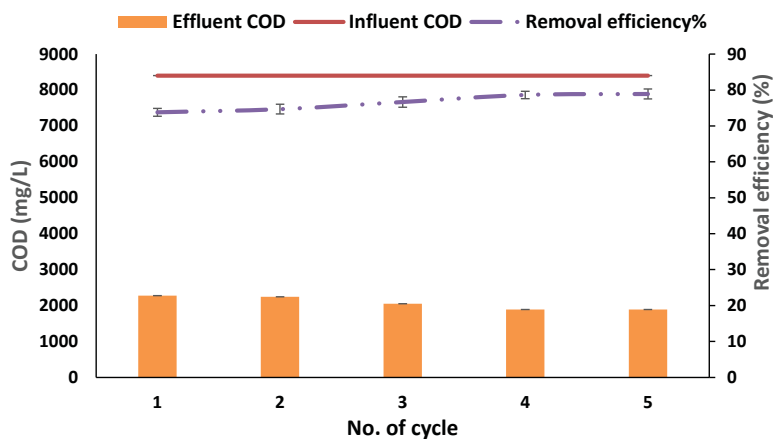
$$LH_2 = \frac{1 \text{ mole } H_2}{22.414 H_2} \quad \dots\dots\dots (3)$$

Here 22.414  $H_2$  is the molar mass of the gas at standard temperature and pressure.

## RESULTS AND DISCUSSION

**COD removal:** Figure 2 depicts the COD removal efficiency of the MEC operated with combined leachate and dairy wastewater. It was observed that during the initial cycles the MEC showed a COD removal of 73.8% with effluent COD of 2276.9 mg/L. On continuous operation, the COD removal increased slowly and reached 78.9% leaving a residual COD of 1890.3 mg/L. The increase in COD removal efficiency might be due to the degradation of the substrate at steady conditions.

**Energy generation:** The maximum current generation observed during the operation of MEC with combined leachate and dairy wastewater was 74 mA. The current and power density was calculated to be  $74A/m^3$  and  $592 \text{ mW/cm}^2$ . Gas generation was also considered as part of energy generation. It was observed that the MEC generated gas in the range of 10-15 mL/L/d. The gas was a mixture of carbon dioxide and hydrogen.

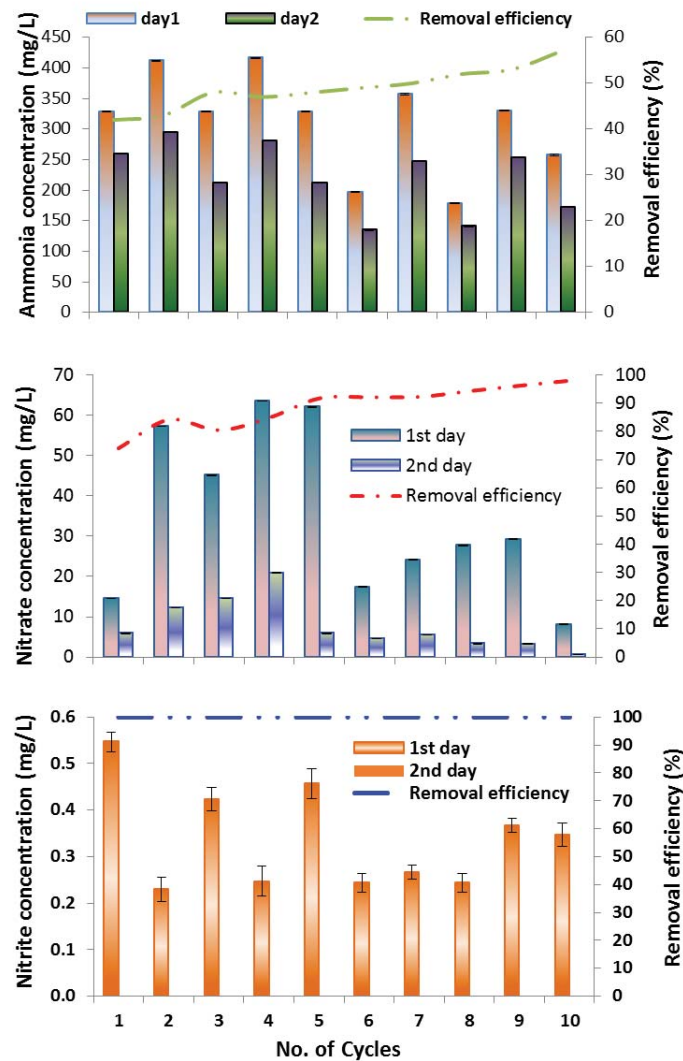


**Figure 2** Variation of COD in MEC operated with combined leachate and dairy industry wastewater

**Nitrogen removal:** Figure 3 depicts the ammonia, nitrite and nitrate removal in MEC operated with combined leachate and dairy industry wastewater. MEC showed 100% removal of nitrite and 90% removal of nitrate. The lowest removal efficiency in the range of 48 - 57% was recorded for ammonia. The ammonia within the MEC was in the range of 404.4 mg/L to 548.4 mg/L showing an average effluent ammonia of 224.9 mg/L. According to Haddadi et al., (2014), at increased current generation, a competition between protons and ammonia ions exists which results in



decreased ammonia removal. The higher efficiency of nitrite and nitrate is due to their use as electron acceptors. Nitrate and nitrite accept electrons from external circuit and gets reduced. Nitrate ions are reduced to nitrite at cathode. Further autotrophic denitrifiers use H<sub>2</sub> gas at cathode as an electron donor (Zhang et al., 2014). This hydrogen gas was used to reduce nitrate to nitrite which further react with H<sub>2</sub> gas to form nitric oxide (Ghafari et al., 2008). In the absence of organic matter, nitrate can be reduced by electrons present at the cathode (Park et al., 2005). From the results, it is clear that MEC has a good potential to remove the nitrogen.



**Figure 3 Ammonia, nitrite and nitrate removal in MEC operated with combined leachate and dairy industry wastewater.**

**CONCLUSIONS**

MEC was efficient in treating leachate and dairy industry wastewater. The MEC showed 72.2 % COD removal, 0.74 A current generation and 10 mL/L/d of gas generation. Among the nutrients,

The IWA S2Small2017 Conference on Small Water & Wastewater Systems and Resources Oriented Sanitation

MEC showed 100% removal of nitrite and 90% removal of nitrate. The lowest removal efficiency in the range of 48 - 57% was recorded for ammonia.

## REFERENCES

- Ghafari S., Hasan M. & Aroua M. K. 2008 Bio-electrochemical removal of nitrate from water and wastewater—a review. *Bioresource Technology* **99**(10), 3965-3974.
- Haddadi S., Elbeshbishy E. & Lee H. S. 2013 Implication of diffusion and significance of anodic pH in nitrogen-recovering microbial electrochemical cells. *Bioresource Technology* **142**, 562-569.
- Iskander S. M., Brazil B., Novak J. T. & He, Z. 2016 Resource recovery from landfill leachate using bioelectrochemical systems: Opportunities, challenges, and perspectives. *Bioresource Technology* **201**, 347-354.
- Kelly P. T. & He Z. 2014 Nutrients removal and recovery in bioelectrochemical systems: a review. *Bioresource Technology* **153**, 351-360.
- Mahmoud M., Parameswaran P., Torres C. I. & Rittmann B. E. 2014 Fermentation pre-treatment of landfill leachate for enhanced electron recovery in a microbial electrolysis cell *Bioresource Technology* **151**, 151-158.
- Park J. Y. & Yoo Y. J. 2009 Biological nitrate removal in industrial wastewater treatment: which electron donor we can choose. *Applied Microbiology and Biotechnology* **82**(3), 415-429.
- Standard Methods for the Examination of Water and Wastewater* 2012 24th edn, American Public Health Association/American Water Works Association/Water Environment Federation, Washington DC, USA.
- Villano M., Scardala S., Aulenta F. & Majone, M. 2013 Carbon and nitrogen removal and enhanced methane production in a microbial electrolysis cell. *Bioresource Technology* **130**, 366-371.
- Zhang F., Li J. & He Z. 2014 A new method for nutrients removal and recovery from wastewater using a bioelectrochemical system. *Bioresource Technology* **166**, 630-634.

**Parallel session 9 - Nutrients recovery and reuse**

**14:00-15:00**

Session chair: Joëlle Paing

**506 - How important is acclimation for the start-up of an anammox reactor at low temperature and nitrogen concentration?**

PEDROUSO Alba - *Universidade de Santiago de Compostela*

**460 - Nutrients recovery from the effluent of a decentralized anaerobic membrane bioreactor treating fresh domestic wastewater by cultivation of the microalgae *Acutodesmus obliquus***

FOIX-CABLE Mathilde - *Technical University of Berlin*

**619 - Potential of using synthesized Nano-zeolite for Nitrogen and Phosphorus removal**

GAO Fei - *Department of Civil, Structural and Environmental Engineering, Trinity College Dublin*

**Parallel session 10 - Phosphorus Treatment and recovery 3**

**15:20-16:20**

Session chair: Norbert Weissenbacher

**782 - Phosphorus removal using steel slag in reactive filters: 6 years monitoring at large scale**

PAING Joëlle - *OPURE*

**478 - Modelling of reactions in a fixed bed reactor for phosphate recovery by scallop shell particles**

ITO Ryusei - *Hokkaido University*

**658 - Use of reactive material for P removal in small treatment plants, potential of industrial by-products in India**

MUTNURI Srikanth - *Birla Institute of Technology and Science - Pilani KKBirla Goa campus*

# How important is acclimation for the start-up of an anammox reactor at low temperature and nitrogen concentration?

Ref # S2SMALL-96702

A. Pedrouso<sup>1\*</sup>, A. Val del Río<sup>1</sup>, J.L. Campos<sup>2</sup>, R. Méndez<sup>1</sup>, A. Mosquera-Corral<sup>1</sup>

<sup>1</sup> Department of Chemical Engineering, School of Engineering, Universidade de Santiago de Compostela, Rúa Lope Gómez de Marzoa, E-15782. Santiago de Compostela, Spain.

<sup>2</sup> Facultad de Ingeniería y Ciencias, Universidad Adolfo Ibáñez, Avda. Padre Hurtado 750, 2503500, Viña del Mar, Chile.

\* Corresponding Author: alba.pedrouso@usc.es

**Keywords:** anammox, granules, mainstream, nitrogen removal, wastewater

## INTRODUCTION

The small sewage treatment plants (STP) (<10,000 population equivalent) amount for the 65% of the total plants in Europe (Foladori *et al.* 2015). Small STP are high energy demanding as they are usually oversized and based on activated sludge systems which are high energy consuming units (Gu *et al.* 2017). The application of the anammox process is under study to maximize the wastewater energy self-sufficiency. Moreover, when these systems are based on granular sludge, are compact and recommended for small STP.

However, there are still some issues to be improved when these processes are applied to treat urban wastewater at low temperature (<20 °C) and low nitrogen concentrations (< 100 mg N/L). In order to speed up the process the inoculation with anammox enriched biomass coming from a high load and high temperature system seems an option. Up to date, most available studies have been performed by applying long acclimation periods (several months) to the inoculum to reach the required conditions (Laureni *et al.* 2015). The main objective of the present study is to evaluate the long term performance of a granular anammox process operated at mainstream conditions, 15 °C and 50 mg N/L, without previous acclimation period.

## MAIN METHODS

A 5-L sequencing batch reactor (SBR) was operated at 15 °C. It was fed with synthetic media (Dapena-Mora *et al.* 2004) containing 25 mg NH<sub>4</sub><sup>+</sup>-N/L and 25 mg NO<sub>2</sub><sup>-</sup>-N/L. The 6-hours SBR cycle was: feeding and reaction 300 min, mixing 30 min, settling 15 min and withdrawal 15 min. Hydraulic retention time was fixed at 1 day. The anammox reactor was seed with granular sludge from an ELAN<sup>®</sup> reactor (Morales *et al.* 2015). Specific anammox activity (SAA) was determined in batch tests according to Dapena-Mora *et al.*, (2007). Activation energies were estimated by linear regression of the SAA values (at 15, 20, 25 and 30 °C) applying the Arrhenius' equation (Lotti *et al.* 2015).

## MAIN RESULTS AND CONCLUSIONS

The anammox reactor was operated for 144 days. Throughout the operational period, the removed nitrogen loading rate (NLR) was of 41±4 mg N/L·d, comparable with the values obtained by Laureni *et al.* (2015) after 120 days of acclimation from 29 to 15 °C. The

removed NLR in the SBR was limited by the load applied, as nitrite accumulation was not observed. The obtained average values of  $\text{NO}_2^-$  to  $\text{NH}_4^+$  consumed molar ratio and  $\text{NO}_3^-$  produced to  $\text{NH}_4^+$  consumed molar ratio were  $1.26 \pm 0.12$  and  $0.34 \pm 0.09$ , respectively. These values fit the stoichiometry of the anammox process.

**Table 1.** Comparison of the properties of the biomass in the SBR on days 0 and 135 of operation

Sampling day	SAA (30 °C) (mg N/(g VSS·d))	SAA (15 °C) (mg N/(g VSS·d))	Activation energy (kJ/mol)	Biomass in SBR (g VSS/L)
0	270 ± 13	53 ± 11	78 ± 3	1.60 ± 0.01
135	259 ± 18	56 ± 8	65 ± 5	1.21 ± 0.03

Batch activity test showed that the SAA at the reference temperature (30 °C) is more than five times higher than at 15 °C (Table 1). The same behavior was observed in the inoculum and after 135 days of operation. The similar values of SAA obtained at 15 °C in days 0 and 135 indicate no effect of the long-term operation on the anammox biomass. Furthermore, the decrease of the activation energy along the operation (Table 1) suggests the anammox biomass acclimation at the operational temperature (Lotti *et al.* 2015).

Therefore the results indicate that for the start-up of an anammox reactor at low temperature and nitrogen concentration an acclimation period might not be needed.

### Acknowledgments

This work was funded by the European Union's Horizon 2020 (Pioneer\_STP project (ID 199)), the Spanish Government (FISHPOL (CTQ2014-55021-R) and GRANDSEA (CTM2014-55397-JIN) projects). All these programs are co-funded by FEDER. Authors want to thank FCC Aqualia for the ELAN<sup>®</sup> biomass samples.

### REFERENCES

- Dapena-Mora A., Arrojo B., Campos J. L., Mosquera-Corral A. and Méndez R. (2004). Improvement of the settling properties of Anammox sludge in an SBR. *Journal of Chemical Technology & Biotechnology* **79**(12), 1417-20, 10.1002/jctb.1140.
- Dapena-Mora A., Fernández I., Campos J. L., Mosquera-Corral A., Méndez R. and Jetten M. S. M. (2007). Evaluation of activity and inhibition effects on Anammox process by batch tests based on the nitrogen gas production. *Enzyme and Microbial Technology* **40**(4), 859-65, 10.1016/j.enzmictec.2006.06.018.
- Foladori P., Vaccari M. and Vitali F. (2015). Energy audit in small wastewater treatment plants: methodology, energy consumption indicators, and lessons learned. *Water Science and Technology* **72**(6), 1007,
- Gu Y., Li Y., Li X., Luo P., Wang H., Robinson Z. P., Wang X., Wu J. and Li F. (2017). The feasibility and challenges of energy self-sufficient wastewater treatment plants. *Applied Energy*, 10.1016/j.apenergy.2017.02.069.
- Laureni M., Weissbrodt D. G., Szivák I., Robin O., Nielsen J. L., Morgenroth E. and Joss A. (2015). Activity and growth of anammox biomass on aerobically pre-treated municipal wastewater. *Water Research* **80**, 325-36, 10.1016/j.watres.2015.04.026.
- Lotti T., Kleerebezem R. and van Loosdrecht M. C. M. (2015). Effect of temperature change on anammox activity. *Biotechnology and Bioengineering* **112**(1), 98-103, 10.1002/bit.25333.
- Morales N., Val del Rio A., Vazquez-Padin J. R., Gutierrez R., Fernandez-Gonzalez R., Icaran P., Rogalla F., Campos J. L., Mendez R. and Mosquera-Corral A. (2015). Influence of dissolved oxygen concentration on the start-up of the anammox-based process: ELAN(R). *Water Sci Technol* **72**(4), 520-7, 10.2166/wst.2015.233.

# Nutrients recovery from the effluent of a decentralized anaerobic membrane bioreactor treating fresh domestic wastewater by cultivation of the microalgae *Acutodesmus obliquus*

Ref # S2SMALL-73656

M. Foix-Cablé<sup>1\*</sup>, R. Darmawan<sup>2</sup>, M. Sahnoun<sup>1</sup>, S. Hindersin<sup>2</sup>, M. Kerner<sup>2</sup>, M. Kraume<sup>1</sup>

<sup>1</sup> Technical University of Berlin, Chair of Chemical and Process Engineering, FH6-1, Strasse des 17. Juni 135, 10623 Berlin, Germany

<sup>2</sup> Strategic Science Consult GmbH, Beim Alten Gaswerk 5, 22761 Hamburg, Germany

\* Corresponding Author: [mathilde.foix-cable@tu-berlin.de](mailto:mathilde.foix-cable@tu-berlin.de)

**Abstract:** This study investigates the feasibility of microalgae cultivation in the effluent (permeate) of a decentralized anaerobic membrane bioreactor (AnMBR) treating domestic wastewater. Throughout 3 successive batch experiments, nutrient removal and growth of the microalgae species *Acutodesmus obliquus* were studied for the following culture media: (A) raw permeate, (B) permeate enriched with iron, magnesium, manganese, sulfur and the chelating agent EDTA, (C) diluted commercial fertilizer as control culture. Initial nutrient concentrations in the permeate ranged 97.2 - 126.2 mg·L<sup>-1</sup> TN and 13.6 - 14.6 mg·L<sup>-1</sup> TP. During the successive batch tests, Total Phosphorus (TP) reached an average removal of 97 %, 97 % and 99 % for (A), (B) and (C) respectively. An average Total Nitrogen (TN) removal of respectively 95 % and 96 % was achieved for the enriched permeate (B) and the control culture (C). Despite TN removal and microalgae growth rates similar to (B) and (C) during the first two batch tests, the culture (A) showed a limitation of these two parameters starting from the third batch test. This was certainly caused by the lack of at least one element within the four named micronutrients in the microalgae cells. In this work, an effluent with a quality permitting to fulfill the requirements of the European Commission Directive 98/15/EE for wastewater discharge (maximum concentrations of 1 mg·L<sup>-1</sup> TP and 10 mg·L<sup>-1</sup> TN) was obtained. However, the micronutrients iron, magnesium, manganese, sulfur and the chelating agent EDTA should be added for continuous cultures at full-scale.

**Keywords:** anaerobic membrane bioreactor, microalgae, nutrient removal, wastewater reuse

## INTRODUCTION

Domestic wastewater treatment with efficient nutrient recovery is a worldwide key challenge for the 21<sup>st</sup> century. While industrialized countries treat 70 % of their sewage, wastewater is treated in only 28 % to 38 % of the emerging countries and 8 % of the developing countries (Sato *et al.* 2013). When the wastewater is treated, nitrogen and phosphorus removal often remains insufficient (Rawat *et al.* 2011), leading to eutrophication of the water bodies. At the same time, phosphorus resources are expected to be depleted within the next 100 years (Withers *et al.* 2015) and demand could exceed supply starting from 2035 (Cordell 2010). Phosphorus from human feces represent 28 % of the phosphorus global demand (Mihelcic *et al.* 2011). If this major nutrient was reused, it could lead to enhancement of the water bodies quality and be a long-term solution to phosphorus depletion. For this purpose, microalgae appear to be perfect candidates. Coupling wastewater treatment and microalgae cultivation enables to save fertilizer based on limited resources. Combining these two technologies is considered as a very promising alternative for phosphorus and ammonium removal, energy recovery, biomass production and water reuse (Whitton *et al.* 2015; Solovchenko *et al.* 2016).



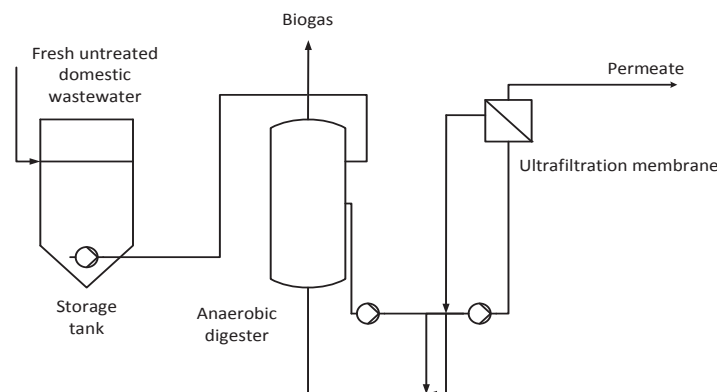
Besides, the use of AnMBR for wastewater treatment has multiplied in the recent years. The low amount of sludge produced and energy consumed are the main advantages of the AnMBR over a conventional aerobic process (Ozgun *et al.* 2013). Especially, membranes have a small footprint (Pretel *et al.* 2016), which leads some AnMBR plants to be net neutral energy demanders (Seib *et al.* 2016). However, this process cannot eliminate the nutrients, which implicates the need of a post-treatment (Smith *et al.* 2012). Microalgae culture could perfectly fulfill this post-treatment requirement, as they could especially have a great role for tertiary treatment (Oswald 1995; Whitton *et al.* 2015).

This work aims to recycle the nutrients contained in the effluent of a decentralized AnMBR treating domestic wastewater by coupling this preliminary process with the culture of microalgal biomass. Even though the researches in the field of nutrient recovery from wastewater streams by means of microalgae culture have intensified over the past ten years, coupling an AnMBR with microalgae cultivation is comparatively a new area of study. Ruiz-Martinez *et al.* (2012) showed that a Submerged Anaerobic Membrane Bioreactor (SAnMBR) treating domestic wastewater was suitable for continuous microalgae growth. Using an AnMBR treating pre-treated sewage in combination with microalgae production, Viruela *et al.* (2016) demonstrates that it was possible to comply with EU directive when the effluent from the AnMBR was comprised in the range 40 - 50 mg·L<sup>-1</sup> TN and 6 - 7 mg·L<sup>-1</sup> TP. However, to our knowledge, coupling a decentralized wastewater treatment system using an AnMBR with microalgal culture has never been studied.

Furthermore, the influence of the addition of the chelating agent EDTA and the micronutrients iron, magnesium, manganese and sulfur to the permeate was simultaneously investigated. Parallel to the macronutrients carbon, nitrogen and phosphorus, numerous micronutrients are required at low amounts for microalgae growth (Grobbelaar 2004). However, no information about their availability in the effluent of an AnMBR can be found in the literature.

## MATERIALS AND METHODS

A prototype plant was built and automated in the so-called “BIQ Algae House” in Hamburg Wilhelmsburg, Germany (figure 1). Domestic wastewater from an apartment block (15 apartments, approximately 30 inhabitants) is directed to an AnMBR, where organic compounds are anaerobically digested in an 800 L Continuous Stirred Tank Reactor (CSTR).



**Figure 1.** Simplified flow diagram of the decentralized AnMBR process

After an average hydraulic retention time of 10 days, the wastewater flows through an ultrafiltration membrane (Bioflow External Membran Bioreactor, HyperFlux module Mo P13U(1m)\_I8, 0,31 m<sup>2</sup> area, 30 nm pores size, Berghof, Germany), which retains particulate

substances, microorganisms and pathogenic germs. The obtained liquid phase (permeate) contains high concentrations of inorganic nutrients, especially ammonium and orthophosphates, which are necessary for microalgae growth.

In this work, the permeate was sampled for further experiments at laboratory scale. Throughout three successive batch experiments, nutrient removal and microalgae growth were simultaneously studied in triplicates for the three following culture media:

- (A) Raw permeate from the AnMBR
- (B) Permeate enriched with the elements magnesium, manganese, iron, sulfur and the chelating agent EDTA. By addition of magnesium sulfate ( $\text{MgSO}_4 \cdot 7\text{H}_2\text{O}$ ), manganese (II) chloride ( $\text{MnCl}_2 \cdot 4\text{H}_2\text{O}$ ) and iron (II) sulfate ( $\text{FeSO}_4 \cdot 7\text{H}_2\text{O}$ ), an initial concentration of  $6.81 \text{ mg} \cdot \text{L}^{-1}$  of magnesium,  $4.96 \text{ mg} \cdot \text{L}^{-1}$  of manganese,  $25.22 \text{ mg} \cdot \text{L}^{-1}$  of iron and  $23.47 \text{ mg} \cdot \text{L}^{-1}$  of sulfur was achieved. The chelating agent EDTA, which favors the formation of complexes with the micronutrients and therefore their assimilation by microalgae, was also added with an initial concentration of  $8 \text{ mg} \cdot \text{L}^{-1}$ . The initial concentrations of the added elements were chosen regarding the results of previous internal microalgae cultivation experiments conducted with anaerobically digested blackwater under various micronutrient concentrations.
- (C) A commercial fertilizer (Ferty Basis 1, Planta Düngemittel GmbH, Germany) was used as control for the experiment. As it does not contain a nitrogen source, nitrogen was added in the form of ammonium nitrate ( $\text{NH}_4\text{NO}_3$ ).  $\text{NH}_4\text{NO}_3$  was preferred to an ammonium salt, as culture media usually reach great acidic levels when ammonium is the only source of nitrogen. The commercial fertilizer was diluted with distilled water and  $\text{NH}_4\text{NO}_3$  added so that nitrogen and phosphorus initial concentrations were similar as those of the cultures (A) and (B).

Initial ammonium, TN, TP and biomass concentrations are presented in the table 1.

**Table 1.** Initial ammonium, TN, TP and biomass concentrations

Experiment and duration	Ammonium initial concentration ( $\text{mg NH}_4\text{-N} \cdot \text{L}^{-1}$ )			TN initial concentration ( $\text{mg} \cdot \text{L}^{-1}$ )			TP initial concentration ( $\text{mg} \cdot \text{L}^{-1}$ )			Initial biomass concentration (g dry weight $\cdot \text{L}^{-1}$ )		
	A	B	C	A	B	C	A	B	C	A	B	C
1 <sup>st</sup> Batch (8 days)	73.7	73.7	39.0	97.2	97.2	110.1	14.0	14.0	11.5	0.294	0.388	0.257
2 <sup>nd</sup> Batch (5 days)	97.2	97.2	45.6	122.2	122.2	111.0	13.6	13.6	12.0	0.694	0.832	0.671
3 <sup>rd</sup> Batch (5 days)	98.6	98.6	46.2	126.2	126.2	106.8	14.6	14.6	12.4	0.664	0.774	0.653

The experimental plant consisted on nine autoclaved tubular pipes with a volume of each 350 mL (3 pipes for each culture medium). The pipes were submerged in a continuously streamed Plexiglas water bath. Temperature was set to  $25 \text{ }^\circ\text{C}$  (Thermostat DC40-K40, Haake, Germany). Five neon tubes (Philipps, Master TL-D 58W/840) gave an average light intensity of  $446 \pm 44 \text{ } \mu\text{mol} \cdot \text{m}^{-2} \cdot \text{s}^{-1}$ . The experimental set-up worked with a 14:10 h light/dark cycle. The light and temperature parameters aimed to reproduce the weather conditions of the “BIQ Algae House” in the summer season. A continuously circulation of air and carbon dioxide

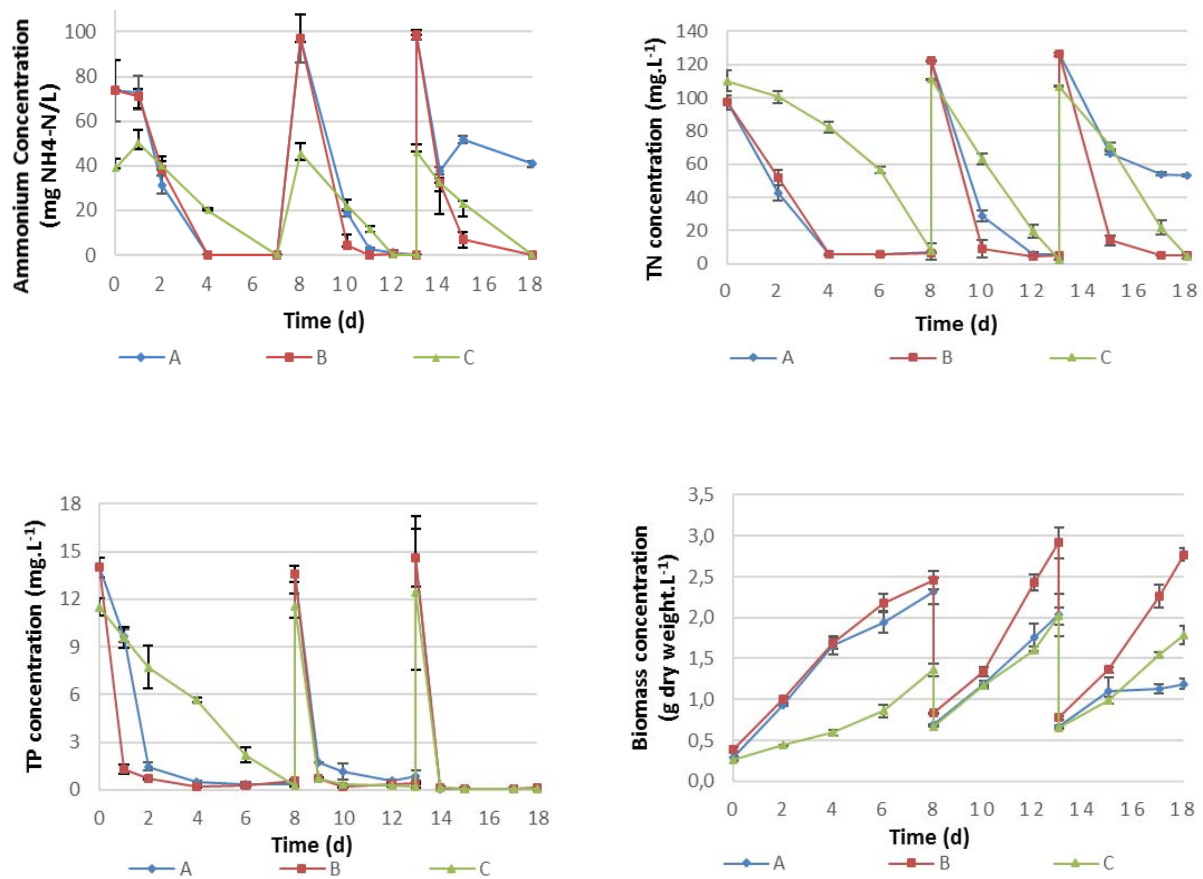
with a carbon dioxide concentration from 4 % to 5 % was used as carbon source. At the start of the experiment, pH (pH 91, WTW, Germany) was set to 7.5. Values in the range 7 - 9 are reported to be optimal pH values for microalgal growth (Ruiz-Martinez *et al.* 2012). Furthermore, a pH kept to the neutrality allows ammonium to be the most dominant form of ammonia nitrogen and does not lead to phosphorus, ammonium and magnesium precipitation in the form of struvite (de-Bashan, Bashan 2004). Every day, pH was controlled and adjusted with sodium hydroxide in case of acidification of the culture medium. The abiotic parameters applied during the successive batch experiments are summarized in the table 2.

**Table 2.** Summary of the abiotic factors set for the 3 successive batch experiments

Temperature (°C)	Light intensity ( $\mu\text{mol}\cdot\text{m}^{-2}\cdot\text{s}^{-1}$ )	Light:dark cycle (h)	CO <sub>2</sub> gas content (v/v %)	Initial pH
25 ± 1	446 ± 44	14:10	4 - 5	7,5

For the inoculation, 20 mL *Acutodesmus obliquus* from the microalgae collection MCZH-SVCK of the University Hamburg was used as pre-culture medium. This species was investigated because TP removal is commonly lower than TN removal during microalgae cultivation and *Acutodesmus obliquus* generally leads to higher TP removal than other microalgae species (Whitton *et al.* 2015). The pre-culture was cultivated in a 2 Liter Duran laboratory bottle in presence of a diluted commercial fertilizer (Ferty Basis 1, Planta Düngemittel GmbH, Germany). Before starting the pre-culture, the culture medium was autoclaved and the pH was adjusted to 7.5. A continuous lighting of  $331.7 \mu\text{mol}\cdot\text{m}^{-2}\cdot\text{s}^{-1}$  was applied. After 7 days, the pre-culture was centrifuged 10 min at  $4000 \text{ U}\cdot\text{min}^{-1}$  (Thermo scientific, USA). The biomass was then washed with distilled water and centrifuged again. The microalgae could afterwards be divided in the nine pipes. After inoculation, 10  $\mu\text{L}$  of silicon anti-foaming agent was added in each pipe in order to avoid the formation of foam and the flooding of the culture. At the end of each batch experiment, the contents of the three tubular pipes used for the culture (A) were mixed together in a 2 Liter Duran flask. After 10 min centrifugation at  $4000 \text{ U}\cdot\text{min}^{-1}$ , the biomass was divided in the same three pipes. Identical procedures were applied for the cultures (B) and (C).

## RESULTS AND DISCUSSION



**Figures 2A, 2B, 2C and 2D.** Ammonium, TN, TP and biomass concentrations throughout 3 successive batch experiments with (A) raw permeate, (B) enriched permeate and (C) commercial fertilizer. The error bars represent the standard deviation of the 3 replicates.

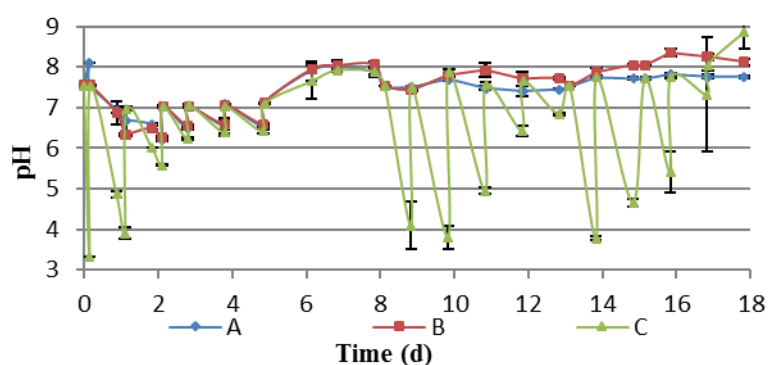
At the end of the first two batch tests for the culture (A) and at the end of each batch test for (B) and (C), TP and TN removal efficiencies higher than 93 % were reached (table 3 and figure 2). However, starting from the third batch experiment, a limitation of nitrogen removal and microalgal growth was observed with raw permeate (A). As the culture medium of the experiments (A) and (B) had the same nutrient concentrations, except for magnesium, manganese, sulfur, iron and EDTA, it can be concluded that at least one of the 4 named micronutrients were missing or not at sufficient concentrations in the culture (A). It can also not be excluded that the absence of the chelating agent avoided the assimilation of the micronutrients by the microalgae. As the pre-culture microalgae used as initial biomass at the beginning of the first batch experiment grew in a nutrient-rich synthetic culture medium containing sufficient micronutrients, the limitation of microalgae growth and TN removal in (A) did not occur at the beginning of the experiment. Indeed, during the pre-culture, the micronutrients contained in the synthetic culture medium were stored in the cells of the microalgae. Therefore, it was assumed that the stock of micronutrients in the cells was still sufficient during the first and the second batch test. The accumulated reserves gradually decreased, resulting in a total inhibition of microalgae growth and TN removal during the third batch test. Regarding the results of this work, these four micronutrients and EDTA should be added for microalgae cultivation at full-scale. As a result of the low concentrations of elements needed, this change in the process will only have a low influence on the cost of

**Table 3.** Average ammonium, Total Nitrogen (TN), and Total Phosphorus (TP) removal throughout 3 successive batch experiments with (A) raw permeate, (B) enriched permeate and (C) commercial fertilizer.

Experiment and duration	Ammonium removal (%)			TN removal (%)			TP removal (%)			Growth rate (g·L <sup>-1</sup> ·day <sup>-1</sup> )		
	A	B	C	A	B	C	A	B	C	A	B	C
1 <sup>st</sup> Batch (8 days)	99.8	99.9	99.9	93.0	93.3	93.2	97.3	96.0	97.7	0.253	0.258	0.138
2 <sup>nd</sup> Batch (5 days)	99.9	99.9	99.7	95.5	96.0	97.8	93.5	97.0	98.2	0.268	0.417	0.269
3 <sup>rd</sup> Batch (5 days)	58.7	99.9	99.7	57.9	95.8	95.5	99.2	99.2	99.6	0.105	0.400	0.227

the process. Furthermore, experiments will be undertaken at a labor scale in order to state which element was responsible for the observed limitations.

In this work, the quality of the effluent (B) permitted the fulfillment of the European Commission Directive 98/15/EE for wastewater discharge. While a maximum TP concentration of 1 mg·L<sup>-1</sup> is authorized, the culture (B) reached final concentrations of 0.260, 0.410 and 0.114 mg·L<sup>-1</sup>. With final TN concentrations of 6.54, 4.89 and 5.30 mg·L<sup>-1</sup>, the requirements regarding TN were also fulfilled (maximum TN concentration of 10 mg·L<sup>-1</sup> authorized). The culture with raw permeate (A) likewise achieved TN and TP respecting the European Commission Directive 98/15/EE requirements, except at the end of the third batch test where TN remained at a concentration of 53.1 mg·L<sup>-1</sup>. Moreover, as pH (figure 3) reached maximum values of 8.1, 8.1 and 7.9 for (A), (B) and (C) during TP removal, it was presumed that phosphorus and ammonium did not precipitate in the form of struvite. Therefore, it was assumed that nutrient removal from the culture medium was mostly due to nutrient assimilation by the microalgae cells. However, an analysis of microalgae cells should be investigated in further studies. Due to the very low volume of culture in each tubular pipe, this analysis was unfortunately not feasible in this work.



**Figure 3.** pH concentrations throughout 3 successive batch experiments with (A) raw permeate, (B) enriched permeate and (C) commercial fertilizer. The error bars represent the standard deviation of the 3 replicates.

In these batch experiments, nutrient removal and microalgae growth occurred faster with the enriched permeate (B) than with the commercial fertilizer (C). Indeed, despite the daily adjustment of the pH value to a neutral level, strong acidification of the culture (C) occurred.

This represented a stress factor for the microalgae, which needed for that reason a longer adaptation time. Furthermore, microalgae needed a higher amount of energy to assimilate the nitrogen in the culture (C). Indeed, nitrate uptake requires reduction to ammonium in the cells involving the use of enzymes. This reaction could have influenced TN uptake rate.

## CONCLUSIONS

Based on this study, the microalgae species *Acutodesmus obliquus* is able to grow continuously in the effluent of a decentralized AnMBR treating fresh domestic wastewater with high growth rates and total removal of the main nutrients phosphorus and ammonium. For this purpose, the micronutrients iron, magnesium, manganese, sulfur and the chelating agent EDTA should be added to the permeate. However, since the addition of a small amount of micronutrients and chelating agent is sufficient to achieve an optimum microalgae growth, the cost of full-scale processes should not be affected. Given that the use of AnMBR has expanded in the last decade, this work opens new perspectives for the coupling between this technology and microalgae culture. The results of this study will be verified by cultivating *Acutodesmus obliquus* with permeate in outdoor photobioreactors. In addition, the micronutrients iron, magnesium, manganese, sulfur and the chelating agent EDTA will be tested separately in order to find the limiting element in the raw permeate.

## REFERENCES

- v. Cordell D. 2010 *The Story of Phosphorus. Sustainability implications of global phosphorus scarcity for food security*. PhD thesis, Department of Water and Environmental Studies, Linköping University, Linköping, Sweden.
- de-Bashan L. E. & Bashan Y. 2004 Recent advances in removing phosphorus from wastewater and its future use as fertilizer. *Water research*, **38**(19), 4222–4246. DOI: 10.1016/j.watres.2004.07.014.
- i. Grobbelaar J. U. 2004 Algal Nutrition - Mineral Nutrition. In: *Handbook of Microalgal Culture. Biotechnology and Applied Phycology*, edited by Richmond R., Blackwell Publishing.
- Mihelcic J. R., Fry L. M. & Shaw R. 2011 Global potential of phosphorus recovery from human urine and feces. *Chemosphere* **84**(6), 832–839. DOI: 10.1016/j.chemosphere.2011.02.046.
- Oswald W. J. 1995 Ponds in the twenty-first century. *Waste Stabilisation Ponds and the Reuse of Pond Effluents* **31**(12), 1–8. DOI: 10.1016/0273-1223(95)00487-8.
- Ozgun H., Dereli R. K., Ersahin, M. E.; Kinaci C., Spanjers H. & van Lier J. B. 2013 A review of anaerobic membrane bioreactors for municipal wastewater treatment. Integration options, limitations and expectations. *Separation and Purification Technology* 118, 89–104. DOI: 10.1016/j.seppur.2013.06.036.
- Pretel R., Monino P., Robles A., Ruano M. V., Seco, A. & Ferrer, J. 2016 Economic and environmental sustainability of an AnMBR treating urban wastewater and organic fraction of municipal solid waste. *Journal of environmental management* 179, pp. 83–92. DOI: 10.1016/j.jenvman.2016.04.057.
- Rawat I., Ranjith Kumar R., Mutanda T. & Bux F. 2011 Dual role of microalgae. Phycoremediation of domestic wastewater and biomass production for sustainable biofuels production. *Applied Energy* **88**(10), 3411–3424. DOI: 10.1016/j.apenergy.2010.11.025.



- Ruiz-Martinez A., Martin Garcia N., Romero I., Seco A. & Ferrer J. 2012 Microalgae cultivation in wastewater: nutrient removal from anaerobic membrane bioreactor effluent. *Bioresource technology* 126, 247–253. DOI: 10.1016/j.biortech.2012.09.022.
- Sato T., Qadir M., Yamamoto S., Endo T. & Zahoor, A. 2013 Global, regional, and country level need for data on wastewater generation, treatment, and use. *Agricultural Water Management* 130, 1–13. DOI: 10.1016/j.agwat.2013.08.007.
- Seib M. D., Berg K. J. & Zitomer, D. H. 2016 Low energy anaerobic membrane bioreactor for municipal wastewater treatment. *Journal of Membrane Science* 514, 450–457. DOI: 10.1016/j.memsci.2016.05.007.
- Smith A. L., Stadler L. B., Love N. G., Skerlos, S. J. & Raskin L. 2012 Perspectives on anaerobic membrane bioreactor treatment of domestic wastewater: a critical review. *Bioresource technology* 122, 149–159. DOI: 10.1016/j.biortech.2012.04.055.
- Solovchenko A., Verschoor A. M., Jablonowski, N. D. & Nedbal L. 2016 Phosphorus from wastewater to crops: An alternative path involving microalgae. *Biotechnology advances* 34 (5), 550–564. DOI: 10.1016/j.biotechadv.2016.01.002.
- Viruela A., Murgui M.; Gomez-Gil T., Duran F., Robles A. & Ruano M. V. 2016 Water resource recovery by means of microalgae cultivation in outdoor photobioreactors using the effluent from an anaerobic membrane bioreactor fed with pre-treated sewage. *Bioresource technology* 218, 447–454. DOI: 10.1016/j.biortech.2016.06.116.
- Whitton R., Ometto F., Pidou M., Jarvis P., Villa R. & Jefferson B 2015 Microalgae for municipal wastewater nutrient remediation. Mechanisms, reactors and outlook for tertiary treatment. *Environmental Technology Reviews* 4(1), 133–148. DOI: 10.1080/21622515.2015.1105308.
- Withers P. J. A., Elser J. J., Hilton J., Ohtake H., Schipper W. J. & van Dijk K. C. 2015 Greening the global phosphorus cycle. How green chemistry can help achieve planetary P sustainability. *Green Chem* 17(4), 2087–2099. DOI: 10.1039/C4GC02445A

**REVIEWERS COMMENTS – The article was corrected based of the following comments:**

**Jack van de Vossen, PhD, Senior Lecturer in Microbiology, IHE Delft Institute for Water Education, Netherlands:**

This abstract clearly demonstrates the feasibility to remove P and N with microalgae from permeate of an AnMBR reactor fed with domestic wastewater. The system can yield effluent water that fulfills EU requirements for wastewater discharge. A simple enrichment of the permeate with Mg, Mn, Fe, S and EDTA was sufficient to obtain sustainable removal as compared with added fertilizer. This work builds on knowledge that has been obtained with algae growing on permeate of an AnMBR reactor fed with urban (pre-treated) wastewater and I think that this is a nice topic for a presentation on S2small.

**Ewelina Jankowska, Researcher, Institute of Environmental Engineering, Politechnika Poznańska, Poznań, Poland:**

This work represents an attempt to understand the feasibility of microalgae *Acutodesmus obliquus* cultivation in the effluent of decentralized anaerobic membrane bioreactor treating fresh domestic wastewater. Presented results indicated that the use of raw permeate limited the nitrogen removal and microalgae growth, however the permeate enriched with iron, magnesium, manganese, sulfur and the chelating agent EDTA enhanced TP, TN and ammonium removal.

Authors need to explain why the *Acutodesmus obliquus* was used. Maybe another species or mixed microalgae biomass could give better results in nutrients recovery from raw permeate. Authors should discuss how added microelements could influence the growth of microalgae biomass. In the future work (full scale processes) authors should consider whether the addition of microelements will not adversely affect the cost of the process.

**Simone Rossi, Ph.D. student, Department of Civil and Environmental Engineering Politecnico di Milano, Milano, Italy:**

In this study, a microalgal culture was fed with the effluent (permeate) of an AnMBR reactor treating domestic wastewaters from a small apartment block. Removal efficiencies and microalgal productivities were calculated for: raw permeate, permeate enriched with Fe, Mg, Mn, S and a chelating agent (EDTA) and a control commercial fertilizer. The microalgal species *Acutodesmus obliquus* was cultivated for this purpose, obtaining very high removal efficiencies and satisfactory concentrations in the effluent stream for TP and TN. Three consecutive batch tests were performed, showing a decrease in the removal of TN and  $\text{NH}_4^+$  for the last batch test, when treating raw permeate.

A possible explanation for this phenomenon should be added from the authors, explaining possible consequences when treating permeate at full-scale. Details about initial conditions should be added as well, regarding TP, TN and biomass concentration. The work is however well-structured and I found the abstract interesting for the S2small 2017, being the conference focused on water and wastewater management for small and decentralized systems.

**Lukasz Jaroszynski, Ph.D. student, Institute of Environmental Engineering, Poznan University of Technology, Poland:**

It is interesting basic research which targets nutrients recovery from an anaerobically digested wastewater by microalgae cultivation. Results are described coherently with good English. Minor improvements are needed such as better description in batch test methodology (culture volume, vessel geometry or pH control during the test) or replicates number.

Detailed comments:

Fresh wastewater – better term could be treated wastewater

Figure 1 – flow arrows should be provided and description of fluid recirculation

**Ian Bradley, Ph. D student, University of Illinois at Urbana-Champaign, United States:**

This is an interesting application of microalgal technology, with the current abstract detailing a feasibility study of growing algae on AnMBR effluent. The current study shows that algae can grow on the effluent and achieve high removal of TN/TP. Overall, the abstract does demonstrate that this is a feasible application for microalgae treatment. I think the methods could be added to, and the abstract could benefit from slightly more discussion of insights gained from this study.

For example, I'm unclear from the methods how exactly the successive batch experiments were performed. Was the mixed batch culture wasted at the end of the experiment and then additional media added to the remaining culture? Was the culture allowed to settle before wasting? Or were these entirely new batch experiments with new inocula? From the graphs shown (Figures 2-5) it appears these were operated as semi-continuous reactors (SBRs). It is hard to make conclusions about the results without fully understanding how the batch experiments were run. For example, if wasting of old culture happened after allowing settling, perhaps inorganic metals accumulated in the raw permeate reactor and inhibited growth during the third replicate? The enriched permeate reactor that had EDTA could have eliminated this problem, and thus, the reason for no loss of TN removal.

In general, I think the abstract could greatly benefit from additional content in the methods that allow the reader to understand how this system was operated. This would allow deeper insights into the results. In addition, it would be great to see slightly more discussion on the results. For example, why do the authors think that reactor (B) had slightly higher growth and faster nutrient removal than (A)? Was it due to the addition of EDTA removing inhibitory metals? Or do the authors think that the addition of other micronutrients (Mg, S, etc.) was responsible? Any additional insights or information would be extremely welcome and beneficial.

**Ana Paula Erbetta Sueitt, University of Sao Paulo, Brazil:**

The study performed by Foix-Cablé et al. aimed to recycle the nutrients contained in the effluent of a decentralized AnMBR treating fresh domestic wastewater from an apartment block (15 apartments, approximately 30 inhabitants) by coupling this preliminary process with the culture of microalgae *Acutodesmus obliquus*. Such objective is quite interesting considering that the culture of microalgae in wastewater can contribute to the management of water ecosystems by providing a relatively inexpensive and environmentally attractive alternative to conventional energy intensive wastewater treatment systems. The experiments were conducted in lab-scale controlled conditions and some preliminary results were presented. In my opinion, the abstract presents interesting preliminary results, which have the potential to contribute to broaden the knowledge regarding the use of microalgae for wastewater treatment. However, the methodological approaches should be complemented with care to assure the understanding about what the authors did to achieve the results. In addition, more in-depth discussions and comparisons about the three culture mediums should be provided.

# Potential of using synthesized Nano-zeolite for Nitrogen and Phosphorus removal

Ref # S2SMALL-54803

F. Gao.<sup>1</sup>, L. Xiao.<sup>1</sup>, H. Zhang<sup>2</sup>

<sup>1</sup> Department of Civil, Structural and Environmental Engineering, Trinity College Dublin, Dublin, Ireland

<sup>2</sup> CRANN, School of Physics, Trinity College Dublin, Dublin, Ireland

\* Presenting Author: [gaofe@tcd.ie](mailto:gaofe@tcd.ie)

**Keywords:** Nano-zeolite, carbon nanotube, dairy wastewater, nitrogen removal, phosphorus removal

## INTRODUCTION

In this research project, the feasibility of using Coal fly ash to synthesize Nano-zeolite was studied and a set of batch experiments was conducted in order to assess the Nitrogen and Phosphorus adsorption efficiencies of the Nano-zeolite.

Nano-zeolite refers to Nano-crystalline zeolites, namely zeolites with crystal sizes less than 100 nm, has resulted in increased surface area and decreased diffusion path lengths, enhancing ion exchange properties and high potential environmental decontamination (Cambor, Corma, & Valencia, 1998). Its physicochemical characteristics such as high mechanical and chemical resistance in addition to their high surface area have formed the basis for their widespread use in catalysis, separation, and ion-exchange (Song, Li, Grassian, & Larsen, 2005).

The dairy industry is one of the most polluting of industries, not only in terms of the volume of effluent generated but also in terms of waste water characteristics (Sarkar, Chakrabarti, Vijaykumar, & Kale, 2006). It is hypothesized that NZ for treatment of dairy wastewater may allow simultaneous removal and recovery of nitrogen and phosphorus.

## MAIN METHODS

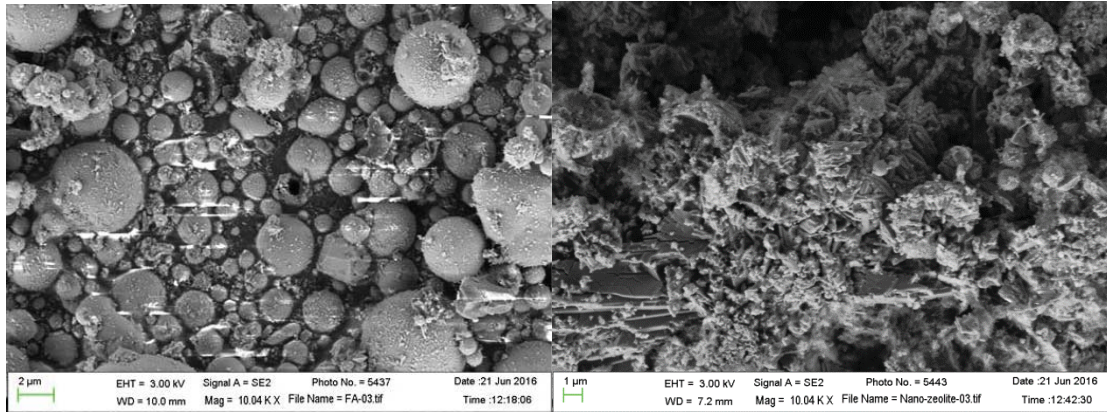
Coal fly ash (FA) was obtained from the Moneypoint thermoelectric power plants located in Co. Clare. Nano-Zeolite (NZ) was synthesized via alkaline hydrothermal treatment. Physical, chemical mineralogical composition characterizations of the samples were studied by using scanning electron microscopy (SEM) and X-ray diffraction (XRD) was performed. The surface area, cation exchange capacity phosphorous sorption index of solids (FA and NZ) was also studied.

Surface modification were conducted by adhere Cu, Mg, Fe, Zn, Ca ions on the surface of NZ by adding 0.5mol/kg of different chemicals into the autoclaves during the synthesis process of NZ. Besides, Hexadecyltrimethylammonium (HDTMA) was employed as organic surfactants, in order to change the surface properties. The modified NZ were named as Cu-NZ, Mg-NZ, Fe-NZ, Zn-NZ, Ca-NZ and HDTMA-NZ.

Batch studies were conducted to study the effect of sorption time, pH values, dosage of FA/NZ on nitrogen and phosphorus removal efficiency. Besides, a comparative batch

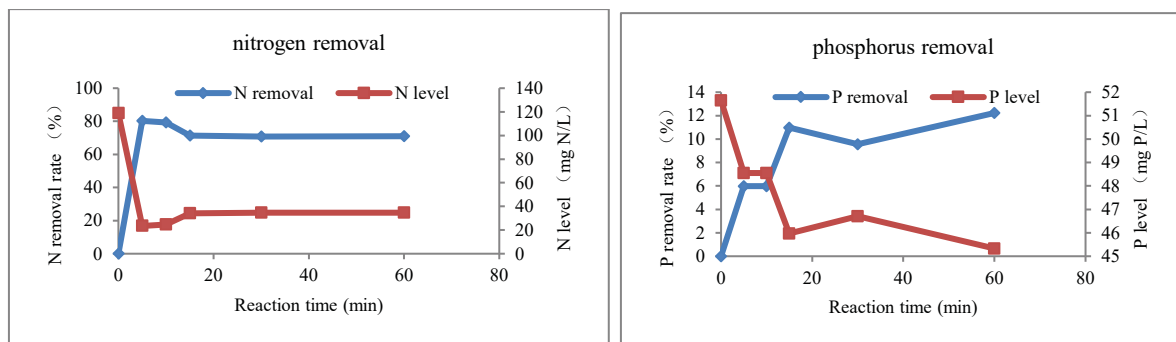
experiments were done on surface modified NZ, Activated Charcoal and Carbon nanotubes at a certain reaction time.

## MAIN RESULTS AND CONCLUSIONS



**Figure 1.** SEM images of the Coal fly ash (FA) and the Nano-Zeolite (NZ).

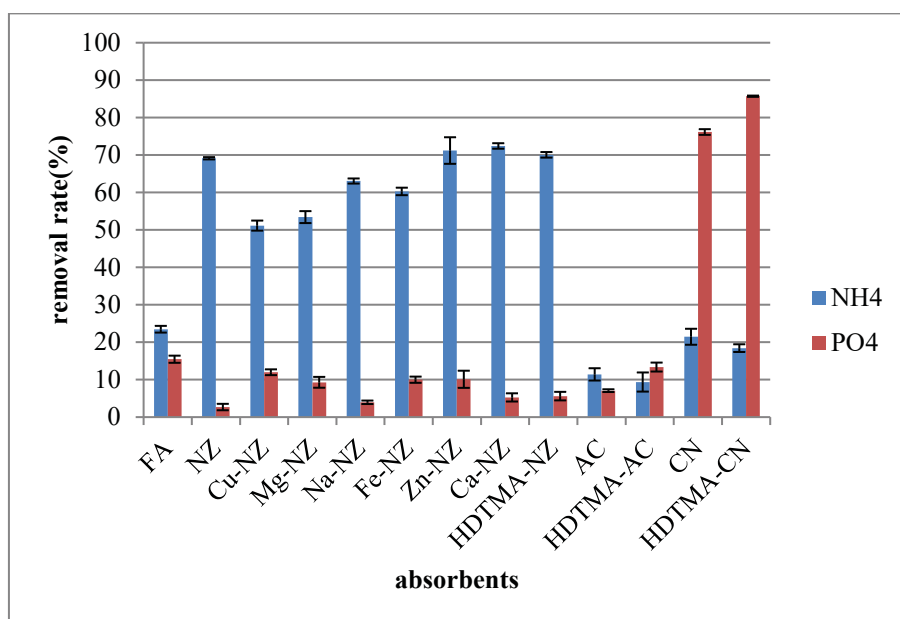
SEM images of the FA and synthesized NZ were shown in Fig. 1. SEM observation of the FA showed the presence of micro-particles in the shape of smooth balls. NaOH solution affected the FA by deforming ball-like shape and changing smooth surface into various irregularly shaped of crystals, e.g., plates and rods. The particle surface of NZ showed the formation of zeolites, as was confirmed by the XRD data of this study.



**Figure 2.** Average removal rate (%) and level of Nitrogen and Phosphorus (mg/g) by Nano-zeolite

The removal efficiencies of N and P in SW over time at the Nano-zeolite dosage of 1 g/50 ml can be seen in Fig. 2. It can be seen that both N and P levels decreased rapidly during the first 5 min due to the sorption. After that, N level increased slightly between 5 and 15 min while P level increased slightly at 30min. Within 60 min, the concentration of  $\text{NH}_4\text{-N}$  decreased from 118 to 35 mg/L (71% removal) while the concentration of  $\text{PO}_4\text{-P}$  decreased from 52 to 45 mg/L (12% removal).





**Figure 3.** Comparative experiments of ammonium and phosphate removal on different absorbents (reaction time 12 h,  $\text{NH}_4=110\text{mg/L}$ ,  $\text{PO}_4=50\text{mg/L}$ ).

The results of comparative experiments show that the modified Nano-zeolite by Ca possesses highest removal rate of ammonia (72.42%) and HDTMA-CN has the highest phosphate removal rate (85.71%).

It can be concluded that the Nano-zeolite was synthesized successfully the sorption capacity of NZ on ammonia and phosphate are 7.8mg/g and 1.2 mg/g. The adsorption process reached equilibrium in a very short time (less than 60min), which suggests that it's potential on fast immobilisation of nutrients.

Besides, the adsorption pattern of N and P are different when using this NZ to treat SWs. The ammonia removal efficiency is higher at higher pH levels while the removal of phosphate is the opposite way. There is unapparent increase on removal rates of phosphate when using modified NZs, which shows that simultaneous removal of nitrogen and phosphorus still need further research.

At the same time, carbon nanotube and modified carbon nanotube possess higher phosphate removal rate compared to NZ and modified NZ, which shows their potential in wastewater treatment.

## REFERENCES

- Cambor, M., Corma, A., & Valencia, S. (1998). Characterization of nanocrystalline zeolite Beta. *Microporous and Mesoporous Materials*, 25(1), 59-74.
- Sarkar, B., Chakrabarti, P. P., Vijaykumar, A., & Kale, V. (2006). Wastewater treatment in dairy industries — possibility of reuse. *Desalination*, 195(1-3), 141-152. doi:10.1016/j.desal.2005.11.015
- Song, W., Li, G., Grassian, V. H., & Larsen, S. C. (2005). Development of Improved Materials for Environmental Applications: Nanocrystalline NaY Zeolites. *Environmental Science & Technology*, 39(5), 1214-1220. doi:10.1021/es049194z

## REVIEWERS COMMENTS :

The abstract fits within the scope of the Conference. The theme selected by the authors is appropriate. The abstract clearly presents the subject and the main results of the study. The references are a dated. The novelty is not apparent. It looks like just another adsorption study. Not obvious how it relates to the topic of Small water / wastewater / sludge treatment and reuse



## Phosphorus removal using steel slag in reactive filters: 6 years monitoring at large scale.

Paing, J.<sup>1</sup>, Serdobbel, V.<sup>1,2</sup>, Helbert M.<sup>3</sup>, Chazarenc, F.<sup>2</sup>

<sup>1</sup> L'UNAM University, Institut Mines-Telecom Atlantique, CNRS, GEPEA, UMR 6144, 4 rue Alfred Kastler, 44307 Nantes, France

<sup>2</sup> Opure, Les Charmilles, Z.A. les Poupinières, 37360 Beaumont-la-Ronce, France

<sup>3</sup> Departmental service for wastewater treatment plant control, 18 bd Lavoisier, BP 20943, 49009 Angers, France

**Keywords:** Treatment wetlands, steel slag, phosphorus removal, reactive material

### Introduction

Phosphorus discharges from wastewater lead to water quality degradation. In order to achieve a “good ecological status of water” according to the European Water Framework, European and French regulations aims to limit total phosphorus (TP) disposal of wastewater treatment plants, even for capacity < 2000 person-equivalent (Pe), with limits between 1 and 10 mg/l, depending on the water quality of the receiving environment.

Since 1990s, Vertical Flow Constructed Wetlands (VFCWs) have been more and more popular in treating raw domestic wastewater for small municipalities in France (> 4000 units in 2017). However, phosphorus removal is limited in VFCWs (Paing et al, 2015) and the addition of chemicals such as FeCl<sub>3</sub> is not always suitable because of energy requirement, corrosive risks and maintenance needs. Therefore, there is a need for alternative technologies to overcome this situation.

Among different filters materials used for phosphorus removal, as described in Volha et al. (2011), slags (by-product of the steel industry) were selected because of low cost and site production in many countries including France. Slags are aggregated rock materials mostly made of Ca/Mg oxides, Silicates and iron.

The aim of this work was to study long term efficiency of reactive filter filled with slag material to improve phosphorus removal downstream of small wastewater treatment plants (< 2000 Pe). The study focus on the monitoring of a large-scale filter fed with secondary effluent of constructed wetlands during 5 years, completed by laboratory experiments.

### Material and Methods

This study focus on a large-scale waste water treatment plant for domestic wastewater located in France: La Chapelle-Rousselin (49). This treatment wetland was designed and constructed by Opure company (previous name Jean VOISIN), according to the classical “French system” with 2 vertical flow stages (unsaturated), with 2 m<sup>2</sup>/EH. The capacity was 900 Pe (54 kg BOD<sub>5</sub>/d, 135 m<sup>3</sup>/j) and the commissioning was in 2010. To improve phosphorus removal, a

third stage with a horizontal slag filter (90 m<sup>2</sup>) was added in June 2012. This filter treat half of the total flow from the second vertical stage, in order to increase retention time.

Additional to this large-scale monitoring, a laboratory experiment was conducted to compare the “fresh slag” and the “used slag” after 5 years.

## Results and Discussion

Mean results on treatment efficiency obtained at large scale are summarized in Table 1. Global performance removal on total phosphorus reached  $56 \pm 10\%$ , both vertical constructed wetland filters showed no significant efficiency and the 3<sup>rd</sup> stage with slag filter allowed  $55\% \pm 10\%$  removal. The concentration at the outlet is very stable and quite low compared to the regulation limit ( $< 10$  mg/l for this site) with  $3.7 \pm 0.5$  mg/l. In addition to phosphorus removal, the slag filter allowed to enhance the quality on all other parameters such as suspended solids, COD, TKN and TN, reaching 94% to 99% of global efficiency.

	Raw		2nd stage		3rd stage		% removal		% removal		% removal	
	Wastewater		effluent (VF)		effluent (SF)		(2 stages VF)		(slag filter)		(global)	
	Mean	S.D.	Mean	S.D.	Mean	S.D.	Mean	S.D.	Mean	S.D.	Mean	S.D.
<b>pH</b>	<b>8,0</b>	0,5	<b>5,0</b>	1,1	<b>7,3</b>	0,6						
<b>SS</b>	<b>284</b>	63	<b>10,2</b>	6,7	<b>6,0</b>	4,3	<b>96%</b>	2%	<b>42%</b>	18%	<b>98%</b>	1%
<b>BOD</b>	<b>252</b>	61	<b>4,0</b>	3,5	<b>3,2</b>	2,8	<b>98%</b>	1%	<b>11%</b>	54%	<b>99%</b>	1%
<b>COD</b>	<b>632</b>	143	<b>57</b>	26	<b>39</b>	17	<b>91%</b>	3%	<b>26%</b>	28%	<b>94%</b>	2%
<b>TKN</b>	<b>75</b>	16	<b>3,6</b>	3,0	<b>2,2</b>	0,4	<b>95%</b>	4%	<b>20%</b>	30%	<b>97%</b>	1%
<b>N-NH4</b>	<b>52</b>	13	<b>2,8</b>	1,8	<b>2,0</b>	0,0						
<b>N-NO3</b>			<b>54</b>	23	<b>46</b>	18						
<b>TN</b>			<b>59</b>	25	<b>48</b>	18	<b>24%</b>	18%	<b>13%</b>	25%	<b>36%</b>	18%
<b>TP</b>	<b>8,9</b>	3,2	<b>8,7</b>	2,8	<b>3,7</b>	0,5	<b>1%</b>	8%	<b>55%</b>	10%	<b>56%</b>	10%

**Table 1: Mean characteristics of influent and effluent from large scale treatment wetland during 5 years monitoring (N=5).**

The experiment conducted in laboratory with longer residence time showed a better percentage removals with 88% of TP for “used slag” and 79% for “fresh slag”. We can conclude than after 5 years operating and a quantity of 2 gP/kg slag removed (estimation), the slag still performed well and that removal efficiency can be improved by increasing residence time.

## References

- Paing J., Gilbert A., Gagnon V., Chazarenc F., 2015. Effect of climate, wastewater composition, loading rates, system age and design on performances of French vertical flow constructed wetlands: A survey based on 169 full scal systems. *Ecological Engineering*, 80, 46-52.
- Vohla C., Koiv M., Bavor H.J., Chazarenc F., Mander U., 2011. Filter materials for phosphorus removal from wastewater treatment – A review. *Ecological Engineering*, 37(1), 70-89.

# Modelling of phosphorus recovery by fixed bed reactor of scallop shell particles

Ito, R.<sup>1</sup>, Kaneko, S.<sup>2</sup>, Funamizu, N.<sup>1</sup>

<sup>1</sup> Faculty of Engineering, Hokkaido University, Kita 13 Nishi 8, Kitaku, Sapporo 0608628 Hokkaido, Japan

<sup>2</sup> Graduate School of Engineering, Hokkaido University, Kita 13 Nishi 8, Kitaku, Sapporo 0608628 Hokkaido, Japan

**Keywords:** non-steady state; surface reaction; diffusion; Phreeqc

## Introduction

Urine has a potential as phosphorus resources. Direct use of collected urine to farmland has problems on its utilization, such as bad smell of ammonia, low concentration of nutrients comparing with solid fertilizers. To overcome these problems, we proposed some techniques to produce solid fertilizer of slow released nitrogen fertilizer<sup>1,2)</sup> and calcium phosphate<sup>3)</sup> with scallop shell particles from urine. Most of urine is generated from domestic houses, while the recovery should be done in house, therefore the reactor should be small scale and decentralized type. Considering this situation, a fixed bed reactor with simple configuration can be used for the production of calcium phosphate, although the reaction kinetics is not unclear. The aim of this paper is to develop a mathematical model for the reactions of calcium, phosphate and other ions in the fixed bed.

## Material and Methods

Shell particles were sieved into the range from 0.71 to 1.19 mm. Synthetic urine were prepared based on the research of Wilsenach<sup>4)</sup>, from which urea were excluded to avoid the effect of urea hydrolysis. A series of column operations were conducted with cylindrical columns. The bottom outlets were connected with silicon tube with inner diameters 0.7 mm and the other side was kept as high as the certain height of the shell bed. The column was filled with tap water and the shell particles. The bed porosity was 0.445 in average. The synthetic urine was started to be supplied to the column from upper side by tubing pumps with silicon tube whose diameter were 1mm. During the operations, several milliliters of sample were taken from effluent periodically, to be filtered with cellos acetate membrane filter with pore size of 0.45  $\mu\text{m}$  (25CS045AN, ADVANTEC®). Part of them are used for measurement of inorganic carbon with a TOC analyzer (TOC-5000A, SHIMADZU) under appropriate dilution with deionized water while rest of them were stored after addition of 1%-vol. of nitric acid (1%-volume) (140-04016, Wako) for stabilization until measurement with an ICP-AES analyzer (ICPE-9000, SHIMADZU) for calcium, phosphorus, sulfur and potassium. At each sampling, a few milliliters of samples were directly put on a pH meter (LAQUA twin, HORIBA). The experiments were conducted at room temperature 25°C.

The analysis was conducted with Phreeqc of an equilibrium solver. The reaction model considers advection model and the ions diffuses from the bulk solution to surface and inside of the crystal layer. The reaction rate coefficient of the precipitation was obtained from batch tests. Using this mathematical model, the concentrations were simulated.

## Results and Discussion

During the experiment, the concentration of phosphate was lower than that at initial to indicate recovery of phosphate. The carbonate concentration was same level of the difference of the phosphorus concentration between initial and effluent. This means the replacement of carbonate in calcium carbonate with phosphate. After 200 hours, the concentration of phosphate increased, while that of carbonate decreased. This fact shows a decrease of the reaction rate of replacement. pH and the concentration of calcium were stable. The lines are estimated values by the simulation to show good agreement with the experimental data.

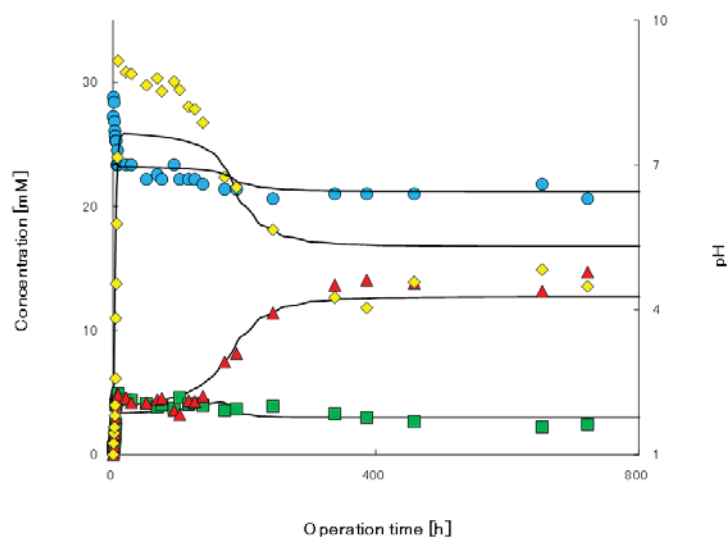


Figure Typical time course of ion concentrations in column effluent: blue circle pH, yellow diamond: CO<sub>3</sub><sup>2-</sup>, red triangle: phosphate, green square: calcium

## References

- 1) Ito, R., Takahashi, E. and Funamizu, N.: Production of slow-released nitrogen fertilizer from urine., *Environmental technology*, Vol. 34, No. 17–20. 2013.
- 2) Kabore, S., Ito, R. and Funamizu, N.: Reaction kinetics for the production of methylene urea from synthetic human urine, *J. Environ. Chem. Eng.*, Vol. 4, No. 2, 2016.
- 3) Ito, R. and Funamizu, N.: Phosphate Recovery from Synthetic Urine with Shell of *Mizuhopecten yessoensis*, *J. Water Environ. Technol.*, Vol. 14, No. 6, pp. 437–446, 2016.
- 4) Wilsenach, J. A., Schuurbijs, C. A. H. and van Loosdrecht, M. C. M.: Phosphate and potassium recovery from source separated urine through struvite precipitation, *Water Res.*, Vol. 41, No. 2, pp. 458–466, 2007.

## Use of reactive material for P removal in small treatment plants, potential of industrial by-products in India

Yadav, A.<sup>1</sup>, Mutnuri, S.<sup>1</sup>, Chazarenc, F.<sup>2</sup>

<sup>1</sup> Applied Environmental Biotechnology Laboratory, Department of Biological Sciences, BITS Pilani K.K. Birla Goa Campus, Goa, India

<sup>2</sup> GEPEA, UMR CNRS 6144, IMT Atlantique, 44307 Nantes, France

**Keywords:** Constructed wetlands; Steel slag, Bauxite ore, bentonite clay, Kiln ash, Fire brick, phosphorus removal

### Introduction

Discharge of phosphorus polluted wastewater is the of major factor for the excessive growth of photosynthetic algae and cyanobacteria which leads to the eutrophication of surface water bodies [1]. The aim of this work was to establish and compare the phosphate removal capacities of five different materials like steel slag, bauxite ore, bentonite clay, fire brick, and kiln ash from blast furnace and to provide selection criteria for substrates that would enhance phosphate removal downstream of existing wastewater treatment plants such as constructed wetland system. These systems generally enable to treat biochemical oxygen demand (BOD), suspended solids (SS) and kjeldahl nitrogen but are limited in removing phosphorus [2,]. In vertical flow constructed wetland removal of phosphorus mainly occurs through substratum adsorption, to a minor extend plant uptake and incorporation into organic matter can remove a fraction of P but this is not sustainable [3,4,5].

Therefore, there is an urgent need for new technologies to overcome this situation, our project was conducted in this context.

### Material and Methods

Reactive materials were collected from different places in India. The steels slag and kiln ash was procured from the company Goa Sponge Ltd, Bauxite ore was obtained from mining industry in Goa. Bentonite clay was available commercially and fire brick was taken from the waste from fire brick manufacturing small scale industry in Uttar Pradesh. The samples were grinded manually according to the granular size of 5-10 mm to perform the batch experiments. This enables the results to be compared with the size of field scale filters. Before the experiments, the samples were washed first with tap water to remove fine particles and then dried at 105°C for 24 h. Energy dispersive X-ray fluorescence analyses (EDX) were performed to determine the semiquantitative chemical composition of the samples (Rayny series EDX-800HS spectrometer, Shimadzu Corporation, Kyoto, Japan).

For each reactive material, a series of 6 glass bottles each containing 1 L of a synthetic solution with different initial PO<sub>4</sub>-P concentrations (0, 5, 10, 20, 25, 100 mg P/L) was prepared. The bottles were placed on a shaker at 125 rpm under controlled temperature conditions (20°C). The residual PO<sub>4</sub>-P and Ca<sup>2+</sup> concentrations of the solutions were measured after 7 days of agitation, when a pseudo-equilibrium in PO<sub>4</sub>-P removal was reached. The solution were filtered before residuals PO<sub>4</sub>-P, TP(Total phosphorus) and Ca<sup>2+</sup> concentration were measured.

## Expected Results and Discussion

It is expected that the Steel slag collected from steel manufacturing industry will show some promising results as in the manufacturing process lime is added to the furnace. The high content of CaO and Fe in the steel slag has shown good result in the previous studies. All the other materials we are using also have some amount of Fe, Al and CaO content (6,7,8). P removal will be according to the Fe, Al, CaO dissolution and adsorption of Fe-P, Al-P and Ca-P complexes. The best material showing promising result will be used for the field scale studies in India. As these materials are very cheap and easily available in large scale in India.

## References

1. U.S.EPA, "Handbook Retrofitting POTW's for Phosphorus Removal in the Chesapeake Bay Drainage Basin," EPA/625/6-87/017 EPA/625/6-87/017,1987.
2. Moshiri G. A. (ed.) (1993) *Constructed Wetlands for Water Quality Improvement*. Lewis Publishers, Boca Raton, FL, USA
3. Drizo A. (1998) Phosphate and ammonium removal from waste water, using constructed wetland systems. Ph.D. thesis, University of Edinburgh
4. Karczmarczyk, A., & Renman, G. (2011). Phosphorus Accumulation pattern in a subsurface constructed wetland treating residential wastewater. *Water*, 3(1), 146-156.
5. Arias, C. A., Brix, H., & Johansen, N. H. (2003). Phosphorus removal from municipal wastewater in an experimental two-stage vertical flow constructed wetland system equipped with a calcite filter. *Water Science and Technology*, 48(5), 51-58.
6. Haghseresht, F., Wang, S., & Do, D. D. (2009). A novel lanthanum-modified bentonite, Phoslock, for phosphate removal from wastewaters. *Applied Clay Science*, 46(4), 369-375.
7. Pereira, D. A., Couto, D. M., & Labrincha, J. A. (2000). Incorporation of alumina rich residues in refractory bricks. In CFI. *Ceramic forum international* (Vol. 77, No. 7, pp. E21-E25). Göller.
8. Vohla, C., Kõiv, M., Bavor, H. J., Chazarenc, F., & Mander, Ü. (2011). Filter materials for phosphorus removal from wastewater in treatment wetlands—A review. *Ecological Engineering*, 37(1), 70-89.



**Parallel session 7 - Waste Stabilization Ponds**

09:50-11:10

Session chair: Kuruvilla Mathew

**493 - Small is beautiful, small is efficient: The future of waste stabilisation ponds in Australia**

GHADOUANI Anas - *The University of Western Australia*

**482 - Application of high-resolution bathymetry mapping for sludge management in waste stabilisation ponds**

COGGINS Liah - *The University of Western Australia*

**629 - Factors affecting the removal of bacterial indicator organisms in wastewater stabilization ponds operated in a temperate climate**

LIU Lei - *Queen's University, Department of Civil Engineering*

**632 - Modeling and validation of stratification and hydrodynamics in a wastewater stabilization pond using Delft3D**

CHAMPAGNE Pascale - *Queen's University, Department of Civil Engineering*

**Parallel session 8 - Membrane technology**

11:30-12:50

Session chair: Maxime Pontie

**491 - Correcting nutrient imbalance in hand washing water to permit recycling with a biologically activated membrane bioreactor (BAMBi)**

ZIEMBA Christopher - *Eawag*

**574 - Economic and environmental analysis of the new resource toilet with forward osmosis technology**

SHI Yi-lei - *Tsinghua University*

**611 - Innovative and easy-handling membrane-based water treatment system for decentralized applications**

ORDONEZ ANDRADE Jose Abdon - *University of Kassel, Department of Sanitary & Environmental Engineering*

**312 - Optimizing the design and operation of a novel process: The Membrane aerated biofilm reactor integrated with activated sludge-(MABR-IFAS)**

PEREZ CALLEJA Patricia - *University of Cantabria*

**Parallel session 9 - Toxic and emerging pollutants 2**

14:00-15:00

Session chair: Yaqian Zhao

**437 - Drugs abatement in surface water using photocatalytic coated glass surfaces**

BIANCHI Claudia - *University of Milan*

**265 - Biochar efficiently removes recalcitrant pharmaceuticals from wastewater**

DALAHMEH Sahar - *Swedish University of Agricultural Sciences*

**446 - Removal of micropollutants and nutrients in filter beds for on-site sewage treatment - column and field experiments**

ZHANG Wen - *KTH Royal Institute of Technology*

**Parallel session 10 - Small wastewater treatment systems 3**

15:20-16:20

Session chair: Michel Torrijos

**718 - Integrated piggery wastewater and microalgal biomass production – a pilot plant case study**

CHENG Ngai Ning - *Flinders University*

**322 - Alternative On-Site Wastewater Treatment Technologies to Reduce Biochemical Oxygen Demand, Total Suspended Solids, Oil and Grease, and Total Nitrogen from High Strength Commercial Wastewater**

HAASE Peter - *Fall Creek Engineering*

**295 - Recently emerging eco-friendly systems for wastewater purification: A review**

ZHAO Yaqian - *University College Dublin*

# Small is beautiful, small is efficient: The future of waste stabilisation ponds in Australia

Ref # S2SMALL-33690

Anas Ghadouani<sup>\*</sup>, Liah X. Coggins

<sup>1</sup> School of Civil, Environmental and Mining Engineering, The University of Western Australia, 35 Stirling Highway, M015, Crawley 6009, Western Australia, Australia

\* Presenting Author: [anas.ghadouani@uwa.edu.au](mailto:anas.ghadouani@uwa.edu.au)

**Keywords:** design, management, performance, planning, waste stabilization ponds

## INTRODUCTION / MAIN METHODS

By 2025, it is anticipated that up to two-thirds of the world population could be living under water-stressed conditions, as demand for safe water will exceed availability in many regions (UNDP 2006; UN-Water and FAO 2007). One of the biggest challenges facing water resource management is the lack of adequate water and wastewater infrastructure in the developing world, and the aging of existing networks in the developed world (Rodriguez *et al.* 2012). While water services are essential for socioeconomic development and increased societal productivity, they remain severely underfunded on a global scale, with a large portion of the gap in the investment attributed to delays in infrastructure and inadequate maintenance (Rodriguez *et al.* 2012).

Waste stabilisation ponds (WSPs) are the most widely used technology for the treatment of wastewater worldwide. These wastewater treatment systems are generally used to service small populations in rural and remote areas, however where land area is available there are plants successfully servicing up to 2.5 million people (e.g., Western Treatment Plant, Melbourne, Australia). Pond systems work through a multivariate process (Figure 1), where WSPs are designed to take into account elements of loading, hydraulics, sludge, ecology and climate. Efficient WSP systems rely on wastewater being present in ponds for the designed minimum hydraulic retention time to treat the incoming load.

In light of the growing pressures on our wastewater infrastructure, it is vital to apply a more integrated approach to understand the drivers in WSP performance in order to meet future demand. Our ability to diagnose problems in WSP systems is becoming increasingly important, as more pressure is placed upon systems to meet increasing demand. To this end, the development of rapid, high-resolution tools for studying WSPs is critical to solve current deficiencies, as well as to highlight processes and interactions that are often overlooked due to their complexity or the inherent difficulty in quantifying them.

The approach used in this study calls upon high-resolution data of sludge bathymetry, hydrodynamic modelling, as well as experimental microbial ecological approaches, to work towards and deliver a fully integrated approach to the planning, design, and operation of WSPs.

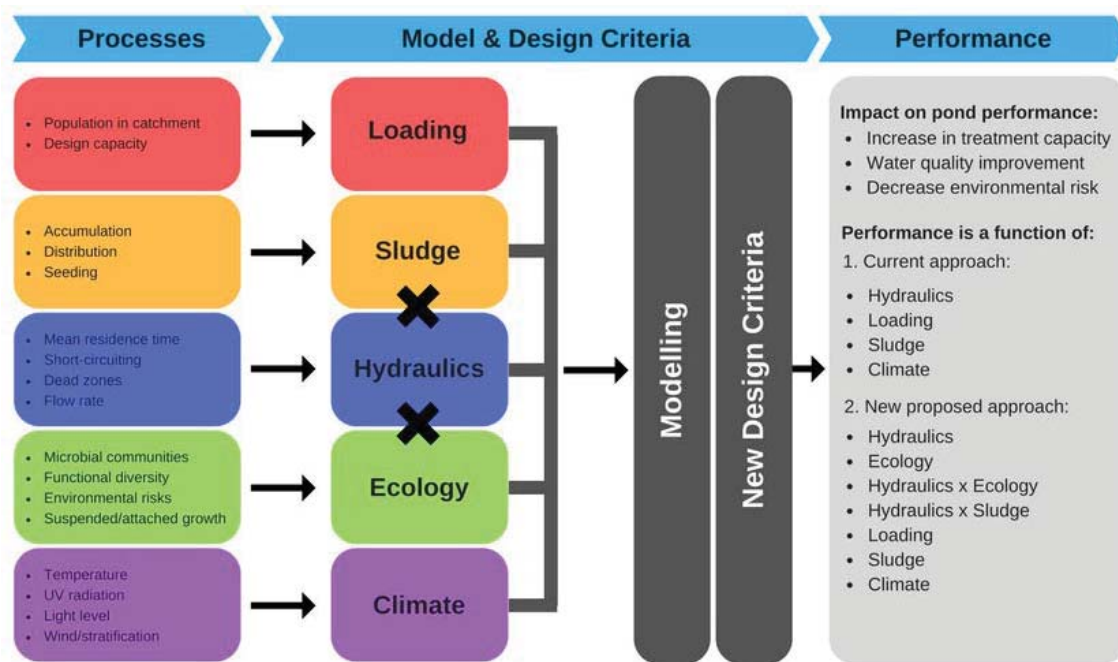
## MAIN RESULTS AND CONCLUSIONS

Sludge management is of vital importance to pond treatment performance, and sludge removal is extremely expensive. Through the development of a high-resolution measurement platform for the collection of sludge bathymetry data, we have not only been able to improve the resolution of sludge bathymetry data, but also provide a tool for pond managers to more regularly complete surveys to better inform expensive sludge management operations (Chua

*et al.* 2013; Coggins *et al.* 2017). The high-resolution data collected using this platform has also been used to develop a more reliable and accurate model of the evolution of pond hydrodynamics (Coggins *et al.* 2017); the high-resolution bathymetry also makes it possible to model pond upgrades, such as baffles.

There is also a need to move away from traditional microbial measurement techniques, such as heterotrophic plate counts (HPCs) for the quantification of wastewater communities, towards techniques which can act as more rapid, accurate indicators of pond performance. For example, we have shown that metabolomics is a useful tool to determine the ‘human signal’ throughout the pond treatment train (Reichwaldt *et al.* 2017). Additionally, flow cytometry, currently used as the guideline method for assessing drinking water in Switzerland (e.g., Prest *et al.* 2013), may also be applied for the rapid quantification of WSP algal and microbial communities.

Additionally, there is scope to more fully integrate studies on pond hydraulics with pond microbial ecology, to gain a better understanding of the interplay of these factors and their combined effect on treatment performance. This includes the measurement of greenhouse gas (GHG) fluxes (Glaz *et al.* 2016), as well as mitigation strategies for toxic cyanobacterial blooms (e.g., Barrington *et al.* 2011; Barrington *et al.* 2014).



**Figure 1: Conceptual framework of processes, drivers, and criteria for current and proposed future design of WSPs. This also shows that the relationships between the main drivers are complex, as sludge has an effect on hydraulics, and hydraulics interacts with pond ecology.**

A more integrated approach is required to not only understand how our systems currently perform, but also to inform new design criteria (Figure 1), both for both new pond systems and the upgrade of existing assets. This new approach recognises that pond design criteria cannot be assessed in isolation, and that there needs to be more connectivity in the research surrounding pond performance related to hydraulics, sludge, and pond ecology. Overall, through a better understanding of the interplay between processes (Figure 1), we will be able to develop new design criteria allowing the adaptation of these systems to be sustainable long into the future, in the hope of meeting the future demands on our wastewater infrastructure.

## REFERENCES

- Barrington D. J., Ghadouani A. and Ivey G. N. 2011. Environmental Factors and the Application of Hydrogen Peroxide for the Removal of Toxic Cyanobacteria from Waste Stabilization Ponds. *Journal of Environmental Engineering-Asce*, **137**(10), 952-60.
- Barrington D. J., Ghadouani A., Sinang S. C. and Ivey G. N. 2014. Development of a new risk-based framework to guide investment in water quality monitoring. *Environmental Monitoring and Assessment*, **186**(4), 2455-64.
- Chua A., Trolio R., Ghadouani A. and Coggins L. 2013. Application of sonar technology for the profiling of sludge in wastewater pond systems. *Water*, **40**(5), 55-60.
- Coggins L. X., Ghisalberti M. and Ghadouani A. 2017. Sludge accumulation and distribution impact the hydraulic performance in waste stabilisation ponds. *Water Research*, **110**, 354-65.
- Glaz P., Bartosiewicz M., Laurion I., Reichwaldt E. S., Maranger R. and Ghadouani A. 2016. Greenhouse gas emissions from waste stabilisation ponds in Western Australia and Quebec (Canada). *Water Research*, **101**, 64-74.
- Prest E. I., Hammes F., Kotsch S., van Loosdrecht M. C. M. and Vrouwenvelder J. S. 2013. Monitoring microbiological changes in drinking water systems using a fast and reproducible flow cytometric method. *Water Research*, **47**(19), 7131-42.
- Reichwaldt E. S., Ho W. Y., Zhou W. and Ghadouani A. 2017. Sterols indicate water quality and wastewater treatment efficiency. *Water Research*, **108**, 401-11.
- Rodriguez D. J., van den Berg C. and McMahon A. 2012. *Investing in Water Infrastructure: Capital, Operations and Maintenance*, World Bank, Bank W, Washington DC.
- UN-Water and Food and Agriculture Organisation (FAO) 2007. *Coping with water scarcity: Challenge of the twenty-first century*, United Nations Water.
- United Nations Development Programme (UNDP) 2006. *Human Development Report 2006 - Beyond scarcity: Power, poverty and the global water crisis*, Macmillan P, New York, New York.

# Application of high-resolution bathymetry mapping for sludge management in waste stabilisation ponds

Ref # S2SMALL-14678

Liah X. Coggins<sup>1\*</sup>, Marco Ghisalberti<sup>1,2</sup>, Anas Ghadouani<sup>1</sup>

<sup>1</sup> School of Civil, Environmental and Mining Engineering, The University of Western Australia, 35 Stirling Highway, M015, Crawley 6009, Western Australia, Australia

<sup>2</sup> Department of Infrastructure Engineering, The University of Melbourne, Parkville 3010, Victoria, Australia

\* Presenting Author: [liah.coggins@uwa.edu.au](mailto:liah.coggins@uwa.edu.au)

**Keywords:** bathymetry mapping, CFD modelling, pond hydraulics, sludge, sludge management, waste stabilization ponds

## INTRODUCTION / MAIN METHODS

Sludge accumulation in waste stabilisation ponds (WSPs) can impact performance by reducing effective pond volume, and altering pond hydraulics and wastewater treatment efficiency (e.g., Persson 2000; Sah *et al.* 2012). Traditionally, sludge heights, and thus sludge volume, have been measured using low-resolution and labour intensive methods such as ‘sludge judge’. Currently, this low-resolution WSP bathymetry data has made it difficult to validate hydrodynamic models of these systems (e.g., Olukanni & Ducoste 2011; Alvarado *et al.* 2013; Passos *et al.* 2016), and thus higher resolution data is needed to significantly improve the reliability of models of WSPs.

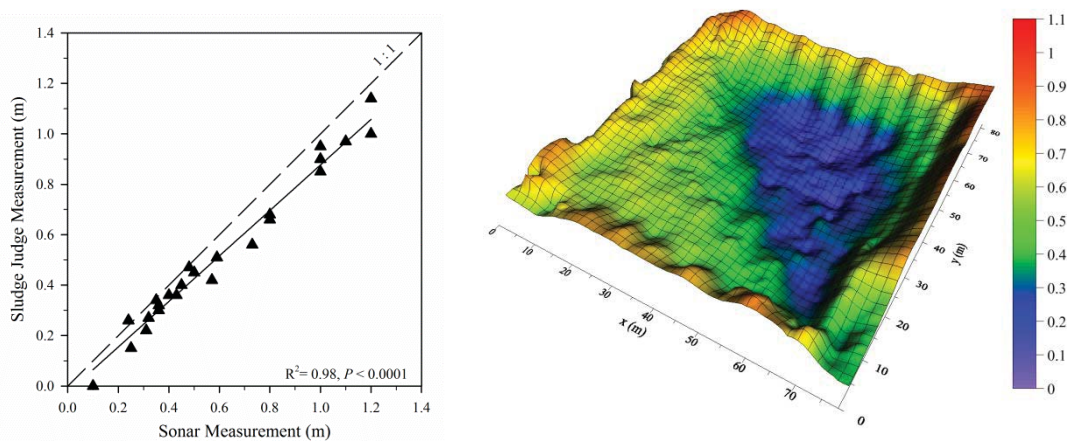
The aims of this study were: 1) to develop a tool to collect high-resolution data of WSP bathymetry, 2) to construct a hydrodynamic model using collected high-resolution bathymetry data, and 3) to determine the effect that sludge accumulation and distribution have on the hydraulics of a range of WSP systems.

A sonar device with built-in GPS and data logging ability was fitted to a remotely operated vehicle (ROV), and then compared to the measurements taken with a sludge judge. A 2D hydrodynamic model of WSPs was set up using the high-resolution bathymetry data collected with the ROV, and then calibrated and validated through field tracer experiments. The validated model was then applied to determine the effect of range of sludge scenarios on pond (Coggins *et al.* 2017).

## MAIN RESULTS AND CONCLUSIONS

Comparing the results from a sludge judge survey to one collected with the sonar, there is a very clear and strong correlation ( $R^2 = 0.98$ ) between the measurement techniques (Figure 1). Using an ROV greatly reduced profiling time, with >25000 data points collected in 20-30 mins. In addition, the ROV greatly reduced the safety risks of operators having to go out onto ponds. An example of a sludge survey completed with the ROV is shown in Figure 1. In general, sludge judge surveys can only capture pond-scale features, while a sonar survey determines sludge bathymetry, showing the sludge blanket in sufficient detail for bathymetry-induced changes in flow to be accurately predicted. To date, the ROV has been used >400 WSPs across Australia, as well as in some lakes, stormwater wetlands, and rivers.





**Figure 1. (Left) Sonar vs. sludge judge measurements of sludge height, where the dashed line indicates the 1:1 relationship. The relationship between the data collected using both methods shows that the techniques are comparable for the estimation of sludge height. (Right) A pond sludge profile collected using the ROV, showing a non-uniform distribution; colour scale shows sludge height in metres, pond depth 1.1m.**

Hydrodynamic modelling was conducted for three sites with varying sludge distributions, i.e., uniform, edge accumulation, and a highly channelized pond (e.g., Figure 1), with various infill volumes (no sludge, and up to 58% infill). In the range of ponds modelled, reductions in residence times ranged from 33% in a pond with a uniform sludge distribution to a reduction of up to 60% in a pond with highly channelized flow. It was found that hydraulic performance of ponds was not only affected by sludge accumulation, but also that the distribution played a role in performance (Coggins *et al.* 2017).

Overall, we have demonstrated that the developed ROV can successfully measure sludge distribution with high-resolution, and that the collected data can be input into a hydrodynamic model. By applying this to the study of three sites, we have shown that pond hydraulics is mainly influenced by the accumulation of sludge, with the distribution of sludge also having an addition effect on pond hydraulics.

## REFERENCES

- Alvarado A., Vesvikar M., Cisneros J. F., Maere T., Goethals P. and Nopens I. 2013. CFD study to determine the optimal configuration of aerators in a full-scale waste stabilization pond. *Water Research*, **47**(13), 4528-37.
- Coggins L. X., Ghisalberti M. and Ghadouani A. 2017. Sludge accumulation and distribution impact the hydraulic performance in waste stabilisation ponds. *Water Research*, **110**, 354-65.
- Olukanni D. O. and Ducoste J. J. 2011. Optimization of waste stabilization pond design for developing nations using computational fluid dynamics. *Ecological Engineering*, **37**(11), 1878-88.
- Passos R. G., Dias D. F. C. and von Sperling M. 2016. Review of practical aspects for modelling of stabilization ponds using Computational Fluid Dynamics. *Environmental Technology Reviews*, **5**(1), 78-102.
- Persson J. 2000. The hydraulic performance of ponds of various layouts. *Urban Water*, **2**(3), 243-50.
- Sah L., Rousseau D. P. L. and Hooijmans C. M. 2012. Numerical Modelling of Waste Stabilization Ponds: Where Do We Stand? *Water Air and Soil Pollution*, **223**(6), 3155-71.



# The Effect of pH on the Removal of Bacterial Indicator Organisms in Wastewater Stabilization Ponds

Ref # S2SMALL-99808

Lei Liu<sup>1</sup>, Geof Hall<sup>1</sup>, Pascale Champagne<sup>1\*</sup>

<sup>1</sup> Queen's University, 58 University Ave., Kingston, ON, Canada

\* Corresponding Author: pascale.champagne@queensu.ca

**Keywords:** Wastewater stabilization ponds (WSPs); bacterial indicator organisms; pH

## INTRODUCTION / MAIN METHIODES

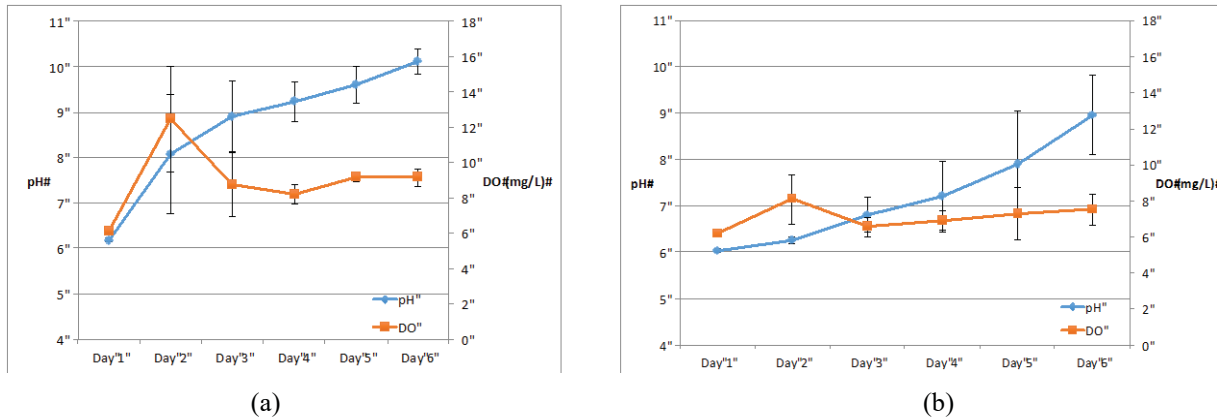
The aim of this work was to investigate the effect of pH on the removal of bacterial indicator organisms in a WSP operated in a temperate climate. Disinfection efficiency in WSPs is strongly influenced by environmental factors, as the treatment in a WSP is dependent on natural purification. Environmental factors, such as pH, dissolved oxygen (DO), temperature and sunlight intensity play an important role in pathogen removal. High pH levels (pH >9) have been recognized in the literature as a critical mechanism for pathogen inactivation in WSPs. A neutral to slightly acidic pH (between 6.5 and 7.5) is optimal for fecal bacteria growth, while pH levels above 9 are effective in indicator organism removal (Davies-Colley et al., 2000; Awuah, 2006; Ansa et al., 2011, 2012). *Escherichia coli* (*E. coli*), fecal coliforms and total coliforms are the most commonly used pathogenic indicator organisms, however, concerns with respect to their limitation and accuracy have recently been reported, and potential strategies to overcome some of these have been proposed (Bouhoum et al. 2000; Betancourt and Rose 2004; Coulon et al. 2010). In this study, *Enterococci* and *Clostridium Perfringens* were selected, in addition to conventional indicator organisms, to investigate the effects of environmental factors on the inactivation of a variety of microorganisms.

The WSP system investigated in this study is located on the north shore of Lake Ontario (Canada). Samples were collected from the inlet to the pond system. Algae samples were cultivated in Bold's Basal Medium (BBM) for 6 days, and pH and DO values were recorded. The culture and enumeration of indicator organisms were carried out using the membrane filtration method according to the Standard Methods for the Examination of Water and Wastewater (APHA, 2005). The plates were cultured at temperatures of 37°C (*E. coli*, fecal coliforms, total coliforms and *Enterococci*) and 44°C (*Clostridium Perfringens*) for 24 hrs. Five pH levels (4, 7.5, 8.5, 9.5 and 10.5) were investigated. pH in wastewater samples was adjusted accordingly using 1 N sodium hydroxide or 1 N hydrochloric acid.

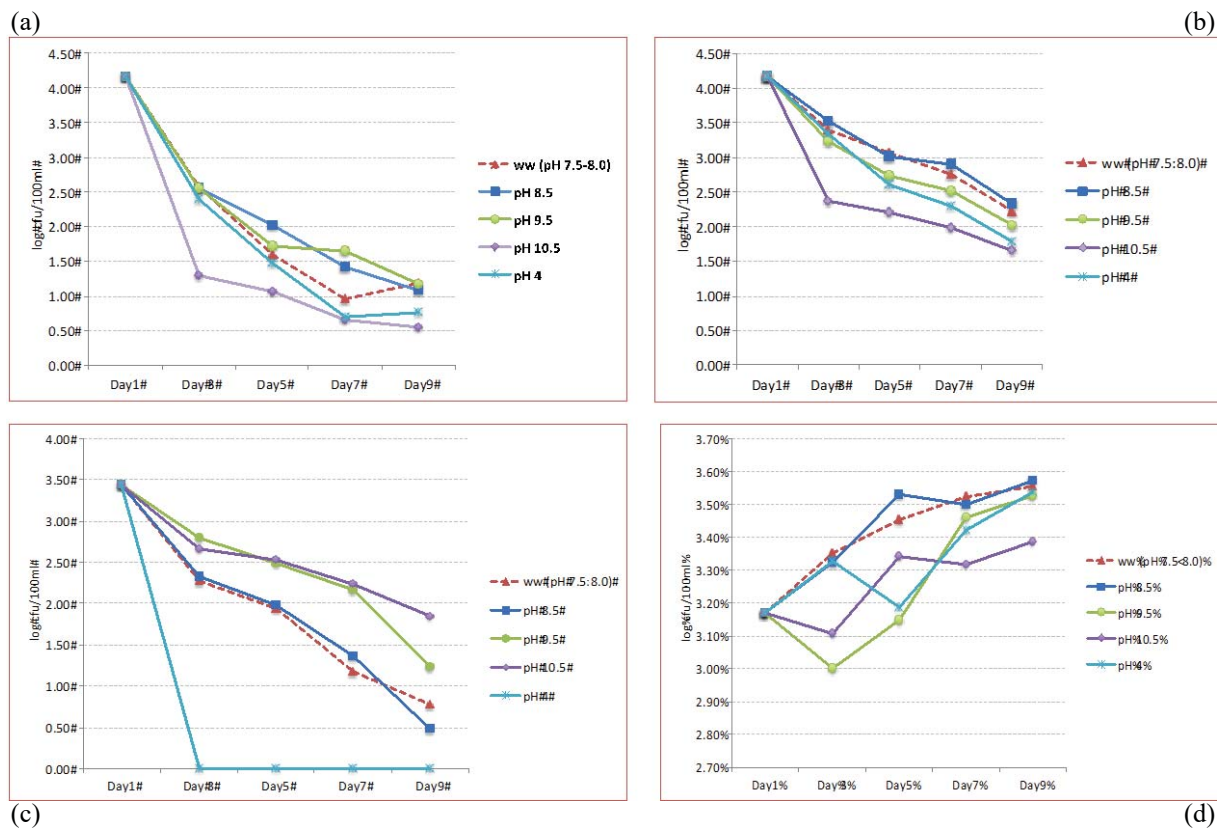
## MAIN RESULTS AND CONCLUSIONS

Two species of macroalgae were found in the WSP during the summer sampling season of 2016; water net (*Hydrodictyon*) and filamentous (*Spirogyra*) algae. Algal growth showed strong positive correlations with pH and DO in laboratory experiments (spearman's coefficient of 0.82) (Figure 1). *E. coli* decayed faster under pH levels of 10.5 and pH 4 in comparison to other pH conditions tested. Total coliforms showed an increase in mortality with increasing pH from 8.5 to 10.5. *Enterococci* responded differently to basic condition than *E. coli* and total coliforms as their mortality was lower under acidic condition than basic

condition. *Clostridium perfringens* are spore-forming bacteria that are more resistant to environmental stresses. They can survive and even grow under extreme pH conditions (pH 4 and pH 10.5). This study confirmed that traditional indicator organisms, *E. coli* and total coliforms offer some limitations in their ability to represent an overall level of pathogens in treated wastewater. It would be recommended that additional indicator organisms, such as *Enterococci* and *Clostridium Perfringens* be considered in regular disinfection monitoring programs and included in discharge regulation.



**Figure 1.** DO and pH changes as a function of macroalgae ((a): *Spirogyra*, (b): *Hydrodictyon*) in BBM with a starting pH of 6.



**Figure 2.** The effect of different pH levels on the mortalities of *E. coli* (a), total coliforms (b), *Enterococci* (c) and *Clostridium perfringens* (d).

## REFERENCES

- Ansa E. D. O., Lubberding H.J., Ampofo J. A. & Gijzen H. J. 2011 The role of algae in the removal of *Escherichia coli* in a tropical eutrophic lake. *Ecol. Eng.* **37** (2011), 317-324.
- Ansa E. D. O., Lubberding H. J., Ampofo J. A., Amegbe G. B. & Gijzen H. J. 2012 Attachment of faecal coliform and macro-invertebrate activity in the removal of faecal coliform in domestic wastewater treatment pond systems. *Ecol. Eng.* **42** (2012), 35-41.
- Awuah E. 2006 *Pathogen removal mechanisms in waste stabilisation ponds*. PhD thesis, Wageningen University/UNESCO-IHE Institute for Water Education, The Netherlands.
- Betancourt W. Q. & Rose J. B. 2004 Drinking water treatment processes for removal of *Cryptosporidium* and *Giardia*. *Veterinary Parasitology* **126** (1-2), 219-234.
- Bouhoum K., Amahmid O. & Asmama S. 2000 Occurrence and removal of protozoan cysts and helminth eggs in waste stabilisation ponds in Marrakech. *Water Sci Technol* **42**(10 11):159–164.
- Coulon C., Collignon A., McDonnell G. & Thomas V. 2010 Resistance of *Acanthamoeba* spp. cysts to disinfection treatments used in healthcare settings. *J. Clin. Microbiol.* **48**, 2689–2697.
- Davies-Colley R. J., Donnison A. M. & Speed D. J. 2000 Towards a mechanistic understanding of pond disinfection. *Water Sci. Technol.* **42**, 149 - 158.
- Standard Methods for the Examination of Water and Wastewater* 2005, American Public Health Association/American Water Works Association/Water Environment Federation, Washington DC, USA.

# Modeling and validation of stratification and hydrodynamics in a wastewater stabilization pond using Delft3D

Ref # S2SMALL-99808

Rey, A.<sup>1</sup>, Sauder, M.<sup>1</sup>, Mulligan, R.<sup>1</sup>, Boegman, L.<sup>1</sup>, Filion, Y.<sup>1</sup>, da Silva, A.M.<sup>1</sup>, Champagne, P.<sup>1\*</sup>

<sup>1</sup>Department of Civil Engineering, Queen's University, Kingston, ON K7L3N6, Canada

\* Corresponding Author: [pascale.champagne@queensu.ca](mailto:pascale.champagne@queensu.ca)

**Keywords:** Wastewater Stabilization Ponds, Simulation, Wind-induced mixing, Baffles, CFD modelling, Delft3D

## INTRODUCTION

Wastewater stabilization ponds (WSPs) use natural processes to both disinfect and stabilize wastewater, and are a frequently applied treatment method. Traditionally designed as perfectly mixed reactors of plug-flow, there is a need for an improved understanding of spatial variability in hydrodynamic processes. This would allow for applications coupled with biological and water quality models to investigate transport and fate of materials in these systems. The goal of this work is to setup and validate a 3-dimensional hydrodynamic model of a WSP using Delft3D--a commonly applied Reynolds-averaged Navier-Stokes model to simulate the water levels, temperature stratification and current velocities. A secondary facultative pond near Amherstview, Ontario was used as a field study location. Observed results in this site show significant thermal stratification during the summer season.

## LITERATURE REVIEW

Wastewater stabilization ponds (WSP) have been studied significantly as a secondary or tertiary treatment option, focusing on disinfection, reducing turbidity, and nutrient load in an effluent stream (Gu & Stefan, 1995; Sah, Rousseau, & Hooijmans, 2012).

Although used in all regions, WSPs are particularly useful in rural and remote communities, owing to their lower maintenance, operation, and capital costs (Senzia, Mayo, Mbwette, Katima, & Jørgensen, 2002). When designed and operated correctly, WSPs are an effective tool for water treatment, reaching removal efficiencies for coliform of 99.99% and 100% removal of protozoan cysts and helminth eggs (MacDougall, 2017). WSPs can function as either aerobic, anaerobic, or facultative (combination) systems, employing several natural biologic processes found in bodies of water to self-purify. Notably, several species of bacteria, algae, and invertebrates act in tandem to fix nutrients such as phosphorus and nitrogen; as well as balance dissolved oxygen and pH (Spellman & Drinan, 2008). Specific to facultative WSPs, the interaction of

photosynthetic algae/ cyanobacteria and heterotrophic bacteria acts as a critical pathway for the removal of BOD and nutrients, as well as some pathogens (Sah et al., 2012).

Early WSP design guidelines focused on water volume with adjustments due to temperature such as Gloyna's equation in 1971. Hydraulic retention time was introduced later as a design parameter, under the assumption of a completely mixed system. In the 1990s, models were introduced accounting for geometry and assuming a combination of plug and completely mixed flow. (Aldana, Lloyd, Guganesharajah, & Bracho, 2005). The most recent design manual incorporates loading rate, short circuiting prevention, number of cells, and bathymetry; but remains a fundamentally empirical process (Spellman & Drinan, 2008). These techniques have not adequately modeled real world systems. Tracer studies have shown that hydraulic retention time can be 50% of nominally predicted values, due to short circuiting, unsteady flow rates, and sludge accumulation (Persson, 2000). Temperature differentials between the bottom and surface of WSPs of up to up to 8°C have also been observed (Gu & Stefan 1995).

Accurate hydrodynamics are critical for correct modeling of the biochemical processes responsible for treatment. The spatial variability of aerobic and anaerobic zones, temperature stratification, and flow speeds presents conditions that are not adequately captured through a plug flow reactor assumption. Moreover, variable inputs (such as environmental conditions and changing inflows) are not captured by empirical design formulas, but are included in hydrodynamic models (Sah et al., 2012).

Several hydrotechnical models have been proposed to describe WSPs; however, relatively few models have incorporated both biochemical processes and been accurately validated against real world performance (Sah et al., 2012). An early model (Gu & Stefan 1991) using the MINLAKE model adapted to account for WSPs specifically investigated the effect wind mixing had on stratification. After calibration, the model performed relatively well, but was only validated against temperature data. A later model using HYDRO-3D was completed in 2005 (Aldana et al. 2005). This study was unique in also validating against a physical model, as well as a full-scale pond.

A recent investigation simulated a complete WSP using Delft3D, a hydrodynamics and water quality modeling package (Sah et al. 2011). This model incorporated wind effects, and was three dimensional. Wind was used as a driver of the FLOW (hydrodynamics) module, and water quality was modeled. This model was not validated against observations, however, it showed considerable promise towards using Delft3D to model WSP systems.

## **METHODS**

Delft3D is an open source, coupled, three-dimensional, finite difference numerical modeling package for coastal and estuary environments (Deltares 2014). Delft3D is commonly used in both industry and academic settings thanks to its flexibility and open source code. Specific to WSP applications, Delft3D is coupled to an included water quality model (WAQ).

A Delft3D model was created incorporating water levels, wind, influent water and air temperature fluctuations, solar radiation. The model was based on three coupled grids, allowing the moderately complex geometry of the site to be included. Delft3D grids are regular and

orthogonal and implemented in this model at a resolution of 1 to 3 m<sup>2</sup>. The model was run using a 1.2 second time step to preserve hydrodynamic continuity.

The Delft3D model was validated against a secondary facultative WSP facility, receiving municipal wastewater after primary treatment was completed. During the summer, the WSP received approximately 30 L/s of inflow through an open discharge pipe at the north-west corner of the bed. A rubber baffle (visible in Figure 1 as a dashed line) separated the inflow and outflow sides of the site. Water flowed through 12 individual 1 m<sup>2</sup> holes in the west side of the grid, requiring the higher resolution grid in this area. Water flowed out on the south-west side via an open weir.

Field results were collected using a Hydrolab DataSonde in vertical profiles taken at 12 points, marked in Figure 1. Data was saved at 13 vertical depths for each location. Results were processed to interpolate temperatures along the flow path, as shown in Figure 1.

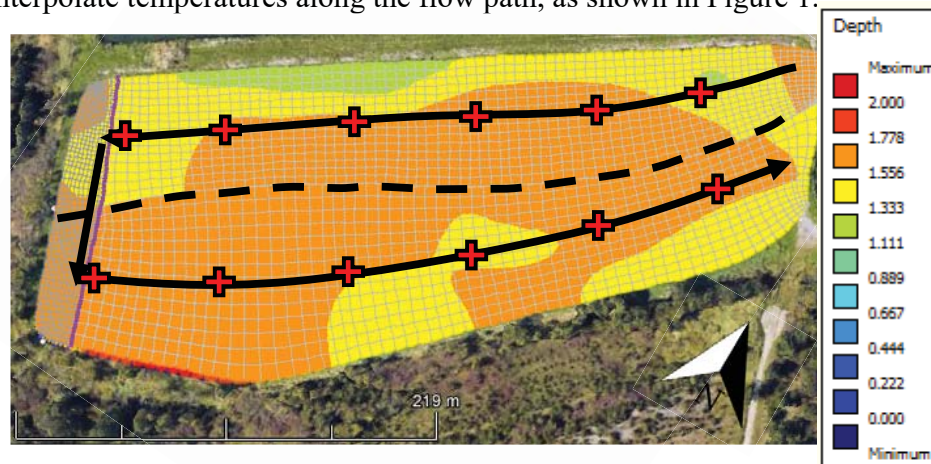


Figure 1. Site overview in Amherstview, Ontario, Canada with computational grid, flow path, sampling locations, and water depth

## RESULTS AND DISCUSSION

Figure 2 displays selected temperature profiles along the flow path taken on July 6 and July 13. Flow entered the WSP on the lower corner of the plot, and exited on the top right. Flow through the holes in the baffle occurs at 375 m. Results show stratification throughout the length of flow through the system, with temperature differentials of up to 5 degrees being observed.

These results suggest that perfectly mixed or plug flow models may not accurately capture the flows at play in WSP systems, consistent with previous investigations. Both plug flow and completely mixed assumptions predict more consistent conditions throughout the treatment length.



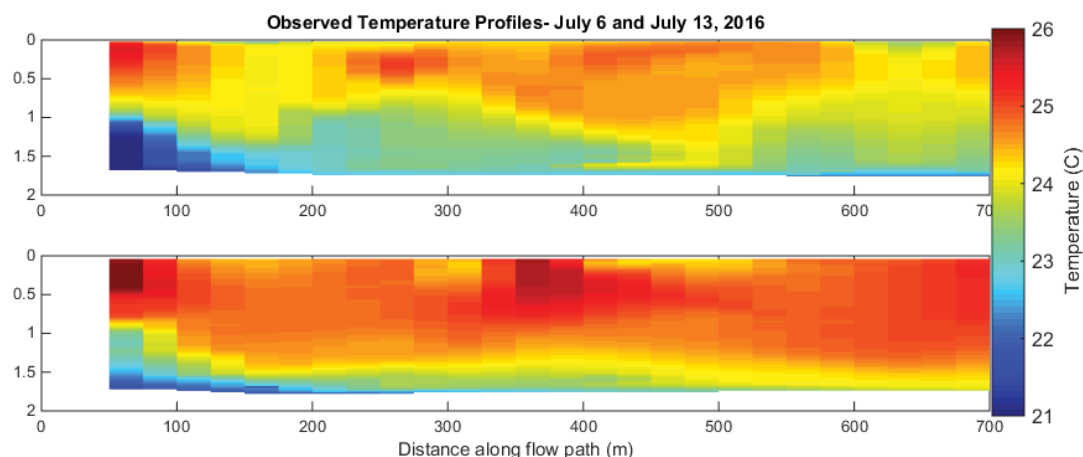


Figure 2. Observed temperature profiles

The results point towards the use of Delft3D to model these systems. As a full hydrodynamic model, Delft3D contains the required implementations to capture the complex processes at play in WSPs. Furthermore, the included water quality coupling module simplifies the process of including key environmental parameters in simulations, describing a complete hydrodynamic and biochemical picture.

## CONCLUSIONS

Wastewater stabilization ponds (WSPs) are a well-established treatment technique. Particularly well suited for use in rural or remote communities, WSPs have the capacity to effectively treat wastewater using natural and biological processes. Existing design guidelines for WSPs rely on empirical equations and either completely mixed or plug flow assumptions. Data collected from a WSP using vertical temperature profiles showed significant thermal stratification varying throughout the treatment path. These results support the use Delft3D as a hydrodynamic model to analyze WSPs, to account for the observed thermal stratification and accurately model biochemical treatment processes.

## REFERENCES

- Aldana, G. J., Lloyd, B. ., Gugesarajah, K., & Bracho, N. (2005). The development and calibration of a physical model to assist in optimising the hydraulic performance and design of maturation ponds. *Water Science and Technology*, 51(12), 173–181.
- Deltares. Delft3D-FLOW, User Manual.; 2014. [www.deltares.nl](http://www.deltares.nl).
- Gu, R., & Stefan, H. G. (1995). Stratification dynamics in wastewater stabilization ponds. *Water Research*, 29(8), 1909–1923. [https://doi.org/10.1016/0043-1354\(95\)00011-9](https://doi.org/10.1016/0043-1354(95)00011-9)
- MacDougall, A. (2017). *The effects of climate and humic substances on disinfection performance in Arctic wastewater stabilization ponds*. Queen's University, Kingston, Ontario, Canada. Retrieved from <http://hdl.handle.net/1974/15377>
- Persson, J. (2000). The hydraulic performance of ponds of various layouts. *Urban Water*, 2(3),

243–250. [https://doi.org/10.1016/s1462-0758\(00\)00059-5](https://doi.org/10.1016/s1462-0758(00)00059-5)

Sah, L., Rousseau, D., & Hooijmans, C. (2012). Numerical Modelling of Waste Stabilization Ponds: Where Do We Stand? *Water, Air, & Soil Pollution*, 223(6), 3155–3171.

<https://doi.org/10.1007/s11270-012-1098-4>

Sauder, M. Amherstview Waste Pollution Control Plant: Data Collection in Wastewater Stabilization Pond 2. Kingston, Ontario: N.p., 2016. Print.

Senzia, M. A., Mayo, A. W., Mbwette, T. S. A., Katima, J. H. Y., & Jørgensen, S. E. (2002). Modelling nitrogen transformation and removal in primary facultative ponds. *Ecological Modelling*, 154(3), 207–215. [https://doi.org/10.1016/S0304-3800\(02\)00018-2](https://doi.org/10.1016/S0304-3800(02)00018-2)

Spellman, F., & Drinan, J. (2008). *Wastewater Stabilization Ponds. Operation of Wastewater Treatment Plants* (1st ed.). Boca Raton, FL: CRC Press. <https://doi.org/10.1201/b16787>

# Correcting nutrient imbalance in hand washing water to permit recycling with a biologically activated membrane bioreactor (BAMBi)

C. Ziembra<sup>(a,b)</sup>, O. Larivé<sup>(a,c)</sup>, E. Reynaert<sup>(a,b)</sup>, and E. Morgenroth<sup>(a,b)</sup>

<sup>(a)</sup> Eawag: Swiss Federal Institute of Aquatic Science and Technology, 8600 Dübendorf, Switzerland

<sup>(b)</sup> ETH Zürich, Institute of Environmental Engineering, 8093 Zürich, Switzerland

<sup>(c)</sup> (current address) EPFL Lausanne, Environmental Chemistry Laboratory, 1015 Lausanne, Switzerland

**Keywords:** Greywater; nitrogen; micro-nutrients

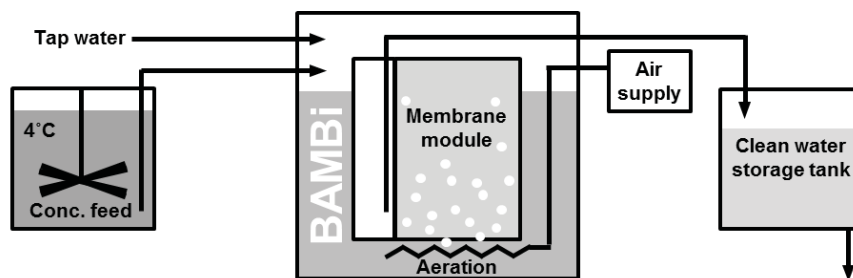
## Introduction

A small-scale decentralized system, that can recycle hand washing water, offers tremendous value both in the developed and developing world. Biologically activated membrane bioreactors (BAMBi) are a promising treatment solution. Biological systems however, require a balance of components, and this balance may not be correct in hand washing water. Supplementing nutrients can be an effective strategy to improve treatment (Jefferson et al. 2001).

To better understand how nutrient-balancing impacts hand washing water treatment in BAMBi, we estimated both the nutrient content of hand washing water and the nutrients necessary for balanced biological treatment. A synthetic hand washing water recipe was developed to mimic real inputs to hand washing water, supplemented with nutrients and evaluated in the full-scale BAMBi. This treatment was highly-effective, with over 95% removal of the organic carbon and 90% removal of nitrogen. Additional testing is being conducted with water that is not nutrient-balanced to investigate reductions in performance.

## Material and Methods

A BAMBi has been constructed using a 52-L plastic tank and a 150 kDa ultrafiltration membrane module (Microdyn). The BAMBi is fed a concentrated greywater solution (stored at 4°C, mixed at 10 RPM) at a rate of 3.75 L/day, plus 61.25 L/day tap water, and aerated at a rate of 20 L/min.



**Figure 1.** Process schematic for a BAMBi hand washing water recycling system. All water is transported using laboratory pumps. Concentrated feed is mixed at 10 RMP.

## Results and Conclusions

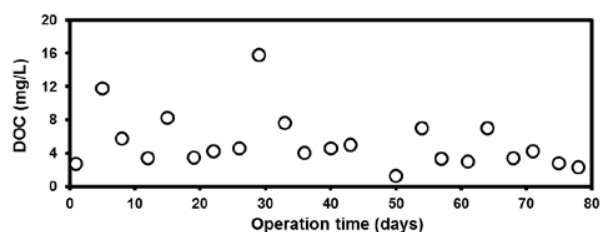
A representative hand washing water composition is presented in the first data column of Table 1a (Surendran and Wheatley 1998, Jefferson et al. 2004). The second data column of Table 1a presents an estimate of the nutrient requirements for bacterial growth (Egli 2015). Table 1 third data column presents the nutrient requirements we expect the bacteria will need to treat the carbon in real hand washing water based on the ratio in the second data column. The nutrients marked with boxes are the nutrients that we expect to be deficient.

Contributions to hand washing water from dirt, skin, body oils and the components of soap have been compiled from emission estimates, monitored hand washing studies and commercial

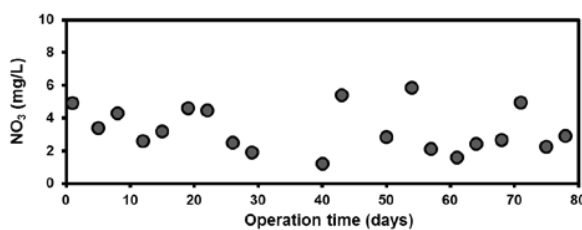
a) Component	Concentration expected in real hand washing water (mg/L)	Ratio of component to carbon in biomass (g/g)	Target concentrations to balance to carbon (mg/L)	b) Chemical	Mass per 25L of 20X concentrate (g)
C	130	1	130	SDS	105
N	13	0.24	31	Glycerol	37.5
PO <sub>4</sub>	0.53	0.18	24	Lactic acid	0.55
S	21	0.02	2.6	Humic acid	1.28
Ca	63	0.02	2.6	Kaolin	11.5
K	7.6	0.02	2.6	NH <sub>4</sub> Cl	19.9
Fe	0.02	0.01	1.3	NaNO <sub>3</sub>	63.1
Mg	6.9	0.01	1.3	HNa <sub>2</sub> PO <sub>4</sub> ·2H <sub>2</sub> O	22.4
Mn	0.05	4.2 × 10 <sup>-9</sup>	5.5 × 10 <sup>-3</sup>	Na <sub>2</sub> SO <sub>4</sub>	5.76
Cu	8 × 10 <sup>-3</sup>	6.7 × 10 <sup>-5</sup>	8.7 × 10 <sup>-3</sup>	KCl	2.48
Al	4 × 10 <sup>-3</sup>	4.7 × 10 <sup>-5</sup>	6.1 × 10 <sup>-3</sup>	Cl <sub>2</sub> Fe·4H <sub>2</sub> O	2.21
Zn	0.04	1.6 × 10 <sup>-9</sup>	0.02	Cl <sub>2</sub> Mn·4H <sub>2</sub> O	0.01
Mo	0	5.3 × 10 <sup>-5</sup>	6.9 × 10 <sup>-3</sup>	Cl <sub>2</sub> Co·6H <sub>2</sub> O	0.001
Co	0	5.3 × 10 <sup>-5</sup>	6.9 × 10 <sup>-3</sup>	NaCl	48.7

**Table 1.** a) Nutrients and concentrations expected to be found in representative hand washing water and the concentrations estimated to be required for biological treatment. The nutrients shaded boxes need to be supplemented to achieve nutrient-balance. b) components added to the concentrated greywater mix.

soap recipes. Table 1b reflects this synthetic hand washing recipe designed to reflect the sources and compositions of inputs, supplemented with the nutrients in which we expect it to be deficient. The concentration of NaCl has been increased to enable future electrolysis post-treatment testing.



**Figure 2.** DOC of BAMBi permeate over 80 days.



**Figure 3.** NO<sub>3</sub> of BAMBi permeate over 80 days.

This nutrient-balanced synthetic hand washing water was then tested in a household-scale BAMBi over 80 days. The concentrations of DOC and total nitrogen in the feed water were 130 mg/L and 31 mg/L respectively, 10 mg/L as ammonia. The membrane permeate displayed DOC (Figure 2) averages of 4.8±3.2 mg/L (standard deviation), ammonia generally at or close to the quantification level of 0.2 mg/L and nitrate (Figure 3) averages of 3.5±1.5 mg/L, reflecting approximately 95% DOC removal, complete nitrification and 90% removal of total nitrogen. Additional testing is currently being conducted to evaluate the performance of BAMBi when the hand washing water is not nutrient-balanced. In conclusion this project presents a valuable recipe for synthetic hand washing water, presents a nutrient supplement to compliment this water and then demonstrates how nutrient-balanced water can be effectively treated in a BAMBi system.

## References

- Egli, T. (2015). "Microbial growth and physiology: A call for better craftsmanship." *Frontiers in Microbiology* 6(MAR).
- Jefferson, B., J. E. Burgess, A. Pichon, J. Harkness and S. J. Judd (2001). "Nutrient addition to enhance biological treatment of greywater." *Water Research* 35(11): 2702-2710.
- Jefferson, B., A. Palmer, P. Jeffrey, R. Stuetz and S. Judd (2004). Grey water characterisation and its impact on the selection and operation of technologies for urban reuse. *Water Science and Technology*. 50: 157-164.
- Surendran, S. and A. D. Wheatley (1998). "Grey-water reclamation for non-potable re-use." *Journal of the Chartered Institution of Water and Environmental Management* 12(6): 406-413.

# Economic and Environmental Analysis of the New Resource Toilet with Forward Osmosis Technology

Ref # S2SMALL-42760

Yilei SHI<sup>1</sup>, Lu ZHOU<sup>1\*</sup>, Yangyu XU<sup>1</sup>, Hongjie ZHOU<sup>1</sup>, Lei SHI<sup>1</sup>

<sup>1</sup> School of Environment, Tsinghua University, Haidian District, Beijing 100084, PR China

\* Corresponding Author: zhoul@tsinghua.edu.cn

**Abstract:** Two new resource toilet systems with forward osmosis technology were designed in this study in contrast to traditional public toilet system (Scenario A). One was partial resource recovery toilet system (Scenario B) concentrating yellow water to produce liquid fertilizer and another was complete resource recovery toilet system (Scenario C) treating both brown water and yellow water. The methodology of cost-benefit analysis and Life Cycle Assessment were applied to analyze the economic and environmental benefit of these systems and to evaluate the feasibility of extension in the future. As results indicated, Scenario B proved to have the most economic benefit and lowest environmental impact, when compared with Scenario A and Scenario C, while the largest limitation of Scenario B and C came from the cost of construction and the consumption of electricity. The result also confirmed the potential of new resource toilet, especially Scenario B, as a better choice when constructing toilets.

**Keywords:** toilet; resource recovery; forward osmosis; cost-benefit analysis; Life Cycle Assessment

## INTRODUCTION

The discharge of black water from the toilet which includes human excrement and flush water will not only cause the waste of nitrogen, phosphorus and other nutrients, but also increase the amount and difficulties of the sewage treatment. Averagely, an adult produces 1.5 kg urine and 0.14 kg feces per day, containing 11.5 g nitrogen, 1.5 g phosphorus and 3.15 g potassium, and of which about 88% of the nitrogen, 67% of the phosphorus and 73% of the potassium are contained in the urine (Benetto et al. 2009; Karak & Bhattacharyya 2011). Traditional black water treatment and re-utilization methods have five processes, including collection, storage, transportation, treatment and re-utilization (in a specific system, some processes could be omitted). However, the high cost of construction and operation, the security risks and other issues limit the promotion of the traditional way in rural areas. In addition, the nitrogen, phosphorus and potassium removed from the wastewater by using a lot of material and energy are basic nutrients which can be reused in agriculture and forestry. Therefore, how to recover nutrients from black water, improving social, environmental and economic benefits with low investment and operating costs has become a focus of current technology research (Etter et al. 2011).

As a sustainable membrane technology, forward osmosis (FO) has a significant advantage in the concentration of nutrient-rich wastewater. FO membrane has a draw solution side running a high concentration solution and a feed solution side running the target solution that needs to be concentrated. In the concentration process, water diffuses from the feed solution into a draw solution through a dense, semipermeable FO membrane and the osmotic pressure is the driving force of water transport (Hancock N. T. et al. 2011; Lutchmiah K. et al. 2014). The main advantages of FO membrane technology in comparison with other membrane technology such as reverse osmosis (RO), electrodialysis (ED) etc. are: a) no need for external pressure and low membrane strength requirement, b) low fouling propensity and quick recovery when polluted, c) high rejection to the ions (Cath et al. 2006). Based on the advantages of the FO, it enables concentration of a range of challenging, nutrient-rich

streams, achieving high enrichment factors for streams (Xie et al. 2016). It can be used for the concentration of source-separated urine (yellow water) as well and the concentrated urine can be used as liquid fertilizer for agriculture and forestry. Thus, the aim of sewage treatment and nutrients recovery will be both achieved. At present, a number of research work and institutions have involved in this field. The FO membrane produced by HTI company was used to concentrate the synthetic urine in a laboratory-scale (Zhang et al. 2014). The result indicates that the rejection rate of organic nitrogen (urea) can only reach 20-50%, but the rejection rate of ammonia that is generated from the hydrolysis of the urea can reach 50-80%, and the rejection rate of phosphorus and potassium can reach more than 90%. National Aeronautics and Space Administration (NASA) use a two-stage FO infiltration system to treat urine and recycle water, and the rejection rate can reach more than 95%, and the recovery of water can reach 98% (Cath et al. 2005a, b). At the same time, there are also a number of research work focusing on the benefit of new toilet system from economic and environment perspective. Ishii & Boyer (Ishii S. K. & Boyer T. H. 2015) used Life Cycle Assessment (LCA) and the method of adding select economic impacts to compare urine source separation with struvite precipitation and centralized wastewater treatment. The result shows that the economic impacts is close (<13% difference) while the urine source separation with MgO addition for high P recovery has a significant environmental benefit. Gao (Gao et al. in press) compared the economic and environmental benefit of five Chinese rural toilet technologies with the method of input-output and LCA, resulting in collocation suggestions between actual situations and technologies.

In view of the fact that there are few practical engineering application examples of the FO membrane technology, it is worthy to set up a pilot-scale resource toilet with FO membrane technology to study the design methods and application effects. Therefore, a pilot-scale resource toilet serving 500 persons each day was built in the northwest corner of the playground of Tsinghua University Primary School in October 2015 by our research group (Xu et al. in press). However, besides the application effects, inspired by above research work, it is necessary to evaluate the economic and environment benefits comprehensively for possible extension and construction in the future.

## **METHODS**

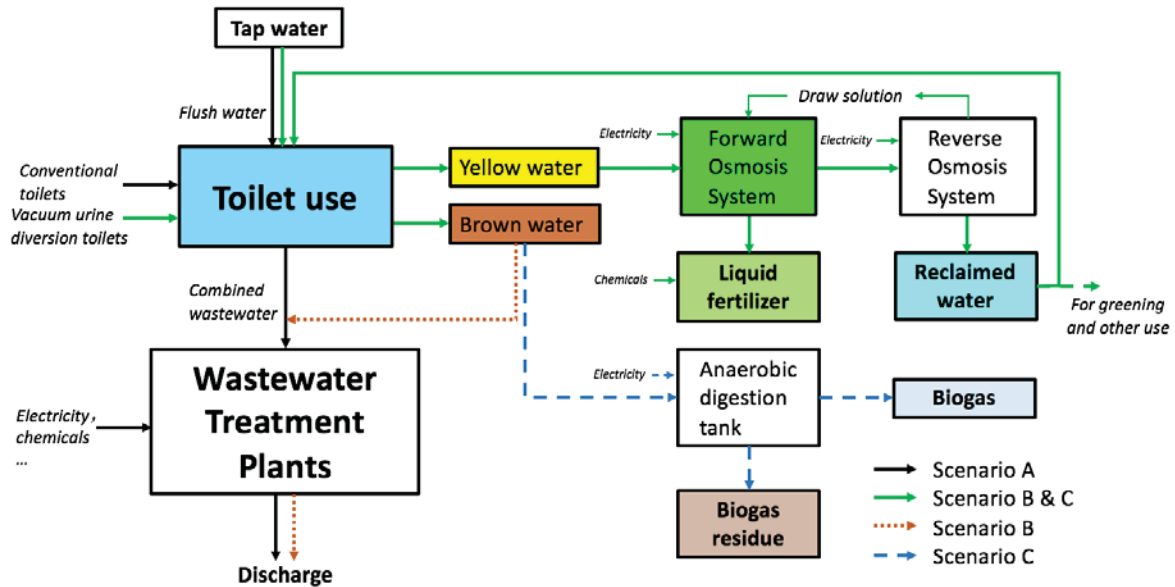
Considering the differences of the supply and drainage infrastructure conditions in different regions, two scenarios were designed in this study (Figure1), one is partial resource recovery toilet system concentrating yellow water to produce liquid fertilizer and another is complete resource recovery toilet system treating both brown water and yellow water.

Scenario A: the traditional public toilet system, relying on tap water for flushing and discharging the sewage into the municipal drainage pipe network and getting treated in wastewater treatment plants; Scenario B: the partial resource recovery toilet system, using source-separated toilet to collect urine (yellow water) and feces (brown water) separately, obtaining liquid fertilizer from concentrating yellow water by FO system, reclaiming flushing water from draw solution recycling by RO system, and discharging brown water into the sewer; Scenario C: the complete resource recovery toilet system, on the basis of Scenario B, treating brown water with anaerobic digestion in order to achieve the complete resource recovery and it can also be separated from the municipal water supply and drainage system when concentrate a part of brown water to produce enough flush water, ending in an independent closed circuit.

In this study, Cost-Benefit Analysis and Life Cycle Assessment (LCA) will be used to evaluate the advantages and disadvantages of three kinds of toilet system scenarios



respectively, based on the performance and test data of the pilot-scale resource toilet system in preliminary research.



**Figure 1.** Simplified schematic of three scenarios; both FO and RO membrane have a high rejection rate of trace organic compounds (TOCs), making sure the safety of using reclaimed water to flush (Hancock N. T. et al. 2011).

### Cost-Benefit Analysis

The economic net present value (ENPV) is an absolute indicator of the net contribution of the project to the national economy (Gao et al. in press). It is calculated by the following equation:

$$ENPV = \sum_{t=1}^n C_t / (1 + i)^t \quad (1)$$

Where  $n$  is the periods (years);  $C_t$  is the difference between the total benefit and the total cost in  $t$  years (104 CNY);  $i$  is social discount rate (%), and according to the document of National Development and Reform Commission and Ministry of Housing and Urban-Rural Development of the People's Republic of China, social discount rate of long-term environmental protection project should be less than 8%, thus  $i$  equals 8% in this study.

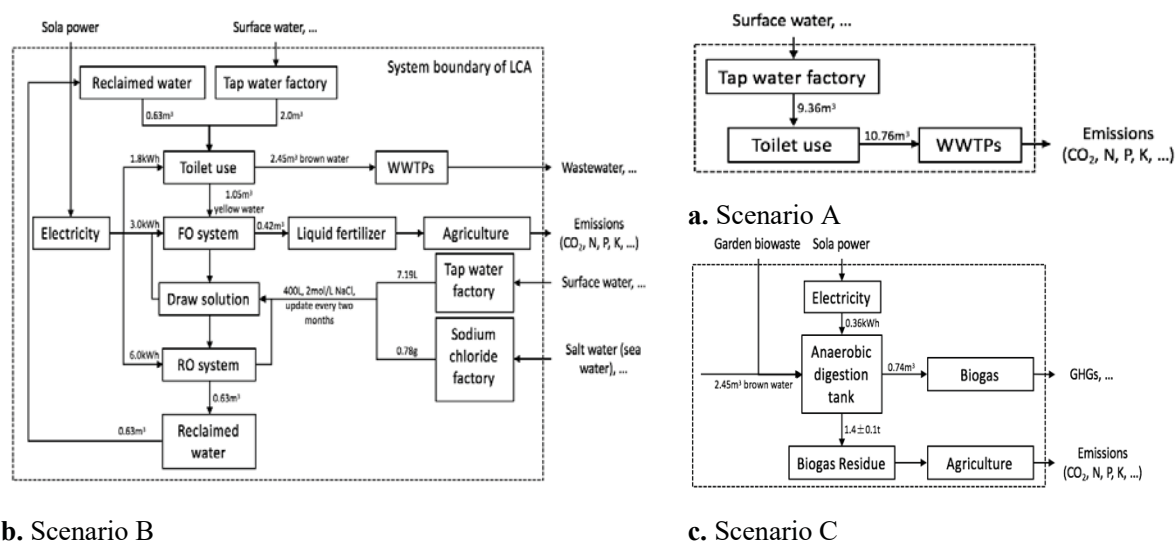
According to the ENPV calculation result, the project is feasible in economy when its result is greater than or equal to zero, while the project with a higher calculation result is better when comparing two projects (Del B. C. & Florio M. 2010). Assumption was made that a 50 m<sup>2</sup> toilet, equipped with 6 closet pans for the female and 2 closet pans and 2 urinals for the male would be built in a park or scenic spot, producing 1.05 m<sup>3</sup> urine and 0.35 m<sup>3</sup> feces per day when analyzing the cost and benefit of the three toilet systems.

### Life Cycle Assessment

Life Cycle Assessment (LCA) is the compilation and evaluation of the inputs, outputs, and the potential environmental impact of a product system throughout its life cycle (ISO 14040 2006), and can be applied to systematically characterize the environmental impact of the operation and construction of sanitation systems (Remy & Jekel 2012).

In this study, all processes for black water (or yellow water and brown water in Scenario B and C) collection and treatment are built in spreadsheet format and described in a substance

flow model using the LCA software Gabi. The considered functional unit of the LCA is the treatment of 1.05 m<sup>3</sup> urine and 0.35 m<sup>3</sup> feces; the boundaries (Figure 2) include flushing in toilet use and treatment in WWTPs (Scenario A) or concentration and anaerobic digestion with FO system, RO system and anaerobic digestion tank (Scenario B and C). The key objective of this part is to compare new resource toilet with traditional toilet from environment perspective and figure out the obstacles and limitations of the new resource toilet which should receive specific research efforts to make it environmentally sustainable in next stage.



b. Scenario B

a. Scenario A

c. Scenario C

**Figure 2.** System boundaries of three scenarios; a-Scenario A, b-Scenario B, c-Scenario C (replace WWTPs in b with the flow chains in c; garden biowaste can be added if needed).

## RESULTS AND DISCUSSION

### Resource recovery

In the actual operation of the toilet, the concentration factor of yellow water is 2.5. The reclaimed water can meet the consumption demand of the toilet flushing water, and the feces can be treated to meet the standard of Sanitary standard for the non-hazardous treatment of night soil (Ministry of Health of China 2012). The general operation aspects are shown in Table 1.

**Table 1.** The overall performance of the toilet system.

Items	Parameter	Before concentration	After concentration
Urine	Volume (m <sup>3</sup> )	1.05 average	0.42 average
	pH	9.1-9.3	9.1-9.3
	TP (g/L)	2.11	4.14
	TN (g/L)	2.46	3.16
	NH <sub>3</sub> -N (g/L)	1.63	1.78
	COD <sub>Cr</sub> (g/L)	4.03	6.96
	K (g/L)	0.58	0.97
	N+P+K (g/L)	5±1	10±2
Reclaimed water	Volume (m <sup>3</sup> )		0.63 average
	TDS (mg/L)		900±100

### Economic Benefits

To compare the economic benefits of three different toilet systems, the cost-benefit flows of these systems are analyzed in following tables.

**Table 2.** Cost-benefit flows of three toilet systems.

Items	Scenario A	Scenario B	Scenario C
<b>Cost (10<sup>4</sup> CNY)<sup>a</sup></b>			
Civil building and decoration cost <sup>b</sup>	13.50	24.30	27.00
Pipes cost <sup>c</sup>	0.47	0.41	0.41
Equipment cost <sup>d</sup>	0.92	34.47	38.47
Annual tap water and sewage treatment cost <sup>e</sup>	2.05	0.56	0.44
Annual operational cost <sup>f</sup>	1.20	3.16	3.36
Annual material cost <sup>g</sup>	0.00	0.40	0.40
Annual depreciation cost <sup>h</sup>	0.00	1.72	1.92
<b>Benefit (10<sup>4</sup> CNY)</b>			
Annual liquid fertilizer benefit <sup>i</sup>	0.00	17.25	17.25
Annual biogas benefit <sup>j</sup>	0.00	0.00	0.02
Annual biogas residue benefit <sup>k</sup>	0.00	0.00	0.00

<sup>a</sup> The currency exchange rate in *Bank of China* at July 13, 2017: 1 CNY= 0.1474 USD= 0.1293 EUR.

<sup>b</sup> Civil building and decoration cost will be influenced by different area and terrain, and ranges from 12 to 15\*10<sup>4</sup> CNY, and the average cost is 13.5\*10<sup>4</sup> CNY. Scenario B needs an additional 40 m<sup>2</sup> equipment room and Scenario C needs 50 m<sup>2</sup> equipment room.

<sup>c</sup> Scenario A needs stainless steel pipes to connect with municipal pipe system.

<sup>d</sup> Scenario B and C need special vacuum urine diversion toilets, vacuum station (source-separation system has a significant effect in saving water and energy (Remy & Jekel 2012)), FO system, RO system and solar power generation systems. Besides, Scenario C need one more group of solar power generation system and an additional 1.5 m<sup>3</sup> anaerobic digestion tank.

<sup>e</sup> Scenario B and C do not need tap water to flush as designed, but in actual operation, it need to concentrate a part of brown water to cover flush water with reclaimed water, but it will cause clogging and decrease the quality of the reclaimed water, thus, 2 m<sup>3</sup> tap water is provided to solve this problem each day.

<sup>f</sup> Operational cost includes a 1,200 CNY per month expenditure for labor, training and a 172,000 CNY per year (5% of the equipment cost) expenditure for maintenance.

<sup>g</sup> Material refers to fertilizer additives, disinfectants, yellow water stabilization agents and membrane pollution control agents.

<sup>h</sup> Depreciation cost is calculated with the accounting method of annualized average discount amount, and the period is 20 years.

<sup>i</sup> Liquid fertilizer daily production is 0.42 m<sup>3</sup> from 1.05 m<sup>3</sup> yellow water with a concentration factor of 2.5.

<sup>j</sup> Biogas production rate is 0.3 m<sup>3</sup>/m<sup>3</sup>.

<sup>k</sup> The nutrient content of N, P and other nutrients contained in the feces collected by the source-separation is low and the biogas residue produced by anaerobic digestion do not have the feasibility of selling.

Furthermore, since some of the external benefits have little or no influence on the results of the calculation, the cost-benefit flows in Table 2 do not fully calculate all indirect benefit, such as benefit of reducing urban water supply and wastewater treatment facilities construction costs, reducing environmental degradation costs caused by water pollution, improvement of global atmospheric environment resulting from water conservation, improvement of local eco-environmental quality by reducing pollutant emissions and so on.

Calculate the ENPV with equation (1) to compare the economic benefits of three scenarios, and the results is shown in Table 3.

**Table 3.** The ENPV results of three scenarios. <sup>a</sup>

Systems	ENPV (10 <sup>4</sup> CNY)
Scenario A	-46.80

Scenario B	52.85
Scenario C	43.86

<sup>a</sup> during 20 years operating period

Table 3 indicates that Scenario A is not feasible from economic perspective and its ENPV result is negative because of using a large number of tap water for flushing. In contrast to Scenario A, although a great investment is needed in construction and equipment (Table 2), the new resource toilet is feasible and both Scenario B and C have positive ENPV results because of the application of FO technology and RO technology to concentrate yellow water, obtaining reclaimed flushing water and liquid fertilizer which results in additional economic benefits. Moreover, in view of the necessity to build more resource recovery facilities and equipment in Scenario C, Scenario B which simply recover nutrients in the urine is more feasible from economic perspective.

### Environmental impact

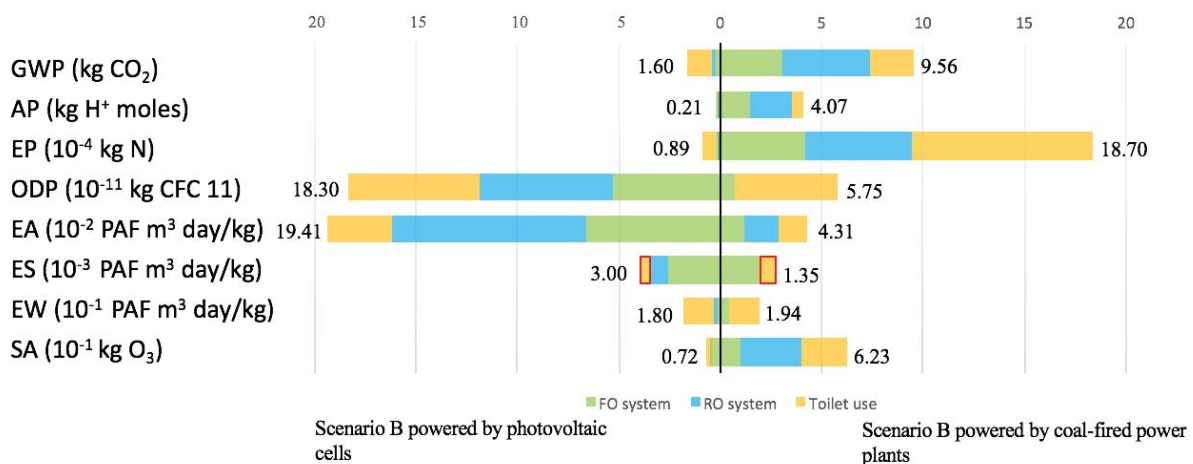
Figure 3 provides an overall comparison between Scenario A, B and C. Scenario B and C have a cheaper environmental cost but the soil pollution is more serious because of the use of liquid fertilizer and biogas residue production while Scenario A treat black water in WWTPs and discharge into surface water achieving a positive environmental impact in ecotoxicity air and soil aspects. However, when it comes to global warming air, acidification air, eutrophication, ozone depletion air, air and water pollution, Scenario B and C have the significant environmental benefit in contrast to Scenario A. The reason is that water and nutrients can be reclaimed and recovered through FO and RO system. Besides, there are little differences between Scenario B and C as Figure 3 shows, indicating that using anaerobic digestion to treat brown water does not have a great environmental benefit. But if Scenario C concentrated a part of brown water to maintain the balance between reclaimed water and flushing water to separate municipal water supply and drainage system completely, the environmental impact would be high.



**Figure 3.** Environmental impact of each scenario; *GWP*-global warming air, *AP*-acidification air, *EP*-eutrophication, *ODP*-ozone depletion air, *EA*-ecotoxicity air, *ES*-ecotoxicity soil, *EW*-ecotoxicity water, *HA*-human health cancer air, *HS*-human health cancer soil, *HW*-human health cancer water, *HCA*-human health criteria air, *HNA*-human health non cancer air, *HNS*-human health non cancer soil, *HNW*-human health non cancer water, *SA*-smog air.

In Figure 4, Scenario B has been broken down into its operating parts. The toilet use contributes the largest environmental cost in the aspects of global warming air, eutrophication, ozone depletion air and ecotoxicity water. That is mainly because the use of tap water which need a lot of chemicals such as Polyacrylamide (PAM), chlorine dioxide and etc. in its production process. FO and RO system, by contrast, has little environmental impact in global warming, eutrophication and ecotoxicity water but a great environmental impact in ozone depletion, ecotoxicity air and soil, and smog. Being powered by photovoltaic cell makes a great contribution to this results. Using sodium chloride solution as draw solution brings a few of environmental cost in FO process.

If the electricity of all system in Scenario B was supplied by coal-fired power plants, the result would be different, as Figure 4 shows. It is also a sensitivity analysis where energy consumption has been selected to evaluate the influence on the resulting environmental impact for Scenario B. It suggests that FO system and RO system contribute the largest environmental cost because of the electricity consumption. The reason of high energy consumption, at present, is the low flux rate of the membrane in FO and RO process. However, toilet use still has a high impact to ozone depletion and water pollution because of the use of tap water which has a chlorination process.



**Figure 4.** Environmental impact of each operation parts of Scenario B in different electricity supply modes; *the highlights in ES with a red frame are negative values referring to positive environmental impacts.*

## CONCLUSIONS

In this study, Scenario B (the partial resource recovery toilet system) proved to have the most economic benefit and lowest environmental impact, when compared with Scenario A (the traditional public toilet system) and Scenario C (the complete resource recovery toilet system). The conclusions are summarized as follows:

- 1) From economic perspective, Scenario B and C is more feasible than Scenario A. Scenario B is a better choice for areas where drainage facilities are available when constructing toilets, while Scenario C could be applied in areas without drainage facilities if needed.
- 2) From environment perspective, Scenario B and C, powered by photovoltaic cells have a lower environmental impact than Scenario A. Otherwise, the consumption of electricity will also result in a great environmental cost when they are powered by coal-fired power plants.
- 3) The largest limitation of Scenario B and C comes from the cost of construction and the consumption of electricity. Thus, how to increase the flux rate and the efficiency of FO system is one of the emphases for future research. The cost will reduce with the extension of

construction scale, the standardization of the equipment and the further innovations of the technology accordingly.

## ACKNOWLEDGEMENT

The authors would like to acknowledge the *Bill & Melinda Gates Foundation* for funding this study.

## REFERENCES

- Benetto E., Nguyen D., Lohmann T., Schmitt B. & Schosseler P. 2009 Life cycle assessment of ecological sanitation system for small-scale wastewater treatment. *Sci Total Environ*, **407**(5), 1506-1516. doi: 10.1016/j.scitotenv.2008.11.016
- Cath T., Childress A. & Elimelech M. 2006 Forward osmosis: Principles, applications, and recent developments. *Journal of Membrane Science*, **281**(1-2), 70-87. doi: 10.1016/j.memsci.2006.05.048
- Cath T. Y., Adams D. & Childress A. E. 2005 Membrane contactor processes for wastewater reclamation in space. *Journal of Membrane Science*, **257**(1-2), 111-119. doi: 10.1016/j.memsci.2004.07.039
- Cath T. Y., Gormly S., Beaudry E. G., Flynn M. T., Adams V. D. & Childress A. E. 2005 Membrane contactor processes for wastewater reclamation in space. *Journal of Membrane Science*, **257**(1-2), 85-98. doi: 10.1016/j.memsci.2004.08.039
- Del B. C. & Florio M. 2010 Cost-Benefit Analysis and the Rates of Return of Infrastructure Projects: Evidence from International Organizations. *Transition Studies Review*, **17**(3), 587-610. doi: 10.1007 / s11300-010-0162-2
- Etter B., Tilley E., Khadka R. & Udert K. M. 2011 Low-cost struvite production using source-separated urine in Nepal. *Water Res*, **45**(2), 852-862. doi: 10.1016/j.watres.2010.10.007
- Gao H., Zhou C., Li F., Han B. & Li X. 2015 Economic and environmental analysis of five Chinese rural toilet technologies based on the economic input–output life cycle assessment. *Journal of Cleaner Production*. doi: 10.1016/j.jclepro.2015.12.089
- Hancock N. T., Xu P., Heil D. M., Bellona C. & Cath T. Y. 2011 Comprehensive bench- and pilot-scale investigation of trace organic compounds rejection by forward osmosis. *Environ Sci Technol*, **45**(19), 8483-8490. doi: 10.1021/es201654k
- Ishii S. K. & Boyer T. H. 2015 Life cycle comparison of centralized wastewater treatment and urine source separation with struvite precipitation: Focus on urine nutrient management. *Water Res*, **79**(2015), 88-103. doi: 10.1016/j.watres.2015.04.010
- ISO 14040. 2006 *Environmental Management - Life Cycle Assessment – Principles and Framework*. International Standardization Organization, Geneva, Switzerland.
- Karak T. & Bhattacharyya P. 2011 Human urine as a source of alternative natural fertilizer in agriculture: A flight of fancy or an achievable reality. *Resources, Conservation and Recycling*, **55**(4), 400-408. doi: 10.1016/j.resconrec.2010.12.008
- Lutchmiah K., Verlied A. R., Roest K., Rietveld L. C. & Cornelissen E. R. 2014 Forward osmosis for application in wastewater treatment: a review. *Water Res*, **58**(2014), 179-197. doi: 10.1016/j.watres.2014.03.045
- Remy C. & Jekel M. 2012 Energy analysis of conventional and source-separation systems for urban wastewater management using Life Cycle Assessment. *Water Sci Technol*, **65**(1), 22-29. doi: 10.2166/wst.2011.766
- Sanitary standard for the non-hazardous treatment of night soil GB7959-2012*, Ministry of Health of the People's Republic of China, Beijing, China.



Xie M., Shon H. K., Gray S. R. & Elimelech M. 2016 Membrane-based processes for wastewater nutrient recovery: Technology, challenges, and future direction. *Water Res*, **89**(2016), 210-221. doi: 10.1016/j.watres.2015.11.045

XU Y., ZHOU L. & JIA Q. 2017 Nutrients recovery of source separated urine via forward osmosis and a pilot scale resource-oriented sanitation system. *Desalination and Water Treatment*.

Zhang J., She Q., Chang V. W., Tang C. Y. & Webster R. D. 2014 Mining nutrients (N, K, P) from urban source-separated urine by forward osmosis dewatering. *Environ Sci Technol*, **48**(6), 3386-3394. doi: 10.1021/es405266d

### **Reviewers comments:**

Add more results in the abstract.

### **Replication:**

The abstract has been extended to this full paper. **Here are the abstract and conclusions:**

**Abstract:** Two new resource toilet systems with forward osmosis technology were designed in this study in contrast to traditional public toilet system (Scenario A). One was partial resource recovery toilet system (Scenario B) concentrating yellow water to produce liquid fertilizer and another was complete resource recovery toilet system (Scenario C) treating both brown water and yellow water. The methodology of cost-benefit analysis and Life Cycle Assessment were applied to analyze the economic and environmental benefit of these systems and to evaluate the feasibility of extension in the future. As results indicated, Scenario B proved to have the most economic benefit and lowest environmental impact, when compared with Scenario A and Scenario C, while the largest limitation of Scenario B and C came from the cost of construction and the consumption of electricity. The result also confirmed the potential of new resource toilet, especially Scenario B, as a better choice when constructing toilets.

### **Conclusions**

In this study, Scenario B (the partial resource recovery toilet system) proved to have the most economic benefit and lowest environmental impact, when compared with Scenario A (the traditional public toilet system) and Scenario C (the complete resource recovery toilet system). The conclusions are summarized as follows:

- 1) From economic perspective, Scenario B and C is more feasible than Scenario A. Scenario B is a better choice for areas where drainage facilities are available when constructing toilets, while Scenario C could be applied in areas without drainage facilities if needed.
- 2) From environment perspective, Scenario B and C, powered by photovoltaic cells have a lower environmental impact than Scenario A. Otherwise, the consumption of electricity will also result in a great environmental cost when they are powered by coal-fired power plants.
- 3) The largest limitation of Scenario B and C comes from the cost of construction and the consumption of electricity. Thus, how to increase the flux rate and the efficiency of FO system is one of the emphases for future research. The cost will reduce with the extension of construction scale, the standardization of the equipment and the further innovations of the technology accordingly.

# Innovative and easy-handling membrane-based water treatment system for decentralized applications

Ordóñez Andrade, Jose Abdón<sup>(a)\*</sup>; Frechen Franz-Bernd<sup>(a)\*</sup>;

<sup>(a)</sup> University of Kassel, Department of Sanitary & Environmental Engineering (DESEE), Kassel, Germany <sup>(a)</sup> [jose.ordonez@ordonez.de](mailto:jose.ordonez@ordonez.de); <sup>(b)</sup> [frechen@uni-kassel.de](mailto:frechen@uni-kassel.de)

## Summary

The following paper shows how biofiltration can be an effective pre-treatment option to reduce membrane fouling and increase performance on gravity-driven ultrafiltration, i.e., ULP-UF.

## Keywords

Ultra-Low-Pressure Ultrafiltration Process (ULP-UF); natural organic matter (NOM), Biopolymers, Liquid chromatography-organic carbon detection (LC-OCD)

## Introduction

The ULP-UF aims to be a suitable and feasible solution to be used on decentralized drinking water treatment plants in remote and rural areas worldwide, since it is easy of handle and requires no chemicals and energy consumption during its operation.

ULP-UF may face some problems regarding the quality of the raw water; especially those related to increasing membrane fouling or re-growth of bacteria on permeate water. In addition, ULP-UF faces operational and maintenance problems when treating water with high content of NOM, especially Biopolymer and Humic Acids<sup>[1][2]</sup>.

Pretreatments for ULP-UF in lab scale have been already proposed<sup>[3][4]</sup>. However, a suitable and affordable pre-treatment method to integrate higher removal of contaminants, lower rate of losing permeability, and lower cost of the whole treatment process is still a challenge<sup>[5][6]</sup>.

Biofiltration can be an effective pre-treatment for the removal of NOM components that cause membrane fouling, especially organic colloidal material such as biopolymers (polysaccharides, protein and amino sugars)<sup>[7][8]</sup>.

## Materials and Methods

Two pilot plants based on ULP-UF process were put into operation at the University of Kassel and by using modified raw water from a River. Pilot plant 1 consisted on a PAUL filter, which is a very simple, robust and small gravity-driven membrane unit (ULP-UF) without any pre-treatment step. Pilot plant 2 comprised an Up-flow Gravel Filter (UGF) and Slow Sand Filter (SSF) as pretreatment of a ULP-UF. Both pilot plants used an UF module, PES material and MWCO of 150 kDa. NOM components were separated and quantified by Liquid chromatography-organic carbon detection (LC-OCD).

## Results

Figure 1 shows that UGF-SSF together is an effective pretreatment process for the reduction of biopolymers and thus decreasing of operational maintenance in ULP-UF.

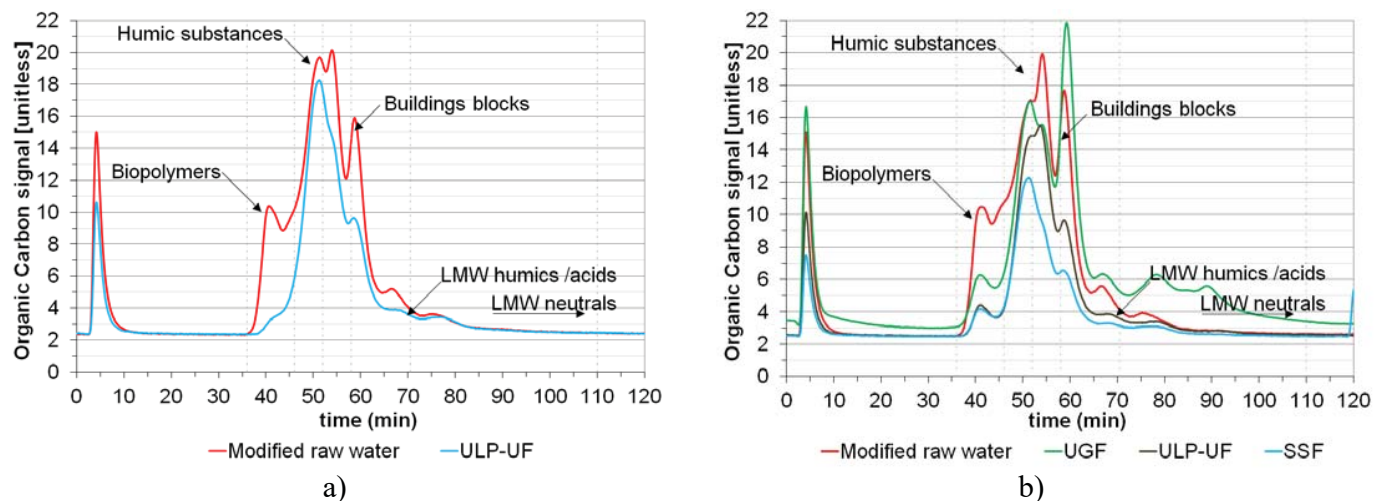
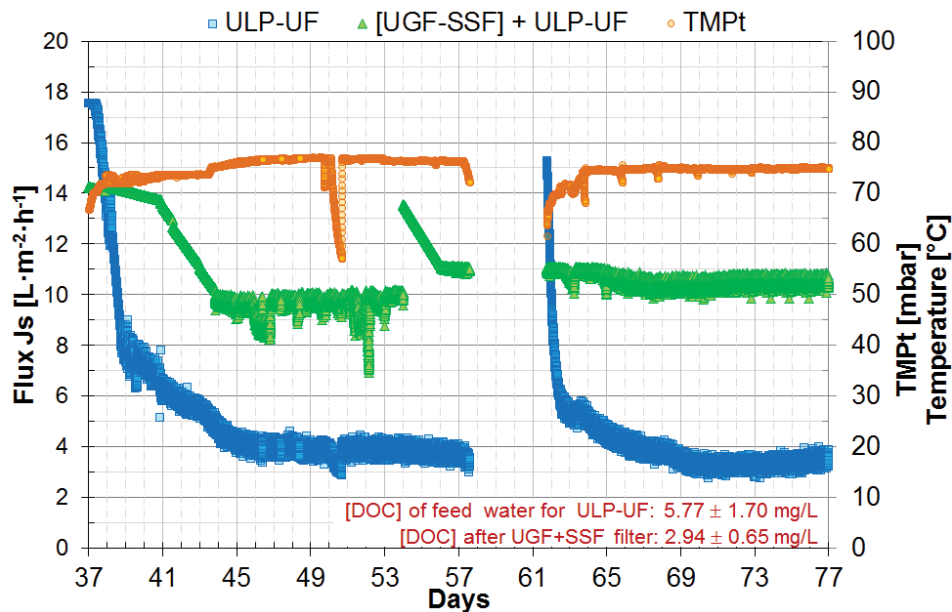


Figure 1. LC-OCD chromatograms with NOM fractions in a) pilot plant 1 and b) pilot plant 2

Figure 2 shows that by UGF-SSF filter as pre-treatment step, the flux can be increased almost at double in comparison to a ULP-UF without pre-treatment. Figure 2 shows the flux of PAUL without and with UGF-SSF filter as pre-treatment.



**Figure 2.** Flux stabilization of the dead-end ULP-UF without pretreatment and with UGF-SSF as pre-treatment and using as feed water modified raw water with higher TOC/DOC content

### Conclusion

This study shows that the ultrafiltration at very low pressures (ULP-UF) can be installed together with a pre-treatment of easy maintenance to increase the flux. In this way, an ULP-UF can be part of a decentralized small scale system to treat water for remote and rural areas with polluted raw water sources in terms of organic matter and pathogen content.

### References

- [1]. Derlon, N., Mimoso, J., Klein, T., Koetzsch, S., Morgenroth, E. 2014. Presence of biofilms on ultrafiltration membrane surfaces increases the quality of permeate produced during ultra-low pressure gravity-driven membrane filtration. *Water Research*, 60(0), 164-173.
- [2]. Peter-Varbanets, M., Margot, J., Traber, J., Pronk, W. 2011. Mechanisms of membrane fouling during ultra-low pressure ultrafiltration. *Journal of Membrane Science*, 377(1-2), 42-53.
- [3]. Huang, H., K. Schwab, et al. (2009). "Pretreatment for Low Pressure Membranes in Water Treatment: A Review." *Environmental Science & Technology* 43(9): 3011-3019.
- [4]. Kimura, K., Tanaka, K., Watanabe, Y. 2014. Microfiltration of different surface waters with/without coagulation: Clear correlations between membrane fouling and hydrophilic biopolymers. *Water Research*, 49(0), 434-443.
- [5]. Fabris, R., Lee, E.K., Chow, C.W.K., Chen, V., Drikas, M. 2007. Pre-treatments to reduce fouling of low pressure micro-filtration (MF) membranes. *Journal of Membrane Science*, 289(1-2), 231-240.
- [6]. Gao, W., Liang, H., Ma, J., Han, M., Chen, Z.-l., Han, Z.-s., Li, G.-b. 2011. Membrane fouling control in ultrafiltration technology for drinking water production: A review. *Desalination*, 272(1-3), 1-8.
- [7]. Huck, P.M., Sozanski, M.M. 2008. Biological filtration for membrane pre-treatment and other applications: towards the development of a practically-oriented performance parameter. *Journal of Water Supply: Research and Technology—AQUA*, 57(4), 203-224.
- [8]. Rahman, I., Van Dyke, M.I., Anderson, W.B., Jin, X., Ndongue, S., Huck, P.M. 2016. Effect of phosphorus addition on biofiltration pre-treatment to reduce ultrafiltration membrane fouling. *Desalination and Water Treatment*, 1-13.

## Optimizing the design and operation of a novel process: The Membrane aerated biofilm reactor integrated with activated sludge-(MABR-IFAS)

Pérez-Calleja, P.<sup>1</sup>, Esteban-García, A.<sup>1</sup>, Aybar, M.<sup>1</sup>, Tejero, I. <sup>1</sup>, and Larrea, L.<sup>1</sup>

<sup>1</sup>Department of Sciences and Techniques of Water and the Environment, University of Cantabria, (Spain)

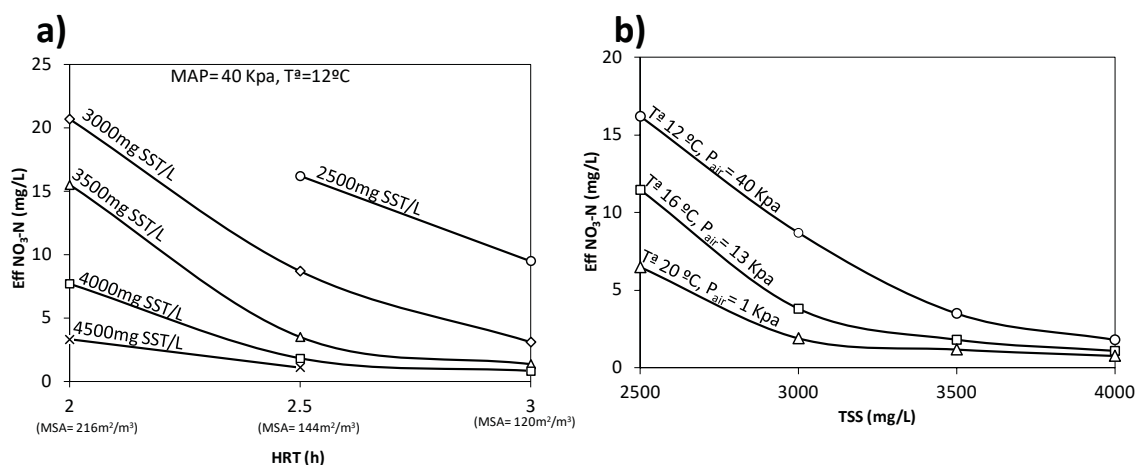
**Introduction:** In small wastewater treatment plants, the search for more energy-efficient treatment systems has become fundamental. Membrane Aerated Biofilm Reactors (MABRs), where the biofilm is supported on and aerated by a gas permeable membrane have been researched exhaustively since they are able to achieve high oxygen transfer efficiencies (up to 100%) and great energy savings (Esteban et al., 2012, Aybar et al., 2014). Satisfactory results of nutrient removal were obtained in pilot studies using synthetic wastewater, but the potential for application in real urban raw wastewater is very limited because the low concentration of readily biodegradable substrate hampers the growth of enough biomasses in the biofilm. In recent years IFAS (integrated fixed biofilm activated sludge) processes have attained very successful results (Rutt et al., 2006) in full scale plants because high nitrification rates in the biofilm and satisfactory denitrification and phosphorous removal in suspension biomass were obtained. It was thought that the combination of the MABR with the IFAS concept (MABR-IFAS process) could overcome the limitations of the MABR process. Thus, the first objective of this paper was to establish the operational criteria that lead to the optimum performance of the MABR-IFAS process in an experimental study for nitrogen removal. Then, the calibration of the MABR-IFAS process model from the experimental results was undertaken. Thus, the second objective was to establish the optimum design and operation conditions for the MABR-IFAS process using systematic simulation studies with the calibrated model.

### Experimental study: Material, methods and experimental results

The laboratory plant consisted of only one 15 litres reactor operated in anoxic conditions that contained one Kubota flat membrane of 0.11 m<sup>2</sup> (MSA: 7m<sup>2</sup>/m<sup>3</sup>) through which air was supplied at an inlet pressure of 7 Kpa. Quasi-real raw urban wastewater with the following average concentrations: TSS≈400mg/L, total COD≈600mg/L, filtered COD≈90 mg/L and NH<sub>4</sub>-N≈35mgN/L, was fed to the reactor, with an additional NO<sub>3</sub>-N dosage to hinder nitrate limiting conditions, maintaining effluent nitrate concentrations always higher than 2mg/L. The MABR- IFAS reactor was operated for 145 days and after several adjustments the final HRT was 14 hours in order to maintain effluent ammonium concentrations always higher than 4mg/L. The SRT resulted in 8 days so that a MLSS concentration of around 3000 mg/L was maintained. High average denitrification rate of 134gN/m<sup>3</sup>d at 20°C was achieved. Batch tests revealed that 95% of denitrification took place in suspension as desired, thereby indicating that most of the biodegradable COD (dissolved and particulated) was removed via heterotrophic denitrification in suspension. High average nitrification rates of 3gN/m<sup>2</sup>d were achieved. Batch tests showed that 90% of nitrification took place in the biofilm as intended. This was due to 1) operating with non ammonium limiting conditions in the biofilm (the half saturation constant for NH<sub>4</sub>-N is 1mg/L), and 2) biodegradable COD was removed anoxically in suspension, preventing the inhibition of nitrifying bacteria in the biofilm. In summary, the operational criteria for optimum performance of the MABR- IFAS process were established.

## Simulation studies: Materials, methods and results

For modelling purposes, the MABR-IFAS process was implemented in AQUASIM simulation software using the ASM2d biochemical model for nutrient removal and the colloid biofilm model developed at CEIT (Albizuri et al., 2014). The calibration process consisted in a stepwise iterative procedure, with adjustment of predefined fitting parameters in order to match the experimental results. Thus, the biofilm detachment coefficient was adjusted to obtain a biofilm thickness of 160 microns, and membrane mass transfer coefficient and boundary layer thickness were adjusted to 3m/d and 100 $\mu$ m respectively. Default values of the ASM2d model were not necessary to adjust. In the optimization process, another stepwise iterative procedure was applied in which the membrane surface area (MSA) and the membrane air pressure (MAP) were adjusted in order to match (as constraint) an effluent  $\text{NH}_4\text{-N}$  of around 4 mg/L. The hydraulic and solid retention times (HRT and SRT) were adjusted to match predefined MLSS. Regarding the results of the design optimization at 12°C and MAP of 40Kpa, figure a), shows, as an example, that effluent nitrate concentration of 9-10 mg/l (which implies a TN of about 16-18 mg/L) can be obtained for HRTs from 2 to 3h (MSA: from 216 to 120  $\text{m}^2/\text{m}^3$ ) with design MLSS from 4000 to 2500 mg/L respectively. For the optimization of the operation, figure b), (for a HRT=2.5h and MSA of 144  $\text{m}^2/\text{m}^3$ ), allows the determination of the air pressure and the MLSS concentration to be maintained depending on the temperature and the effluent  $\text{NO}_3\text{-N}$  concentration desired.



**Conclusions.** It has been demonstrated that the MABR-IFAS is a very promising technology to be applied in small WWTPs with low space available and low energy requirement. To include phosphorous removal the sequencing batch reactor SBR (very compact) can be applied.

## References

- Albiruzi, J., Van Loosdrecht, M.C.M., Larrea, L., 2009. Extended mixed-culture biofilms (MCB) model to describe integrated fixed film/activated sludge (IFAS) process behavior. *Water Science and Technology* 60(12): 3233-3241.
- Aybar, M., Pizarro, G., Boltz, J., Downing, L., Nerenberg, R., 2014. Energy-efficient wastewater treatment via the air-based, hybrid membrane biofilm reactor (hybrid MfBR). *Water Science and Technology* 69(8): 1735-1741.
- Esteban-García, A.L., Díez, R., Rodríguez, L., Lobo, A., De Florio, L., Pérez, P., Tejero, I. 2012. Processes based on the growth of biofilms on gas permeable membranes: Biomembrane reactors. In *Innovative Technologies for Urban Wastewater Treatment Plants (2nd Edition)*, Editors Omil F. and Suárez S., Santiago de Compostela. ISBN: 9788469535141, 117-145.
- Rutt K., Seda J., and Chandler H. J. 2006. Two year case study of integrated fixed film activated sludge at Broomfield, CO WWTP. Proceedings WEFTEC 06, Dallas, TX..



# Drugs abatement in surface water using photocatalytic coated glass surfaces

---

Bianchi, C.L.<sup>1</sup>, Stucchi, M.<sup>1,2</sup>, Sacchi B.<sup>1</sup>, Pirola, C.<sup>1</sup>, Boffito, D.<sup>2</sup>, Pellini, R.<sup>3</sup>, Capucci, V.<sup>3</sup>

<sup>1</sup> Università di Milano, Dip. Chimica, Via Golgi19, 20133 Milano, Italy

<sup>2</sup> Polytechnique Montréal, Département de Génie Chimique, Montréal, QC, H3C 3A4 Canada

<sup>3</sup> GranitiFiandre SpA, 41042 Fiorano M.se, Italy

## Abstract

Organics coming from pharmaceuticals and personal care products (PPCPs) persist in water and conventional treatment plants are not able to efficiently remove PPCPs. Ibuprofen (IBF) has high acute toxicity and its biological treatment forms toxic intermediates. Sonochemical treatment is insufficient to completely convert organics such as IBF to CO<sub>2</sub> and H<sub>2</sub>O. Photocatalysis by TiO<sub>2</sub> degrades IBF, however its complete mineralization is not reported yet. Here, first we investigated the mineralization of IBF to CO<sub>2</sub> by TiO<sub>2</sub> UV-A photocatalysis. Moreover, we replaced nano-sized P25 with a micro-sized commercial sample of TiO<sub>2</sub> to preclude the use of nanoparticles dangerous for human health. Micro-TiO<sub>2</sub> mineralized 100 % of IBF in 24 h. We deposited micro-TiO<sub>2</sub> on glass Raschig rings to ensure an easy recovery and reuse of the photocatalyst, and we studied their performance both in a batch and continuous reactor. TiO<sub>2</sub>-coated glass Raschig rings degraded 87 % of IBF in 6 h of UV-A irradiation in a continuous reactor, and they converted 25 % of it in CO<sub>2</sub>.

## 1. Introduction

Industrial and agricultural activities, transports, power generation and other human activities generate chemical products, whose misuse and improper disposal causes water pollution [1]. Organics coming from pharmaceuticals and personal care products (PPCPs) persist in water [2]. Domestic wastewater, hospital discharges, sewage treatment plants and water treatment plants are the way through which organic molecules enter in the water system [3]. PPCPs either retain both their original concentration and structure, or they convert to other compounds during their lifespan in aquatic matrices [4]. Concentration levels range from ng/l to µg/l [5], which are enough to cause undesired physiological effects in wildlife and humans [6]. Conventional treatment plants are not able to efficiently remove PPCPs [7, 8]. Koplín et al. first detected pharmaceutical compounds in surface water [9]; in 2017 Glassmayer et al. analyzed drinking water and revealed several classes of chemical compounds, including pharmaceuticals [10, 11]. Feng et al. reviewed electrochemical



advanced oxidation processes (EAOPs) for the removal of many anti-inflammatory and analgesic pharmaceuticals; they included aspirin, ibuprofen and ketoprofen as most significant considering their contamination levels in aqueous environment [12]. Ibuprofen (IBF), (RS)-2-(4-(2-methylpropyl)phenyl)propanoic acid is globally consumed and has a high acute toxicity [13]. Moreover its biological treatment forms toxic intermediates [14]. Sonochemical treatment degrades organic pollutants [15], but without complete mineralization [16]. Peller et al. combined sonolysis and photocatalysis for the degradation of chlorinated organic compounds and reached their complete mineralization [17]. However, in case of IBP, sono- or photo-degradation produce long-lived intermediates [18] or by-products that need a post-biological treatment as reported by Arriaga et al. [19].

Madhavan et al. [20] performed the sonophotocatalytic degradation of IBF using  $\text{Fe}^{3+}$ , and P25- $\text{TiO}_2$ : in 3 h, they reached 74 % mineralization by photocatalysis only, and 92 % mineralization by sono-photocatalysis. Many studies focused on photocatalytic degradation of IBF by  $\text{TiO}_2$ : Choina et al. doped  $\text{TiO}_2$ -P25 by Zr, improving the activity under UV light, but without reaching the complete mineralization [21]; others scientists focused on visible light photodegradation of IBF, as for example Yuan et al. [22], or El-Sheikh et al. [23]. They reached 100 % photodegradation of IBF under visible light, still without complete mineralization. Here, we report for the first time the complete mineralization of IBF by  $\text{TiO}_2$  UV photocatalysis. We replaced the reference among commercial  $\text{TiO}_2$  photocatalysts, i.e. nano-sized P25, with a micro-size commercial sample of  $\text{TiO}_2$  to avoid the use of nanoparticles, considering their potential harmful health effects [24] and their difficult management in water treatments plants [25]. Moreover, we deposited micro- $\text{TiO}_2$  on glass Raschig rings and we studied their performance both in batch and in continuous reactor. This is significant for continuous processing in large-scale water treatment plants.

## 2. Materials and methods

### 2.1 Materials

Glass spheres and Rashig rings of different sizes (Fig.1) were coated with tailored ink containing a commercial  $\text{TiO}_2$  sol-gel by Cristal, or micro-sized  $\text{TiO}_2$  by Kronos (K1077). K1077 particles size and crystallographic phase composition was reported in a previous work [26]. It consists completely of anatase and its particles dimension ranges from 110 to 130 nm. A diameter greater than 100 nm ensures the particles are not inhaled or come into contact with cells [27].

The ink was designed and developed for digital ceramic printers [28] and used for the production of photocatalytic industrial slabs [29], already tested as potential materials for drugs abatement in water [30].

Both glass balls and glass rings were immersed in the ink solution and then treated at 650°C for 30 minutes to favour the adhesion of the formulation to the glass surface.

Glass Raschig rings had two different dimensions, i.e. 6 mm or 8 mm for both diameter and length (Fig. 1 and 2).

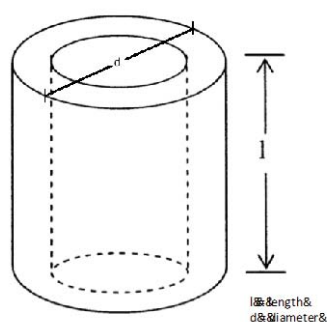


Fig. 1 Glass Raschig ring



Fig. 2 glass Raschig rings coated with a thin film of TiO<sub>2</sub>

We purchased IBF from Sigma Aldrich ( $\geq 98\%$ , GC), as well as all the solvents used for the analysis, i.e. dipotassium hydrogen phosphate ( $K_2HPO_4 \cdot 3H_2O$ , ReagentPlus<sup>®</sup>,  $\geq 99.0\%$ , Sigma-Aldrich) and Acetonitrile ( $CH_3CN$ , HPLC grade).

## 2.2 Reactors and photocatalytic setups

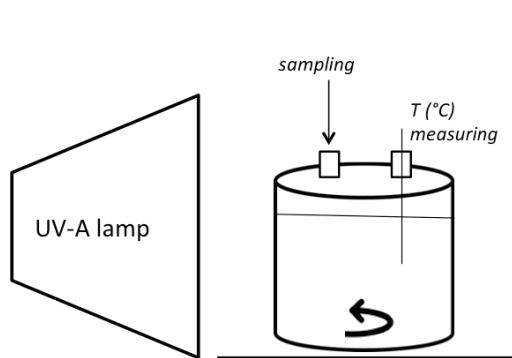


Fig. 3,A Setup for photocatalytic reactions with TiO<sub>2</sub> in powder in batch mode.

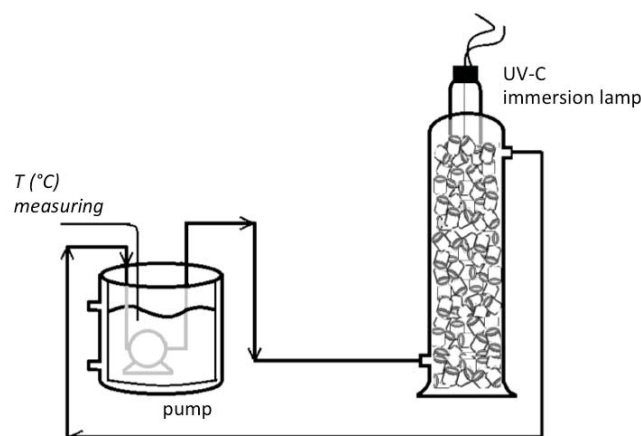


Fig. 3,B Setup for photocatalytic reactions with TiO<sub>2</sub>-functionalized Raschig.

UV-A (Iron halogenide lamp Jelosil, model HG 500, 500 W, 315–400 nm) tests in batch occurred in a glass cylindrical reactor 2 L volume. UV lamp distance from the reactor wall provided a 30 W m<sup>-2</sup> irradiation intensity (Fig. 3,A).

UV-C (UVC germicide immersion lamp Jelosil, model GL8, 220 V, 50 Hz, 9 W) tests were performed both in batch and in continuous mode. The tubular glass reactor was 35 cm in height, 5 cm in diameter, with an active volume of 600 cc volume (Fig. 3,B). Inlet/outlet ports are one on the bottom and one on the top, either closed or connected in recirculation to an external tank, respectively for batch or continuous tests, respectively (Fig. 3,B).

The UV-C lamp had a light intensity of 55 W m<sup>-2</sup>.

We followed the UV-A photodegradation of IBF in batch by K1077 TiO<sub>2</sub> in powder form. Each test lasted 24 h, withdrawing samples every 30 min for 6 h, with the last sampling after 24 h.

UV-C photodegradation of IBF occurred either by K1077 TiO<sub>2</sub> or by TiO<sub>2</sub>-coated Raschig rings. Batch tests lasted 24 h, while continuous kinetics lasted 6 h, sampling every hour. Temperature was maintained constant at 25 ± 2 °C for both setups.

## 2.3 Analytical Instruments

We monitored the IBF concentration by HPLC Agilent 1100 Series Instrument, with diode array detector and using a 125 mm × 4 mm C18 reverse phase column. The mobile phase composition was 78:28 K<sub>2</sub>HPO<sub>4</sub>·3H<sub>2</sub>O and acetonitrile, respectively. The buffer contained 2.3 g of K<sub>2</sub>HPO<sub>4</sub>·3H<sub>2</sub>O dissolved in 1000 mL of boiled ultrapure milli-Q water. A diluted solution of phosphoric acid (H<sub>3</sub>PO<sub>4</sub>) or NaOH adjusted the pH to 6.8±0.1 A TOC 5000A Shimadzu Instrument monitored the carbon contain to calculate the IBF mineralization.

### 3. Results and discussion

#### 3.1 Photodegradation of IBF in batch by micrometric TiO<sub>2</sub>

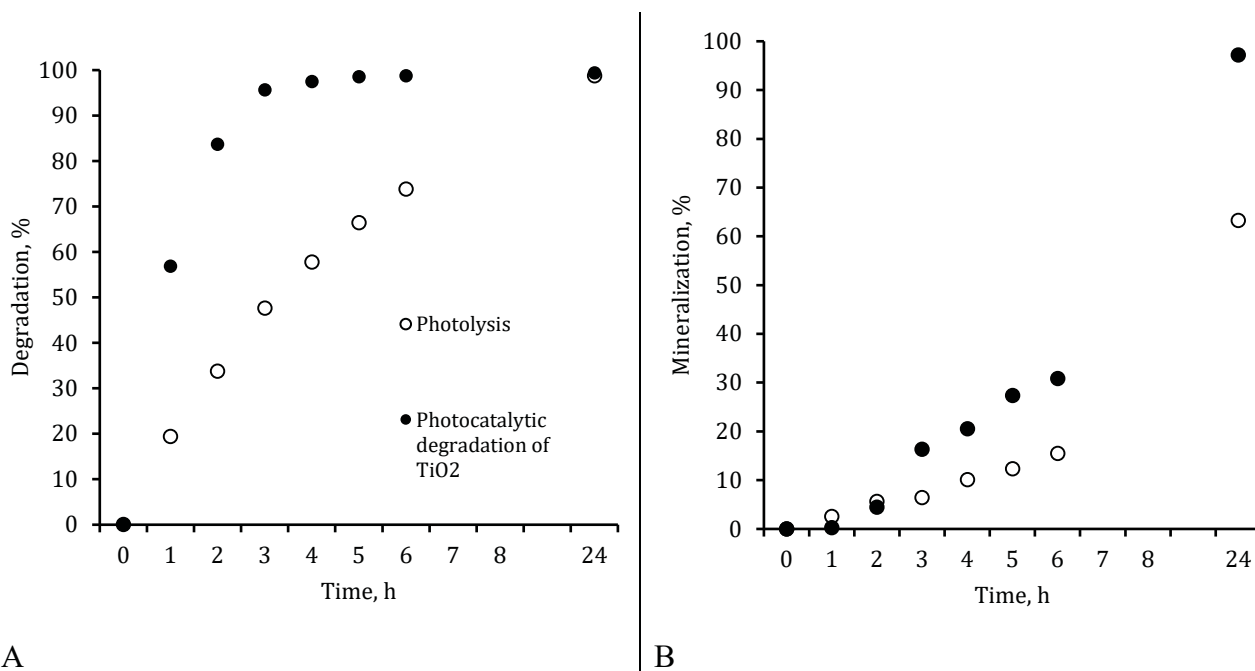


Fig. 4 UV-A photolysis and photocatalytic degradation in batch mode. IBF degradation % vs. time (A) and IBF mineralization % vs. time (B)

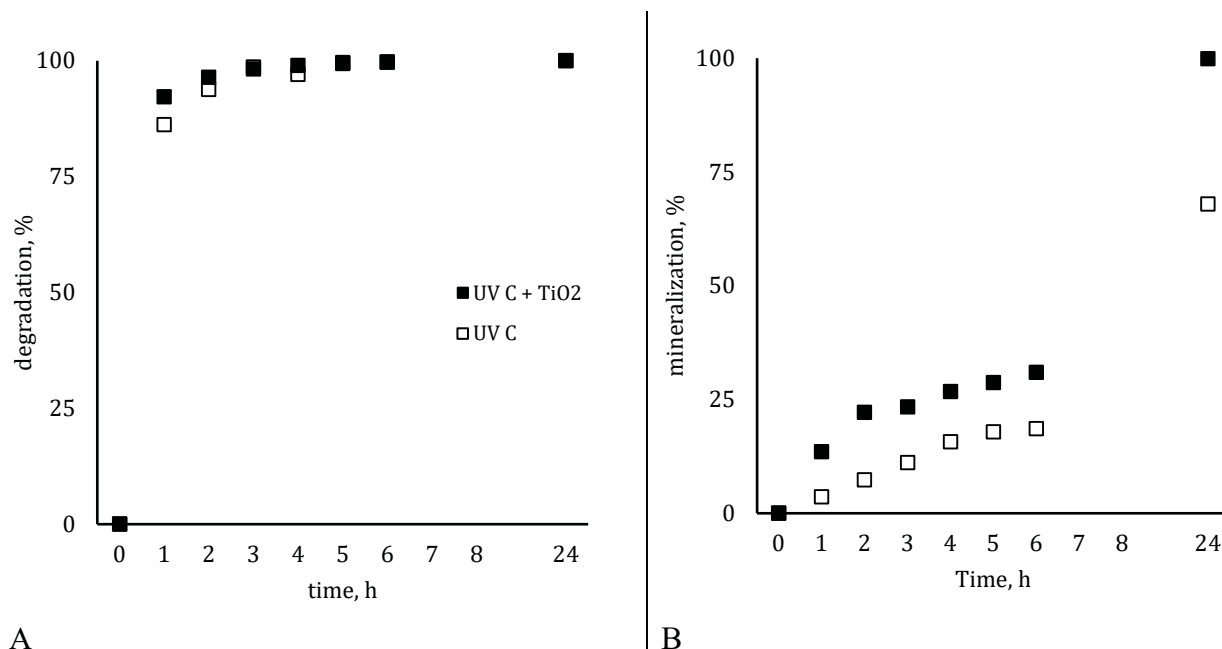


Fig. 5 UV-C (immersion lamp, setup fig. x) photolysis and photocatalytic degradation in batch mode. IBF degradation % vs. time (A) and IBF mineralization % vs. time (B)

For the UV-A photodegradation tests in batch, the presence of K1077 TiO<sub>2</sub> increased the reaction rate degrading the total amount of IBF in 6 h (Fig 4,A) as already observed with other drugs [30].

Indeed photolysis gave 63 % of degradation in the same time. However, after 24 hours the degradation was complete for both the kinetics. Photolysis is effective on the IBF degradation, but it converted 68 % of IBF to CO<sub>2</sub> in 24 h. TiO<sub>2</sub> completely mineralized IBF in the same time (fig 4,B). Thus, mineralization trends are remarkably different and proved the activity of the catalyst. UV-C photolysis showed higher IBF degradation than UV-A, degrading 99 % of organics in 6 h, and increased mineralization up to 68 % after 24 h. However, only the presence of TiO<sub>2</sub> gave the complete conversion of IBF in CO<sub>2</sub> (fig 5A,B).

### 3.2 Photodegradation of IBF using glass Raschig rings

#### 3.2.1 Raschig dimension optimization

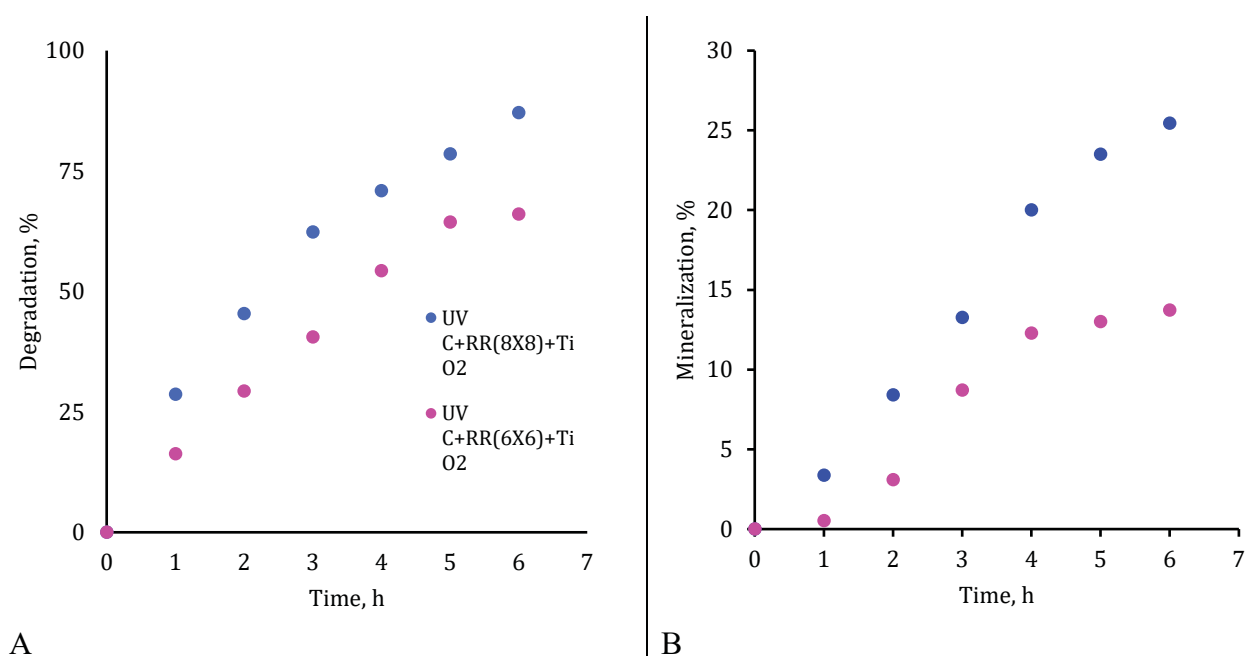


Fig. 6 IBF UV photodegradation (A) and mineralization % (B) over time; comparison between TiO<sub>2</sub>-functionalized Raschig with different dimension.

TiO<sub>2</sub>-coated glass Raschig catalyst decreases the IBF degradation compared to photolysis, because increasing glass layers, the intensity of the radiation reaching the organics to degrade decreases. However, they are effective on the IBF mineralization: they converted 25 % of IBF to CO<sub>2</sub> in 6 h compared to the 18 % conversion of photolysis.

8 x 8 mm glass Raschig rings achieved higher degradation and mineralization % in compared to the 6 x 6 mm ones (Fig 6). Ibuprofen final degradation was 87% 66 % using 6 x 6 mm and 8 x 8 mm Raschig rings, respectively; mineralization was 25 % and 13 %, respectively (Fig. 6,b). Results are consistent with the limitation of UV-C irradiation due to the increase of glass Raschig ring layers.

While the active surface area is similar for the 6 x 6 and 8 x 8 rings (0.23 and 0.20 m<sup>2</sup>, respectively), the number of glass Raschig rings increased from 625 to 1030 using the smaller ones.

### 3.2.2 TiO<sub>2</sub>-functionalized Raschig IBF photodegradation

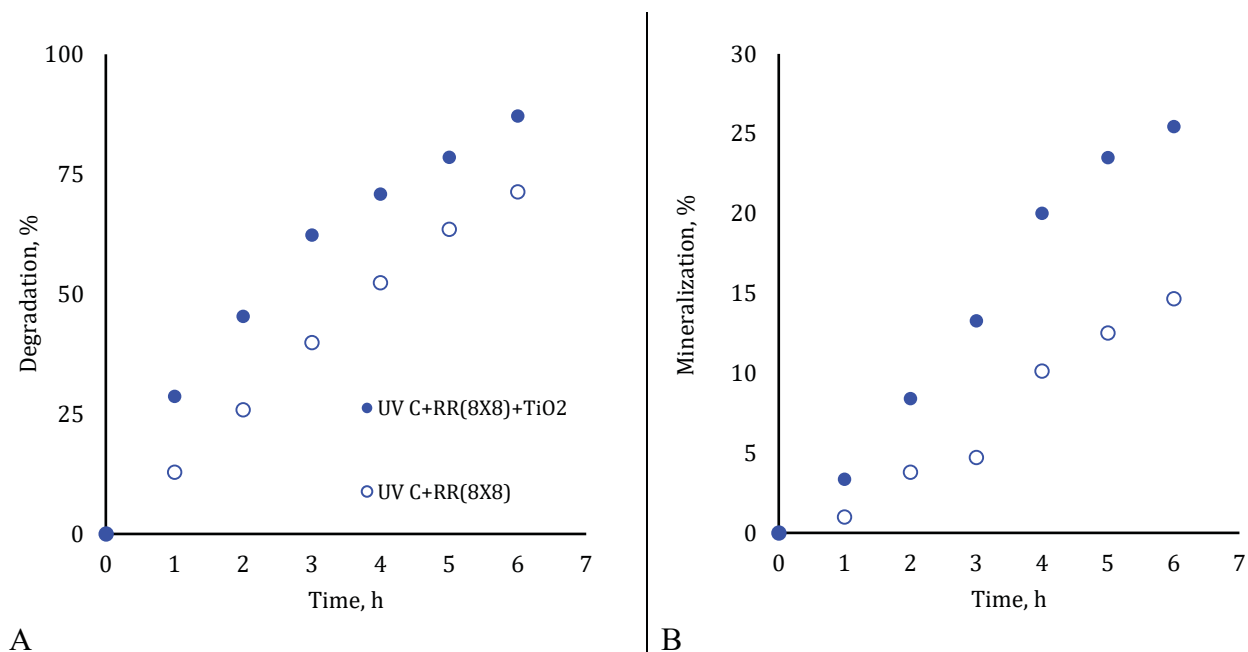


Fig. 7 IBF UV C photodegradation (A) and mineralization % (B) over time; comparison between naked glass Raschig rings and TiO<sub>2</sub>-functionalized Raschig (optimized dimension).

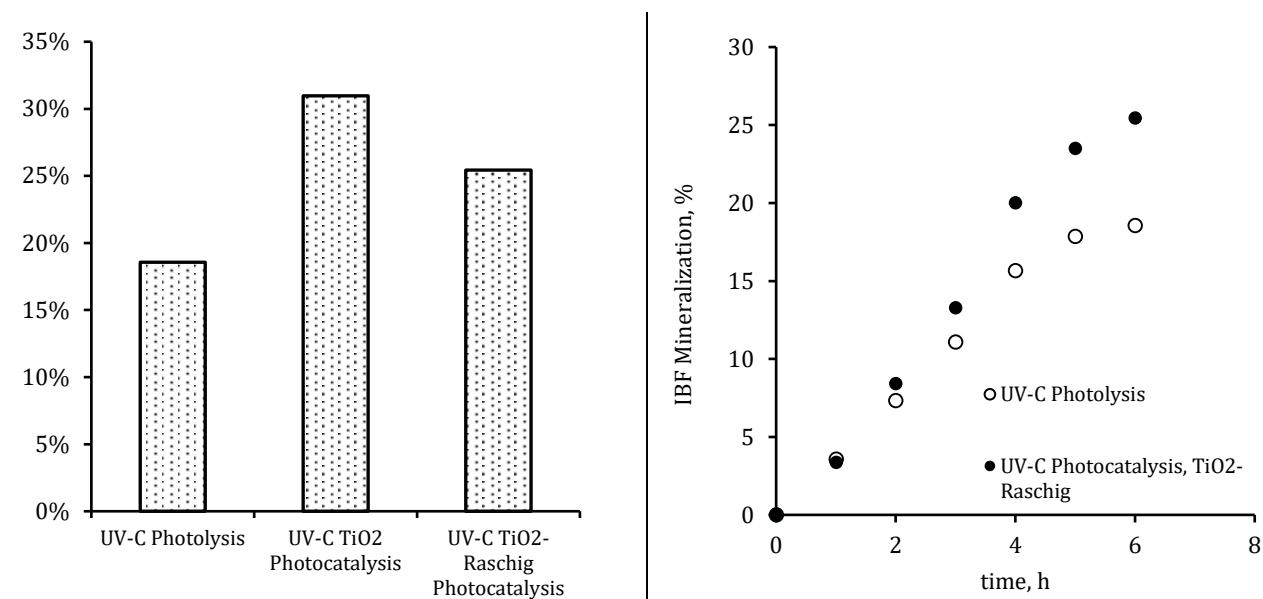


Fig. 8 IBF mineralization % reached after 6 h of i) UV-C irradiation (photolysis), ii) photocatalytic degradation with TiO<sub>2</sub> in powder and iii) photocatalytic degradation with TiO<sub>2</sub>-functionalized Raschig

Fig. 9 IBF mineralization over time: comparison between photolysis and UV-C photocatalytic degradation with TiO<sub>2</sub>-functionalized Raschig



We studied the contribution of the TiO<sub>2</sub> layer by comparing 8 x 8 mm TiO<sub>2</sub>-coated glass Raschig rings with bare ones. TiO<sub>2</sub> deposition increased the degradation of IBF from 71 % to 87 % in 6 h, and it increased the mineralization by 11 % (fig 7 A and B). A comparison between final mineralization % obtained by photolysis, photocatalytic reaction by TiO<sub>2</sub> in powder, and photocatalytic reaction by TiO<sub>2</sub>-coated Raschig rings (Fig. 8) shows that: i) TiO<sub>2</sub> increase the IBF conversion to CO<sub>2</sub> comparing with photolysis, ii) powder efficiency is higher with a mineralization above 30 %, however iii) TiO<sub>2</sub>-coated Raschig rings increased the mineralization from 18 % reached by photolysis to 25 % (Fig 9).

## Conclusion

TiO<sub>2</sub>-coated Raschig rings are a real option for photocatalytic water treatment plants.

We first proved that micro-TiO<sub>2</sub> degrade and mineralize IBF. Replacing nano-P25 with it we avoided nanoparticles that have potential harmful health effects. We successfully deposited micrometric TiO<sub>2</sub> on glass Raschig rings and we optimized their dimension to 8 x 8 mm to increase the IBF photodegradation in a continuous setup. In this way, we avoided TiO<sub>2</sub> dispersed in water and any further filtration treatment. TiO<sub>2</sub> on glass Raschig rings improved the IBF degradation and its complete conversion to CO<sub>2</sub> in comparison with photolysis. Thus, they can be considered as innovative material to be applied in large-scale water treatment plants

## References

- [1] K.R. Echols, J.C. Meadows, C.E. Orazio, Reference Module in Earth Systems and Environmental Sciences, from Encyclopedia of Inland Waters, (2009) 120-128.
- [2] B. Blair, A. Nikolaus, C. Hedman, R. Klaper, T. Grundl, Chemosphere, 134 (2015) 395–401.
- [3] J.L. Liu, M.H. Wong, Environ. Int., 59 (2013) 208–224.
- [4] Y. Yang, Y.S. Ok, K. Kim, E.E. Kwon, Y. F. Tsang, Sci. Total Environ., 596–597 (2017) 303-320.
- [5] E. Archer, B. Petrie, B. Kasprzyk-Hordern, G.M. Wolfaardt, Chemosphere, 174 (2017) 437-446.
- [6] B. Petrie, R. Barden, B. Kasprzyk-Hordern, Water Res., 72 (2014) 3–27.
- [7] S.K. Behera, H.W. Kim, J.E. Oh, H.S. Park, Sci. Total Environ., 409(20) (2011) 4351–4360.
- [8] Y. Zhang, S.U. Geißen, C. Gal, Chemosphere, 73(8) (2008) 1151–1161.
- [9] D.W. Kolpin, E.T. Furlong, M.T. Meyer, E.M. Thurman, S.D. Zaugg, L.B. Barber, H.T. Buxton, Environ. Sci. Technol., 36(6) (2002) 1202.

- [10] S.T. Glassmeyer, E.T. Furlong, D.W. Kolpin, A.L. Batt, R. Benson, J.S. Boone, M.S. Kostich, *Sci. Total Environ.*, 581 (2017) 909–922.
- [11] S.T. Glassmeyer, E.T. Furlong, D.W. Kolpin, A.L. Batt, R. Benson, J.S. Boone, O. Conerly, M. J. Donohue, D. N. King, M. S. Kostich, H. E. Mash, S. L. Pfaller, K. M. Schenck, J.E. Simmons, E. A. Varughese, S. J. Vesper, E. N. Villegas, V. S. Wilson, *Sci. Total Environ.*, 581-582 (2017) 909–922.
- [12] L. Feng, E.D. van Hullebusch, M.A. Rodrigo, G. Esposito, M.A. Oturan, *Chem. Eng. J.*, 228 (2013) 944–964.
- [13] G.A. Loraine, M.E. Pettigrove, *Environ. Sci. Technol.*, 40 (2006) 687–695.
- [14] P.H. Roberts, K.V. Thomas, *Sci. Total Environ.*, 356 (2006) 143–153.
- [15] R. Singla, F. Grieser, M. Ashokkumar, *Ultrason. Sonochem.*, 16 (2009) 28-34.
- [16] K. Hirano, H. Nitta, K. Sawada, *Ultrason. Sonochem.*, 12 (2005) 271-276.
- [17] J. Peller, O. Wiest, P.V. Kamat, *Environ. Sci. Technol.*, 37 (2003), 1926-1932.
- [18] F. Mendez-Arriaga, R.A. Torres-Palmaa, C. Petrier, S. Esplugas, J. Gimenezd, C. Pulgarin, *Water Res.*, 42 (2008) 243-4248.
- [19] F. Mendez-Arriaga, S. Esplugas, J. Gimenez, *Water Res.*, 42 (2008) 585-594.
- [20] J. Madhavan, F. Grieser, M. Ashokkumar, *J. Hazard. Mater.*, 178 (2010) 202–208.
- [21] J. Choina, Ch. Fischer, G.-U. Flechsig, H. Kosslick, V.A. Tuan, N.D. Tuyen, N.A. Tuyen, A. Schulz, *J. Photochem. Photobiol. A: Chem.*, 274 (2014) 108–116.
- [22] C. Yuan, C.H. Hung, H.W. Li, W.H. Chang, *Chemosphere*, 155 (2016) 471-478.
- [23] S. M. El-Sheikh, T. M. Khedr, A. Hakki, A. A. Ismail, W. A. Badawy, D. W. Bahnemann, *Sep. Purific. Technol.*, 173 (2017) 258–268.
- [24] Y. Ze, L. Zheng, X. Zhao, S. Gui, X. Sang, J. Su, N. Guan, L. Zhu, L. Sheng, R. Hu, J. Cheng, Z. Cheng, Q. Sun, L. Wang, F. Hong, *Chemosphere*, 92 (2013) 1183–1189.
- [25] Z. Hossain, G. Mustafa, S. Komatsu, *Int J Mol Sci.* 16(11) 2015 26644–26653.
- [26] C. L. Bianchi, C. Pirola, F. Galli, G. Cerrato, S. Morandi, V. Capucci, *Chem. Eng. J.*, 261 (2015) 76–82.
- [27] ISO/TS 27687:2008 Nanotechnologies - Available at [http://www.iso.org/iso/iso\\_catalogue.htm](http://www.iso.org/iso/iso_catalogue.htm)
- [28] <http://digitalife.active-ceramic.com/>
- [29] C.L. Bianchi, G. Cerrato, B. Sacchi, S. Capelli, V. Capucci, *Environmental Science and Pollution Research*, DOI 10.1007/s11356-017-9066-6
- [30] C.L. Bianchi, B. Sacchi, C. Pirola, F. Demartin, G. Cerrato, S. Morandi, V. Capucci, *Environmental Science and Pollution Research*, 24(14) (2017) 12646-12654

# Biochar efficiently removes recalcitrant pharmaceuticals from wastewater

Ref # S2SMALL- 40441

Sahar Dalahmeh <sup>1</sup>, Lutz Ahrens <sup>2</sup>, Meritxell Gros <sup>3</sup>, Karin Wiberg <sup>2</sup>, Mikael Pell <sup>4</sup>

<sup>1</sup> Department of Energy and Technology, Swedish University of Agricultural Sciences (SLU), Box 7032, SE 750 07 Uppsala, Sweden.

<sup>2</sup> Department of Aquatic Sciences and Assessment, SLU, Box 7050, SE 750 07 Uppsala, Sweden

<sup>3</sup> Catalan Institute for Water Research (ICRA), C/Emili Grahit 101, Girona, Spain

<sup>4</sup> Department of Molecular Sciences, Swedish University of Agricultural Sciences (SLU), Box 7015, SE 750 07 Uppsala, Sweden

\* Corresponding Author: E-mail: Sahar.Dalahmeh@slu.se

**Abstract:** This study investigated the potential of biochar as a filter medium for removal of pharmaceutically active compounds (PhACs) and wastewater macro-pollutants in on-site wastewater treatment systems. Removal of carbamazepine among other selected PhACs was investigated over 22 weeks experiment in four treatments: biochar (BC) with active and inactive biofilm (BC-active-biofilm, BC-inactive-biofilm), biochar without biofilm for adsorption only (BC-no-biofilm) and sand with active biofilm (Sand-active-biofilm). Carbamazepine removal in BC-no-biofilm (98%) was high due to adsorption, while non-existent removal was observed in Sand-active-biofilm, revealing low biodegradability of carbamazepine. Removal of carbamazepine in BC-active-biofilm was stable (>98%), while it declined with time in BC-inactive-biofilm. In conclusion, biochar is a promising filter material supporting active biofilm and adsorption for the removal of PhACs in on-site wastewater treatment systems.

**Keywords:** Adsorption; biochar; biodegradation; carbamazepine; onsite wastewater treatment

## INTRODUCTION

Environmental pollution by residual pharmaceutically active compounds (PhACs) is a growing problem (Fatta-Kassinos, 2010). Investments and developments in the pharmaceutical industry have resulted in continuous increases in drug production and PhACs are continually being released to the environment via wastewater.

In Sweden, around one million people live in rural areas that are not connected to a public sewerage system, but instead use around 675,000 on-site sewage treatment facilities (OSSFs) (Ejhed et al., 2016; SMED, 2011). Sand filter and soil infiltration systems for on-site wastewater treatment systems have proven to be only partially efficient or inefficient in removal of different types of organic micro-pollutants, including pharmaceuticals. For example, Gros et al. (2016) reported no significant removal of acetaminophen in soil beds, while average to low removal was observed for other substances, such as 46% removal for ibuprofen, 86% for diclofenac, 44% for metoprolol and 73% for caffeine. Similarly, Matamoros et al. (2009) reported that well-functioning sand filters in Denmark achieved removal efficiency of >80% for the PhACs salicylic acid, ibuprofen and carboxy-ibuprofen, but failed to remove carbamazepine, diclofenac and ketoprofen. These studies demonstrate

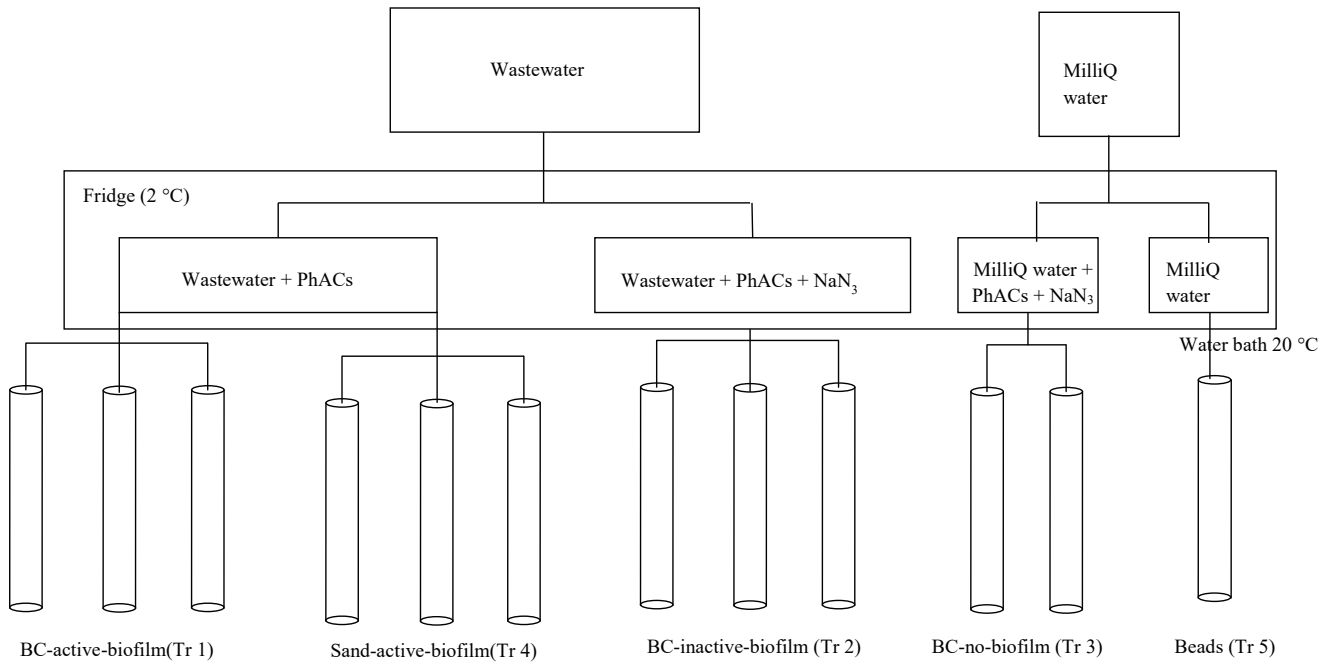
that many PhACs and probably also related metabolites and transformation products are able to pass through sand filters and enter groundwater or surface water resources.

This study investigated the potential of biochar filters for on-site treatment of recalcitrant macro-pollutants i.e carbamazepine in on-site and small wastewater treatment systems. Specific objectives were to: (i) investigate the removal of a model recalcitrant PhACs (carbamazepine) from wastewater via biodegradation, adsorption and a combination of both processes, and (iii) assess the efficiency of biochar filters with and without active biofilm in removal of carbamazepine from wastewater.

## MATERIALS AND METHODS

Lab-scale filter columns (60 cm x 5 cm, height x diam) were packed with biochar and tested using different treatments, allowing the study of biological degradation and adsorption of pharmaceuticals (Figure 1). The treatments included: (1) three biochar filters with active biofilm (BC-active-biofilm) fed with wastewater spiked with pharmaceuticals, (2) three biochar filters with non-active biofilm (BC-inactive-biofilm) fed with wastewater spiked with pharmaceuticals and sodium azide (to inhibit biofilm development), (3) two biochar filters with no biofilm (BC-no –biofilm) fed with ultrapure water spiked with pharmaceuticals and sodium azide. In addition, (4) three sand filters with active biofilm (Sand-active-biofilm) were packed and fed with wastewater to form active biofilm spiked with pharmaceuticals. A glass bead filter was used as control and was fed with ultrapure water. The wastewater and ultrapure water used were spiked with  $10 \mu\text{g L}^{-1}$  of model pharmaceutical compounds including carbamazepine. These substances were selected according to their high therapeutic use, occurrence in wastewaters in Sweden, and recalcitrance during conventional wastewater. All the filters were fed continuously with wastewater for a period of 22 weeks. During the first five weeks of the experiment, and before dosing of pharmaceuticals, a biofilm were allowed to develop in the relevant treatments. Thereafter, the pharmaceuticals were dosed until the end of the experiment. The effluent from each filter was collected daily, cooled to 1-2 °C, and accumulated over 7 days in brown glass bottles. Thereafter, the accumulative effluents were stored at -18 °C until extracted and analyzed.

Pharmaceuticals were analyzed by solid phase extraction (SFE) followed by ultrahigh performance liquid chromatography (HPLC) coupled to a XevoQ2 quadrupole-time-of-flight (QToF) mass spectrometer. Prior to extraction, samples were filtered through  $0.7 \mu\text{m}$  glass fiber filters. A volume of 50mL of inflow and 100mL of effluent wastewater were analyzed, and  $50 \mu\text{L}$  of  $0.5 \text{ ng mL}^{-1}$  of isotopically labelled pharmaceuticals were added to the samples as internal standards. The samples were percolated onto Oasis HLB cartridges (200mg, 6mL). The cartridges were eluted with pure methanol, dried under nitrogen stream, and reconstituted to  $0.5 \text{ mL}$  with MeOH/water (10/90, v/v). Samples were injected in full-scan mode, and compounds were quantified using the extracted ion chromatograms of the protonated molecular ion.



**Figure 1.** Schematic diagram of the column experiments using biochar (BC) with active biofilm (n = 3), inactive biofilm (n = 3) and no biofilm (n = 2), and sand (Sand) with active biofilm (n = 3) and glass bead filter as blank (n = 1). PhACs = pharmaceutically active compounds.

## RESULTS AND DISCUSSION

The average concentration of carbamazepine in the spiked wastewater fed to BC-active-biofilm, BC-inactive-biofilm, BC-no-biofilm and Sand-active-biofilm ranged from  $6850 \pm 1507$  to  $12,300 \pm 637$  ng L<sup>-1</sup>. However, the measured concentration of carbamazepine was occasionally higher than the theoretical spiked wastewater concentration due to background contamination of wastewater with carbamazepine. The average removal of carbamazepine during the experimental period ranged from  $90 \pm 11\%$  in the BC-inactive-biofilm filters to  $99 \pm 4\%$  in BC-no-biofilm, with the lowest effluent concentration of  $31 \pm 83$  ng L<sup>-1</sup> measured in the latter treatment. The BC-active-biofilm and BC-no-biofilm filters maintained high removal of carbamazepine (99%) with low effluent concentrations ( $<40$  ng L<sup>-1</sup>) throughout the experiment (Figure 2). However, removal of carbamazepine in BC-inactive-biofilm declined from 99% in week 13 to 73% in week 22. The effluent of the Sand-active-biofilm filters contained high average effluent concentrations of carbamazepine ( $11,245 \pm 3455$  ngL<sup>-1</sup>) during the entire experimental period and these filters fluctuated between low removal rate and carbamazepine emissions (31% to -46%; Figure 2).

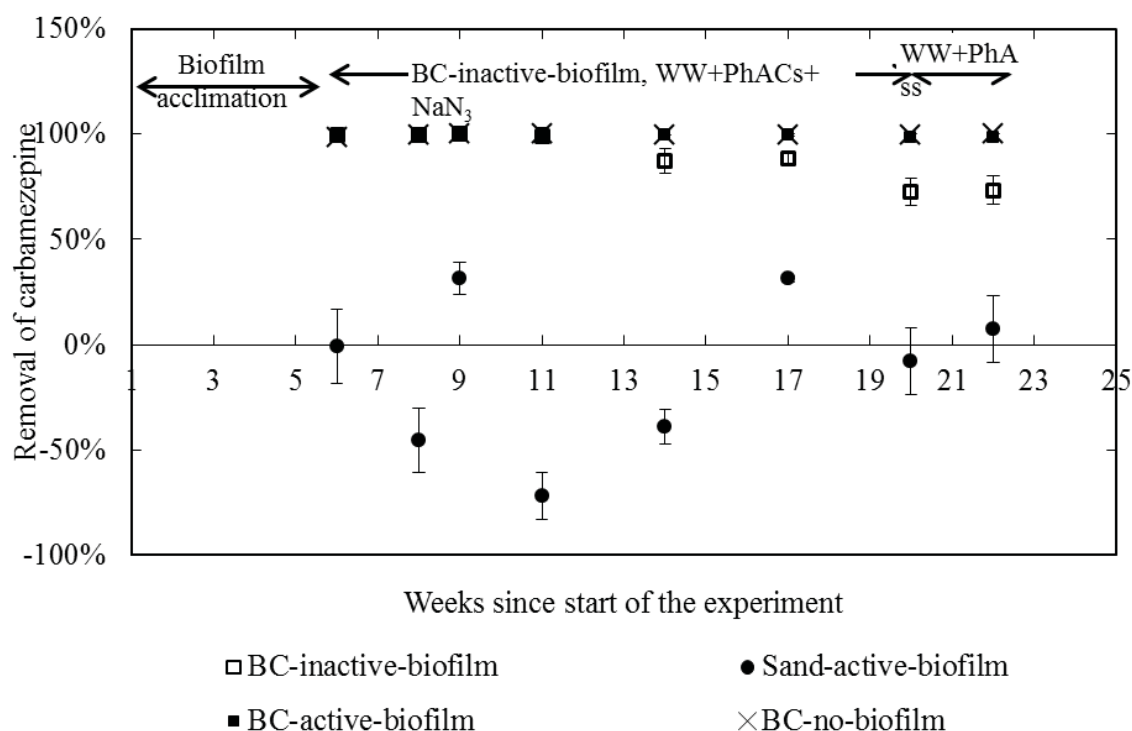


Figure 2. Capacity of BC-active-biofilm (■), BC-inactive-biofilm (□), BC-no-biofilm (×) and Sand-active biofilm (●) for removal of carbamazepine during 22 weeks of exposure to spiked wastewater or MilliQ water. Symbols and error bars represent mean  $\pm$  standard deviation,  $n = 3$  for the effluent and  $n = 1$  for the influent. BC = biochar, PhACs = pharmaceutically active compounds.

Carbamazepine was selected as model substance for removal by biochar due to its frequent occurrence in water and wastewater in Sweden and in Europe (Archer et al., 2017; Fick et al., 2011; Tröger et al., 2017). A recent study on micro-pollutants in on-site wastewater systems in Sweden showed that influent to the systems contained PhACs at wide range of concentration, from non-detectable levels up to  $180$  ng L<sup>-1</sup> of carbamazepine (Gros et al., 2016). The spiked concentrations of PhACs used in the present study were significantly



higher than those reported by Gros et al. (2016) except. High concentrations were selected for use here because the aim was to explore the capacity of the filters to remove PhACs, rather than to mimic environmental concentrations of these substances.

Carbamazepine was removed efficiently in BC-no-biofilm and in BC-active-biofilm (Figure 2). The removal mechanism was mainly adsorption to the surface of the biochar, as indicated by the high removal in BC-no-biofilm. The poor to no removal of carbamazepine in the Sand-active-biofilm filters (31% to -46%) shows poor biodegradability of carbamazepine in biofilms. In BC-active-biofilm, the biofilm may have regenerated the biochar, due to simultaneous biodegradation of easily degradable organic matter (COD) from the wastewater accumulating on the surface. This most likely cleaned the surfaces of the biochar and made them available for prolonged adsorption of carbamazepine. Abromaitis et al. (2016) reported that biologically active carbon systems provide the same effluent quality as regards persistent pollutants as abiotic active carbon systems but, due to the contribution of the biomass to the removal, the lifetime of the adsorbent is longer. In the absence of substantial biologically active biofilm, as in BC-inactive-biofilm, the removal of carbamazepine declined after 14 weeks of treatment from 99 to 87 %, which demonstrates the negative consequences of lack of an active biofilm cleaning the surface of the biochar (Figure 2). Adsorption of carbamazepine by BC-inactive-biofilm was affected by the presence of wastewater organics, due to competition for adsorption sites on surfaces. Similarly, Saravia and Frimmel (2008) showed that the presence of natural organic matter (as in BC-inactive-biofilm) reduced adsorption of carbamazepine on activated carbon. In addition, carbamazepine is a neutral and hydrophilic substance, while the accumulation of organic matter from wastewater (as in BC-inactive-biofilm filters) can be expected to increase the hydrophobicity of the biochar, meaning that carbamazepine would be repelled from the surface. The effluent of the Sand-active-biofilm filters contained higher concentrations of carbamazepine than the influent, indicating negative removal of carbamazepine. Such negative removal can be explained by desorption of accumulated carbamazepine on the filter. Zhou et al. (2009) concluded that PhACs can only be temporarily retained in sand, while poor removal of carbamazepine (<10%) in slow sand filters and sand infiltration systems has also been reported by D'Alessio et al. (2015); Nakada et al. (2007).

## CONCLUSIONS

Carbamazepine was efficiently removed only in the biochar filters, predominantly by adsorption. In contrast to sand, biochar provided large specific surface for sorption and biofilm growth, which provided higher capacity for removal of PhACs with different characteristics. Overall, the results highlighted the importance of biofilm for removal of pharmaceuticals, and also for suggested bio-generation of filter media. Biochar has good potential to enhance PhAC removal in on-site wastewater treatment systems, either by replacing sand in the filter bed or as an add-on module after the main filter. Further studies are needed to investigate the long-term capacity of biochar for PhAC removal and the effects of different loading regimes and implementation configurations.

## REFERENCES

Abromaitis, V., Racys, V., van der Marel, P., Meulepas, R.J.W. 2016. Biodegradation of persistent organics can overcome adsorption-desorption hysteresis in biological activated carbon systems. *Chemosphere*, **149**, 183-189.

- Archer, E., Petrie, B., Kasprzyk-Hordern, B., Wolfaardt, G.M. 2017. The fate of pharmaceuticals and personal care products (PPCPs), endocrine disrupting contaminants (EDCs), metabolites and illicit drugs in a WWTW and environmental waters. *Chemosphere*, **174**, 437-446.
- D'Alessio, M., Yoneyama, B., Kirs, M., Kisand, V., Ray, C. 2015. Pharmaceutically active compounds: Their removal during slow sand filtration and their impact on slow sand filtration bacterial removal. *Sci Total Environ*, **524-525**, 124-35.
- Ejhed, H., Widén-Nilsson, E., Brunell, J.T., Hytteborn, J. 2016. Näringsbelastningen på Östersjön och Västerhavet 2014.
- Fatta-Kassinos, D. 2010. K. Kümmerer, Pharmaceuticals in the environment: sources, fate, effects and risks. *Environmental Science and Pollution Research*, **17(2)**, 519-521.
- Fick, J., Lindbert, R.H., Kaj, L., Brorström-Lunden, E. 2011. Results from the Swedish National Screening Programme 2010- Subreport 3 Pharmaceuticals. Swedish Environmental Research Institute (IVL).
- Gros, M., Blum, K.M., Jernstedt, H., Renman, G., Rodriguez-Mozaz, S., Haglund, P., Andersson, P.L., Wiberg, K., Ahrens, L. 2016. Screening and prioritization of micropollutants in wastewaters from on-site sewage treatment facilities. *J Hazard Mater*, **328**, 37-45.
- Matamoros, V., Arias, C., Brix, H., Bayona, J.M. 2009. Preliminary screening of small-scale domestic wastewater treatment systems for removal of pharmaceutical and personal care products. *Water Research*, **43(1)**, 55-62.
- Nakada, N., Shinohara, H., Murata, A., Kiri, K., Managaki, S., Sato, N., Takada, H. 2007. Removal of selected pharmaceuticals and personal care products (PPCPs) and endocrine-disrupting chemicals (EDCs) during sand filtration and ozonation at a municipal sewage treatment plant. *Water Research*, **41(19)**, 4373-4382.
- SMED. 2011. Teknikenkät - enskilda avlopp 2009.
- Tröger, R., Ahrens, L., Franke, V., Glimstedt, L., Klöckner, P., Kothawahla, D., Köhler, S., Wiberg, K. 2017. Tracing micropollutants in raw and drinking water in Sweden. . in: *SETAC Europe 27th Annual Meeting*. . Brussels, Belgium, .
- Zhou, J.L., Zhang, Z.L., Banks, E., Grover, D., Jiang, J.Q. 2009. Pharmaceutical residues in wastewater treatment works effluents and their impact on receiving river water. *Journal of Hazardous Materials*, **166(2-3)**, 655-661.

# Removal of micropollutants and nutrients using filter beds for on-site sewage treatment – column and field experiments

Ref # S2SMALL-05641

W. Zhang<sup>1\*</sup>, G. Renman<sup>1</sup>, L. Ahrens<sup>3</sup>, K. Blum<sup>2</sup>, P. Gago-Ferrero<sup>3</sup>, Q. Gao<sup>2</sup>, B. Björlenius<sup>1</sup>, Kholoma, E.<sup>1</sup>

<sup>1</sup> KTH Royal Institute of Technology, Teknikringen 76, SE-10044 Stockholm, Sweden

<sup>2</sup> Umeå University, Linnaeus väg 6, SE-90187 Umeå, Sweden

<sup>3</sup> Swedish University of Agricultural Sciences, Box 7050, SE-75007 Uppsala, Sweden

\* Corresponding Author: [zhangw@kth.se](mailto:zhangw@kth.se)

**Keywords:** sand, dissolved organic carbon, pharmaceuticals, synthetic organic compounds

## INTRODUCTION

On-site sewage treatment facilities (OSSFs) are widely applied in rural areas in the Nordic countries. A potential amount of phosphorus (P) and nitrogen (N) are released from these systems every year. The concerns are also about micropollutants (MPs), i.e. pharmaceuticals and synthetic organic compounds which are contaminating the environment and can affect the ecosystem and human health (Luo, 2014). About 40% of the OSSFs in Sweden use soil-based systems to treat wastewater (Olshammar, 2015) and sand is the most commonly applied media. The aim of this study was to evaluate the removal efficiencies of P, N and a number of MPs in filter beds and to find out the potential additional treatment efficiency which could be achieved by combining sand with other commercial filter materials.

## MATERIALS AND METHODS

Two bench-scale column experiments were performed during 2016 (Table 1). The first experiment was operated with saturated flow conditions during two weeks. The second experiment applied unsaturated flow conditions and was operated during twelve weeks.

**Table 1.** Specification of the two column experiments

	Duration of experiment	Column		Pumping		Surface load	Feed water
		Diameter	Depth	Rate	Time		
	day	m	m	mL min <sup>-1</sup>	h day <sup>-1</sup>	L m <sup>-2</sup> ·day <sup>-1</sup>	
Experiment 1	14	0.05	0.1	1.14	2.25	78	Effluent from filter bed
Experiment 2	84	0.05	0.5	1.14	10.5	364	Effluent from septic tank

The wastewater used in the experiment was spiked with a number of MPs to investigate their removal by the sand filtration. The MPs included pharmaceuticals, pesticides, biocides, plasticizers, fragrances, surfactants, UV-stabilizers, rubber additives and food additives. Weekly samples were taken for N, P and MPs analysis. Other parameters measured during the experiments included dissolved organic carbon (DOC), pH, turbidity and electric conductivity.

A field pilot plant was constructed in 2013 (Kholoma, 2016) with three subsurface parallel filter beds. Each bed had a length and depth of 1.5 and 0.8 m, respectively, and an upper surface area of 0.75 m<sup>2</sup>. The three filter beds were filled with sand, biochar and sand, biochar and Sorbulite® (a product based on gas concrete), respectively. The system was maintained

for two and a half years prior the sampling (November 2016), where 24-hour composite water samples were taken from the influent and the effluent.

## MAIN RESULTS AND CONCLUSIONS

The average removal efficiencies of DOC, NH<sub>4</sub>-N and P<sub>tot</sub> in column and field samples are presented in table 2. Compared with the sand filter, the added biochar layer improved the removal of DOC by 18% and the added Sorbulite layer increased both the DOC and total phosphorus removal efficiencies by 7%.

**Table 2.** Average removal efficiencies (%) of DOC, NH<sub>4</sub>-N and total phosphorus

		DOC	NH <sub>4</sub> -N	P <sub>tot</sub>
Experiment 1	Sand	49	88	33
Experiment 2	Sand	73	9	16
Field sampling	Sand	31	84	22
	Biochar + sand	49	95	20
	Biochar + Sorbulite	38	78	29

The MPs in the column experiment showed different removal efficiencies: Firstly, biocides (hexachlorobenzene and triclosan), pharmaceuticals (acetaminophen and caffeine), fragrance (musk xylene) and preservative (propylparaben) have been efficiently removed with an average removal above 90%. Secondly, a few organophosphorus flame retardants such as tributylphosphate and triphenylphosphate, perfluoroalkyl substances, UV stabilizer (benzophenone) and fragrances (musk ketone and galaxolide) had lower removal efficiencies in the range 51% and 81%. The sand did not remove most of pharmaceuticals very efficiently. Seven out of the nine investigated pharmaceuticals had removal efficiencies ranging between 17% and 48%, whereas four of them (diclofenac, oxazepam, losartan and carbamazepine) had an average removal efficiency lower than 30%.

A number of 47 MPs were identified in the field experiment samples with concentrations ranging from 0.1 ng L<sup>-1</sup> to 46285 ng L<sup>-1</sup>. The removal efficiency varied depending on the type of filter media and MPs. The dual layer filter with biochar and sand provided a better removal of MPs (on average, 68%) than the other two filters (on average, 65% and 56% for sand and biochar + Sorbulite, respectively). In the future, to improve the removal efficiency of nutrients and MPs, the application of new filter materials to optimize the traditional filter bed is needed. The life span of sand and alternative sorbents were not considered in the column experiments, however it is one of the essential research tasks for future work.

## REFERENCES

- Kholoma, E., Renman, G., Renman, A., 2016. Phosphorus removal from wastewater by field-scale fortified filter beds during a one-year study. *Environmental Technology*, 37:23, 2953-2963.
- Luo, Y., Guo W., Ngo H. H., Nghiem L. D., Hai, F. I., Zhang J. & Liang S. (2014) A review on the occurrence of micropollutants in the aquatic environment and their fate and removal during wastewater treatment. *Science of the Total Environment*, 473-474 (March), 619-614.
- Olshammar M., Ek M., Rosenquist L., Ejhed H., Sidvall A. & Svanström S. 2015 Uppdatering av kunskapsläget och statistik för små avloppsanläggningar (Update of knowledge and statistic for small wastewater facilities). Report for the Marine and Water Authority, Sweden. SMED Report No. 166 2015.

# Integrated piggery wastewater and microalgal biomass production – a pilot plant case study

Ref # S2SMALL-271350

N.N. Cheng<sup>1\*</sup>, H.J. Fallowfield<sup>1</sup>

<sup>1</sup> Flinders University, College of Science and Engineering, GPO Box 2100  
Adelaide 5001, South Australia, Australia.

\* Presenting Author: [ryan.cheng@flinders.edu.au](mailto:ryan.cheng@flinders.edu.au)

**Keywords:** aerobic treatment, algal biomass, HRAP, microalgae, nitrification, piggery wastewater

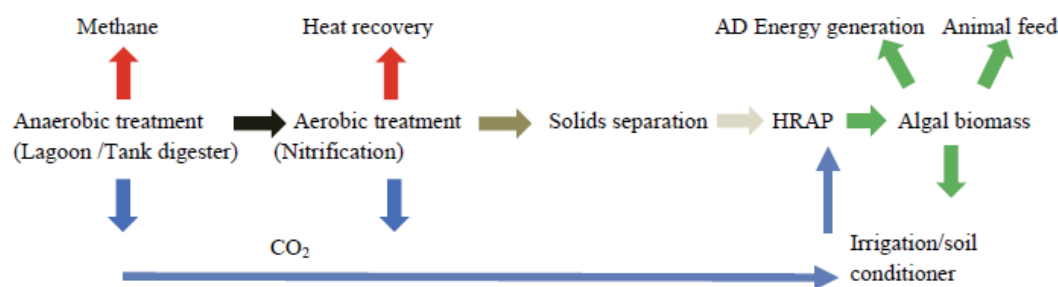
## INTRODUCTION

Currently, the overwhelming majority of Australia pork producers use lagoon systems for wastewater treatment. A small minority of producers have covered anaerobic lagoons to reduce emissions of the Greenhouse gas (GHG) methane from slurry. Buchanan *et al.* (2013) conducted a review: Algae for energy and feed: A wastewater Solution, commissioned by the High Integrity Australian Pork Cooperative Research Centre (CRC) and recommended that integrated wastewater treatment, incorporating aerobic treatment to condition slurry to enable algal growth for biomass energy production, was the approach most likely to enable the Pork CRC to meet its objective of reducing GHG emissions. As part of its Program 4, Carbon Conscious Nutrient Inputs and Outputs Research & Development program, the Australia's Pork CRC has set targets that include emissions of less than 1 kg of CO<sub>2</sub> gas per kg of pork produced in Australia.

In the review, the life cycle assessment (LCA) analysis indicates that rather than 'flaring' this renewable energy source the industry should be encouraged to exploit biogas for water or space heating or in combined heat and power systems thereby reducing fossil fuel usage and associated GHG emissions. A large range of advanced manure handling strategies were examined and only those strategies with real prospects of successful integration on-farm have been recommended for further study. Specifically the review recommends the integration of controlled, closed vessel aerobic treatment (with heat recovery), followed by solids separation to enable microalgal growth on anaerobic digester effluent. The LCA indicates that further wastewater treatment by microalgae, followed by additional energy recovery via co-digestion of the algal biomass with pig slurry is the option most likely to achieve the Pork CRC aspirational GHG emission target of 1kg CO<sub>2</sub> e kg HSCW<sup>-1</sup> (hot standard carcase weight) by 5% of the Australian pork industry. It is assumed that algae can be grown at a rate of 15g/m<sup>2</sup>/day on the effluent coming out of the anaerobic lagoon. There is evidence that this may not be possible due to a range of issues including ammonia which may inhibit algal growth and colour and other suspended solids which will affect the light penetration in the algae pond. An intermediate aerobic treatment process between the anaerobic lagoon and the high rate algal pond could vastly improve this water quality and a necessary component of any working system design.

Anaerobically treated pig slurry has high ammonia and suspended solids concentration which precludes using it as a substrate for the growth of microalgae for wastewater treatment, disinfection and sustainable biomass energy production. The objective of the research is to incorporate aerobic treatment of the slurry to convert the ammonia to nitrate using naturally occurring populations of aerobic nitrifying bacteria. Figure 1 shows the proposed aerobic

treatment strategy. After the pre-treatment by existing covered anaerobic lagoon (CAL) or in an engineered anaerobic reactor, the aerobic treatment was introduced to minimise the high total solid, colour, and high ammonia concentration by nitrification prior to feeding to a high rate algal pond (HRAP). In this operation, less energy will be required for aeration since much of the organic carbon would have been mineralised in the anaerobic system, most of the supplied oxygen being used for nitrification and heat might be recovered to offset electrical energy used for aeration. In addition, CO<sub>2</sub> would be used by algae growing in the HRAP. This will likely improve algal production on effluent since the pool of readily degradable organic carbon for conversion to inorganic carbon for photosynthesis may be depleted (Gonzalez-Fernandez *et al.*, 2011). The LCA shows that this configuration occurs only a small penalty compared with using only a CAL to treat the effluent but has the benefit, by oxidising ammonia to nitrate, of enabling algal biomass production which could be used to generate further methane and resultant electricity. The LCA suggests that this option has the potential to abate over 100kg CO<sub>2</sub> e 60kg HSCW (Buchanan *et al.*, 2013).



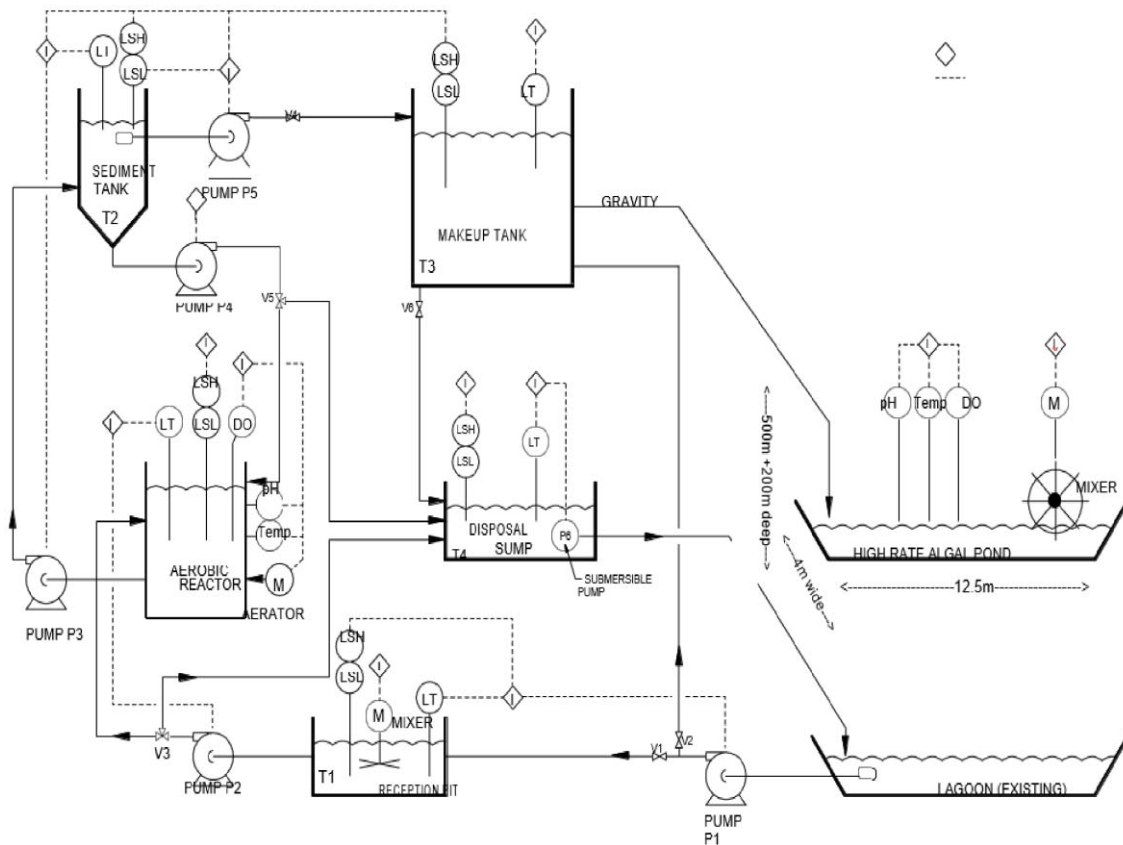
**Figure 1.** Conditioning piggery slurry for algal growth – integrated treatment with both aerobic and anaerobic to algal culture

This pilot plant case study is funded by the Australian Pork CRC and seeks to evaluate the performance of an integrated wastewater treatment (iWWTP) system incorporating, aerobic treatment with heat recovery and algal biomass production for energy and GHG abatement. This will assist the industry target of reducing CO<sub>2</sub> emissions and access financial benefit from Australia State & Federal GHG abatement schemes. The iWWTP will also produce a better disinfected effluent low in ammonia which, when reused for pig shed operations, is expected to reduce pig respiratory ill-health.

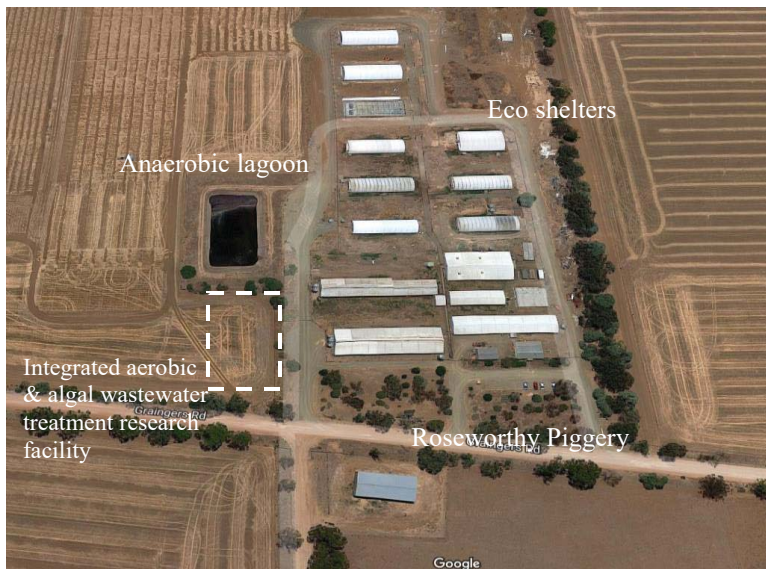
## METHIODS

The Roseworthy piggery in South Australia (34°30'47.9"S 138°40'47.5"E) was chosen and preliminary slurry analyses were conducted to enable design of the integrated wastewater treatment plant. The plant was constructed as shown in plate 1 and figure 2. Anaerobically pre-treated slurry from an existing lagoon is transferred to a reception pit on the research facility site. Pump activation is under liquid level control from the reception pit. Slurry from the reception pit is then delivered, at programmed intervals, to the aerobic reactor. By doing so, it incorporates aerobic treatment of the slurry to convert the ammonia to nitrate using naturally occurring populations of aerobic nitrifying bacteria and reduce its high ammonia load. Treated slurry from the aerobic reactor is pumped to a sedimentation tank and its supernatant liquid phase is delivered to a make-up tank. Finally, effluent from the make-up tank is then pumped to high rate algal pond for growth of algal biomass. The size of HRAP is approximately 25m<sup>2</sup> and its hydraulic residence time is determined by the rate of slurry addition and/or change in HRAP depth (maximum operating depth 0.5m). The HRAP is mixed by an eight bladed paddlewheel powered by an electric motor through a variable speed reduction gearbox. Treated HRAP effluent is returned to sump and then to the existing anaerobic lagoon prior to land spreading.





**Figure 2** Flinders University Roseworthy integrated aerobic & algal wastewater treatment research facility. LSH = Level switch high; LSL = Level switch low; LT = level transmitter; DO = Dissolved oxygen transmitter; pH = pH transmitter; Temp = Temperature transmitter; I = Connection to control system.



**Plate 1** Proposed location of the iWWTP at Roseworthy Piggery (indicated as broken line).

## RESULTS

Since construction work has commenced on April this year, the pond wall was built ready and the dam wall lining was in place on June. The major infrastructure are expected to be finished August this year. The aerobic reactor will then be commissioned. This initially will entail setting aeration rates and retention times necessary to achieve the required degree of carbon oxidation and nitrification.



**Plate 2** The outline of high rate algal pond with the completed dam wall and pond liner (June 2017).

There are three unit operations which need to be optimised and their performance evaluated - the aerobic reactor, the clarifier and the HRAP. The respective components will be evaluated for their effect on carbon oxidation/heat production,  $\text{NH}_4\text{-N}$  oxidation, suspended solids removal and algal biomass production; the disinfection potential of each unit operation will also be determined by measuring respective inlet and outlet values.

Optimising net energy production by the aerobic reactor and the production of an effluent suitable for algal biomass production is the focus of the research. This will entail understanding the relationship between retention time and the dissolved oxygen (DO) percentage saturation on carbon oxidation/heat recovery and nitrogen speciation in the aerobically treated effluent. Essentially the reactor will be operated under different combinations of retention time and aeration rate. At high percentage DO saturation ( $>10\%$ ), it is anticipated that  $\text{NO}_3\text{-N}$  will be the predominant source of N for algal growth, however, a consequence will be increased energy usage. Lower DO percentage saturations, reduce the aeration rate and energy consumption and enable simultaneous nitrification and denitrification, however,  $\text{N}_2$  gas is lost to the environment. An intermediate operation, with reduced energy consumption, may conserve more inorganic nitrogen in the effluent as  $\text{NO}_3\text{-N}$  with residual  $\text{NH}_4\text{-N}$  levels ( $\leq 150\text{mg L}^{-1}$ ) tolerable to algae, while minimising loss of  $\text{N}_2$  to the atmosphere. The oxidation of carbon and consequent heat production will be determined for all modes of operation investigated.

## CONCLUSIONS

Through this direct demonstration, farmers will be able to form an opinion about the relevance of the waste handling system to their own operations. Piggery waster should be considered as a recourse, which can be safely treated, potentially providing additional on farm energy, while reducing GHG emissions and producing high quality water for reuse in piggery operations.

## REFERENCES

- Buchanan A., Bolton N., Moheimani N., Svoboda I., Grant T., Batten D., Cheng N., Borowitzka M. & Fallowfield H. 2013 *Algae for energy and feed: a wastewater solution. A review* (Pork CRC Project 4A-101).
- Gonzalez-Fernandez C., Riano-Irazabal B., Molinuevo-Salces B., Blanco S., & Garcia-Gonzalez MC. 2011 Effect of operational conditions on the degradation of organic matter and development of microalgae-bacteria consortia when treating swine slurry. *Environmental Biotechnology*, **90**, 1147-1153

## **Alternative On-Site Wastewater Treatment Technologies to Reduce Biochemical Oxygen Demand, Total Suspended Solids, and Total Nitrogen from High Strength Commercial Wastewater**

Ref # S2SMALL-52516

Haase, Peter<sup>1,2\*</sup>, Sharp, Samantha<sup>1</sup>, and Ensminger, Bryce<sup>2</sup>

<sup>1</sup> Fall Creek Engineering, Inc., 1525 Seabright Avenue, Santa Cruz, CA 95062

<sup>2</sup> Acqualogic, Inc., 1525 Seabright Avenue, Santa Cruz, CA 95062

\*Presenting Author: phaase@fallcreekengineering.com

**Keywords:** Anaerobic baffled reactors; trickling filters; nitrogen removal

### **Abstract**

The Mission Spring Christian Camp and Conference Center is a full-service conference center that maintains a mixed use commercial facility and residential units in Scotts Valley, California. The conference center operates year-round with additional youth camps in the summer. An advanced biological treatment system was installed in 2014, replacing the original standard septic and gravity leachfield system. The system was designed by Fall Creek Engineering, Inc. with operations, maintenance, and monitoring completed by Acqualogic, Inc.

The wastewater treatment system includes several alternative wastewater treatment technologies aimed at treating high-strength wastewater influent to low effluent concentrations of biochemical oxygen demand (BOD), total suspended solids (TSS), and total nitrogen (TN). The wastewater treatment system includes flow equalization, an anaerobic baffled reactor, a 3-stage combined trickling filter and clarifier system (biofilter), recirculation, and solids return. Treated effluent is disposed to pressure leachfields. The treatment system is designed to manage a daily flow of 24,000 gallons per day (gpd) with a recirculation rate of 3 to 1. Summer flows increase up to 36,000 gpd with a recirculation rate of 2 to 1.

The wastewater system is regulated by the Central Coast Regional Water Quality Control Board and the County of Santa Cruz. The treatment system is required to reduce the 30-day average of BOD and TSS to less than 30 milligrams per liter (mg/L) each and reduce TN by 50%. In general, the treatment system has good performance and meets the treatment goals with over 90% removal of BOD and TSS, and over 50% removal of TN.

Challenges with treatment performance occur in the summer months, when average flows more than double compared to the rest of the year and the site experiences higher temperatures. Additional challenges occur during the winter months when the collection system experiences problems with inflow and infiltration (I&I). However, the system reliably meets the State Water Board water quality effluent requirements despite these issues.



## Introduction

The Mission Spring Christian Camp and Conference Center (Conference Center) is a full-service conference center, located in Scotts Valley, in Central California, United States. Figures 1 and 2 present the vicinity and site location maps.



Figure 1. Vicinity Map



Figure 2. Site Location Map

The Conference Center is a mixed-use commercial facility with staff and guest housing and youth camps. The property is located in an unincorporated part of Santa Cruz County on approximately 750 hectares of forested and mountainous terrain in the Santa Cruz Mountains.

The Conference Center is located at an elevation of 500 feet above mean sea level. The site is located in a Coastal Redwood forest and is bordered by two year round streams. The site receives an annual rainfall of 50 inches. The mean temperature fluctuates from 74°F in the summer months and 44°F during the winter months.

The Conference Center owns and operates private water and wastewater systems for the facility. The water system comprises of deep water supply wells, a groundwater treatment system to remove excessive iron and manganese, water storage, and a distribution system.

Historically, the facility used several individual septic systems that were installed in several locations across the property. Given the rural and relatively remote location of the community, there was not access to a municipal or centralized sewer system. The wastewater systems consisted of standard septic tanks and deep seepage pits (typically four (4) foot diameter by fifty (50) foot deep pits).

The facility is located in the San Lorenzo River Watershed, which is a water quality impaired watershed for nitrogen. Water from the river is a primary source of drinking water for the City of Santa Cruz, the main urban center in the watershed, which provides water to approximately 60,000 people in the city. Over the past 50 years, residential development in the San Lorenzo River watershed has expanded substantially, with a population of over 25,000 people that are served by onsite septic systems. The long-term use of onsite wastewater systems in the river valley has impacted water quality with elevated concentrations of nitrate as nitrogen. To address this impairment, in the early 1990's, the local County Health Department and the State Water Authority adopted a nitrogen management plan for the watershed. As part of the management plan the agencies adopted a 50% nitrogen reduction strategy for all new and existing commercial onsite wastewater systems in the watershed. The new rules required that when an existing facility had a wastewater system that failed or when the owners wanted to expand or substantially modify the facility, a new enhanced treatment system would be required to be installed.

In 2009, the Conference Center began to have intermittent problems with their original wastewater system. In 2010, the Conference Center retained a local engineering company to prepare a wastewater facility plan to begin to plan for the design and installation of a new centralized enhanced wastewater treatment and disposal system. In 2012, the Conference Center proceeded with the design and permitting of a new sanitary sewer collection system, an enhanced wastewater treatment system, and a pressure leachfield disposal system. In 2013, the Conference Center installed a new primary clarifier tank and a new lift station. In 2014, the Conference Center installed a new enhanced wastewater treatment system and disposal system.

This paper presents a description and a performance evaluation of the enhanced wastewater treatment system installed at the Conference Center.

### **Regulatory Requirements**

The wastewater system at the Conference Center is regulated by both the Local County Health Department and the State Water Quality Control Authority. The performance standards for the enhanced treatment system are as follows:

- Biochemical Oxygen Demand (BOD) < 30 mg/L;
- Total Suspended Solids (TSS) < 30 mg/L;
- Total Nitrogen (TN) Removal  $\geq$  fifty (50) Percent; and
- TN Loading Rate  $\leq$  40 grams/ac/day.

### **Section Criteria and Performance Goals**

Prior to selecting an enhanced wastewater treatment technology, the Conference Center and their consulting engineers completed a screening analysis of various treatment systems. Each system was compared based on several criteria including reliability, performance for BOD, TSS and TN removal, operation and maintenance requirements, and capital and O&M costs. Other factors

that were also considered in the selection of new wastewater treatment system included the flow variability, strength of the wastewater, and accessibility to the site.

The performance goals for the new treatment system were also selected and included the following:

- BOD and TSS Effluent < 10 mg/L
- TN Reduction  $\geq$  50% Removal for a loading rate  $\leq$  40 g/ac/day.

### **Design Criteria**

The Conference Center conducted flow and water quality studies during 2012 to support the design of the wastewater treatment system. The following is a summary of the primary design criteria data collected in that period:

- Daily Average flows = 10,000 – 15,000 gpd;
- Peak Summer Flow = 36,300 gpd;
- Influent Water Quality:
  - Total Nitrogen = 150 mg/L;
  - BOD = 1,000 mg/L;
  - TSS = 1,500 – 2,500 mg/L; and
  - Oil and Grease = 100 – 300 mg/L.

The results of the predesign studies indicated that the wastewater quality from the Conference Center was a high strength wastewater with high concentrations of BOD, TSS, TN, and oil and grease.

Flow monitoring also indicated that wastewater flows vary significantly seasonally. During the fall, winter and spring months wastewater flows range from 8,000 to 15,000 gallons per day. During the summer months when camps are at full occupancy flows can vary from 20,000 to over 36,000 gpd.

### **Enhanced Wastewater Treatment System**

In 2014, the Conference Center installed a new enhanced wastewater treatment system to meet the performance goals set by the Conference Center and the design team. The enhanced treatment system is a multi-stage biological treatment system that includes a 30,000 gallon anaerobic baffled reactor (ABR), a 2,000 gallon recirculation tank, and a three-stage bio-filtration system. Treated wastewater is discharged to three pressure dosed leachfield systems. Figure 3 presents the layout of the enhanced wastewater treatment system.



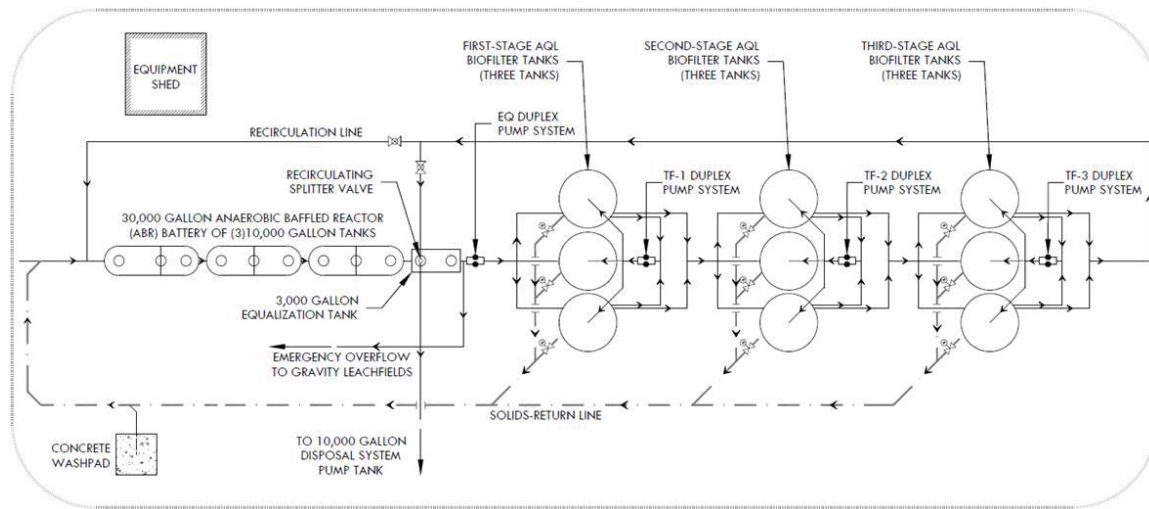


Figure 3. Enhanced Wastewater Treatment System Layout

### Anaerobic Baffled Reactor (ABR)

The primary treatment process of the system includes a 30,000 gallon ABR tank that includes a gravity flow tank configured with a battery of three 10,000 gallon tanks plumbed in series. The first tank consists of two compartments: the first compartment is approximately 7,000 gallons, and the second compartment has a capacity of 3,000 gallons. The second and third tanks consist of two compartments that are each 5,000 gallons. The outlet of each compartment is configured to convey flow from the top of the tank to the bottom of the tank so wastewater flows vertically in each compartment, creating an upflow sludge blanket in each compartment. This design provides for enhanced treatment of the wastewater by forcing the wastewater to flow through the biological sludge blanket rather than across it in a horizontal septic tank styled tank. The primary function of the ABR is to reduce TSS from the wastewater.

### Three-Stage Biofiltration System

Following the ABR the partially treated wastewater flows through a three-stage biofiltration system. The biofiltration system consists of three-stages of filters and each stage consists of three biofilters plumbed in parallel for a total of nine biofilter tanks.

The biofilter tanks are above ground in a unique stacked design that combines a trickling filter with a clarifier in a single tank vessel. The three-stages of biofilters are set up so that effluent from the ABR is pumped to the clarifier zone of the first stage of filters and then the effluent flows via gravity to the second and third stage filters. Recirculation pumps draw water from the clarifier and pump it over the biofilters on an intermittent dosing cycle (typically on for two minutes and off for one minute). The recirculation pumps are sized and setup to provide a recirculation rate of approximately 3:1 at each stage of filtration. A non-clogging spray nozzle distributes wastewater over the biomedica in each tank. Each tank is filled with 6 feet of engineered random trickling filter media that provides 30 square feet of filter area for each cubic foot of media.

Water from the trickling filter zone is collected in an under pan that directs the wastewater to an internal circular baffle in the clarifier under the filter zone to settle out any biosolids that slough off of the filters. The bottom of the clarifier is sloped to a trough in the center of the tank. A sludge outlet is on the bottom of the tank and the end of the trough and the outlet includes a 3-inch pipe that is fitted with an electronic actuated valve that is controlled by the treatment plants main controller. This solids return valve is opened up twice a week to flush out accumulated biosolids from the filter to the entrance of the ABR.

Effluent from the third-stage of the biofilters flows to a 2,000 gallon recirculation tank. This tank is fitted with a recirculation ball valve, which allows treated water to be recirculated through the biofilters and the system is set up to achieve a recirculation ratio of 3:1. Effluent that flows through the recirculation ball valves flow to an effluent pump tank that conveys the water to the pressure dosed leachfields.

### **Treatment System Performance**

A compilation of water quality data from early 2014 through 2016 was analyzed for this study to evaluate the performance of the enhanced treatment system. During the study period (2014 – 2016) 33 influent and effluent samples were tested for wastewater quality parameters including BOD, TSS, and TN.

#### *BOD Removal*

Over the sampling period the treatment system met the effluent standards for BOD on 24 events and on 9 events effluent exceeded the treatment requirements. Since the treatment system was brought online in 2014 it has on average achieved 94% removal of BOD. The data indicates that the treatment plant met the BOD requirements approximately 73% of the time. The BOD exceedances occurred during the summertime when flows were higher. Additionally, BOD influent concentrations are frequently higher than the 1,000 mg/L influent concentration for which the treatment plant was designed. Figure 4 is a graph comparing influent and effluent BOD concentrations in the plant. Figure 5 is a graph of BOD effluent concentration at a higher resolution.

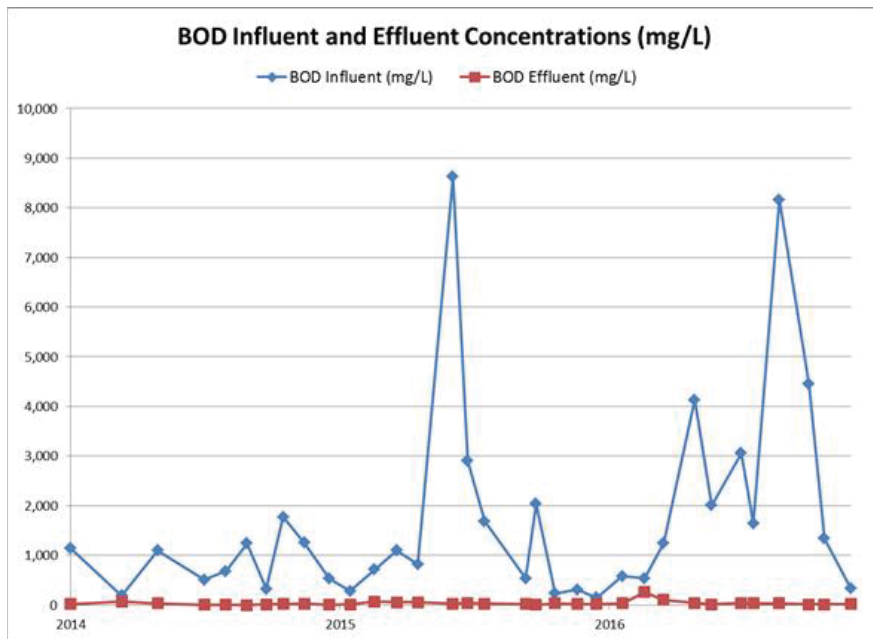


Figure 4. Influent and Effluent BOD

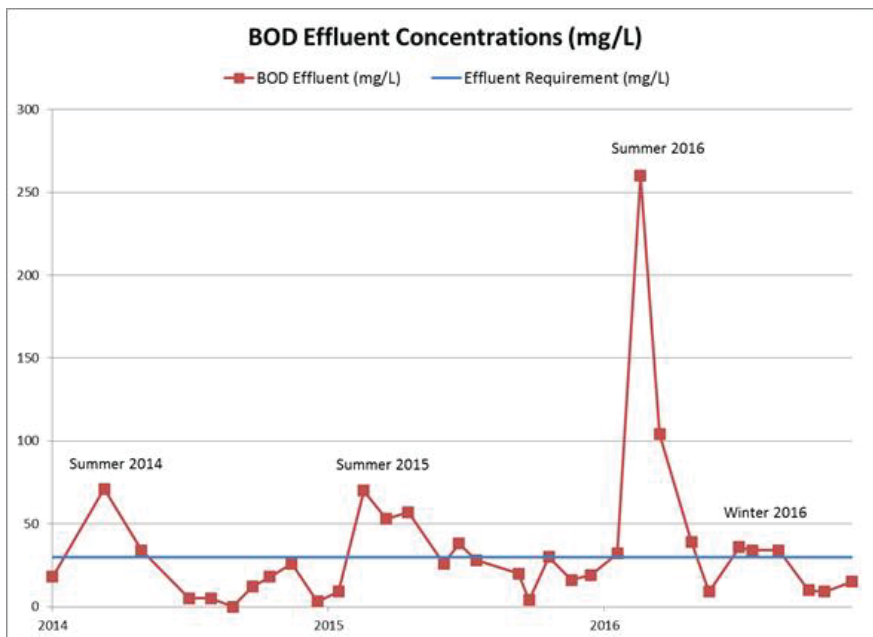


Figure 5. BOD Effluent Concentration

### TSS Removal

Over the testing period, the average TSS removal for the treatment plant was 99%. The treatment plant achieves very high removal rates of TSS as shown in both Figure 6 and 7. Over the testing period the TSS requirements were met 32 out of 33 sampling events indicating that the treatment plant met the requirements 97% of the time. Elevated effluent concentrations of TSS occur during the summertime when flows are higher. Increasing concentrations in influent TSS are likely due to solids accumulation in the collection system lift station tanks.

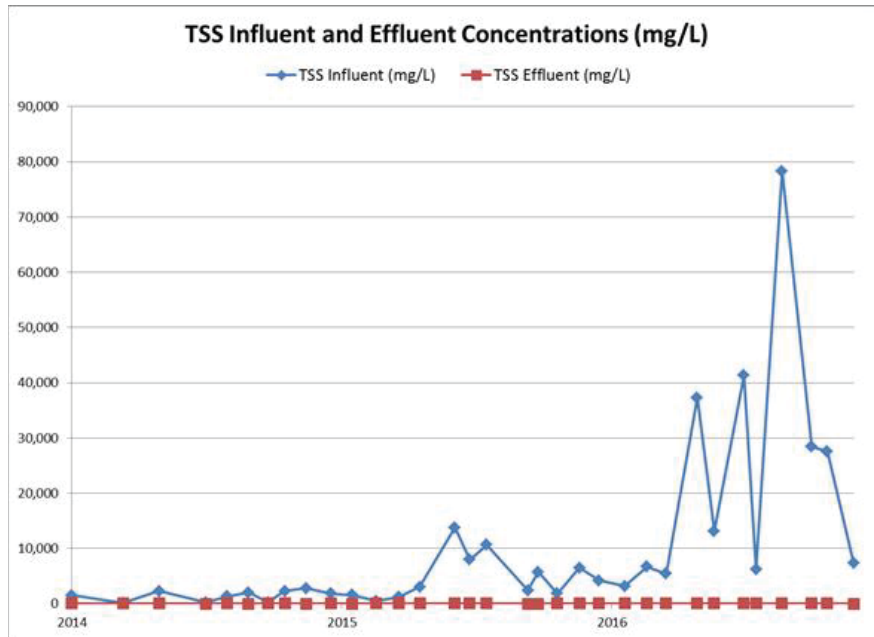


Figure 6. Influent and Effluent TSS

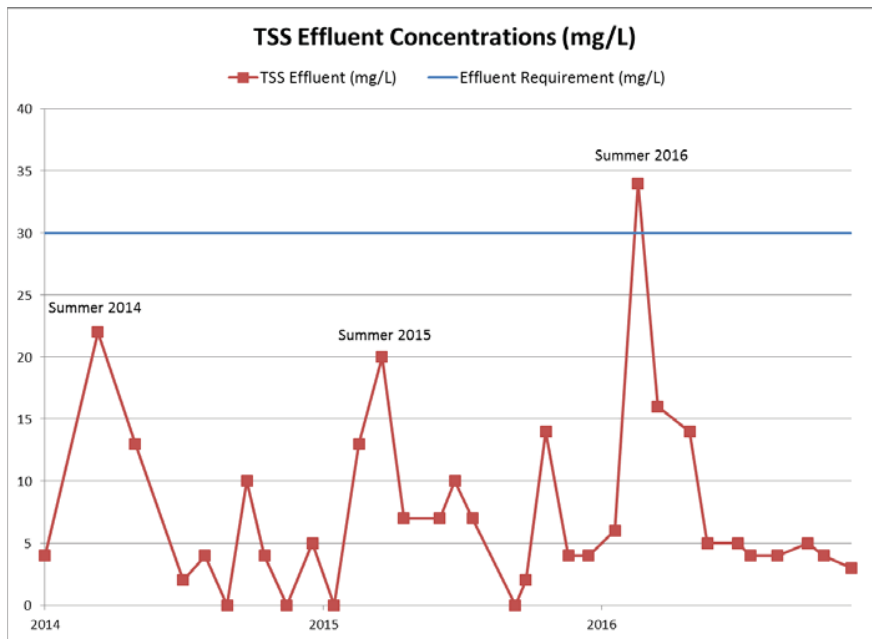


Figure 7. Effluent TSS Concentration

### *TN Removal*

The average TN removal of treatment plant over the testing period was 67%. The treatment plant achieves good removal rates of TN as shown in both Figure 8 and 9 below. Over the testing period the TN requirements were met 26 out of 33 sampling events indicating that the treatment plant met the performance requirements 78% of the time. TN removal performance has improved over time, likely due to improve operations of the treatment plant.

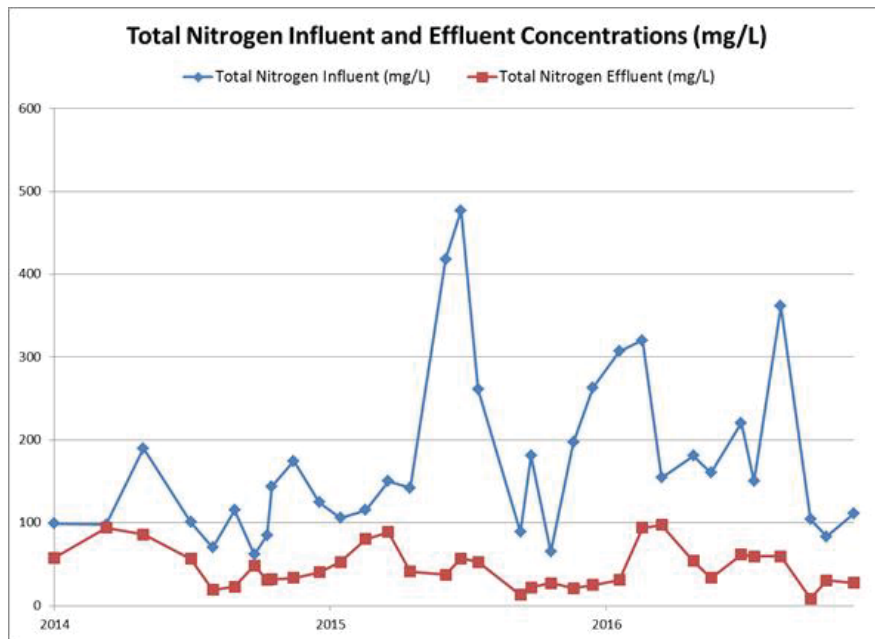


Figure 8. Total Nitrogen Influent and Effluent Concentration (mg/L)

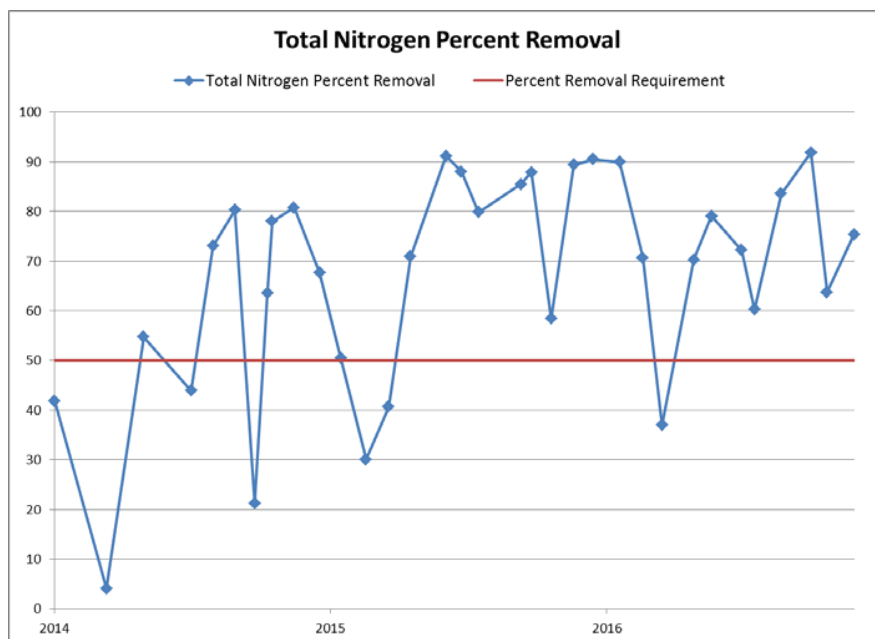


Figure 9. Total Nitrogen Effluent Concentration (mg/L)

### Capital and Operation and Maintenance Costs

The capital costs associated with construction of the wastewater treatment plant were \$350,000 in 2014. The total construction cost was \$1,200,000, which included improvements to the collection and disposal systems. The capital costs correspond to approximately \$10 per gallon of



wastewater treated, with the wastewater treatment plant designed for a flow of 36,300 gallons per day.

The operation and maintenance costs average \$4,600 per month. These costs include operations of the treatment plant, servicing and maintenance of the treatment plant equipment, monthly and semi-annual sampling and reporting, and daily monitoring and remote telemetry.

## **Findings**

Our findings from this study include:

1. The combined ABR and Acqualogic Biofilter treatment system is a low cost (capital and operations and maintenance) and effective treatment option for reduction of BOD, TSS, and TN.
2. An advantage of the treatment plant design includes little operator intervention is necessary. The same pump systems were installed throughout the treatment plant, which have proven to be reliable with no interruption in service since installed in 2014.
3. Another advantage of the treatment plant design is the inclusion of a remote telemetry system, which allows for daily monitoring of the treatment plant operations.
4. Challenges with the system occur from seasonal flow fluctuations including high summer flows from youth camps and inflow and infiltration (I&I) issues in the winter season.

## Recently emerging eco-friendly systems for wastewater purification:

### A review

Liu, R.B.<sup>1</sup>, Zhao, Y.Q.<sup>1,2</sup>

UCD Dooge Centre for Water Resources Research, School of Civil Engineering, University College Dublin,  
Belfield, Dublin 4, Ireland

School of Civil Engineering and Architecture, Xi'an University of Technology, Xi'an 710048, Shaanxi, P.R. China

**Keywords:** Wastewater treatment; Eco-friendly technologies; Green facilities; Pleasing appearance

### Introduction

Throughout the historical evolution of wastewater management, it can be roughly divided into two stages (Hellenistic, 2007). The first stage is the direct discharge into soil and water bodies in antiquity. The second as well as the current stage is the scheme of centralized collection and treatment. With the continuing increase of the population and urban sprawl, wastewater treatment is still facing great challenges and, therefore, two major actions have been taking worldwide to meet the situation. One is the urgency for upgrading the aging wastewater treatment plants (WWTPs) while another is the proliferation of the non-point pollutions and develop the eco-friendly processes/technologies (Huang et al., 2014). The challenge is that the increasing vast of wastewater and/or cost make the mode of “convergence and treat” more difficult. Indeed, the sustainable solution is to keep the wastewater treatment processes being part of the ecosystem, similar to the first stage, or impart them additional value.

By far, several eco-friendly processes have been proposed and studied with some being implemented already. Differentiating from conventional treatment systems, these processes partly or totally mimic the natural systems of purifying wastewater with artificial intensification. All these systems share several unique features: a) pleasing appearance and compatibility with surroundings; b) low capital & operation cost; c) priority of *in-situ* treatment. Given these highlighted characteristics, these eco-friendly processes were nominated as green facilities (GFs). Here, “green” describes, on the one hand, the sustainable operation mode with little energy or chemical requirement and, on the other hand, the visual appearance with various vegetation and plants. This review was to introduce and summarize the existing GFs in wastewater purification in terms of concept, highlights and *pros and cons*, respectively. It is believed that GFs represent one of the directions towards to sustainable wastewater treatment management.

### Green facilities

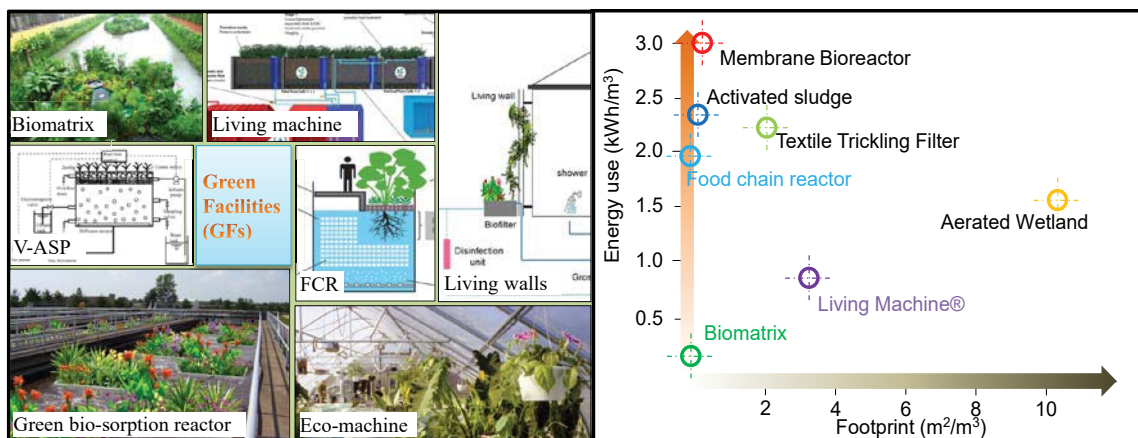
As depicted in Fig. 1, a number of GFs have been developed across the world. These facilities include food chain reactor (FCR) or fixed-bed biofilm activated sludge (FBAS), Living

Machine®, Solar Aquatics System, Biomatrix, vegetation-activated sludge process (V-ASP) and living walls, as well as the most recently green bio-sorption reactor (GBR) (Liu et al., 2017). The brief introduction and properties of each facility were summarized in Table 1. Obviously, owing to the pleasing appearance, these facilities could get involved in the biosphere and hydrosphere and thereby be more easily accepted by the public. Moreover, most of these facilities can be constructed as parts of the community and significantly reduce the footprint as well as the capital investment (Fig. 1). The high-standard effluent holds the potential to reclaim and reuse on-site and at the same time these facilities really offer residents a good place for fun and knowledge.

Table 1 Summarization of the GFs

Reactor	FCR	GBR	LM	V-ASP	Biomatrix	LW
Maturity	Full-scale	Lab-scale	Full-scale	Lab-scale	Full-scale	Full-scale
Influent	wastewater				Surface water	Grey water
Key parts	Fiber & roots	P-adsorptive carriers & activated sludge	Normal matrix	Activated sludge and roots	Fiber & roots	Normal matrix
Application	Various scale <sup>1</sup>	NA <sup>1</sup>	Community scale <sup>2</sup>	NA <sup>1</sup>	Various scale <sup>2</sup>	Single building <sup>2</sup>

<sup>1</sup>, centralized mode; <sup>2</sup>, decentralized or on-site mode; NA, not available



**Figure. 1** Schematic diagram of GFs and comparison of operation cost (V-ASP, vegetation-activated sludge process; FCR, food chain reactor)

**References**

Hellenistic, I., 2007. Historical Development of Wastewater Collection and Treatment. *Water Supply* 1–24.

Huang, N., Su, B., Li, R., Yang, W., Shen, M., 2014. A field-scale observation method for non-point source pollution of paddy fields. *Agric. Water Manag.* 146, 305–313.

Liu, R., Zhao, Y., Zhao, J., Xu, L., Sibille, C., 2017. Embedding constructed wetland in sequencing batch reactor for enhancing nutrients removal. *J. Environ. Manage.* 192, 302–308.

**Parallel session 7 - Ressource Oriented Sanitation systems 1**

09:50-11:10

Session chair: Heribert Rustige

**302 - High time to normalize 'alternative' sanitation models in engineering curricula**

OBERG Gunilla - *IRES, UBC, Vancouver, Canada*

**288 - Economic feasibility assessment of integrated sanitation systems for Uganda Christian University**

AGUNYO Miria Frances - *Europa University Flensburg*

**481 - Impacts of urban typologies on efficiency of source-separation systems with decentralized treatment**

BESSION Mathilde - *LISBP-INSA*

**479 - Water Hub @ NEST: Practical Implications of Source Separation**

ETTER Bastian - *Eawag*

**Parallel session 8 - Ressource Oriented Sanitation systems 2**

11:30-12:50

Session chair: Stéphane Troesch

**297 - Vermifiltration toilets as an on-site household sanitation option**

TEMPLETON Michael - *Imperial College London*

**637 - Sustainable sanitation mangement tool to decision making in isolated areas in Brazil**

PAULO Paula - *Dom Bosco Catholic University*

**487 - Optimizing chlorination and electrolysis dosages for hand washing water recycling post-treatment**

LARIVE Odile - *Eawag*

**503 - Evaluation of the hygienization at composting toilets in remote areas**

WEISSENBACHER Norbert - *University of Natural Resources and Life Sciences, Vienna*

**Parallel session 9 - Water Reuse 1**

14:00-15:00

Session chair: Eran Friedler

**285 - Local Sustainability! - Insights from On-site Wastewater reuse plants around the globe**

LAHAV Yotam - *Aqwise*

**502 - Sanitation and Water Reuse for urban gardening in informal settlements. Lessons learnt from a systemic approach in Namibia**

SINN Jochen - *Technische Universität Darmstadt*

**655 - Wastewater Reuse for Irrigation – unconventional or un-welcome resource? Local perceptions on barriers and drivers for reuse in Egypt, Morcco and Tunisia**

KER RAULT Philippe - *Wageningen Environmental Research*

**Parallel session 10 - Water Reuse 2**

15:20-16:20

Session chair: Eran Friedler

**462 - Treated Domestic Greywater Reuse and Associated Health Risks - Integrated with Green Wall Structure for Hydroponic Lettuce Production**

EREGNO Fasil Ejigu - *PhD Candidate*

**473 - A preliminary survey on public attitude for the reuse of grey water as an alternative source of water in Turkey**

EFE Hilal - *Istanbul Technical University*

## High time to normalize 'alternative' sanitation models in engineering curricula

**Öberg, G. and Banks, C.**

Institute for Resources, Environment and Sustainability, University of British Columbia, 2202 Main Mall, Vancouver, V6T 1Z4 B.C. Canada.

**Keywords:** sustainable sanitation, rapid urbanization, engineering curricula reform

### Introduction

Research communities dedicated to solving the sanitation crisis in rapidly growing urban areas are well aware that large-scale infrastructure that builds on the linear end-of-pipe model (water toilet to sewer to treatment plant) is quixotic in the deepest sense of the word (Black and Fawcett 2010). The conventional model is simply too inflexible and too costly to construct, operate and maintain for the majority of rapidly growing urban communities: Provision of safe sanitation to the exponentially growing number of urban inhabitants calls for the development of other models. This requires that the lock-in to the conventional model is broken.

The sanitation sector leans heavily on engineering and it is reasonable to assume that the solution, or at least a central part of it, lies in the content and structure of engineering curricula. Sanitary engineering was born in response to societal changes in the late 19<sup>th</sup> to early 20<sup>th</sup> century (Anderson 2003) and the curriculum has since successively been altered in response to changing societal concerns and expectations (Malina, Jr, and Gloyna 2007; Leonard 2001; Heaney 2012). This responsiveness is illustrated by the common name-change from sanitation engineering to environmental engineering (Iyer-Raniga and Andamon 2012; Logsdon 2008; Hansen and Kells 2002).

The question raised in this paper is if present-day curricula reforms have been sufficiently responsive to incorporate the challenges caused by the unprecedented rapid and haphazard urbanization that is taking place at an accelerating rate across the globe, and thus properly prepares students to that end. We analyze the content and framing of urban sanitation in the curricula of our own university - UBC - as well as that from leading engineering schools and discuss how it might be revised to drive innovation and change.

### Material and Methods

Leading engineering schools were identified based on official ranking lists (2015-2016 Times Higher Education World, QS World Ranking by Subject 2016, Best Global Universities for Engineering US News 2017, ARWU-Engineering 2016). Four top-schools that had course material available on their websites were chosen (MIT, University of California Berkley, Stanford and NTU). Courses dealing with issues related to urban sanitation were identified through searches using terms such as wastewater, water, sanitation, sewage, environmental, public health, pollution. Course syllabi including core literature were reviewed and a content analysis was carried out to determine how urban sanitation and future challenges are framed.

## Results and Discussion

Our study suggests that engineering curricula implicitly frame the conventional model as the norm while anything else is framed as 'alternative'. Few of the analyzed mandatory courses include content related to challenges that are tied to the rapid and haphazard urbanization. Generally, such questions are left to higher level electives or the graduate level.

We propose that the framing of the conventional model as the norm strongly contributes to the prevailing lock-in to the status quo. To meet the challenges tied to service provision in an increasingly urbanized world, we need to attract brilliant, innovative and creative minds that are trained to think outside the box (Wood 2016). We argue that the challenges of present-day urban sanitation and the shortcomings of the present paradigm need to be placed at the forefront and taught in the very first years, rather than, as now is commonly the case, provided as 4th year electives or at graduate level. We conclude that it is unrealistic to expect that today's curriculum will lead to lasting innovation beyond the conventional.

## References

- Anderson, W C. 2003. "A History of Environmental Engineering in the United States." *Environmental and Water Resources History*. Reston, VA: American Society of Civil Engineers, 1–12. doi:10.1061/40650(2003)1.
- Black, Maggie, and Ben Fawcett. 2010. *The Last Taboo*. Routledge.
- Hansen, David, and J A Kells. 2002. "Environmental Engineering Education in Canada: Discussion." *Canadian Journal of Civil Engineering* 29 (1): 185–87. doi:10.1139/l02-004.
- Heaney, James P. 2012. "History of the Department of Environmental Engineering Sciences, University of Florida." In, 29–35. Reston, VA: American Society of Civil Engineers. doi:10.1061/40928(251)4.
- Iyer-Raniga, U, and M Andamon. 2012. "Sustainability Education in the Engineering and Built Environment Curriculum: the Case for Asia-Pacific." *5th International Conference of ...*
- Leonard, Kathleen M. 2001. "Brief History of Environmental Engineering: ``the World's Second Oldest Profession". In, 389–93. Reston, VA: American Society of Civil Engineers. doi:10.1061/40594(265)47.
- Logsdon, Gary S. 2008. "The Future of Environmental Engineering Education." *Journal of Environmental Engineering Science*, April, 1–4.
- Malina, J F, Jr, and E F Gloyna. 2007. "History of Environmental Engineering at the University of Texas at Austin." *Environmental and Water Resources: ....* Reston, VA: American Society of Civil Engineers, 36–43. doi:10.1061/40928(251)5.
- Wood, Alison P. 2016. "Multidisciplinary Thinking to Increase Sustainability in Engineering: a Case Study in Sanitation," May, 1–218.



# Economic Feasibility Assessment of Integrated Sanitation Systems for Uganda Christian University

Ref # S2SMALL-38477

**Miria Frances Agunyo\***, **Prof.Jens Born**<sup>2</sup>

\* *Interdisciplinary Institute of Environmental, Social and Human Sciences in Europa  
Universität Flensburg, Munketoft 3b, 24937 Flensburg Germany.* Presenting Author:  
anomotmiria@gmail.com

<sup>2</sup> *Flensburg University of Applied Sciences, Kanzleistr. 91-93, 24943 Flensburg, Germany.*

## Abstract

Management of organic waste streams from various source points including institutions of learning in Uganda can be a challenge if proper sanitation systems are absent. Given that various organic waste streams may be generated, an integrated sanitation system approach which considers combined management of the waste streams while additionally recovering resources in the form of biogas and organic fertilizer could be a viable solution. Attractive as the approach may seem, investigating the economic viability of such sanitation systems would avail the necessary information, guiding decision makers on system selection. A cost benefit approach was applied to assess the economic feasibility of integrated sanitation systems for Uganda Christian University in Uganda.

**Key words;** integrated sanitation systems, economic feasibility assessment, net present value, pay back period, internal rate of return

## 1. Introduction

Often the case, sanitation interventions or projects, attempt to link impacts of poor sanitation to economic losses while concurrently assessing economic returns associated with reducing the burden of health and the impact on the environment. Moreover, impacts associated with people's/citizens' lost time and their productivity as a result of poor health and environmental impacts from the related interventions or projects are taken in to consideration (TBC 2016; WSP 2008; McIntyre et al. 2014). Based on such a background, it is common that the economic assessment of sanitation system alternatives or options endeavour to incorporate life cycle costs and benefits (WSP 2008, 2011; Hutton 2015). In this paper, a similar approach of incorporating the related costs and benefits of a sanitation system is applied to enable assessment of system alternatives.

## 2. Case Study

Uganda Christian University (UCU), Mukono like most institutions of higher learning in Uganda is mandated to manage her own waste. The University has an own activated wastewater treatment plant (WWTP), which manages wastewater from various source points within the University and the plant currently operates at half its capacity. Plastic waste generated is sorted and recycled while kitchen waste is used as animal feed by local farmers neighboring the University. Meanwhile, other solid waste is either incinerated at UCU or disposed of at Mukono Municipal landfill, which is located about 7km from the University campus. UCU currently experiences difficulty in the final disposal of sewage sludge, where about 70% of the partially stabilized sewage sludge is left in lagoons which are located at the WWTP. The remnant 30% of the partially stabilized sewage sludge is used as soil conditioner by UCU on the sports field, while a portion of the sludge is also used by interested local farmers' neighbouring the University as soil conditioner. UCU heavily depends on firewood for cooking and is interested in utilizing cleaner energy source such as biogas. In her 6year strategic plan (2012-2018), UCU proposes that biogas could be produced by management of organic waste streams such as sewage sludge (UCU 2012). Moreover, UCU also owns a farm which has been leased to a dairy farmer and this could be an additional source of organic waste in the form of cow dung. Noteworthy is that Mukono Municipality does not have a centralized WWTP or faecal sludge treatment plant nor is it connected to the National Water and Sewage Corporation (NWSC) sewer network.

The most commonly used sanitary facilities within Mukono Municipality consist of onsite pour flush toilets which are connected to septic tanks and pit latrines (Kanathigoda 2014). These onsite facilities are used in homes, business or institutional settings however, further management of sewage and faecal sludge from these facilities is required. The absence of faecal management facilities within Mukono Municipality poses as major challenge since interested customers would have to consider hiring cesspool emptiers to transport the sludge to the nearest faecal sludge management plants, which are located in Kampala at least 22km from Mukono. The fact that the **WWTP** at UCU operates at half its capacity implies that opportunities exist for possible management of the faecal sludge from neighbouring areas in Mukono at UCU. With reference to the background of the case study area, focus is drawn to the management of organic waste streams generated from UCU and neighbouring area of Mukono. The organic waste streams considered include sewage and faecal sludge, animal excreta, 'biowaste and wastewater effluent. Given that UCU experiences a challenge in managing sewage sludge and yet opportunities exist to further manage other organic waste streams i.e cow dung, kitchen waste and faecal sludge while generating biogas, an integrated sanitation system approach is considered a viable solution. Provided that the management of different organic waste streams would be involved, variable technologies/processes would be required to manage the waste. Mostly, sanitation systems which may consist of a single technology or combinations of technologies/processes are designed to ensure management of the various waste streams. In the context of this paper, the integrated sanitation systems consider combined management of the organic waste streams mentioned using a combination of anaerobic digestion technologies and other technologies/processes such as incineration, composting and solar drying among others. With reference to this suggestion, six sanitation system alternatives were proposed for the management of waste streams mentioned.

### 3. Sanitation System Alternatives

The *Status Quo* alternative which represents the current sanitation system at UCU with a few modifications. The system alternative consists of pumping the sewage sludge from the **WWTP** to the gravity settling tank prior to partial stabilization of the sewage sludge in the lagoons. Also, application of 30% of the partially stabilized sewage sludge as conditioner and dumping of 70% of the residual sewage sludge in the lagoons. Other considerations in this system boundary included; utilization of food waste (**Fw**) from the kitchen as animal feed and application of cow dung (**Cd**) from the University farm in gardens or dumping the dung in the animal kraal.

The **COMPAD** alternative system boundary consists of pumping the sewage sludge from the **WWTP** to the gravity settling tank and partial stabilization of sewage sludge in the lagoon. Thereafter, co-composting of the sewage sludge from the lagoon with other organic waste was considered and the compost generated would be utilized as soil conditioner. Furthermore, the pretreatment of food waste (**Fw**) from the kitchen and mixing it with cow dung (**Cd**) prior to anaerobic co-digestion was considered. Utilization of biogas that would be produced from the anaerobic digestion process was examined with reference to two scenarios i.e. direct utilization of the biogas as cooking fuel (**BfC**) or for cogeneration (**CoGen**) of electricity and heat from the **CHP** unit. Meanwhile, the application of digestate that would be generated from the anaerobic digestion process as organic fertilizer was included within the system boundary. Therefore, substitution of electricity from the national grid, thermal energy generated from firewood for cooking and mineral fertilizers were also included in the **COMPAD** alternative boundary.

The **COMPAD LF** alternative boundary considered was similar to the **COMPAD** alternative with the exception that the co-composting process would be carried out at Mukono Municipal landfill instead of at UCU campus. Thus, transportation of the partially stabilized sewage sludge to Mukono Municipal landfill, which is located about 7km away from the University campus was included within the boundary. Other processes such as the anaerobic digestion process would be similar to that of the **COMPAD** system alternative.

The **INCAD** alternative boundary consisted of similar components to the **COMPAD** alternative with the exception of drying the partially stabilized sewage sludge from the lagoon prior to incineration. In addition, the anaerobic digestion process of cow dung and food waste would still be considered within the system boundary. Thus, all by-products from the anaerobic digestion process i.e biogas and digestate would be managed in a similar way as for the **COMPAD** and **COMPAD LF** alternatives.

The **INTEG 1** alternative boundary consisted of pumping the sewage sludge from the **WWTP** to the gravity settling tank where dewatering of the sewage sludge (**Os**) would take place. Similar to the **COMPAD** alternative, pretreatment of food waste prior to mixing it with cow dung and dewatered sewage sludge (**Os: Cd: Fw 30:20:50**) was considered. Thereafter, a mixture of sewage sludge, food waste and cow dung would be anaerobically digested producing biogas and digestate. The biogas produced would be managed in a similar manner as the **COMPAD**, **COMPAD LF** and **INCAD** alternatives, while the digestate would be directed to the lagoons where partial stabilization would take place prior to solar drying to improve the quality of the organic fertilizer produced. The substitution of firewood, grid electricity and mineral fertilizer production processes were also included in **INTEG 1** boundary.

The **INTEG 2** alternative boundary was similar to the **INTEG 1** alternative and additionally considered faecal sludge (**Fs**) as one of the substrates that would be anaerobically digested. Thus, the substrate mixture of composition **Fs:Os:Cd:Fw 10:20:20:50** was considered. Furthermore, the **INTEG 2** alternative boundary included utilization of 40% of the solar dried digestate for briquette making while 60% of leftover digestate was considered for use as organic fertilizer. The substituted processes considered for the **INTEG2** alternative were similar to those considered for **INTEG 1** alternative. Moreover, substitution of firewood with briquettes made from digestate was additionally included in the boundary. For all the sanitation system alternatives which consisted of the anaerobic digestion process, two scenarios were considered i.e utilization of biogas as cooking fuel (**BfC**) or cogeneration (**CoGen**) of electricity and waste heat. Furthermore, the heat generated from the **CoGen** scenario was considered for heating water, which would later be utilized for cooking purposes. Generally, for all sanitation system alternatives which consisted of an anaerobic digestion unit, substrate/feedstocks are identified and pretreated prior to anaerobic digestion. The by-products from the anaerobic digestion process are then managed variably with biogas being utilized either directly as a cooking fuel or for cogeneration of electricity and heat. The digestate generated can be considered directly as fertilizer or further post treated, resulting in much more portable organic fertilizer and or briquettes.

#### 4. Methodology

Having defined the sanitation systems proposed for **UCU**, a cost benefit approach was used to carry out their economic assesment. Moreover, computation of parameters such as the net present value (**NPV**), payback period (**PBP**) and internal rate of return (**IRR**) were also considered so as to have a more comprehensive assessment. Thus, in addition to incorporating all the potential sanitation system component installation and operation costs, the business case of the sanitation systems was also argued based on the economic returns associated with reducing environmental impacts and the burden on health reflected as well as citizens' lost time and productivity (McIntyre et al. 2014; WSP 2008). Moreover, returns associated with potential resource recovery from management of the various organic waste streams were additionally considered. The three parameters used were further defined as; the **NPV** is the sum of all cash flows discounted for the given duration thus, the time value of money is recognized using **NPV**, which is computed according the Equation 1.

$$NPV = \sum_{t=1}^T \frac{C_t}{(1 + r)^t} - C_0 \quad \dots\dots\dots \text{Equation 1}$$

Where **NPV** is the net present value of the sanitation system (s), **C<sub>t</sub>** is the cash flow of the investment for the duration **t**, **C<sub>0</sub>** is the initial investment for the sanitation system, **r** is the discount rate (%), **t** is the time period from the first year to **T** years.

The **IRR** which is the discount rate when the after-tax **NPV** is zero is computed according to Equation 2.

$$0 = \sum_{t=1}^T C_t (1 + IRR)^{-t} - C_0 \dots \dots \dots \text{Equation 2}$$

Where **IRR** is the internal rate of return of the sanitation system (s),  $C_t$  is the cash flow of the investment for the duration  $t$ ,  $C_0$  is the initial investment for the sanitation system,  $t$  is the time period from the first year to  $T$  years.

The **PBP** basically compares revenues with costs and determines the duration required to recoup the initial investment of a given project and is computed according to Equation 3.

$$PBP = \frac{\text{Initial investment}}{C_t} \dots \dots \dots \text{Equation 3}$$

Where  $C_t$  is the cash flow of the investment in time period  $t$  (s) and **PBP** is the payback period (Brent 2006; Yiridoe et al. 2009)

### 5. Data Sources and Analysis

The data used for the economic assessment of the sanitation system alternatives was obtained from key informants and observation during fieldwork carried in Uganda. Additional data relevant to the anaerobic process considered in the various system alternatives was also obtained through experimental analysis, where characterization of the organic waste streams as well as biogas yield analysis was carried out. Finally, reference to existing literature related to economic feasibility of biogas plants as well as costing of biogas plants and sanitation systems also enabled the relevant cost estimation for the system alternatives considered (Karellas et al. 2010; Pantaleo et al. 2013; Otoo et al. 2015). Comprehensive estimation of costs for the sanitation system components of each sanitation system alternative, taking into consideration the substrate composition, process or technology combinations and the various inputs and outputs was carried out. Thereafter, the potential benefits accrued from resource recovery in the form of biogas and digestate considered as organic fertilizer were evaluated.

During the assessment, environmental benefits specifically associated with reduction in green house gases (**GHGs**) and health benefits related to improved sanitation from the respective system alternatives were additionally included to ensure comprehensivity (Ackerman 2008; Weimer 2008). The environmental benefits were represented by the reduction of **GHGs** for respective sanitation systems and this was mostly attributed to recovery of biogas from the anaerobic digestion process. Meanwhile, the health benefits associated with the respective sanitation system alternatives were computed based on guidance from literature, which suggests that waterborne and sanitation related diseases consist mainly of infectious diarrhoea. Although the disease burden due to poor sanitation could include other diseases, infectious diarrhoea is considered the cause of the main global burden resulting from poor access to water supply and sanitation. The availability of regional and national data on diarrhoea incidence rates and deaths also contributed to investigations of the health benefits of sanitation interventions with reference to reduction in diarrhoea incidence (Hutton, Haller 2004; Hutton et al. 2007; Hutton 2012, 2015). Therefore, with reference to such a background, the economic benefits associated with improved sanitation services were assessed based on three key points summarized.

- Savings related to seeking less health care. In this case, health care savings are estimated as a function of treatment seeking rates and medical practices as well as unit costs of medical services.
- Savings related to productive time losses from disease. The productivity losses are often estimated based on disease rates in addition to the number of days a patient of care taker could be absent from productive activities and the unit value of productive time.

Taking into account the stringent data requirements to estimate specifically financial losses from lost productive time, the common practice considered is that an economic value is given based on the sick person's age.

- Finally, savings related to reductions in premature mortality are considered. In this case, mortality is valued using the human capital approach, where estimation of the value of a premature death averted is considered.

To enable the economic assessment of the sanitation system alternatives proposed for UCU, a Microsoft Excel tool was developed and used. At the initial stage, computation of the available substrate quantities was carried out for the anaerobic digestion unit, then the annual biogas amounts for the specific system alternatives was determined. Computation of the biogas amounts was based on substrate characteristics such as the total solids (TS) and volatile solids (VS), which were determined through experimental analysis and reference to literature (Al Seadi et al. 2008; Vögeli et al. 2014). Thereafter, other costs and benefits related to the environmental and health aspects of all sanitation system alternatives were also computed. **Error! Reference source not found.** shows the substrate estimates and the respective characteristics considered for computing the annual biogas amounts.

**Table 1: Summary of Available Substrate/Feedstock**

Substrate/feedstock type	Input Tons/year	TS %	VS%
Food waste	202.23	53.69	52.30
Cow dung	208.53	36.14	27.66
Sewage Sludge	486.68	10.56	7.81
Faecal sludge	243.34	8.52	6.30

**Source:** Author

The assessment also included examination of the implementation and operation of key components considered for the management of organic waste streams in the respective sanitation system alternatives. As such, estimation of the initial investment costs for the sanitation system alternatives was carried out. The estimation of investment costs was informed by supplier information for the various components proposed for the sanitation system alternatives. This information was obtained from UCU and other suppliers interested in offering related services. In addition, information was obtained from relevant literature related to various process/technology installations suggested in the system alternatives (Walla and Schneeberger 2008; Pantaleo et al. 2013; Karellas et al. 2010; Pantaleo et al. 2013; Walekhwa et al. 2014; FEA 2014; GIZ 2016). With reference to the information obtained estimation of the operating costs which comprised of net operating costs, maintenance and financing in addition to insurance costs was carried out for each of the sanitation system alternatives. Moreover, the computation of the benefits for the respective sanitation systems additionally factored in the environmental and health benefits already discussed. All estimations were converted to Uganda Shillings (UGX) from Euros (€). The total discounted costs and revenues were then applied for computation of the NPV, IRR, PBP and a sensitivity analysis was carried out as discussed at a later stage.

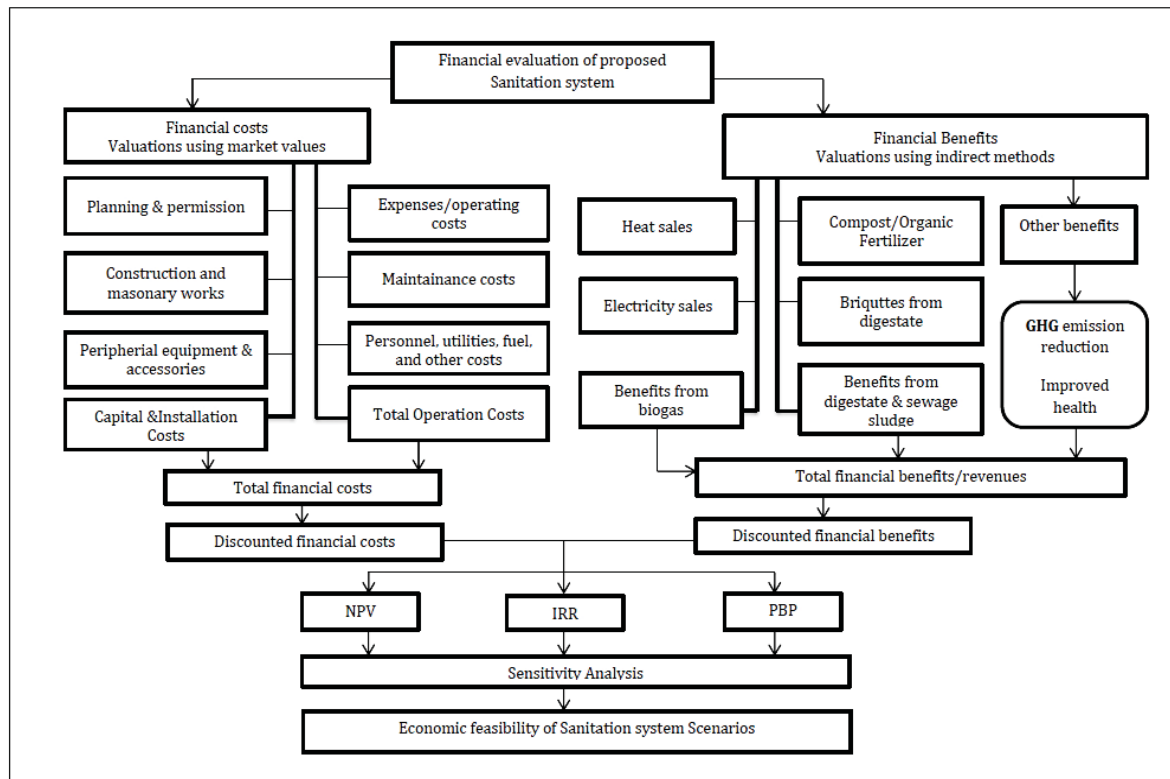
## 6. Main Assumptions considered

The computation of all costs and revenues was based on the following key assumptions;

- Equity capital was assumed as 30% of the investment costs for the sanitation systems.
- Fugitive emissions from the biogas plant/anaerobic digestion unit accounted for 7% the biogas amount generated.
- An interest rate of 10% was used and this was based on key informant interviews from GIZ - Uganda and Uganda Energy Credit Capitalisation Company (UECCC).
- While the loan payback period was assumed to be 10 years.



For all sanitation system alternatives which consisted of an anaerobic digestion unit, two scenarios were considered i.e.; utilization of biogas directly for cooking (**BfC**) and utilization of biogas for cogeneration (**CoGen**). **Error! Reference source not found.** shows an overview of procedure adapted for assessment of the economic feasibility of the sanitation system alternatives proposed for UCU.



**Figure 1:** Framework for the economic feasibility assessment of sanitation system alternatives proposed for UCU.

## 7. Discussion of Results

Reference can be made to **Error! Reference source not found.** for the overall assessment of the sanitation system alternatives. Taking into consideration the **CoGen** scenario while additionally incorporating the **Status Quo** system alternative, which does not consist of anaerobic digestion unit, the performance trend with reference to the NPV parameter showed that the **INTEG 2** alternative performed best followed by **COMPAD LF**, **INTEG 1**, **COMPAD**, **INCAD** and finally the **Status Quo** alternative. The performance of the alternatives was influenced by the annual income accrued by the system alternatives. Thus, the higher the annual income, the better the system alternative performed. The good performance of the **INTEG 2** alternative in comparison to all other sanitation system alternatives was attributed to additional revenues accrued from greenhouse gas (GHG) emission reduction and sale of briquettes made from digestate. Moreover, the performance trend of the system alternatives with reference to the **PBP** and **IRR** showed that the **Status Quo** alternative performed best followed by the **COMPAD LF**, **INTEG 2**, **INTEG 1**, **COMPAD** and finally the **INCAD** alternative. Noteworthy was that for all alternatives, a **PBP** less than the 10 year loan period was registered. Meanwhile, with reference to the **IRR**, the **Status Quo** alternative registered at least 100%, while the remaining system alternatives registered **IRR** values ranging between 14-32%. The registered good performance of the **Status Quo** alternatives with reference to these two parameters was attributed to the fact that the main installation considered for the alternative consisted of modifications to incorporate a roofing structure for the lagoons at UCU wastewater treatment plant. These modifications would boost drying of sewage sludge, especially during rainy seasons. Given that such low installation costs would be incurred, yet much higher income would be accrued due to health improvement benefits, the **Status Quo** alternative performed significantly better than the remaining system alternatives.



On the other hand, the better performance of the **COMPAD LF** alternative in comparison to the **INTEG 2**, **INTEG 1**, **COMPAD**, and **INCAD** alternatives was additionally attributed to the fact that the alternative had reduced investment costs. This was mainly because utilization of the composting plant at Mukono Municipal landfill was proposed instead of installing a new composting unit. The overall economic feasibility performance trend taking into consideration all three parameters showed that **COMPAD LF>INTEG 2>Status Quo>INTEG 1>COMPAD>INCAD**.

When the utilization of biogas for cooking (**BfC**) scenario was considered, all the sanitation system alternatives except the **INCAD** alternative registered positive **NPVs**. The performance trend showed that the **INTEG 2** alternative still performed best followed by the **COMPAD LF**, **INTEG 1**, **COMPAD**, **Status Quo** and finally the **INCAD** alternative, which registered a negative **NPV**. As was the case for the **CoGen** scenario, the performance was influenced by the potential annual income accrued from the respective system alternatives. Thus, the higher the annual income, the better the system alternative performed with reference to **NPV**. Meanwhile, the negative **NPV** for the **INCAD** alternative was due to the much lower income accrued by the alternative in comparison to the overall investment of the system. Given that sewage sludge was considered for incinerated in the **INCAD** alternative, the only resources recovered was biogas and the organic fertilizer or soil conditioner from the anaerobic digestion unit. As such, the overall annual income from the system alternatives was lower in comparison to other alternatives. With reference to the **PBP** and **IRR**, the performance trend for the system alternatives showed a slight variation from that of **CoGen** scenario with the **INTEG 2** alternative performing better than **Status Quo** alternative, followed by **COMPAD LF**, **INTEG 1**, **COMPAD** and finally the **INCAD** alternative. Noteworthy was that higher **NPVs**, lower **PBPs** and higher **IRR** values were registered for the system alternatives when **CoGen** scenario was considered in comparison to when the **BfC** scenario was considered. These findings also suggest that it may be economically attractive to consider the **CoGen** scenario instead of the **BfC** scenario. Although such considerations would be based on the University's priorities. The overall performance trend with reference to all three parameters for the **BfC** scenario showed that **INTEG 2>Status Quo>COMPAD LF>INTEG 1>COMPAD>INCAD**.

**Table 2: Summary of Economic Evaluation of Sanitation System Alternatives for both Scenarios**

Item	COMPAD	COMPAD LF	INCAD	INTEG 1	INTEG 2	Status Quo
<b>Investment cost</b>						
<b>CoGen</b>	331,588,525	274,426,546	364,709,809	359,684,710	558,602,272	5,443,998
<b>Investment cost-BfC</b>	271,045,568	217,919,786	304,166,852	279,158,282	445,279,159	
<b>Project Financing</b>						
<b>Equity Capital</b>	30%	30%	30%	30%	30%	
<b>Loan</b>	70%	70%	70%	70%	70%	
<b>Loan Assumptions</b>						
<b>Interest rate</b>	10%	10%	10%	10%	10%	
<b>Payback period</b>	10 years	10 years	10 years	10 years	10 years	
<b>Grace period</b>	1 year	1 year	1 year	1 year	1 year	
<b>Revenues CoGen</b>	206,315,085	203,436,468	196,044,572	239,965,586	369,430,392	7,424,132
<b>Revenues BfC</b>	149,811,942	146,933,325	139,541,429	164,813,206	263,668,780	
Error! Reference source not found.						
<b>Total operating costs(TOC)</b>						
<b>TOC-CoGen</b>	133,287,445	115,300,097	140,923,224	153,634,864	194,364,142	3,145,307
<b>TOC-BfC</b>	108,231,462	90,935,656	115,867,240	120,308,628	147,464,847	

<b>Annual income</b>						
<b>Income-CoGen</b>	73,027,641	88,135,378	54,121,348	86,330,722	175,066,250	4,278,825
<b>Income-BfC</b>	41,580,481	55,996,677	22,674,189	44,504,578	116,203,934	
<b>Financial Evaluation</b>						
<b>NPV-CoGen</b>	290,136,945	475,427,399	96,055,737	375,297,396	931,835,406	30,983,329
<b>NPV-BfC</b>	82,952,506	266,378,354	-111,128,703	98,629,322	549,714,885	
<b>PBP-CoGen</b>	4.5years	3.1 years	6.7 years	4.2 years	3.2 years	1.3 years
<b>PBP- BfC</b>	6.5years	3.9years	13.4years	6.3years	3.8years	
<b>IRR-CoGen</b>	22%	32%	14%	24%	31%	79%
<b>IRR - BfC</b>	14%	25%	-	15%	26%	

**Source:** Author Note: All Monetary values are represented in Uganda Shillings (UGX)

## 8. Sensitivity Analysis

Having identified certain hot spots from the assessment of the sanitation system alternatives discussed, a sensitivity analysis was carried out to fully appreciate the influence of adjustments to the performance of the system alternatives. In the sensitivity analysis, variation of the interest rate, percentage of equity capital and biogas losses anticipated was carried out. During the sensitivity analysis, focus was also drawn to the **CoGen** scenario given the better performance registered in comparison to **BfC** scenario. Thus, the following adjustments considered included;

- Reduction of fugitive emissions from the biogas plant/anaerobic digestion unit to 5% and later to 3% was considered since the initial computation of **NPV**, **IRR** and **PBP** factored in the worst case scenario of fugitive emission of up to 7% of the biogas produced. The adjustment in fugitive emissions considered was based on experiences in measurement of fugitive emissions at biogas plants mostly in European countries, which registered fugitive emissions in the range 3-10% (Jonerholm, Lundborg 2012; Jørgensen, Kvist 2015)
- Adjustment of the interest rate from 10 % to 12%, which is also used conventionally to annualize capital payments in certain developing countries such as Uganda in a study carried out by (Walekhwa et al. 2014).
- Furthermore, a 5% discount rate was considered based on the assumption that a credible relationship between **UCU** and other financial institutions could influence reduction in the interest rate on loans acquired.
- Lastly, variation of equity capital for investment from 30 % (**base case**) to 20 % (**worst case**) and finally 40 % (**best case**) was considered. Given that **UCU** is a private University, implementation of any selected sanitation system would imply that necessary funds would be contributed by the University. Moreover, the fact that **UCU** is interested in shifting from the dependence on firewood for cooking to cleaner energy sources such as biogas while managing sewage sludge from the **WWTP** was an additional motivating factor (UCU 2012).

In general, the results from the sensitivity analysis showed that reduction of fugitive emissions from the anaerobic digester or biogas plant to 5% and later 3% positively influenced the **NPV**, **PBP** and **IRR** for all five alternatives. In comparison to the base case scenario where initial assumptions were considered, the **NPVs** increased by at least 7% while the **PBP** reduced by at least 1 month and only a 2% increment in **IRR** was noted for all the alternatives. Thus, reduction of fugitive emission significantly affected the **NPV** since more biogas would be available for cogeneration, which would in turn contribute to additional electricity and heat sales, accruing more annual income. Adjustment of the interest rate to 12% while maintaining equity capital at 30% and fugitive emissions at 7% resulted in the reduction in **NPVs** by at least as would be expected. In particular, the **INCAD** alternative registered a negative **NPV** 27% for the **COMPAD**, **COMPAD LF**, **INTEG 1** and **INTEG 2** alternatives in comparison to the **NPVs** computed in the base case scenario. Meanwhile, the **INCAD** alternative registered a negative **NPV**.

The trend of performance still showed that the **INTEG 2** alternative performed best followed by the **COMPAD LF**, **INTEG 1** and finally the **COMPAD** alternative. Moreover, with reference to the **PBP** and **IRR**, the **COMPAD LF** alternative still performed better than the other alternatives. Adjusting the interest rate to 5% no doubt resulted in much higher **NPVs**, much lower **PBPs** and slightly higher **IRR** values for all sanitation system alternatives considered. Reducing the equity capital to 20% showed reduced **NPVs**, increased **PBPs** and much lower **IRR** values. Increasing the equity capital to 40% no doubt positively influenced the result for the sanitation system alternatives with significant increase in **NPVs** of at least **100%**, lower **PBPs** by up to 1 year and higher **IRR** values by at least 6% in comparison to the base case scenario. Moreover, under these conditions, the **INCAD** alternative also registered a positive **NPV**. A final adjustment to check the influence on the results when no equity capital was considered showed that only the **INTEG 2** and **COMPAD LF** alternatives were feasible since they registered positive **NPVs** and the **PBPs** registered were below 10 years, while the **IRR** values were at least 15%. The **COMPAD**, **INCAD** and **INTEG 1** alternatives all registered negative **NPVs**, **IRR** values of less than 10% and **PBPs** ranging from 9.6 years to 18.6 years. Therefore, the sensitivity analysis highlighted key areas that could be considered in case of necessary adjustment for implementation of sanitation systems. Particularly in case the **CoGen** scenario was considered, then equity capital of at least 30%, an interest rate less than 10% and fugitive emissions less than 7% would positively influence the economic feasibility of all the sanitation system alternatives which consisted of the anaerobic digestion unit.

## 9. Conclusion

This paper set out to investigate the economic feasibility assessment of sanitation system alternatives proposed for **UCU**. The assessment which was carried out based on a cost benefit approach additionally incorporated computation of net present value (**NPV**), payback period (**PBP**) and internal rate of return (**IRR**) as additional parameters. The results from the assessment indicated that the feasibility of the sanitation system alternatives was positively influenced by inclusion of the anaerobic digestion process which allowed for resource recovery from sanitation system alternatives. Generally, the combination of low system investment costs and increased revenues from resource recovery positively influenced the good performance of the **COMPAD LF** alternative. Meanwhile, increased resource recovery in the form of biogas, organic fertilizer and briquettes from digestate contributed to the overall good performance of the **INTEG 2** alternative. Moreover, low investment costs also influenced the better performance of the **Status Quo** alternative which did not consist of an anaerobic digestion unit. In addition, consideration of other aspects such as an equity capital of at least 30%, an interest rate of at most 10% and fugitive emissions less than 7% would positively influence the economic feasibility of all the sanitation system alternatives proposed for **UCU**.

## Acknowledgment

The author gratefully acknowledges the financial support from Schlumberger Faculty for the Future foundation for funding this research and Uganda Christian University for the assistance accorded during the PhD research. The author is also grateful to the anonymous reviewers for their useful comments and valuable suggestions that improved the paper.

## REFERENCES

- Ackerman, Frank (2008): Critique of cost-benefit analysis and alternative approaches to decision-making. A report to Friends of the Earth England, Wales and Northern Ireland.
- Al Sadi, T.; Rutz, D.; Prassl, H.; Köttner, M.; Finsterwalder, T. (2008): Biogas handbook. Esbjerg: University of Southern Denmark Esbjerg.
- Brent, Robert. J. (2006): Applied Cost-Benefit Analysis. 2nd: Edward Elgar Publishing Limited.
- FEA (2014): Technical Guide on the Treatment and Recycling Techniques for Sludge from municipal Wastewater Treatment with references to Best Available Techniques (BAT). Federal Environment Agency: FEA.
- GIZ (2016): Biogas Technology Matrix. Deutsche Gesellschaft für Internationale Zusammenarbeit: GIZ.

- Hutton, Guy (2012): Global costs and benefits of drinking-water supply and sanitation interventions to reach the MDG target and universal coverage. World Health Organisation:WHO.
- Hutton, Guy (2015): Water and Sanitation Assessment Paper. Benefits and Costs of the Water Sanitation and Hygiene Targets for the Post-2015 Development Agenda. World Bank.
- Hutton, Guy and Haller, Laurence (2004): Evaluation of the Costs and Benefits of Water and Sanitation Improvements at the Global. World Health Organisation:WHO.
- Hutton, Guy; Haller, Laurence; Bartram, Jamie (2007): Global cost-benefit analysis of water supply and sanitation interventions. In *Journal of water and health* 5 (4), pp. 481–502. DOI: 10.2166/wh.2007.009.
- Jonerholm, K. and Lundborg, H. (2012): Methane losses in the biogas system.
- Jørgensen, L. and Kvist, T. (2015): Methane emission from Danish biogas plants. Quantification of methane losses.
- Kanathigoda, A. (2014): Faecal Sludge Management in Kampala and smaller urban areas.
- Karellas, Sotirios; Boukis, Ioannis; Kontopoulos, Georgios (2010): Development of an investment decision tool for biogas production from agricultural waste. In *Renewable and Sustainable Energy Reviews* 14 (4), pp. 1273–1282. DOI: 10.1016/j.rser.2009.12.002.
- McIntyre, Peter; Casella, Deirdre; Fonseca, Catarina; Burr, Peter (2014): Priceless! Uncovering the real costs of water and sanitation.
- Otoo, M.; Rao, K.; Taron, A. (2015): Synthesis Report on Feasibility Assessment for the Implementation of RRR business models proposed for Lima. Swiss Agency for Development and Corporation:SDC.
- Pantaleo, Antonio; Gennaro, Bernardo De; Shah, Nilay (2013): Assessment of optimal size of anaerobic co-digestion plants. An application to cattle farms in the province of Bari (Italy). In *Renewable and Sustainable Energy Reviews* 20, pp. 57–70. DOI: 10.1016/j.rser.2012.11.068.
- TBC (2016): Sanitation in the Circular Economy. Transformation to a commercially valuable, self-sustaining, biological system. Toilet Board Coalition.
- UCU (2012): Uganda Christian University Strategic Plan 2012-2018. Uganda Christian
- Vögeli, Y.; Lohri, C.; Gallardo, A.; Diener, S.; Zurbrügg, C. (2014): Anaerobic digestion of biowaste in developing countries. Dübendorf.
- Walekhwa, Peter Nabusi; Lars, Drake; Mugisha, Johnny (2014): Economic viability of biogas energy production from family-sized digesters in Uganda. In *Biomass and Bioenergy* 70, pp.26–39. DOI: 10.1016/j.biombioe.2014.03.008.
- Walla, C. and Schneeberger, W. (2008): The optimal size for biogas plants. In *Biomass and Bioenergy* 32 (6), pp. 551–557. DOI: 10.1016/j.biombioe.2007.11.009.
- Weimer, David. L. (2008): Cost Benefit Analysis and Public Policy. Journal of Policy Analysis and Management Classics Series.
- WSP (2008): Economic Impacts of Sanitation in Southeast Asia. A four-country study conducted in Cambodia, Indonesia, the Philippines and Vietnam under the Economics of Sanitation Initiative (ESI). Water and Sanitation Program, World Bank Group.
- WSP (2011): Economic Assessment of Sanitation Interventions in Indonesia. A six-country study conducted in Cambodia, China, Indonesia, Lao PDR, the Philippines and Vietnam under the Economics of Sanitation Initiative (ESI). World Bank, Water & Sanitation Program.
- Yiridoe, Emmanuel K.; Gordon, Robert; Brown, Bettina B. (2009): Nonmarket cobenefits and economic feasibility of on-farm biogas energy production. In *Energy Policy* 37 (3), pp.1170–1179. DOI: 10.1016/j.enpol.2008.11.018.

### Reviewer`s Comments

This is an interesting case study of feasibility assessment for Africa area. The topic is clearly interesting for the conference. The author used the cost benefits approach. Hence the need to assess the systems cost and benefits. There is a lack of information about the benefits.

## Impacts of urban typologies on efficiency of source-separation systems with decentralized treatment

Besson, M.<sup>1,2,3</sup>, Bisinella De Faria, A.B.<sup>1,2,3</sup>, Spérandio, M.<sup>1,2,3</sup>, Paul, E.<sup>1,2,3</sup>

<sup>1</sup> Université de Toulouse; INSA, UPS, INP; LISBP, 135 Avenue de Rangueil, F-31077 Toulouse, France

<sup>2</sup> INRA, UMR792 Ingénierie des Systèmes Biologiques et des Procédés, F-31400 Toulouse, France

<sup>3</sup> CNRS, UMR5504, F-31400 Toulouse, France

**Keywords:** Source-separation, wastewater treatment, decentralization, urbanism

### Introduction

The aim of this study is to develop a tool capable of analysing the impact of the urban typologies where is implemented source separation system on wastewater regarding energy balance. By separating the wastewater flows before mixing into the sewer, each flow keeps their characteristic, and could be valorised separately. Urine contains the large part of the nutrients (around 80% of the nitrogen and 50% of the phosphorus from domestic wastewater (Meinzinger and Oldenburg, 2009) whereas faeces contains the large part of the organic matter (around 60% (Meinzinger and Oldenburg, 2009)). Several studies analysed the environmental impacts of source separation (Landry and Boyer, 2016; Remy, 2010) but a few by taking into account the urbanism form where it is implemented (Meinzinger et al., 2010). This is why, this work studies two different separations (urine and black water) regarding different urban forms. Correlation between urban form and type of source separation will be analysed. Furthermore a sensitivity analysis will be carried out on the size of the district.

This work is the first part of the French project MUSES (Urban modelling of source separation systems) which aims to build a decision support tool to evaluate the different solutions of source separation (urine separation, black water separation...) in a specific urban implementation with real case studies. This tool will be further used to support the emergence of pilot project.

### Material and Methods

Two different solutions of source separation system are studied: 1) urine source separation; 2) black water collection (urine and faeces), and compared to the conventional collection and treatment of wastewater. In the first solution, the urine is transported by truck from storage near the production and until the treatment point. The rest of the wastewater is transported by conventional sewer and discharged into the wastewater treatment plant. In the second solution, the black water is collected by vacuum sewer and treated in decentralized system. The greywater is sent to the wastewater in a first option and in a second variant it is treated locally.

The 7 typologies representing European cities described by (Bonhomme et al., 2012) are studied: discontinuous pavilions, continuous pavilions, continuous blocks, discontinuous blocks, high-rise towers, ancient centre and industrial buildings.

The modelling approach is composed of four blocks: 1) the district with each urban form; 2) the collection and transport of flows (pipes or trucks); 3) the treatment of each flow; 4) the valorisation of by-products.

The first block uses the statistical parameters highlighted by (Bonhomme et al., 2012) as building density, land coverage ratio, road density ..., for the creation of the 7 theoretical districts. The second block designs the network collection regarding distance and wastewater flows. The urine is collected by truck and the black water by vacuum sewer. The treatment block consists in the modelling of each treatment unit: anaerobic digestion of the black water,



precipitation of struvite from urine and the conventional wastewater. In the valorisation block the transport and the use of co-products, here struvite, digestate and energy is simulated. A variant scenario will be the use of urine after precipitation to agriculture. Each simulated scenario is analysed with energetic assessment on the whole system.

## Results and Discussion

The study will highlight by a sensitivity analysis the effect of urban typology on the source separation system. For that two main aspects are studied. First, the effects of the scale of decentralisation for black water treatment are carried out. The size of the district with source separation is modified. The feasibility of black water digestion (size of the digester) is compared to the energy consumption linked to processes and especially the transport. The same analysis is conducted for urine treatment and transport. Secondly, the results of this study is analysed regarding the combination between type of separation and urban typology, in order to highlight if a specific source separation system seems most suitable in a particular urban typology. In this part, the specific significance of each parameter regarding each typology is investigated in order to assess the urban drivers for source separation. The figure 1 shows typical results obtained from the simulation.

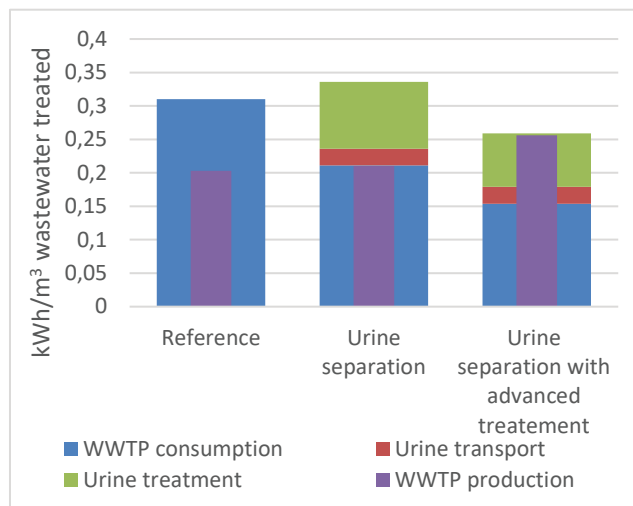


Figure 1: Typical results (energy balance) which are obtained by the simulation (from (Besson et al., 2015; Bisinella de Faria et al., 2015))

This analysis on energy balance is the first step of analysis for construction of the tool. In a second part of the project, several criteria (environmental assessment, economic balance) will be used to assess the link between urban form and source separation system.

## References

- Besson, M., Berger, S., Bessière, Y., Paul, E., 2015. Simulation of scenarii with source separated system integrated in the cities for wastewater added value, in: ResearchGate. Presented at the Eau Mégalopoles et changement global.
- Bisinella de Faria, A.B., Spérandio, M., Ahmadi, A., Tiruta-Barna, L., 2015. Evaluation of new alternatives in wastewater treatment plants based on dynamic modelling and life cycle assessment (DM-LCA). *Water Research* 84, 99–111.
- Bonhomme, M., Ait Haddou, H., Adolphe, L., 2012. Genius: A tool for classifying and modelling evolution of urban typologies. Presented at the PLEA2012 - 28 th Conference , Opportunities, Limits & Needs Towards an environmentally responsible architecture, Lima , Perú.
- Landry, K.A., Boyer, T.H., 2016. Life cycle assessment and costing of urine source separation: Focus on nonsteroidal anti-inflammatory drug removal. *Water Research* 105, 487–495. doi:10.1016/j.watres.2016.09.024
- Meininger, F., Oldenburg, M., 2009. Characteristics of source-separated household wastewater flows: a statistical assessment. *Water Science & Technology* 59, 1785. doi:10.2166/wst.2009.185
- Meininger, F., Ziedorn, V., Peters, I., 2010. Interactions Between Urban Forms and Source-Separating Sanitation Technologies, in: Vliet, B. van, Spaargaren, G., Oosterveer, P. (Eds.), *Social Perspectives on the Sanitation Challenge*. Springer Netherlands, pp. 125–144. doi:10.1007/978-90-481-3721-3\_8
- Remy, C., 2010. Life cycle assessment of conventional and source separation systems for urban wastewater management.



## Water Hub @ NEST: Practical Implications of Source Separation

**B. Etter, N. Hubaux, K. M. Udert, E. Morgenroth**

Eawag – Swiss Federal Institute of Aquatic Science and Technology, Ueberlandstrasse 133, 8600 Duebendorf, Switzerland (E-mail: bastian.etter@eawag.ch)

**Keywords:** NEST, Source Separation, Living Lab, Resources-Oriented Sanitation, Decentralised Systems

### Introduction

The NEST Building ([nest.empa.ch](http://nest.empa.ch)) is a living lab accommodating housing and office units. The building has been operational for 6 months (since August 2016) and activities are gradually increasing in both the living and the lab aspects, i.e. the life in the building hosting workers and inhabitants as well as the research on technologies implemented in the building. Wastewater research in NEST gravitates around the Water Hub ([www.eawag.ch/waterhub](http://www.eawag.ch/waterhub)) located in the basement. As presented at the previous edition of this conference (Etter et al., 2016), the wastewater streams in NEST are collected separately. Source separation plays the key role in the building's wastewater management, given that resources can best be recovered from separated waste streams (Larsen et al., 2013; Larsen & Gujer, 1996). However, at a practical scale, source separation is still a novel concept and no off-the-shelf solutions exist. Hence, this novel sanitation system requires specific technical know-how and skills of architects, planners, and craftspeople during its conception, design and implementation. In addition, users need to accept the new systems and learn how to use them. This paper shall summarise the findings and practical experience of the first stage of the implementation of source separation in NEST, in order to formulate recommendations for future systems.

### Material and Methods

#### *Piping*

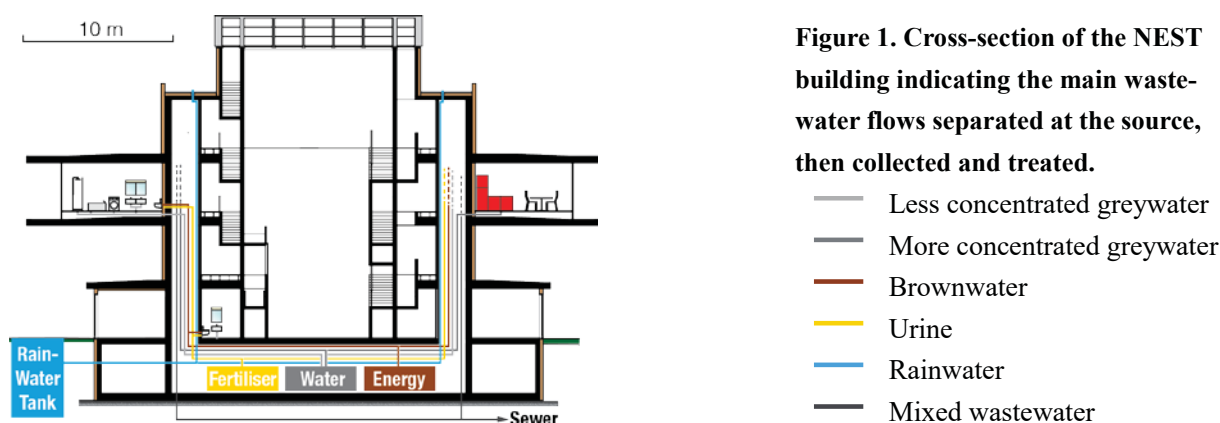
In NEST, the following streams are collected in separate pipes: urine, brownwater (faeces with flush water), less concentrated greywater (from bathrooms), more concentrated greywater (from kitchens), and rainwater. An additional pipe receives mixed wastewater, wherever the streams cannot be separated at the source.

#### *Urine-Diverting Toilets*

To effectively separate urine and faeces at the source, a new urine-diverting flush toilet (Duravit, Hornberg, Germany) has been thoroughly tested in NEST. A series of ten prototypes was installed and maintenance issues reported. Simultaneously, users were asked to respond to two types of surveys: Occasional users were probed about their attitude towards urine-diverting toilets and the tested prototype in particular, whereas regular users were asked to feed back on the toilet's technical functioning. Urine from the toilets was collected in the Water Hub and volumes recorded on a daily basis.

#### *Greywater*

Greywater is collected separately as 'light' and 'heavy' greywater, i.e. less polluted greywater from bathrooms, respectively more polluted greywater from kitchens.



## Results and Discussion

### *Piping*

Implementing a source separation system in NEST proved to be a challenge. The exchanges between researchers, planners, and later on contractors on the construction site showed not to be sufficient to completely avoid misconnecting pipes. In the brownwater pipe, clogging occurred several times at a bypass in the Water Hub, because the stream had a relatively high solids content and the pipes were sloped at the usual 2% resulting in an excessively slow flow. Given that NEST will be expanded with new units, special care will have to be taken to correctly implement all future connections. A fact sheet was developed for contractors to be briefed to understand the rationale behind source separation and beyond standard solutions.

### *Urine-Diverting Toilets*

First evaluations of the urine-diverting toilets show that the electronically controlled separation valve operates well and that most users appreciate the toilet. A gasket had to be replaced, after urine leaked from the valve unit. The facility management did not experience any additional workload with cleaning the toilets. However, an issue with the toilet design led to the replacement of the urine-diverting toilets with conventional flush toilets during the construction: the prototypes did not fulfil the dimensional norms for barrier-free toilets.

### *Greywater*

Greywater flows were considerably low, given that the inhabitants of NEST had not yet moved in. Thus, greywater treatment has been limited to preliminary lab-scale experiments. Currently, a new unit housing a spa is under construction. Hence, much more 'light' greywater will be available upon completion of the unit. In the future, additional units will complement NEST. Owing to this, source separation will become more of a standard solution.

## References

- Etter, B., Wittmer, A., Ward, B.J., Udert, K.M., Strande, L., Larsen, T.A., Morgenroth, E. (2016) Water Hub @ NEST: A living lab to test innovative wastewater treatment solutions. IWA Specialised Conferences on Small Water and Wastewater Systems & Resources-Oriented Sanitation, 14-16 September, Athens, Greece.
- Larsen, T., Udert, K.M., Lienert, J. (2013) Source separation and decentralization for wastewater management. IWA Publishing, London, United Kingdom.
- Larsen, T., Gujer, W. (1996) Separate management of anthropogenic nutrient solutions (human urine). *Water Science and Technology* **34**(3-4), 87-94.

## Vermifiltration toilets as an on-site household sanitation option

Templeton, M.R., Hylton, E., Noad, L.

Department of Civil and Environmental Engineering, Imperial College London, London, UK SW7 2AZ

**Keywords:** On-site sanitation; household sanitation, vermifiltration

### Introduction

Vermifiltration toilets, using earthworms to degrade human waste, have recently been demonstrated as an innovation in on-site sanitation (Furlong et al. 2014), with several hundred now installed in households in India (Furlong et al. 2015). The anticipated benefits of this low-cost sanitation technology over conventional pit latrines include a reduced pit filling rate, fewer odours, and safer emptying (Templeton 2015). The objectives of this study were to determine the rate of filling of vermifiltration toilets that have been in use by households in India for up to three years, gain a better understanding of the liquid infiltration rate through the toilets, and directly observe the feeding patterns of the worms.

### Material and Methods

A laser measure was used to take cross-sectional measurements (Fig. 1) of the depth to the vermi-compost layer in 14 vermifiltration toilets of varying installation ages, in the villages of Jejuri, Bhalgudi and Adachiwadi, near the city of Pune in Maharashtra province, India. These measurements also allowed observation of the non-uniformity of the distribution of the introduced waste and of the accumulated compost within the pits. A survey was also conducted with the toilet owners to determine the number of users, quantify usage habits, and identify any problems with the functioning of the toilet. Soil and compost samples were also collected at each location for use in bench-scale column tests to assess liquid infiltration rates. Photos were taken to examine changes over time in the interior pit conditions, and a video camera was installed in selected pits to observe the worm action *in situ* under red light.

### Results and Discussion

The calculated fill rates of the vermifiltration toilets represented a significant improvement over the estimated emptying frequency of conventional pits of a similar size and usage rate. Several factors caused variability in this fill rate, but the benefit in terms of reduced filling rate versus a conventional pit was clear. The infiltration of the liquid fraction of the waste was observed to be a key factor in pit filling; further research is needed to understand potential soil pore clogging with the vermi-compost over time, whether this varies seasonally (i.e. in the monsoon versus dry season), and how this affects infiltration and fill rates.

The camera imaging confirmed that the worms consume the newly introduced waste very quickly upon introduction into the pits, before then returning below the surface (Fig. 2).

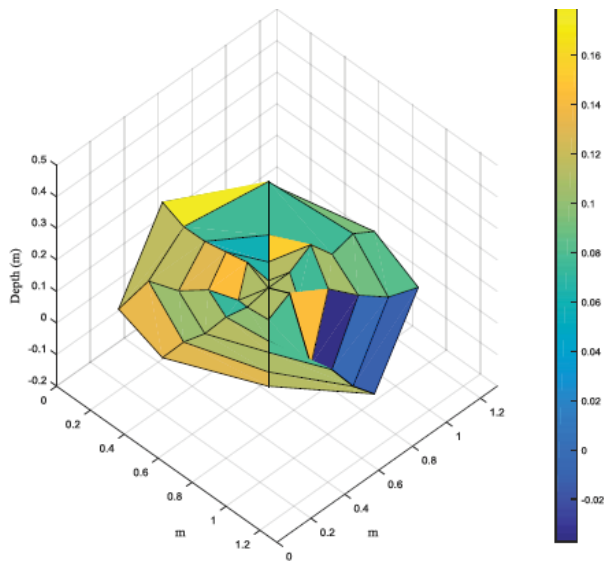


Figure 1. Example of a fill depth contour plot from cross-sectional laser measurements of a cylindrical pit.



Figure 2. *In situ* monitoring of worm activity in a vermi-filtration toilet.

## Acknowledgements

We gratefully acknowledge the assistance provided in India by colleagues from Primove, Bear Valley Ventures, and the Institute for Transformative Technologies, as well as the household members for allowing us access to their toilets for measurements and imaging. This research was partly supported by the UK Engineering and Physical Sciences Research Council, grant number EP/N010124/1.

## References

- Furlong, C., Templeton, M.R., Gibson, W.T., 2014. Processing of human faeces by wet vermifiltration for improved on-site sanitation. *Journal of Water, Sanitation and Hygiene for Development* 4, 231-239.
- Furlong, C., Gibson, W.T., Templeton, M.R., Taillade, M., Kassam, F., Crabb, G., Goodsell, R., McQuilkin, J., Oak, A., Thakar, G., Kodgire, M., Patankar, R., 2015. The development of an onsite sanitation system based on vermifiltration: the 'Tiger Toilet'. *Journal of Water, Sanitation and Hygiene for Development* 6, 608-613.
- Templeton, M.R., 2015. Pitfalls and progress: a perspective on achieving sustainable sanitation for all. *Environmental Science: Water Research and Technology* 1, 17-21.

# Sustainable sanitation management tool for decision making in isolated areas in Brazil

Ref # S2SMALL-05813

Magalhães Filho, F.J.C<sup>1,2\*</sup>, Queiroz, A.A.F.S.L, Paulo<sup>2</sup>, P.L<sup>2</sup>

<sup>1</sup> Dom Bosco Catholic University/Campo Grande, Brazil

<sup>2</sup> Federal University of Mato Grosso do Sul/Campo Grande, Brazil

\* Presenting Author: [fernando@ucdb.com](mailto:fernando@ucdb.com)

**Abstract:** There is a wide range of technical sanitation guidelines focusing on small or traditional communities for ecological alternatives at a household level. However, a computational tool that has a database and connects these guidelines in a single reference for resource oriented sanitation concept decision making does not exist. In this sense, the objective of this project was to develop an easy-to-use tool, for the decision-making process, choosing technical solutions, to managing the operation and maintenance of the systems with a participatory approach. The results obtained from the demonstrative study indicate that the tool proposed in this research project will be of great value, helping the decision making process, to aid in choosing sustainable sanitation solutions and also for the operation and maintenance of the systems. When presenting and discussing the tool with research groups and technicians, we could notice that it has great potential for participatory application, for the elaboration of municipal sanitation plans, assisting technicians of municipalities and environmental licensing agencies, designers and engineering students, among others. The software can be applied with other management tools, such as the 5W-2H and Canvas as a business model.

**Keywords:** basic sanitation, guidelines, management, rural area, software, website.

## INTRODUCTION

In general, implemented sanitation projects that did not work were results of decisions taken without the participation of the concerned population or without taking into account local conditions or aspirations. The implementation of the work cannot be seen as the sole objective of the project. Stakeholders should not be limited to the provision of local infrastructure by the authorities. This difficulty is clearly one of the main challenges in providing sustainable sanitation and in managing activities (Beausejour, 2009). Engaging stakeholders in the proposal selection is essential to the success of the objective (Bryson, 2004) and community involvement is often the only solution to solving solid or liquid waste problems in low-income areas. In this sense, the community's awareness and willingness to participate are important aspects to consider when planning and implementing sanitation alternatives. It is fundamental that the water and sewage service management bodies allow community involvement, motivating and gaining trust in decision making. In isolated communities, this participative management is essential and community information and wishes should be considered in the decision making process.

Regarding planning and decision making processes aimed at sustainable sanitation solutions, guides, manuals and tools developed by multidisciplinary groups exist. The IWA Sanitation 21 (IWA, 2006), for example, aims to support municipal and local authorities in preparing municipal sanitation plans in a rational and realistic manner. The EAWAG-SANDEC Compendium of Sanitation Systems (Tilley et al., 2014) was developed in the context of sustainable decentralized environmental sanitation, composed of a participatory planning process (EAWAG, 2005). It groups a wide range of technologies in a single volume, helping

the user to understand and work with the system definition. There is also the SSWM toolbox (Sustainable Sanitation and Water Management), the most comprehensive collection of technologies (Conradin et al., 2011). The main benefit is its holistic approach: from assisting in identifying local problems, supporting the planning process and presenting numerous solutions that are likely to improve the local situation. Although there is extensive literature on the subject, when it comes to studies and documents in Portuguese, it is still scarce. There are Brazilian experiences and documents that serve as tools to compile technologies and give general ideas about constructive, operational and maintenance aspects, such as: the FUNASA (National Health Foundation) sanitation manual, which deals with water supply, domestic sewage, rainwater drainage and solid waste management (Brazil, 2004); the guide of operational and maintenance aspects of septic tank sludge using constructed wetlands (Brazil, 2014a). Recently, a book with health improvement guidelines focusing on residential sanitation (Brazil, 2014b) has been elaborated, which complements the manual of technical guidelines for the elaboration of residential health improvement projects (Brazil, 2006b), all developed by FUNASA, which is responsible for traditional and isolated communities in the country (Brazil, 2007).

Concurrently with the documents, technical books and manuals, there are computational tools with the same purpose, such as: WAWTTAR (Finney and Gerheart, 1998), SANEX<sup>TM</sup> (Loetscher & Keller, 2002), SETNAWWAT (Sah et al., 2010) and DSS to select and plan in emergencies situations (Zakaria et al., 2015), elaborated for specific applications. These computational tools tend to have an exhaustive amount of criteria that hinders the user when there is not a large number of information about the community being studied. They are neither flexible nor do they have user-friendly interfaces, which in our view would be to be able to insert and remove criteria and technologies and have the possibility of proposing sanitation arrangements, which is only possible with a connection to a database. Aiming to propose a user friendly tool to assist in the selection of technical and management solutions for sanitation services in isolated areas, the objective of this work was to present the tool we have developed, which takes into consideration the selection of technically acceptable solutions, for the decision making process in a participatory approach with the community. In addition to the software itself, the complete tool considers two interventions: the first one with sanitation professionals and the second one with householders.

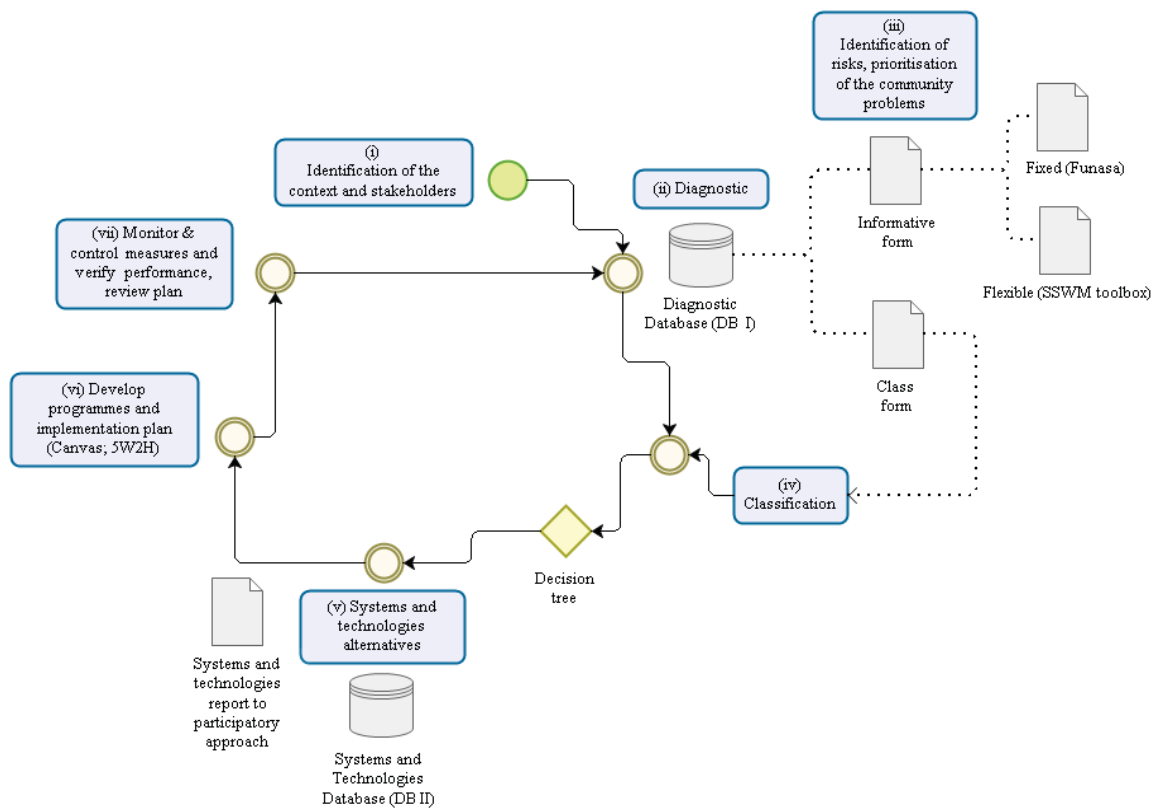
## **MATERIALS AND METHODS**

The tool was developed in 4 steps: i) building the concept of the sustainable sanitation management tool; ii) development of a database (PostgreSQL) to analyze the basic sanitation situation related to water supply and domestic sewage; iii) selection of technologies and decision criteria; and iv) computational program (Java) with a decision tree based on the analysis of the situation and alternative of technologies.

### ***Database management software design, diagnosis, systems and technologies***

The design of the tool (Figure 1) was based on the integration of Sanitation 21 (IWA, 2006) and Safety Sanitation Planning (WHO, 2015), as well as Term of Reference from FUNASA for sanitation plans. The diagnostic model proposed here follows the recommendations of the Sustainable Sanitation and Water Management toolbox – SSWM toolbox (Conradin et al., 2011), with a database. The selection criteria for sanitation systems and technologies are based on Compendium (Tilley et al., 2014), Greywater Management (Morel & Diener, 2006), NBRs (Brazilian Technical Standards) and case studies from FUNASA and PROSAB (National Research Program on Basic Sanitation).



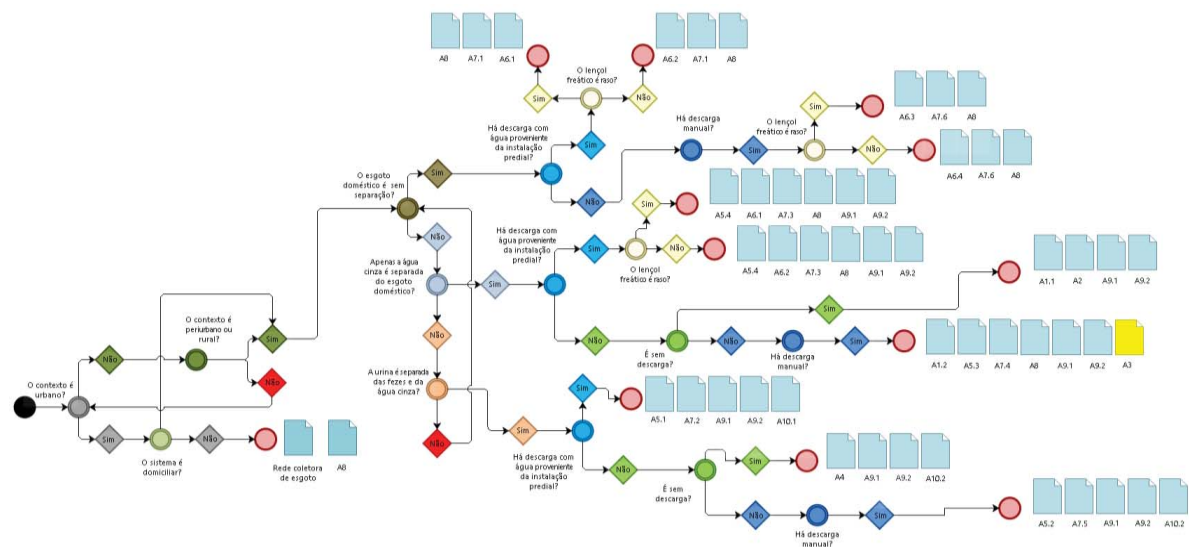


**Figure 1.** Modules of the sustainable sanitation database management software. Stages: (i) identification of the context and stakeholders; (ii) diagnostic with database (DB I); (iii) identification of risks, prioritization of the community problems by informative form; (iv) classification using class form by selection criteria from decision tree to obtain (v) alternative sanitation systems, which presents technologies from DB II (second database). Subsequently, the report is generated with the participatory approach and selects the sanitation system to (vi) develop programs and implementation plans. Lastly, (vii) monitor & control measures verify performance and review plans.

The first step is to identify the stakeholders who will carry out the diagnostic. The diagnostic has two forms: informative and class forms. The information form is divided into two sections: *fixed* and *flexible*. The *fixed* section allows the user to generate graphs and perform a statistical analysis, with information from several households. The *flexible* section allows the user to insert different types of questions such as multiple choice, single choice, and descriptive questions in addition to attaching photos and coordinates.

### ***Decision tree and participatory approach***

The decision tree (Figure 2) crosses the diagnostic (DB I) information (class form) with the selection criteria adopted to obtain possible sanitation systems (DB II). After generating the report with sanitation systems and technologies, a workshop is conducted through a participatory methodology to choose the most appropriate option according to the community. In the technology database (DB II), there is information about technical options (implementation, operation and maintenance aspects); environmental aspects (groundwater level, rocky soil/area and digging/excavation difficulty, etc.); cultural aspects (urine use in the soil, squat defecation, and religious aspects regarding water, feces and urine, among others). Details of the sizing criteria, suitability for the region and location, health and acceptance aspects by members, operation and maintenance, and the advantages and disadvantages are presented and discussed with the local members.



**Figure 2.** Decision tree based on class form linked to the database (BD II) with sanitation systems (in portuguese).

**Case study in the Furnas do Dionísio Quilombola community**

The demonstrative study was carried out in the community Furnas do Dionísio, Brazil, to demonstrate the use and application of the tool from data collection (diagnostic) to the selection of the technological arrangement for domestic sewage. The diagnostic was made through informative and class forms. The participatory methodology was to present the results from software to the community and to select sanitation systems with the community, which was based on the integration of community-based approaches (Table 1).

**Table 1.** Integration of community-based approaches (WaterAid, 2013).

Community-based approaches	Description	Objective
SARAR	Self-esteem; Associative strength; Resourcefulness; Action Planning; Responsibility	to encourage participants and identify local actors
CHC	The child-to-child approach	
PHAST	Participatory hygiene and sanitation transformation	to include people with experience in the process
CLTS	Community-led total sanitation	addressing sanitary conditions that reflect health and hygiene in the rural area

**Business model and sanitation system implementation**

For the implementation of the chosen sanitation system, a business model was presented by the Canvas methodology and the use of the 5W2H management tool (Osterwalder and Pigneur, 2010). Considering the relevance of stakeholder participation in the choice of the sanitation arrangement, the Canvas was used at the end to understand the local business model, adopting the following steps: (1) meetings with the community on ecological alternatives for sanitation; (2) use of the software by the technical team to decide which alternatives to present; (3) holding a workshop with the community using participatory methodology to choose the arrangements and technologies; consult the technology information in the DB II; (5) use of the 5W-2H management tool for implementation. It should be noted that the diagnostic database could be used for information, such as indicators, to be stored in order to evaluate the communities’ performance and to control whether the sanitation plans have been effective.

## RESULTS AND DISCUSSION

### *Application and validation of a sustainable sanitation management tool*

Figure 3 shows the schematic frame with the steps of the process using the tool for the case study in the Furnas do Dionísio Quilombola community.

(i) Stakeholders: members and leaders from the community, sanitation professionals from FUNASA, resource-oriented sanitation specialists, farmers.			
(ii) Diagnostic		Sanitation Systems/Systems and Technologies report (v)	Participatory approach/ Selection stage by choice (vi)
Informative form (iii)	Class form/Decision tree (iv)		
01 Edification (leisure and coexistence area)		A5.4 Biogas without urine-diversion and flushwater	No, without equipment, material and specialists.
02 Bathrooms (male and female).		A6.2 Conventional sewage disposal in soak pit with flushwater	No, there is no reuse and sludge production.
Conventional flushwater toilet.		A7.3 Ecological Sanitation alternative for blackwater with flushwater	Yes, Evapotranspiration Tank (TEvap)
Greywater from washbasin and shower mixed with blackwater and disposal in inadequate septic tank (soak pit/soil without treatment).		A8 Sludge management	TEvap there is no significant sludge production
Greywater from the kitchen sink in the open drains, close to animals and children.		A9.1 Conventional greywater management	Without landscape integration
Inadequate/unsuitable septic tank close to the well for water supply.		A9.2 Sustainable greywater management	Banana circle/Banana garden/Infiltration of greywater.
Food production and tourist activities close to the location.			
The groundwater table is not shallow, but the terrain has rocks and can make excavation difficult.			

**Figure 3.** Stakeholder's identification, diagnostic, decision tree, sanitation systems and participatory approach.

Magalhães Filho & Paulo (2017) conducted a study in the rural Quilombola communities in Brazil, where it was observed that there is no participatory management model in the decision-making process for choosing alternatives for water and sewage treatment, since there is only one system model, both for water and sewage based on groundwater collection lacking operation and maintenance and with no adequate treatment. For sewage, the only alternative is a dry or absorbent pit, with no possibility of reuse of the nutrients present in the sewage, making it impossible to find a sustainable sanitation system. This indicates that an individual household evaluation of the water supply and sewage conditions is important. There are differences between the homes, which allows several technological options within the same community.

The demonstrative study was also efficient to evaluate the participatory methodology chosen for the case study, which was widely accepted by the community and showed positive results regarding the consensus of the chosen technologies.

In the first intervention after applying the software (Intervention I - Technique), the system with the biodigester was discarded due to the difficulty of implantation and operation (cost and labor, among others). The option of systems without water (dry) was suggested even if it was not a result of the software, in order to reduce the consumption of water in the community. However, there was no interest from the members (Intervention 2 - Community), as they are culturally accustomed to using water, being the preference of the majority. In addition, they receive visitors and tourists who are not accustomed to not using water. Thus, among the options, the community opted for evapotranspiration of black water, with the TEvap (Evapotranspiration Tank), in conjunction with the banana tree as a technology. The choice was based on the interest to reuse the water and take advantage of the nutrients and in order to provide a more harmonious landscape environment, attractive for the tourism activities inherent to the location. A lower operation and maintenance demand with easy implantation of the materials, equipment and local labor, without generating mud, odor and vectors, common to other systems and their technologies was also observed.

### ***Business model***

After the structured business model (Table 2) it was possible to verify that with value propositions clarified to the community (customer segments), guaranteeing the choice of this sanitation arrangement was an important factor. After all, an ecological option was adopted with regards to what had been implemented.

**Table 2.** The schematic business Canvas model.

<b>Key partners</b>	<b>Key activities</b>	<b>Key resources</b>	<b>Valuable proposals</b>
FUNASA; community members and leaders; NGOs, technicians from water and sanitation services utilities.	Implement TEvap and Banana circle; collect greywater; collect fruits, prune and clean plants; produce and sell/consume bananas.	Technicians and sanitation professionals; construction of sewerage systems; favorable tourism environment.	Promote the reuse of water and nutrients from domestic sewage, avoiding contamination and reducing health risks. Improving the local landscape and tourism conditions in the community.
<b>Customer relationships</b>	<b>Customer Segments</b>	<b>Channels</b>	<b>Cost structure and Revenue Streams</b>
Permanent user guidance on technology use; monitor market of the production, sale and consumption of bananas; update data in the computational tool.	The Furnas community convention center; workers in the sugar production.	Regular meetings, radio and cell phone messages; constant use of software; educational and environmental actions with the community.	Resource for household sanitary construction improvements can be used for sustainable sanitation systems; use of local labor at a lower cost.

In addition, it is explicit how sanitation, besides providing better health and environmental conditions, guarantees users the possibility of promoting tourism in the region, as it guarantees adequate conditions to receive visitors, improving the local economy, a fact shown by Arthur & Mensah (2006).

In order to diffuse and share the software there is a need to invest in key resources (technicians and consultants), and resources used for conventional systems (septic tank, soak pit) can be reverted to the options chosen in a participatory way (revenue streams ). It is necessary to follow up on activities with health and environmental education workshops and programs, as suggested by Magalhães Filho & Paulo (2017) and detailed in the business model in the customer relationship and channel items.

## CONCLUSIONS

The article presented a sustainable sanitation tool with database management software, the conception, diagnosis, a decision tree and its criteria and technologies and sanitation systems with emphasis on ecological sanitation alternatives. The software can be applied initially at a home (residence), in a community building such as a school, shelter for minors, community living space, a neighborhood, or even for the whole community. The diagnosis can identify risks, understand problems and prioritize actions. The decision tree ensures flexibility to the user by inserting technologies and creating new sanitation systems, allowing the database information to be used in the diagnostic step in the decision process. This tool based on artificial intelligence is database driven and useful for decision making, since many existing documents that address numerous technologies end up making the choice complex and often the designers and technicians make customary decisions.

The proposed methodology allows the application of the software during the elaboration of plans. The information database can be used as an indicator to evaluate the conditions using a project horizon, analyzing the goals, programs and actions in the sanitation area. Although it was applied to Quilombola communities, it can be used in different contexts: urban, rural, settlements, favelas, peri-urban areas, among others. The tool provides the need to involve the community in the participatory decision-making process and it is suggested that the participatory methodology be adapted to local conditions.

The case study permitted the validation of the applied software, with real results and that enabled the implementation of the chosen system. The software application demonstrates that communities are able to make sanitation decisions and choose more sustainable technologies and sanitation systems. It became clear that by enabling ecological sanitation alternatives with the separation of domestic effluents, the community understood that there are better options than conventional technologies such as septic tanks, enabling the reuse of water and utilization of the nutrients present in domestic sewage.

The software can be applied with other management tools, such as the 5W-2H and Canvas as a business model, both to implement technologies, but also to clarify how the proposal of ecological alternatives for resource-focused sanitation presents a more interesting valuable proposal and provides gains with users focused on health and environmental education.

## REFERENCES

- Arthur, S. N. A. & Mensah, J. V. 2006 Urban management and heritage tourism for sustainable development: The case of Elmina Cultural Heritage and Management Programme in Ghana, *Management of Environmental Quality: An International Journal*, 17(3), 299-312.
- Beauséjour, J. 2009 Managing delivery of sanitation infrastructures for poor communities: Decentralizing without penalizing. *International Journal of Managing Projects in Business*, 2(3), 355-359.



- Brasil. 2004 *Manual de Saneamento (Sanitation manual)*. FUNASA, 3<sup>o</sup> ed. Brasília, Brazil.
- Brasil. 2007 *Política Nacional de Saneamento Básico (Federal Law of Basic Sanitation)*. Law no 11.445/07. Brasília. Brazil.
- Brasil. 2014a *Operação e manutenção de tanques sépticos e lodo: manual de boas práticas e disposição do lodo acumulado em filtros plantados com macrófitas e desinfecção por processo térmico (Operation and maintenance of septic tanks and sludge: manual of good practices and disposal of sludge accumulated in planted filters with macrophytes and disinfection by heat process)*. FUNASA, 1<sup>o</sup> ed. Brasília, Brazil.
- Brasil. 2014b *Saneamento domiciliar – Manual de instruções de uso das melhorias domiciliares (Household sanitation – Instructions manual for home improvements use)*. FUNASA, 1<sup>o</sup> ed. Brasília, Brazil.
- Bryson, J.M. 2004 What to do when stakeholders matter: stakeholder identification and analysis techniques, *Public Management Review*, 6(1), 21-53.
- Conradin, K., Peters, D. & Spuhler, D. 2011 *Planning Water and Sanitation Interventions with the SSWM Toolbox*. Sustainable Sanitation Practice: Planning Tools. EcoSan Club, Vienna, Austria.
- Finney, B. & Gerheart, R. 1998. *A user's manual for WAWTTAR*. Environmental Resources Engineering, Humboldt State University.
- IWA. 2006 *Sanitation 21*. International Water Association. IWA Publishing, London, UK.
- Loetscher, T. & Keller, J. 2002 A decision support system for selecting sanitation systems in developing countries. *Socio-Economic Planning Sciences*, 36, 267-290.
- Magalhães Filho, F. J. C. & Paulo, P. L. 2017 *Water supply, sanitation and health aspects in Quilombola communities in the State of Mato Grosso do Sul*. *Interações*, 18, 103-116.
- Morel, A., & Diener. 2006 *Greywater Management in Low and Middle-Income Countries, Review of different treatment systems for households or neighbourhoods*. EAWAG, Ed. Switzerland.
- Ostewalder, A. & Pigneur, Y. 2010 *Business Model Generation* (John Wiley & Sons, Eds) p.278. New Jersey – USA.
- Sah, L., Rosseau, D. P. L. & Van Der Steen, P. 2010 *Selection tool for natural wastewater treatment systems*. SWITCH Document. SWITCH.
- Tilley, E. A., Ulrich, L., Lüthi, C., Reymon, P. & Zürbrugg, C. 2014 *Compendium of Sanitation Systems and Technologies*. Swiss Federal Institute of Aquatic Science and Technology. Water Supply and Sanitation Collaborative Council, Dübendorf, Switzerland; Geneva, Switzerland.
- WaterAid. 2013 *Hygiene framework*. WaterAid, London, UK. [www.wateraid.org/publications](http://www.wateraid.org/publications) (accessed 13 julho 2017).
- WHO (World Health Organization). 2015 *Sanitation Safety Planning: Manual for safe use and disposal of wastewater, greywater and excreta*. Geneva. Switzerland.
- Zakaria, F., Garcia, H., Hooijmans, C. M. & Brdjanovic, D. 2015 Decision support system for the provision of emergency sanitation. *Science of The Total Environment*, 512-513, 645–658.



# Optimizing chlorination and electrolysis dosages for hand washing water recycling post-treatment

O.Larivé<sup>(a)</sup>, C.Ziembra<sup>(a,b)</sup>, and E. Morgenroth<sup>(a,b)</sup>

<sup>(a)</sup> Eawag: Swiss Federal Institute of Aquatic Science and Technology, Dübendorf, CH-8600, Switzerland

<sup>(b)</sup> ETH Zürich, Institute of Environmental Engineering, 8093 Zürich, Switzerland

**Keywords:** greywater, regrowth, assimilable organic carbon, total cell count, hand washing

## Introduction

There is great need for a system that can safely recycle hand washing water, enabling improved sanitation with minimum capital and energy demands. Biologically activated membrane bioreactor (BAMBi) systems are a promising technology to deliver affordable household treatment of greywater (Künzle et al., 2015). However, the water treated with a BAMBi system still contains sufficient carbon to fuel bacterial regrowth. Some disinfection or post-treatment is thus necessary in the storage tank.

Chlorination is the most common disinfection for greywater recycling (Boyjoo et al., 2013), and can be achieved by direct dosing or by producing chlorine using electrolysis (Kraft, 2007). Because chlorine can react with diverse compounds in the water, the required dosage to inactivate bacteria depends heavily on the water quality, which fluctuates with the efficiency of the upstream treatment. In this study, we monitor the residual chlorine, which determines the inactivation. Electrolysis may effectively combat bacterial regrowth at lower free chlorine concentrations as it can produce strong oxidants. Additionally to killing bacteria more efficiently, strong oxidants can mineralize DOC (Kraft, 2007), which may result in a reduction of carbon available for bacteria, measured as assimilable organic carbon (AOC).

This paper seeks to compare the performance of electrolysis and direct chlorination as post-treatments for synthetic hand washing water treated in a BAMBi and filtered through granular activated carbon (GAC). A full-scale system including three different dosages of electrolysis and three different dosages of direct chlorination was evaluated over a period of 70 days, experiencing the disruptions from stable system operation that will influence the selection of the chlorine targets.

## Methods and Materials

A BAMBi reactor was constructed using a 52-liter plastic tank and ultrafiltration membrane modules (Microdyn), fed synthetic greywater (75 liters per day) and aerated. The permeate from the membrane was pumped to a GAC filter and then to 7 post-treatment tanks operated in parallel (1-day residence time). Three tanks were dosed with different concentrations of chlorine and three with different dosages of electrolysis. Electrolysis employed boron-doped diamond electrodes (WaterDiam, Delémont, Switzerland). The tanks were monitored for free and total chlorine concentrations, DOC, AOC and total cell counts (TCC).

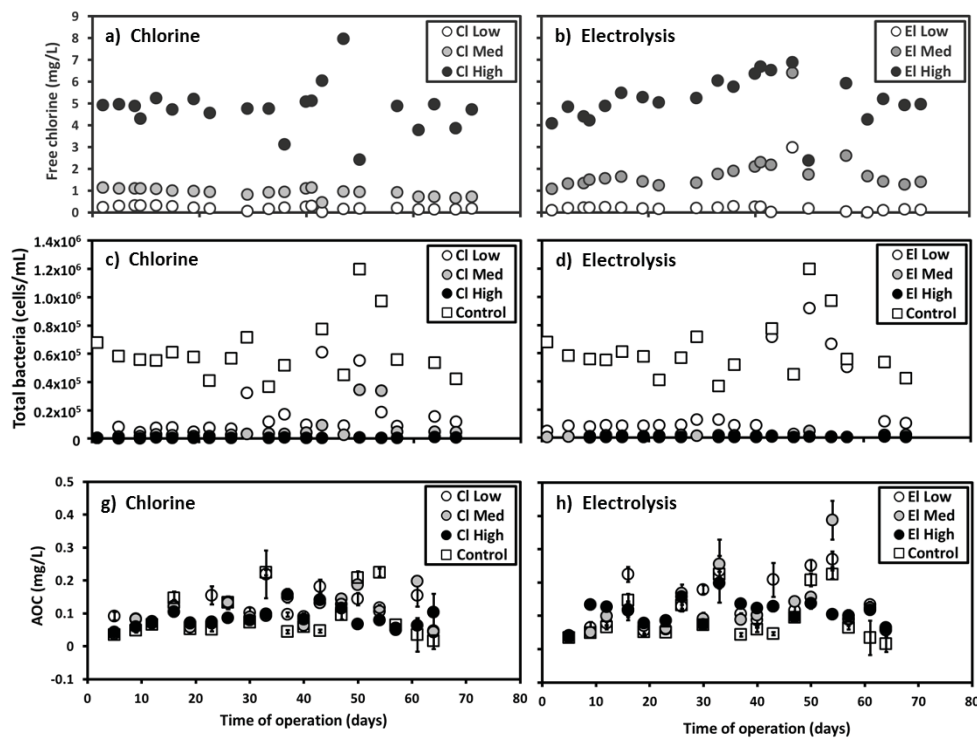
## Results and Discussion

Figure 1 a. and b. demonstrate that generally stable free chlorine concentrations were achieved both using electrolysis and by direct chlorine addition. Target concentrations were 0.2, 1 and 5 mg/L of free chlorine. Both treatments reduced significantly the TCC. The median TCC was reduced from  $6 \times 10^5$  cells/ml in the control to  $9 \times 10^4$ ,  $2.9 \times 10^4$  and  $2.5 \times 10^3$  cells/mL for increasing direct chlorination concentrations respectively, and to  $8.79 \times 10^4$ ,  $1.1 \times 10^4$  and  $2.9 \times 10^3$  for increasing electrolysis concentrations (Fig 1 c. and d.). Increasing concentrations of free chlorine produced reductions in bacteria concentrations in the storage tanks. Municipal drinking water in Zürich Switzerland averages  $8.97 \times 10^4$  cells/ml (Hammes et al. 2010). Even the lowest dosages of electrolysis and direct chlorination were able to bring

the median TCC to that level. TCC concentrations were near identical for a given free chlorine concentration achieved through electrolysis or direct chlorination.

The DOC and AOC concentrations for the electrolysis or chlorination tanks were not clearly different from the control (Fig 1 g. and h., only AOC). The daily variation in DOC and AOC in each post-treatment tank appears to be more impacted from the water quality entering that tank, and less impacted by the post-treatment. The average AOC in all tanks (108 mg/L) was much higher than estimated for bio stability (32  $\mu\text{g/L}$ , Hammes et al. 2010), thus AOC limitation may not be an effective antibacterial mechanism in this system.

Electrolysis and direct chlorination are equally good at reducing TCC and none of them improved the regrowth potential of the water. It seems that chlorine is the main compound produced by the electrolysis in the present configuration.



**Figure 1:** Free chlorine, total cell count (TCC) and AOC for three different dosages of direct chlorination (left plots), three dosages of electrolysis (right plots) and one control tank. The axis titles and scales are the same for horizontal pairs. All plots have the same x-axis.

We observed how variations in the permeate quality can lead to increased TCC. On day 43, the concentration of ammonia in BAMBi's permeate increased from 0.2 mg/L average to 2.7 mg/L. This led to a drop of free chlorine concentration from 0.2 mg/L average to 0 in the low electrolysis dosage tank, which caused an increase of TCC from  $1 \times 10^5$  to  $6 \times 10^5$  cells/mL. In tanks with higher residual free chlorine concentrations no increase of TCC was observed. We recommend operating with a minimum of 1 mg/L free chlorine residual to compensate for these disruptions, obtained by direct dosage or electrolysis with equal effect on water quality.

## References

- Boyjoo, Y., Pareek, V. K., Ang, M. (2013), A review of greywater characteristics and treatment processes. *Water Science and Technology*, 67, (7), 1403-1424.
- Künzle, R., Pronk, W., Morgenroth, E., Larsen, T. A. (2015), An energy-efficient membrane bioreactor for on-site treatment and recovery of wastewater. *Journal of Water Sanitation and Hygiene for Development* 5(3): 448-455.
- Kraft, A. (2007), Doped diamond: A compact review on a new, versatile electrode material. *International Journal of Electrochemical Science* 2(5): 355-385 quality
- Hammes, F. A.; Berger, C.; Köster, O.; Egli, T., Assessing biological stability of drinking water without disinfectant residuals in a full-scale water supply system. *Journal of Water Supply: Research and Technology - AQUA* 2010, 59, (1), 31-40

## Evaluation of the hygienization at composting toilets in remote areas

**Weissenbacher, N. \*, Hochwarter, C., Schwaighofer C., Zunabovic-Pichler, M., Langergraber, G.**

University of Natural Resources and Life Sciences, Institute of Sanitary Engineering and Water Pollution Control, 1190 Vienna, Austria, \* Corresponding author [norbert.weissenbacher@boku.ac.at](mailto:norbert.weissenbacher@boku.ac.at)

**Keywords:** sanitation risks, composting toilets, hygienization, monitoring

### Introduction

Composting toilets can be applied as component of the sanitation system at remote objects in the alpine region. Due to the extreme climatic conditions, the degradation efficiency of the composting process for the reduction of hygienic parameters is unknown. However, for sensitive areas e.g. for drinking water protection the hygienic risks of compost disposal are of interest for water utilities. Chemical and physical parameters impact the composting process (ambient temperature, water content, nutrient and oxygen availability, pH; Eriksen et al., 1995) but self-hygenization by high compost temperatures cannot be reached under such unfavourable temperature conditions (Germer et al., 2010) as present in Alpine areas. Therefore, the study aimed on microbiological sampling, analysis and evaluation of the hygienic quality of the produced compost under unfavourable climatic conditions. Standard procedures for microbiological testing had to be adapted for the use at composting toilets due to the heterogenic matrix and the small volume of materials. Analytics (methods, parameters) had to be screened for their potential to reflect hygienic risks (Magri et al., 2013; Hill et al., 2013). However, because of the large structural heterogeneity of the raw input materials, the first objective was to adapt the sampling procedure to achieve representative results. Further, the analytical methods available had to be compared. Finally, suggestions for sampling, analyses and data interpretation had to be derived from field monitoring results.

### Material and Methods

The investigations took place at five composting toilets located at huts at the Schneeberg and Rax mountains operated by the Austrian Alpine Association (ÖWAV), the mountain rescue unit and the forest management of the Viennese Water Works. The toilet models were all the same but the configuration varied (external or internal construction). The systems were monitored using online temperature measurements in the composting chamber, the toilet facilities and outside. Sampling was carried out every second month for physical, chemical and microbiological analyses. Pooled sampling was proposed as best practice with sample parts taken from up to five positions evenly distributed over the content of the composting chamber. After cooled transport of the samples, homogenisations and filtration of solid particles using stomacher- bags took place. *Escherichia coli* (*E. coli*) at 37°C and 44°C (thermo tolerant),

thermo tolerant Coliforms and Enterococcus spp. were analysed using standard methods (colony count, CFU) and an alternative method (most probable number, MPN).

### Results and Discussion

Concerning the analytics, the two methods (most probable number- MPN, colony count- CFU) yielded comparable results. However, the standard (CFU) method showed a broader applicability. It was also applicable for the parameters total viable count at 22°C and 37°C as well as the pathogens *Listeria* spp., *Salmonella* spp., *Salmonella* Senftenberg 775W and *Salmonella* typhimurium Phage 28B. The monitoring of the hygienic contamination at the different sampling sites showed that the results strongly depend on the storage time for composting due to the low temperature. However, after two years, a significant decrease of the contamination could be observed. For the selection of hygienic control parameters, the detection limits and the survival periods of the control parameters have been considered. Hence it was suggested, that an appropriate compost quality for disposal is reached after the contamination with thermo tolerant Enterococci (long survival periods) and total coliforms fall below 100 CFU/g and pathogens (*Salmonella* sp., *Listeria* sp., and *Clostridium* p.) cannot be detected at the same time. Based on these assumption, the results of the analyses showed that a total composting period of four years including storage outside the toilet building is necessary to sufficiently reduce the hygienic contamination. Figure 1 shows the monitoring results of one of the investigated sites (4 years of composting and storage) where the proposed quality criteria have been reached and the compost can be disposed to the environment. The suggestions on operation and maintenance as well as on the methodical details for the quality control were summarized in guidelines, which finalize the research activities on composting toilet operation at Alpine objects and will be presented in the full paper.

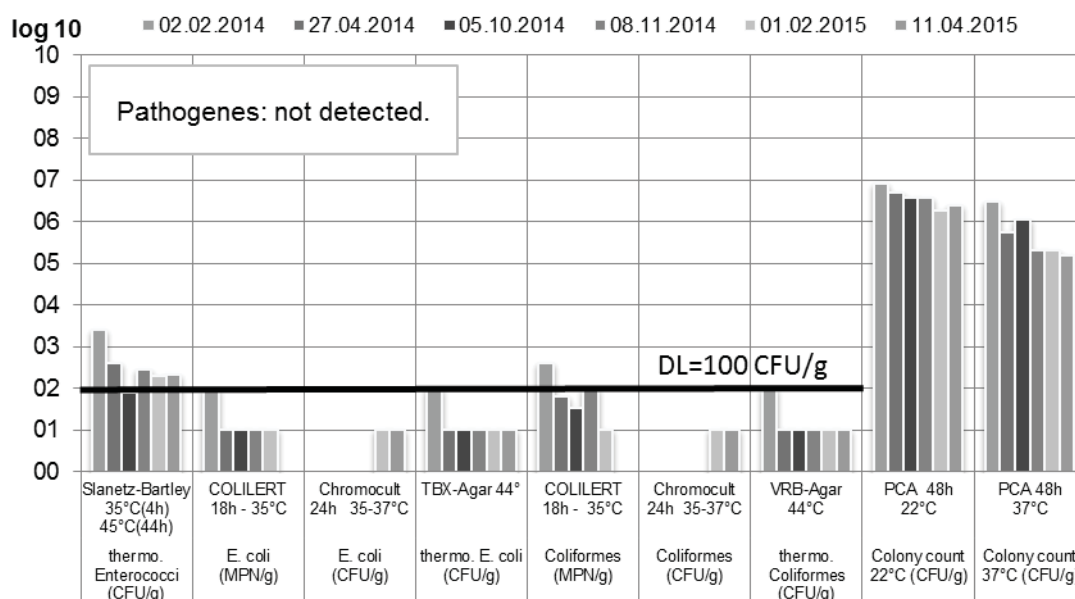


Figure 1. Results of microbiological analyses at the Gloggnitzer Huette (1600 m a.s.l) over 14 months (6 samplings) including parameters and methods applied.

## References

- Eriksen, L., Andreasen, P., Ilsoe, B. (1995): Inactivation of *Ascaris suum* eggs during storage in lime treated sewage sludge. *Water Research* 30, 1026–1029.
- Germer J., Boh M.Y., Schoeffler M., Amoah P. (2010) Temperature and deactivation of microbial faecal indicators during small scale co-composting of faecal matter. *Waste Management* 30: 185–191.
- Hill G.B., Baldwin S.A., Vinneras B. (2013): Composting toilets a misnomer: Excessive ammonia from urine inhibits microbial activity yet is insufficient in sanitizing the end-product. *Journal of Environmental Management*, 119: 29-35.
- Hochwarter, C. (2017) Mikrobiologische Untersuchungen des Komposttoilettenbetriebs. [Microbiological analyses of composting toilet operation; in German] Master Thesis at the University of Natural Resources and Life Sciences Vienna
- Magri M. E. Phillipi L.S., Vinneras B. (2013): Inactivation of pathogens in faeces by desiccation and urea treatment for application in urine-diverting dry toilets. *Applied and Environmental Microbiology*. doi:10.1128/AEM.03920-12
- Schwaighofer C. (2017) Betriebsempfehlungen für Komposttoiletten in Extremlage. [Operation guidelines for composting toilets at remote areas; in German] Master Thesis at the University of Natural Resources and Life Sciences Vienna

# Local Sustainability! - Insights from On-site Wastewater reuse plants around the globe

Ref # S2SMALL- 48474

*H. Rauchl\**, *H. MatamorosI*, *T. Arbell*

1 Aqwise – Wise Water Technologies Ltd., 8 Hamenofim St., Herzliya, Israel , (E mail: harel@aqwise.com )

\* Presenting Author: [harel@aqwise.com](mailto:harel@aqwise.com)

**Abstract:** Water scarcity, sustainable development, groundwater pollution, urbanization & increasing demands on resources are changing traditional forms of water/wastewater management. Many rural areas around the world favors small local wastewater treatment plant that will be used also as local water source. This paper will present 3 successful case studies of small local WWTP around the globe, using MBBR technology. Effluent characteristics from all the facilities exhibit good performance of the facilities and efficient reuse of the water.

**Keywords:** Reuse; Decentralized units; small WWTP, Sustainable, MBBR.

## INTRODUCTION

Water scarcity, sustainable development, groundwater pollution, urbanization & increasing demands on resources are changing traditional forms of water/wastewater management. Additionally, in many rural areas around the world, the large distances between remote communities and central wastewater treatment plants (WWTP) require high investments for the erection of long sewage pipelines.

There are many advantages to decentralized WWTPs, as, eliminating the need and expenses for long sewage pipes, alternative local water sources for irrigation, cooling towers and drinking water, reducing groundwater pollution from potential leakages, lower carbon and environmental footprints.

Small WWT systems based on Moving Bed Biofilm Reactor (MBBR) technology offers several benefits compared to other technologies such as a small foot print, high resistance to hydraulic and toxic shocks, and easy operation.

In the last decade, small plants based on Attached Growth Airlift Reactor-AGAR® MBBR technology are operated around the world. These plants are in a wide range of configurations and sizes, treating flows between tens to hundreds m<sup>3</sup>/day with varying effluent qualities, and different reuse applications as irrigation, toilet flushing and cooling towers. There are several construction methods of WWTP: containerized units, small tanks or concrete structures. The decision of a construction method is dependent on several factors, such as ambient temperature, available area, visibility, operation period, and more.

## THE TECHNOLOGY

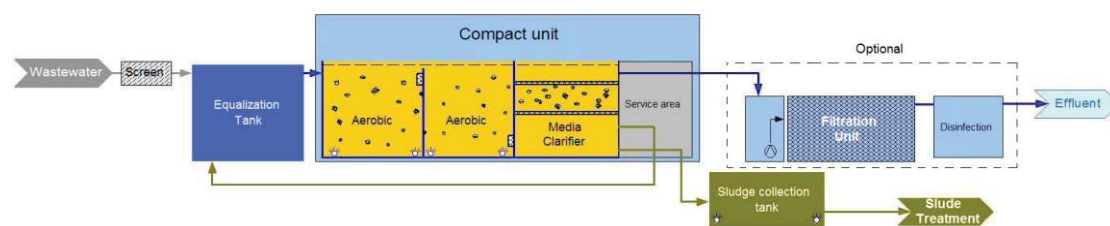
The MBBR process utilizes attached growth biomass on carriers, which enable higher biological efficiency and consequently lower volume of reactor per load (up to 50 %). This small footprint is important for decentralized and small WWTP's, where area is usually a limited resource and there are daily and seasonal flow fluctuations (Ødegaard, 1999). The MBBR AGAR® systems have several possible configurations to answer client demands and/or local regulations.



## **MBBR**

Organic matter and ammonia removal can be accomplished by a two stage MBBR process, followed by a clarifier and fine solids removal (Figure 1). The basic effluent quality after a media clarifier is BOD and TSS of 30 and 20 mg/l, respectively, or 10 and 10 mg/l after sand filtration. Typical HRT ranges between 1.5 to 3 hours in both high and low temperatures.

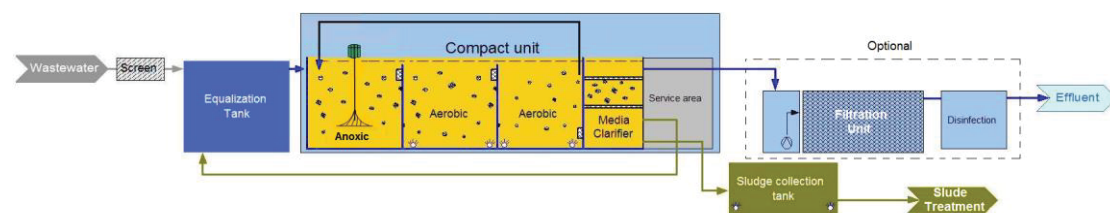
**Media clarifier (MC)** is a unique patented clarifying technology, developed especially for MBBR effluent. The MBBR effluent characteristics, containing mainly the sloughed-off biomass, are different in particle size distribution and biomass morphology compared to activated sludge. MC has several advantages, important to small WWTP, as simple operation, small footprint and no need for chemicals for sedimentation. Since this configuration doesn't include nitrogen removal, it is usually applied for irrigation in small communities, service stations, and remote malls.



**Figure 1:** MBBR system schematic

## **MBBR-BNR**

MBBR BNR includes Biological Nitrogen Removal (BNR) (Figure 2) is achieved via denitrification process in an anoxic reactor. This reactor is usually situated as the first stage in order to utilize the organic matter in the WW as a carbon source. Part of the effluent is recirculated back to the anoxic reactor, and the remaining flows to the clarifier. HRT will depend on water and ambient temperature and will normally be between 4 to 6 hours, for municipal WW.



**Figure 2:** MBBR-BNR system schematic

## **CASE STUDIES**

Three case studies are presented, each one has its unique characterization.

### ***CASE STUDY 1 - Greenfield for reuse Walmart Mexico***

As a leading company in the field of corporate responsibility, Walmart strives to reduce its water footprint by, among other things, reusing sewage in its sites for various applications as irrigation and toilet flushing.

### Challenges

Several challenges had been addressed:

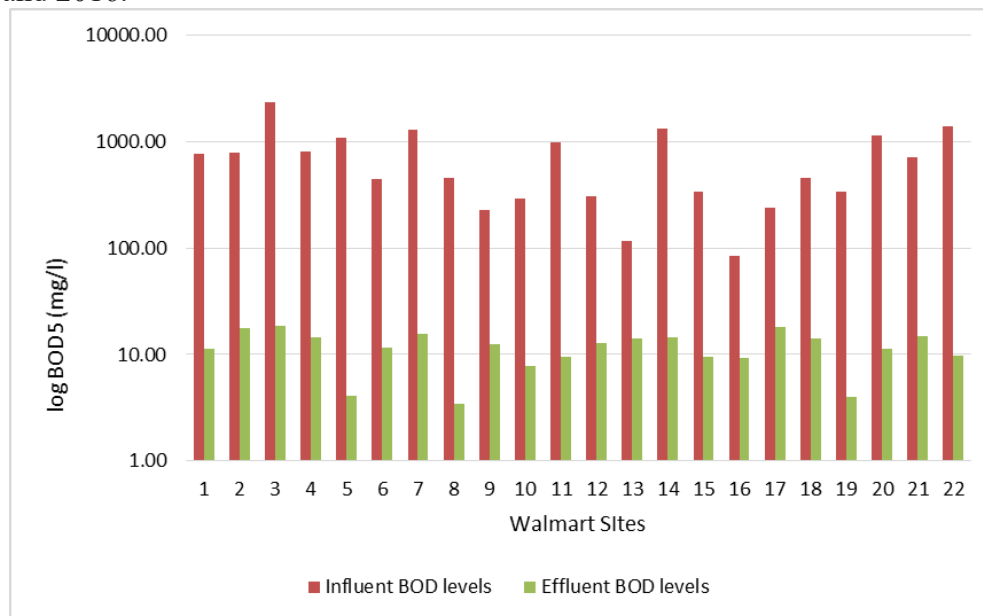
- Various wastewater quality & flows - there are several types of Walmart sites that differ in size and operation. Following that, the technology should cope with various flows and influent qualities.
- Minimal impact - proximity of the plant to the stores requires minimal visibility and environmental impact of the WWTP
- Short recovery time after discharge of toxic compounds to sewage
- Reuse applications - high quality effluent for reuse for toilet flushing and irrigation.

### Solution

During the last 7 years, more than 50 small WWTP, based on the AGAR® including MC technologies, were installed in Walmart facilities around Mexico. Due to the differences in store sizes, several sizes were designed for flows of 25, 45, 90-120 and 150 m<sup>3</sup>/day. The inlet BOD concentrations ranged between a few hundreds to thousands mg/l, while the typical TSS levels were between 200 to 300 mg/l. Due to the close proximity to the stores, the WWTP's were mostly below ground level. The process consists of two aerobic reactors followed by a MC and filtration unit to achieve required quality. After chlorination, the effluent is used for toilet flushing and is recognized by a blue color.

### Results

The following results refer to 22 WWTPs operating for various periods between 2012 and 2016.



**Figure 3:** Average influent and effluent BOD levels at the different sites.

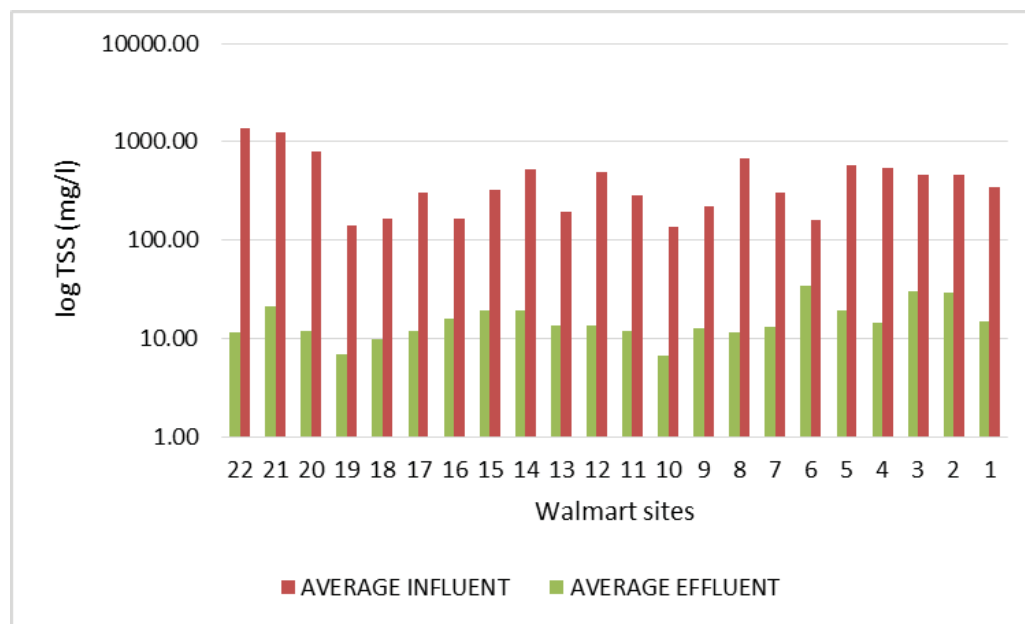
As shown in Figure 3, inlet BOD levels varied between 100 to 2,300 mg/l. Effluent BOD levels meet the required Mexican Standard NOM 003, of 20 mg/L. The BOD removal efficiency in the MBBR-MC process achieved above 98%. As mentioned above, one of the MBBR advantages is the ability to cope with poisonous compounds. A toxic event which caused the death of biomass occurred due

to the discharge of wastewater with high content of solvents. The biomass died in the course of the day generating a bad smell in the plant and very dark foam (Figure 4). Following that, the following measures were carried out: Draining all the water from the reactors and feeding raw non-polluted WW. Water quality recovered in a few days.



**Figure 4:** Quick response of MBBR to toxification

Figure 5, illustrates the influent and effluent TSS levels. Results show that TSS can reach values of up to 1,259 mg/L; nevertheless, the average effluent TSS is 18.31 mg/L. The efficiency in the removal of Total Suspended Solids can reach 95.5%.



**Figure 5:** Average influent and effluent TSS levels at the different sites.



**Figure 6:** Water clarity and color at the different process stages.

Figure 6 presents water appearance at each process stage. In order to avoid an incident of water consumption, a biodegradable colorant (blue) is added to the re-used water for flushing purposes.

***CASE STUDY 2 - Green field , high effluent quality, Valkov, Slovakia***

Valkov is a village on the Velka Domasa lake. The village is a summer recreational site and therefore not inhabited during the winter. Temperatures range between -20°C in winter to 20°C in summer. The village did not have any WWTP and wastewater was discharged to a local septic tank. According to EU directive regulations, the municipality was obligated to treat it in accordance with the wastewater EU directive regulations which included two options: erection of a sewage system and discharge to a regional WWTP or the establishment of a new local WWTP discharge to a nearby lake. Due to the remote location of the village, a local WWTP was the most economical solution.

*Challenges*

Several challenges had to be addressed in this project:

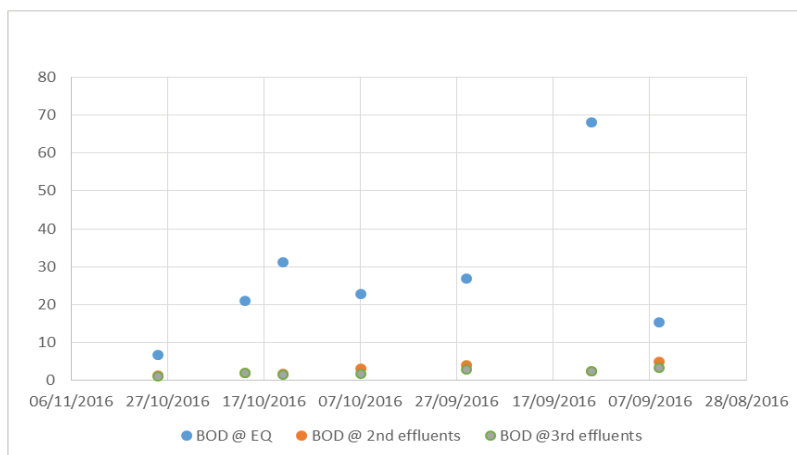
- Quick recovery time after winter shutdown – due to fact that the village is lightly inhabited during winter, the system should be able to recover quickly after long shutdown periods and/or low operation stages.
- Operating during low temperatures
- Minimum to non-negative environmental impact of the WWTP.
- Disinfection without the use of chlorination due to the discharge to the lake.

*Solution*

The solution was to apply the MBBR process which can recover in a few hours, isolating the 40 ft. container & using Polypropylene tanks and the application of UV for disinfection. The containerized unit, enables minimal environmental impact and coping with very low temperature during the cold seasons.

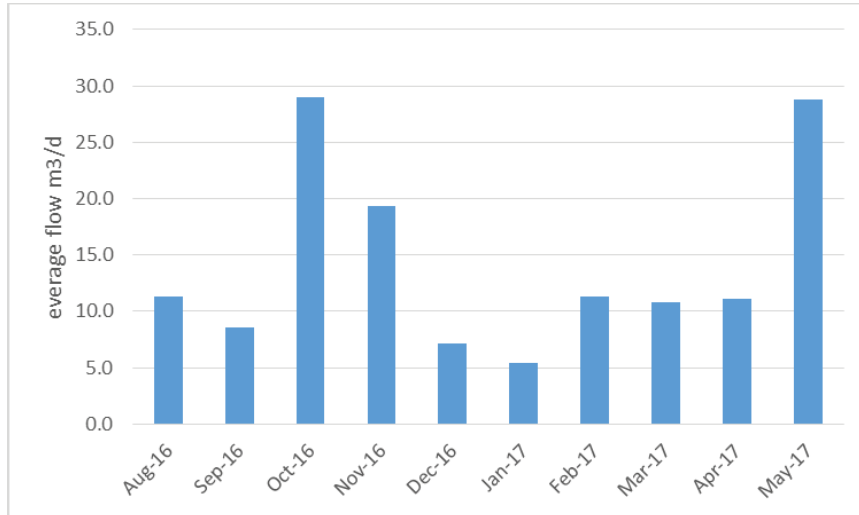
*Results*

The effluent’s quality successfully met the EU directive standards, with COD, BOD5 and NH4-N removal of 75 %, 89 % and 87 %, respectively.



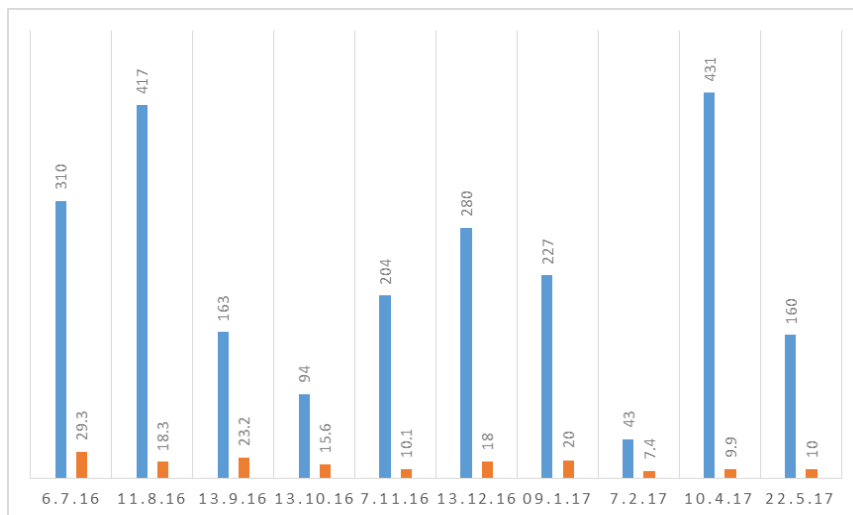
**Figure 7:** BOD inlet and outlet levels during start-up

Results concluded, the system immediately achieved the desired outlet values (BOD less than 10 mg/l). In addition, results show that the BOD was removed to the desired values after the second reactor, meaning that the 3<sup>rd</sup> reactor was not necessary for BOD removal.



**Figure 8:** Average daily flows

The considerable inlet flow difference between summer and winter is shown in figure 8. The average daily flow ranged between 5.5 m<sup>3</sup>/d in January up to the max flow of 28 m<sup>3</sup>/d in May, 2017. Following the discharge to the lake, the discharge standards were stringent, as 35 mg/l for COD for example.



**Figure 9:** Average influent and effluent COD levels 2016-2017.

***CASE STUDY 3 – Containerized unit, Reuse for irrigation, Ramot Shapira, Israel***

Ramot Shapira is a 60 room hotel in the Jerusalem Mountains, serving mainly youth groups during weekdays and vacationers during weekends. The hotel was not connected to the regional sewage system and wastewater was discharged to two septic tanks, which were evacuated by a tanker twice a week. Due to the long time that was required for installation of a sewage pipe, the Ministry of Health (MOH) required the treatment of the wastewater onsite in accordance to the limited irrigation standard.

### Challenges

Several challenges had to be addressed in this project:

- Considerable flow fluctuations between weekdays and weekends.
- Low temperatures during winter time.
- Minimum to non-negative environmental impact of the WWTP.
- Operation for a limited period until installation of the regional sewage pipe was complete.
- Easy operation

### Solution

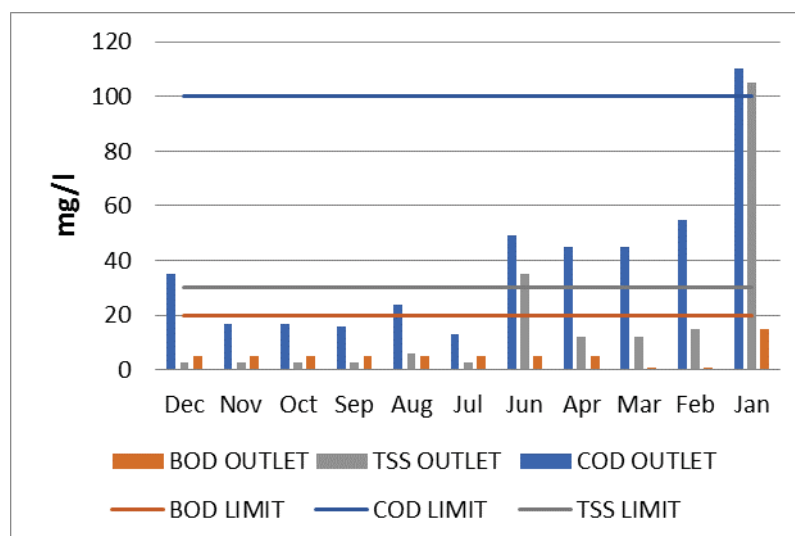
**Table 1:** Design parameters for the WWTP

Parameter	Unit	Value
Design Flow	m <sup>3</sup> /d	50
Temperature	°C	15/30
BOD5	mg/l	400
TSS	mg/l	467
pH	mg/l	6 – 8

A containerized MBBR system was found as the most cost effective solution and referred to the challenges of mobility and minimum impact on the environment (as odor nuisance) and interference to hotel operation. The WWTP included a two stage MBBR process (with a volume of 9.5 m<sup>3</sup> each) and a MC for solids separation. This design enabled very simple operation for the untrained hotel staff (for example, the MC does not require the addition of chemicals). The MOH approved that the treated effluent could be used for irrigation of a nearby forest. The WWTP began operation in October, 2013.

### Results

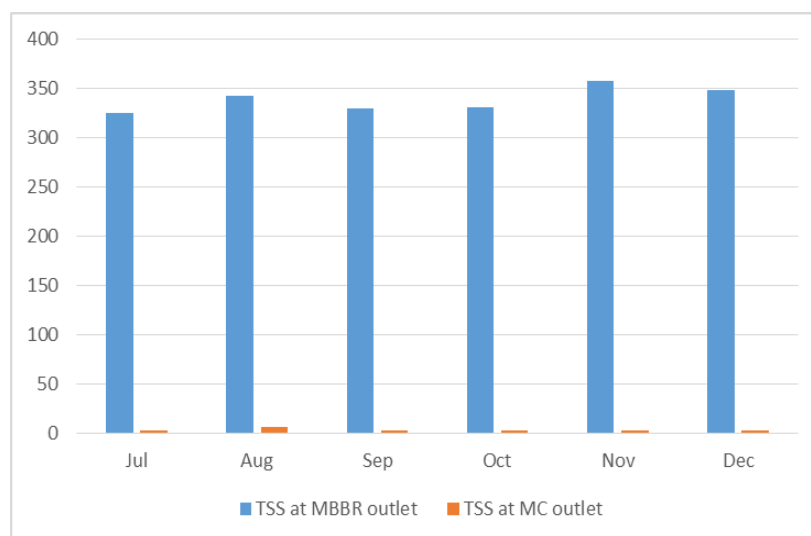
The WWTP has been in operation for almost four years, in which it has operated efficiently and successfully met the required discharge standards of the MOH. Figure 10 illustrates the effluent quality during 2016.



**Figure 10:** BOD and TSS concentration before and after Media Clarifier (MC), 2016.



As illustrated in the Figure 10 COD, BOD and TSS levels were between 50% to 90% below required discharge levels (BOD 20 mg/l, TSS 30 mg/l). The deviation in TSS levels in June was due to improper system operation.



**Figure 11:** TSS values before and after Media Clarifier



**Figure 12:** Effluent after MC

Figures 11 & 12 display the high efficiency of the MC, which enables very high removal of solids without the use of chemicals. Malfunctions may occur if solids are not removed properly from the bottom of the MC or from the carrier blanket.

## **CONCLUSIONS**

Treatment of wastewater at the source with small WWTP may be one of the solutions for water scarcity and global warming problems. The MBBR based WWTP provides a small footprint, durability and offers significant advantages for small remote communities, as demonstrated in the case studies. The technology can recover quickly after poisoning events and operate in low temperatures. Additionally, the possibility of effluent reuse for toilet flushing or irrigation, emphasizes its importance when facing water scarcity and its economical upside.

## **REFERENCES**

- Ødegaard H, 1999, The Moving Bed Biofilm Reactor, Water Environmental Engineering and Reuse of Water, Hokkaido Press 1999 pp. 250-305
- Norma Oficial Mexicana, 1997, NOM-003-SEMARNAT-, Que Establece los límites máximos permisibles de contaminantes para las aguas residuales tratadas que se reusen en Servicios Al Público.
- Ministry of Health, 2010, Israeli Standard for effluent quality.

# Sanitation and Water Reuse for urban gardening in informal settlement: Lessons learnt from a systemic approach in Namibia

Ref # S2SMALL-67699

K. Müller<sup>1,2</sup>, J. Sinn<sup>1\*</sup>, P. Cornel<sup>1</sup>, S. Lackner<sup>1</sup>

<sup>1</sup> Technische Universität Darmstadt, Institute IWAR, Franziska-Braun-Str. 7, 64287 Darmstadt, Germany

<sup>2</sup> Association for Technology and Structures in Agriculture (KTBL, Kuratorium für Technik und Bauwesen in der Landwirtschaft), Bartningstraße 49, 64289 Darmstadt, Germany

\* Corresponding Author: j.sinn@iwar.tu-darmstadt.de

**Abstract:** A holistic approach and consideration of new concepts for water supply and sanitation is required to maximize the achievable benefits. Two research projects in the same town in Northern Namibia aim at filling knowledge gaps acting as barriers to implementation of new planning approaches and technologies in sanitation and water reuse. Especially during systemic planning of sanitation and water reuse projects in developing countries it is essential to address risks and challenges within the local context and from various perspectives. For the first project these were particularly concerning technical, economical, agricultural, social issues, operation and management, as well as the lack of national guidelines for water reuse. Consequently, those aspects were taken into account during the design phase of the second project. Compared to the first project, its scope was extended at regional and institutional level. For sustainability, a sound basis of data on technical aspects and socio-cultural issues are as important as flexibility for adaptation. With the presented risks and challenges encountered during implementation this research contributes valuable information for future projects in similar contexts.

**Keywords:** developing countries, informal settlement, irrigation, systemic approach, urban gardening, wastewater pond

## INTRODUCTION

There is a consensus that, for comprehensive implementation of sanitation concepts, a holistic and integrative view of all system components is required (IWA 2005; Wilderer 2005; McConville et al. 2011; Tiberghien et al. 2011). New approaches in concept development and new technologies allow a linkage of components that were considered separately in the past (McConville et al. 2011; Schramm et al. 2013). However, new concepts for water supply and sanitation play only a minor role in the practical world (Marlow et al. 2013). In most cases, design engineers and stakeholders favor conventional approaches and technologies instead of new approaches (Nelson and Murray 2008).

At first, there is the need to consider the entire water chain to maximize achievable benefits of sanitation systems and to better match the individual components with each other. Second, there is a knowledge gap that needs to be filled in order to change the perception of new approaches among stakeholders, compared to conventional approaches.

To address these issues, a research project was developed in the North of Namibia. The preliminary studies that were the basis for this initiative already started in 2004 (Kluge et al. 2008). Then, CuveWaters - a first project on sanitation and water reuse in Outapi - was implemented between 2009 and 2015 (Müller et al. 2017). Based on the experiences and lessons learned, the follow-up project EPoNa ("Enhancement of Ponds in Namibia") was initiated in 2015 and started in 2016 (BMBF 2017) (see [www.epona-africa.com](http://www.epona-africa.com) for details).

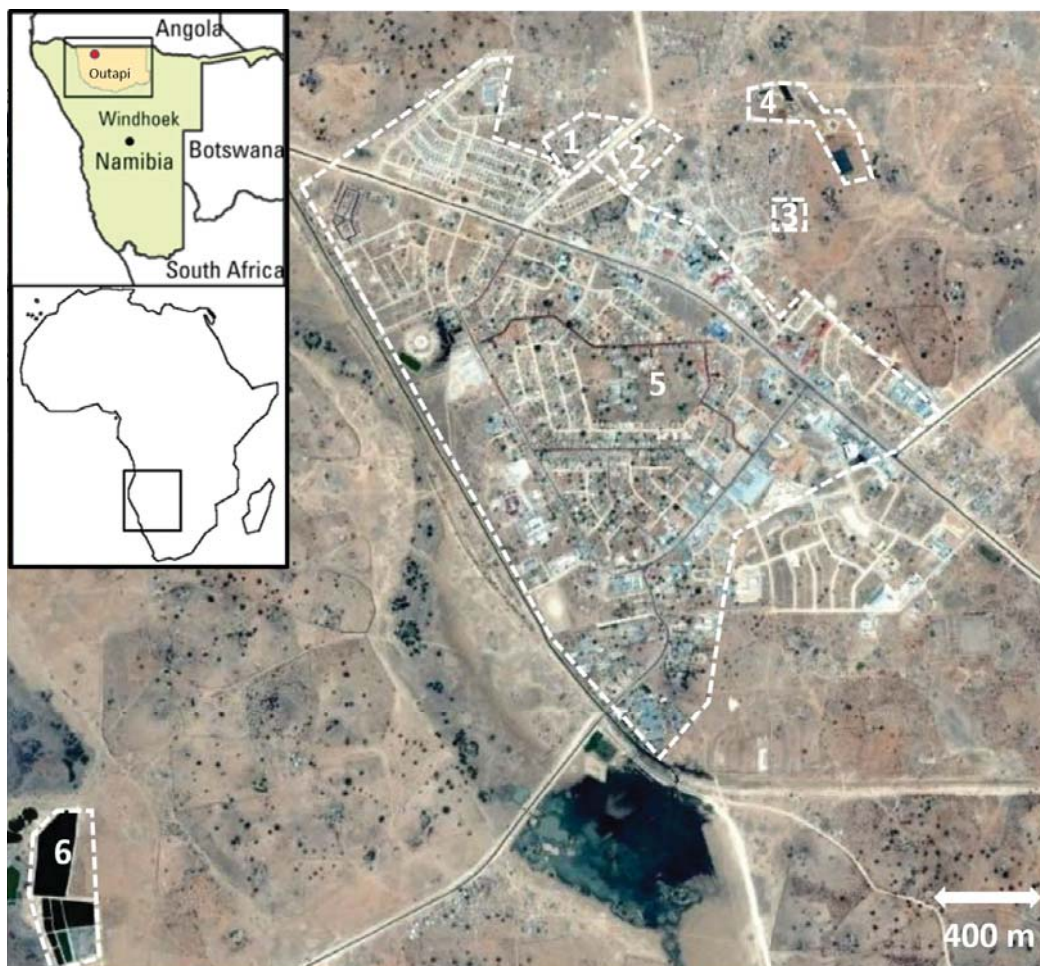
Sanitation and water reuse projects in developing countries face several challenges. Especially during planning and implementation there are many factors and uncertainties influencing the

decision-making process. This article explores the main challenges and knowledge gaps encountered during implementation of CuveWaters and how lessons learned were used to improve the follow-up project EPoNa. This research presents a systemic approach, with technical and socio-cultural issues for future projects in a similar context. With the outcome of this work, obstacles to the implementation of new concepts in urban water management will be reduced and the achievable benefits of sanitation systems are maximized.

## MATERIALS AND METHODS

### *Study site*

The studies were carried out in the city of Outapi in Northern Namibia (Figure 1). In 2011, Outapi had a total population of 6,437 persons (NSA 2011). In its informal settlements, simplest sanitary facilities are used or open defecation is practiced. Some dry toilets are available, but often collapse during the rainy season when the area is flooded. Maintenance or regular cleaning is lacking. For personal hygiene, at best, self-made sheds are available. Collection or removal of feces and used water does not occur.



**Figure 1.** Location of the components of CuveWaters: cluster units (1), individually connected households (2), communal washhouse (3), water reuse plant and irrigation sites (4) and EPoNa components: gravity sewer (5) and wastewater ponds (6) (Google Earth (Version 7.1.8.3036) 2016, Price and Hegnauer 2017, modified).

In town districts that are better developed, flush toilets are used. The wastewater is transported by a conventional gravity sewage system to non-aerated ponds (shallow pools for collecting and evaporating wastewater). The ponds are overloaded and overflowing. There is no receiving water, which could take the treated effluent. Reclamation or reuse of this water did not occur either.

#### *CuveWaters (2009-2015)*

The objective of this research project is to develop and implement a sanitation system that responds to the water and sanitation challenges in the region. From 2009 to 2015, three types of sanitation facilities (communal washhouse, cluster units and individual household connections) for up to 1,500 users are developed and evaluated in different informal settlements. Vacuum sewers transport the wastewater to a newly built treatment plant. The wastewater treatment consists of an anaerobic treatment with upstream anaerobic sludge blanket (UASB) reactors, aerobic treatment with rotating biological contactors and lamella clarifiers, 10 µm microscreen for the removal of helminth eggs and UV-disinfection followed by storage in 2 subsequent polishing ponds. Wastewater sludge and agricultural residues are co-digested and the biogas is used for generation of electricity and heat. The Outapi Town Council (OTC) operates the vacuum sewers and wastewater treatment plant and sells the treated water to the operator of the irrigation site who reuses the water for irrigation of vegetables for human consumption. More details on the technical design of the wastewater treatment plant and the irrigation site are provided in Müller et al. (2017) and Zimmermann et al. (2017).

#### *EPoNa (2016-2019)*

The follow-up project EPoNa was developed in order to sustainably reuse the effluent of existing wastewater ponds for the irrigation of fodder crops for animals and to reduce the risk of environmental contamination by overflowing pond water during rainy season.

The only wastewater infrastructure in Outapi before CuveWaters was a gravity sewer system in developed parts of Outapi and wastewater stabilization ponds that were constructed in 2004. According to the Namibian code of practice (DWA 2008) all effluents from wastewater treatment ponds are to be evaporated and not to be discharged into the environment. The specifically built evaporation pond has already been overflowing several times. This was due to high population growth, continuous extension of the gravity sewer system and infiltrating water during the rainy season. The surrounding dam was damaged already in 2008 or before. Especially during rainy season, the surrounding ephemeral surface waters risk contamination caused by low treatment efficiency and overflow.

The pond system is based on two parallel lines of four ponds each, a primary facultative pond followed by three maturation ponds. All eight ponds have a water surface of 40,000 m<sup>2</sup> and a volume of 55,000 m<sup>3</sup>. The final evaporation pond has a similar surface of 41,000 m<sup>2</sup> but due to its shallowness a volume of only 20,000 m<sup>3</sup>. The original design was to operate the two lines in an alternating rhythm. The improvement of the pond system will commence with one line, whilst the second line will remain in its present stage to act as a comparison for gauging the effect of the modifications. At the inflow of the plant a pretreatment consisting of a UASB reactor and a microscreen will be installed in parallel to reduce the organic load. During the research the two different technologies will be compared regarding their efficiency within the local context. Additionally, baffles are installed in the first pond to approach a plug flow reactor rather than the current uncontrolled mixed reactor. For the post-treatment a rock filter is planned to reduce solids and algae effecting the irrigation system. Different irrigation



techniques and crops are compared on small trial plots and large scale irrigation will follow based on the results from those fields.

When the ponds were constructed in 2004, Outapi had only half the population of today, with only a small proportion (about 2,500) having access to sewerage services. However, in 2016 more than double the population in this constantly growing town was connected to the gravity sewers. This increase presents a challenge for OTC who is also operating and maintaining the wastewater ponds.

## **RESULTS AND DISCUSSION**

### *CuveWaters*

During planning of CuveWaters, possible risks and challenges were analyzed with local experts and discussed with future users during local workshops. Important aspects that had to be considered for planning purposes were floods during the rainy season and the dynamic urban population development. Specific risks were vandalism and misuse of sanitation facilities, damage from garbage and other foreign objects in the wastewater. Those risks were overcome by hygiene education via community health clubs, a demand-responsive approach, capacity development of users, operating and management staff and installations such as screens and crusher and a flexible design of wastewater treatment steps. The mentioned measures made it possible to put the sanitation system into operation. However, new challenges arose during realization of this project:

#### 1. Fruit stones in the wastewater

Stones from the eembe fruit, which is part of the local diet, caused damage to pumps and required retrofitting of a further screen. Therefore, technical planning should provide for additional space to install additional or rearrange existing equipment.

#### 2. Specific water quantities, loads and utilization of shared sanitation facilities

After implementation, utilization of the sanitation facilities, water quantities, and loads were lower than planned. This affected the sanitation system in several ways. Revenue collection from tariffs charged to the users was lower than estimated. Thus, less money was available for covering the running costs. Less irrigation water was available; thus, additional tap water had to be used to irrigate the agricultural fields. This meant lower revenues for the local farmers because tap water had to be bought from the OTC. In addition, this also meant lower revenues for the OTC that sold the reclaimed water to the farmers. Vice versa, less available irrigation water means, that a smaller area can be cultivated if another water source is not available or affordable. This lowers the revenues from the sale of crops and the amount of residues available for co-digestion.

Overall, the effort to operate the sanitation system was relatively high compared to treated water quantities. This led, for example, to a relatively high specific electricity consumption per cubic meter of treated water, due to the lower degree of efficiency of motors and pumps as their capacity was not fully used because of the low hydraulic loading.

#### 3. Management system of shared sanitation facilities

The operational concept of the sanitation facilities has a direct influence on the construction layout. For instance, separate control of visitor flows is required if an operational concept includes free access for one or several uses and charges for other uses (e.g., if the municipality

wishes to offer free access to toilets). This can be achieved via the separation of visitor flows or by prepaid systems (e.g., coin-operated showers and laundry sinks) and needs to be taken into account already during planning.

Ideally the operational concept is agreed on before construction starts as this has to be considered for the detailed planning of sections, entrances, and exits. Once the permanent structures of the building are finished it is difficult to switch to another operational arrangement. Therefore, different operation modes need to be discussed and the best solution identified before construction starts. Even with thorough planning and behavioral evaluations, the technical design needs to be as flexible as possible to allow for operational changes.

#### 4. Involvement of social scientists required

During the course of the project, social scientists played an important role. Planning and implementation started with a community-based situation assessment, as part of the demand responsive approach used for development of the technical layout (Kramm and Deffner 2017). The adaptation of the community health club approach was developed, together with an NGO and local partners, to meet project and community needs (Waterkeyn 2010; Deffner and Böff 2012). However, the practical benefit of sociological studies can be further increased.

In this project, utilization of the sanitation facilities was lower than expected. Especially urination in the public was still widely practiced, even when toilets were available free of charge in the vicinity (cluster units) or on the household level (individual households). This was observed not only in this study but also in a study on shared sanitation facilities in South Africa (Crous et al. 2013). Hence, access to toilets needs to be made very easy, in order to compete with the convenience of urination in public. In practice, this is very difficult to achieve. The design of the facilities was discussed with the residents during several workshops and adapted accordingly (Deffner and Mazambani 2010). Hence, it can be assumed that the technical layout is satisfactory. Further studies should focus on other possible barriers to the use of the sanitation facilities (e.g., habits, behavior patterns). The involvement of social scientists is crucial to make sure that the provided infrastructure is fully used. It is most important to show the connection between hygiene and health.

#### 5. Soil salinization and overfertilization

During planning, the salt and nutrient loads and concentrations in the irrigation water were expected to be relatively high, and there seemed to be a high risk of salinization, overfertilization, and eutrophication. After implementation, the loads and concentrations were considerably lower due to a relatively high amounts of water and relatively low specific loads collected by the shared sanitation facilities. On the whole, the nutrient and salt content of the irrigation water roughly met the requirements of crops and soil.

#### 6. National guidelines on irrigation water quality

The project was implemented in a setting in which national regulations for reclaimed water quality did not yet exist. Thus, water quality criteria and objectives had to be defined. The FAO and WHO guidelines were used for monitoring irrigation water quality. In order to meet the requirements of water reuse projects, additional water quality objectives for turbidity, BOD<sub>5</sub>, TCOD, TP, and K were suggested. The storage pond was initially included in the sanitation system to balance supply and demand of the irrigation water. However, it turned out to be necessary to achieve the required water quality (see Müller and Cornel (2017) for details).



## *EPoNa*

Following the experience from CuveWaters, EPoNa was initiated and started by the community itself. The lessons learned and the self-reflection from the first project lead OTC to a needs and risk assessment. During this process the fodder shortage at the end of the dry season and the improvement of the surface water quality were prioritized. Consequently, enhancement of the overloaded wastewater ponds was targeted. Other issues such as floods and dynamic population growth were also considered as with CuveWaters.

As it turned out to be a key point in CuveWaters, EPoNa is also based on a systemic approach to overcome the shortcomings of conventional sanitation systems. The project team includes professionals from different disciplines. Social scientists and environmentalists are analyzing the intended and non-intended effects on the environment and the community. Agronomists will test and evaluate different irrigation systems as well as various crops, at first at a pilot scale which is followed by a large scale implementation. Engineers are involved for the design, construction and operation of the new pre-treatment, flow improvement, post-treatment as well as the quality assurance.

Within CuveWaters one focus was on the comparison of different sanitation technologies in informal settlements. In order to account for the whole situation of the town EPoNa now reflects the existing sewer system and the existing wastewater treatment. Therefore, it is not envisaged to develop further sanitation systems but to focus on the treatment and reuse aspects. The design capacity of CuveWaters was 1,500 inhabitants, whilst the wastewater ponds of EPoNa are serving the remaining population of about 6,000 people.

The lessons learned from CuveWaters are directly influencing the approach of EPoNa. The pre-treatment is designed to eliminate the stones from the eembe fruit and other unexpected substances in the wastewater and enough space is given for future alterations. A similar flexibility is integrated into the size of the irrigated fields. At first trial plots are cultivated and later extended to a larger scale once the water quantities and qualities are evaluated. This information also helps to determine the type and amount of crops that can be irrigated and therefore deliver financial revenues which ensure the economical sustainability of the system.

Besides technical and economic aspects, managerial issues are of further importance. This has been shown for the CuveWaters sanitation system and will be addressed for the operation of wastewater treatment plant and irrigation site of EPoNa as well. The involvement of social scientists is especially relevant for the understanding of barriers in using shared sanitation systems, but also for the acceptance of reused water for animal fodder production. Especially as the animals represent an important aspect of the traditional local society.

In order to supply the best yields, the planted crops need to be adapted to the receiving salt and nutrient contents. In the given context it was shown during CuveWaters, that the risk of soil salinization and overfertilization was reduced due to lower loads and concentrations in the treated water. This will also be considered with EPoNa and the crop varieties adapted to make best use of the final effluent.

For all projects guidelines on the quality of the reused water are important, particularly for the protection of health of workers and the community as well as the environment. The quality requirements for the irrigation of food crops developed during CuveWaters are an important basis for EPoNa and will be adapted for the irrigation of fodder crops.

Whilst CuveWaters was implemented with three partners, EPoNa has now six partners who are responsible for their specialty which are: process engineering, civil engineering, agriculture and irrigation, economy, socio-ecological research and water quality analysis. When implementing CuveWaters, emphasis was put on safeguarding long-term operation of

the implemented facilities and embedding appropriate management structures at the OTC. The activities of EPoNa go beyond the town boundaries of Outapi. Besides OTC there is also a focus on the neighboring towns in the north of Namibia with similar wastewater pond systems and similar problems as encountered in Outapi. The results from EPoNa are shared through a partnership of plant operators and can therefore be used for the improvement of the wastewater situation in the region. This partnership is also supported through the water basin management committees who are operating under the Ministry of Agriculture, Water and Forestry. Further involved are the Ministry of Urban and Rural Development as the guiding institution of the town councils as well as the Ministry of Environment and Tourism who is responsible for all environmental impacts. On the educational level there is strong cooperation with the local university which is using the projects as case study for their lectures and at the same time practical training is supported by a vocational training institute and the results reflected in their curriculum.

The technology implemented at the CuveWaters wastewater treatment plant involved considerable investment costs and due to low water quantities the operation and maintenance costs per cubic meter are high. With EPoNa the per unit cost of reuse water is expected to be lower due to reduced water quality requirements and due to higher flow rates.

For long-term assistance in operation and management of the infrastructure installed during the two projects, a German partner was identified who assists and trains the local plant operators with experienced personnel on a regular basis. This exchange provides mutual benefits. OTC receives support and feedback on its plants and the German technicians can prove and extend their technical skills and knowledge under different working conditions in a different cultural context.

## **CONCLUSIONS**

Each project has its specific focus and has to consider the local situation. CuveWaters was primarily based on new installations around the water cycle, sanitation, wastewater collection, wastewater treatment and reuse for food crops. EPoNa is now concentrating on the improvement of existing systems with a focus on low cost wastewater treatment, irrigation of fodder crops, transfer to neighboring towns and partnership of wastewater plant operators.

For the sustainable implementation of sanitation and wastewater projects in the context of developing countries a certain flexibility is always needed. However, experiences from preceding projects can help to overcome challenges more easily. The lessons learned from one project have to be put into their context and can then be useful for others.

On the technical scale additional space requirements have to be allowed due to unexpected substances in the wastewater that may require retrofitting of the existing installations. For the economical sustainability it is important to have the best estimates of the specific water quantities and loads as this will determine the type and amount of crops that can be irrigated and therefore deliver financial revenues. Besides technical and economic aspects a strong focus on managerial issues is also needed. The same applies for the involvement of social scientists. They are needed to identify barriers in using shared sanitation systems and to evaluate the acceptance of reused water for the irrigation of vegetables for human consumption and animal fodder. On the irrigation site, it is important to control the risks of soil salinization and overfertilization. Therefore, good water quality analysis and flexibility in the type of crops are needed to make best use of the final effluent.

For all projects guidelines on the quality of the reuse water are important. Especially for the protection of health of workers and the community as well as the environment this is

essential. If those guidelines do not exist in the country, international guidelines can be used, but need to be adapted to the local context. The results of the research can then also be an important indicator for the development of national guidelines.

## REFERENCES

- BMBF 2017 EPoNa – Upgrade of Wastewater Ponds in the North of Namibia – Factsheet. [http://www.epona-africa.com/images/News/18.04.2017/Factsheet\\_EPONA\\_English.pdf](http://www.epona-africa.com/images/News/18.04.2017/Factsheet_EPONA_English.pdf) (accessed 10 July 2017)
- Crous, P., Haarhoff, J. and Buckley, C. A. 2013 Water demand characteristics of shared water and sanitation facilities: Experiences from community ablution blocks in eThekweni municipality, South Africa. *Water SA*, **39**(3), 361–367.
- Deffner, J. and Böff, J. 2012 Participatory sanitation marketing approaches for altering hygiene behavior: A review of community health clubs and community-led total sanitation, Institute for Social-Ecological Research (ISOE). <http://www.cuvewaters.net/fileadmin/edit/Downloads/Publications/cuvewaters-papers-9-2012.pdf> (accessed 11 June 2016).
- Deffner, J. and Mazambani, C. 2010 *Participatory empirical research on water and sanitation demand in central northern Namibia: A method for technology development with a user perspective*, CuveWaters Papers, **7**. Institute for Social-Ecological Research, Frankfurt/Main.
- DWA 2008: *Code of practice: Volume 2 Pond Systems, General Guidelines*, July 2008, Department of Water Affairs and Forestry, Ministry of Agriculture, Water and Forestry, Windhoek.
- Google Earth (Version 7.1.8.3036) 2016 Outapi, Namibia: 17° 30' 05.06" S 14°59'24.45"O, elevation 1114 m. <http://www.google.com/earth/index.html> (accessed 09 July 2017).
- IWA 2005 *Sanitation 21. Simple approaches to complex sanitation. A draft framework for analysis*. IWA Publishing, London.
- Kluge, T., Liehr, S., Lux, A., Moser, P., Niemann, S., Umlauf, N. and Urban, W. 2008 IWRM Concept for the Cuvelai Basin in Northern Namibia. *Physics and Chemistry of the Earth*, **33**(1-2), 48–55.
- Kramm, J. and Deffner, J. 2017 Social aspects of new sanitation infrastructure. In: *Integrated water resources management in water-scarce regions. Water harvesting, groundwater desalination and water reuse in Namibia*, S. Liehr, J. Kramm, A. Jokisch and K. Müller (eds.), IWA Publishing, London.
- Marlow, D. R., Moglia, M., Cook, S. and Beale, D. J. 2013 Towards sustainable urban water management: a critical reassessment. *Water Research*, **47**(20), 7150–7161.
- McConville, J., Norström, A. and Lüthi, C. 2011 Planning for sustainable sanitation. In: *Sustainable sanitation in cities. A framework for action*, C. Lüthi, A. Panesar, T. Schütze, A. Norström, J. McConville, J. Parkinson, D. Saywell and R. Ingle (eds.), Papiroz Publishing House, Rijswijk, pp. 84–102.
- Müller, K. and Cornel, P. 2017 Setting water quality criteria for agricultural water reuse purposes. *Journal of Water Reuse and Desalination*, **7**(2), 121–135.
- Müller, K., Cornel, P. and Gerlach, M. 2017 Collection, transport and treatment. In: *Integrated water resources management in water-scarce regions. Water harvesting, groundwater desalination and water reuse in Namibia*, S. Liehr, J. Kramm, A. Jokisch and K. Müller (eds.), IWA Publishing, London.
- Nelson, K. L. and Murray, A. 2008 Sanitation for unserved populations: technologies, implementation challenges, and opportunities. *Annual Review of Environment and Resources*, **33**(1), 119–151.
- NSA 2011 Namibia 2011: Population & housing census main report, Namibia Statistics Agency (NSA). <http://cms.my.na/assets/documents/p19dmn58guram30ttun89drp1.pdf> (accessed 27 July 2016).
- Price, P. and Hegnauer, O. 2017: Staatswappen Afrika, Umriss/Länder. [http://www.swissfot.ch/html\\_public\\_d/wappen/world/Af/Africa\\_Umriss\\_Laender.htm](http://www.swissfot.ch/html_public_d/wappen/world/Af/Africa_Umriss_Laender.htm), (accessed 9 July 2017).
- Schramm, E., Kluge, T., Beck, S., Hansjürgens, B., Hiessl, H. and Sartorius, C. 2013 Integrierte Systemlösungen als Strategie für eine nachhaltige und exportstarke Wasserwirtschaft. *Wasser und Abfall*(1/2), 39–44.
- Tiberghien, J. E., Robbins, P. T. and Tyrrel, S. F. 2011 Reflexive assessment of practical and holistic sanitation development tools using the rural and peri-urban case of Mexico. *Journal of Environmental Management*, **92**(3), 457–471.
- Waterkeyn, J. 2010 *Hygiene behaviour change through the community health club approach: A cost effective strategy to achieve the millennium development goals for improved sanitation in Africa*. LAP Lambert Academic Publishing, Saarbrücken.
- Wilderer, P. 2005 Sustainable water management in rural and peri-urban areas: what technology do we need to meet the UN development goals? *Water Science and Technology*, **51**(10), 1–6.
- Zimmermann, M., Liehr, S. and Kluge, T. 2017 Economic viability, tariffs and financing options. In: *Integrated water resources management in water-scarce regions. Water harvesting, groundwater desalination and water reuse in Namibia*, S. Liehr, J. Kramm, A. Jokisch and K. Müller (eds.), IWA Publishing, London.

# Wastewater Reuse for Irrigation – unconventional or un-welcome resource? Local perceptions on barriers and drivers for reuse in Egypt, Morocco and Tunisia

Ker Rault, P.A.<sup>1</sup> El-din Abdin. A<sup>2</sup> . Choukr-Allah R.<sup>3</sup> Jaouani A<sup>4</sup> . , Karajeh F.<sup>5</sup>, Frascari D<sup>6</sup>.

<sup>1</sup> Wageningen Environmental Research The Netherlands,

<sup>2</sup> National Water Research Center Egypt

<sup>3</sup> Hassan II Institute of Agronomy and Veterinary Medicine, Morocco,

<sup>4</sup> University of Tunis El Manar,

<sup>5</sup> Food and Agriculture Organisation of the United Nations – regional office for Near East and North Africa,

<sup>6</sup> University of Bologna Italy

\*Corresponding author

**Keywords:** Wastewater reuse, Irrigation water vulnerability, Complexity, Arid region

## Abstract:

In a resource constrained world with increasing variability in rainfall pattern due to climate change, and salinization of groundwater aquifers, Wastewater Reuse (WWR) for irrigation enables to reframe WASH “waste” as a resource and to optimise the value of fresh water resources. Wastewater reuse offers benefits for the environment by reducing withdrawal from ground water resources (particularly fossil) and surface water competing with water for human and cattle consumption. Wastewater reuse also benefits farmers and crops yield due to its constant supply and high content in NPK. Treated Wastewater reuse, as a water resource, can significantly contribute to mitigate water vulnerability especially in the light of changing rainfall pattern and temperature increase due to climate change.

However, in many countries, WWR lacks of a legal framework, training, capacity building, dialogue and political courage. This unconventional resource is not welcome by national institutions because of an unclear bunch of misunderstandings around potential risks associated with its origins, usages, potential threat to the environment and human activities (farming, transformation & trading, cooking etc...). Treated water, also called reclaimed water suffers systematic comparison with drinking water and this up to the norms and standards define its legal suitability for application. But plants do not need drinking water. Nevertheless one can only acknowledge that too many farmers irrigated with wastewater (treated or untreated) because they have no other choice. Promoting and building capacity to WWR is anticipated to encourage local communities and institutions to better manage this “resource” for farmers and consumers.

Irrigation with treated waste water is a complex problem because it brings challenges of different nature bouncing on each other: technical, agronomical, economic, cultural, political, legal, institutional and many more.

The project Mad4Water aims to develop an integrated set of technological and management instruments for the enhancement of wastewater treatment, treated wastewater reuse for irrigation and water efficiency in agriculture, with the final aim to reduce water vulnerability in selected basins in Egypt, Morocco and Tunisia. The selected basins are: North Eastern Nile Delta in Egypt, Cap-Bon and Miliane in Tunisia, Souss-Massa in Morocco.

This article reports the methodology developed to investigate the factors that influence the development and application of technologies and management tools in the field of water management. Factors that prevent (negative influence) such development are called Barriers, and those that encourage it (positive influence) the reuse are called Drivers.

A questionnaire and three (3) participative workshops with local stakeholders have been organized to better understand the complexity to promote and implement safe and productive irrigation with treated waste water. Preliminary results of perceived Barriers and Drivers according to local stakeholders in Egypt, Morocco and Tunisia are being analyzed.

# Treated Greywater Reuse for Hydroponic Lettuce Production in a Green Wall System - Quantitative health risk assessment

Ref # S2SMALL-60659

**Fasil Ejigu Eregno\*, Melesse Eshetu Moges, and Arve Heistad**

Faculty of Science and Technology, Norwegian University of Life Sciences (NMBU), P.O. Box 5003, NO-1432 Ås, Norway

\* Correspondence: [fasil.eregno@nmbu.no](mailto:fasil.eregno@nmbu.no)

**Keywords:** Source separation system; Greywater treatment; Water reuse; Hydroponic system; Green wall; Heavy metals bioaccumulation; QMRA; Health risk assessment

## Abstract

The scarcity and pollution of freshwater are extremely crucial issues today and the expansion of water reuse have been considered as an option to reduce its impact. This study aims to assess the efficiency of an integrated greywater treatment system and hydroponic lettuce production as a part of a green wall structure and to evaluate the health risk associated with the production and consumption of lettuce through quantitative microbial risk assessment (QMRA) and chemical health risk assessment. The study was conducted based on the unique configuration of source separation system; on-site greywater treatment system; green wall structure as a polishing step; and hydroponic lettuce production in the green wall structure. The final effluent from the system was used to grow three lettuce varieties by adding urine as a nutrient solution. Both water samples and plant biomass were collected and tested for *E. coli* and heavy metals contamination. The system has gained a cumulative 5.1 log<sub>10</sub> reduction of *E. coli* in the final effluent and no *E. coli* found in the plant biomass. The estimated annual infection risk for *cryptosporidium*, *Campylobacter*, and norovirus were 10<sup>-6</sup> - 10<sup>-8</sup>, 10<sup>-8</sup> - 10<sup>-10</sup>, and 10<sup>-10</sup> - 10<sup>-11</sup> respectively. These results indicate the system attained the health-based targets, 10<sup>-6</sup> disability adjusted life years (DALYs) per person per year. Similarly, health risk index (HRI) and targeted hazard quotient (THQ) results did not exceed the permissible level, thus the chemical health risk concern was insignificant.

# A preliminary survey on public attitude for the reuse of grey water as an alternative source of water in Turkey

Ref # S2SMALL-131286

Beler Baykal, B.<sup>1</sup>, Efe, H.<sup>1</sup>, Afacan, E.<sup>1,2</sup>, Arslan, E.<sup>3,4</sup>

<sup>1</sup> Istanbul Technical University, Department of Environmental Engineering, 34467, Maslak, Istanbul, Turkey

<sup>2</sup> National Research Center on Membrane Technologies, 34469, Maslak, Istanbul, Turkey

<sup>3</sup> Istanbul Technical University, Department of Textile Engineering, 34437, Beyoglu, Istanbul, Turkey

<sup>4</sup> Arcelik R&D Center, Cleaning Technologies Department, 34950, Tuzla, Istanbul, Turkey

\* Presenting Author: efehi@itu.edu.tr

**Abstract:** Current water availability in Turkey indicates water stress and a high possibility of water scarcity within a couple of decades, however the practice of the recent domestic wastewater management that introduces grey water reuse as an alternative source is limited. The success of grey water reuse applications is highly related to public willingness and acceptance. This preliminary survey/study involving 300 respondents was designed to gain insight about readiness/willingness of the community focusing upon awareness regarding water stress/scarcity, grey water as an alternative source, and acceptance with regard to the reuse of different fractions of grey water and possible end uses. The results indicated that hand wash basins were the most acceptable points of origin of grey water in a household (63%), while toilet flushing was the most preferred final reuse area (88%). Considering different groups of food stuff, green areas, and industrial plants irrigated with grey water, food stuff consumed after cooking received the highest preference (69%), while landscape areas were the most accepted irrigated green area (84%). For industrial plants, cotton grown upon grey water received the highest acceptance (83%). Water savings (77%) was the topmost motivation while the most common concern was insufficient information on hygienic safety (54%).

**Keywords:** Domestic wastewater recycling, grey water reuse, public acceptance, source separation / ECOSAN

## INTRODUCTION

The recent domestic wastewater management approach focusing upon source separation and ECOlogical SANitation (ECOSAN) generates grey water as one of the streams regardless of the type of segregation adopted. It is the fraction of domestic wastewater which comes from different washing functions in the household like hand washing, baths/showers, kitchen sinks, dish washing, laundry etc. and constitutes about  $\frac{3}{4}$  of domestic wastewater by volume (Belér Baykal, 2015). As it leaves toilet wastewater out, a considerable amount of pathogens and especially nutrients in domestic wastewater are separated at the source, which makes grey water an easier-to-deal with stream for reclamation as compared to conventional mixed domestic wastewater (Giresunlu & Belér Baykal 2016; Giresunlu, et al. 2016). Grey water may be returned to almost any point in the water cycle after proper treatment. Although it may even be used for potable purposes after sophisticated treatment, non-potable uses like toilet flushing, irrigation, car washing, firefighting etc. are more common. Early successful grey water reuse examples were reported by Nolde (1999, 2005).

Despite its advantages regarding sustainability, particularly under conditions of water stress/scarcity, as a “fit for purpose” water source, the popularity of grey water reuse is rather



limited. Indeed, the success of implementation and widespread use of grey water is closely related to the awareness and acceptance of the community it will serve.

This paper will summarize results from a preliminary survey in Turkey, currently experiencing water stress with a water availability of about 1500 m<sup>3</sup>/capita.year, with 300 respondents. The survey was designed to gain insight about readiness/willingness of respondents from different cities of the country for grey water reuse, basically focusing upon awareness regarding water stress/scarcity in the country and grey water as an alternative source, and acceptance with regard to the reuse of different fractions of grey water and possible end uses. Motivations and concerns for grey water reuse were also questioned.

## MATERIALS AND METHODS

The survey was conducted through face to face questionnaires to assess attitudes, acceptance and willingness regarding reuse of grey water as an alternative source. The survey questions were posed to 300 participants living in Turkey.

Table 1 summarizes the demographic profile of the 300 respondents, who were all living in Turkey during April 2016 and were to a large extent Turkish nationals with 94% Turkish, 6% other nationalities. The distribution of the participants based on gender was almost in half shares with 45% for females and 55% for males. The educational level is considered high as the great majority of the respondents were university graduates (with 11% 2-year, 34% bachelor's and 34 % graduate degrees). Age ranges were set to represent employment status; <18 for children and adolescents, 18-24 for college students, 25-30 for new graduates, 31-50 for professionals, 51-65 for senior professionals, and >65 for retirees for this survey. 31-50

**Table 1.** Demographic profile of respondents (N – number of respondents).

		<18	18-24	25-30	31-50	51-65	>65
<b>Age</b>	N	7	69	92	112	18	2
	%	2	23	31	37	6	1
		<b>Female</b>			<b>Male</b>		
<b>Gender</b>	N	135			165		
	%	45			55		
		<b>Turkish</b>				<b>Other*</b>	
<b>Nationality</b>	N	282				18	
	%	94				6	
		<b>Primary School</b>	<b>High School</b>	<b>2-Year Degree</b>	<b>Undergraduate Degree</b>	<b>Master's Degree</b>	<b>Ph.D. Degree</b>
<b>Education</b>	N	21	45	32	100	82	20
	%	7	15	11	34	27	7
		<b>Engineer</b>	<b>Technician</b>	<b>Student</b>	<b>Academician</b>	<b>Operator</b>	<b>Other</b>
<b>Occupation</b>	N	115	38	34	15	14	84
	%	38	13	11	5	5	28

\***Other:** Americans (N. 3), Iranian (N. 3), Syrian (N. 3), Azerbaijani (N. 2), Bangladeshi (N. 1), British (N. 1), Greek (N. 1), Bulgarian (N. 1), Russian (N. 1), Palestinian (N. 1), and Indonesian (N. 1).

year old professionals, which constituted 37% of respondents, was the largest group that was to respond to this survey followed by new graduates with 31%. Most of the respondents in the survey majored in engineering with 38%, however there were also technicians (13%), students (11%), researchers/academicians/teachers (5%), operators/workers (5%), and others such as officers, housewives, housekeepers, accountants/bankers.

The questionnaire consisted of a total of 21 questions and was composed of three parts: i) general questions about the demographic attributes of the participants, the results of which are presented in Table 1 and the preceding paragraph, ii) questions to evaluate background knowledge and awareness of water scarcity in Turkey as well as grey water, motivations and concerns/drawbacks regarding grey water reuse including the reasons behind their perception, and iii) questions regarding the origin and reuse areas of grey water to analyze the level of public acceptance for grey water reuse.

The data obtained were analyzed using simple head counts and percentages to reflect acceptance or motivations/concerns as appropriate.

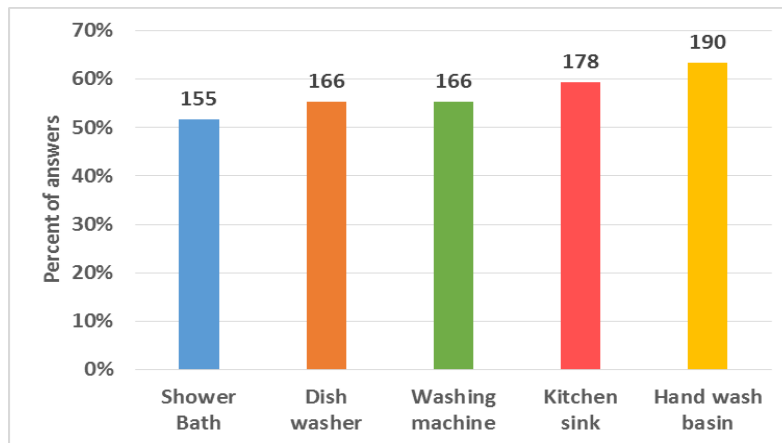
## **RESULTS AND DISCUSSION**

The results of demographic attributes of the participants are summarized in Table 1. Additionally, the answers revealed that 72% of the respondents never lived in a rural area. While 39% said they had no garden, 61% either had a garden of their own or a garden shared with their neighbors. Following the general questions regarding demographic attributes, questions were asked to assess background knowledge and awareness of the respondents about water scarcity in Turkey and grey water.

Currently, water availability in Turkey is about 1500 m<sup>3</sup>/capita.year (DSI 2014), indicating water stress (UNDP 2007). The results have revealed that 86% of the participants (N. 261) were aware that Turkey is experiencing a water stress at this time or will be experiencing it in about a decade while 7% said there was no water shortage and 7% said they did not know. This indicates that 86% of the respondents were aware that there is a shortage problem, showing that awareness with regard to water stress/scarcity was high.

When the participants were asked if they know what grey water meant, 63% did not know the exact meaning. When the definition/description of grey water was provided to those who did not know what it was, 47% of those said they would accept separate collection of grey water. Of the entire respondents, 56% indicated definite positive opinion that grey water could be segregated, while only 6% thought it could not. Although source separation is technically possible, 38% of respondents stated that they had no knowledge about how to segregate grey water. The results revealed that awareness with regard to grey water was rather low and providing information would be helpful.

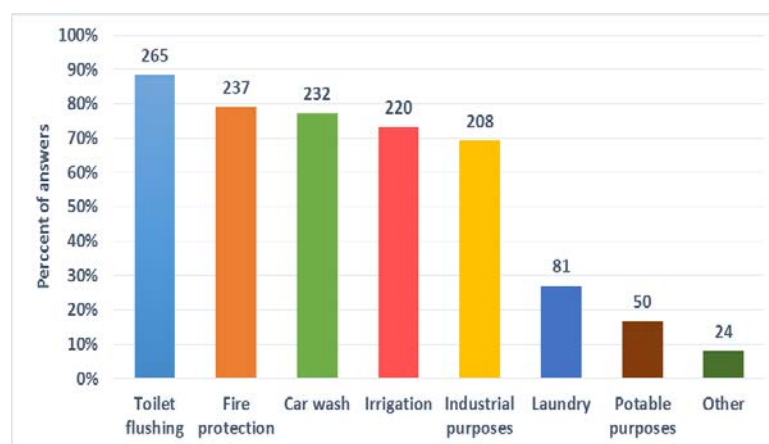
Grey water may be collected from several different washing functions in the household. That fraction coming from hand wash basins, showers and bath tubs constitute about 30% by volume and are categorized as light grey water. Light grey water has a higher quality as compared to the other fractions. When asked about acceptance towards five different points of origin of grey water in a household, hand wash basins (63%) and kitchen sinks (59%) received highest while showers/baths got the lowest preference (52%). However, Figure 1 shows that percentage of answers was rather close to each other and lied within a difference of about 10%. Acceptance level was considerable and under all circumstances over half of the participants accepted to use grey water from different origins in the household.



**Figure 1.** Acceptance of grey water origins

Together with these responses, participants expressed concerns about the detergents/personal care products which they thought might come from washing machines/dishwashers and possible contact with human excreta in shower and bath tub water. It is to be noted that some of these concerns do not reflect the real situation as for example in the case of possible human excreta problem, which may be more significant in the fraction from washing machines rather than showers/baths especially due to underwear that are washed in washing machines, while personal care products would be expected to be more predominant in wastewater from wash basins, showers and bath tubs as compared to washing machines and dish washers. These provide supporting proof of the significance of informing/educating communities in terms of grey water, its contents and the ways of dealing with those constituents.

Figure 2 reveals that of the seven different end uses questioned, the top three choices were toilet flushing (88%), fire fighting (79%), and car washing (77%). Even though it was clearly stated as 'after proper treatment', only 17% was ready to reuse grey water for potable purposes and 27% for laundry, mainly as a result of concerns regarding hygienic safety. Preference for those two end uses was apparently lower as compared to the other end uses questioned that received acceptances between 69–88%. Furthermore, 75% of participants who had exposure to rural living (N.15) were willing to use grey water for the purpose of irrigation while 78% of participants who have gardens (N.185) of their own or common gardens with neighbors were willing to use grey water for the purpose of irrigation, indicating that there was a considerable acceptance towards irrigation with grey water by people who are somehow involved with this activity.



**Figure 2.** Acceptance of grey water reuse areas.

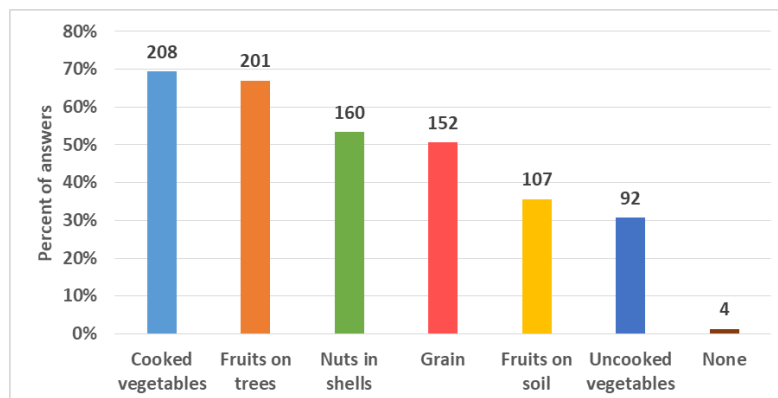
In addition to the end uses listed in the question, respondents also mentioned about possible additional reuse areas such as street washing, groundwater injection, cleaning of industrial plants, cleaning of chemical tanks, ponds and swimming pools, construction and mines, household and carpet cleaning, and others like air conditioning, heating, etc.

It was interesting that the results indicate that one of the most widespread current end use of grey water reuse, toilet flushing, received the highest preference in the survey, which was a motivating outcome. This is because the quantity of the mildest fraction of grey water, i.e. light grey water, which in general requires the least level of treatment, is sufficient to cover the water demand for toilet flushes; and using reclaimed grey water for this purpose is a meaningful step in contributing to sustainability of water resources through the “fit for purpose” use of this alternative water source, which will help cut back “wasting” of drinking water quality water, the cleanest, for sweeping away human excreta, the most polluted. Willingness of people involved with irrigation to use grey water as an alternative source was also apprehended as encouraging.

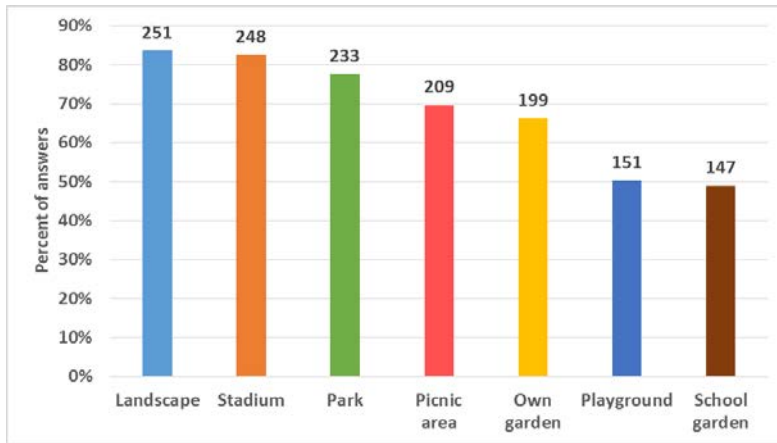
Acceptance for agricultural products irrigated with grey water was also investigated using two categories: food stuff and industrial plants. Among six different groups of food stuff, those consumed after cooking received the highest preference (69%) followed by fruits from trees (67%), while “none of them” was ticked only four times showing that there is considerable acceptance as indicated by Figure 3. Cooked vegetables received more than twice the acceptance for uncooked ones, and acceptance towards fruits irrigated with grey water decreased with proximity of the product with grey water, most probably as a reflection of concerns about hygienic safety.

Of the seven different types of green areas to be irrigated with reclaimed grey water, landscape areas (84%), stadiums (83%), and parks (78%) received the highest acceptance; while playgrounds of children (50%) and school gardens (49%) had lowest acceptance most probably as a result of possible contact which might occur with a higher possibility with younger children to lead to health problems, as can be observed from Figure 4.

Figure 5 shows that of the four different industrial plants questioned with the aim of assessing acceptance for different industrial products from plants irrigated with treated grey water, wearing clothes produced from cotton grown upon grey water received the highest acceptance with 83% and only 8% said they would not use any one of them. Tobacco, fruit juice and sugar received similar acceptances around 50%. Interestingly, 31% of the all respondents said they would accept all of those products.



**Figure 3.** Acceptance of food stuff irrigated with reclaimed grey water.



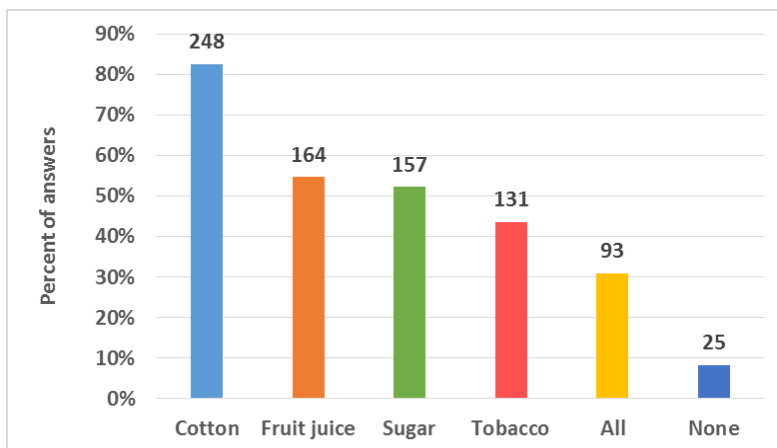
**Figure 4.** Acceptance of green areas irrigated with reclaimed grey water.

As illustrated in Figure 6 and 7, the top three motivations for grey water reuse were water savings (77%), lower environmental impacts (68%) and lower water bills (61%), while the topmost concerns were insufficient data on hygienic safety (54%), reluctance to pay for installation (44%), and lack of known success stories related to this practice (38%).

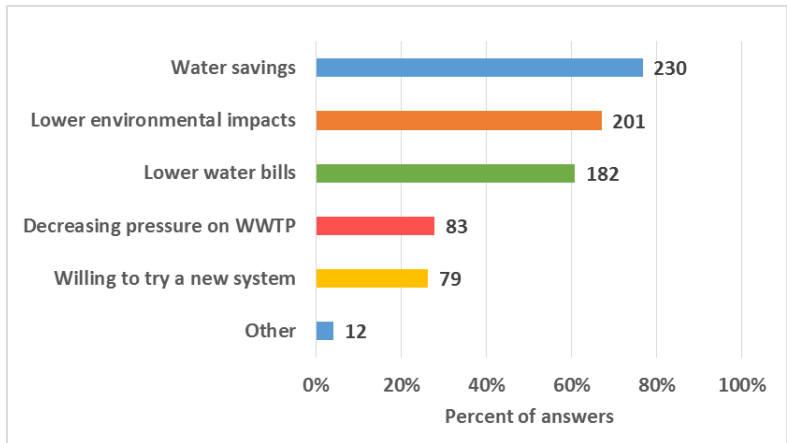
Reusing grey water for toilet flushes is the most logical and probably the most common areas of domestic water reuse. As flush water constitutes about 1/4 of domestic water use (Beler Baykal 2015), an approximate water bill reduction of 25% could be expected if the grey water was reused for toilet flushes.

Given this information, participants were asked if they would accept or reject reuse of grey water for toilet flushing if their water bill shows a 25% reduction to observe the effect of economic considerations. 83% of participants accepted to reuse grey water for flushes if it can decrease the water bills, showing measurable monetary benefits had positive effects on public opinion and acceptance.

To test the financial impact further, participants were first asked for extra payment for the installation of grey water systems in their current houses. Of the entire respondents, only 6% indicated definite acceptance and 17% rejected the extra payment in their current houses completely. While 26% needed a proof of an environmental benefit, 25% of respondents stated that they needed a proof of a future financial benefit to pay for grey water system installation in their current houses. When the question was changed to free installation in their current houses, 30% of participants were still not sure. However, definite acceptance towards



**Figure 5.** Acceptance of industrial plants grown upon reclaimed grey water.



**Figure 6.** Motivations for grey water reuse.

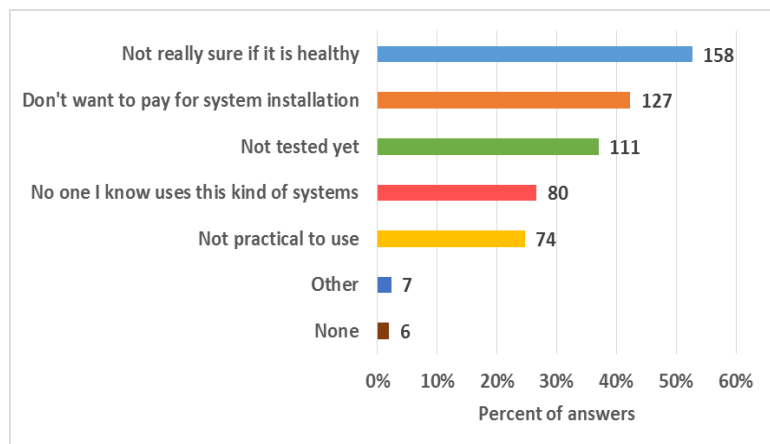
grey water installation was raised from 6% to 66% and only 4% of answers remained as no. These results reveal that the major drivers for willingness to pay extra were environmental and financial benefits, and more importantly economic instruments in the form of free installations would be a major factor for public acceptance and willingness to use grey water systems. An increase of more than tenfold (from 6 % to 66%) in terms of acceptance is perceived to be remarkable, and that such an incentive would be a major positive instrument/driver in the implementation of this practice (especially at the initial stages).

Lastly, to assess motivations towards reusing grey water, participants were asked from whom they will be inspired. 78% of respondents thought scientist/academicians would be the most encouraging group followed by family members, as shown in Figure 8. This information may be useful in getting a clue in terms of with whom to start the grey water reuse action in Turkey.

## CONCLUSIONS

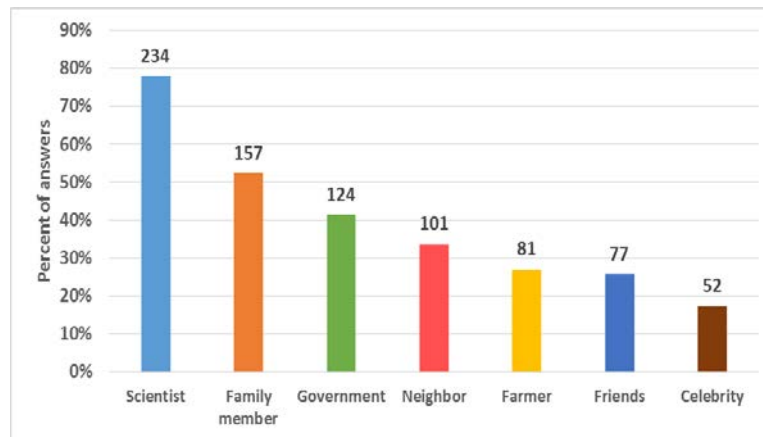
This study aims to shed light upon readiness/willingness of end users for grey water reuse in Turkey. According to the responses obtained in this preliminary survey, awareness regarding water stress/scarcity in Turkey is high and all in all the general opinion seems to be positive regarding grey water reuse as in most cases acceptances were over 50%, especially for non-potable uses including toilet flushing and irrigation. Potable use of grey water received the lowest level of acceptance mainly due to hygienic safety and health concern, which seem to be the most significant barrier for wide spread implementation of grey water reuse overall.

Toilet flushing among various end uses, vegetables consumed after cooking among agricultural food products, landscape area among irrigated green areas, cotton among



**Figure 7.** Concerns/drawbacks for grey water reuse.





**Figure 8.** Possible role models to encourage grey water reuse.

industrial plants ranked the first in terms of acceptance, all receiving 80% acceptance or more except agricultural food products which received 69%. In terms of the origin of grey water, all fractions received reasonable acceptance ranging between 52-63% acceptances.

While health issues seem to constitute the main concern in acceptance, environmental issues including water savings, lower negative impacts upon environment and economic benefits as exemplified by lower water bills were observed as the top drivers for grey water reuse. Economic incentives will most likely increase willingness to adopt grey water systems.

In conclusion, the results of this preliminary survey were interpreted to be motivating in terms of further grey water reuse. Increasing efforts of awareness raising, education and publicity, successful examples of practices, and financial benefits will most likely raise the level of acceptance and popularity of this sustainable practice.

## REFERENCES

- Belér Baykal, B. 2015 Stream segregation in household use: A review of grey water as an alternative source of water and yellow water as an alternative source of fertilizers. *Water Quality Exposure and Health*, 7(1), 27-37.
- DSI (State Hydraulic Works of Turkey) (n.d.) Toprak ve Su Kaynakları. (*Soil and Water Resources*) <http://www.dsi.gov.tr/toprak-ve-su-kaynaklari> (accessed 11 March 2017)
- Giresunlu E., Belér Baykal, B. (2016) A case study of the conversion of grey water to a flush water source in a Turkish student residence hall, *Water Science and Technology Water Supply* December 2016 16 (6) 1659-1667; DOI: 10.2166/ws.2016.078
- Giresunlu, E., Belér Baykal, B., Afacan, E. (2016) A Comparative Study on Light Grey Water from Buildings with different functions, 8. International Conference on Environmental Science and Technology, American Academy of Sciences 2016 Houston, June 6-10, 2016.
- Nolde E (1999) Grey water reuse systems for toilet flushing in multistorey buildings—over ten years experience in Berlin. *Urban Water* 1:275–284
- Nolde E (2005) Grey water recycling systems in Germany—results, experiences and guidelines. *Water Sci Technol* 51(10):203–210
- UNDP (United Nations Development Programme) (n.d.) Coping with Water Scarcity. <http://www.tr.undp.org/content/turkey/en/home/presscenter/news-from-new-horizons/2007/04/coping-with-water-scarcity.html> (accessed 07 July 2017)

**Parallel session 8 - Toxic and emerging pollutants 1**

**11:30-12:50**

Session chair: Véronique Deluchat

**260 - Retention of the endocrine disruptors ethinylestradiol, bisphenol A and levonorgestrel by subsurface constructed wetlands**

CAMPOS Julyenne Meneghetti - *University of Campinas*

**281 - Physico-Chemical Analysis and Implications of Partially Treated Wastewater from Textile Industries in Nigeria**

DAN'AZUMI Salisu - *Bayero University Kano*

**711 - Phenol biodegradation by bacterial cultures encapsulated in 3D microfiltration-membrane capsules for industrial wastewater treatment**

KURZBAUM Eyal - *Shamir Research Institute, University of Haifa, Israel*

**485 - Removal of phenolic compounds from wastewater by Phragmites australis-bacteria association**

WIRASNITA Riry - *University of Yamanashi*

# Retention of the endocrine disruptors ethinylestradiol, bisphenol A and levonorgestrel by subsurface constructed wetlands

Ref # S2SMALL-51435

J.M. Campos<sup>1\*</sup>, D.M. Roston<sup>1</sup>, S.C.N. Queiroz<sup>2</sup>

<sup>1</sup> Department of Water and Soil, School of Agricultural Engineering, University of Campinas, Candido Rondon Avenue, 501 -13083-875 - Campinas - SP, BRAZIL

<sup>2</sup> Embrapa Environment, Waste and Contaminants Laboratory, SP 340 Road, Km 127,5, 13820-000, Tanquinho Velho, Jaguariúna – SP, BRAZIL

\* Corresponding Author: [julyenne.mc@gmail.com](mailto:julyenne.mc@gmail.com)

**Abstract:** Endocrine disruptors are chemical substances which have been found in water bodies and wastewater, and are capable to interfere at the endocrine system of humans and animals, causing many adverse effects to health. Among these substances are the estrogen hormone ethinylestradiol (EE2), the progestin levonorgestrel (LNG) and the bisphenol A (BPA), substance used in the production of plastics, which in concentrations of nanogramas per liter could affect the reproduction and the sexual characteristics of aquatics animals. Constructed wetlands are natural wastewater treatment systems with low implantation and maintenance costs, suitable for installation in rural and isolated communities, which have been shown capable of removing endocrine disrupters from contaminated wastewater. In this context, the present project aimed to evaluate the retention efficiency of these three substances by four bench scale constructed wetlands - three containing gravel as support matrix, one cultivated with *Cyperus isocladius* (WL1), other with *Eichhornia crassipes* (WL3), and one without macrophyte (WL2). The fourth unit contained gravel and bamboo charcoal as support matrix, also cultivated with *Cyperus isocladius* (WLC). The results showed that the most efficient wetland for retention of EE2 and BPA was WLC, and for retention of LNG were WL1 and WL3 (without bamboo charcoal).

**Keywords:** dwarf papyrus; endocrine disruptors; estrogen; hormones; liquid chromatography; water hyacinth.

## INTRODUCTION

Endocrine disruptors are substances or mixtures of chemicals that can interfere with the endocrine system of humans and animals and can cause cancer, reproductive disorders, mutagenicity, thyroid problems, presence of male organs in female fish (or vice versa), among several other health problems (Singhal *et al.* 2009; Bergman *et al.* 2012; Damstra *et al.* 2002). Endocrine disruptors are substances increasingly present in the environment, especially in water bodies.

The classification of endocrine disruptors is generally given in four main classes: natural estrogens (estrone, estradiol, estriol), synthetic estrogens (ethinylestradiol), phytoestrogens, and xenoestrogens which are industrial chemicals such as bisphenol A, nonylphenol, pesticides in general, among others (European Commission 1999). Contamination by endocrine disruptors may be accomplished by point sources such as discharge of raw or treated wastewater, or by diffuse sources such as pesticides and herbicides application in crops, or the disposal of sludge and wastewater in the soil (Kookana *et al.* 2007).

The estrogen hormone ethinylestradiol (EE2) is commonly found in surface waters and in effluents from municipal water supply at concentrations capable of causing changes in the reproductive system of fish, given that concentrations in nanograms may already cause this effect (Gray & Sedlak 2005; Kumar *et al.* 2011). The feminization of fish in contact with

wastewater from confined animal facility was studied by Leet *et al.* (2015). It was found that 84% of the male fish that came into contact with these residues during the first 45 days (larval stage) developed a cavity for ovary, a sign of feminization.

The progestogen levonorgestrel (LNG) is usually associated with the hormone ethinylestradiol in contraceptive pills. While the EE2 has feminization effect in male fish, the LNG is known to have androgenic effect, that is, masculinization effect in fish (Leet *et al.* 2015; Runnalls *et al.* 2015). Toxicological studies with fish showed that at low concentrations as 6.5 ng.L<sup>-1</sup>, levonorgestrel inhibited spermatogenesis, reduced egg production, decreased fish reproduction, reduced growth, increased the weight and lengths of female fish, and led females to acquire characteristics of male fish (Overturf *et al.* 2015; Runnalls *et al.* 2015; Svensson *et al.* 2014).

Bisphenol A (BPA) is a chemical used in the manufacture of resins and polycarbonate, epoxy resins among others. It was present in plastic water bottles, plastic pots, bottles, and other food packaging until few years ago (FDA 2012; USEPA 2010). Concern for this substance had arisen when it was found in mineral waters contained in plastic packaging and also in surface water (Montagner & Jardim 2011; FDA 2012). According to USEPA (2010) the BPA has already been part of the "Toxic Substances Control Act - TSCA" because it is toxic for the reproduction and development of animals, in addition to being slightly estrogenic.

Constructed wetlands (CW) are wastewater treatment systems built for the purpose of simulating the structure of natural wetlands, biochemically transforming the pollutants through the microbial population, and promoting phytoremediation mechanisms (ITRC 2003). It is possible to mention as wetlands systems advantages their simple operation and poor maintenance, possible application in isolated communities, low production of secondary residues from the process, low operation and maintenance costs, creation of a habitat for animal species and incorporation into the local landscape - which increase acceptance by the population (ITRC 2003; USEPA 1988).

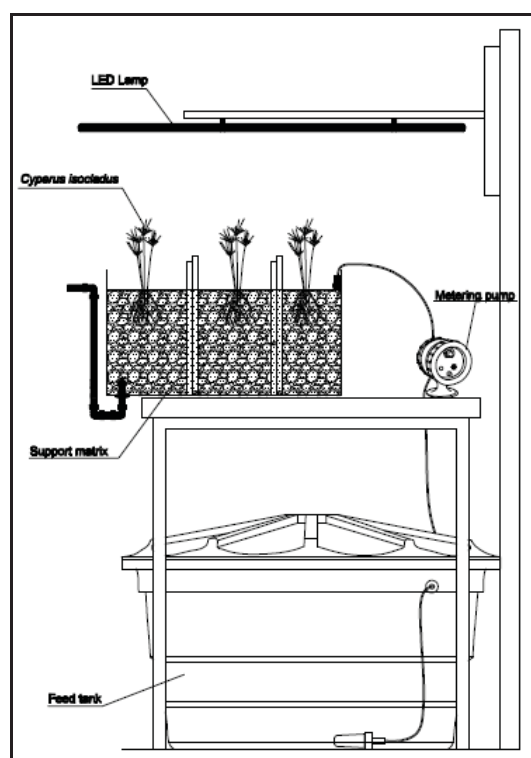
Hijosa-Valsero *et al.* (2010) reported that conventional wastewater treatment plant was not able to remove diclofenac, carbamazepine, galaxolide and tonalide, while wetlands removed all these substances in greater or lesser amounts. This shows that wetlands systems were more efficient in removing endocrine disrupters than conventional treatment. Several authors have used constructed wetlands with different configurations and types of macrophytes to remove different endocrine disrupters (Shappell *et al.* 2007; Song *et al.* 2009; Kumar *et al.* 2011; Cai *et al.* 2012; Ávila *et al.* 2014; Chen *et al.* 2014). Constructed wetlands systems were cited as an efficient removal approach of slightly hydrophobic pesticides (Gray & Sedlak 2005). As ethinylestradiol (EE2), bisphenol A (BPA) and levonorgestrel (LNG) are slightly hydrophobic or persistent substances, the present project aimed to evaluate the retention efficiency of these endocrine disruptors utilizing four bench scale constructed wetlands.

## **MATERIALS AND METHODS**

The treatment system was installed in the Laboratory of Sanitary Engineering of the School of Agricultural Engineering, University of Campinas. The subsurface flow type wetlands (WL) were made out of polypropylene (PP) boxes with dimensions of 0.60 x 0.40 x 0.32 m, and net volume of 16 to 18L. Wetlands WL1, WL2 and WL3 were filled with gravel as support matrix (9.5 to 19.0 mm), while WLC was filled with 20 cm of bamboo (*Dendrocalamus asper*) charcoal (9.0 to 39.0 mm) and covered with gravel (19.0 to 25.0 mm). WLC and WL1 were cultivated with the macrophyte *Cyperus isocladius* better known as dwarf papyrus, and WL3 was cultivated with *Eichhornia crassipes*, known as water hyacinth. WL2 remained only with support matrix.

A 150 L feed tank was used to store synthetic wastewater simulating municipal wastewater with C:N:P ratio of 200:50:8, which was conducted to the constructed wetland by a metering pump. EE2 and LNG were added to synthetic wastewater using macerated contraceptive pills. The added BPA had 97% purity (Sigma-Aldrich). The compounds were studied in two concentration ranges: low, corresponding 20  $\mu\text{g.L}^{-1}$  for EE2 and BPA, and 100  $\mu\text{g.L}^{-1}$  for LNG; high, corresponding 100  $\mu\text{g.L}^{-1}$  for EE2 and BPA, and 500  $\mu\text{g.L}^{-1}$  for LNG. Two replicates were performed for each concentration range.

The hydraulic retention time (HRT) ranged from 2 to 4 days. All variables were taken into account in the experimental design. Influent to all wetlands had the same characteristics, and effluent samples were collected from each unit. Figure 1 shows a schematic representation of the treatment unit.



**Figure 1.** Schematic representation of the constructed wetland treatment system.  
Source: Figure drawn by the author (2015).

The chromatographic analysis were performed at the Laboratory of Residues and Contaminants of Embrapa Environment (Brazilian Agricultural Research Company). Chromatographic standards of d(-)norgestrel ( $\geq 99\%$ ), ethinylestradiol ( $\geq 99.7\%$ ) and bisphenol A ( $\geq 97\%$ ) were purchased from Sigma-Aldrich. The analysis were performed on a Shimadzu Class VP high performance liquid chromatograph (HPLC) consisting of automatic injection system, high pressure pump, furnace for column and ultraviolet (UV) detector model SPD-10AV. Chromatographic separation was performed using Phenomenex Gemini brand C18 column, 5 $\mu\text{m}$ , C18, 110 A, 250 x 4.6 mm. The analytical method used and the solid phase extraction (SPE) step were performed according to Campos, Queiroz & Roston "in press". All injections were performed in triplicate.

The method validation was done according to the guide "DOQ-CGCRE-008: Guidance on Validation of Methods of Chemical Tests", INMETRO (2007). The data were stored in

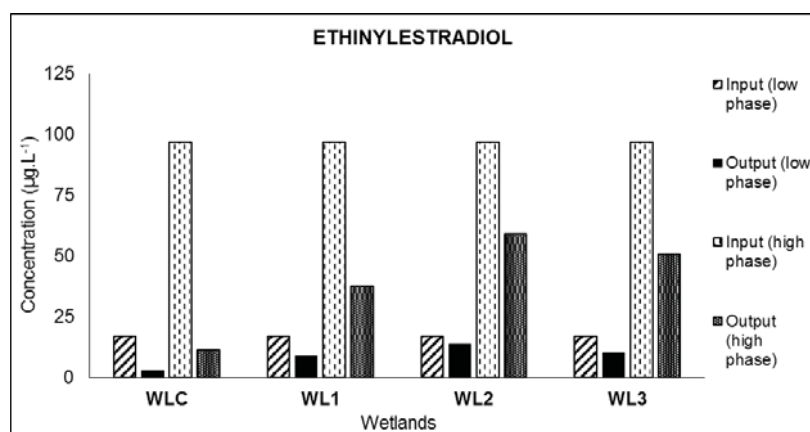
Microsoft Excel spreadsheets, and the data statistical analysis was performed using the ASSISTAT Version 7.7 software (Silva 2016).

## RESULTS AND DISCUSSION

The analytical method proved to be efficient, sensitive and adequate for the quantification of the analytes in samples of synthetic wastewater from the constructed wetlands. The values found for the detection limit (LD) of the method were  $0.1 \mu\text{g.L}^{-1}$  for LNG,  $0.4 \mu\text{g.L}^{-1}$  for BPA, and  $0.6 \mu\text{g.L}^{-1}$  for EE2, and the limits of quantification (LQ) were  $0.2 \mu\text{g.L}^{-1}$  for LNG,  $0.6 \mu\text{g.L}^{-1}$  for BPA, and  $0.8 \mu\text{g.L}^{-1}$  for EE2.

Although a fixed amount of the compounds was added to the wastewater, it was possible to observe that due to the pumping and inlet flow at the time of analysis, this concentration was slightly altered. The mean input concentration of EE2 in the low-concentration phase was  $16.8 \mu\text{g.L}^{-1}$  and output  $2.8 \mu\text{g.L}^{-1}$  (WLC),  $8.9 \mu\text{g.L}^{-1}$  (WL1),  $13.8 \mu\text{g.L}^{-1}$  (WL2) and  $10.0 \mu\text{g.L}^{-1}$  (WL3). In the high concentration phase the mean input was  $96.9 \mu\text{g.L}^{-1}$  and output was  $11.2 \mu\text{g.L}^{-1}$  for WLC,  $37.5 \mu\text{g.L}^{-1}$  for WL1,  $58.9 \mu\text{g.L}^{-1}$  for WL2 and  $50.7 \mu\text{g.L}^{-1}$  to WL3.

It is observed in Figure 2 the input and output average concentration for EE2. The WLC effluent presented lower concentrations of EE2 than the other treatment effluents. The highest retention rate in the low concentration phase was 83.4% for WLC and the lowest was 18.2% for WL2, and in the high concentration phase it was 88.4% for WLC and 39.3% for WL2. The wetland containing gravel and bamboo charcoal as support matrix and cultivated with *Cyperus isocladius* was the most efficient in the retention of this hormone whereas the one without macrophyte, containing only gravel as support matrix, the less efficient. The statistical analysis (ANOVA) confirms that independently concentration variations, the most efficient wetland for EE2 retention was WLC (p-value  $<0.05$  at 5% significance), and the least efficient WL2 (p-value  $<0.05$  to 5 % significance).



**Figure 2.** Mean input and output concentrations, and mean retention rates for EE2.

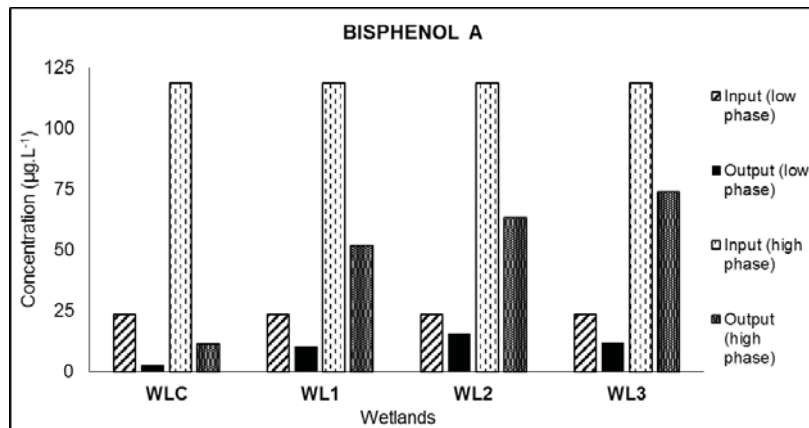
Ávila *et al.* (2014) investigated the retention of EE2 added to municipal wastewater by a hybrid system of wetlands containing two vertical flow type, one horizontal flow and one surface flow, cultivated with *Phragmites australis* on a pilot scale. The authors studied three different hydraulic loading rates (HLR), performing continuous injection of EE2 and other endocrine disruptors. They observed that the higher the HLR the lower the retention rates, which were between 20 and 80% for EE2, variations close to that of the present study.

Kumar *et al.* (2011) studied the natural attenuation of the hormone ethinylestradiol in three different tanks, one with floating macrophytes (Tank 1), one with integrated emergent and submerged macrophytes (Tank 2) and a system with submerged macrophytes rooted together



with microalgae (Tank 3). According to the author, Tank 1 showed to be more efficient in the removal of EE2 (EE2 - 69.1%), close to the maximum found in the present study, Tank 2 obtained 18.5% of removal and Tank 3 7.7% for EE2.

The mean input concentration of BPA in the low concentration phase was 23.5  $\mu\text{g.L}^{-1}$  and output 2.6  $\mu\text{g.L}^{-1}$  for WLC, 10.3  $\mu\text{g.L}^{-1}$  for WL1, 15.5  $\mu\text{g.L}^{-1}$  for WL2 and 12.0  $\mu\text{g.L}^{-1}$  for WL3. In the high concentration phase the mean input was 118.6  $\mu\text{g.L}^{-1}$  and output was 11.4  $\mu\text{g.L}^{-1}$  (WLC), 52.0  $\mu\text{g.L}^{-1}$  (WL1), 63.5  $\mu\text{g.L}^{-1}$  (WL2) and 74.0  $\mu\text{g.L}^{-1}$  (WL3). Figure 3 shows the input and output average concentration for BPA, where is observed lower concentrations for WLC effluent.



**Figure 3.** Mean input and output concentrations, and mean retention rates for BPA.

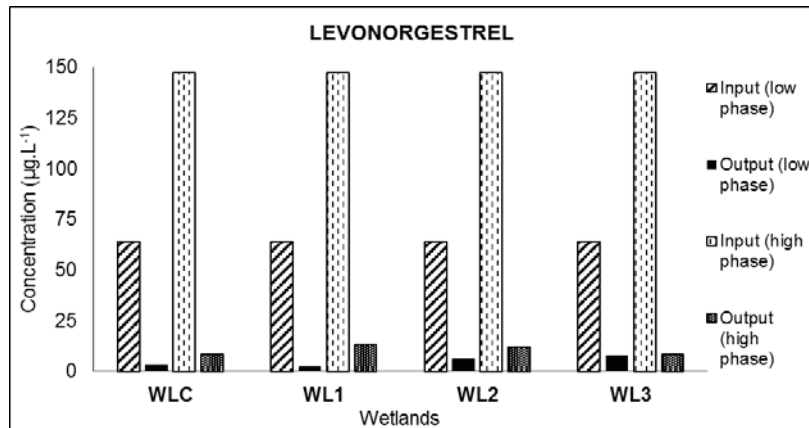
Regarding to the retention rates, in the low concentration phase the highest rate was 89.0% for WLC and the lowest 34.1% for WL2, while in the high concentration range the lowest retention rate occurred for WL3 (37.6%) and the highest was also for WLC, with 90.4% BPA retention. As in the case of EE2, the highest retention rates occurred in the wetland containing bamboo charcoal and gravel as a support matrix, and cultivated with the macrophyte *Cyperus isocladius*. Applying the Mann-Whitney statistical test, the most efficient wetland for BPA retention was WLC ( $p$ -value  $< 0.05$ , at 5% significance), independently of concentration range. There was no significant difference between the lower efficiencies in the removal of BPA (WL1, WL2 and WL3).

Toro-Vélez *et al.* (2016) used a pilot scale horizontal subsurface flow wetlands, as in this study, and observed for BPA removal 73.3 ( $\pm 19\%$ ) in wetland cultivated with *Heliconia psitacorum*, 70.2 ( $\pm 27\%$ ) in the unit cultivated with *Phragmites australis*, and 62.2 ( $\pm 33\%$ ) in the one without plant. The values were slightly lower than the maximum values found in this study. Papaevangelou *et al.* (2016) also studied BPA removal in pilot scale horizontal subsurface flow wetlands, and obtained mean removals of 49.6% in those cultivated with *Phragmites australis*, 50.0% in wetlands cultivated with *Typha latifolia*, and 55.4% in wetlands without plant (rates slightly higher than the minimum found in this study). Ávila *et al.* (2014) investigated the retention of EE2 added to a municipal wastewater treated by an hybrid system of wetlands cultivated with *Phragmites australis* obtaining retention rates between 11 and 90% for BPA, variations close to those of the present study.

In the low-concentration phase the mean input for LNG was 64.2  $\mu\text{g.L}^{-1}$ , while the output concentrations were 3.2  $\mu\text{g.L}^{-1}$  (WLC), 2.4  $\mu\text{g.L}^{-1}$  (WL1), 6.1  $\mu\text{g.L}^{-1}$  (WL2) and 7.6  $\mu\text{g.L}^{-1}$  (WL3). In the high-concentration phase the mean input was 147.2  $\mu\text{g.L}^{-1}$ , and output 8.5  $\mu\text{g.L}^{-1}$  for WLC, 13.3  $\mu\text{g.L}^{-1}$  for WL1, 12.0  $\mu\text{g.L}^{-1}$  for WL2 and 8.3  $\mu\text{g.L}^{-1}$  to WL3. The input

concentration should be close to  $100 \mu\text{g.L}^{-1}$  in the low phase and  $500 \mu\text{g.L}^{-1}$  in the high concentration phase, however, much lower concentrations were observed.

The decrease in concentration at the entrance of the system probably occurred because levonorgestrel was the substance with lower solubility ( $1.73 \text{ mg.L}^{-1}$ ) when compared to EE2 ( $11.3 \text{ mg.L}^{-1}$ ) and BPA ( $300 \text{ mg.L}^{-1}$ ), probably its dissolution in the synthetic wastewater was not as efficient as the other compounds. Figure 4 shows the mean input and output concentrations results for LNG.



**Figure 4.** Mean input and output concentrations, and mean retention rates for LNG.

The levonorgestrel retention rates were higher in relation to the other compounds. The maximum retention at the low concentration stage was 96.3% for WL1, while the minimum retention was 88.2% for WL3. In the high concentration phase the maximum retention occurred in WL3 with 94.3% and the minimum in WL1 with 91.0%. It is noted that the minimal removals for the levonorgestrel compound were very high when compared to the minimal removals of the other compounds. Statistical analysis by Mann-Whitney test showed that the most efficient wetlands were WL1 and WL3 ( $p$ -value  $<0.05$ ) with no difference between them, nor between WLC and WL2, which were the least efficient wetlands ( $p$ -value  $<0.05$ ) with 5% significance.

Li *et al.* (2014) studied the removal of LNG in three tanks with volume of 288L containing ultra-pure water contaminated with  $180 \mu\text{g.L}^{-1}$  of the hormone, one of them without macrophytes, another with *Eichhornia crassipes* (without being fixed to the support matrix) and another containing *Cyperus alternifolius*, also floating. With TDH of 50 days the removal efficiency obtained was  $79.8\% \pm 3.1\%$  in the tank with *Cyperus alternifolius*, and  $78.9\% \pm 2.5\%$  in the tank with water hyacinth (Li *et al.* 2014). The results found by the authors with 50 days HRT are lower than those found in the present study, with HRT ranging from 2 to 4 days, evidencing that the four wetlands were extremely efficient in levonorgestrel retention.

## CONCLUSIONS

The constructed wetland WLC with bamboo charcoal and gravel as support matrix, cultivated with *Cyperus isocladius*, presented the highest retention efficiency for the studied compounds, and it was not affected by the different concentration ranges used.

## ACKNOWLEDGEMENTS

The authors thank CAPES, CNPq (Process n.º 149364/2014-8) and FAEPEX-UNICAMP (2698/17) for scholarships and financial support, to the post-graduation committee of the School of Agricultural Engineering (UNICAMP) and Embrapa Environment.

## REFERENCES

- Ávila, C.; Matamoros, V.; Reyes-contreras, C.; Piña, B.; Casado, M.; Mita, L.; Rivetti, C.; Barata, C.; García, J.; Bayona, J. M. 2014. Attenuation of emerging organic contaminants in a hybrid constructed wetland system under different hydraulic loading rates and their associated toxicological effects in wastewater. *Science of the Total Environment*. **470 – 471**, 1272 – 1280. (DOI: <http://dx.doi.org/10.1016/j.scitotenv.2013.10.065>)
- Bergman, Å.; Heindel, J. J.; Jobling, S.; Kidd, K. A.; Zoeller, R. T. 2012. *State of the Science of Endocrine Disrupting Chemicals 2012*. Inter-organization Programme for the Sound Management of Chemicals, IOMC, United Nations Environment Programme, UNEP, World Health Organization, WHO, Switzerland.
- Cai, K.; Elliot, C. T.; Phillips, D. H.; Scippo, M. L.; Muller, M.; Conolly, L. 2012. Treatment of estrogens and androgens in dairy wastewater by a constructed wetland system. *Water Research*. **46**, 2333 - 2343. (DOI: [doi:10.1016/j.watres.2012.01.056](http://dx.doi.org/10.1016/j.watres.2012.01.056))
- Campos, J. M.; Queiroz, S. C. N.; Roston, D. M. Validação de método analítico para quantificação de interferentes endócrinos em águas residuárias após tratamento secundário (Validation of an analytical method for quantification of endocrine disruptors in wastewater after secondary treatment). “in press”. In: *29º Congresso Brasileiro de Engenharia Sanitária e Ambiental (Brazilian Congress of Sanitary and Environmental Engineering)*.
- Chen, T-C.; Yeh, K-J. C.; Kuo, W-C.; Chao, H-R.; Sheu, S-C. 2014. Estrogen degradation and sorption onto colloids in a constructed wetland with different hydraulic retention times. *Journal of Hazardous Materials*. **277**, 62 – 68. (DOI: <http://dx.doi.org/10.1016/j.jhazmat.2014.03.038>)
- Damstra, T.; Barlow, S.; Bergman, A.; Kavlock, R.; Van Der Kraak, G. 2002. *Global Assessment of the State-of-the-Science of Endocrine Disruptors*. Report WHO/PCS/EDC/02.2. International Programme on Chemical Safety, IPCS, World Health Organization, WHO, Geneva, Switzerland.
- European Commission. 1999. Community Strategy for Endocrine Disruptors: a range of substances suspected of interfering with hormone systems of humans and wildlife. Communication from the Commission to the Council and the European Parliament, Brussels, Belgium.
- FDA. *FDA continuous to study BPA*. 2012. Consumer health information. United States Food and Drug Administration, U. S. FDA, USA.
- Gray, J. L.; Sedlak, D. L. 2005. The fate of Estrogenic Hormones in an Engineered Treatment Wetland with Dense Macrophytes. *Water Environment Research*, **77** (01), 24-31.
- Hijosa-Valsero, M.; Matamoros, V.; Sidrach-Cardona, R.; Martín-Villacorta, J.; Bécares, E.; Bayona, J. M. 2010. Comprehensive assessment of the design configuration of constructed wetlands for the removal of pharmaceuticals and personal care products from urban wastewaters. *Water Research*. **44**, 3669 – 3678.
- INMETRO - *Orientações sobre validação de métodos de ensaios químicos (Guidance on validation of chemical test Methods)*. 2007. DOQ-CGCRE-008. Instituto Nacional de Metrologia, Normalização e Qualidade Industrial (National Institute of Metrology, Standardization and Industrial Quality). Brazil.
- ITRC - Interstate Technology & Regulatory Council. 2003. *Technical and Regulatory Guidance Document for Constructed Treatment Wetlands*. Washington, D. C., USA.
- Kookana, R.; Williams, M.; Waller, N. 2007. Endocrine-disrupting chemicals in the Australian environment: Background and current research in Australia. Land & Water Australia, Canberra, Australia.

- Kumar, A. K.; Chiranjeevi, P.; Mohanakrishna, G.; Mohan, S. V. 2011. Natural attenuation of endocrine-disrupting estrogens in an ecologically engineered treatment system (EETS) designed with floating, submerged and emergent macrophytes. *Ecological Engineering*. **37**, 1555 – 1562. (DOI:10.1016/j.ecoleng.2011.06.009)
- Leet, J. K.; Sassman, S.; Amberg, J. J.; Olmstead, A. W.; Lee, L. S.; Ankley, G. T.; Sepúlveda, M. S. 2015. Environmental hormones and their impacts on sex differentiation in fathead minnows. *Aquatic Toxicology*. **158**, 98 – 107. (DOI: <http://dx.doi.org/10.1016/j.aquatox.2014.10.022>)
- Li, G.; Zhai, J.; He, Q.; Zhi, Y.; Xiao, H.; Rong, J. 2014. Phytoremediation of levonorgestrel in aquatic environment by hydrophytes. *Journal of Environmental Sciences*. **26**, 1869 – 1873. (DOI: <http://dx.doi.org/10.1016/j.jes.2014.06.030>)
- Montagner, C. C.; Jardim, W. F. 2011. Spatial and Seasonal Variations of Pharmaceuticals and Endocrine Disruptors in the Atibaia River, São Paulo State (Brazil). *Journal Brazilian chemistry society*. **22**(08), 1452 – 1462.
- Overturf, M. D.; Huggett, D. B. 2015. Responses to various exposure durations of levonorgestrel during early-life stages of fathead minnows (*Pimephales promelas*). *Aquatic Toxicology*. **161**, 33 – 40. (DOI: <http://dx.doi.org/10.1016/j.aquatox.2015.01.029>)
- Papaevangelou, V. A.; Gikas, G. D.; Tsihrintzis, V. A.; Antonopoulou, M.; Konstantinou, I. K. 2016. Removal of Endocrine Disrupting Chemicals in HSF and VF pilot-scale constructed wetlands. *Chemical Engineering Journal*. **294**, 146 – 156. (DOI: <http://dx.doi.org/10.1016/j.cej.2016.02.103>)
- Runnalls, T. J.; Beresford, N.; Kugathas, S.; Margiotta-Casaluci, L.; Scholze, M.; Scott, A. P.; Sumpter, J. P. 2015. From single chemicals to mixtures - Reproductive effects of levonorgestrel and ethinylestradiol on the fathead minnow. *Aquatic Toxicology*. **169**, 152 – 167. (DOI: <http://dx.doi.org/10.1016/j.aquatox.2015.10.009>)
- Silva, F.; Azevedo, C. 2016. The Assistat Software Version 7.7 and its use in the analysis of experimental data. *African Journal Agriculture Research*. **11**(39), 3733 – 3740.
- Singhal, N.; Song, Y.; Johnson, A.; Swift, S. 2009. *Estrogenic Endocrine Disrupting Compounds*. Technical Report Number TR 2010/005. Auckland Regional Council.
- Shappell, N. W.; Billey, L. O.; Forbes, D.; Matheny, T. A.; Poach, M. E.; Reddy, G. B.; Hunt, P. G. 2007. Estrogenic Activity and Steroid Hormones in Swine Wastewater through a Lagoon Constructed-Wetland System. *Environmental Science & Technology*. **41**, 444 - 450. (DOI: 10.1021/es061268e).
- Song, H. L.; Nakano, K.; Taniguchi, T.; Nomura, M.; Nishimura, O. 2009. Estrogen removal from treated municipal effluent in small-scale constructed wetland with different depth. *Bioresource Technology*. **100**, 2945 – 2951. (DOI:10.1016/j.biortech.2009.01.045)
- Svensson, J.; Fick, J.; Brandt, I.; Brunström, B. 2014. Environmental concentrations of an androgenic progestin disrupts the seasonal breeding cycle in male three-spined stickleback (*Gasterosteus aculeatus*). *Aquatic Toxicology*. **147**, 84 – 91. (DOI: <http://dx.doi.org/10.1016/j.aquatox.2013.12.013>)
- Toro-Vélez, A. F.; Madera-Parra, C. A.; Peña-Varón, M. R.; Lee, W. Y.; Bezares-Cruz, J. C.; Walker, W. S.; Cárdenas-Henao, H.; Quesada-Calderón, S.; García-Hernández, H.; Lens, P. N. L. 2016. BPA and NP removal from municipal wastewater by tropical horizontal subsurface constructed wetlands. *Science of the Total Environment*. **542**, 93 – 101. (DOI: <http://dx.doi.org/10.1016/j.scitotenv.2015.09.154>)
- USEPA. *Design manual on constructed wetlands and aquatic plant systems for municipal wastewater treatment*. 1988. United States Environmental Protection Agency, USEPA, Report EPA/625/1-88/022, Cincinnati, Ohio, USA.
- USEPA. *Bisphenol A Action*. 2010. United States Environmental Protection Agency, USEPA, USA.

# Physico-Chemical Analysis and Implications of Partially Treated Wastewater from Textile Industries in Nigeria

Ref # S2SMALL-50469

S. Dan'azumi<sup>1\*</sup>, A. Mohammed<sup>1</sup>

<sup>1</sup> Department of Civil Engineering, Bayero University Kano, PMB 3011, Kano Nigeria.

\* Presenting Author: [sdanazumi.civ@buk.edu.ng](mailto:sdanazumi.civ@buk.edu.ng)

**Keywords:** Textile industries, physico-chemical analysis, Nigeria

## INTRODUCTION / MAIN METHODS

Textile industries produce wastewater as a by-product which is discharged into the environment. Researches have indicated that, among the various stages of textile production, operations which include fibre manufacturing, spinning and weaving, pre-treatment, desizing, scouring, bleaching, dyeing and finishing produce most of the pollutants (NIIR, 2003). The textile wastes contain unused or partially used organic compounds, and high BOD, often of strong colour and high temperature (Hussaini and Arif, 2004). When disposed into water bodies or onto land these effluents will result in the deterioration of ecology and damage to aquatic life. Furthermore they may cause damage to fisheries, impact on human health and cause economic loss to fishermen and farmers. Therefore, the industries are required, by regulations, to treat the wastewater in order to avoid water pollution and to protect the environment. In Nigeria, the National Environmental Standards and Regulations Enforcement Agency (NESREA) is charged with this responsibility (NESREA, 2009). Despite the existence of this Agency, there are growing concerns that many industries in Nigeria do not treat their wastewater or are partially treating their wastewater. Also the treatment systems are either obsolete or not properly maintained thereby releasing effluent that is harmful to the environment. Despite the gross pollution in the receiving water bodies, the water from these sources is being used as means for water supply, irrigation, fishing, and even for recreation. High prevalence of some diseases in Sub-saharan Africa may not be unconnected with this and this study is carried out to investigate the performance efficiencies of wastewater treatment plants (WWTP) from three textile industries in Kano – Nigeria in order to ascertain whether or not the effluent from the WWTP meet standards. As textile industries discharge a significant proportion of effluent, the research may form a database for monitoring effluent from textiles and for proper enforcement of standards by regulatory agencies.

Three textile industries with functional WWTPs were selected and the performance efficiencies of their WWTP were measured using influent and effluent samples of the WWTP. The unit operations in the first WWTP include equalization tank, coagulation tank, primary tube settler, aeration tank, secondary clarifier and carbon filter. The second WWTP has equalization tank, coagulation tank, clarifier, sand filter and carbon filter while the third WWTP has equalization tank, flash mixer, primary clarifier, aeration tank and secondary clarifier. Samples were collected on hourly basis from 9am to 4pm during working days and a composite sample was formed. A total number of seventeen composite samples were collected and analysed in accordance with standard methods for the examination of water and wastewater (APHA, 2012). Parameters such as pH, BOD, COD, TSS, TDS, Sulphate, Ammonia-nitrogen, Chromium, Cadmium, Lead, Copper and Zinc were investigated for both the influent and effluent to the WWTP.



## MAIN RESULTS AND CONCLUSIONS

The influent to the three WWTPs were monitored and found to be in the following range: pH: 9.8-11.6, BOD: 468-958 mg/l, COD: 1984-2256 mg/l, TSS: 652-5600 mg/l, TDS: 830-6350 mg/l, Sulphate: 234-532 mg/l, Ammonia-nitrogen: 44-202 mg/l, Chromium: 0.15-2.13 mg/l, Cadmium: 0.009-1.080 mg/l, Lead: 0.019-0.340 mg/l, Copper: 0.04-0.54 mg/l and Zinc: 0.072-0.880 mg/l. Similarly, the effluent from the three WWTPs range in the following manner: pH: 6.8-7.2, BOD: 114-251 mg/l, COD: 208-464 mg/l, TSS: 80-550 mg/l, TDS: 140-530 mg/l, Sulphate: 159-236 mg/l, Ammonia-nitrogen: 14-87 mg/l, Chromium: 0.05-1.06 mg/l, Cadmium: 0.002-0.250 mg/l, Lead: 0.011-0.11 mg/l, Copper: 0.010-0.26mg/l and Zinc: 0.012-0.055 mg/l. Table 1 shows result of the average concentration of influent and effluent to the three WWTPs. The mean percentage removal efficiencies of the WWTPs were estimated to be 73% for BOD, 83% COD, 92% for TSS, 91% for TDS, 87% for TDS, 52% for sulphate, 69% for ammonium nitrogen, 43% for Chromium, 76% for Cadmium, 69% of Lead, 59% for Copper and 74% for Zinc. Despite the seemingly appreciable reduction of most pollutants, parameters such as BOD, COD, TSS, Ammonia-nitrogen, chromium, cadmium, copper and lead in the effluent were found to be above the maximum permissible limits (MPL) for discharge into receiving water bodies (Table 1).

It is therefore recommended that centralized WWTP should be adopted in order to treat wastewater from the industrial estates. Similarly, there should be proper monitoring of the industries to ensure compliance with standards.

**Table 1.** Average Concentrations of Influent and Effluent to the WWTPs and MPL.

Parameter	pH	TDS (mg/L)	TSS (mg/L)	BOD <sub>5</sub> (mg/L)	COD (mg/L)	SO <sub>4</sub> <sup>2-</sup> (mg/L)
Influent	10.7	4493	3885	740	2128	388
Effluent	6.9	400	327	201	357	187
MPL	6 – 9	2000	30	30	80	250
Removal efficiency (%)	36	91	92	73	83	52
Parameter	NH <sub>4</sub> -N (mg/L)	Cu (mg/L)	Zn (mg/L)	Cd (mg/L)	Cr (mg/L)	Pb (mg/L)
Influent	141	0.22	0.34	0.37	1.15	0.26
Effluent	44.3	0.09	0.09	0.09	0.66	0.08
MPL	20	0.05	0.20	0.01	0.10	0.05
Removal efficiency (%)	69	59	74	76	43	69

## REFERENCES

- APHA 2012: *Standard Methods for Examination of Water and Wastewater*, 22<sup>nd</sup> Edition. New York, American Public Health Association Inc.
- Hussaini, J. H. I. and Arif, M. 2004. Characterization of Textile Wastewater. *Journal of Industrial Pollution Control*, **20**(1): 137-144.
- NESREA 2009. National Environmental (Textile, Wearing Apparel, and Foot Wear Industry) Regulations. Federal Republic Official Gazette No.66 Volume 96. [www.nesrea.gov.ng/](http://www.nesrea.gov.ng/)
- NIIR 2003. *The Complete Technology Book on Textile Processing with Effluent Treatment*. National Institute of Industrial Research. ISBN 13: 9788178330501.



# Phenol biodegradation by bacterial cultures encapsulated in 3D microfiltration-membrane capsules for industrial wastewater treatment

Ref # S2SMALL-401335

E. Kurzbaum<sup>1\*</sup>, Y. Raizner<sup>1</sup>, O. Menashe<sup>2,3</sup>

<sup>1</sup>Shamir Research Institute, University of Haifa, P.O.B. 97, Qatzrin, Israel.

<sup>2</sup>Water Industries Engineering Department, Achi Racov Engineering School, Kinneret College on the Sea of Galilee, D.N. Emek Ha'Yarden 15132, Israel.

<sup>3</sup>BioCastle Water Technologies Ltd., Israel.

\* Presenting Author: [ekurzbaum@univ.haifa.ac.il](mailto:ekurzbaum@univ.haifa.ac.il)

**Abstract:** The aim of the present study was to evaluate the phenol biodegradation performance of bacterial cultures encapsulated in 3D microfiltration-membrane capsules named 'Small Bioreactor Platform' (SBP). The performance of this novel biotechnological approach was studied under different initial phenol concentrations and different operating conditions in batch and semi-continuous bioreactors. The maximal phenol biodegradation rate was 22 and 48 mg/L/h at an initial phenol concentration of 100 and 1000 mg/L in the batch and semi-continuous bioreactors, respectively. The initial phenol concentration played an important role in the degradation efficiency rates, as found in the batch bioreactor, where the degradation rate was lower under low and high initial concentrations, as described by the Haldane model. Concentration equalization between the two sides of the SBP capsule's membrane occurred after 80 min. The microfiltration membrane is perforated with holes that have an average diameter of 0.2-0.7  $\mu\text{m}$ . It is therefore suggested that the capsule's membrane is more penetrable compared to other polymeric matrixes used for bacterial encapsulation (such as alginate). This study shows that encapsulating phenol degraders within microfiltration-membrane capsules which create a confined environment has a potential for enhancing phenol removal in phenol-rich wastewaters.

**Keywords:** Phenol, biodegradation, encapsulation, wastewater treatment, small bioreactor platform (SBP), bioaugmentation

## 1. Introduction

Environmentally hazardous substances originating from anthropogenic activity cause eco-toxicological harm that has a great effect on the environment and on public health. Aromatic compounds are considered to have cytotoxic, mutagenic and carcinogenic effects on living organisms. Most of them can accumulate and remain in the environment for long periods of time (Mrozik and Piotrowska-Seget, 2010). Phenols are organic aromatic compounds that are soluble in water and are considered to be among the most challenging pollutants in many industries, including leather, textile, paints, plastics, olive mills, wine production, etc. The water treatment industry does not exhibit a sufficient ability to treat these compounds, and they may therefore accumulate and contaminate soil and water. Phenol compounds have a broad environmental footprint and their toxicity has a tremendous effect on living organisms (Kim et al., 2002). Phenol also causes a severe smell nuisance, even at low concentrations (0.005 mg/L) (Mollaei et al., 2010).

In 2013, phenol was officially included in the American Environmental Protection Agency's (EPA) list of 126 Priority Pollutants as well as in the European Union's treatment guidelines. These authorized guidelines present different methods that can be applied for finding the most effective and economical treatment for the removal of phenol compounds from wastewater (Kurzbaum et al. 2010; Oboirien et al. 2011). These methods include well-known physical and chemical treatments such as advanced oxidation processes (AOP's), including treatment with  $\text{H}_2\text{O}_2/\text{O}_3$ , metal ions (Fe, Ti) and UV radiation. However, none have been found to be economically, environmentally and energetically effective. The biological treatments, however, are considered to be a cost-effective, safer and environmentally-friendly alternative (Mrozik and Piotrowska-Seget 2010).

Use of bioreactors under the operation of continuous, semi-continuous or batch mode is a treatment process which is widely employed for biodegradation of phenol compounds. These bioreactors may be supplemented with an exogenous microbial biomass (bioaugmentation) in order to maximize their operational performance. This bioaugmentation process may also be used for the breakdown of selective contaminants (Menashe and Kurzbaum, 2014). The addition of an exogenous microbial biomass is usually performed with a microbial suspension. However, studies have showed that immobilization of the added biomass offers several advantages over free-living suspensions. These include a constant supply of nutrients, without competition by other microorganisms, and protection against preying by protozoan, metazoan and other microorganisms, environmental stresses, bacteriophages, toxins, and UV irradiation (Covarrubias et al., 2012).

Use of culture immobilization formulas has been developed following the realization that the failure of bioaugmentation in wastewater treatment plants (WWTP) may be the result of using a suspended exogenous culture. The reasons for failure of the suspended culture are competition and negative interactions with the natural local microflora, in addition to constant culture dilution induced by the continuous inflow and outflow currents in WWTP (Songzhe et al., 2009). Both abovementioned obstacles prevent the exogenous culture from achieving a biomass that is sufficient for performing the necessary metabolic bioprocess (Azaizeh et al., 2015; Duan et al., 2015; Rathore et al., 2013).

Many studies have investigated the advantages of immobilized bacteria over the free culture state and suggested that immobilized bacteria are preferable due to the physical protection and the fact that they cannot be washed out of the reactor (Ehrhardt and Rehm, 1989). Bacterial immobilization formulas include various platforms such as sponges, membranes,

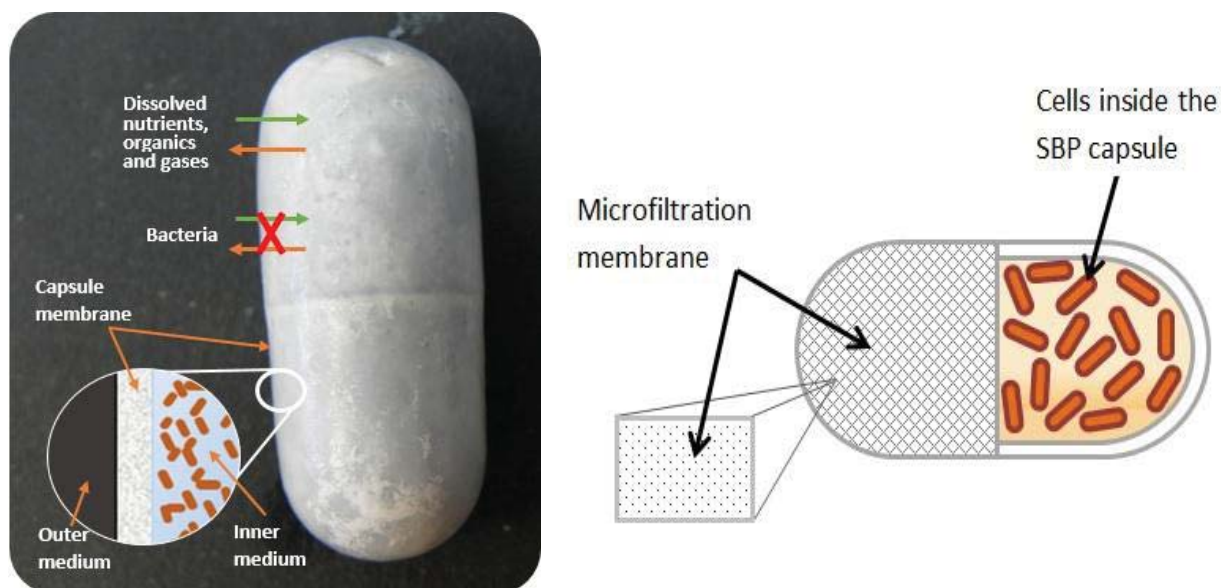
organic matter, gel beads, activated carbon, etc. Nevertheless, ongoing biotechnology and engineering developments enable new solutions that increase the biodegradation efficiency of the bioaugmented immobilized culture. A novel technology developed by BioCastle Water Technologies Ltd. (Israel) is the 'Small Bioreactor Platform' (SBP). This innovative method enables the creation of macro-encapsulation (2.5 cm long and 0.8 cm diameter) capsules for the introduced bacterial culture. The SBP capsule is designed to create preferable micro-environment growth conditions (nutrients, physical protection and more) for the inner culture (pure or mixed). The macro-encapsulation particle generates a confined environment by a wall made from a microfiltration membrane. The structural membrane capsule physically separates the introduced microbial culture inside the capsule from the outer aquatic medium which contains the natural microbial flora of the wastewater, while enabling diffusion and trafficking of nutrients across the capsule's membrane. The protective barrier prevents washout of the microorganisms from the bioreactor and slows the diffusion of toxic materials (Kurzbaum et al., 2017). The SBP capsules can be introduced into the host bioreactor as free suspended capsules within the aquatic medium or incorporated inside a perforated cage for site control. This cage provides some preferable local conditions for the introduced culture (such as placing it above an air diffuser for oxygen supply and mixing). It also prevents washout of the capsules from the bioreactor (Menashe and Kurzbaum, 2016).

We have previously reported the ability of the SBP capsules to biodegrade several phenol compounds as well as phenols in olive mill wastewater (OMWW) using a batch treatment approach (Azaizeh et al. 2015). The required hydraulic retention time was approximately 24 h for synthetic phenol compounds and longer for reduction of phenols in OMWW. In this study, we aimed to develop an effective and unique biological treatment for one of the most serious environmental contaminants, the phenol compounds, in order to create an efficient solution for their degradation. The specific aims of the study were to estimate the degradation rate of phenol in batch and semi-continuous bioreactors using the SBP capsules technology and to define the diffusion rate of phenol through the structural membrane of the SBP capsule.

## 2. Materials and methods

### 2.1 SBP capsules, solutions and materials

The encapsulated cultures in this study originated from a commercial bacterial blend, FOG (Fat Oil and Grease) type 2 purchased from USA Bio Products (USA), which were encapsulated within NatiCap™<sub>Municipal</sub> SBP capsules at BioCastle Water Technologies Ltd. (Israel). The capsule's microfiltration membrane is made of cellulose acetate encasing a supportive nutrient agar and the heterogeneous bacterial culture (Figure 1). The structure, composition, and validation of the SBP capsule technology are presented in detail in patent article number PCT/IL2010/000256. The SBP capsules were provided in a dry formula and the culture inside it is therefore in an inactive state. Activation of the capsules was performed with saline (0.85%) at 30°C and orbital shaking of 100 RPM for 48 h. Afterwards, the capsules were transferred into a new Erlenmeyer flask filled with sterile Minimal Salt Medium (MSM) (Muñoz et al., 2007) and phenol (20 mg/L). The final pH of the medium was adjusted to 7. All growth media and solutions used in this study were prepared with distilled water and autoclaved at 121°C for 20 min. Phenol stock (15 g/L) (Alaf Aesar) was prefiltered with a 0.22 µm filter (Merck Millipore) before supplementation into the experimental treatments.



**Figure 1.** Schematic illustrations of the 3D SBP capsule membrane with a bacterial cell suspension inside it (the capsule is 2.5 cm long with a 0.8 cm diameter). This capsule is built as a structural membrane chamber that separates the inner microbial culture from the outer wastewater flora, while enabling the diffusion of nutrients, oxygen and CO<sub>2</sub> across the capsule's membrane.

## 2.2 Measurements of phenol, dissolved oxygen, pH, culturable heterotrophic bacteria and determination of biodegradation kinetics

Phenol concentration was measured directly by sampling the bioreactor's medium using the 4-aminoantipyrine colorimetric method described at standard methods (1998) at 500 nm (Genesys 20, Thermo Science). pH/DO were measured with pH/DO meters (Eutech Instruments). The culturable heterotrophic bacteria within the SBP capsules and in the outer medium were determined by plating the samples after serial dilutions on 9 cm diameter nutrient agar plates (Neogene, USA) and the phenol-degrading bacteria by plating the samples on MSM-agar with phenol (150 mg/L) as the sole carbon source as described in Kurzbaum et al. (2016). All plates were incubated for 24 h at  $36\pm 1^\circ\text{C}$ .

The biodegradation rate was calculated for each phenol concentration treatment by plotting the negative logarithm of  $C/C_0$  against time, where the slopes of the obtained straight lines are equal to K (Banerjee and Ghoshal, 2010) as demonstrated in the equation:

$$-\ln \frac{C}{C_0} = KC \quad (1)$$

Where C is the phenol concentration;  $C/C_0$  is the relative concentration; K is the slope of the straight line derived from the logarithmic graph.

## 2.3 Experimental setup

### 2.3.1 Batch bioreactor

For the batch bioreactor experiment the reactor was operated initially under sterile conditions (MSM without SBP capsules) in order to conduct experimental cycles of control to ensure that any reduction in phenol concentration in the following treatments is the result of biodegradation alone and not chemical or physical processes. This was done for all initial phenol concentrations and operative conditions. Later, for the batch bioreactor experiment, 40 activated SBP capsules were introduced into 2000 mL Erlenmeyer flasks with a cotton plug, filled with 1000 mL MSM and homogenized with a magnetic stirrer at a constant temperature of  $30^\circ\text{C}$  (Figure 2). Five batch cycles were conducted using the same SBP capsules but with fresh MSM and different initial phenol concentrations (10, 50, 100 and 500 mg/L) for each cycle as described in Table 1. In each experimental cycle, phenol concentrations were measured frequently until reaching a minimal concentration value which indicated that phenol degradation had ceased. During cycles 3-5, additional oxygen was provided by air bubbling (10 L/min). At the end of the fifth cycle, total culturable heterotrophic and phenol-degrading bacteria concentrations were measured inside the SBP capsules.

### 2.3.2 Semi-continuous bioreactor

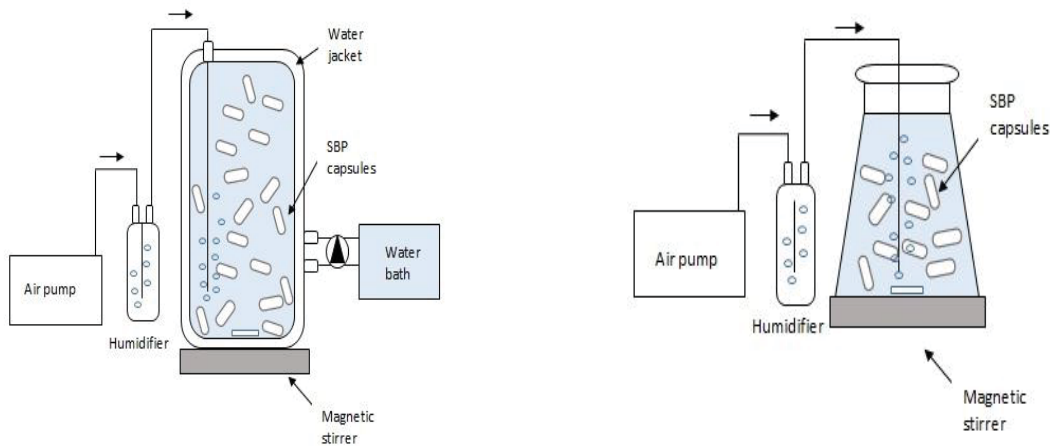
For the semi-continuous bioreactor experiment, 10 activated SBP capsules were introduced into a 500 mL bioreactor filled with 200 mL MSM and homogenized with a magnetic stirrer at a constant temperature of  $30^\circ\text{C}$  and  $36^\circ\text{C}$  for cycles 1-3 and 4-6, respectively (Figure 3 and Table 2). Six cycles were conducted using the same SBP capsules, when each cycle started after pumping out 100 mL medium from the bioreactor and introducing 100 mL of fresh MSM medium. Phenol was added from a stock solution to reach initial phenol concentrations of 50, 200, 500 and 1000 mg/L as described in Table 2 for each cycle. In each experimental cycle, phenol concentrations were measured frequently until reaching a concentration of 0 mg/L. During cycles 3-6, additional oxygen was provided by air bubbling (10 L/min). At the end of the sixth cycle, total culturable heterotrophic and phenol-degrading bacteria concentrations were measured inside the SBP capsules. Controls were done as described in the semi-continuous bioreactor above.

### 2.3.3 Phenol diffusion

One of the most important issues in the bacterial encapsulation field is the diffusion of nutrients/organics through the immobilization/encapsulation matrix. In this study, this issue was addressed by monitoring the phenol diffusion rate through the SBP capsule's microfiltration membrane to the outer medium. The experiment was performed in 250 mL Erlenmeyer flasks filled with 100 mL sterile MSM without phenol. One sterile SBP capsule (without encapsulated biomass) filled with MSM containing 1000 mg/L phenol was added to each flask. The medium was homogenized using a magnetic stirrer at a constant temperature of  $30^\circ\text{C}$  to create conditions identical to the batch and semi-continuous bioreactor experiments. In order to monitor the rate of phenol outlet from the SBP capsule through the microfiltration membrane to the outer medium, phenol diffusion from the capsules into the MSM medium was studied by following the appearance of phenol in the outer medium. The experiment was performed in triplicates.

## 2.4 Statistics

Figures show means of three independent experimental replicates. Each data point represents the mean, and error bars represent the SD of the mean.



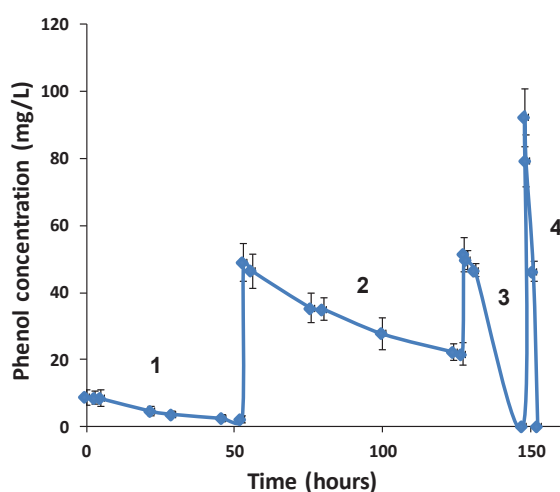
**Figure 2+3.** (Right) Schematic illustration of the batch bioreactor operation experiment. (Left) Schematic illustration of the semi-continuous bioreactor operation experiment.

### 3. Results and discussion

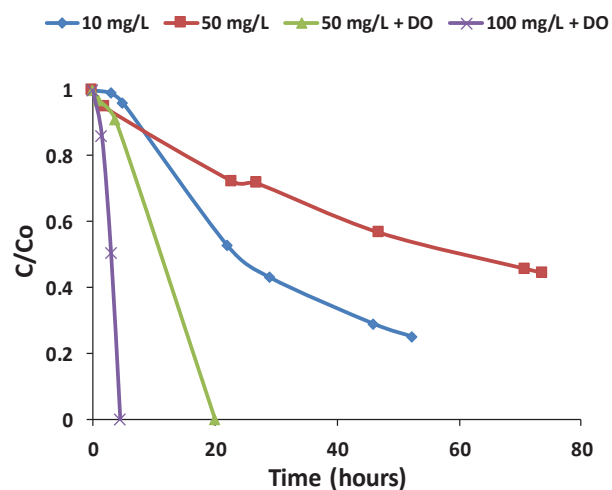
#### 3.1 Effect of initial phenol concentration on biodegradation in the batch and semi-continuous bioreactors

Phenol biodegradation rates in the batch bioreactor are presented in Table 1, Figure 4 and Figure 5.

Sterile controls did not alter phenol concentration in the MSM at all initial concentrations (data not shown). These controls revealed that nonbacterial processes are negligible factors in phenol removal in the studied batch and semi-continuous bioreactors.



**Figure 4.** Batch bioreactor experiment results: Phenol concentration over time in the four operational experimental cycles. Numbers above the line represent the cycle number (see Table 1).



**Figure 5.** Batch bioreactor experiment results: Normalized phenol concentration over time in the four operational experimental cycles. DO represents the addition of oxygen as air bubbling into the bioreactor's medium.

In the batch bioreactor, the lowest degradation rates were obtained at low phenol concentrations (10 and 50 mg/L, cycles 1 and 2, respectively). This was due to a low concentration of DO in the medium (less than 0.1-0.5 mg/L). In order to increase the biodegradation rate of the encapsulated culture, the following cycles were supplied with air bubbling that led to a DO concentration of 6.5 mg/L. Both cycles 3 and 4, containing 50 and 100 mg/L phenol, presented higher phenol degradation rates. However, cycle 5 which had the highest initial concentration (500 mg/L), achieved the lowest phenol degradation rate, probably due to phenol's toxicity to the encapsulated microorganisms (data shown only at Table 1).

A similar phenomenon was observed in the study of Bakhshi et al. (2011) that reported on decreased degradation rates at phenol concentrations higher than 500 mg/L. In the study of Saravanan et al. (2008) it was shown that a high phenol concentration (>500 mg/L) can inhibit bacterial metabolic processes, and a longer lag phase prior to entering the logarithmic growth phase was observed under higher phenol concentrations. Duan et al. (2015) used an immobilized bacterial culture in a bentonite and carboxymethyl cellulose gel and reported contradictory results. In this study they show that the phenol was fully degraded after 144 h at initial concentrations of 500 and 900 mg/L. However, a higher phenol

degradation rate was obtained at an initial concentration of 900 mg/L. Moreover, Kumar et al. (2005) reported that in a batch reactor with a *Pseudomonas putida* culture and an initial phenol concentration of 1000 mg/L, phenol biodegradation was completed after 162 h, with a calculated phenol biodegradation rate of 6 mg/L/h.

Oxygen enrichment was found to have a significant beneficial effect on the biodegradation rate, as shown for cycles 3-5. It should be noted that air supply also increases medium agitation, which may have some positive effect on the rate of phenol biodegradation by the encapsulated culture.

The kinetic constant K (Table 1, Table 2) is a common parameter for comparing biodegradation rates (Banerjee and Ghoshal, 2010). Phenol is considered to be an inhibitory substrate for microorganisms, for which Haldane's growth kinetic model well represents the biodegradation rate as a function of the initial phenol concentration (Kurzbaum et al. 2010). Our results show that at lower initial phenol concentrations the K is low, then it increases up to a certain concentration, and at the highest concentrations it again decreases. These results are concurrent with many previous studies (such as Bakhshi et al. 2011; Banerjee and Ghoshal 2010; Kumar et al. 2005). Bakhshi et al. (2011), for example, investigated the kinetic constant K and defined it as a first-order kinetic model of substrate utilization in a batch bioreactor. They found that the rate constants for initial phenol concentrations of 300, 500, 700 and 1000 mg/L were 0.0266, 0.0209, 0.0089 and 0.0063 h<sup>-1</sup>, respectively. These findings are very similar to the values obtained in the present study. In the study of Mollaei et al. (2010), the observed phenol degradation rate in a batch bioreactor was 25 mg/L/h when using alginate as an immobilization matrix. At an initial concentration of 1000 mg/L, the alginate capsules degraded the phenol after approximately 40 h. Our results show that at the same initial concentration (1000 mg/L), the SBP capsules in the semi-continuous bioreactor degraded the phenol in less than 10 h.

**Table1.** Operational and measured phenol degradation kinetic parameters in the batch bioreactor experiment.

Cycle	Time (min)	Phenol concentration (mg/L)	Temp (°C)	DO (mg/L)	Degradation (%)	Degradation rate (mg/L/h)	K (h <sup>-1</sup> )
1	50	10	30	0.3	75	0.2	0.028
2	125	50	30	0.3	55	0.6	0.0108
3	145	50	30	>6.5	100	2.9	0.0252
4	150	100	30	>6.5	100	22	0.0292
5	152	500	30	>6.5	20	3.6	0.0082

**Table2.** Operational and measured phenol degradation kinetic parameters in the semi-continuous bioreactor experiment.

Cycle	Time	Phenol concentration (mg/L)	Temp (°C)	DO (mg/L)	Degradation (%)	Degradation rate (mg/L/h)	K (h <sup>-1</sup> )
1	15	50	30	-	100	7.6	0.0228
2	25	200	30	-	100	11.9	0.00534
3	70	500	30	-	100	8.6	0.0506
4	95	500	36	>6.5	100	16	0.0495
5	105	500	36	>6.5	100	22.4	0.0972
6	115	1000	36	>6.5	100	48	0.1357



The differences in phenol biodegradation rate between alginate beads and the SBP capsules might point to differences in the suspended (SBP capsule) versus the immobilized (alginate beads) bacterial state within the encapsulated matrix which has an effect on its metabolic rate. Phenol diffusion through the different encapsulation barriers (cellulose acetate membrane versus alginate) probably also influences the biodegradation rate.

Phenol biodegradation rates in the semi-continuous bioreactor operation are presented in Table 2, Figure 6 and Figure 7. The semi-continuous bioreactor operation reduces the possibility of accumulation of byproducts in the bioreactor's medium. In the six experimental cycles, phenol biodegradation was completed and reached 0 mg/L faster than in the batch bioreactor. In cycles 1-3, performed at 30°C with a phenol concentration of 50, 200, 500 mg/L, the degradation rates were lower compared with cycles 4-6 which were carried out at 36°C, with 7.6-11.9 mg/L/h and 16-48 mg/L/h, respectively. The highest phenol biodegradation rate, 48 mg/L/h, was observed in cycle 6 which had an initial phenol concentration of 1000 mg/L. To the best of our knowledge, there are no data in the literature on bioaugmentation and bioremediation of an encapsulated culture within a semi-continuous bioreactor. This study demonstrates that the known advantages of semi-continuous operation (Shulter and Kargi, 2000) are very important also for encapsulated cultures in wastewater treatment processes aimed at biodegrading specific inhibitory contaminants such as phenol.

As shown in Table 1 and Table 2, poor oxygen supply and lower temperature (30°C) resulted in lower degradation rates. At a higher oxygen concentration and temperature, the degradation rates increased significantly. For example, in order to increase degradation rates using the encapsulated culture, the initial concentration of 500 mg/L was tested under agitation alone or with an additional air supply (by bubbling) and under two temperatures (30°C and 36°C). Figure 8 shows the normalized phenol concentration against time under these different conditions. The lowest rate was obtained with agitation alone at 30°C. A higher rate was obtained with the addition of air bubbling, and highest rates when air supply was accompanied with a higher temperature (36°C), with values reaching 8.58 mg/L/h, 16 mg/L/h and 22.4 mg/L/h, respectively. Previous studies also show the importance of temperature for phenol biodegradation by immobilized cultures, with 35-36°C being the most effective temperatures at all initial phenol concentrations (50-1000 mg/L) (Duan et al. 2015; Rava et al. 2015).

### 3.2 Culture characterization

The bacterial cell count inside the SBP capsules exhibited a high concentration of a heterotrophic population and a lower phenol-degrading population, with  $5.54 \times 10^{11}$  CFU/mL and  $1.74 \times 10^9$  CFU/mL, respectively. It is assumed that the phenol is fully degraded not only by the phenol degraders, but also by a co-metabolic degradation of the total heterotrophic mixture that also degrades the byproducts and intermediates as described earlier by Oboirien et al. (2005) and Marrot et al. (2006) which described the use of several microorganism populations as an advantage for co-metabolic degradation of phenols and polycyclic aromatic hydrocarbons (PAH).

### 3.3 SBP capsule diffusion

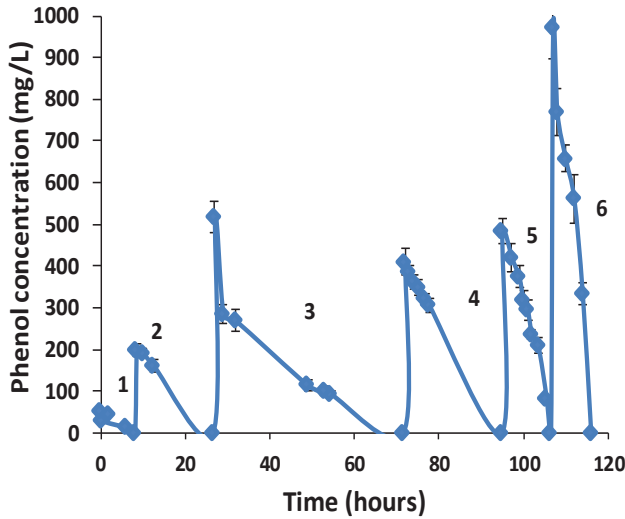
Figure 9 shows the diffusion of phenol through the SBP capsule membrane to the outer medium over time. The aim was to evaluate the phenol diffusion rate through the SBP capsule's microfiltration membrane under sterile conditions. The results show a relatively high initial phenol diffusion rate from the SBP capsules to the outer medium, reaching concentration equalization after 80 min. The time period for reaching a concentration equalization between the two sides of the capsule's membrane is in the range that Gabardo et al. (2011) found for nitrate and glycerol diffusion through alginate beads (30 min and 10 h, respectively).

The growth rate and the contaminant biodegradation rate of encapsulated cultures are usually modified due to substrate diffusion limitations through the encapsulation matrix of the encapsulated cultures. This was shown in previous studies with alginate beads or other polymeric matrixes (Gabardo et al., 2011). The SBP capsule's microfiltration membrane is perforated with 0.2-0.7  $\mu\text{m}$  holes (Menashe 2010), a fact that may enable higher diffusion rates into the encapsulated culture compared with other polymeric matrixes used for encapsulation. In a previous study we demonstrated that the biodegradation rates of three phenols (tannic, gallic and caffeic acids) were up to 2-fold slower when using a SBP encapsulated culture compared to a suspended culture (Azaizeh et al., 2015). This ratio is considered low compared to other formulation matrixes used for bacterial immobilization. Chen et al. (2007), for example, demonstrated that the kinetic ratio of phenol degradation by immobilized and suspended cultures of *Pseudomonas putida* was 1 and 6, respectively. Use of the same bacterial cultures under the same conditions but in a different growth state (suspended vs. encapsulated) can indicate the influence of the encapsulation matrix on the biodegradation rate. It is therefore suggested that the SBP capsule's membrane is more penetrable compared to other encapsulation matrixes. Future research should address this issue in order to optimize the SBP capsule's encapsulation membrane.

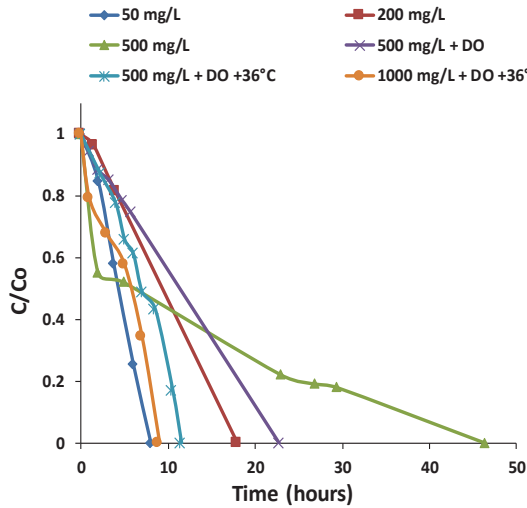
On the other hand, Moslemy et al. (2002), who focused on gasoline biodegradation using free and encapsulated bacteria, showed that the degradation rate of the encapsulated bacteria increased and appeared as a first-order reaction, contrary to the non-linear reaction of the free bacteria that decreased significantly under higher gasoline concentrations. This demonstrates the advantage of bacterial encapsulation over suspension growth when inhibitory substrates are involved.



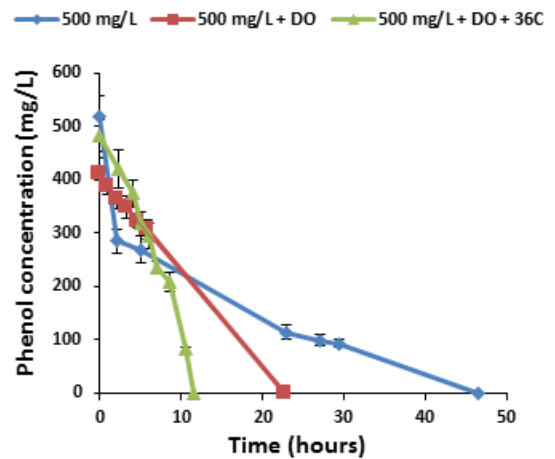
Fig 6



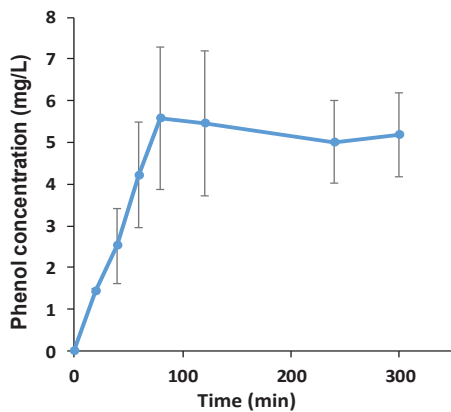
**Figure 6.** Semi-continuous reactor experiment results: Phenol concentration over time in the six operational experimental cycles. Numbers above the line represent the cycle number (see Table 2).



**Figure 7.** Semi-continuous reactor experiment results: Normalized phenol concentration over time under different operation conditions. DO represents the addition of oxygen as air bubbling into the bioreactor's medium. All cycles were performed at 30°C except where 36°C is mentioned.



**Figure 8.** Semi-continuous reactor experiment results: Biodegradation of 500 mg/L phenol under different operation conditions: DO represents the addition of oxygen as air bubbling into the bioreactor's medium. All cycles were performed at 30°C except where 36°C is mentioned.



**Figure 9.** Diffusion of phenol through the SBP capsule's microfiltration membrane from the inner part of the capsule to the outer medium over time.

## 4. Conclusions

- The current study investigated phenol biodegradation using encapsulated cultures within SBP capsules under batch and semi-continuous bioreactors.
- The semi-continuous bioreactor showed higher degradation rates compared to the batch bioreactor.
- The SBP capsules encapsulate a small volume of a bacterial suspension in a 3D membrane. It is expected that the capsule's membrane is more penetrable compared to other encapsulation matrixes. Diffusion rates into and out of the capsules thus facilitate higher biodegradation rates.
- Practically, the SBP technology can be useful for treating phenol-rich wastewaters which cannot maintain a sufficient natural microbial flora due to phenol toxicity or low hydraulic retention time (HRT) in the reactor.

## 5. References

- Azaizeh, H., Kurzbaum, E., Said, O., Jaradat, H., and Menashe, O. 2015 The potential of autochthonous microbial culture encapsulation in a confined environment for phenol biodegradation. *Environmental science and pollution research international*, **22**(19), 15179-87.
- Bakhshi, Z., Najafpour, G., Kariminezhad, E., and Pishgar, R. 2011 Growth kinetic models for phenol biodegradation in a batch culture of *Pseudomonas putida*. *Environmental Technology*, **32**, 1837–41.
- Banerjee, A. and Ghoshal, A. K. 2010 Phenol degradation by *Bacillus cereus*: pathway and kinetic modeling. *Bioresource technology*, **101**(14), 5501–7.
- Bouchez, T., Patureau, D., Dabert, P., Juretschko, S., Doré, J., Delgenès, P., Moletta, R., and Wagner, M. 2000 Ecological study of a bioaugmentation failure. *Environmental Microbiology*, **2**(2), 179–190.
- Chen, Y. M., Lin, T. F., Huang, C., Lin, J. C., and Hsieh, F. M. 2007 Degradation of phenol and TCE using suspended and chitosan-bead immobilized *Pseudomonas putida*. *Journal of Hazardous Materials*, **148**(3), 660–670.
- Esplugas, S., Gimenez, J., Contreras, S., Pascual, E., & Rodríguez, M. 2002 Comparison of different advanced oxidation processes for phenol degradation. *Water research*, **36**(4), 1034-1042.
- Covarrubias, S. A., De-Bashan, L. E., Moreno, M., and Bashan, Y. 2012 Alginate beads provide a beneficial physical barrier against native microorganisms in wastewater treated with immobilized bacteria and microalgae. *Applied Microbiology and Biotechnology*, **93**(6), 2669–2680.
- Duan, L., Wang, H., Sun, Y., and Xie, X. 2015 Biodegradation of Phenol From Wastewater by Microorganism Immobilized in Bentonite and Carboxymethyl Cellulose Gel. *Chemical Engineering Communications*, **203**(7), 948-956.
- Ehrhardt, H. M. and Rehm, H. J. 1989 Semicontinuous and continuous degradation of phenol by *Pseudomonas putida* P8 adsorbed on activated carbon. *Applied Microbiology and Biotechnology*, **30**(3), 312–317.
- Gabardo, S., Rech, R., and Ayub, M. A. Z. 2011 Determination of lactose and ethanol diffusion coefficients in calcium alginate gel spheres: Predicting values to be used in immobilized bioreactors. *Journal of Chemical and Engineering Data*, **56**(5), 2305–2309.
- Kim, J. H., Oh, K. K., Lee, S. T., Kim, S. W., and Hong, S. I. 2002 Biodegradation of phenol and chlorophenols with defined mixed culture in shake-flasks and a packed bed reactor. *Process Biochemistry*, **37**(12), 1367–1373.
- Kumar, A., Kumar, S., and Kumar, S. 2005 Biodegradation kinetics of phenol and catechol using *Pseudomonas putida* MTCC 1194. *Biochemical Engineering Journal*, **22**(2), 151–159.
- Kurzbaum, E., Kirzhner, F., and Armon, R. 2016 Performance comparison of plant root biofilm, gravel attached biofilm and planktonic microbial populations, in phenol removal within a constructed wetland wastewater treatment system. *Water SA*, **42**(1), 166–170.
- Kurzbaum, E., Kirzhner, F., Sela, S., Zimmels, Y., and Armon, R. 2010 Efficiency of phenol biodegradation by planktonic *Pseudomonas pseudoalcaligenes* a constructed wetland isolate) vs. root and gravel biofilm. *Water Research*, **44**(17), 5021–5031.
- Kurzbaum, E., Raizner, Y., Cohen, O., Suckeveriene, R.Y., Kulikov, A., Hakimi, B., Kruh, L.I., Armon, R., Farber, Y. and Menashe, O. 2017 Encapsulated *Pseudomonas putida* for phenol biodegradation: Use of a structural membrane for construction of a well-organized confined particle. *Water Research*, **121**, 37-45.
- Marrot, B., Barrios-Martinez, a., Moulin, P., and Roche, N. 2006 Biodegradation of high phenol concentration by activated sludge in an immersed membrane bioreactor. *Biochemical Engineering Journal*, **30**(2), 174–183.

- Martinsen, a, Storrø, I., and Skjærk-Braek, G. 1992 Alginate as immobilization material: III. Diffusional properties. *Biotechnology and bioengineering*, **39**(2), 186–194.
- Menashe, O. 2010 Microorganism comprising particles and uses of same. Patent application number PCT/IL2010/000256.
- Menashe, O. and Kurzbaum, E. 2016 A novel bioaugmentation treatment approach using a confined microbial environment: a case study in a Membrane Bioreactor wastewater treatment plant. *Environmental technology*, **37**(12), 1582-1590.
- Menashe, O. and Kurzbaum, E. 2014 Small-bioreactor platform technology as a municipal wastewater additive treatment. *Water Science and Technology*, **69**(3), 504–510.
- Mollaie, M., Abdollahpour, S., Atashgahi, S., Abbasi, H., Masoomi, F., Rad, I., Lotfi, A. S., Zahiri, H. S., Vali, H., and Noghabi, K. A. 2010 Enhanced phenol degradation by *Pseudomonas* sp. SA01: Gaining insight into the novel single and hybrid immobilizations. *Journal of Hazardous Materials*, **175**(1–3), 284–292.
- Moslemy, P., Neufeld, R. J., and Guiot, S. R. 2002 Biodegradation of gasoline by gellan gum-encapsulated bacterial cells. *Biotechnology and Bioengineering*, **80**(2), 175–184.
- Mrozik, A. and Piotrowska-Seget, Z. 2010 Bioaugmentation as a strategy for cleaning up of soils contaminated with aromatic compounds. *Microbiological Research*, **165**(5), 363–375.
- Muñoz, R., Díaz, L. F., Bordel, S., and Villaverde, S. 2007 Inhibitory effects of catechol accumulation on benzene biodegradation in *Pseudomonas putida* F1 cultures. *Chemosphere*, **68**(2), 244–252.
- Nawawi, N. M., Ahmad, S. A., Shukor, M. Y., Syed, M. A., and Ibrahim, L. 2014 Isolation and Characterization of Phenol-Degrading Microorganism: Recent Advances. *Journal of Environmental Bioremediation and Toxicology*, **2**(1), 11–22.
- Oboirien, B. O., Amigun, B., Ojumu, T. V., Ogunkunle, O. A., Adetunji, O. A., Betiku, E., and Solomon, B. O. 2005 Substrate inhibition kinetics of phenol degradation by *Pseudomonas aeruginosa* and *Pseudomonas fluorescence*. *Biotechnology*, **4**(1), 56–61.
- Pramanik, S., Khanna, R., Katti, K., McEvoy, J., and Khan, E. 2011 Effects of entrapment on nucleic acid content, cell morphology, cell surface property, and stress of pure cultures commonly found in biological wastewater treatment. *Applied Microbiology and Biotechnology*, **92**(2), 407–418.
- Rathore, S., Desai, P. M., Liew, C. V., Chan, L. W., and Heng, P. W. S. 2013 Microencapsulation of microbial cells. *Journal of Food Engineering*, **116**(2), 369–381.
- Rava, E., Chirwa, E., Allison, P., van Niekerk, M., and Augustyn, M. P. 2015 Removal of hard COD, nitrogenous compounds and phenols from a high-strength coal gasification wastewater stream. *Water SA*, **41**(4), 441–447.
- Saravanan, P., Pakshirajan, K., and Saha, P. 2008 Growth kinetics of an indigenous mixed microbial consortium during phenol degradation in a batch reactor. *Bioresource Technology*, **99**(1), 205–209.
- Shulter, M.L. and Kargi, F., 2000. Bioprocess engineering basic concept. New Delhi: Parentice-Hall of India Pvt Ltd.
- Songzhe, F.U., Hongxia, F.A.N., Shuangjiang, L.I.U., Ying, L.I.U. and Zhipei, L.I.U 2009 A bioaugmentation failure caused by phage infection and weak biofilm formation ability. *Journal of Environmental Sciences*, **21**(8), 1153–1161.
- Standard Methods for the Examination of Water and Wastewater* 1998 20th edn, American Public Health Association/American Water Works Association/Water Environment Federation, Washington DC, USA.

## Removal of phenolic compounds from wastewater by

### *Phragmites australis*-bacteria association

Ref # S2SMALL-36681

**R. Wirasnita \***, T. Toyama, K. Mori

Interdisciplinary Graduate School of Medicine and Engineering, University of Yamanashi, 4-3-11, Takeda, Kofu, Yamanashi 400-8511, Japan

\* Corresponding Author: [rie\\_riy@yahoo.com](mailto:rie_riy@yahoo.com)

**Keywords:** biodegradation, degrading bacteria, phenolic compound, *Phragmites australis*,

#### INTRODUCTION

Phenolic compounds are the most commonly found pollutants in the aquatic environment. There are many types of phenolic compounds such as nitrophenols, chlorophenols, alkylphenols, bisphenols. Some of phenolic compounds are toxic and persistent in aquatic environments. It is necessary to establish technologies to remove phenolic compounds from contaminated water.

Rhizoremediation, the degradation and removal of pollutants by microbial activity in the rhizosphere of plants, is a cost-effective and environmentally friendly remediation technology. Some studies have shown the accelerated biodegradation of phenolic compounds in waters (Hoang *et. al.*, 2010, Toyama *et. al.*, 2011, Kristanti *et. al.*, 2014). However, the accelerated biodegradation of phenolic compounds by rhizosphere is not fully understood.

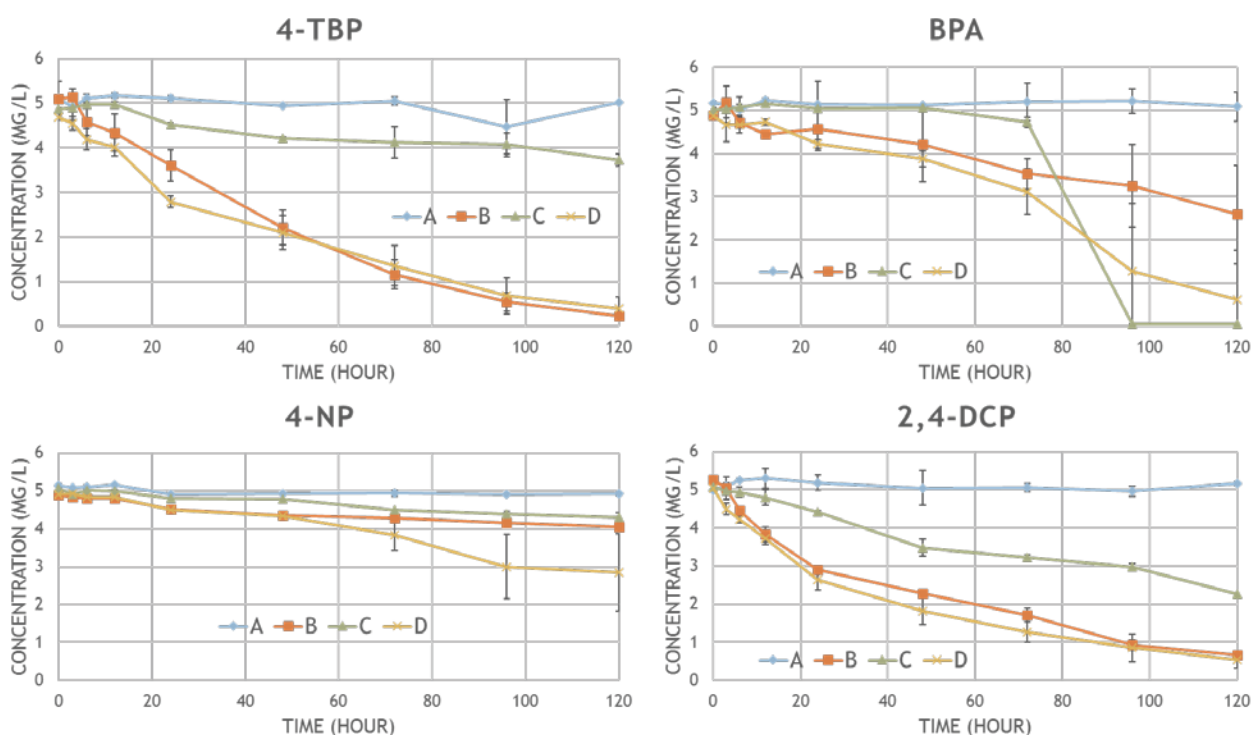
The objectives of this study were to evaluate the accelerated removal of four phenolic compounds, 4-*tert*-butylphenol (4-tBP), bisphenol A (BPA), 4-nitrophenol (4NP) and 2,4-dichlorophenol (2,4-DCP), in the rhizosphere of common reed (*Phragmites australis*) and to isolate and characterize the phenolic compound-degrading bacteria from *P. australis* rhizosphere.

#### MATERIAL AND METHODS

Four different phenolic compounds, 4-tBP, BPA, 4-NP and 2,4-DCP, were used in this study. Ten weeks old sterile *P. australis* and secondary effluent wastewater of municipal wastewater treatment plant were used in the phenolic compounds removal experiments. In the phenolic compounds removal experiments, four types of microcosms Microcosm A (control): each phenolic compound (5 mg/L) in sterilized Hoagland solution; Microcosm B (removal by plant alone): each phenolic compound in sterilized Hoagland solution with a sterile *P. australis*; Microcosm C (removal by bacteria alone): each phenolic compound in wastewater; and Microcosm D (removal by bacteria-plant association): each phenolic compound in wastewater with a *P. australis* were prepared. All microcosms were incubated at 28±1°C under fluorescent lamp at 8000 lux (16-h light and 8-h dark condition) for five days. The phenolic compound concentration was measured by HPLC during the experiments. At the end of experiments, microbial populations in microcosms were analysed and each phenolic compound-degrading bacteria were isolated from *P. australis* rhizosphere (microcosm D).

## RESULTS AND DISCUSSION

Figure 1 shows the degradation profiles of phenolic compounds in the four different microcosms. As shown in microcosm B, common reed has higher ability to remove 4-tBP and 2,4-DCP compared with BPA and 4-NP. Microcosm C shows the biodegradation by bacteria in wastewater. BPA was completely degraded by bacteria after three days, but 4-tBP, 4-NP and 2,4-DCP were slightly and slowly removed by bacteria. Microcosm D shows the phenolic compound removal by bacteria-plant association. Distinct removals of 4-tBP, BPA, 4-NP and 2,4-DCP were observed in microcosm D. The results suggest that rhizoremediation using *P. australis* can be effective for the treatment of the phenolic compound-contaminated water. After removal experiments, 4-tBP-, BPA-, 4-NP- and 2,4-DCP-degrading bacteria were isolated and identified from microcosm D.



**Figure 1.** Degradation profiles of 4-tBP, BPA, 4-NP, and 2,4-DCP in flasks A, B, C, and D.

## References

- Hoang, H., Yu, N., Toyama, T., Inoue, D., Sei, K. and Ike, M., 2010. Accelerated degradation of a variety of aromatic compounds by *Spirodela polyrrhiza*-bacterial associations and contribution of root exudates released from *S. polyrrhiza*. *Journal of Environmental Sciences*, **22**(4), 494-499.
- Kristanti, R.A., Toyama, T., Hadibarata, T., Tanaka, Y. and Mori, K., 2014. Sustainable Removal of Nitrophenols by Rhizoremediation Using Four Strains of Bacteria and Giant Duckweed (*Spirodela polyrrhiza*). *Water, Air, & Soil Pollution*, **225**(4), 1928.
- Toyama, T., Murashita, M., Kobayashi, K., Kikuchi, S., Sei, K., Tanaka, Y., Ike, M. and Mori, K., 2011. Acceleration of nonylphenol and 4-*tert*-octylphenol degradation in sediment by *Phragmites australis* and associated rhizosphere bacteria. *Environmental science & technology*, **45**(15), 6524-6530.

Chairs:

Maria Figueras - Univerisitat Rovira I Vigili

María J. Gunnarsdóttir - University of Iceland

**Introduction of Aquavalens**

**Status of water safety plans and risk assessment in small water supplies in Europe**

Arnt Dierner - *WHO Regional Office for Europe*

**Water safety plans with improved techniques to detect pathogens**

María J. Gunnarsdóttir - *University of Iceland*

**Quantitative Microbial Risk Assessment in small private supplies**

Paul Hunter - *University of East Anglia*

**Carbon Footprint and economic implications of new technologies in detecting waterborne pathogens**

Maria Figueras - *Univerisitat Rovira I Vigili*

**Discussion**



## **S<sub>2</sub>Small conference 22 – 26 October 2017 in Nantes France**

### **Workshop on wider impact of Aquavalens on Wednesday 25 October 14.00-16.00**

#### **Status of water safety plans and risk assessment in small water supplies in Europe**

Arnt Diener, WHO Regional Office for Europe

In the pan-European, one quarter of the population is supplied by small water schemes - predominantly households in rural areas. Country assessments reveal that these households significantly lag behind in access to safely managed water on premises and that rural supplies more frequently fail compliance with *E. coli* limits than urban schemes. Small water supplies feature the common challenge of relatively high per unit costs, limited access to technical advice or materials and are frequently management by undertrained staff. Still many national regulations do not provide particular requirements for small water schemes. The issue of water safety in small supplies is a recognized concern in the region and is addressed by the Protocol on Water and Health and the Sustainable Development Goals. The WHO has developed practical guidance for the implementation of the water safety plan approach in small systems. The WHO European Centre for Environment and Health is assisting countries in the pan-European Region with introducing water safety plans for rural areas and small schemes in policy and practice.

#### **Water safety plans with improved technique to detect pathogens**

María J. Gunnarsdóttir, University of Iceland

Access to safe water is essential for public health. The water sector has implemented water safety plans (WSP) as proactive approach to protect water from contamination. The Aquavalens project has the goal of improving methods for the detection of pathogens in drinking water. New methods and technique has been developed, standardized and tested in the project at twenty water supplies in seven European countries. The task was to evaluate how these methods can be implemented and improve the water safety plan management system as an operational tool. It has been shown to improve knowledge on pathogen present and identify water quality problems. This new knowledge will assist in validating WSP control measures and to perform risk assessment. It will also assist in microbiological control in water treatment processes. The new methods will support risk management in small supplies and have the potential to answer the question is WSP performing as it should to the general public, the regulatory authority and the scientific communities. Evaluation has been done with chosen measurable indicators and questionnaires with open questions together with sanitary inspection performed as a part of the project. Results from this evaluation will be presented at the workshop.

## Quantitative Microbial Risk Assessment (QMRA) in small private supplies

Paul R. Hunter, University of East Anglia

It is now well known that the risks to consumers associated with small and very small water supplies are substantially greater than those associated with large water supplies. Evidence for this comes from surveys of finished water quality, reports of outbreaks and epidemiological studies of disease. Potential reasons for this greater risk include; poorer quality source water, poorer treatment, insufficient funding and lack of adequately trained system managers. There remains, however, uncertainty as to the actual risks to health. A few years ago, we reported on a QMRA study of *Cryptosporidium* and *Giardia* in private supplies in the UK and France. As part of the AQUAVALENS project we have been revisiting that study and reassessing the risks. One issue that has been raised in the intervening years has been how one extrapolates from risk of infection per day to risk of illness per year. We have been using microsimulation modelling techniques to improve our estimates of disease risk from small water supplies and will present our results.

## Carbon Footprint and economic implications of new technologies in detecting waterborne pathogens

Carmen Maria Torres Costa\* and Maria Jose Figueras, University Rovira i Virgili

The Aquavalens research project, funded by the EU aims to improve the safety of European drinking water through the development of technologies that would allow a more rapid detection of viruses, bacteria and parasites. However, within the project the environmental impact of the newly developed technologies is also evaluated through the analysis of their carbon footprint (CFP). So far no CFP data have been reported for analytical procedures used to determine water quality, so this can be considered an original innovation in our project. To achieve this, an inventory of the expected emissions generated by the novel technologies versus classical standard methods was established. The sources of primary data came from the manufacturer partners, and from the end-user partners. Specific questionnaires were designed to obtain flows of materials, energy and wastes, with special attention to packaging in platform production and transport and energy consumption during the platforms use. In the whole life cycle of the product, the use phase is by far the major CFP contributor. The uncertainty analysis conducted illustrated the consequences in the CFP results of the different decisions, analytical choices and laboratory management during the collection and analysis of the samples. The collection of the samples, and specifically the transport to and from the sampling point to the laboratory, was found to be the most significant contributor in the total CFP affecting also the variability of the final score.

### Environmental assessment, policy and legislation

**662 - Sustainability environmental indicators of the Yucatan peninsula, México**

SEGURA Irleth - *Mexican Institute of Water Technology*

**719 - Successful Patind hydropower Project while Minimizing Environmental and Social Impact**

CHA Keeuk - *Star Hydro Power Limited Co, Pakistan*

**749 - Optimal Location of Stormwater Tanks in Real Networks at Colombian Cities: Bogotá and Medellín**

SALCEDO Camilo - *Universidad de los Andes*

### Nanoscale Filtration and Molecular Separation

**868 - A Study on Nanoparticle-embedded Device for Nanoscale Filtration and Molecular Separation**

YOON Jae Sung - *Korea Institute of Machinery & Materials (KIMM)*

### Resources-oriented sanitation systems

**601 - Hygienisation of human urine effluent collected through a new diverting sanitary system**

KANOUN-BOULÉ Myriam - *Institute for Research and Technological Development in Construction, Energy, Environment and Sustainability*

**661 - Blackwater treatment with green microalgae *Chlorella vulgaris***

GRIESSLER BULC Tjaša - *University of Ljubljana, Faculty of health sciences*

**737 - Benefits of reducing toilet flushing volume in terms of resource recovery from blackwater**

TODT Daniel - *Ecomotive AS*

### Small scale and decentralized water / wastewater management systems

**287 - An assessment of decentralised wastewater treatment technologies in North-East England**

BUNCE Joshua T. - *Newcastle University*

**464 - Small-scale wastewater treatment in drinking water sources protection area: A case study in China**

LIU Chang - *South China Institute Of Environmental Sciences*

**564 - The impact assessment of the community based water supply business in remote areas of Tanzania, Bagamoyo**

SOSHINO Yasuhiro - *Japanese Red Cross Kumamoto Hospital*

**629 - Factors affecting the removal of bacterial indicator organisms in wastewater stabilization ponds operated in a temperate climate**

LIU Lei - *Queen's University*

**630 - Treatment performances of a pilot-scale free water surface constructed wetland system for secondary effluents**

JIN Meng - *Queen's University*

**677 - Assessment of groundwater quality status; Case study at Tshivhase villages in Limpopo Province, South Africa**

SENGANI Fhatuwani - *South Deep Gold Mine*

# Sustainability environmental indicators of the Yucatan peninsula, Mexico.

Ref # S2SMALL-99709

**Segura, I.<sup>1\*</sup>, Vázquez, V.<sup>1</sup>, Cervantes, E.<sup>1</sup>**

<sup>1</sup>Mexican Institute of Water Technology, Paseo Cuauhnáhuac 8532 Progreso, Jiutepec, Morelos, México.

\*Presenting Author: [irleth\\_segura@tlaloc.imta](mailto:irleth_segura@tlaloc.imta).

**Abstract:** The Mexican Institute of Water Technology through a project funded by the Gonzalo Rio Arronte Foundation drew up the master Plan in the field of water protection, conservation and recovery environmental of the Yucatan peninsula, which includes an environmental diagnosis and a battery of indicators; This last very important since it serves as an element of verification, monitoring and evaluation of the conservation and environmental recovery of the peninsula. The bacteria indicators update allows you to measure the effectiveness of the activities carried out over time and let you show your progress, identify successes and weaknesses and propose corrective actions to optimize the desired results. Moreover, these indicators reflect the ecological, social and economic status of the region in question. This work is based on the update of the range of indicators of the Master Plan in the field of water for the protection, conservation and recovery environmental of the Yucatan peninsula in 2013, which was carried out through an inclusive process involving the three levels of government, technical and educational institutions, organized civil population and the different uses of water users.

**Keywords:** environmental conservation, indicators, Yucatan peninsula.

## INTRODUCTION

The region of the Yucatan peninsula (PY) is located in Mexico, it is composed by the states of Campeche, Quintana Roo and Yucatan (Figure 1), this area is characterized by the availability of water sufficiency, so rational and sustainable use is a shared responsibility between the government and the society. Water is an issue that is of particular importance given that it is the source of life, their availability determines the development of many regions of the country (CONAGUA 2012).



**Figure 1.** Location of the Yucatan península, Mexico.

The 2011 the Mexican Institute of Water Technology (IMTA) through a project funded by the Gonzalo Rio Arronte Foundation (FGRA) elaborate the master Plan in the area of water protection, conservation and recovery environmental of the Yucatan peninsula which is a document that aims to orient actions and programs that run the various actors of PY to

conserve and preserve the water resources and the environment (Espinosa 2011); his design approach is based on a process of continuous improvement and a comprehensive environmental planning at the regional level, within a framework of intersectoral and inter-institutional management which involves the three levels of government, technical and educational institutions, organized civil population and the different uses of water users; resulting in a strategic plan operational, effective, measurable and perfectible so it was established that its update must be performed every 4 years (Vázquez 2015).

The master Plan is based on five pillars: 1) a differential environmental 2) identification and consensus of priority problems, 3) the establishment of strategic objectives, goals and general actions, 4) identification, consensus and prioritization of specific for environmental recovery projects and 5) the establishment of a range of indicators; the latter very important since it serves as element of verification, monitoring and evaluation of the conservation and environmental recovery of the PY (IMTA 2012). An indicator is a tool that provides quantitative information regarding the performance if same (Armijo 2009) that is characterized by being measurable; precise; consistent; and sensitive (OIE *et al.*).

In 2013 was raised a set of indicators (indicators bacteria) for the master Plan, which measure the effectiveness of the activities carried out over time and allow to show their progress, identify achievements and weaknesses and proposing corrective actions to optimize the desired results. Moreover, these indicators reflect ecological, social and economic aspects of the PY.

This work is based on the update of the range of indicators of the master Plan in the field of water for the protection, conservation and recovery environmental of the Yucatan peninsula in 2013.

## **MATERIALS AND METHODS**

To the range of indicators of the Master Plan update was held a workshop in which a college group composed of 30 people participated representatives of governmental and non-governmental organizations, civil society organizations and educational institutions in the three States that make up the Yucatan peninsula. The assistants worked by working groups which were formed taking as criteria your area of work, skills, experience or expertise in the priority problem to analyze.

The workshop was held in 4 stages, which were:

1. Review, consensus and validation, or redefinition of the content of the methodological sheets.

Each member group shall appoint a chair and a secretary. At this stage the methodological sheets will be provided so that they can be reviewed, consensuses and validated.

Each section of the methodological sheets may undergo changes minor or entirely according to the criterion of the collegiate group (Figure 2).

2. Update, consensus and validation of the status of the flags.

In order to have a solid and up-to-date baseline the current state of the indicators will be put under consensus for validation or modification as the case may be.

3. Definition of goals in the short, medium and long term indicators.

In order to measure and verify the impact of actions and specific projects, each Member group must define goals attainable in the short (1 to 2 years), medium (3 to 4 years) and long (over 5



years) term, as well as indicators of state semaphore type. For this stage scheduled actions that impact on each priority problem to define achievable goals should be taken into account.



**Figure 2.** Review of methodological sheets.

4. Responsible for monitoring, generation and update assignment data base for the production of indicators.

Each member group shall designate the person responsible for the monitoring of indicators, those responsible for the generation, obtaining information and updating of the data base for the calculation of the indicators. Shall be also determined the times related to each activity (Figure 3).



**Figure 3.** Asingacion of persons in charge of the information.

## **RESULTS AND DISCUSSION**

As part of the review and update of the indicators of the master Plan were reviewed methodological sheets of the 14 indicators that they had proposed 2013 as well as their status and relevance for the measurement of environmental conservation of the Yucatan peninsula. After reviewing indicators, 5 has remained, modifications were made to 7 and 2 were eliminated.



Priority problem	Final indicators
Reduction of the quantity and quality of water	Degree of pressure.
	Residual municipal WWTP treated water.
	Index of water quality in groundwater sources of supply for human consumption.
	Percentage of expenditure chlorine in potable water supply systems.
	Percentage of solid waste in appropriate final disposal sites.
Deterioration of natural resources and disordered urban growth	Urban development programs.
	Ecological Ordinance programs.
	Index of the impact of land use change.
	Degree of social backwardness.
Social and economic backwardness and poverty and deterioration of public health and welfare	Population with access to waste water catchment systems.
	Population with access to public health services.
	Percentage of schools served by an alternative system of disinfection of water in marginalized communities who do not have drinking water systems.
	Number of municipalities with established recycling programs.
	Percentage of social participation in the Watershed Council.
Insufficient legislation, reduced awareness and social participation and low environmental culture and inadequacies in the monitoring and socio-environmental information	Number of stations for monitoring hydroambiental in operation.
	Number of installed water areas (ECA) and operation.
	Number of instructors in six steps of health and sanitation.
	Assurance of public goods index.
Extreme events and climate change	Assurance of public goods index.
	Number of strategies that foster for mitigation and adaptation to climate change.

Additionally added 5 indicators, finally leaving 19 (table 1), of which: 5 correspond to the priority problem reducing the quantity and quality of water, 3 to the deterioration of natural resources and urban sprawl, 4 social and economic backwardness and poverty and deterioration of health and well-being public, 5-insufficient legislation, reduced awareness and social participation and low environmental culture and inadequacies in the monitoring and socio-environmental and extreme 2 information and climate change; all these priority issues identified in the environmental diagnosis during the elaboration of the master Plan.

## CONCLUSIONS

There is a battery of indicators solid and up-to-date (19 indicators) for measuring the effectiveness of the activities carried out in the PY.

Through selected indicators of can measure and analyse the conservation and environmental recovery of the region.

It is essential to have a battery of indicators allowing you to identify achievements and weaknesses by the actions carried out in the region by the different organizations of

government and civilian population organized technical and education; allowing propose corrective actions to optimize the desired results.

## REFERENCES

- i. Armijo, M. 2009 *Manual de planeación estratégica e indicadores de desempeño en el sector público*, ILPES/CEPAL.
- ii. Comisión Nacional del Agua (CONAGUA) 2012. *Programa Hídrico Regional Visión 2030, Región Hidrológico Administrativa XII Península de Yucatán*, Comisión Nacional del Agua, ISBN: 978-607-7908-82-1.
- iii. Espinosa B. M. 2011. *Plan Rector en materia de agua para la protección, conservación y recuperación ambiental de la Península de Yucatán*. Diagnóstico e identificación de retos y problemas, estrategias, objetivos, acciones y proyectos prioritarios, Informe final, Instituto Mexicano de Tecnología de Agua. Jiutepec, Morelos, México.
- iv. Instituto Mexicano de Tecnología de Agua (IMTA) 2012. *Guía metodológica para desarrollar planes estratégicos IMTA-FGRA*.
- v. Vázquez V.S. 2015. *Coordinación técnica del Programa para la recuperación ambiental de la península de Yucatán*. Informe parcial. Instituto Mexicano de Tecnología de Agua. Jiutepec, Morelos, México.
- vi. Organización de los Estados Iberoamericanos (OEI), Instituto para el Desarrollo y la Innovación Educativa (IDIE) *Monitoreo e indicadores*, texto de apoyo al proceso de construcción de un sistema regional de indicadores sobre atención y educación ambiental, OEI-IDIE.[www.oei.es/historico/idie/mONITOREOEINDICADORES.pdf](http://www.oei.es/historico/idie/mONITOREOEINDICADORES.pdf).

# Successful Patrind Hydro Power Project while minimizing the Environmental and Social Impacts

Ref # S2SMALL-33934

Cha kee uk<sup>1\*</sup>, Syed Atif Ali Shah<sup>2</sup>, Park no hyuk<sup>3</sup>, Song chi ho<sup>4</sup>

<sup>1</sup> President, Star Hydro Power Limited Co., 534 Margalla Rd, Islamabad, Pakistan

<sup>2</sup> Manager Civil, Star Hydro Power Limited Co., 534 Margalla Rd, Islamabad, Pakistan

<sup>3</sup> General Manager, K-water, 534 Margalla Rd, Islamabad, Pakistan

<sup>4</sup> Chief Officer, K-water, 534 Margalla Rd, Islamabad, Pakistan

\* Corresponding Author: [cku2001@gmail.com](mailto:cku2001@gmail.com)

**Abstract:** Patrind Hydropower Project is run-of-river project located on the boundary of Khyber-Pakhtunkhwa of Pakistan. The Project has the total installed capacity of 150 MW. The purpose of the Project is to provide zero-emissions renewable electricity to the grid and also provide local and global environmental benefits as well as strong local socioeconomic benefits. The construction was started in early 2013 is completed in March 2017 and is now in its commissioning stage for normal activity.

The environmental footprint of the Project has had a slight impact on the environment in comparison with the other projects, because the government and private sector actively cooperated and reduced the environmental impact by minimizing the size of the Project.

The Patrind Hydropower project is the first Independent Power Producers (IPP) under Pakistan's Power Policy 2002 and sponsors' first endeavour in Pakistan's hydro power sector. During the Project's implementation, various challenges were faced and the solutions/mitigations were provided accordingly. There are few challenges faced and can be dealt wisely for the development of next projects in hydropower sector in Pakistan. Keeping in view the issues faced during the construction of Patrind Hydro Power Project, relevant management measures were adopted for their mitigation. However, the challenges faced during the development can be treated as the roadmap for the development of other projects in the future. Proper plans and strategies suggested against the challenges faced can be developed at very early stage of the Project's development in order to successfully implement the project with reduced development time and enhanced efficiency and quality.

**Keywords:** Environment, Hydropower, Impact, Management, Social.

## INTRODUCTION

Patrind Hydropower Project (the "Project") is run-of-river project located on the boundary of Khyber-Pakhtunkhwa (KP Province of Pakistan). The construction was started in early 2013 is completed in March 2017 and is now in its commissioning stage for normal activity.

The Project has the total installed capacity of 150 MW. The purpose of the Project is to provide zero-emissions renewable electricity to the grid and also provide local and global environmental benefits as well as strong local socioeconomic benefits. The Project is sponsored by K-Water which is a Government owned Corporation of South Korea. The Project is being financed by multilaterals like IFC, ADB, IDB and KEXIM. The environmental footprint of the Project has had a slight impact on the environment in comparison with the other projects, because the government and private sector actively cooperated and reduced the environmental impact by minimizing the size of the Project.

The total number of residents that were involved in the resettlement for the Project was also not that high. Only 26 houses including 146 residents were relocated during the Project construction. The total land acquired for the Project is 100 Acres (404,686m<sup>2</sup>), out of which 90% of the land was to be submerged in the reservoir area which is about 5km in length

running through a narrow gorge. This is also one of the key benefits of the location that there is no dependency of the locals in any way.

The Environmental Management Plan (EMP) and Resettlement Plan have been prepared considering the guidelines established by the Asian Development Bank(ADB)/World Bank(WB) and adjoining institutions, especially in accordance with International Finance Corporation(IFC) guidelines on Environment Health Safety(EHS) 2007 and Performance Standards 2006.

The Environmental Impact Assessment(EIA) was submitted in July 2008 to relevant Environmental Protection Agency(EPA-KP) for approval. The EPA-KP approved the EIA report in April 2011. The measures identified and determined in the EMP have to be implemented by all the contractors.

Describe the background of the work and its aims. The formatting provided automatically leaves space between the paragraphs, so the use of an empty line-return is not needed.

**Table 1.** Dam Location and specifications

Feature/structure	Type/size	
Project name/location	Patrind Hydropower Project Pakistan	
River	Kunhar river Khyber-Pakhtunkhwa (KP) province	
Dam/Weir	Type	Concrete Gravity Dam
	Storage	6.14*10 <sup>6</sup> m <sup>3</sup>
	FWL	EL767 m
	NWL	EL765 m
	LWL	EL760 m
Sandtrap	Type	Settlement Pool (Rearranged sand-trap)
	ze	B80.0m×H20.0m× L311.0m×1ea
	Discharge	153.66 m <sup>3</sup> /sec
Spillway (Gates & Size)	Overflow gates	B12.0m×H10.4m×2ea (Radial)
	Underflow gates	B7.0m×H11.6m×2ea (Radial)
	Flap gates	B5.0m×H2.8m×2ea
	Min. flow	2.2 m <sup>3</sup> /sec
Tunnel & Bypass	Headrace tunnel	L2.2 Km, Dia. 7m
	Vertical tunnel	Dia. 8.5m
	Horizontal tunnel	Dia. 8.5m
	Bypass tunnel	L175m x D7.5m
Hydropower plant	Installed capacity	150MW
	Annual Average Energy	642GWh
	Turbines	Vertical Francis (3ea)
Cost	Total Cost	436 million USD
	Compensation	7 million USD

### Location of the project

The Project is located in northern region of Pakistan in the province of Khyber Pakhtunkhwa.

The dam (weir) site is located near Patrind village, which is a small village on the left bank of Kunhar river in district Muzaffarabad. Project's weir site is located about 13.4 Km upstream of the confluence of Kunhar with Jhelum river and can be accessed by Boi Road on right side of Kunhar river.

The powerhouse site is located on the right bank and downstream limb of Jhelum river at Lower Chattar District Muzaffarabad which is about 9.0 Km upstream of the confluence of Jhelum with Kunhar river. A new bridge is constructed across the Jhelum river to access the right bank for transportation of heavy machinery and equipment to the construction area of the powerhouse.





**Figure 1.** Patrind Project layout

### **Environmental and Social Impact and Management Measures**

The impacts on physical, biological and socio-economic environment are described in the following.

In physical environment, there are four groups such as water resources, water quality, air and noises. Environmental impacts and management measures have been shown. In the aspect of water resources, firstly, during the construction phase, it was expected that river water quality would deteriorate. This was due to the increase of suspended solids and turbidity. Secondly during operation phase, Kunhar river flow will undergo cyclical changes particularly affecting the downstream flow of the weir. Then there are the following measures. During the construction phase, change in water quality was temporary and over a short distance of the reach which is neither being used for agricultural irrigation nor as a supply of drinking water. Contractors took extreme care to minimize the quantities of soil that entered the river. During operation phase, minimum 2.2 m<sup>3</sup>/sec of water from the head pond will be released as ecological flow throughout the year. This flow is in addition to substantial flow of the streams in the downstream area which joins Kunhar river thus providing enough flow as a management measure for aquatic flora and fauna in the reach downstream reach of the weir.

In the aspect of water quality, the sediment load in terms of watershed erosion/ silt runoff may affect the life of the head pond and downstream of weir if allowed at excessive filling rate. As a management measures, the weir design provides a control of sediment load by sluicing through the under sluice gates during high flows. A bypass tunnel has been provided to flush the sediment in the upstream reach of the reservoir and protect the turbine from the damage by sediments. Modified sand-trap is designed to trap the particles greater than 0.2 mm. Also, biannual water quality monitoring has been conducted throughout the construction period and

will be done in the operations phase as well in accordance with the National Environment Quality Standards (NEQS). In air quality aspects, particulate matter emission during construction activities include earthworks (dirt or debris pushing and grading), exposed surfaces, exposed storage piles, vehicle movement on unpaved land, combustion of liquid fuel in equipment and vehicles. As a management measure, during the construction period, all the contractors took every necessary precaution to limit pollution from dust and any wind-blown materials during the construction period, including water sprinkling on regular basis. Air quality and meteorological monitoring programs to check on whether emissions and ambient air pollutant concentrations comply with National Environmental Quality Standards (NEQS) and ADB Guidelines were developed and implemented. Materials piled in the field were veiled with dust-proof covers. The spoil material was transported carefully considering the capacity of the trucks. All cars are run under specified speed limit.

In the aspect of noise environment during the construction period, there were enhanced noise levels due to increased traffic, as well as working of construction machinery and equipment during the day. Noise annoyance can also interfere with sleep during the night. These Effects would have been caused due to drill-blasting during the excavation of headrace tunnel, pressure shaft and caverns. As a management measures, the contractors selected the equipment causing low noise and worked regular check and maintenance of the machinery and equipment. Also, construction activities usually carried out in day time. In the construction area most vehicles speed limits were reduced.

In biological environment there are flora and fisheries. Environmental impacts and management measures have been shown. In the aspect of flora, land acquisition for the Project resulted in loss of habitats for flora. Transportation of equipment/machinery for the project might have caused damages to the crops and vegetation. Flora might have been affected by trespassing of construction crews. The cutting of trees during the project implementation will affect the ecological balance of the area and increased the soil erosion and landslide potential. As a management measures, annual tree plantation campaigns have been conducted to compensate the impact done due to the tree cutting during the construction period. Approximately 6,000 trees have been planted in 4 years of construction within the Project area and at other locations near the Project. Engineering Procurement & Construction (EPC) Contractor and its sub-contractors took all efforts to minimize the removal of trees. For any tree cutting necessary for the construction prior approval was mandatory from the Engineer or Client. It was an obligation on the contractors to count of the total number of trees removed and will plant double the number of trees in the replanting efforts. In order to restore the ecological balance of the area, the Operation and Management Contractor should plant as many trees as will be cut down during the project implementation. In fisheries aspects, the migratory fishes don't exist in the Project area. There is no dependency on river fish in domestic or commercial aspects. The creation of head-pond and weir will result in the development of fish culture habitat and endanger aquatic life downstream. As a management measure, the propagations of seasonal fish species were needed with the help of fishery Department in the head-pond. It was also essential to release downstream ecological flow.

In socio-economic environment there are house/land acquisition and economy. Environment impacts and management measures have been shown. In the aspect of house and land acquisition, approximately 100 acres of land including 26 houses were acquired for the development of Project both on powerhouse and reservoir area. The majority of the land (80%) falls in the reservoir area. The houses are occupied by 146 persons who constitute the population which is subject to displacement. As a management measure, during the land acquisition process the various scenarios were properly discussed such as land compensation, business rights periods and relocation expenses. All the land/house owners opted for cash



compensation which was paid to the them through government. No resettlement issues were raised as the cash compensation was opted by the house owners instead of resettlement option. In economy aspects project has already shown its positive impacts on the economy of the area during construction phase. About 2,000 locals were employed (skilled and unskilled) during the construction phase which helped not only in enhancement of their livelihood but also in maintaining good relations with the communities though they always demanded for more. Several business avenues were tapped by the locals in the Project area. More than 50 restaurants and shops have been established in the project's vicinity by the locals helping in enhancing the local economy. Local markets were benefited due to the increased demand for consumer goods, materials, fuel and other necessary items.

### Challenges faced and suggested solutions

The Patrind Hydropower project is the first Independent Power Producers (IPP) under Pakistan's Power Policy 2002 and sponsors' first endeavour in Pakistan's hydro power sector. During the Project's implementation various challenges were faced and the solutions/mitigations were provided accordingly. Following are few challenges faced and can be dealt wisely for the development of next projects in hydropower sector in Pakistan.

**Table 2.** Challenges and solutions

Features	Challenges	Solutions
Stakeholders' Engagement/Community Consultations	Coordination with local communities, land owners and government agencies	Coordination/consultation with the affected communities at every stage of Project development to avoid unnecessary conflicts along with the close coordination with the local administration. Development of proper consultation/stakeholders' engagement plan during the development of the Project.
Baseline studies	Proper baseline studies for all basic environmental and social features to avoid false claims and conflicts	Detailed baseline studies for fish, vegetation, landscape, 100% census of affected land/house owners, condition of access roads, public utility facilities and pre-blast surveys.
Human Resources Policy	Awareness of workers for their rights	Provision of workers' rights in appointment letters with translation in local language to avoid unnecessary hustle and stoppage of works.
Working relationships	Cross-Cultural issues/communication gap	Capable local coordinators should be engaged for regular communication which will help in minimizing gaps and issues.
Working conditions & Terms of employment	Awareness of workers regarding wages, benefits, working hours, overtime arrangement and its compensation	Regular consultation, training sessions, clarity in appointment letter regarding basic pay and overtime compensation
Non-discrimination & Equal opportunity	High expectations of locals on employment and sub-contracting works	Transparency in hiring procedure, proper disclosure of opportunities
Grievance Mechanism	Workers' own conflicts on grievance committee, composition of Grievance Redress Committee (GRC), workers' awareness for proper procedure of launch grievance/complaint	Three tier grievance mechanism (Sub-contractor, EPC Contractor, Sponsor), regular consultation of workers, delegation of power to choose workers' representatives in GRC, regular meetings of GRC, proper documentation

## **Reviews and Conclusions**

The management measures adopted during the construction phase helped in minimizing the impacts whether they were environmental or social. Being the first project, it took some time to understand the severity of the issues at initial stage but after very short time the team (Sponsors, Contractors and Supervisors) dealt with the issues efficiently.

Keeping in view the issues faced during the construction of Patrind Hydro Power Project, relevant management measures were adopted for their mitigation. However, the challenges faced during the development can be treated as the roadmap for the development of other projects in the future. Proper plans and strategies suggested against the challenges faced in the above table can be developed at very early stage of the Project's development in order to successfully implement the project with reduced development time and enhanced efficiency and quality.

## **References**

- Asian, D. B. (2014, June 30). Pakistan: Patrind Hydropower Project. Retrieved from <https://www.adb.org>: <https://www.adb.org/projects/44914-014/main#project-documents>
- K-water and Daewoo, E. C. (April 2015). Patrind HPP- Detailed Design. Islamabad.
- K-water and Daewoo, E. C. (February 2011). Health Safety & Environmental (HSE) Plan. Islamabad: Asian Development Bank; International Finance Corporation.
- International, F. C. (2011, September 8). IFC Project Information Portal. Retrieved from <https://ifc.org>: <https://disclosures.ifc.org/#/projectDetail/ESRS/26229>
- K-water and Star Hydro Power. (2010). Fish Fauna Study. Islamabad: International Finance Corporation.
- K-water and Star Hydro Power.(2013, December 30). Environmental Management. Retrieved from <http://www.patrind.com>: <http://www.patrind.com/environmental-management.php>
- K-water and Star Hydro Power.(2013~2016). Annual Environmental & Social Monitoring Report- Patrind Hydropower Project. Islamabad: Asian Development Bank; International Finance Corporation.
- K-water and Star Hydro Power.(2013~2017). Quarterly Environmental & Social Monitoring Reports- Patrind Hydropower Project. Islamabad: Asian Development Bank; International Finance Corporation.
- K-water and Star Hydro Power.(March 2017). Environmental Management Plan (EMP)- Operation Phase-Patrind Hydropower Project. Islamabad: Asian Development Bank; International Finance Corporation.

# Optimal Location of Stormwater Tanks in Real Networks at Colombian Cities: Bogotá and Medellín.

Ref # S2SMALL-2017

C. A. Salcedo<sup>\*</sup>, K. Bustos<sup>2</sup>, G. J. Rincón<sup>3</sup>, J. Saldarriaga<sup>4</sup>

<sup>1</sup> Universidad de los Andes, Cra 1 No. 18A-12, Bogotá, Colombia.

<sup>2</sup> Universidad de los Andes, Cra 1 No. 18A-12, Bogotá, Colombia.

<sup>3</sup> Universidad de los Andes, Cra 1 No. 18A-12, Bogotá, Colombia.

<sup>4</sup> Universidad de los Andes, Cra 1 No. 18A-12, Bogotá, Colombia.

\* Presenting Author: ca.salcedo959@uniandes.edu.co

**Keywords:** Climate Change, Optimal location, Stormwater tanks, Urban Drainage, Urban Flooding

## INTRODUCTION / MAIN METHODS

Urban flooding has become one of the major concerns related to the water management inside the cities because the different damages they can cause to the human being such as diseases, economical losses, and a low life-quality. These floods are mainly caused by the increasing flowrates that the urban drainage systems must deal with, even they are characterized by an widely-known lack of hydraulic capacity as a consequence of undersized networks, the increasing and not-controlled urbanization processes, and also the changing environmental conditions that has led to the Climate Change, whose major effects are related to the increase of the rainfall (Butler, 2004).

In Colombia, the urban flooding has become an increasing concern to the water utilities and governmental entities because the enormous amount of money that must be assigned to solve flooding problems such as infrastructure renewal, and also to reduce the vulnerability of the urban areas, that in many cases are located near rivers and other water bodies (Bustos, 2017). These exposure are maximized when Climate Change effects are taken into account into the equation.

In response to the previous situation, the Sustainable Urban Drainage Systems, also known as SUDS, are becoming an effective way to control the mentioned adverse effects, besides the improvement of water quality, and also giving the drainage systems the possibility to gain more capacity in areas where they are completely out of it. Some examples of SUDS are green roofs, pervious concretes, infiltration trenches and different kinds of detention systems such as stormwater tanks, which are the focus of this research.

In order to analyze the response of the flooding volumes inside urban stormwater networks, there were selected 5 study cases in two of the main Colombian cities: Three located in Bogotá, and two located in Medellín. The designated areas were chosen based upon the operational knowledge of the rainwater systems, including aspects such the occurrence of urban flooding and their vulnerability due to the low slopes found in the studied areas.

Finally, among the existing alternatives for minimizing the urban floods, the location of stormwater tanks was chosen in order to analyze the feasibility of implementing some of them

into the selected study cases. To accomplish this objective, a methodology proposed within the research project “*Urban Drainage and Climate Change: Towards the Sewerage Systems of the Future*” developed by the Water Supply and Sewers Systems Research Center – CIACUA was applied. This methodology is composed by two main aspects: The development of some rainfall scenarios that incorporate the influence of the Climate Change over it; and the application of two procedures that pursues the optimal location of stormwater tanks in an urban context (CIACUA, 2014).

## MAIN RESULTS AND CONCLUSIONS

Once the potential locations for the stormwater tanks have been selected considering those sites where the biggest floods have occurred, and also considering the available space for implementing these detention systems, the methodology was applied. After the rainfall scenarios under Climate Change has been obtained, and the corresponding runoff is determined, the two mentioned procedures were applied in the 5 selected study cases. The obtained results are shown in Table 1.

**Table 1.** Results obtained for the minimization of urban floods within the study cases

Study Case	Flooding Volume Under Climate Change [m <sup>3</sup> ]	Flooding Reduction -Best Scenario [%]		Storage Volume – Best Scenario [m <sup>3</sup> ]
		Hydraulic Control	Non-Hydraulic Control	
Salazar Gómez	30,223.33	75.43%	45.19%	20,823
Cedro Narvárez	20,533.39	75.82%	48.78%	15,568
Las Palmas	14,952.51	72.66%	34.63%	10,865
Laureles	861.09	82.72%	44.16%	718
La Esmeralda	30,793	43.7%	84%	71,575
La Ayurá	207.74	98.2%	99.28%	3,599

As shown before, as the flooding reduction rates are above the 70% in all the study cases, the feasibility of implementing these structures within urban drainage networks was proven for Colombian study cases. As part of the applied methodology, it is important to consider the effects of Climate Change in the estimation of the rainfall scenarios in order to prepare the urban systems to attenuate these adverse consequences such as floods. Related to the operation of the stormwater tanks, it was obtained that the use of a hydraulic control within the structures allows a better operation of the system rather than the ones without control.

## REFERENCES

- Bustos, K. 2017. *Prueba de la Metodología de la Localización de Tanques de Tormenta en Sectores de la Ciudad de Bogotá y Medellín*. Universidad de los Andes.
- Butler, D. & Davies, J. 2004. *Urban Drainage*. London, Spon Press – Taylor & Francis Group.
- CIACUA, 2014. *Drenaje Urbano y Cambio Climático: Hacia los Sistemas de Alcantarillado del Futuro – Fase I*. Universidad de los Andes.
- Rincón, G. 2016. *Prueba de la Metodología de Localización de Tanques de Tormenta en Diferentes Sectores de las Ciudades de Bogotá y Medellín*. Universidad de los Andes.

# A Study on Nanoparticle-embedded Device for Nanoscale Filtration and Molecular Separation

Ref # S2SMALL-901714

J. S. Yoon<sup>1,2\*</sup>, N. T. Phuong<sup>1,2</sup>, J. H. Kim<sup>1,2</sup>, K. Kim<sup>1</sup>, D. S. Choi<sup>1,2</sup>  
and Y. E. Yoo<sup>1,2</sup>

<sup>1</sup> Dept. Nano Manufacturing Technology, Korea Institute of Machinery & Materials (KIMM), 156 Gajeongbuk-Ro, Yuseong-Gu, Daejeon 34103, KOREA

<sup>2</sup> Dep. Nano Mechatronics, Korea University of Science and Technology (UST), 217 Gajeong-ro, Yuseong-gu, Daejeon 34113, KOREA

\* Presenting Author: jaesyoony@kimm.re.kr

**Keywords:** Filtration, Molecular Separation, Nanoparticle, Nanofabrication, Sand filter

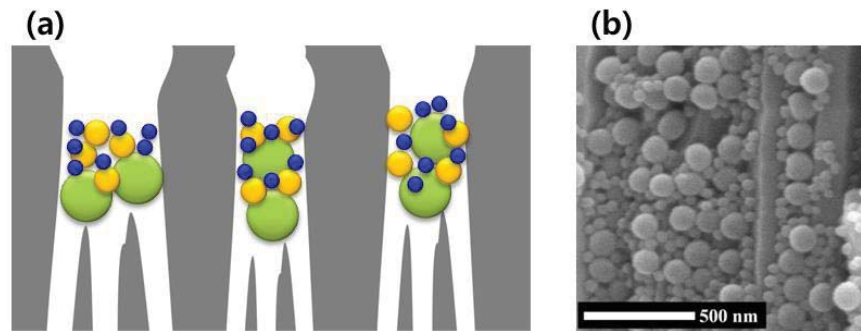
## INTRODUCTION / MAIN METHODS

The sand bed in nature is a natural granular material consisting of fined rocks and mineral particles. And it has been used as the sand bed filters for water purification for a long time (Vohla 2011, Nassar 2013). In principle, macroporous space between sand particles may be used as filtering passage to separate large particulate solids from water. The filtration efficiency of sand filter depends on the size and geometry of the filter media that consist in the sand filter, which are usually quart sand, silica sand, fly ash, furnace slag and so on. If the size of sand is smaller, the finer filtration could be expected. However, many biological substances (e.g. algae, bacteria, viruses) and soluble chemical contaminants (e.g. arsenic, lead, and fluoride) cannot be filtered by the conventional filters due to their complex chemistry and extremely small sizes. Recently, advances in membrane science and technology have basically met the demands for water purification and diverse applications in biology, medical science, and nanoelectronics. In this study, inspired by the simple but highly efficient sand filter, we present a principle for filtration of nanoscale dimension, which consists of nanoparticles and anodic aluminum oxide (AAO) template. This AAO template has asymmetric pore structures where the sizes on one side are bigger (~200 nm) than those on the other side (~100 nm). This structure enables polystyrene nanoparticles with various sizes of 150 nm, 60 nm, and 24 nm to be confined, or embedded within the pores of the AAO template in sequence from biggest nanoparticles to smallest one. The nanoparticles in this study play an important role as the filtration or separation media in nanoscale. The cavities between nanoparticles build up efficient and small pathway networks, which are much smaller than the nanoparticle itself. Therefore, the cavities between the particles can be regarded as effective pores for filtration. Moreover, the nanoparticles have been functionalized, or electrically charged, with arginine/phenylalanine (RF) peptide group. In this way, filtration performance for charged particles or molecules, such as methyl blue, has been enhanced. Or in another word, the filtration for charged substances, which may be smaller than the cavities, is feasible. Accordingly, this study is expected to provide a new principle for fabrication of nano voids, or nanopores for filtration in nanoscale dimension.

## MAIN RESULTS AND CONCLUSIONS

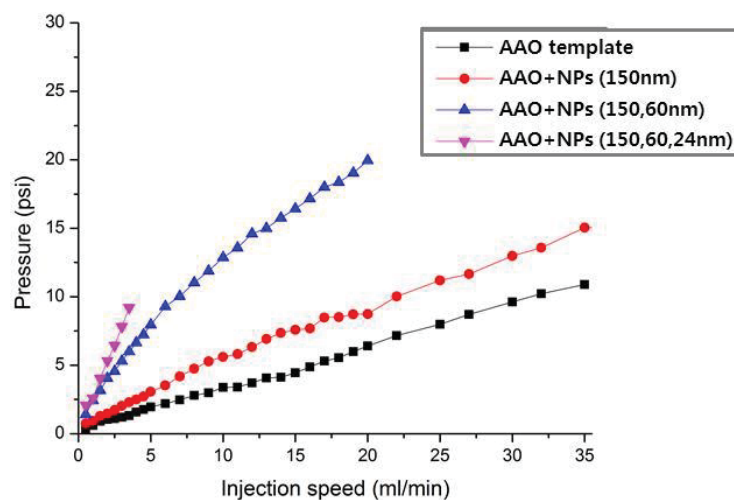
This study provides a new principle for fabrication of nano cavities, or voids using nanoparticles, in the similar way of sand bed. Polystyrene nanoparticles with various sizes of

150, 60 and 24 nm have been embedded in the pores of the anodic aluminum oxide (AAO) template, which has bigger pores on top and smaller divided pores on bottom. So voids between the nanoparticles could be made in nano scale. These voids can be considered as effective pores for filtration or separation (Yoon 2015). By this method, a lot of nano voids could be fabricated on a large area (diameter of template : 25 mm) with a simple process as seen in Figure 1, which may be an important advantage for mass production in the future (Phuong 2016).



**Figure 1.** Schematic of the nanoparticles embedded in AAO template (a) and SEM image of cross section of the template with the nanoparticles (b).

Since overall size of the voids is expected to be much smaller than that of the nanoparticles, this principle is expected to have effective separation size of a few nanometers. And as long as the sizes of the nanoparticles are uniform, sizes of the voids could be quite uniform also. The particles are pretreated with carboxyl group, to be charged negatively. And we also treated the some of them with arginine/phenylalanine peptide ((RF)<sub>4</sub>), so that the particles could be electrically charged positively (Liberto 2013, Decandio 2015). By this way, the filtration device in this study could have separation characteristics of electric charge as well as size. In order to evaluate embedment of the nanoparticles, water flow was applied across the device and pressure drops were measured as seen in Figure 2. The pressure drops became higher as smaller nanoparticles were embedded, which means that smaller voids were made inside.

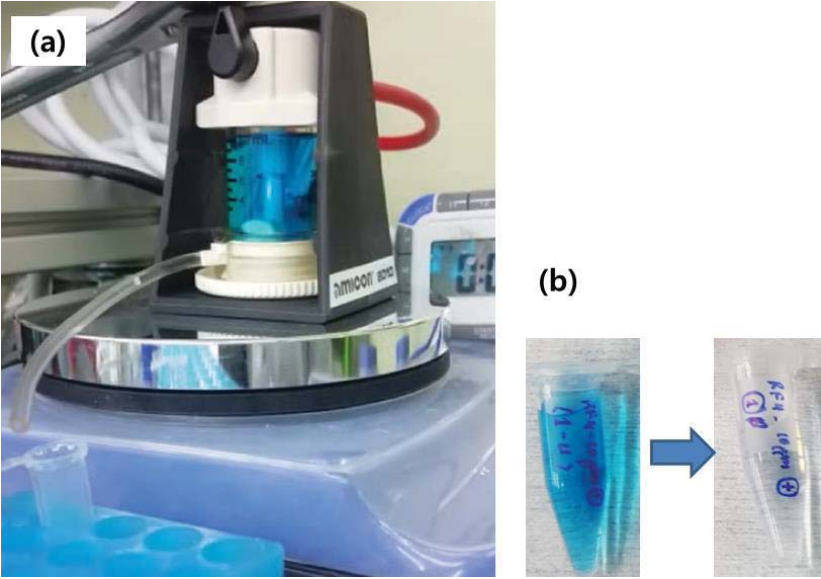


**Figure 2.** Pressure drops across the nanoparticle (NP)-embedded AAO template for various flow rates.

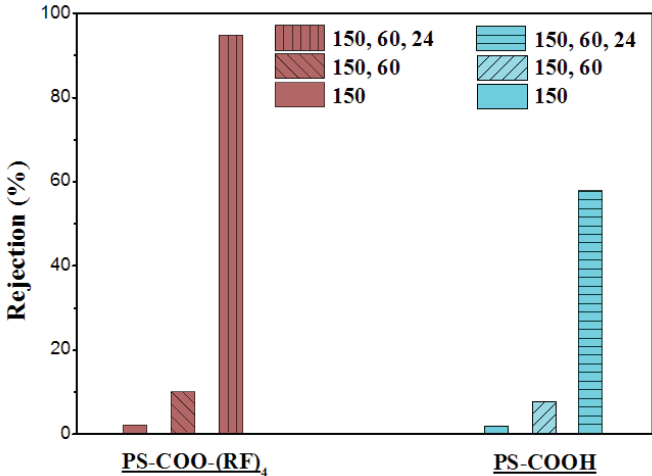
And separation experiments were also performed with electrically charged dye molecule, which is methylene blue (Figure 3). Experimental results have also shown that higher



separation rate was achieved as smaller nanoparticles were used. And the effect of the surface charge on separation performance was also measured as seen in Figure 4.



**Figure 3.** Separation experiment for methylene blue solution using the nanoparticle (NP)-embedded AAO template with stirred cell (a) and comparison of the solution before and after the experiments (b).



**Figure 4.** Results of separation experiments for methylene blue solution with negatively charged particles (PS-COOH) and positively charged particles (PS-COO-(RF)<sub>4</sub>).

Positively charged nanoparticles have produced higher separation, or rejection, for positively charged methylene blue molecules. On the other hand, negatively charged nanoparticles have produced lower separation. These results show that filtration device in this study has both characteristics of size separation and charge separation. Consequently, this study is expected to provide a new principle for filtration or separation technology in nanoscale, which is also feasible for molecules, as well as the fabrication technology for nano voids or nanopores. And further study is under investigation by using smaller nanoparticles. By this way, the voids between the particles can be more smaller and it is expected that this principle can be applied for separation of smaller molecules.

## REFERENCES

- Decandio C. C., Silva, Hamley I. W., Castelletto V., Liberato M. S., Oliveira V. X. Jr., Oliveira C. L. P., Alves W. A. 2015 Self-Assembly of a Designed Alternating Arginine /Phenylalanine Oligopeptide. *Langmuir* **31**, 4513–4523.
- Liberato M. S., Kogikoski S. Jr., Silva E. R., Neto M. D. C., Scott L. P. B., Silva R. H., Oliveira V. X. Jr., Ando R. A., Alves W. A. 2013 Self-Assembly of Arg–Phe Nanostructures via the Solid–Vapor Phase Method. *J. Phys. Chem.* **117** 733-740.
- Nassar A. M. & Hajjaj K. 2013 Purification of stormwater using sand filter. *J. Water Res. Protect.*, **5**, 1007-1012.
- Phuong N.T., Andisetiawan A., Lam D.V., Kim J.H., Choi D.S., Whang K.H., Nham J., Lee Y.J., Yoo Y.E. & Yoon J.S. 2016 Nano sand filter with functionalized nanoparticles embedded in anodic aluminum oxide templates. *Sci. Rep.*, 37673.
- Vohla C., Kõiv M., Bavor H. J., Chazarenc F. & Mander Ü. 2011 Filter materials for phosphorus removal from wastewater in treatment wetlands—A review. *Ecological Engineering*, **39**, 70-89.
- Yoon J.S., Yoo Y.E., Kim J. H. & Choi D.S. 2015 Method for manufacturing nanoholes and filter manufactured by the same. *Korea Patent 1605632, European Patent 15153186.0, Singapore Patent 10201500789X.*

## ACKNOWLEDGEMENTS

This research was supported by the Pioneer Research Center Program through the NRF of Korea funded by the Ministry of Science, ICT and Future Planning (grant number: NRF-2012-0009574) and the Institute Project (NK204B).

# Hygienisation of human urine effluent collected through a new diverting sanitary system

Ref # S2SMALL-86788

M.Kanoun-Boulé<sup>1</sup>, A. Azevedo<sup>1\*</sup>, M.I. Santos<sup>1</sup>, J. Almeida<sup>1,2</sup>, C. Pimentel-Rodrigues<sup>3</sup>, A.Silva-Afonso<sup>3,4</sup>, A. Tadeu<sup>1,5</sup>

<sup>1</sup>ITeCons - Institute for Research and Technological Development in Construction, Energy, Environment and Sustainability, Rua Pedro Hispano, 3030-289 Coimbra, Portugal

<sup>2</sup> Chemistry Centre, Department of Chemistry, University of Coimbra, 3004-535 Coimbra, Portugal

<sup>3</sup>ANQIP – Portuguese Association for Quality in Building Installations, Campus Universitário de Santiago, 3810-193 Aveiro, Portugal

<sup>4</sup>RISCO - Department of Civil Engineering, University of Aveiro, Campus Universitário de Santiago, 3810-193 Aveiro, Portugal

<sup>5</sup>ADAI - AETA, Department of Civil Engineering, University of Coimbra, Pólo II, Rua Luís Reis Santos, 3030-788 Coimbra, Portugal

\* Presenting Author: ana.azevedo@itecons.uc.pt

**Keywords:** faecal cross-contamination, urine nutrients, urine source separation, urine storage

## INTRODUCTION

Human urine is the most important source of nitrogen (N), phosphorus (P) and potassium (K) in household wastewater. With a typical N/P/K nutrient ratio of 18:2:5, human excreta constitutes a valuable potential fertilizer for agriculture but, also, an important source of organic pollution of domestic wastewater. (Vinnerås *et al.* 2006). Based on these considerations, the first studies to remove and recycle urine nutrients initiated in the early 1990s (Kirchmann & Pettersson 1994). Since then, urine separation and recycling appears as a promising solution for a more sustainable wastewater management as well as an early answer to the increasing scarcity of drinking water and mineral resources (e.g. phosphorus) depletion.

The recent development of urine-diverting sanitary systems allows the collection of urine with a small quantity of water for subsequent application in arable land (Kvarnström, *et al.* 2006). Some experiences already exist of local urine recovery in Europe (e.g. Sweden and the Netherlands) (Lienert & Larsen 2009; Münch *et al.* 2011). However, if urine contains only very few pathogens under a temperate climate, faecal cross-contamination constitutes a real risk of environmental transmission. Storage represents a possible way for urine hygienisation thus reducing the potential health risks from faecal pathogens. Among the main factors that influence the urine hygienisation process, storage time, total nitrogen, pH and temperature are the most

relevant (Höglund 2001).

An innovative urine-diverting sanitation system is currently under development by a Portuguese consortium. More attractive, from a commercial perspective, this system also allows to solve some issues inherent to the traditional systems such as mineral salts crystallization in the urine bowl. However, new challenges emerge from this system such as a higher risk of faecal cross-contamination and a higher urine dilution rate. The present communication aims at presenting the first results of the urine collection and hygienisation process.

## **METHODS**

Urine effluent with a volume ratio urine:water of approximately 1:3 was collected under real conditions of use and stored in 20 l plastic containers under three different storage temperature: 4 °C, 23 °C and 30 °C.

The following physicochemical parameters were measured at collection time (day 0) and regularly along the storage period: pH, urea, ammonium and total nitrogen contents, nitrate, nitrite, COD, total phosphorus, potassium, sulphate, sodium, magnesium, chloride and calcium. Simultaneously, several microbiological parameters were also monitored. The presence and levels of microorganisms used as indicators for faecal contamination and selected microbial pathogens (total coliforms, faecal coliforms, *Staphylococcus* spp., *Salmonella* spp., enterococci and clostridia) were determined to evaluate the hygienic conditions and safety of samples using standards methods.

## **RESULTS AND DISCUSSION**

Results obtained during the first 30 days of storage regarding pH, urea, ammonia and total nitrogen content clearly showed that urine maturation process initiated shortly after collection and continued throughout the storage time. Indeed, with different degrees of intensity according to the storage temperature, pH rapidly rose to 9.5 while urea was being decomposed into ammonia/ammonium ( $\text{NH}_4^+/\text{NH}_3$ ) by the natural enzyme urease present in the urine.

As expected, the main microbial indicators contents exhibited a significant decrease within the first 30 days after collection.

## **CONCLUSION**

At this stage of our study, the first results clearly show that the urine dilution rate (1:3), inherent to our innovative dispositive, does not prevent to meet the required minimal nitrogen concentration, allowing the maturation process to occur in the collected urine effluent. As expected, storage temperature has proven to be an important factor for the maturation process.

## **ACKNOWLEDGEMENTS**

The authors are grateful for the WashOne Project (POCI-01-0247-FEDER-017461) funded by the Operational Program for Competitiveness and Internationalization (POCI) of Portugal 2020, with the support of the European Regional Development Fund (FEDER).

## REFERENCES

- Höglund C. 2001 *Evaluation of microbial health risks associated with the reuse of source-separated human urine*. PhD Thesis. Stockholm, Sweden: Royal Institute of Technology.
- Kirchmann, H., & Pettersson, S. 1994 Human urine-chemical composition and fertilizer use efficiency. *Nutrient Cycling in Agroecosystems*, **40**(2), 149-154.
- Kvarnström, E., Emilsson, K., Stintzing, A. R., Johansson, M., Jönsson, H., Petersens, E., Schönning, C., Christensen, J., Hellström, D., Qvarnström, L. Ridderstolpe, P. & Drangert, J. 2006 *Urine diversion: One step towards sustainable sanitation*. EcoSanRes Programme.
- Lienert, J., & Larsen, T. A. 2009 High acceptance of urine source separation in seven European countries: a review. *Environmental science & technology*, **44**(2), 556-566.
- Münch Ev, Winker M. 2011 *Technology Review of Urine diversion components*. Overview of urine diversion components such as waterless urinals, urine diversion toilets, urine storage and reuse systems. Eschborn, Germany: Deutsche Gesellschaft für Internationale Zusammenarbeit (GIZ) GmbH.
- Vinnerås B., Palmquist H., Balmér, P., & Jönsson, H. 2006 The characteristics of household wastewater and biodegradable solid waste - a proposal for new Swedish design values. *Urban Water Journal*, **3**(1), 3-11.

# Blackwater treatment with green microalgae *Chlorella vulgaris*

Ref # S2SMALL-63908

T. Griessler Bulc<sup>1\*</sup>, M. Žitnik<sup>1</sup>, M.A. Segovia Bifarini<sup>3</sup>, A. Krivograd Klemenčič<sup>2</sup>

<sup>1</sup>Faculty of Health Sciences, University of Ljubljana, Zdravstvena pot 5, SI-1000 Ljubljana, Slovenia

<sup>2</sup> Faculty of Civil and Geodetic Engineering, University of Ljubljana, Hajdrihova 28, SI-1000 Ljubljana, Slovenia

<sup>3</sup> University La Sapienza, Piazzale Aldo Moro 5, 00185 Rome, Italy

\* Presenting Author: [tjasa.bulc@zf.uni-lj.si](mailto:tjasa.bulc@zf.uni-lj.si) (email address is provided for presenting author ONLY)

**Keywords:** Blackwater, *Chlorella vulgaris*, nutrients, wastewater treatment

## INTRODUCTION / MAIN METHIODS

Municipal wastewater (WW) is in most cases treated as a mixture of WW from toilets, kitchens and bathrooms in a central WW treatment plant without closing material flows. Treated water is discharged into water bodies without reuse and due to its richness with nutrients; it is causing eutrophication of water bodies and irreversibly deposition of phosphorus in sediments of stagnant waters. Increasing urbanization and growing pressure on water supply and food production is leading to the development of source separation technologies with black, grey and yellow water to enable water reuse and to obtain new fertilizers for food production. Objective of this paper is to evaluate the possibility of treatment of blackwater (BW) from source separation system with green microalgae *Chlorella vulgaris* with main focus on nutrient (phosphorous) recovery

## Material and Methods

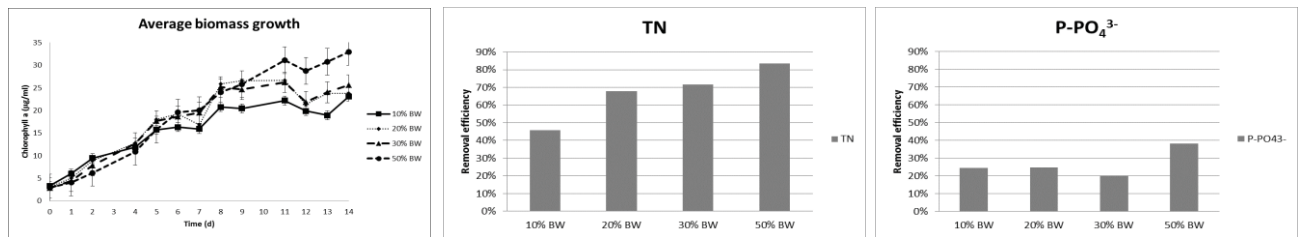
Lab-scale experiment consisted from four different tests of BW treatment (BW dilutions of 10%, 20%, 30% and 50%) by using a strain of green microalgae *C. vulgaris* (obtained from AlgEn, algal technology centre, Slovenia). The experiment was conducted in order to evaluate the impact of BW concentrations on *C. vulgaris* growth and its capacity of nutrients and organic matter removal. Tests were performed in batch-mode by using 2 L Erlenmeyer flasks at temperature of 25±2 °C, irradiance of 5000-6000 LUX in 18/6 h light/dark intervals and magnetic stirrer mixing. Each test sample contained 20% of *C. vulgaris* inoculum and 80% of BW dilution. The BW was sampled in a pilot BW separation system with low water consumption vacuum toilets (JETS™). COD, TN, N-NH<sub>4</sub><sup>+</sup>, P-PO<sub>4</sub><sup>3-</sup>, chlorophyll-*a*, dry weight and ash free weight of *C. vulgaris* inoculum and BW were measured every 24 hours for 14 days.

## RESULTS AND DISCUSSION

The concentrations of BW influenced a) the algae growth and b) the process of nutrient-organic matter removal (Figure 1). Lower BW concentrations lead to lower *C. vulgaris* growth yields and lower nutrient removal efficiencies after 14 days. Nitrogen was the nutrient



preferred by *C. vulgaris* (removal efficiencies > 70%), while the removal efficiencies of phosphorous were lower (< 50%).



**Figure 1. Biomass growth of *C. vulgaris*, total nitrogen (TN) and orthophosphate (P-PO<sub>4</sub><sup>3-</sup>) removal in four different lab-scale tests with different blackwater (BW) concentrations.**

This study demonstrates that microalgae *C. vulgaris* can recover N and P from raw BW, which is a promising result for future research of BW reuse while gaining valuable algal biomass, however certain limitations such as e.g. light and nutrient ratio have to be taken into account. The kinetics of microalgae growth depends on the dilution of BW, which correlates with the colour of BW and light availability for microalgae. More diluted BW represents less extreme conditions for microalgae, nevertheless biomass growth was higher in more concentrated BW. The phosphorus removal rate can be optimised by the use of a mixed inoculum of activated sludge and *C. vulgaris*, and by the pre-treatment of BW with anaerobic fermentation.

The authors acknowledge the financial support from the Slovenian Research Agency (projects J2-5462 “Development of new technologies for separation and treatment of black and grey water”, and J2-8162 »Closing material flows by wastewater treatment with green technologies«) and by support of Koto Ltd. and AlGen Ltd. The authors are grateful for all the support.

# Benefits of reducing toilet flushing volume in terms of resource recovery from blackwater

Ref # S2SMALL-2017

D. Todt<sup>1\*</sup>, I. Bisschops<sup>2</sup>

<sup>1</sup> Ecomotive As, Myravegen 1, Hareid, Norway

<sup>2</sup> LeAF, Wageningen, The Netherlands

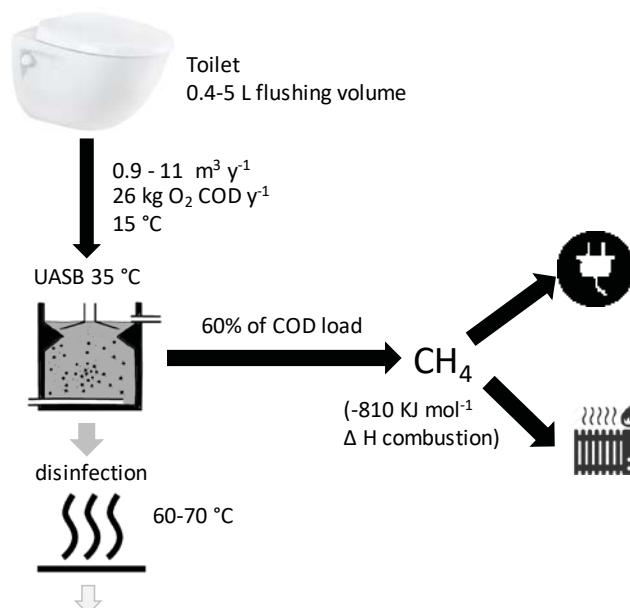
\* Presenting Author: dt@ecomotive.no

**Keywords:** blackwater recovery, flushing volume, anaerobic reactor, vacuum toilets

## INTRODUCTION

Source separating sanitation and subsequent recovery of nutrients are gaining an increasing popularity (Langergraber and Muellegger 2005; Larsen et al. 2009; Zeeman and Kujawa-Roeleveld 2011). The major feature of source separation is that a majority of nutrients and organic matter is retained in the relatively high concentrated blackwater fraction (Todt et al. 2015). This opens for the application of novel anaerobic treatment approaches having a high energy efficiency compared to traditional technologies. However, especially when heat disinfection is integrated to eliminate pathogens, energy efficiency of blackwater resource recovery becomes highly dependent on the concentration of its organic matter content (Zeeman and Kujawa-Roeleveld 2011). The latter is mainly determined by the flushing volume of the toilet (Todt et al. 2015).

This study was investigating the impact of flushing volume as well as toilet type on the energy balance of an anaerobic treatment approach. The energy balance considers a UASB reactor unit followed by a heat disinfection unit. Energy recovery from methane is calculated for both a simple heat recovery via a gas burner and a more advanced conversion into heat and electricity in a gas turbine (Fig. 1). More details are given in Todt et al. (2016).



**Figure 1.** Processes and basic conditions applied for energy assessment of this study

## RESULTS AND CONCLUSIONS

The gross energy consumption was calculated for five types of toilets having different flushing volumes (Tab. 1). Gravity toilets do not need energy but have with 2-5 liter a relatively high flushing volume. To obtain a lower flushing volume, a vacuum sewer system is needed giving a trade-off in an electrical energy consumption for blackwater transportation. A UASB needs both heat energy to reach an optimal process temperature and electrical energy for feeding that are both considered to be volume dependent. For disinfection an additional up-heating to 60-70 °C is needed which again requires accordingly additional heat energy.

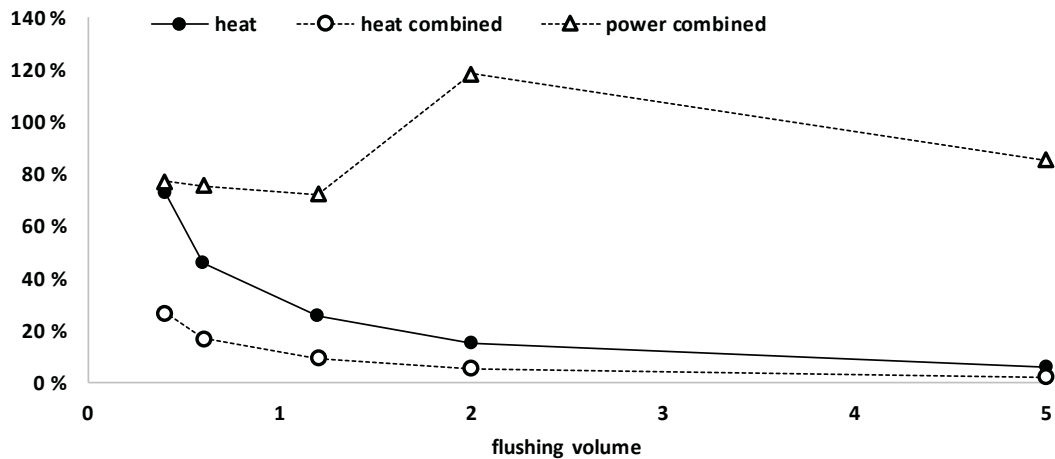
Given the thermal physics of fluids, heat energy requirement is more or less linear dependent on the flushing volume (Tab. 1). Electrical energy requirement on the other hand is higher for the lowest flushing volumes due to the additional energy consumption of the vacuum system. The latter accounts for approximately 10 kWh y<sup>-1</sup> per capita (Todt and Jenssen 2015) and is mainly depending on the number of pump starts or flushing events, respectively, rather than the flushing volume itself. Hence no significant difference in electrical consumption was found for the three vacuum-based toilet types.

**Table 1.** Energy consumption per capita (kWh y<sup>-1</sup>) at different toilet flushing volumes for vacuum sewer and anaerobic blackwater treatment including disinfection unit

Toilet type, flushing volume	heat requirement	electricity requirement
Gravity standard, 5 L	703	19
Gravity low flush, 2 L	281	14
Vacuum standard, 1.2 L	169	22
Vacuum low flush, 0.6 L	94	21
Vacuum ultra-low flush, 0.4 L	59	21

Considering a typical CH<sub>4</sub> conversion accounting for 60% of COD load for a UASB reactor (Zeeman and Kujawa-Roeleveld 2011) and burner efficiency of 80% of  $\Delta H$  combustion, 43 kWh heat energy could be gained from the organic matter contained in the blackwater with a simple gas heating system. This accounts for 6-73% of the heat needed for operation of UASB and disinfection stage (Fig. 2). Applying a more advanced recovery would gain 16 kWh y<sup>-1</sup> electrical power and 27 kWh y<sup>-1</sup> heat, considering the energy transformation efficiencies for a gas turbine reported by Kroiss and Svardal (2009).

Fig. 2 indicate an exponential decrease of net heat consumption with decreasing flushing volume, while electrical energy consumption slightly increases due to the vacuum sewer. However, since 75-95% of the systems energy consumption is heat, reducing the flushing volume from 5 to 0.4 liter reduces the net energy requirement from 680 to 80 kWh y<sup>-1</sup>. As shown in Fig. 2, at the lowest flushing volume up to 80% of the energy needed to run the system can be recovered, increasing the energy efficiency and recovery potential of a blackwater treatment notably.



**Figure 2.** Energy recovery potential in percentage of process energy consumption in dependency of flushing volume for a simple (heat only) and advanced (heat/electrical combined) recovery system

## ACKNOWLEDGEMENTS

This study is part of the Horizon 2020 project Run4Life (grant agreement No 730285) and is mainly financed by the European Commission.

## REFERENCES

- Kroiss H, Svoldal K (2009) The power consumption of sewage treatment plants *Österreichische Wasser- und Abfallwirtschaft* 61:170-177 doi:10.1007/s00506-009-0134-0
- Langergraber G, Muellegger E (2005) Ecological Sanitation—a way to solve global sanitation problems? *Environment International*
- Larsen TA, Alder AC, Eggen RIL, Maurer M, Lienert J (2009) Source Separation: Will We See a Paradigm Shift in Wastewater Handling *Environmental Science & Technology* 43:6121-6125 doi:10.1021/es803001r
- Todt D, Heistad A, Jenssen PD (2015) Load and distribution of organic matter and nutrients in a separated household wastewater stream *Environmental Technology* 36:1-28 doi:10.1080/09593330.2014.997300
- Todt D, Jenssen PD (2015) Particle removal in a novel sequential mechanical filter system loaded with blackwater *Water science and technology : a journal of the International Association on Water Pollution Research* 71:1407-1413 doi:10.2166/wst.2015.114
- Todt D, Moges ME, Heistad A Source separating sanitation as an option for efficient sanitary and wastewater management in cold climate regions. In: EWA Conference. Water management: Challenges in cold climate. 25–27 JUNE 2016. , Longyearbyen, Norway, 2016.
- Zeeman G, Kujawa-Roeleveld K (2011) Resource recovery from source separated domestic waste(water) streams; full scale results *Water Science and Technology* 64:1987-1992 doi:10.2166/wst.2011.562

# **An assessment of decentralised wastewater treatment technologies in North-East England.**

**Bunce, J.T.<sup>1</sup> Ofiteru, I.D.,<sup>1</sup> Graham, D.W.<sup>1</sup>**

<sup>1</sup> School of Engineering, Newcastle University, Newcastle Upon Tyne, UK

**Keywords:** decentralized wastewater treatment, microbial source tracking, regulation.

## **Introduction**

Regulatory conditions (DEFRA, 2010) mean that small-scale wastewater treatment works (WwTW) in the UK are often less well understood than larger ones. There is a dearth of reliable data for systems receiving flows of less than 50m<sup>3</sup> per day (~250 PE) and their ecological and health impacts may be underestimated. Variable loading rates and unpredictable hydraulic responses of decentralised systems means that existing knowledge cannot always be directly applied. This study seeks to address the data gap for decentralised WwTW in NE England and assess the stability of common technologies using typical and novel metrics. Specifically, the use of genetic markers often applied to microbial source tracking (MST) problems are employed as removal rate metrics.

## **Material and Methods**

An assessment of 15 WwTW across NE England, including 12 small-scale and 3 larger reference sites has been carried out. Technologies include secondary filtration, activated sludge and package plants - rotating biological contactors (RBC) & High Performance Aerated Filters (HiPAF). Bi-monthly, manual composite samples of influent & effluent are being taken between October 2016 and October 2017. Analysis for sCOD, tCOD, ammonia, nitrite, nitrate, solids and culturable faecal indicators provides insight into treatment performance and stability. Abundance and removal of genetic markers for human-associated *Bacteroides sp.* (Green et al., 2014), *Enterococcus* (Ahmed et al., 2008) and *E.Coli* (Chern et al., 2011; Gomi et al., 2014) are explored as novel performance and health impact metrics.

## **Results and Discussion**

Across all parameters, small works are less stable and generally produce poorer quality effluent. There is a significant difference ( $p < 0.01$ ) between effluent quality from large and small works for all abiotic metrics except total suspended solids (TSS), suggesting the variance may result from microbial factors. The strongest trend of covariance is shown by TSS effluent quality, however, the ammonia concentration best demonstrates the difference between small and large works performance. Package plants show less variance between works of the same technology type. The removal rate of genetic markers appears to be greater at larger works with both technologies removing close to 100% of *Bacteroides* and *E.Coli* (>4 log removal average). Whereas, there is greater variance between small-scale treatment technologies and the average removal rate is ~80% (3 log average; range 0.3 - 6 log removal). Further work on the behaviour of faecal markers at small works is warranted, particularly with the emergence of fresh-water MST applications.

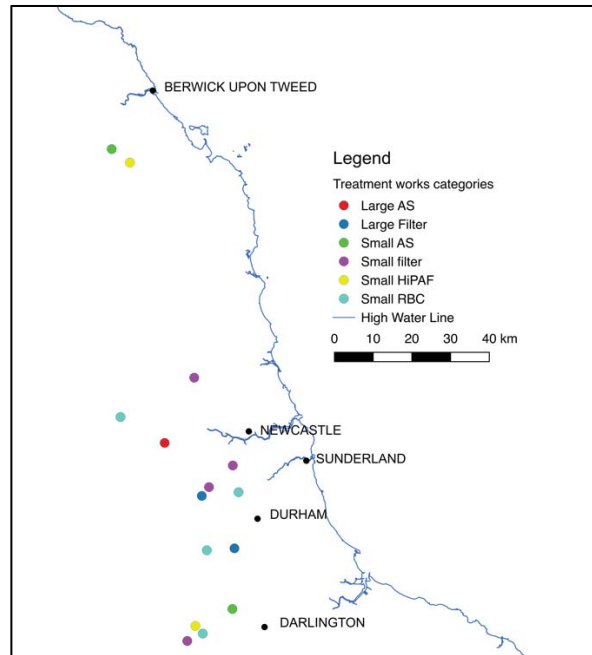


Figure 1: sample locations by treatment works type and population. RBC = rotating biological contactor, AS = activated sludge, HiPAF = high rate aerated filter. Small is <250 population equivalent, large is ~10,000 population equivalent.

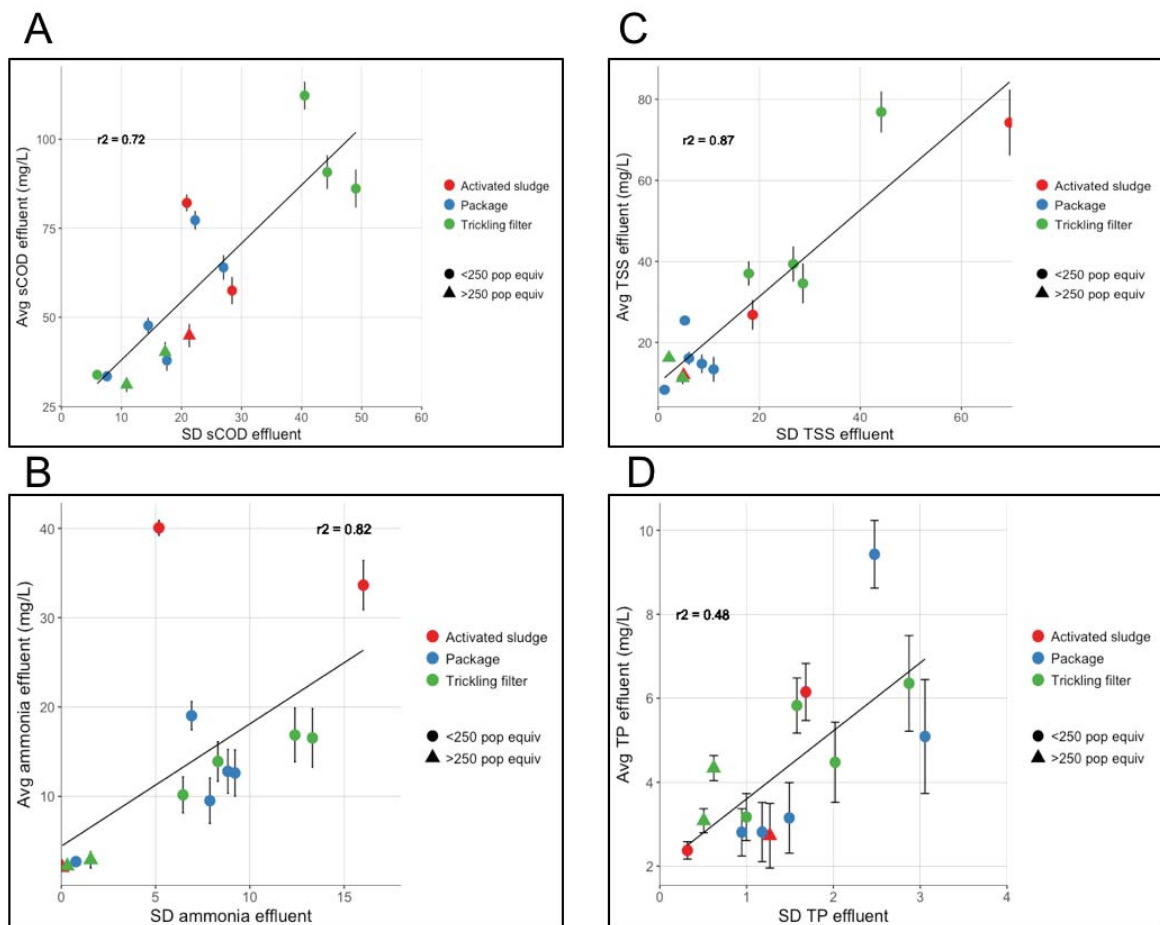


Figure 2: Covariance of effluent concentrations displayed graphically. A = soluble COD. B = ammonia. C = total suspended solids. D = total phosphorus.



## References

Ahmed, W., Stewart, J., Gardner, T., and Powell, D. 2008. A real-time polymerase chain reaction assay for quantitative detection of the human-specific enterococci surface protein marker in sewage and environmental waters. *Environmental Microbiology*. 10, 3255–3264.

Chern, E. C., Siefring, S., Paar, J., Doolittle, M., and Haugland, R. A. 2011. Comparison of quantitative PCR assays for *Escherichia coli* targeting ribosomal RNA and single copy genes. *Letters in Applied Microbiology*. 58. 298–306

Gomi, R., Matsuda, T., Matsui, Y., Yoneda, M. 2014. Fecal Source Tracking in Water by Next-Generation Sequencing Technologies Using Host-Specific *Escherichia Coli* Genetic Markers. *Environmental Science & Technology*. 48. 9616-9628.

Green, H. C., Haugland, R. A., Varma, M., Millen, H. T., Borchardt, M. A., Field, K. G., Walters, W.A., Knight, R., Sivaganesan, M., Kelty, C.A., Shanks, O.C. 2014. Improved HF183 quantitative real-time PCR assay for characterization of human fecal pollution in ambient surface water samples. *Applied Environmental Microbiology* 80, 3086–3094.

DEFRA. 2010., Environmental Permitting Regulations. London, UK.

# Small-scale wastewater treatment in drinking water sources protection area: A case study in China

Liu Chang, Chen Jianyu, Zhou Xiuxiu

South China Institute of Environmental Sciences, MEP, No.7 West Street, Yuancun, Guangzhou, P. R. China

**Abstract:** Drinking water sources are particularly sensitive to pollution. In some catchment areas of drinking water source of China, the wastewater treatment plants (WWTP) effluent meeting Class 1A standards ( $\text{COD}_{\text{Cr}} \leq 50 \text{ mg/L}$ ,  $\text{BOD}_5 \leq 10 \text{ mg/L}$ ,  $\text{TN} \leq 15 \text{ mg/L}$ ,  $\text{NH}_3\text{-N} \leq 5 \text{ mg/L}$ ,  $\text{TP} \leq 0.5 \text{ mg/L}$ ), which is the most stringent discharge standards in China, could still lead to micropollution in drinking water supply, posing a risk to public health. Due to this circumstance, advanced treatment of wastewater with higher standards is required. However, most of these areas are economic low-developed rural regions, the advanced wastewater treatment process selection is restricted by processing costs, post-maintenance and other factors. In this paper, a small WWTP located close to the drinking water source in South China with scale of 500 tons per day was selected as a study case. Several types of wastewater treatment technology were discussed and compared, including Anaerobic-Anoxic-Oxic technology (AAO), Biological Contact Oxidation technology, Constructed Wetland technology, Membrane Bio-Reactor technology and Biological Aerated Filter technology. A combined process of AAO- Functional Constructed Wetland -UV Disinfection, with a low cost of treatment and simple maintenance, was adopted after comparison of advantages and disadvantages according to the actual situations. The packing in the functional Constructed Wetland was an improved functional material, which could bring positive effects on denitrification and phosphorus removal. As demonstrated by the trail run, the effluent could satisfy the Class III requirement of the environmental quality standards for surface water (GB3838-2002), i.e.  $\text{COD}_{\text{Cr}} \leq 20 \text{ mg/L}$ ,  $\text{BOD}_5 \leq 4 \text{ mg/L}$ ,  $\text{TN} \leq 1 \text{ mg/L}$ ,  $\text{NH}_3\text{-N} \leq 1 \text{ mg/L}$ ,  $\text{TP} \leq 0.2 \text{ mg/L}$ . And the surface water in the region has been effectively protected by the project.

**Keywords:** drinking water source; Small-scale wastewater treatment; advanced treatment

# Impact Assessment of the community based water supply business in remote areas of Tanzania, Bagamoyo

Ref # S2SMALL-85735

Y. SOSHINO<sup>1\*</sup>, O. JUMA<sup>2</sup>, N. OKAMURA<sup>1</sup>, A. MIYATA<sup>1</sup>

<sup>1</sup> Japanese Red Cross Kumamoto Hospital, 2-1-1 Nagamine-minami, Higashi-ku, Kumamoto City, Kumamoto, 861-8520, JAPAN

<sup>2</sup> Ifakara Health Institute, Bagamoyo District Hospital, Bagamoyo, United Republic of Tanzania

\* Corresponding Author soshino@kumamoto-med.jrc.or.jp

**Abstract:** In remote areas of developing countries, ensuring the access to safe drinking water has been a challenge. The previous studies point out that the lack of safe drinking water causes the negative impact on health, livelihood, education opportunities. To tackle these difficulties, the implementation of the community based water supply business is considered to be one solution. This study assessed the impact of the community based water supply business in remote areas of Tanzania, Bagamoyo. The Comparative analysis was conducted to assess the impact on the health, the educational opportunities, the livelihood opportunities and sustainability of the services in the villages of Matipwili and Fukayosi. The result of this assessment highlights the positive impact on health, educational opportunities, and livelihoods of the beneficiaries. The limited availability of the water plant and inequality of the water fee were the challenges.

**Keywords:** Remote areas, Water treatment, Sustainability, Livelihood,

## INTRODUCTION

Water is essential for the human beings. Whilst water is imperative for the people in the world, a number of people still have a difficulty in accessing the safe and sufficient potable water. In sub-Saharan Africa and Oceania, less than 50% of the population uses improved drinking water sources. Nowadays, 96 per cent of the global urban population uses improved drinking water sources, however, eight out of ten people still without improved drinking water sources live in rural areas. (Unicef, UN ,2015) There are 25 countries in Sub-Saharan Africa in which the percentage point gap between use of improved drinking water in urban and rural areas is more than 25%. In seven countries – Congo, Democratic Republic of Congo, Ethiopia, Gabon, Niger, Sierra Leone and Somalia – it is more than 50%. (Unicef and WHO 2011) In Tanzania, 54% of the total population have access to water supply whilst 55% of the population in rural areas are not covered by the water supply. (World Bank, 2015) 38% of schools in Tanzania do not have the water supply in the school premises. (Unicef, 2011) In developing countries, water collection and hauling occupies large amounts of time and energy. (Carter et al. 1999)

A poor access to water supply, whatever the reason, is associated with significant health risks. (Hunter et al 2010) In 2010, diarrhea disease was responsible for almost 9% of all deaths of Tanzanian under five children just behind Malaria (11%) and pneumonia (15%) (Liu et al. 2012). In low income countries like Tanzania, it has been suggested that up to 88% of all the child diarrhea cases can be attributed to inadequate sanitation, unsafe water and or insufficient hygiene (Prüss-Üstün, 2008).

In addition to the water and health challenges, many people around the globe including women, children, the elderly, indigenous peoples and people with disabilities have lower

levels of access to safe drinking water, hygiene or sanitation facilities than other groups. (WWAP 2015). Poor access to WASH at household and schools negatively impact the children's education. (WaterAid 2013) In rural communities, a 50% of reduction in the time to haul water could increase the girls attendance of the school by 7 percent on the average, with stronger effects in rural communities. (Nauges et al. 2015)

A lot of studies reported the positive impact of the water supply in alleviating poverty in developing countries. Low density populated areas seem to suffer increased levels of WASH poverty. (Garriga et al. ) In Tanzania, poorer households pay three times more for water as a proportion of their income. (Unicef 2011) With improved access to WASH, women have more time to undertake income-generating activities. (WaterAid 2013)

The previous studies suggested the challenges in ensuring the sustainability of the water supply services. The implementation of private sector service models is one of the three potential solutions to the limited success of community-managed rural water supplies. (Harvey et al 2007) Better focus on implementation of rules by project staff, intermediaries, contractors or NGOs will improve performance of the water supply project. (Travis et al. 2005) In terms of appropriate technology, sustainability has two meanings: environmentally sustainable and locally sustainable. To be locally sustainable, the technology need to be introduced and developed so that the local users will be able to maintain, reproduce and repair it after the outside designers have left the community. (Murphy et al. 2009)

In 2004, a private Japanese company commenced the water supply business in remote areas of Bagamoyo, Tanzania. The project provides the affordable safe water in a remote village of Matipwili. This study aims to examine the effectiveness of the water supply business model in remote areas of Bagamoyo, Tanzania. In this study, the impact on the health, the educational opportunities, the livelihood opportunities and sustainability of the services are assessed in the villages of Matipwili and Fukayosi.

## **MATERIALS AND METHODS**

### **Materials**

#### ***Project Overviews***

In 2013, Japan International Cooperation Agency (hereafter JICA) introduced Small and Medium-Sized Enterprise Partnership Promotion Survey on a trial basis. Under this framework, one Japanese private company, "Poly-Glu Social Business Co., Ltd", commenced the community based water supply projects in Tanzania. In 2014, The Company decided to expand the projects in four rural communities in Tanzania, in collaboration with JICA, the Government of Tanzania, and Tanzania Water and Environmental Sanitation (TWESA) which is a countrywide local NGO. In 2014, the company started the installation of water treatment plants in a rural village of Matipwili in Bagamoyo of Pwani Region, Tanzania. The village of Matipwili has approximately 2,400 of population and the people in the village had been relying on nearby river water before this project started.

#### ***Affordable Flocculant.***

PG $\alpha$ 21Ca is low cost flocculant which has rapid aggregation capacity. The main contents of the flocculant are natural calcium and poly-glutamic biodegradable acid. PG $\alpha$ 21Ca is the low cost technology which can purify 1,000 liters of water and it costs less than two USD. Moreover, it can remove even arsenic which causes serious health problems around the world, especially in the areas where people are relying the drinking water on wells.

## Equipment

All the equipment and items for this study, except for PGO<sub>2</sub>Ca, were locally purchased in Tanzania. The main equipment for the water plant (“Fig.1”) consists of water tanks, pipes, hoses and engine pumps.(Table 1) In filtration tank, filter consists of four layers, from bottom, 40 cm of charcoal, 10 cm of small stones, 10 cm of gravels and 60 cm of sands. Tough fabric divides each layer for easing maintenance.

**Table 1.** The equipment



**Figure 1.** The Plant in Matipwili Village

---

### Necessary Equipment/Items

---

- Agitation Tank (1MT X 2)
- Filtration Tank(2MT X 1)
- Storage Tank (3MT X 1)
- Engine Pump and Pipes

*(Total Initial Cost)*

Approximately 20,000USD

\*The cost can be reduced by simplifying the facilities.

---

The construction cost for the small type of the plant was approximately USD 20,000. However, the construction cost can be flexibly reduced by simplifying the facilities and taking an advantage of the geographical feature. In this project, the local purchase is the key to this business in order to reduce the initial costs and ensure the spare parts are handed over after to the local counterparts.

## The Business Establishment

In June 2014, the mayor of Bagamoyo district officially permitted to start this community water supply project. After the discussions with the community leaders of Matipwili, the questionnaire surveys were conducted to assess the demand for clean water and the purchase power of community members. The sales price of water was settled after the consultation with the community leaders of Matipwili. The ex-sales cost of water has been settled at 150 Tanzania Shillings(0.07USD) for 20 liters of the treated water. The treated water is distributed by water vendors to households. The transportation cost is added on the ex-store cost, for example, the 20 liters of water costs 3,000 Shillings(1.33USD) in the community where 10 km away from the water plant.

### *The operation staff of the plant*

The Matipwili water plant has eight staff members: one manager, three operators, two female sales representatives for fee collection and two security guards. The technical support and regular monitoring have been conducted by Tanzanian NGO(TWESA) when needed. The transportation of the treated water is operated by local water vendors. The water vendors convey the water by bicycles, motorbikes.

## **Methods**

### *Study Design*

The study will be cross-sectional design that employs both quantitative and qualitative research methods (FGD, key informant interviews, and in-depth interviews, and health facility survey). Health facility data relating with waterborne diseases will be collected for the previous one year before the survey. The study will compare intervention (Matipwili) and control villages in terms of quality of water supply, water borne diseases and livelihood. The village of Fukayosi was chosen as the control village since the population size was close to the intervention village.

**Table 2.** Sample Size

<b>Variable</b>	<b>Intervention Villages</b>	<b>Control Villages</b>	<b>Total</b>
Focus Group Discussions	3	3	6
In-depth Interviews	15	15	30
Health facility to be surveyed	1	1	2

### *Data Collection*

This study employed various approaches and data sources to address the above mentioned objectives. Qualitative data collection techniques were used to gather all the necessary information. Questionnaires which will include both open and closed ended questions were used at all levels of data collection. Health information was collected by visiting to health facilities in Bagamoyo district. Improvement of access for educational and livelihood opportunities were assessed. The FGD were conducted in place convenient to participants. The moderator first introduced all participants, explained the general topic for discussion and how to contribute during the discussion, before asked for their consent. The moderator led the discussion while the note taker took notes. The FGDs were recorded using an MP3 voice recorder, after gaining permission. After the FGD, the note-taker and the moderator reviewed their hand written notes.

### *Field Visits*

The authors visited Tanzania in June and December 2014, and February 2016. We monitored the site selection and construction process of the water treatment plants in the study area. Key informants interviews were conducted during the field visits.



### *Ethical Considerations and Clearance*

The study received the ethical approvals from ethics committees of Ifakara Health Institute and National Institute for Medical Research in Tanzania.

## RESULTS AND DISCUSSION

### Results

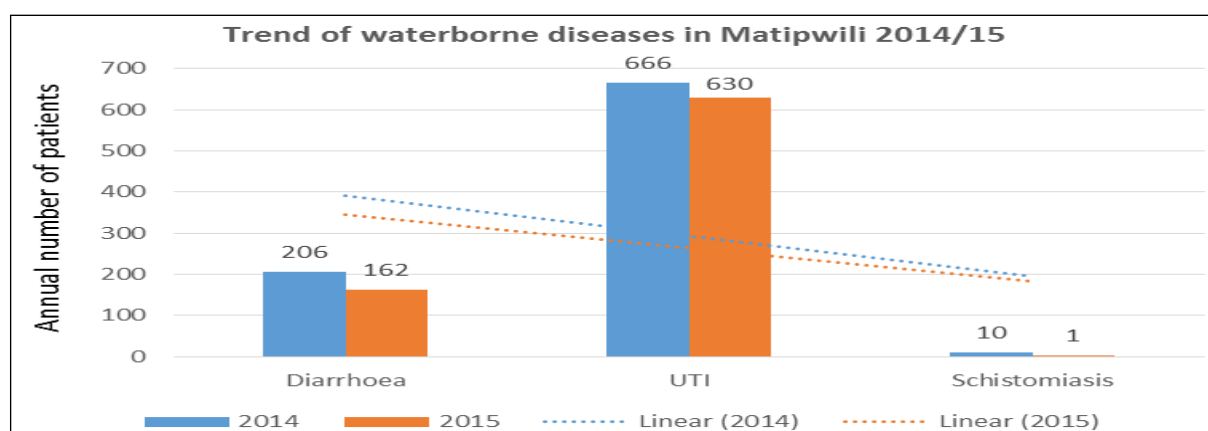
#### *Impact on Health*

Table 3 shows the monthly and annual number of patients for water borne diseases in intervention villages.

**Table 3.** Annual Number of waterborne diseases in Matipwili

Matipwili 2014													
Disease	January	February	March	April	May	June	July	August	September	October	November	December	Total
Diarrhoea	25	19	14	17	28	6	6	20	23	19	16	13	206
UTI	32	29	43	58	61	55	67	65	50	62	70	74	666
Schistomiasis	0	0	3	0	1	2	2	2	0	0	0	0	10
Typhoid	0	0	0	0	0	0	0	0	0	0	0	0	0
Cholera	0	0	0	0	0	0	0	0	0	0	0	0	0
Matipwili 2015													
Diarrhoea	11	20	24	12	6	10	22	17	9	19	9	3	162
UTI	46	54	53	42	34	87	67	63	40	43	55	46	630
Schistomiasis	0	1	0	0	0	0	0	0	0	0	0	0	1
Typhoid	0	0	0	0	0	0	0	0	0	0	0	0	0
Cholera	0	0	0	0	0	0	0	0	0	0	0	0	0

In the year 2014 there was a great number of patients with urinary tract Infection (UTI) followed by diarrhoea and schistomiasis. There was no number reported on typhoid and cholera. However in 2015 after start of the water treatment plant, the number of patients in three mentioned diseases was reduced. Despite declining of trend of waterborne disease in 2015, as compared to 2014 (“Fig. 2”), yet UTI was still leading as major waterborne problem, followed by diarrhoea in the intervention area. There was no number reported for typhoid and cholera. However, when compared the two years, the later had lower number of patients in all disease.



**Figure 2.** Trend of waterborne diseases in Matipwili

### *Impact on the Learning Opportunities*

School children have reported to attend class regularly with clean uniforms. Specifically for intervention village, this is more seen to communities living closer to water treatment plants. The school children's uniform and general cleanness of the pupils living closer to sources of water, were much better as compared to those living far away from sources of water. Furthermore, the project has simplified the task of children fetching water from river, as when the back from school they go on water tap to take water, and go back to school.

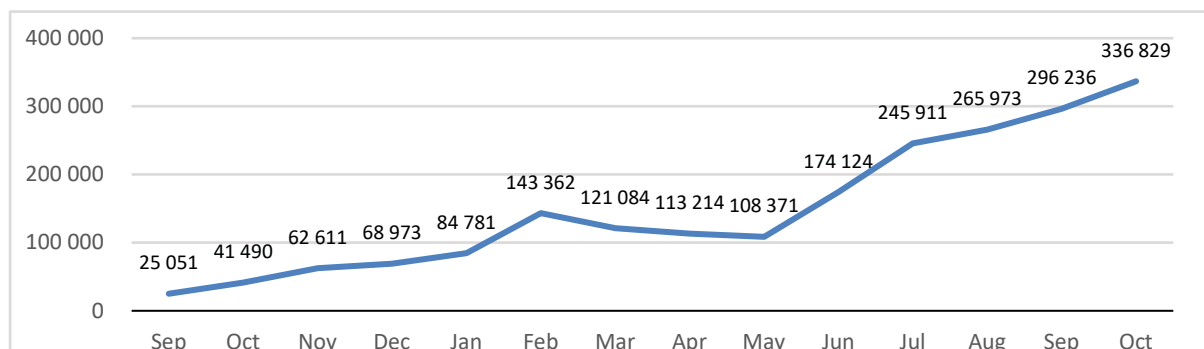
### *Impact on the Livelihoods*

More than a half of respondents in each FGDs group and individual in depth interviews were reported to have been benefited with water projects. Specifically for Intervention village, availability of water project has helped community to get enough time to engage in livelihood activities such petty business which includes frying fishes, growing and selling of green vegetables, baking, chicken and bee keeping, aquaculture. Other activities in including farming, fishing and casual labour such as mud house building.

### *The Business Situation*

“Fig.4” presents the increase of water sales amount (litre) at water plants in Matipwili plant from Sept.2014 to Oct. 2015. As of July 2016, the water plant was handed over to the local community. Since then, the Matipwili village has been operating the water plant.

**Fig. 4** The amount of water sales amount (Litre)



### **Discussion**

This study assessed the impact of the community based water supply business in remote areas of Tanzania, Bagamoyo. The result of this assessment revealed the positive impact on health, educational opportunities, and livelihoods of the beneficiaries. The limited availability of the water plant and inequality of the water fee were the challenges of this business. The limitation of this study is the limited availability of the health data of the target populations. In addition, the regular biological analysis of the supplied water should be conducted at the plant and households.

### *Implications*

Given the water plant was installed in the remote areas of Bagamoyo, where the populations were scattered in the wide geographic areas, the water treatment plant showed its adaptability to the low density areas in the developing countries. Therefore, application of this service model to the humanitarian response to the slow onset disasters, such as population

movements, floods, epidemics (cholera), should be considered. In addition to the adaptability to the geographical settings, this water supply business model showed its sustainability in terms of the local purchase of the equipment and the job creation of the plant staff and water vendors. Furthermore, this study presented that this business model can also be applied in urban settings of many African countries, where the access for the clean and safe water is difficult.

### ***Further studies***

Currently, this water supply business has been expanded in several places of Tanzania. Comparative study on the success factors of the business is valuable to identify the appropriate site selection. To improve the inequality of the water fee by the distance from the water plant, the management of the water transporters is important. In addition, the quality control in the whole distribution process from the plant to the household storage should be studied including the microbiological study.

### **CONCLUSIONS**

This study assessed the impact of the community based water supply business in remote areas of Bagamoyo, Tanzania. The positive impact was seen in health, education opportunities, livelihood activities in the target community. Whilst the water business performed its business sustainability, the inequality of the water cost, which caused by the distance from the water plant was identified as a challenge.

### **REFERENCES**

- Céline Nauges Jon Strand, 2015 Water Hauling and Girls' School Attendance: Some New Evidence from Ghana 2015 Environ Resource Econ, DOI 10.1007/s10640-015-9938-5
- Hunter PR, MacDonald AM, Carter RC (2010) Water Supply and Health. PLoS Med 7(11): e1000361. doi:10.1371/journal.pmed.1000361
- Heather M. Murphy\*, Edward A. McBean, Khosrow Farahbakhsh, 2009 Appropriate technology – A comprehensive approach for water and sanitation in the developing world, Technology in Society 31 (2009) 158–167
- Katz TRAVIS, Sara Jennifer J. 2005. Making rural water supply sustainable: report on the impact of project rules. Water and sanitation program. Washington, DC: World Bank. <http://documents.worldbank.org/curated/en/495261468135922056/Making-rural-water-supply-sustainable-report-on-the-impact-of-project-rules>
- Liu L, Johnson HL, Cousens S, Perin J, Scott S, et al. (2012) Global, regional, and national causes of child mortality: an updated systematic analysis for 2010 with time trends since 2000. Lancet 379: 2151–2161
- Peter A. Harvey, Robert A. Reed, 2007 Community-managed water supplies in Africa: sustainable or dispensable? Community Development Journal Vol 42 No 3 pp.365-378
- Prüss-Üstün A, Bos R, Gore F, Bartram J (2008) Safer water, better health: costs, benefits and sustainability of interventions to protect and promote health. Geneva: World Health Organization.
- Ricard Gine Garriga, Augsti Perez Foguet, 199x Unravelling the Linkages Between Water, Sanitation, Hygiene and Rural Poverty: The WASH Poverty Index,

Richard C Carter, Sean F Tyrrel, Peter Howsam, 1999. Impact and Sustainability of Community Water Supply and Sanitation Programmes in Developing Countries, Journal of the Chartered Institution of Water and Environmental Management, Vol 13, pp 292-296,

Shamila Jansz, Jane Wilbur (2013) Women and WASH Water, sanitation and hygiene for women's rights and gender equality, Briefing Note, WaterAid

UNICEF and World Health Organization 2015: 2015 Progress on sanitation and drinking water - 2015 update and MDG assessment, ISBN 978 92 4 150914 5, pp.4-6.

Unicef 2011: Fact Sheet Water, sanitation and hygiene, [https://www.unicef.org/tanzania/resources\\_11476.html](https://www.unicef.org/tanzania/resources_11476.html) (Accessed 28 June 2017)

Unicef 2010: Children and Women in Tanzania, Volume 1 Mainland, [https://www.unicef.org/tanzania/resources\\_12058.html](https://www.unicef.org/tanzania/resources_12058.html) (Accessed 28 June 2017)

WHO and Unicef: Drinking Water Equity, Safety and Sustainability: Thematic report on drinking water 2011

World Bank 2015: Water Supply and Sanitation in Tanzania Turning Finance into Services for 2015 and Beyond,

WWAP (United Nations World Water Assessment Programme). 2015. The United Nations World Water Development Report 2015: Water for a Sustainable World. Paris, UNESCO.

# The Effect of pH on the Removal of Bacterial Indicator Organisms in Wastewater Stabilization Ponds

Ref # S2SMALL-99808

Lei Liu<sup>1</sup>, Geof Hall<sup>1</sup>, Pascale Champagne<sup>1\*</sup>

<sup>1</sup> Queen's University, 58 University Ave., Kingston, ON, Canada

\* Corresponding Author: pascale.champagne@queensu.ca

**Keywords:** Wastewater stabilization ponds (WSPs); bacterial indicator organisms; pH

## INTRODUCTION / MAIN METHIODES

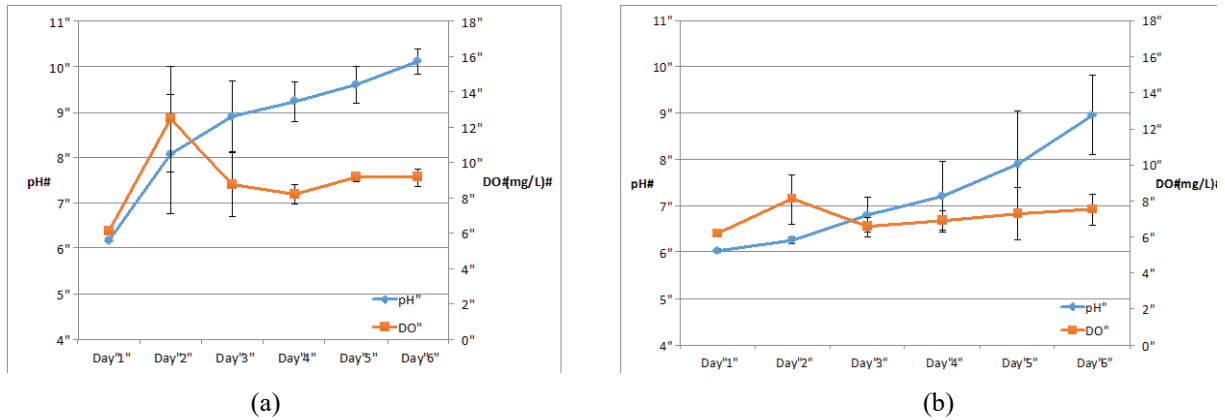
The aim of this work was to investigate the effect of pH on the removal of bacterial indicator organisms in a WSP operated in a temperate climate. Disinfection efficiency in WSPs is strongly influenced by environmental factors, as the treatment in a WSP is dependent on natural purification. Environmental factors, such as pH, dissolved oxygen (DO), temperature and sunlight intensity play an important role in pathogen removal. High pH levels (pH >9) have been recognized in the literature as a critical mechanism for pathogen inactivation in WSPs. A neutral to slightly acidic pH (between 6.5 and 7.5) is optimal for fecal bacteria growth, while pH levels above 9 are effective in indicator organism removal (Davies-Colley et al., 2000; Awuah, 2006; Ansa et al., 2011, 2012). *Escherichia coli* (*E. coli*), fecal coliforms and total coliforms are the most commonly used pathogenic indicator organisms, however, concerns with respect to their limitation and accuracy have recently been reported, and potential strategies to overcome some of these have been proposed (Bouhoum et al. 2000; Betancourt and Rose 2004; Coulon et al. 2010). In this study, *Enterococci* and *Clostridium Perfringens* were selected, in addition to conventional indicator organisms, to investigate the effects of environmental factors on the inactivation of a variety of microorganisms.

The WSP system investigated in this study is located on the north shore of Lake Ontario (Canada). Samples were collected from the inlet to the pond system. Algae samples were cultivated in Bold's Basal Medium (BBM) for 6 days, and pH and DO values were recorded. The culture and enumeration of indicator organisms were carried out using the membrane filtration method according to the Standard Methods for the Examination of Water and Wastewater (APHA, 2005). The plates were cultured at temperatures of 37°C (*E. coli*, fecal coliforms, total coliforms and *Enterococci*) and 44°C (*Clostridium Perfringens*) for 24 hrs. Five pH levels (4, 7.5, 8.5, 9.5 and 10.5) were investigated. pH in wastewater samples was adjusted accordingly using 1 N sodium hydroxide or 1 N hydrochloric acid.

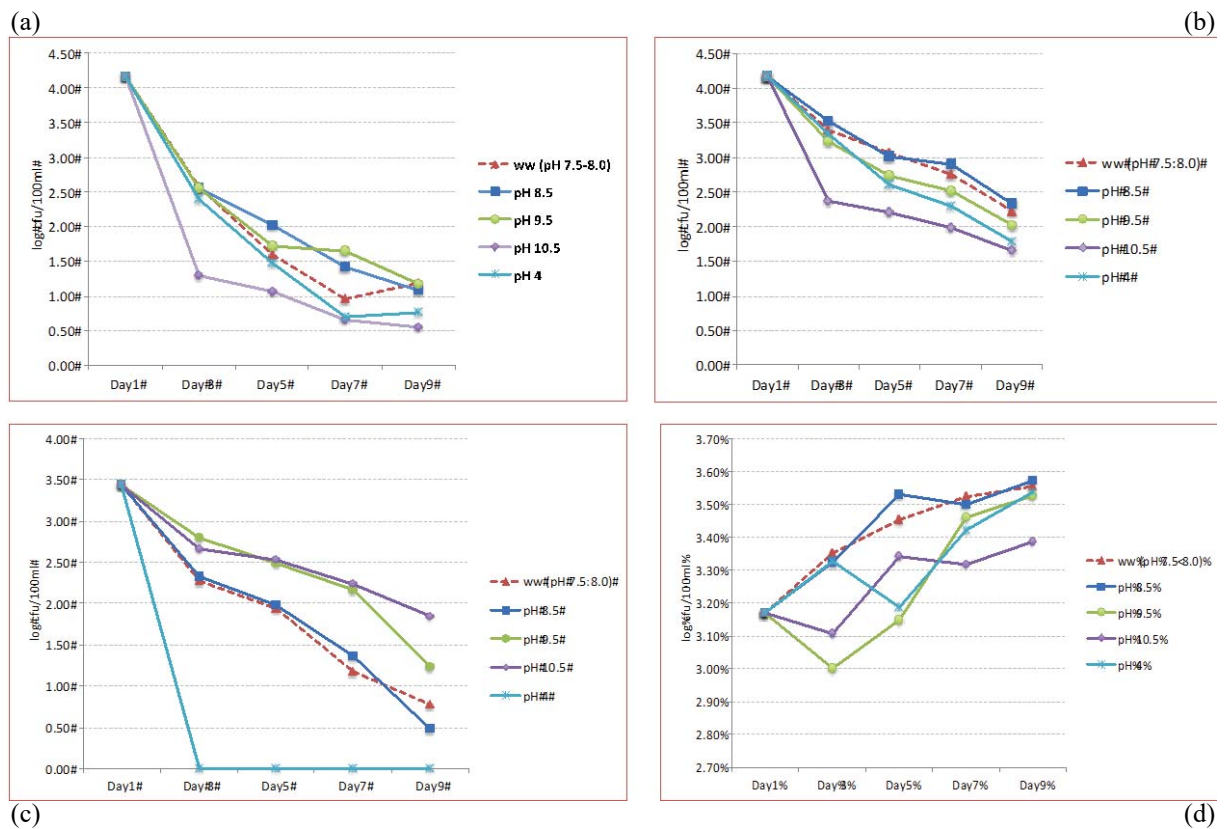
## MAIN RESULTS AND CONCLUSIONS

Two species of macroalgae were found in the WSP during the summer sampling season of 2016; water net (*Hydrodictyon*) and filamentous (*Spirogyra*) algae. Algal growth showed strong positive correlations with pH and DO in laboratory experiments (spearman's coefficient of 0.82) (Figure 1). *E. coli* decayed faster under pH levels of 10.5 and pH 4 in comparison to other pH conditions tested. Total coliforms showed an increase in mortality with increasing pH from 8.5 to 10.5. *Enterococci* responded differently to basic condition than *E. coli* and total coliforms as their mortality was lower under acidic condition than basic

condition. *Clostridium perfringens* are spore-forming bacteria that are more resistant to environmental stresses. They can survive and even grow under extreme pH conditions (pH 4 and pH 10.5). This study confirmed that traditional indicator organisms, *E. coli* and total coliforms offer some limitations in their ability to represent an overall level of pathogens in treated wastewater. It would be recommended that additional indicator organisms, such as *Enterococci* and *Clostridium Perfringens* be considered in regular disinfection monitoring programs and included in discharge regulation.



**Figure 1.** DO and pH changes as a function of macroalgae ((a): *Spirogyra*, (b): *Hydrodictyon*) in BBM with a starting pH of 6.



**Figure 2.** The effect of different pH levels on the mortalities of *E. coli* (a), total coliforms (b), *Enterococci* (c) and *Clostridium perfringens* (d).



## REFERENCES

- Ansa E. D. O., Lubberding H.J., Ampofo J. A. & Gijzen H. J. 2011 The role of algae in the removal of *Escherichia coli* in a tropical eutrophic lake. *Ecol. Eng.* **37** (2011), 317-324.
- Ansa E. D. O., Lubberding H. J., Ampofo J. A., Amegbe G. B. & Gijzen H. J. 2012 Attachment of faecal coliform and macro-invertebrate activity in the removal of faecal coliform in domestic wastewater treatment pond systems. *Ecol. Eng.* **42** (2012), 35-41.
- Awuah E. 2006 *Pathogen removal mechanisms in waste stabilisation ponds*. PhD thesis, Wageningen University/UNESCO-IHE Institute for Water Education, The Netherlands.
- Betancourt W. Q. & Rose J. B. 2004 Drinking water treatment processes for removal of *Cryptosporidium* and *Giardia*. *Veterinary Parasitology* **126** (1-2), 219-234.
- Bouhoum K., Amahmid O. & Asmama S. 2000 Occurrence and removal of protozoan cysts and helminth eggs in waste stabilisation ponds in Marrakech. *Water Sci Technol* **42**(10 11):159–164.
- Coulon C., Collignon A., McDonnell G. & Thomas V. 2010 Resistance of *Acanthamoeba* spp. cysts to disinfection treatments used in healthcare settings. *J. Clin. Microbiol.* **48**, 2689–2697.
- Davies-Colley R. J., Donnison A. M. & Speed D. J. 2000 Towards a mechanistic understanding of pond disinfection. *Water Sci. Technol.* **42**, 149 - 158.
- Standard Methods for the Examination of Water and Wastewater* 2005, American Public Health Association/American Water Works Association/Water Environment Federation, Washington DC, USA.

# Treatment performances of a pilot-scale free water surface constructed wetland system for secondary effluents

Jin, M.<sup>1</sup>, Champagne, P.<sup>1,2</sup>, Hall, G.<sup>1</sup>

<sup>1</sup> Civil Engineering, Queen's University, Kingston, ON, Canada

<sup>2</sup> Chemical Engineering, Queen's University, Kingston, ON, Canada

**Keywords:** Wastewater Stabilization Ponds (WSPs); Constructed Wetlands (CWs); Free Water Surface (FWS); Peat; Algal bloom;

## Introduction

Wastewater Stabilization Ponds (WSPs) represent a simple yet effective wastewater treatment technology, which a number of small, remote and rural municipalities in North America have adopted as low cost, energy and maintenance facilities for wastewater treatment. However, certain climate and environment conditions could raise concerns with respect to WSP as algal blooms can frequently occur under elevated temperature and strong solar radiation conditions prevalent during the summer season, resulting in high pH effluent that cannot meet regulatory wastewater effluent discharge criteria (Kayombo et al., 2002).

Constructed Wetlands (CWs), on the other hand, have been demonstrated to be reliable alternative wastewater treatment approaches that can be applied to treat various wastewater sources. They rely on natural processes to assist in treating the wastewaters, and requires very low or no energy input, which made them ideal for small communities (Vymazal, 2010).

Amherstview Water Pollution Control Plant (WPCP), located in Amherstview, Ontario, Canada (44°14'N, 76°39'W) employs an effluent polishing and storage lagoons system for the treatment of secondary wastewater effluent, and the system periodically suffers algal blooms during the summer season. A previous bench-scale study (Jin et al., 2017) was conducted to evaluate different substrates in the laboratory in order to select the most suitable substrates for the pilot-scale CW. Therefore, the aim of this study was a) develop a pilot-scale CW to remediate the high pH effluent; and, b) evaluate the performance of three different substrates that could be applied in the full-scale CW.

## Material and Methods

The pilot-scale Free Water Surface (FWS) CW was initially designed in 2014, and the construction was completed in June 2016. The schematic design of the wetland is illustrated in Fig. 1. It consists of four different treatment trains (three open-water connections and one berm connection), and each treatment train contains three treatment cells in series. Three different substrates were applied in this wetland including topsoil, de-watered sludge, and

peat. *Typha latifolia* was transplanted from a local natural wetland as sole vegetation in this CW, although colonization by other native vegetation is anticipated as the system matures. The FWS CW was operational in September 2016, and the system monitoring was initiated in March 2017.

Wastewater samples are collected weekly from 15 sampling points along the CW (sampling points shown in Fig. 1) at the wastewater treatment facility at the Amherstview WPCP. pH, temperature, Oxidation-Reduction Potential (ORP), Chlorophyll a (Chl-a) are measured on-site by Hydrolab DS5 multiparameter data sonde, while wastewater quality samples are collected, stored at 4°C and brought back to the laboratory at Queen's University for water quality analysis, including COD, total nitrogen (TN), total phosphorous (TP), ammonium, nitrate, nitrite, alkalinity (APHA, 2005).

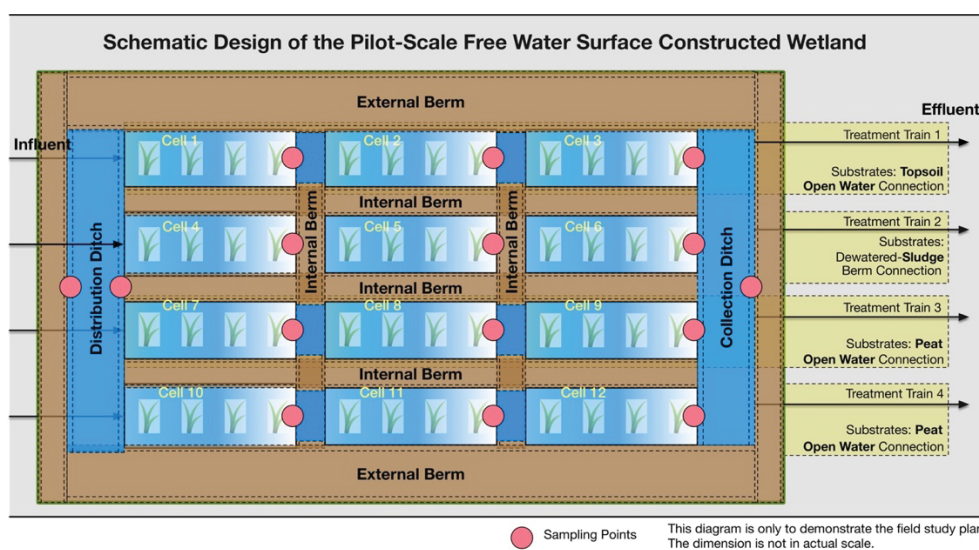


Figure 1. Schematic Design of the Pilot-Scale Free Water Surface Constructed Wetland

## Preliminary Findings

Initial monitoring has shown that the treatment trains with peat were able to attenuate the pH level from an average 8.2 to 7.0 without dense vegetation in the first month. It is anticipated that as the system matures, system pH will be maintained at the range from 6.5 to 8 without human interference. The interaction between microorganisms, plants and substrates within CW will be able to further remove organic matters and nutrients from the secondary effluent.

## References

- APHA, 2005. Standard methods for the examination of water and wastewater. 21<sup>st</sup> edn. American Public Health Association, Washington, DC.
- Jin, M., Champagne, P., Hall, G., 2017. Effects of different substrates in the mitigation of algae-induced high pH wastewaters in a pilot-scale free water surface wetland system. *Water Sci. Technol.* 75 (1), 1-10.
- Kayombo, S., Mbwette, T. S. A., Mayo, A. W., Katima, J. H. Y., Jørgensen, S. E., 2002. Diurnal cycles of variation of physical-chemical parameters in waste stabilization ponds. *Ecol. Eng.* 18 (3), 87-91.
- Vymazal, J., 2010. Constructed wetlands for wastewater treatment. *Water* 2 (3), 530-549.

## **Assessment of groundwater quality Case study of Ha-Tshivhasa, Limpopo Province, South Africa:**

Sengani F<sup>a\*</sup> Nengwekhulu S<sup>b\*</sup>, Rembuluwani N<sup>c\*</sup>, Mogotlane K.L.E<sup>d\*</sup>

<sup>a\*</sup> South Deep Gold Mine, Johannesburg, South Africa

<sup>b\*</sup> University of Venda, School Agriculture, Department of Horticultural science

<sup>c\*</sup> University of Venda, School of Environmental sciences, Department Mining and Environmental Geology, Limpopo, South Africa

<sup>d\*</sup> South Deep Gold Mine, Johannesburg, South Africa

Corresponding authors: [fhatugeorge@gamil.com](mailto:fhatugeorge@gamil.com)

: [nengwekhulu.s@gmail.com](mailto:nengwekhulu.s@gmail.com)

[Ndivhudzannyi.rembuluwani@univen.ac.za](mailto:Ndivhudzannyi.rembuluwani@univen.ac.za)

### **ABSTRACT**

Water is considered to be the most precious and important of all natural resources. Groundwater plays a vital role in most of rural areas in South Africa especially for rural water supply due to insufficient pipe borne water supply. Salinity is regarded as one of the major contributor to water pollution, not only in rural areas but throughout South Africa. The aim of the study was to assess the quality of groundwater at Ha-Tshivhasa villages. The investigation of ground water quality involved analysis of physical water quality parameters such as pH, Electrical Conductivity, turbidity, salinity and Geo-statistical Analysis. Water samples were collected from seven different boreholes for the period of four months, pH, EC and TDS meter were used to measure the physical parameters and turbidity was measured using a turbidity meter. The results shows that pH values for the boreholes ranged between 6.61 and 8.26, showing that all the boreholes were slightly acidic to alkaline. The EC of the boreholes ranged from 947  $\mu\text{s}/\text{cm}$  to 2350  $\mu\text{s}/\text{cm}$ , the concentrations of EC were found to be above the recommended standard for water quality. Turbidity of all the boreholes was found to be within the range of 1-5 NTU indicating that the turbidity of all the boreholes were within required standard. Lastly, the TDS of the sampled water was ranging from 660 mg/l to 1790 mg/l and the salinity were ranging from 465 ppm to 1120 ppm, both TDS and salinity were found to be higher as compared the recommended standard by DWAF.

**Keywords:** groundwater, pH, electrical conductivity and turbidity

## Introduction

The investigation was conducted in the following villages: Tshikombani, Milaboni, Tshirenzheni, Mudunungu and Dopeni village, which form part of Ha-Tshivhasa area in Thulamela Local Municipality of Vhembe District in the Limpopo Province in South Africa. Ha-Tshivhasa areas are situated in the western part of Thohoyandou Central Business District (CBD). Ha-Tshivhasa areas drain water from several number of boreholes along the villages and also from dams around the area (see Figure 1). According to Loxton, *et al.*, (1969) Ha-Tshivhasa areas are underlain by Precambrian basalts of the Sibasa Formation of the Soutpansberg Group to the north and leucocratic biotite gneiss, leucocratic granite and pegmatite, grey biotite gneiss and migmatite of the Sand River Gneiss of the Central Zone of the Limpopo Belt to the south.

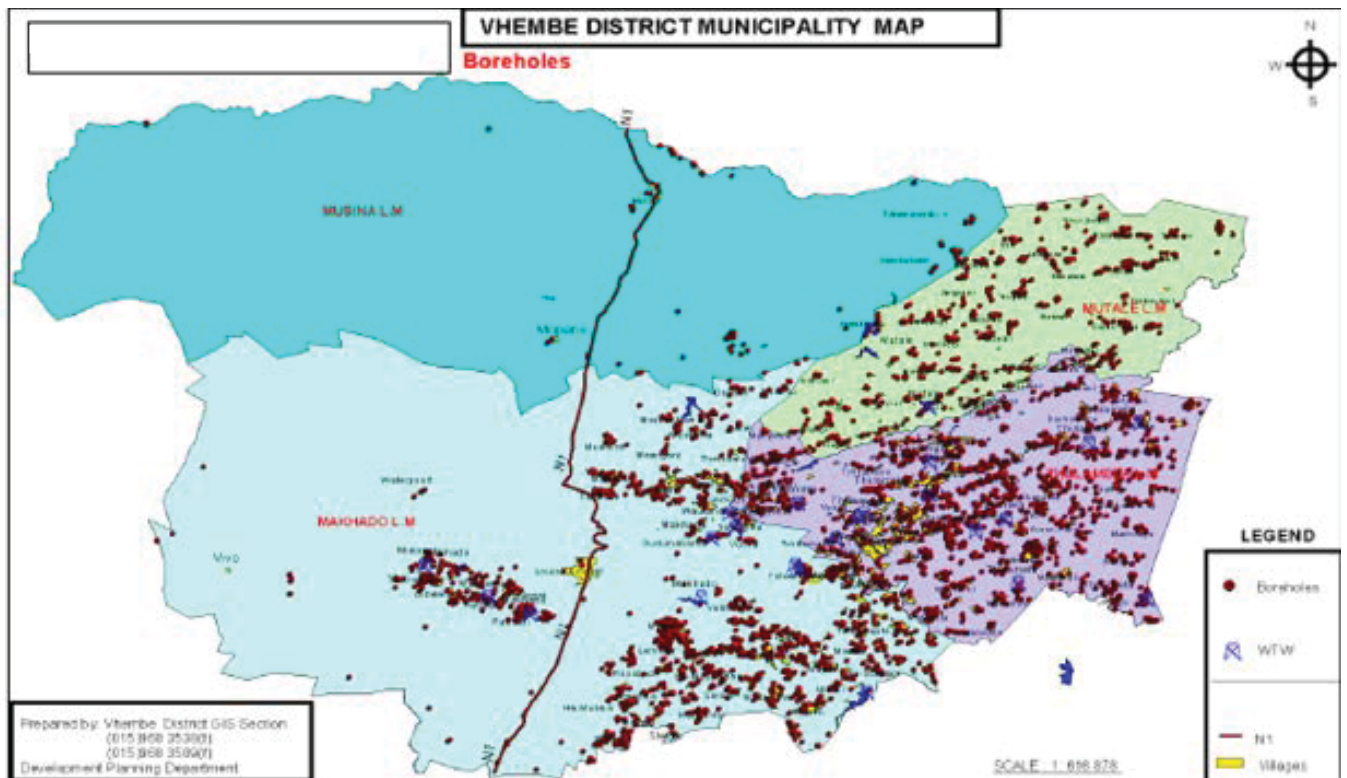


Figure 1: Vhembe district municipality map (Vhembe municipality, 2013).

## Previous studies on ground water quality

Groundwater is the water stored underground in rock fractures and pores that lay beneath the surface of the earth (AWA, 2007). Freeze and Cherry (1979) outlined that groundwater is considered to be the subsurface water that occurs beneath the water tables in soils and geologic formations that are fully saturated. The principal source of groundwater is meteoric water (precipitation from rain, snow and hail), juvenile water and connate water (Gleick, 1993). According to Chapman (1996) and BGS, (2001); groundwater is the most important component of the hydrological cycle, an important source of potable water in Africa and constitutes about two thirds of the freshwater resources of the world.

Sirila *et al.* (2010), pointed out that water aquifers are large in extent (1-10km) and have variations in physical and chemical properties at small scale (1-100m). This can cause a challenge in expecting transport from potential leakage source to the receptor. Transport of contaminants in soil is a major problem for different flow scales, from the fractured rocks to large underground aquifers (Hammon, 2011). The rate, residence time and direction of groundwater flow, the movement of micro-organism pathogenic bacteria and viruses depends on the size of the pores on reactions within media, on the amount of food available and on their life span which affects its quality (Sanden, 1986; Vladimir, 2003). Deep consolidated formations are characterized by slow groundwater movement, long residence time, ample opportunity for dissolution of minerals and therefore often poor natural water quality. These formations are confined under thick sequence of low permeability clays and are less vulnerable to anthropogenic influences (Chapman, 1996).

The quality of drinking water is typically determined by monitoring microbial presence especially faecal coliform bacteria, and physico-chemical properties (Gray, 1994 and USEPA, 1990). Faecal population assessment in water can be achieved by determining the number of faecal coliform that are present in the water sample.

Based on DWAF, 1996, Kempster *et al.*, 1997 and WHO, 2004, the water monitoring parameters are used to determine if the water is suitable for human consumption, recreation and other purposes such as agricultural use. Human activities such as agricultural activities, including fertilizing the soil and septic systems are the potential sources of groundwater pollution (Lyle and Raymond, 1998; Todd and Mays, 2005). According to McDonald and Kay, 1986, the analysis of physical parameters of ground water such as Turbidity, temperature, Total Dissolved Solids, odor and taste are the most important physical properties of groundwater in relation to its quality.

## **Methodology**

The groundwater quality properties such as pH, Electrical Conductivity (EC), Turbidity, temperature, TDS and salinity were measured in the field. The pH was measured using the pH meter, turbidity was measured using an electronic turbidity meter, while the electrical conductivity and temperature of the groundwater were determined using conductivity meter.

### *pH*

The pH of the water samples was measured by a digital pH meter. The measurements of the pH of the water were carried in the field and also in the laboratory. In the field, the pH meter electrodes were rinsed properly with distilled water after calibration. Then the glass electrodes were dipped into the beaker containing the water sample and it was stirred until the reading was stabilized at a certain point. At the laboratory, the samples were also measured, all the samples were measured in triplicate and the mean value were estimated.

### *EC*

The measurements of the EC of the water sample were carried in the field and also in the laboratory. At the field, the conductivity meter electrode was rinsed properly with distilled water after calibration. In the laboratory, the samples were measured in triplicate and the mean value were estimated.

### *Turbidity*



A clean dry beaker was rinsed three times with the water sample to be tested. The beaker was filled with the water sample to be analyzed and then covered with light shield cap. The outer surface of the beaker was wiped dry with a clean tissue paper. It was then pushed firmly into the optical well and the lid closed. The NTU values were measured by pressing and releasing the arrow and the value were recorded after the display has stopped flashing the turbidity meter.

#### *TDS and Salinity*

The TDS and salinity of the water sample were measured using a mutliprobe that is used to measure TDS and salinity (Exstik/ Extech instrument). The measurements of the TDS and salinity of the water were carried in the field and also at the laboratory. At the field, the TDS and salinity Exstik is rinsed properly with distilled water after calibration. At the laboratory, the sample were also measured in triplicate and the mean value were estimated.

#### *Geo-statistical Analysis*

All spatial data were analyzed in ArcGIS 10.2 software using ArcMap program. The spatial interpolation of water quality parameters employed in this study is the Inverse Distance Weighting (IDW) embedded in the Spatial Analyst extension. The IDW is a default method to generate a surface when attribute values are available at sample locations. IDW method is intended to modify the weights with information derived from the empirical data.

#### **Data collection**

Samples were collected once a month for a period of four months (that is from October 2015 to January 2016). Field measurements of pH, EC, TDS, and turbidity was measured using standard methods of analysis as prescribed by South African National Standards (SANS 241, 2006). A GPS will be used to locate the coordinates of the boreholes in the study area.

### **Results of the physical parameters of the groundwater in the study area**

#### **pH**

According to DWAF, 1996, pH is a measure of the hydrogen ion  $H^+$  within water. The pH of the water affects the solubility and availability of nutrients, and how they can be utilized by aquatic organisms. Chapman and Kimstach, 1996, pointed out that the acidity of groundwater is due to the presence of organic acids in the soil as well as those of atmospheric origin infiltrated to the water. The pH status of water is one of the most common parameter that need to be identified in order to understand the water quality of certain area, however according to DWAF standards of 1998, a minimum pH value of 6.5 to a maximum value of 8.5 is accepted, any values less or more than the recommended standard is required to be dangerous and toxic to use for domestic purpose.

The results from the study areas shows that 6.61 pH values was measured as the lowest of all boreholes while 8.26 pH values was measured to be the highest of all the boreholes. The results of the pH test is clearly illustrated by Figure 2, wherein red solid line indicate both maximum and minimum pH values recommended according DWAF standards. Looking at pH test of all the boreholes, it was then concluded that groundwater within these areas consist of pH values that are within the recommended standard, but that would not conclude the quality of water since there more parameters to be analyzed in order to conclude.

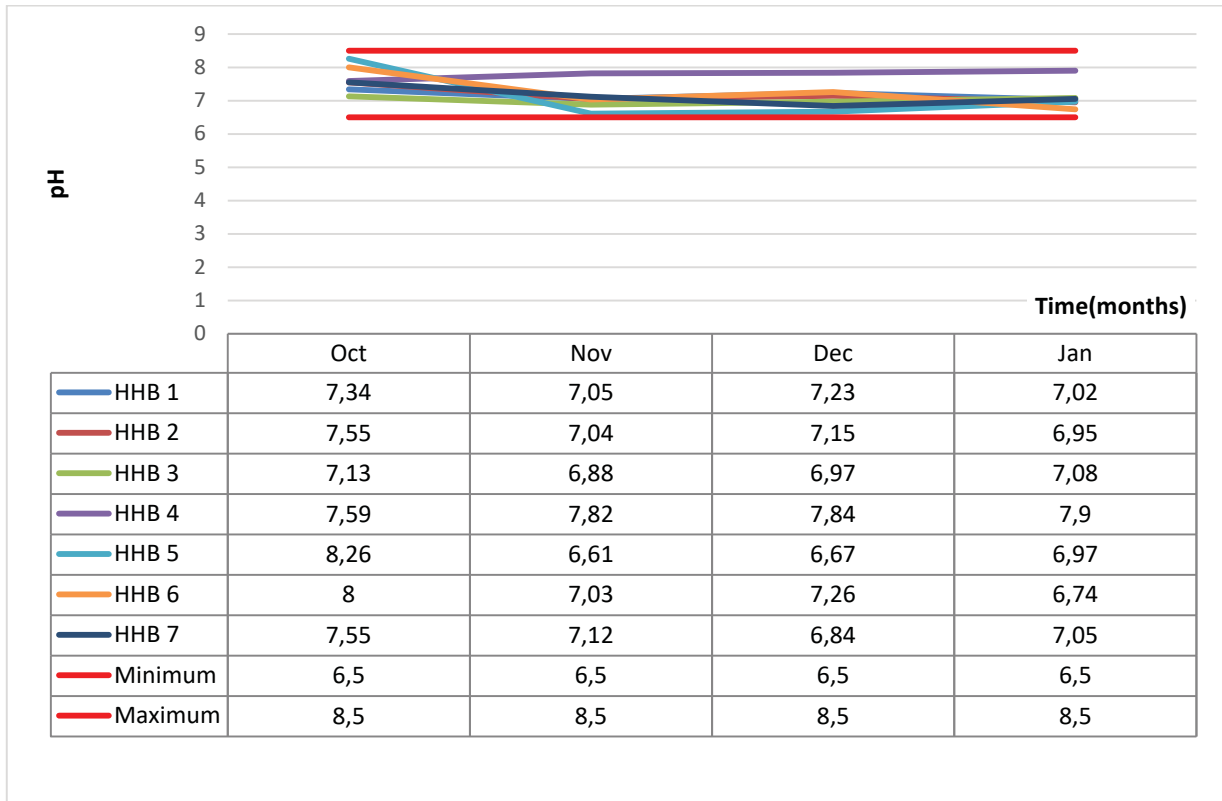


Figure 2: pH values for the boreholes in Ha-Tshivhase areas

During the four months of the investigation, spatial variation of the pH was carried out using ArcGIS 10.2 software. However, the spatial variation results were found to be similar to the results obtain using physical parameters (see Figure 3a-3d). Figure 3a-3d, illustrate results collected from the spatial variation of the pH within the seven boreholes in HA-Tshivhase areas. It was found that the pH values were ranging from minimum of 7.13 to the maximum of 8.26.

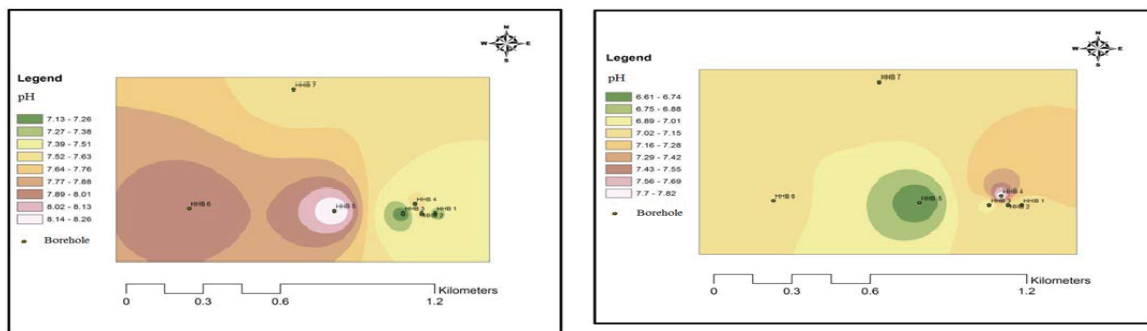


Figure 3 (a): Spatial variations for pH in the month of October 2015, (b) spatial variation for pH in the months of November 2015

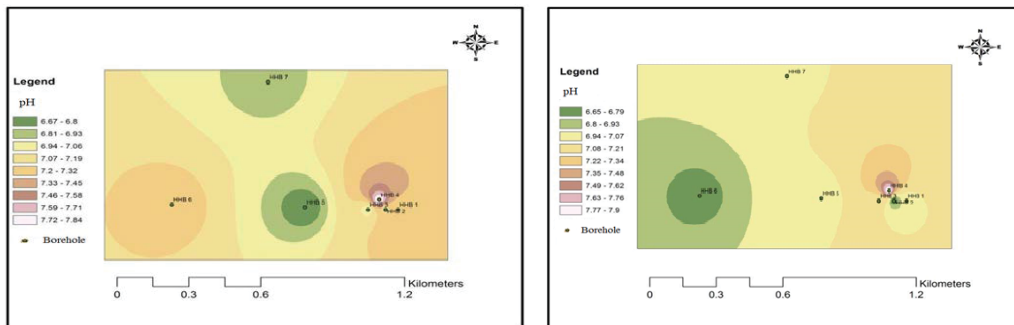


Figure 3 (c): Spatial variations of pH in the month of December 2016, (d) spatial variations of pH in the months of January 2016.

### Electrical Conductivity

Electrical conductivity (EC) is a measure of the ability of water to conduct an electrical current measured in  $\mu\text{S}/\text{cm}$ , this ability is a result of the presence of certain ions in water such as carbonate, bicarbonate, chloride, sulphate, nitrate, sodium, potassium, calcium and magnesium, all of which carry an electrical charge (DWAF, 1996a). If the electrical conductivity of water is high it indicates a high concentration of ions which then determines if such water is drinkable or not (Bruvold and Ongerth, 1969). The electrical conductivity of water depends on the water temperature: the higher the temperature, the higher the electrical conductivity would be (Cassidy *et al.*, 2001).

The electric conductivity of the groundwater of the study area was also analyzed and the results are illustrated in Figure 2, the EC values was found to range from 945  $\mu\text{S}/\text{cm}$  to 2350  $\mu\text{S}/\text{cm}$ . the EC values of the study area were found to higher as compared to recommended standard of < 700  $\mu\text{S}/\text{cm}$  by DWAF (1998). Figure 4 shows that the EC values were above the recommended standard throughout the four months (October 2015 to January 2016).

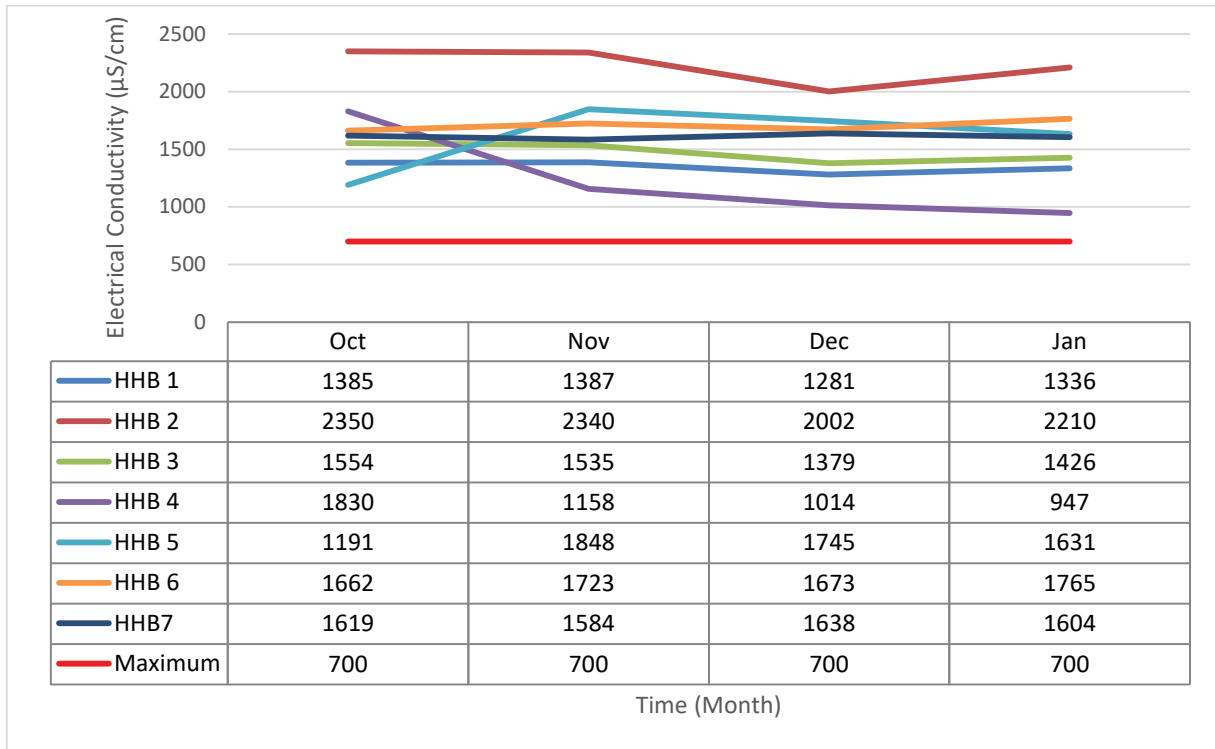


Figure 4: EC values for the boreholes in Ha-Tshivhase areas

The Electrical Conductivity of water is used as an indicator of how salt free or ion free the water sample is, the purer the water the lower the Electrical conductivity and the higher the resistivity. The spatial variation of the EC of the all the boreholes was also assessed, the EC different boreholes were found to be higher in different months as compared to the recommended standard of EC level by DWAF (see Figure 5a-5d).

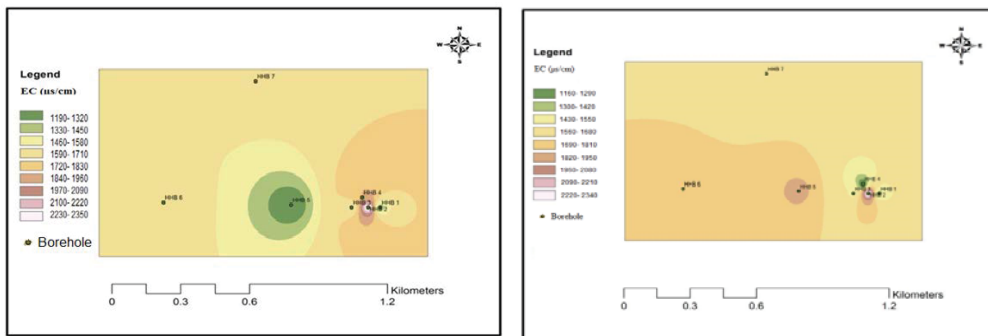


Figure 5(a): Spatial variation of EC in October 2015, (b) spatial variation of EC in November 2015.

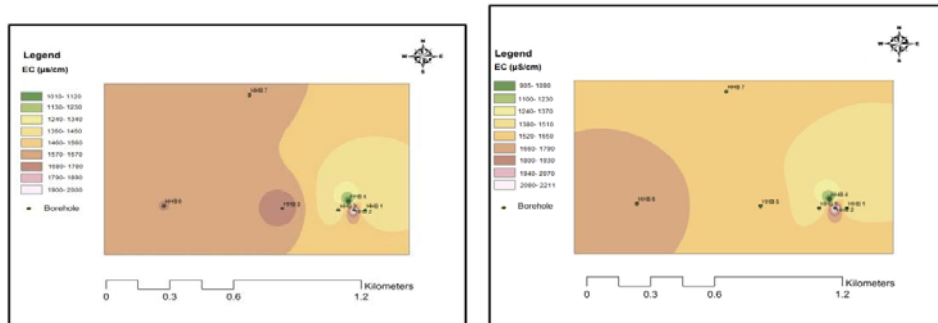


Figure 5(c): Spatial variations of EC in December 2015, (d) spatial variation of EC in January 2016.

### Salinity

Salinity of water samples is related to TDS concentration or electrical conductivity (Conrad *et al.* 1999). The occurrence of salinity in water and soil can be divided in two groups: primary salinity, where increase in salinity have occurred solely through natural processes; and secondary or induced salinity, where increase in salinity have occurred due to land use changes made by human activities (Smithson and Acworth, 2005; Omami, 2005). Salinity values of the study area was found to be ranging from 465ppm to 1120 ppm, however borehole HHB 4 was found to be within the recommended drinking guideline of less than 600ppm, while other boreholes (HHB 1, HHB 2, HHB 3, HHB 5, HHB 6 and HHB 7) were found to be exceeding the recommended maximum value according to DWAF guideline (see Figure 6). Durowoju, 2015, pointed out that the fluctuation in salinity value of water samples could be possibly be influenced by the high temperature leading to more dissolution of minerals in groundwater.

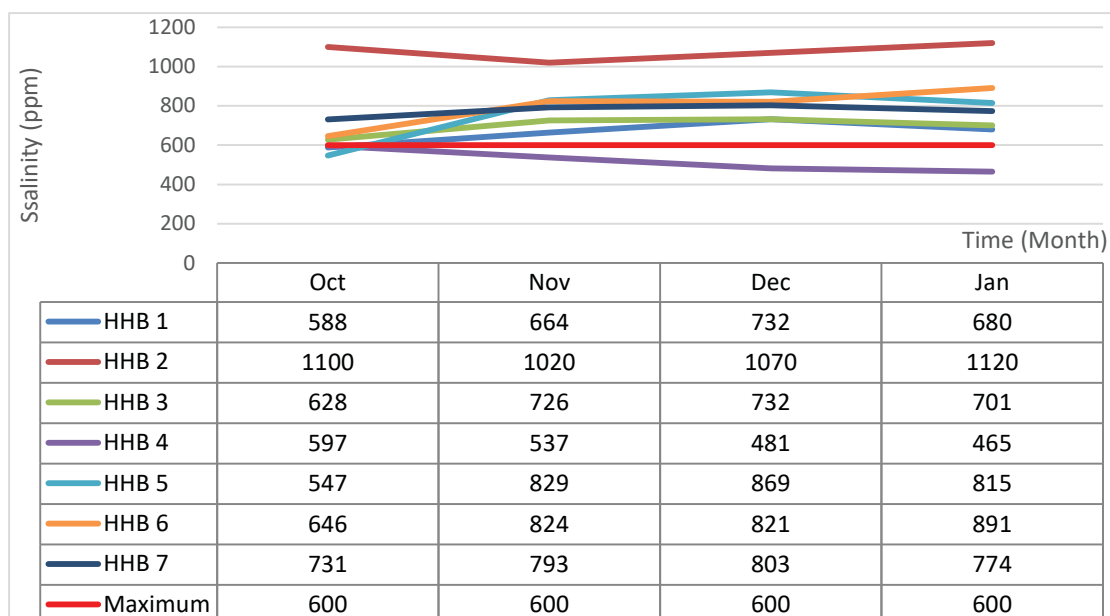


Figure 6: Salinity values for the borehole in Ha-Tshivhase areas

Figures 7 (a – d) shows the spatial variations of salinity in the study, in October 2015 most of the boreholes were associated with low to moderate salinity level as compared to recommended salinity values, however as the analysis progress from October to January there was an increase in salinity level (see Figure 7a-7d). High salinity in water can also be influence by high concentration of ions and dissolved minerals in the water. Salinity can occur naturally when drainage is poor or in areas with low rainfall and high evaporation, in this case the study area receives low rainfall.

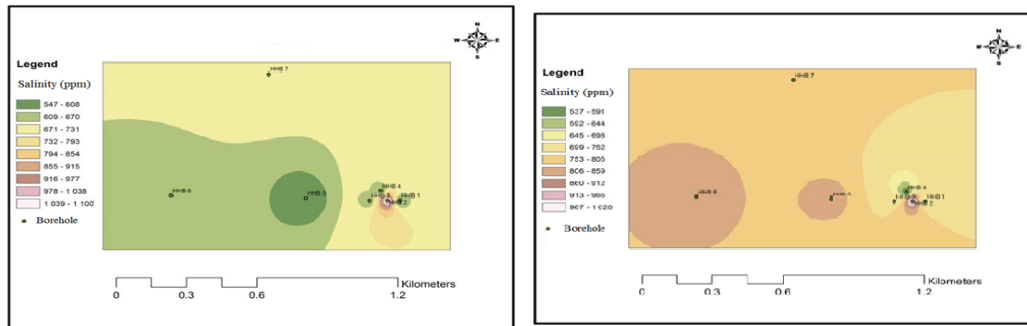


Figure 7 (a): Spatial variations of salinity in October 2015, (b) spatial variation in November 2015.

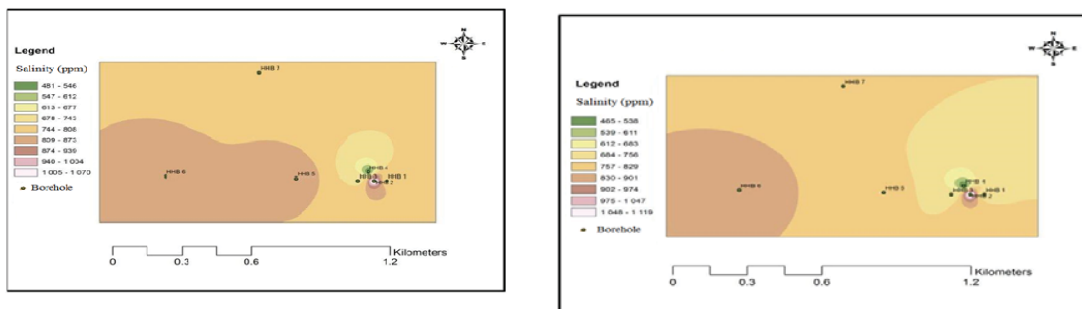


Figure 7 (c) Spatial variations of Salinity in November 2016, (d) spatial variation of salinity in January 2016.

### Total Dissolved Solids (TDS)

Total Dissolved Solids (TDS) is defined as the concentration of all dissolved minerals in the water (Agbaire and Oyibo, 2009). TDS in groundwater are due to minerals from acids produced as byproducts of the degradation process, hence TDS is a geochemical parameter that closely links the bulk conductivity to microbial degradation of hydrocarbon (Atekwanna *et al.*, 2004). TDS can be measured by automated meters or the gravimetric method. The TDS is directly proportional to the EC of water. Since EC is much easier to measure than TDS, it is routinely used as an estimate of the TDS concentration (DWAf, 1996b).

Figure 4.3 indicates TDS of the samples for four months from October 2015 to January 2016, the TDS values found to range from 701 mg/l to 1790 mg/l. according to DWAf standards of 1998, the maximum recommended that for TDS is 1000 mg/l. Looking at Figure 8, it is clearly shown that most of the boreholes were found to have high TDS values as compared to DWAf standards,



although the TDS at HHB1 was found to comply but in average the boreholes within the study area was consist of high TDS.

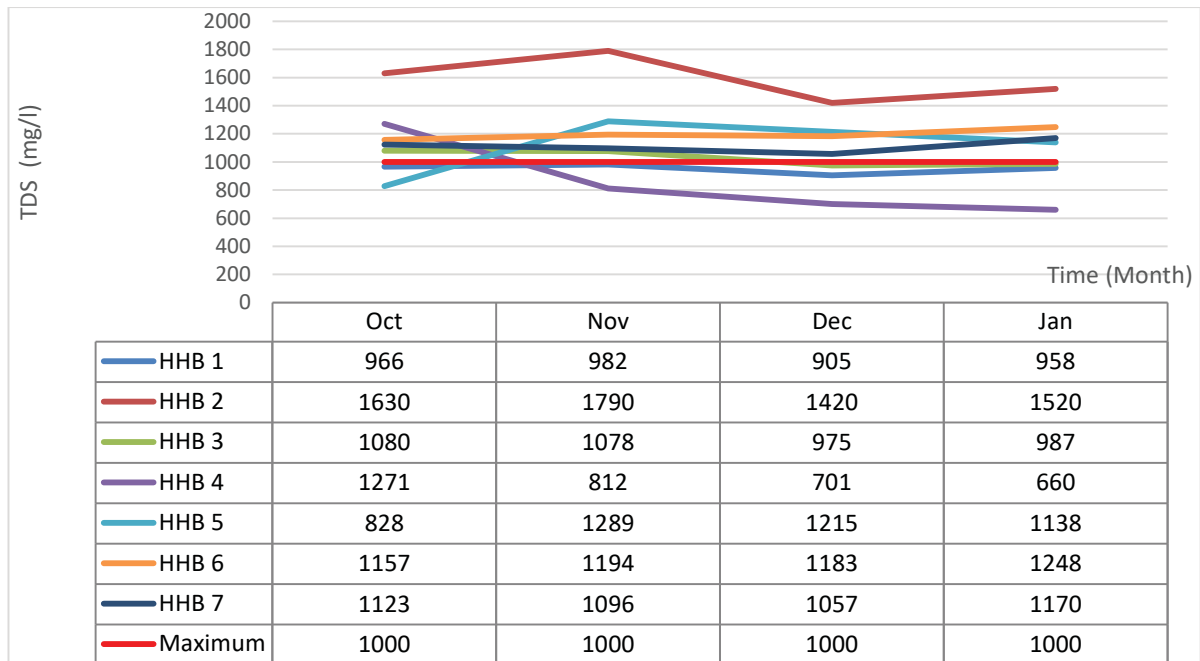


Figure 8: TDS values for the borehole in Ha-Tshivhase areas

### Turbidity

Turbidity is the measure of clarity in water, turbidity is measured using Nephelometric Turbidity Units (NTU) (Water Quality Monitoring, 1996). Turbidity which can make water appear cloudy or muddy, is caused by the presence of suspended and dissolved matter, such as clay, silt, finely divided organic matter, plankton and other microscopic organisms, organic acids and dyes (ASTM International, 2003). The colour of water, whether resulting from dissolved compounds or suspended particles can affect a turbidity measurements.

Figure 4.4: shows the turbidity values found for the boreholes in Ha-Tshivhasa areas. The turbidity values was found to range from 0.01 NTU to 0.57 NTU (see Figure 9). However, the turbidity of the study area was found to be acceptable since it was within the recommended turbidity by DWAF, which ranged from 1-5 NTU. Boreholes HHB 1-HHB7 in October 2015 were found to contain turbidity values that range from 0.01NTU to 0.09NTU, in November 2015 boreholes were found to have a turbidity values that ranged from 0.01NTU to 0.15NTU, in December 2015 the turbidity of the investigated boreholes were found to range from 0.33NTU to 0.57NTU and lastly in January 2016 the turbidity values of the investigated boreholes were found to range from 0.2NTU To 0.4NTU.

Based on the results found, it was clearly shown that the turbidity of the study area in December 2015 was relatively higher as compared to other months, although it was higher; it was considered to be less as per recommended values by DWAF. However these clearly tells us that the groundwater within the study area was containing less microbiological contamination.

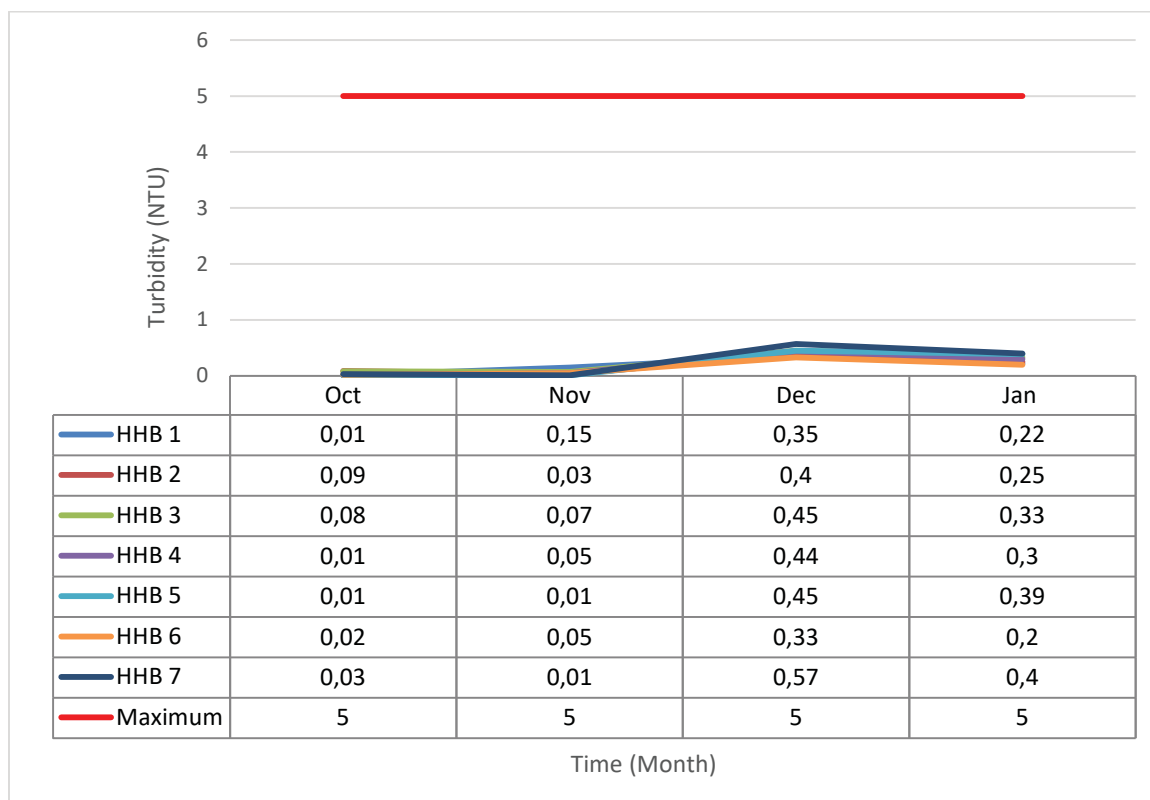


Figure 10: Turbidity values for the borehole in Ha-Tshivhase areas

## Discussion

After detailed analysis of the water quality parameters (pH, EC, TDS, Turbidity and Salinity) of groundwater at Ha-Tshivhase areas, the pH values for the boreholes monitored from October 2015 to January 2016 were found to range from the minimum 6.61 to maximum of 8.26.

The turbidity of all boreholes were found to range from the minimum of 0.01 NTU to the maximum of 0.57 NTU. The turbidity of all the boreholes were found to be within the recommended standard, which is between 1-5 NTU. According to WHO (2004) water quality standards, water (surface/ground) with turbidity of less than 1 NTU is recommended for preparation of food and for drinking, however turbidity only cannot be used to conclude the quality of water for drinking purpose or food preparation it is advisable to boil such water before drinking as way of killing bacterial and other contaminations.

The salinity of boreholes were found to range from the minimum of 465 ppm to the maximum of 1120 ppm, however the majority of the boreholes were found to be highly salinity as compared to the recommended standard. The EC of the boreholes were ranging from 947  $\mu\text{S}/\text{cm}$  to 2350  $\mu\text{S}/\text{cm}$ , the EC of all the boreholes were then found to be exceeding the recommended standards which is less than 700  $\mu\text{S}/\text{cm}$ . Lastly, the TDS of boreholes were found to range from 701 mg/l to 1790 mg/l, however majority of the boreholes in different months were found to exceed the recommended standard by DWAF.

## Conclusion

An assessment of groundwater quality for domestic consumption was evaluated by comparing the physical parameter and spatial variation of the groundwater within the study areas and the prescribed standards by DWAF.). The pH values for all the boreholes were found to be within the recommended guideline, ranging from slightly acidic to alkaline. Turbidity of the boreholes within the study area was also found to be within the recommended standard, with values that ranged between 0.01 NTU to 0.57 NTU. While the average EC, TDS and Salinity values were found to be above the recommended guideline, which clearly tells us that the groundwater is slightly salty. It was then concluded that groundwater in the study area is not suitable for domestic use but it can be used for agricultural purpose.

### **Acknowledgement**

Authors would like to acknowledge the University of Venda, Ms Matsie Shai and Ha-Tshivhasa Villagers for facilitating the research and for their support in the research.

### **References**

- Agbaire, P.O and Oyibo, P.I. (2009). Seasonal variation of some Physico-chemical properties of borehole water in Abraka, Nigeria. *African Journal of Pure and Applied Chemistry*, 3 (6), 116-118.
- ASTM International, (2003). D1889-00 Standard test method for turbidity of water, in ASTM-International, Annual Book of ASTM Standards, Water and Environmental Technology, 2003, V.11.01, West Conshohocken, Pennsylvania, 6p.
- Atekwana, E.A., Estella, A.A., Rebecca S.R. (2004). The relationship of Total Dissolved Solids measurements to bulk electrical conductivity in an aquifer contaminated with hydrocarbon. University of Missouri-Rolla. USA.
- AWA (2007). Water in Australia: Facts and Figures, Myths and Ideas. Australian Water Association, Sydney. [http://www.awa.asn.au/AM/Template.cfm?Section=Water\\_in\\_Australia](http://www.awa.asn.au/AM/Template.cfm?Section=Water_in_Australia)
- Bruvold, W.H and Ongerth, H.J. (1969). Taste Quality of Mineralized Water. *Journal of American Water Works Association*, 61, 120.
- Cassidy, D.P., Werkema, D.D., Sauck, W.A., Atekwana, E.A., Rossbach S. and Duris, J. (2001). The effect of LNAPL biodegradable products on electrical conductivity measurement. *Journal of Environment, Engineering and Geophysics*, 6, 47-52.
- Chapman, D. (1996). Water Quality Assessments. A guide to use biota, sediments and water in environmental monitoring, Second Edition. University Press, Cambridge.
- Chapman, D. and V. Kimstach, (1996). Selection of Water Quality Variables. Water Quality Assessments: A Guide to the use of Biota, Sediments and Water in Environmental Monitoring. Chapman edition, 2<sup>nd</sup> Edn. E & FN Spon, London, pp: 595..
- DWAF, (1996b). *South African Water Quality Guidelines* (second edition) Volume 1. Domestic use.
- DWAF, (1998). Quality of Domestic Water Supplies Assessment Guide, Volume 1: WRC Report No: TT.101/98, pp.101.
- Freeze, R.A. and Cherry, J.A. (1979). Groundwater, Prentice-Hall, Englewood Cliffs.

- Gleick, P.H. (1993). *Water in Crisis. A guide to the World's Fresh Water Resources*. Pacific Institute for studies in Development, Environment and Security Stockholm Environment Institute.
- Gray, N.F. (1994). *Drinking Water Quality, Problems and Solutions*. John Wiley and Sons Ltd, England.
- Hammon, H. Ginzbury, I. Boulter, M. (2011). Two relaxation-times Lattice Boltzmann Schemes for solute transport in unsaturated water flow, with a focus on stability, *Advances in water Resources* 34(2011) 779-793.
- Kempster, P.L., Van Vliet H.R and Kuhn, A. (1997). The need for guidelines to bridge the gap between ideal drinking water quality and that quality which is practically available and acceptable *Water SA*, 23(2), 167-169.
- Kirsh, R. (2008). *Groundwater geophysics: A tool for hydrogeophysics*. Springer Science and Business Media (Illustrated Version), pages 568.
- Loxton, Hunting and Associates, (1969). Natural resources survey of Venda land. Confid. Rep. TS 32/68, for Dep. Bantu Admin, Devel. S. Afr.
- Lyle, S. and Raymond J.R. (1998). Groundwater contamination, *Bulletin. Water SA*, 2, 3.
- Todd, D.K and Mays, L.W. (2005). Pollution of groundwater. In: *Groundwater hydrology*. Jennifer WV, Vergas A, Jennifer P, dawn LS, Kulesa T, Levy D and Morris. Argosy publishing, Texas (Chapter8), 361-366.
- McDonald, A.T and Kay, D. (1986). *Water Resources Issues and Strategies*. No.3 (393-404).
- Murray R., Baker K., Revenscroft P., Musekiwa C. and Dennis R. (2012). *Water Research Commission Report No. 1763/1/11*, Pretoria, South Africa.
- Omami, E.N. (2005). *Response of Amaranth to salinity stress*. PhD thesis. University of Pretoria.
- Sanden, P., Bergstrom, S., and Gardelin, M. (1986). *Modelling Groundwater Levels and Quality*. SMHI, 601 76 Norrkoping.
- Smithson, A and Acworth, R.I (2005). *An investigation of unconsolidated sedimentary units and their role in the development of salinity in the Snake Gully Catchment, Central New South Wales*. The University of New South Wales Water Research Laboratory, research report No 214.
- Sirila, E.R., Maxwell, R.M., Nacarre-Sitchler, A.K. and McCray, J.E. (2010). *A quantitative methodology to assess the risks to human health from carbon dioxide leakage into ground water*. *Advwater resource*.
- Sverjensky, D.A. (1986). *Genesis of Mississippi Valley-type lead-zinc deposits: Annual Review of Earth and Planetary Sciences*, v. 14, p. 177-199.
- US Environmental Protection Agency, (1990). *Groundwater, Volume 1: Groundwater and Contamination*, EPA/ 625/6- 90/ 0160, Center for Environmental Research Information, Cincinnati, Ohio.
- WHO (2004) *Guidelines for Drinking Water Quality: Recommendation, Volume1, 3rd edition* World Health Organisation, Geneva.
- Vladimir N. (2003). *Water Quality, Diffuse pollution and watershed management*. Second Edition. John Wiley and sons, Inc. Boston.

### Small water / wastewater / sludge treatment and reuse

**269- Sustainable Water and Wastewater Treatment in Rural Scotland Using The Arvia™ Process**

NABEERASOOL Akmez - *Arvia™ Technology*

**310 - Wastewater treatment by vermifiltration - Comparison of effluent quality and earthworm population for various substrates**

DUARTE Natalia - *Universidade Estadual de Campinas (UNICAMP)*

**338 - Modular green façade elements built from construction and demolition waste to treat storm- and greywater**

KISSER Johannes - *Alchemia-nova GmbH*

**447 - Feasibility study of small anaerobic-co-digestion in urban district level**

BAUTISTA Jean-Romain - *CSTB-GEPEA*

**469 - Development and validation of performance evaluation protocol for small wastewater treatment MBR systems**

KULESHA Olga - *Norwegian University of Life Sciences*

**472 - Vermifilter as a compact and simplified unit for decentralized sewage treatment systems**

MADRID Francisco - *School of Civil Engineering, Architecture and Urban Design, State University of Campinas*

**492 - Phosphorous removal by apatite filters: lessons learned by full scale systems and a new apatite generation**

DELGADO GONZALEZ Laura - *IRSTEA*

**494 - Energy production from xylose by *Thermoanaerobacterium calidifontis* IS1 isolated from sludge of wastewater treatment**

SILVA Vanessa - *Universidade de São Paulo*

**515 - Influence of hydraulic retention time on the removal and removal kinetics of antibiotics Sulfamethoxazole and Ciprofloxacin in an anaerobic packed bed reactor**

CARNEIRO Rodrigo - *Universidade de São Paulo*

**541 - Influence of nutrients and pH on the efficiency of vertical flow constructed wetlands treating winery wastewater**

SOTO Manuel - *University of A Coruña*

**699 - Metagenomic 16S rRNA analysis of wastewater from a freshwater fish farm**

MAKINO Ikuyo - *Tohoku university*

**716 - Novel materials for catalytic ozonation of wastewater for disinfection and removal of micropollutants**

KOLOSOV Petr - *McGill University*

**722 - Development and validation of performance evaluation protocol for small wastewater treatment MBR systems**

KULESHA Olga - *Norwegian University of Life Sciences*

**726 - Decontamination of urban wastewater loaded with psychoactive drugs via photocatalytic processes**

TSOUMACHIDOU Sophia - *Laboratory of Physical Chemistry, University of Thessaloniki*

### Terra Preta sanitation

**648 - Pilot scale testing of the use and production of Terra Preta and other soil improving products like Phosphate Rich Organic Manure for increased agricultural productivity**

MUTNURI Srikanth - *Birla Institute of Technology and Science*

# Sustainable Water and Wastewater Treatment in Rural Scotland Using The

## Arvia™ Process

Nabeerasool, A.<sup>1</sup>, Massaros, M.<sup>1</sup>, Brown, N.<sup>1</sup>, D. Sanderson<sup>1</sup>, Thompson, C. <sup>1</sup>, Lodge, M.<sup>1</sup>, Khan, M.<sup>1</sup>

<sup>1</sup> Arvia™ Technology, The Heath Business and Technical Park, Runcorn Cheshire WA7 4EB, UK

**Keywords:** Arvia™ Process, Adsorption, Electrochemical regeneration

### Introduction

The provision of clean and safe drinking water is of paramount importance and is a basic human need. Water scarcity coupled with tightening of regulations means that alternative treatment technologies that are viable and cost effective are required to address the failures of current treatment technologies in order to meet demand and regulations for clean water supplies.

Logistically, the application of water treatment in rural areas presents unique challenges. The first of these is due to the decentralisation of abstraction points arising from low population density and the resultant lack of infrastructure, which can make it costly to centralise treatment facilities and hence provide potable water direct to the consumer. The second main challenge arises from the need to treat water at the site of use. According to the Scottish government, around 150,000 people in Scotland rely on a private water supply (Gov.scot, 2015), which means that the owner or user(s) of these supplies, which can serve one household to hundreds, are responsible for the maintenance rather than Scottish Water. As such it is imperative that a suitable technological solution to private water treatment is employed, as the quality of the water derived from these supplies is highly variable.

Arvia™ Technology Ltd. has trialled the application of its tertiary water treatment technology in treating reservoir water abstracted near Glasgow, Scotland, and has demonstrated promising results, despite the conditions of low water quality and a lack of pre-treatment. It has been reasoned that the application of the technology as part of a multi-component array, including ceramic mesh filters and an ion-exchange resin, would enable the system to be run continuously over long periods of time, with low day-to-day maintenance and operating cost.

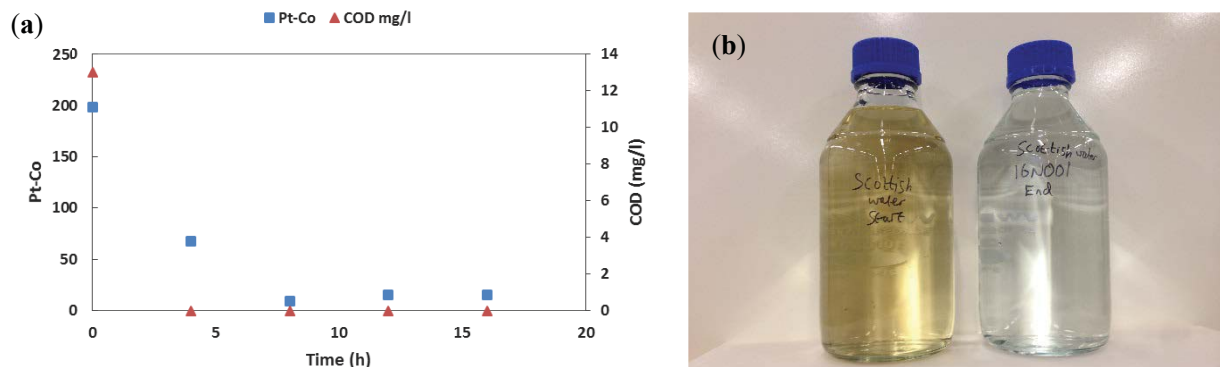
### Materials and Methods

Arvia's patented advanced oxidation technology combines the advantages of adsorption and electrochemical regeneration within a single unit; the Organic Destruction Cell (ODC). The ODC uniquely uses a combination of adsorption and electrochemical regeneration to destroy organics. Key to this innovative process is an alternative approach to adsorption. The conventional approach is to use high capacity adsorbents (e.g. activated carbons with high porosities and surface areas) that are excellent adsorbents, but require complex and costly regeneration. Arvia's technology uses a patent protected adsorbent, Nyex™, which is a non-porous, highly conducting, graphite based adsorbent material that enables it to act as both the adsorbent and as a 3D electrode. Its non-porous nature means kinetics during adsorption and regeneration are extremely fast and can be repeated many times a day in-situ. This benefit greatly outweighs the lower relative adsorptive capacity of Nyex (Brown, 2004), thus the process requires a significantly lower mass of adsorbent than those using activated carbon,



enabling a lower comparative footprint and overall CAPEX. The high conductivity of the Nyex™ means that it operates at low cell voltage to produce a chemical free, waste-free, cost and energy efficient process. Contaminant organics are adsorbed onto the Nyex™ surface and a low voltage electric current proportional to the organic concentration is passed through the Nyex™. Adsorbed organics are oxidised and the surface of the Nyex™ is regenerated in-situ for further adsorption without interruption or replacement. Treated water flows from the bottom of the cell where it can either be re-used or safely discharged (video of the process <http://bit.ly/1QMAc5A>, Arvia™ Technology Ltd., 2017). One variation of our unit was used for this first phase of trials, the ODC1-20, comprising of a single electrochemical cell (400 cm<sup>2</sup> in size).

## Results and Discussion



**Figure 1:** (a) Chemical Oxygen Demand (COD) and Colour (Pt-Co; apparent) removal for the treatment of a live Scottish Water raw water. (b) Sample of Raw water before and after treatment

As shown in figure 1, complete colour removal was achieved in combination with COD removal to meet target level within 8 hours of treatment. COD fractionation tests on the treated samples were performed by Scottish Water to determine the nature of the COD fractions removed by the Arvia™ process. Results show that the Arvia™ process removed 90% of the hydrophobic material in the water which are often the biggest contributors to THM formation.

The engagement with Scottish Water has progressed to the next stage with the deployment of a pilot plant at a Scottish Water treatment site as a direct replacement for GAC. The set-up is part of a multi-treatment array, involving a bespoke Arvia™ ODC unit (consisting 22 cells, 1m<sup>2</sup> in size), an ion-exchange treatment and a ceramic filter to remove any particulate matter or biological contaminants such as cryptosporidium. Further evaluation of the Arvia™ system as a standalone treatment system is also planned. Arvia™ is also actively developing a novel under the sink treatment unit that is targeted at remote, point of use local treatment.

## References

- Gov.scot. 'Private water supplies in Scotland'. World Wide Web address. Available at: <http://www.gov.scot/Topics/Environment/Water/17670/pws> [Accessed 24/01/2017].
- Arvia Technology Ltd. 'Product – Arvia Organics Destruction Cell'. World Wide Web address. Available at: <http://www.arviatechnology.com/product/> [Accessed 24/01/2017].
- Brown, N.W., E.P.L. Roberts, A.A. Garforth and R.A.W. Dryfe (2004). Electrochemical regeneration of a carbon based adsorbent loaded with crystal violet dye. *Electrochimica Acta* Vol 49, p3269-3281

# Wastewater treatment by vermifiltration – Comparison of effluent quality and earthworm population for various substrates

Ref # S2SMALL-15502

N. C. Duarte<sup>1</sup>, A. F. Leopoldino<sup>2</sup>, F. J. P. L. Madrid<sup>1</sup>, J. Schneider<sup>1</sup>, A. L. Tonetti<sup>1\*</sup>

<sup>1</sup> School of Civil Engineering, Architecture and Urban Design – FEC, Sanitation and Environment Dept., State University of Campinas – UNICAMP, PO Box 6021, 13083-889 Campinas (SP) Brazil.

<sup>2</sup> School of Technology – FT, State University of Campinas – UNICAMP, 13484-332 Limeira (SP) Brazil.

\* Presenting Author: [adriano@fec.unicamp.br](mailto:adriano@fec.unicamp.br)

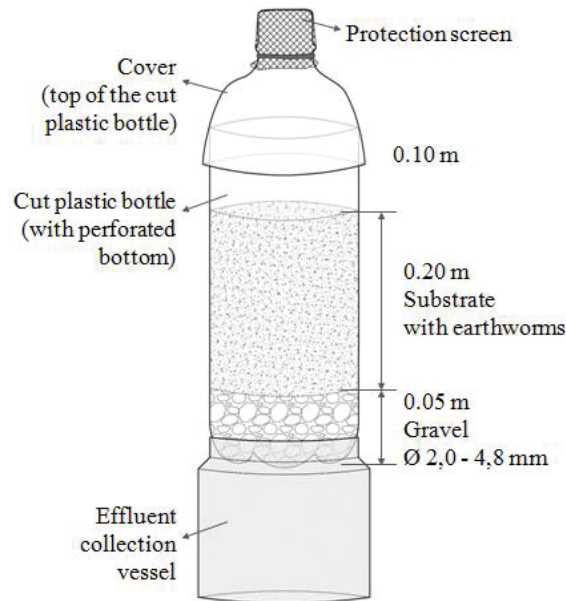
**Keywords:** *Eisenia Andrei*; lumbrifiltration; sewage treatment; vermifiltration; wastewater treatment;

## INTRODUCTION / MAIN METHIODES

The lack of adequate sanitation facilities affects 32% of world's population, 70% of which lives in rural areas (WHO, UNICEF, 2015), where wastewater collecting systems are often not available. Low cost and effective options for decentralized wastewater treatment are then urgently necessary. Vermifilters are capable of removing chemical and biological pollutants through earthworms and their interactions with microorganisms (LIU et al., 2012), offering a cheap and feasible solution. This study analysed vermifiltration performance regarding leachate volume, pH, total alkalinity, conductivity and turbidity for five different substrates, as well as earthworms' final population numbers, comparing it to identical treatments without earthworms, aiming to determine the best substrate for an effective vermifilter treatment.

Each vermifilter consisted of a 1.5 L plastic bottle filled with 5 cm gravel and one substrate, as shown in Figure 1. Layers were similar to those used by Madrid (2016), and five different substrates were used, as shown in Table 1. For each substrate, there were 3 vermifilters containing 10 earthworms (*Eisenia andrei*) each and 3 without worms, in a total of 30 vermifilters. Soil was collected at Unicamp and dried, sieved and autoclaved. Sewage applications occurred once a day and, subsequently, treated effluent volumes were measured. Once a month, samples of raw sewage and treated effluents of each vermifilter were analysed for pH, total alkalinity, conductivity and turbidity, according to Standard Methods for the Examination of Water and Wastewater (2012). After approximately 16 weeks, the experiment was disassembled and earthworms in each vermifilter were counted.

Data were subjected to variance analyses (ANOVA) and media tests (Scott-Knott, 5%) by statistic program SISVAR.

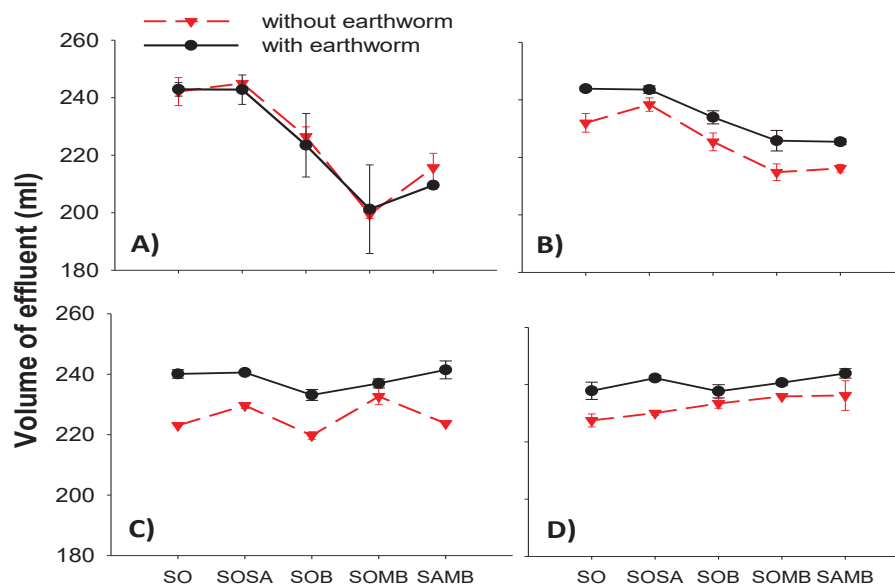


**Figure 1.** Filters schematic cross section.

## MAIN RESULTS AND CONCLUSIONS

Vermifilters containing milled *Brachiaria* retained more wastewater (Figure 2). At first there was no difference between units with or without worms, but after 30 days all vermifilters with earthworms showed lower retention and higher turbidity (Table 1), probably due to mobility of worms in the substrate, which created pathways for filtration.

Effluent quality was better in SAMB systems and earthworms showed to be more adapted to substrates containing vegetable material, increasing in population in those where *Brachiaria* was introduced.



**Figure 2.** Temporal evolution of treated effluent in vermifilters containing different substrates at A) 0 days; B) 30 days; C) 60 days and D) 90 days of application of raw sewage in vermifilters. Vertical bars represent the standard deviation;  $n = 3$ .

**Table 1.** Summary of results.

Abbreviation	Substrate	Presence of earthworms	pH	Total alkalinity (mg CaCO <sub>3</sub> L <sup>-1</sup> )	Conductivity (µS/cm)	Turbidity (uT)
RS	Raw Sewage	*	7.47±0.35	308.2±56.2	1102±270	248±132
SO	Soil	No	7.33±0.17	191.0±9.6	1008±131	708±413
		Yes	7.41±0.32	212.9±23.4	1048±128	1070±204
SOSA	Soil + Sand	No	7.29±0.17	167.4±17.2	989±100	384±252
		Yes	7.46±0.24	192.5±21.4	972±93	765±216
SOB	Soil + <i>Brachiaria</i>	No	7.54±0.23	266.1±18.4	1180±157	369±48
		Yes	7.47±0.35	239.2±30.7	1212±185	476±34
SOMB	Soil + milled <i>Brachiaria</i>	No	7.61±0.18	276.6±24.2	1105±116	406±255
		Yes	7.50±0.21	258.4±13.5	1111±135	644±411
SAMB	Sand + milled <i>Brachiaria</i>	No	7.44±0.27	238.6±34.5	1064±76	134±99
		Yes	7.18±0.39	169.3±41.2	1121±166	179±98

\* Raw Sewage parameters at the time of application in vermifilters.

## ACKNOWLEDGEMENTS

The authors would like to thank FAPESP (São Paulo Research Foundation, process 2011/21919-7) for financing this study.

## REFERENCES

- Liu, J., Lu, Z., Yang, J., Xing, M., Yu, F., Guo, M., 2012 Effect of earthworms on the performance and microbial communities of excess sludge treatment process in vermifilter. *Bioresource Technology* 117, 214–221.
- Madrid, F. J. P. L. 2016 *Aplicação da vermifiltração no tratamento de esgoto sanitário (Application of vermifiltration in sanitary sewage treatment)*. Master thesis. FEC. Unicamp. Campinas. Brazil.
- Standard Methods for the Examination of Water and Wastewater* 2012 22nd edn. American Public Health Association/American Water Works Association/Water Environment Federation. Washington DC. USA.
- WHO. UNICEF. 2015 Progress on sanitation and drinking water–2015 update and MDG assessment. [https://www.unicef.org/publications/index\\_82419.html](https://www.unicef.org/publications/index_82419.html) (accessed 12 July 2017).

## **Modular green façade elements built from construction and demolition waste to treat storm- and greywater**

**Klsser, J.<sup>1</sup>, Zehetbauer C.<sup>1</sup>, Reinberg V.<sup>1</sup>**

<sup>1</sup> alchemia-nova GmbH, institute for innovative phytochemistry & closed loop processes, Baumgartenstrasse 93, 1140 Vienna, Austria

**Keywords:** urban green infrastructure, grey and stormwater treatment, construction and demolition waste

### **Introduction**

The aim of the H2020-project Green INSTRUCT (grant agreement no. 723825) is to design a prefabricated, modular and multi-layered building block made of over 70 % of construction and demolition waste (CDW). This panel should be suitable for new construction as well as for retrofitting projects. A core feature of this innovative panel is the incorporation of an outdoor geopolymer-based vertical green infrastructure (GI) layer equipped with an aquiferous system to purify grey- and stormwater. Generally, the basic green façade contributes to the improvement of the urban environment and public/social health through CO<sub>2</sub> reduction, microclimatic benefits, increased biodiversity, aesthetic aspects, and additional acoustic as well as thermal insulation. Furthermore, the GI integrates a rhizodegradation-based grey- and stormwater purification unit partly based upon the previously invented VertECO<sup>®</sup> system (alchemia-nova GmbH 2017; Zraunig et al. 2015). The innovation will contribute to significant savings of potable water by recycling non-faecal household, office or public building wastewaters. Between 60 l and 130 l greywater are produced per person/day through usage of showers, baths and hand basins (Environment Agency 2011). Including contaminated water from washing machines and kitchen sinks higher values are possible. Together with the climate-specific stormwater discharges, these recycled waters can consequently be used for toilet flushing, irrigation, groundwater recharge and laundry (demEAUmed project 2014). The panel's outer layer, a geopolymer based on CDW, holds the plants in substrate-filled channels. The channels are then fed with collected grey- and stormwater from the respective building. The adjustable vertical water flow set-up is designed to purify the water within several of these vertically arranged panels according to building specific contamination rates.

### **Material and Methods**

The panel is roughly dividable into an internal and external panel held together with an aluminium frame. While the internal panel integrates a PU foam and MOC (magnesium oxychloride cement) layer, the external panel comprises a CDW-based reinforced geopolymer layer providing the green wall installation. The geopolymer matrix applies CDW, including clay, wood, glass bricks gypsum and tiles. Various CDW/mixtures and extruding techniques are tested for their plant growing suitability. The pH-value of the geopolymer needs to be adapted to around 6 for proper plant and biofilm development. For lab experiments a test layer of 300 mm length, 1000 mm width and 80 mm depth with four vertical elliptic channels with a cross-sectional area of 31.4 cm<sup>2</sup> is extruded. Inclining drill holes (1 cm diameter and in 10 cm

vertical and 13 cm horizontal intervals) on the front side serve as planting openings (see fig. 1), in. The channels are filled with various test substrates (e.g. expanded clay, perlite, etc.) to find a stable material also supportive of root growth.

Plants are selected primarily for advantageous root architecture and climatic conditions (e.g. precipitation, evaporation, temperature range, etc.) to support the stable development of a biofilm. Hardy evergreen plants like graminoids, sub-shrubs or herbaceous perennials for temperate regions have proven to work well on cascading systems. The plants are inserted via the front-sided drill holes.



**Figure 1 Schematic illustration of the Green INSTRUCT water purification system**

In lab-scaled experiments artificial grey/stormwater is pumped from an aerated tank into the main channels. Underneath the panel a vessel collects the outflow. Pumps and tubes directing the outflow into another channel are at disposal for extra circuits to test optimal channel length for purification.

Mobile sensor units measuring COD, BOD, TSS, conductivity, nitrate and turbidity are applied to control inlet and outlet values. Laboratory balances are used to measure the panel's weight with various filling levels regarding substrate, plants and dry or wet condition.



## Results and Discussion

Results of the lab experiments will include the suitability of the geopolymer matrix for plant development and with regards to weight aspects. Factors affecting the development of root architecture will be documented and analysed, and the test set-up adapted accordingly. The optimal substrate supports a continuous flow, however with respect to a well-balanced retention time to allow for best purification results. If the water flow is too fast, purification rates will be correspondingly low and the contaminated water needs to pass more sanitation circuits. On the other hand, issues of draught similarly affect purification results. Considerations regarding evapotranspiration rates and biofilm desiccation are therefore crucial, especially with respect to the various climatic conditions the prototypes eventually are going to be exposed to.

To correspond with national and EU regulations on the usage of recycled water for various purposes the specific maximum contamination values must be achieved. Under lab conditions a pollution abatement of COD and BOD by more than 85 % ( $< 10 \text{ O}_2 \text{ mg/l}$  and  $< 5 \text{ O}_2 \text{ mg/l}$  respectively) is foreseen. Furthermore, the unit is expected to capture approx.  $2,4 \text{ kg of CO}_2/\text{m}^2$  per anno.

## References

- demEAUmed. 2014. 'demEAUmed'. <http://www.demeaumed.eu/>.
- Environment Agency. 2011. *Greywater for Domestic Users: An Information Guide*. Bristol: Environment Agency.
- alchemia-nova GmbH. 2017. 'Phytotechnology | alchemia-nova'. Accessed February 3. <http://www.alchemia-nova.net/en/activities/phytotechnologie-2/>.
- Zraunig, Andrea, Heinz Gattringer, Johannes Kissler, and Manfred Radtke. 2015. 'Building-Integrated Indoor Vertical Ecosystem for Treatment and Recycling of Greywater'. *Sustainable Sanitation Practice* 23 (7): 11–17.

## **Feasibility study of small anaerobic-co-digestion in urban district level.**

Ref # S2SMALL-56642

**Bautista Angeli J-R.**<sup>1,2</sup>, **Lakel A.**<sup>2</sup>, **Le Floc'h T.**<sup>2</sup>, **Andres Y.**<sup>1</sup>

<sup>1</sup>IMT Atlantique, GEPEA (UMR CNRS 6144), Université Bretagne Loire, 4 rue Alfred Kastler, 44307 Nantes, France

<sup>2</sup> CSTB, Aquasim, 11 rue Henri Picherit, 44300 Nantes, France

Corresponding author. E-mail address: [jean-romain.bautista@cstb.fr](mailto:jean-romain.bautista@cstb.fr)

**Key words:** Anaerobic-digestion, co-digestion, wastewater, BMP

### **Introduction**

The evolution of Western societies now raises the question of their energy perspectives and their environmental impacts. Indeed, with the depletion of fossil resources, in Europe and France, the policies lead to an energetical transition. In these objectives, the research challenge is focused on alternative technologies, towards local and renewable resources. Anaerobic digestion is one of the technologies put forward to make this transition. The process of anaerobic digestion produces, by consumption of the organic matter resulting from waste, a recoverable biogas. Nevertheless its domain needs to be adapted to fit into the tomorrow's urban area and thus enable the realization of the energetic and environmental objectives.

Eco neighborhoods correspond to homes built on a strong environmental commitment. Their development takes social and environmental criteria into account at the construction stage, and various process of resource management are implemented, for example, to limit water consumption (vacuum toilet), to recover waste and / or to use solar energy. The collection of wastewater can also be centralized to process such as anaerobic digestion (Wendland, 2008), to a treatment plant or to decentralized management. Furthermore, recent studies on anaerobic digestion highlight the possibility to use a co-digestion to optimize the process by the valorization of other waste deposits. (Cabbai et al., 2013; Hertel et al., 2015) In order to maximize energy recovery by bringing the final energy consumer, the waste producer and the treatment site closer together. This project plans to study the feasibility of a micro anaerobic digestion process by co-digesting of primary sludge from small wastewater treatment plants, domestic waste and green waste available on an eco district scale.

## Material and Methods

First of all, the study includes the characterization and selection of organic waste available at the scale of a district. For this, the Chemical Oxygen Demand (COD), the Dry Matter (DM), the Volatile Matter (VM) and the elementary analysis of the substrates were carried out (ISO NF EN 15169; 15934). Biochemical Methane Potential (BMP) tests were realized in 500 ml flasks, placed at 37 ° C. for 24-35 days. The S / I ratio was selected, close to 3, without addition of nutrient solution and each flask was supplemented with water up to 400 ml. About the Primary Sludge, the mention "A" correspond to a correction at 7 of the pH in the beginning of the reaction, by added NaOH or HCl. (Elbeshbishy et al., 2012; Raposo et al., 2012). The operation realized on a MIX of Food Waste (FW), Green Waste (GW) and Primary Sludge (PS) was with a ratio 1g VM add of each one. 1 blanks composed of 250 ml of inoculum and 150 ml of water, went for each test. The biogas quality was realized by micro-Gaseous Chromatography, with injected simples of 50 ml. This allowed to determine the fraction of CH<sub>4</sub>, CO<sub>2</sub>, N<sub>2</sub>, O<sub>2</sub> and H<sub>2</sub>S.

## Results and Discussions

From Table 1 the substrate was selected taking into account a VM / DM ratio greater or equal than 88% and a C/N ratio close to 15. Food Waste (FW), Green Waste (GW), Primary Sludge (PS), Paper Towel (PT) and Wheat Straw (WS) were selected as main substrates. The high C/N ratio (> 85) of PT and WS was taken into account considering the C/N ratio had to be adjusted in co-digestion.

Tables 1 shows the results of the physico-chemical analyzes of the residues studied.

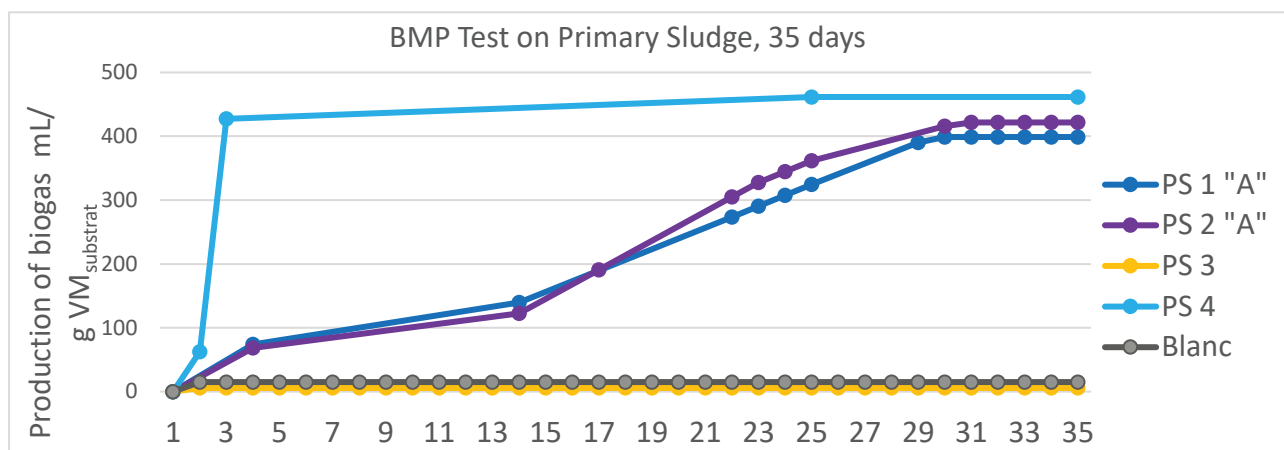
**Table 1:** Physico-chemical analyzes on the different types of substrates identified.

	DM (%)	VM/DM (%)	COD	C/N
<b>Food Waste (grinded and dried)</b>	94.4 (±0.4)*	81.1-92.9 **	1129 (±128) g.kg <sup>-1</sup> *	14
<b>Green Waste (grass mowing)</b>	14.6 (±0.7)*	96.7 (±0.8)*	824 (±46) g.kg <sup>-1</sup> * <sup>1</sup>	14
<b>Primary Sludge (raw wastewater settled 25-90min)</b>	1.0 (±0.1)*	80.0-95.2**	4.73-14.74 g.l <sup>-1</sup> **	13
<b>Mixed Sludge</b>	2.5 (±0.8)*	74.9-77.4 **	28 (±5) g.l <sup>-1</sup> *	11
<b>Activated Sludge (mass loading 0.3 kg.kg<sup>-1</sup>.d<sup>-1</sup>)</b>	0.44 (±0.02)*	81.9 (±1.8)*	5.8 (±0.4) g.l <sup>-1</sup> *	6
<b>Paper Towel</b>	93.9 (±0.2)*	99.8 (±0.2)*	815 (±112) g.kg <sup>-1</sup> * <sup>1</sup>	Inf. det. <sup>a</sup>
<b>Wheat Straw</b>	91.8 (±0.7)*	96.4 (±0.6)*	1033 (±72) g.kg <sup>-1</sup> * <sup>1</sup>	91
<b>Composting (after 150 days) <sup>2</sup></b>	60-85	45.8-50.4	Nd	Nd

1, Measured on the substrate after grinded and drying at 105 ° C., 16 h. 2, based on the work of Adhikari et al., 2013.

\* Gaussian p<0.05 with Wilk Shapiro's test, mean (± standard deviation) \*\*minimum – maximum

a, azote fraction lower than the detection threshold



**Figure 1:** BMP Test on PS, at 37°C, during 30 days.

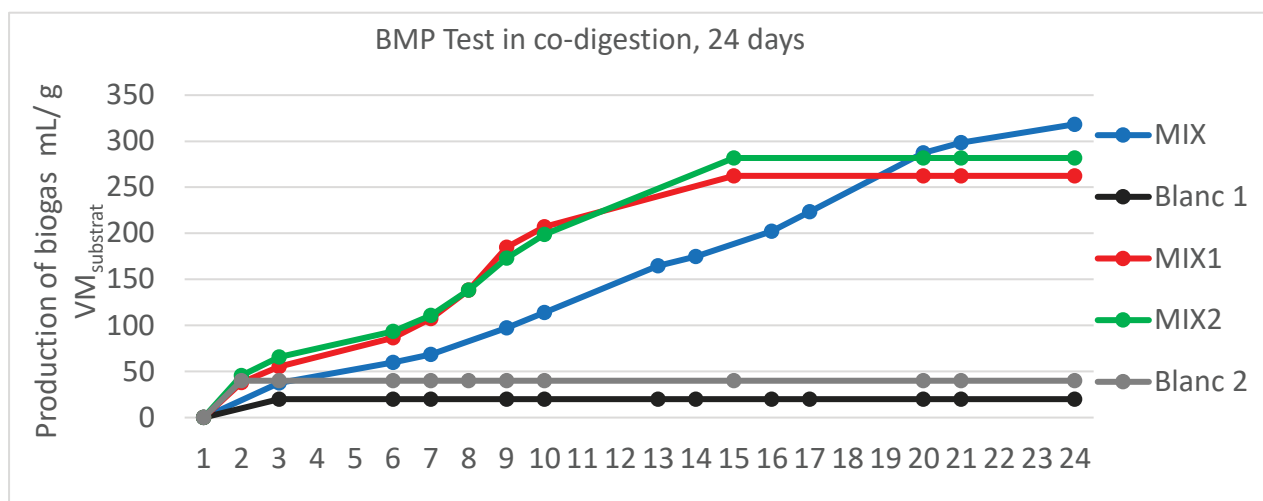
“A”, correspond to a correction of the pH to 7

**Table 2:** Methane concentration on the biogas produced during BMP test

	Day 3	Day 4	Day 14	Day 17	Day 22	Day 25	Day 35
PS 1 « A » *	-	2.8%	26.5%	-	25.3%	22.7%	30.1%
PS 2 « A » *	-	1.7%	3.7%	12.3%	-	37.0%	55.4%
PS 3 *	-	-	-	-	-	-	-
PS 4 *	0.2%	-	-	-	-	0.2%	-

\*Results on percentage of the total volume of biogas analyzed

- : not measured



**Figure 2:** BMP Test in co-digestion of FW, GW, PS, at 37°C, during 24 days.

**Table 3:** Methane concentration on the biogas produced during BMP test

	Day 2	Day 6	Day 10	Day 13	Day 20	Day 23	Day 25
MIX *	1.3%	26.8%	-	68.1%	73.1%	69.2%	-
MIX 1 *	-	-	30.6%	-	-	-	57.0%
MIX 2 *	-	-	24.4%	-	-	-	58.5%

\*Results on percentage of the total volume of biogas analyzed

- : not measured

According to the Figure 1 and the Table 2, it could be measured during the BMP test of PS, with a high S/I ratio, a total yield of 98 ( $\pm 10$ ) mL CH<sub>4</sub> / g VMsubstrat and an inhibition of the methane production in absence of pH correction. With the same S/I ratio, BMP tests on a MIX of each waste are presented on Figure 2. It could be deduced to the Table 3, a methane production of 134 ( $\pm 34$ ) mL CH<sub>4</sub> / g VMsubstrat. Although we acknowledge that the methane concentration is fast obtainable with the MIX than the PS, that seems confirm the literature about a better stability of co-digestion in comparison of mono-substrate digestion. (Davidsson et al., 2007; Cabbai et al., 2013)

This results highlight the co-digestion as a process to conduce the anaerobic digestion of decentralized water without chemical addition to regulate the pH. In the focus of the integration at urban scale, the co-digestion process, could be a way to treat organic household waste with small and local units. (Wendland, 2008; de Graaff et al., 2010)

The next step of the study will consist of the transposition into a 50 L pilot reactor and the use of secondary substrate for improve the C/N ratio of the mix to 20-30, assumed to optimized for an anaerobic digestion reaction.

## References

- Cabbai, V., Ballico, M., Aneggi, E., Goi, D., 2013. BMP tests of source selected OFMSW to evaluate anaerobic codigestion with sewage sludge. *Waste Manag.* 33, 1626–1632. doi:10.1016/j.wasman.2013.03.020
- Davidsson, Å., la Cour Jansen, J., Appelqvist, B., Gruvberger, C., Hallmer, M., 2007. Anaerobic digestion potential of urban organic waste: a case study in Malmö. *Waste Manag. Res.* 25, 162–169. doi:10.1177/0734242X07075635
- de Graaff, M.S., Temmink, H., Zeeman, G., Buisman, C.J.N., 2010. Anaerobic Treatment of Concentrated Black Water in a UASB Reactor at a Short HRT. *Water* 2, 101–119. doi:10.3390/w2010101
- Elbeshbishy, E., Nakhla, G., Hafez, H., 2012. Biochemical methane potential (BMP) of food waste and primary sludge: Influence of inoculum pre-incubation and inoculum source. *Bioresour. Technol.* 110, 18–25. doi:10.1016/j.biortech.2012.01.025
- Hertel, S., Navarro, P., Körner, I., 2015. Biogas and nutrients from blackwater, lawn cuttings and grease trap residues—experiments for Hamburg’s Jenfelder Au district [WWW Document]. URL <http://link.springer.com/article/10.1186/s13705-015-0057-5> (accessed 8.4.16).
- Raposo, F., De la Rubia, M.A., Fernández-Cegrí, V., Borja, R., 2012. Anaerobic digestion of solid organic substrates in batch mode: An overview relating to methane yields and experimental procedures. *Renew. Sustain. Energy Rev.* 16, 861–877. doi:10.1016/j.rser.2011.09.008
- Wendland, C., 2008. Anaerobic digestion of blackwater and kitchen refuse, *Hamburger Berichte zur Siedlungswasserwirtschaft. Ges. zur Förderung und Entwicklung der Umwelttechnologien an der Technischen Univ. Hamburg-Harburg, Hamburg.*

# Development and validation of performance evaluation protocol for small wastewater treatment MBR systems

<sup>1,2</sup>Kulesha, O., <sup>1</sup>Maletskyi, Z., <sup>3</sup>Todt, D., <sup>1</sup>Ratnaweera, H.

<sup>1</sup>Norwegian University of Life Sciences, PO Box 5003, 1432 Aas, Norway

<sup>2</sup>Kiev Polytechnic Institute, Kiev, Ukraine

<sup>3</sup>Ecomotive AS, Runde Miljøbygg, 6096 Runde, Norway

**Keywords:** submerged MBR, fouling, operation

## Introduction

Membrane fouling remains the main drawback to wider application of MBR technology in decentralized wastewater treatment [1]. All known physical, chemical and biological prevention strategies require representative and continuous evaluation of MBR system performance. Conventional laboratory approach, based either on monitoring of trans-membrane pressure development during filtration at constant flux or flux decrease at constant pressure, together with chemical and biological indicators, does not suit needs of full-scale or pilot systems, where separation process is being run in cycle, when filtration phase alternates with relaxation, backwash with permeate or chemically enhanced backwash. Large-scale industrial MBR plants are monitored comprehensively and continuously supervised by qualified staff, which takes decision about acceptable hydraulic parameters, energy consumption and cleaning frequency. Both approaches are not suitable for small MBRs, intended for decentralized wastewater treatment, where qualified staff is involved during installation and commissioning at best.

Thereby, the objective of the present work is to define performance indicators of the membrane separation process in submerged MBR, which can be monitored during continuous run of small decentralized wastewater treatment system and interlinked with chemical and biological parameters into performance evaluation protocol.

## Material and Methods

The experimental plant has a design of submerged MBR in external configuration, with separate biological and filtration tanks, connected by overflow. Ceramic-plate microfiltration membranes with 0.4  $\mu\text{m}$  pores were applied (Cembrane, Denmark). Three membrane modules with total filtering area of 0.828  $\text{m}^2$  were connected in parallel to the peristaltic pump. Membranes were aerated from the bottom diffuser with oxygen excess. Biology was inoculated with sludge from municipal wastewater treatment plant (BEVAS, Oslo). Pre-screened wastewater was supplied at 0.3  $\text{m}^3/\text{d}$  and obtained by mixing black and grey water at 1:1 ratio.

Wastewater (WW) and activated sludge (AS) were characterized by COD, TSS, VSS, SVI, CST and relative hydrophobicity (RH), analysed daily according to SMWW (22<sup>nd</sup> edition). Flow in permeate line, and transmembrane pressure (TMP) were measured with flow and pressure sensors (Krohne) and logged every second to PLC together with filtration cycle settings.



## Results and Discussion

Obtained permeate flows were recalculated to membrane flux  $J$ , LMH (1), normalized to 20 °C as  $J_N$  (1) and used to calculate normalized permeability  $P_N$  (2):

$$J = \frac{F}{S_f} \quad (1) \quad J_N = J \cdot e^{(-0.032 \cdot (t-20))} \quad (2) \quad P_N = \frac{J_N}{TMP} \quad (3)$$

Data array of hydraulic parameters was statistically treated and 8 representative filtration cycles for each day were selected for further analysis. For each cycle, a set of average initial and final parameters has been calculated, excluding ramp and relaxation periods of the peristaltic pump. Coefficient of permeability recovery  $P_R$  (4), TMP development rate  $dTMP/dt$  (5) and membrane resistance  $R$  (6) were calculated:

$$P_R = \frac{P_N^{N+1} - P_N^N}{P_N^{N+1} - P_N^N} \quad (4) \quad \frac{dTMP}{dt} = \frac{TMP_i - TMP_{i-1}}{t_i - t_{i-1}} \quad (5) \quad R_{tot} = \frac{TMP}{\eta \cdot J_N}, \quad (6)$$

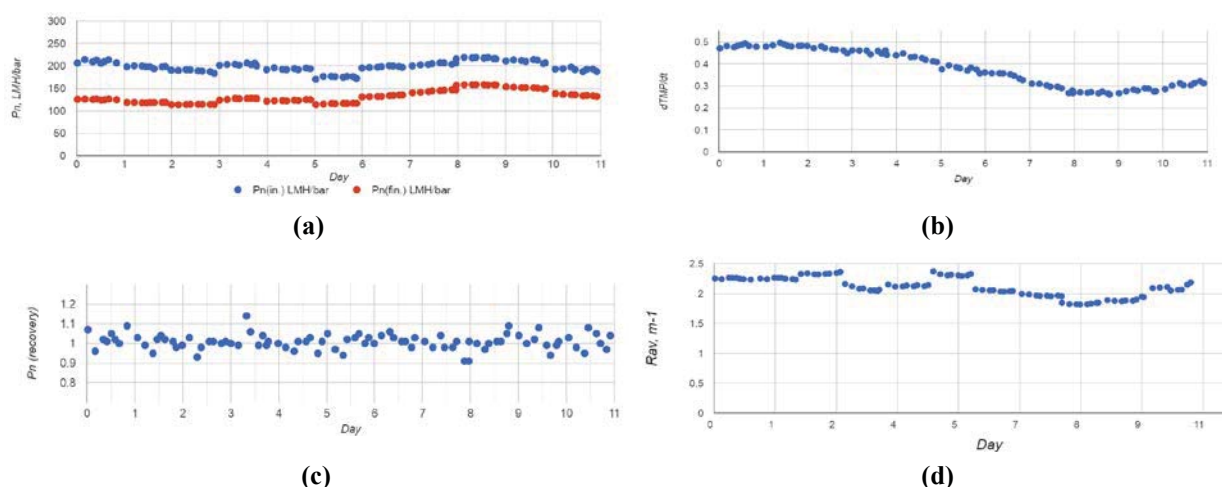


Figure 1. Membrane system operation parameters: normalized permeability (a), first derivative of transmembrane pressure (b), recovery of normalized permeability (c), membrane resistance (d)

Table 1 – Parameters of WW and AS

Parameter	COD, mgO <sub>2</sub> /L	TSS, mg/L	VSS, mg/L	SVI, mL/g	CST, sec	RH, %
WW	165.5-179	0.15-0.21	-	-	-	-
Permeate	29.8-36.1	0-0.023	-	-	-	-
AS-B	47.65-57.95	1.77-2.06	1.39-1.91	192.28-257.79	30.1-40.16	-
AS-F	52.75-85.15	5.03-5.51	4.18-4.923	159.60-202.65	119.8-139.3	35.84-47.26

Obtained results show that developed protocol allows evaluating performance of small wastewater treatment MBR system, simultaneously accounting treatment efficiency parameters, standard membrane filtration characteristics, fouling development indicators ( $dTMP/dt$ ,  $R_{tot}$ ) and membrane cleaning efficiency ( $P_R$ ). This approach allows maintaining the system within stable operation range and treatment efficiency, and can be used in further studies of membrane fouling prevention and development of membrane cleaning protocols.

## References

1. Membrane Biological Reactors. Theory, Modeling, Design, Management and Applications to Wastewater Reuse. Editors: Hai F.I., Yamamoto K. and Lee C-H, (2014). IWA Publishing, 504 p.

# Vermifilter as a compact and simplified unit for decentralized sewage treatment system

Ref # S2SMALL-98668

A.L. Tonetti<sup>1\*</sup>, F.J.P.L. Madrid<sup>1</sup>, M.M. Marques<sup>2</sup>, M.C. Parizotto<sup>2</sup>

<sup>1</sup> School of Civil Engineering, Architecture and Urban Design – FEC, Sanitation and Environment Dept. – DSA, State University of Campinas - UNICAMP, P.O. Box 6143, 13083-889, Campinas (SP), Brazil

<sup>2</sup> Marques & Parizotto Company, Alameda Ourique 725, 13342-150, Indaiatuba (SP), Brazil

\* Presenting Author: [adriano@fec.unicamp.br](mailto:adriano@fec.unicamp.br)

**Keywords:** decentralized wastewater treatment, *Eisenia Andrei*, nitrification, organic matter removal, vermifilter.

## INTRODUCTION

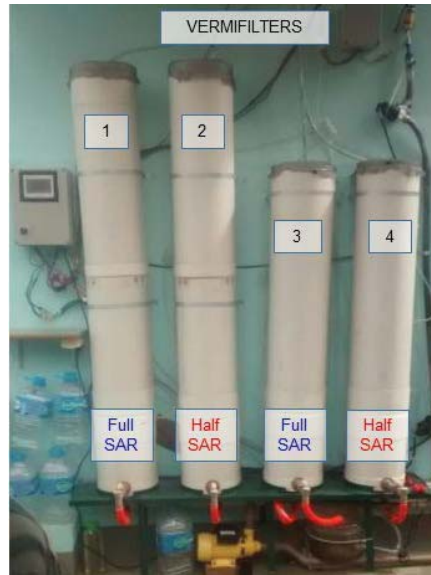
Considering the current scenario of developing countries where 18% of urban and 49% of rural households still use unimproved sanitation facilities (WHO, 2015), the vermifiltration process appears as a technically attractive alternative for sanitary wastewater treatment. It requires low-cost materials, small areas (thanks to the high surface application rates it can operate), generates vermicast instead of sludge – that can be used as bio-fertilizer – and its effluent can be applied in agricultural reuse (Xing et al. 2005; Sinha et al. 2008; Liu et al. 2009).

This work evaluated the performance of four pilot scale vermifilters in sewage treatment of a commercial establishment, supporting the future conception of a compact, versatile and easy to operate unit for decentralized wastewater treatment systems.

## MAIN METHODS

Each of the four cylindrical pilot scale vermifilter (made with 250 mm PVC pipes) received a population of 25,000 *Eisenia andrei* earthworms per m<sup>3</sup>, and were fed from the top with raw sewage for eight months. The top layer of Vermifilters 3 and 4 were formed by 50 cm of sawdust in several flake sizes, followed by a 50 cm expanded clay layer stratified in different grain sizes. Vermifilters 1 and 2 had two bed compartments of same configuration of the other referred units, simulating two reactors in series (Figure 1). The daily influent volume application varied according to the generation of sewage that was stored in a well; Vermifilters 1 and 3 received twice as much as units 2 and 4. Therefore, two surface application rates (SAR) were evaluated for each configuration set; the highest SAR reached maximum values around 1,800 L.m<sup>-2</sup>.day<sup>-1</sup>.

Laboratory analysis of the raw influent and treated effluents were taken once a month, using the standard methods described in APHA (2012) for the following parameters: pH, Turbidity, Total Suspended Solids (TSS), Biochemical and Chemical Oxygen Demand (BOD and COD), and nitrogen series. Data were submitted to analysis of variance (ANOVA), and their means were compared by Tukey test at a significance level of 0.05.



**Figure 1.** Front view of the four pilot scale vermifilters.

## MAIN RESULTS AND CONCLUSIONS

The main results (Table 1) showed: (i) No significant differences were found for Turbidity, TSS, BOD and COD removal between the four vermifilters (Tukey, 5%). (ii) All vermifilters had an average removal of about 80% of Turbidity, TSS and BOD, and about 70% of COD of the raw sewage. (iii) Between 30% and 40% of the ammoniacal nitrogen from the sewage was nitrified by the vermifilters.

Therefore, it can be inferred that the single compartment unit operated with a high SAR – Vermifilter 3 –, as well as the others reactors, reached satisfactory levels of organic matter removal from the raw sewage. It is noteworthy that removals above 90% of Turbidity, TSS and BOD and 80% of COD were verified most of the time for this unit. In addition, the high  $\text{N-NH}_4^+$  load of the urine-rich sewage ( $220 \pm 86 \text{ mg.L}^{-1}$ ) did not cause apparent problems in the reactor performance, presenting a nitrification of about 30%. These positive results may support further researches for vermifilters design based on SAR, as well as to establish minimum materials for the bed composition without compromising its performance.

**Table 1.** Mean concentrations and standard deviation of analyzed parameters.

Parameter	Raw Influent	Effluents			
		Vermifilter 1	Vermifilter 2	Vermifilter 3	Vermifilter 4
pH	$7.9 \pm 0.7$	$6.7 \pm 0.1$	$6.9 \pm 0.3$	$6.9 \pm 0.1$	$7.0 \pm 0.1$
Turbidity (uT)	$231 \pm 129$	$40 \pm 22$	$33 \pm 35$	$26 \pm 29$	$34 \pm 35$
TSS ( $\text{mg.L}^{-1}$ )	$195 \pm 75$	$37 \pm 30$	$21 \pm 30$	$23 \pm 34$	$39 \pm 38$
BOD ( $\text{mg.L}^{-1}$ )	$303 \pm 99$	$55 \pm 28$	$44 \pm 29$	$46 \pm 34$	$52 \pm 25$
COD ( $\text{mg.L}^{-1}$ )	$751 \pm 142$	$270 \pm 159$	$197 \pm 65$	$224 \pm 151$	$271 \pm 129$
N-ORG ( $\text{mg.L}^{-1}$ )	$40 \pm 71$	$28 \pm 51$	$6 \pm 7$	$13 \pm 18$	$18 \pm 41$
N- $\text{NH}_4^+$ ( $\text{mg.L}^{-1}$ )	$220 \pm 86$	$108 \pm 28$	$117 \pm 39$	$130 \pm 45$	$126 \pm 28$
N- $\text{NO}_2^-$ ( $\text{mg.L}^{-1}$ )	*	$0,7 \pm 0,8$	$1,3 \pm 2,6$	$2,4 \pm 2,1$	$5,0 \pm 7,1$
N- $\text{NO}_3^-$ ( $\text{mg.L}^{-1}$ )	*	$81 \pm 42$	$93 \pm 41$	$73 \pm 44$	$76 \pm 33$

\* Values below the method detection limit

## ACKNOWLEDGEMENTS

The authors would like to thank FAPESP (São Paulo Research Foundation, PROCESSO 2011/21919-7) for financing this study.

## REFERENCES

APHA, 2012. *Standard methods for the examination of water and wastewater*. American Public Health Association / American Water Works Association / Water Environment Federation. 22nd ed, New York, USA.

Liu, J., Lu, Z., Yang, J., Xing, M., Yu, F., 2009. *Ceramsite-vermifilter for domestic wastewater treatment and reuse: an option for rural agriculture*. International Conference on Energy and Environment Technology, 472-475. DOI: [10.1109/ICEET.2009.352](https://doi.org/10.1109/ICEET.2009.352).

Sinha, R.K.; Bharambe G.; Chaudhari, U., 2008. *Sewage treatment by vermifiltration with synchronous treatment of sludge by earthworms: a low-cost sustainable technology over conventional systems with potential for decentralization*. Environmentalist, 28, 409-420. DOI: [10.1007/s10669-008-9162-8](https://doi.org/10.1007/s10669-008-9162-8).

WHO, 2015. *Progress on Sanitation and Drinking Water: 2015 Update and MDG Assessment*. World Health Organization / UNICEF.

Xing, M.; Yang, J.; Lu, Z. 2005. *Microorganism-earthworm Integrated Biological Treatment Process – a Sewage Treatment Option for Rural Settlements*. ICID 21st European Regional Conference, Frankfurt and Slubice, Germany and Poland, 15-19.

## **Phosphorous removal by apatite filters: lessons learned by full scale systems and a new apatite generation.**

**Delgado-González, L.<sup>1,2</sup>, Prost-Boucle, S<sup>1</sup>., Troesch, S.<sup>2</sup>, Boubarne A.<sup>3</sup>, Molle, P<sup>1</sup>.**

<sup>1</sup> Irstea, UR MALY, 5 rue de la Doua, PB 32108, 69100 Villeurbanne Cedex, France.

<sup>2</sup> Epur Nature, 12 rue Toussaint Fléchaire, ZAC Les Balarucs, 84510 Caumont-sur-Durance, France.

<sup>3</sup> Timab Produits Industriels, 55 boulevard Jules Verger 35800 Dinard, France.

**Keywords:** Constructed wetlands; apatite, filters, phosphorus removal

### **Introduction**

The use of apatite, a natural phosphate rock, as a specific material which promotes phosphorous (P) adsorption/precipitation phenomena, has received particular attention in wastewater treatments in France in the last decade. Apatite filters are extensive systems for phosphorous removal which have been used together with constructed wetlands (CW) in wastewater treatment plants (WWTP) of small communities to deal with eutrophication problems in sensitive zones. There are more than 20 full-scale apatite filters installed in France, UK, Belgium and Austria, some of which are being operated for more than 5 years now. Consequently, a new research project gathering Irstea and Epur Nature, who have historically developed the use of apatite filter for P removal in France, and Timab, in charge of apatite pelletization which is marketed under the brandname Phosclean®, has started in 2017. The project named APPROVE is also co-funded by Rhône Méditerranée Corse and Adour Garonne French water agencies.

The APPROVE research program is being developed in order to i) capitalize the lessons learnt from the full scale systems since their commissioning, ii) to evaluate and validate a new generation of apatite material (kinetics, lifespan, influences of environmental and operational conditions ...) and iii) to define the valorisation of P enriched final material. This poster will present the APPROVE project objectives and methodology as well as the first results obtained during 2017.

### **Project methodology**

The APPROVE project comprises three axes of work (Figure 1). In first place, a number of field campaigns provide a feedback on the performances of full-scale apatite filters in France which operate with the 1<sup>st</sup> generation of Phosclean apatite pellets. This feedback allows a) to evaluate the pH increase during the commissioning phase, b) to identify the causes of dysfunctions sometimes observed in apatite filter's operation (e.g. clogging occurrence and/or the overcoming of discharge limits) and c) to evaluate the hydraulic and phosphorous retention performances of three hydraulically-different apatite filters (horizontal flow, vertical down flow and vertical up flow).

In second place, a PhD thesis has started to assess the new generation of apatite product. The major aim of this work is to determine its maximum P-retention capacity and the influence of different parameters as  $\text{Ca}^{2+}$  concentration, pH, and the presence of competitive ions and biomass in retention's kinetic. Laboratory and pilot scale experiments are conducted to combine chemical speciation and hydraulics with the aid of the Hydrus® software.

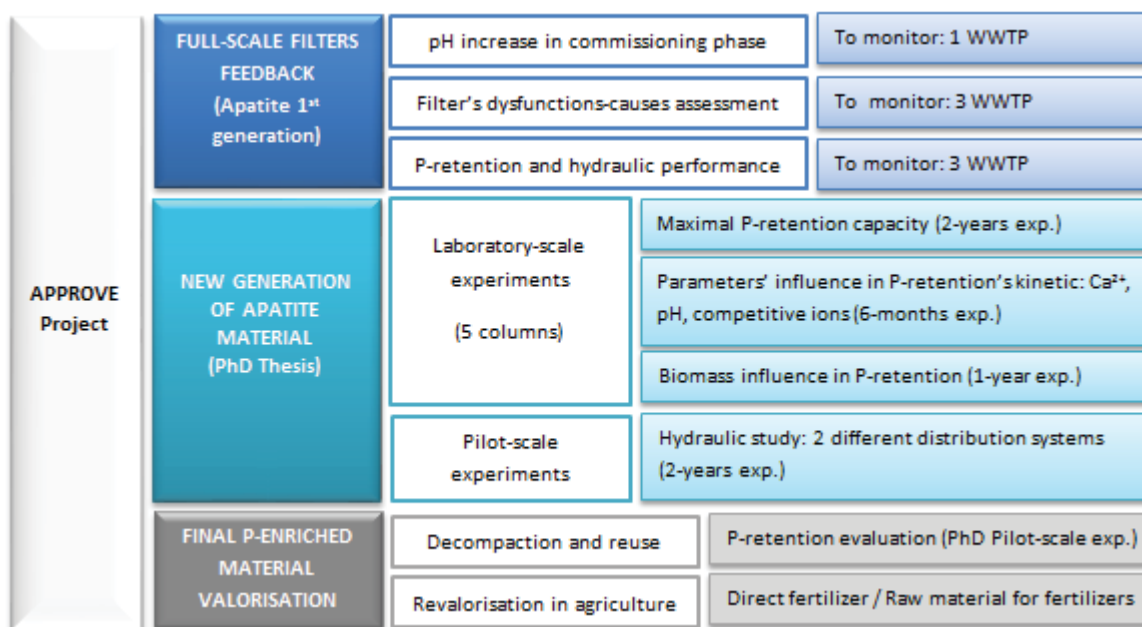


Figure 1 Scheme of APPROVE project

Finally, a study to determine P valorisation and apatite reuse alternatives will be performed. On one hand, the resulting saturated apatite (final P-enriched product) from pilot-scale experiments will be decompacted and operated again to assess P retention reliability after permeability's recovery. On the other hand, an investigation to determine its possible ways of valorisation either as direct fertilizer in agriculture or as raw material for fertilizers production will be conducted in accordance to the European regulation context.

## Results and Discussion

The poster will present the first results obtained on two aspects: the lessons gained from full scale systems (an example of a WWTP of 4 500EHcapacity) and the laboratory-scale monitoring of the new generation of Phosclean.

## References

- Harouiya, Prost-Boucle, S., Morlay, C., Esser, D., Ruel, S.M., 2011. Performance evaluation of phosphorus removal by apatite in constructed wetlands treating domestic wastewater: Column and pilot experiments. *Int. J. Environ. Anal. Chem.*91(7-8): 740-752.
- Molle, P., Martin, S., Esser, D., Besnault, Morlay, C., 2011. Phosphorus removal by the use of apatite in constructed wetlands: Design recommendations. *Water Pract. Technol* (6): 3.
- Troesch, S., Esser D. and Molle P., 2016. Natural rock phosphate: a sustainable solution for phosphorous removal from wastewater. *Procedia Engineering* 138:119 – 126



# Energy production from xylose by *Thermoanaerobacterium calidifontis* IS1 isolated from sludge of wastewater treatment

Ref # S2SMALL-20691

V. Silva<sup>1\*</sup>, I.K. Sakamoto<sup>2</sup>, M.B.A. Varesche<sup>3</sup>

<sup>1</sup> University of São Paulo, Av. Trabalhador São-carlense, 400, 13566-590 São Carlos, SP, Brazil

<sup>2</sup> University of São Paulo, Av. Trabalhador São-carlense, 400, 13566-590 São Carlos, SP, Brazil

<sup>3</sup> University of São Paulo, Av. Trabalhador São-carlense, 400, 13566-590 São Carlos, SP, Brazil

\* Corresponding Author: [vanessacs@sc.usp.br](mailto:vanessacs@sc.usp.br)

**Keywords:** anaerobic, ethanol, hydrogen, lignocellulosic

## INTRODUCTION

Reducing the generation of solid and liquid wastes and producing a clean, renewable and efficient energy represent the main challenges for the economic and environmental politics. Agricultural residues are one of such renewable and lignocellulosic-rich biomass resources available for biofuels production. Although the researchers have been focused on converting cellulose into energy, hemicellulose has been less studied. Thermophilic bacteria are able to convert pentose and hexoses in hydrogen, ethanol and organic acids in the anaerobic digestion process. The aim of this study was to isolate anaerobic, hemicellulosic, thermophilic bacteria from sludge of wastewater treatment UASB reactor and evaluate its ability to produce biofuel from xylose, the principal carbohydrate in the composition of hemicellulose.

## MAIN METHODS

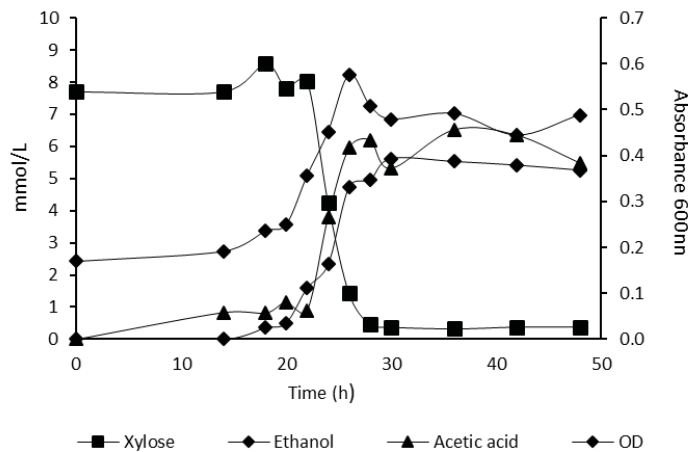
The strain was isolated from a granulated sludge of the Upflow Anaerobic Sludge Blanket (UASB) reactor treating vinasse waste (Usina São Martinho, Pradópolis, São Paulo, Brazil). Samples were enriched on xylose (1g/L) in AMM Medium (Crespo et al., 2012), at 55°C for 120 hours under strict anaerobic conditions (under N<sub>2</sub> 100%). The consortium was the serially diluted in the same medium and conditions, and the end point dilutions were planted by using agarose (2g/L). Colonies were picked from final positive dilution and reinoculated to liquid medium with xylose. The strain with the highest level of H<sub>2</sub> production was named IS1, and its metabolic was investigated in batch reactors. DNA was extracted from strain IS1 and the ribosomal 16S genes were amplified by PCR using the primer 27F-1110R (Lane, 1991). The PCR products were purified and sequenced using Sanger method and applied in the software DNASTAR (Lasergene sequence analysis). The partial 16S rRNA gene sequences were compared by database searches in NCBI-database (National Center for Biotechnology Information). Therefore, assays were prepared in batch reactors for evaluating the end-products, that 200 mL of microbial suspension was transferred into 2000 mL AMM Medium supplemented with xylose (1g/L) at 55°C and strict anaerobic conditions. Cell concentration was determined by measuring absorbance at 600 nm by Nanocolor VIS spectrophotometer. The anaerobic medium used was supplemented with xylose, galactose, cellobiose, glucose, sucrose, fructose, mannose, arabinose, and hydrolysate of bagasse and coffee husk (2g/L). Growth was observed by increase in optical density which was measured at the beginning and at the end of incubation time (5 days). The hydrogen content in the biogas was determined by gas chromatography (GC 2010 Shimadzu). The volatile acid and alcohol were determined by

gas chromatography (GC 2010 Shimadzu) equipped with flame ionization detector and an HP INNOWAX (30m x 0,25mm x 0,25µm of film thickness (Adorno et al., 2014; Adorno and Tomita, 2014).

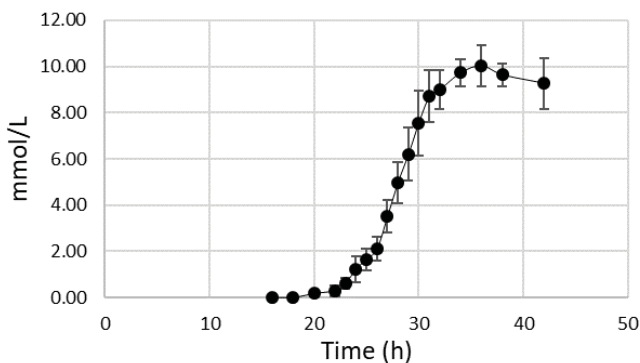
## MAIN RESULTS AND CONCLUSIONS

By means of 16S rRNA analysis was identified that the strain IS1 is a member of the genus *Thermoanaerobacterium*. The closest phylogenetic relative was *Thermoanaerobacterium calidifontis* NR 113051.1, where recorded similarity of the 16S rRNA genes was 99%. The strain IS1 isolate showed grown with various type of carbohydrates, such as xylose, galactose, cellobiose, glucose, sucrose, fructose, arabinose, mannose and hydrolysate of bagasse and coffee husk. Hydrogen was produced in the exponential phase accompanied by the production of ethanol and acetic acid. Propionic and butyric acids were not detected. All the substrate was consumed in 35 hours (95%) (Fig 1 and Fig 2).

The maximum H<sub>2</sub> production rate and yield of strain IS1 were 1.42 mmol/L. h<sup>-1</sup> and 1.39 mol H<sub>2</sub> / mol-xylose, respectively. The ethanol results were 0.76 mmol/L. h<sup>-1</sup> and 0.72 mol EtOH / mol- xylose. Therefore, the strain IS1 was able to produce hydrogen and ethanol from xylose, and these results evidence the capability to produce energy from renewable resources, such as lignocellulosic residues.



**Figure 1.** Growth and end products formation from xylose (2g/L) by strain IS1



**Figure 2.** Hydrogen production from xylose (2g/L) by strain IS1

## REFERENCES

- Adorno, M.A.T., Hirasawa, J.S., Varesche, M.B.A., 2014. Development and Validation of Two Methods to Quantify Volatile Acids (C2-C6) by GC-FID: Headspace (Automatic and Manual) and Liquid – Liquid Extraction (LLE). *Am. J. Anal. Chem.* 5, 406–414.
- Adorno, M.A.T., Tomita, I., 2014. Development and validation of a method for nitrogen, hydrogen, methane, and carbon dioxide determination by GC / DCT, in Brazilian Chemical Society Annual Meeting.
- Crespo, C., Pozzo, T., Karlsson, E.N., Alvarez, M.T., Mattiasson, B., 2012. *Caloramator boliviensis* sp. nov., a thermophilic, ethanol-producing bacterium isolated from a hot spring. *Int. J. Syst. Evol. Microbiol.* 62, 1679–1686. doi:10.1099/ijs.0.032664-0
- Lane, D.J., 1991. 16S/23S rRNA sequencing. In: Stackebrandt E, Goodfellow M (eds) *Nucleic acid techniques in bacterial systematics* 115–175.

# Influence of hydraulic retention time on the removal and removal kinetics of antibiotics Sulfamethoxazole and Ciprofloxacin in an anaerobic packed bed reactor

Ref # S2SMALL-92710

R. B. Carneiro<sup>1\*</sup>, C. M. Mukaeda<sup>1</sup>, A. J. Santos-Neto<sup>2</sup>, M. Zaiat<sup>1</sup>

<sup>1</sup> Laboratory of Biological Processes, Center for Research, Development and Innovation in Environmental Engineering, São Carlos School of Engineering, University of São Paulo (USP), 1100, João Dagnone Ave., Santa Angelina, 13563-120, São Carlos, São Paulo, Brazil.

<sup>2</sup> Laboratory of Chromatography, Institute of Chemistry of São Carlos, University of São Paulo (USP), 400, Trabalhador São-Carlense Ave., São Carlos, São Paulo 13566-590, Brazil.

\* Corresponding Author: [rodrigobrazcarneiro@yahoo.com.br](mailto:rodrigobrazcarneiro@yahoo.com.br)

**Abstract:** The occurrence, fate and potential impacts of antibiotics in the environment has attracted attention of researchers around the world in recent years. Although the concentration of antibiotics and their metabolites is considered low (range from  $\text{ng.L}^{-1}$  to  $\mu\text{g.L}^{-1}$ ) in the different environmental compartments, they are considered emerging contaminants because they can result in the development and spread of resistance genes in bacteria. Sulfamethoxazole (SMX) and Ciprofloxacin (CIP) are among the antibiotics most frequently detected in various environmental matrices. Nevertheless, there are few studies focusing on anaerobic biodegradation processes for these compounds. Adjustment of operational parameters, such as hydraulic retention time (HRT) and sludge retention time, at wastewater treatment plants may influence the biodegradation of micropollutants. The aim of this work was to evaluate the influence of HRT on the performance of anaerobic packed bed reactor (APBR) at removing the antibiotics SMX and CIP from a low strength synthetic domestic sewage. It was observed that the decrease in HRT from 12 to 4 hours resulted in a drop in the performance of the reactors in the removal of organic matter and antibiotics.

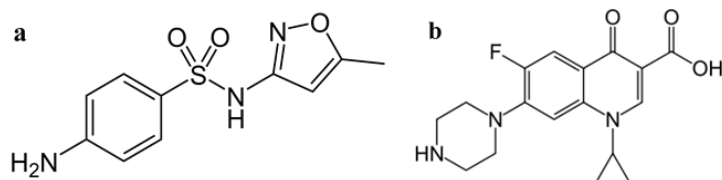
**Keywords:** Ciprofloxacin, Hydraulic Retention Time, Kinetics, Packed Bed, Sulfamethoxazole.

## INTRODUCTION

Antibiotic compounds are emerging contaminants, which are present in various environmental matrices at concentrations of  $\mu\text{g.L}^{-1}$  or even lower ( $\text{ng.L}^{-1}$ ), and may cause adverse effects on human health, biota and aquatic ecosystems. They are among the pharmaceutical compounds most frequently found in aquatic environments around the world, and are only partially degraded in biological treatment plants (Bila and Dezotti, 2003; Göbel et al., 2005; Zorita et al., 2009).

Antibiotics have wide use in human and veterinary medicine, resulting in many potential sources of contamination. Moreover, they have the ability to change the structure of the microbial community, promoting the development of resistant human pathogens (Karthikeyan and Meyer, 2006) and thus causing a serious threat to public health, as the infection cannot be treated with the antimicrobials currently known (Hirsch et al., 1999). The bacteria, when exposed to low doses of antibiotics, are gradually becoming tolerant to these antibiotics and developing resistance (Sahoo et al., 2010).

Considering the various classes of antibiotics, fluoroquinolones and sulfonamides are the most persistent in the environment (Huang et al., 2001). The sulfamethoxazole (sulfonamide class) and the ciprofloxacin (fluoroquinolone class) are widely used in human and veterinary medicine (Segura et al., 2009), and are among the most frequently detected in the aquatic environment (Heberer, 2002; Kümmerer, 2009), imposing therefore great risk to the non-target species in ecosystems (Bouki et al., 2013). Figure 1 shows the structure of SMX and CIP.



**Figure 1.** General chemical structure of sulfamethoxazole (a) and ciprofloxacin (b)

Possible technologies available for removing antibiotics refer to physical-chemical systems such as activated carbon, advanced oxidation processes and ozonation. However, these processes require high investment and more sophisticated operation. Thus, it is very important to know the behavior and removal mechanisms of these pharmaceutical compounds in biological treatment systems. In this respect, the removal in conventional activated sludge and membrane bioreactors are the most studied (Clara et al., 2005; Miege et al., 2009; Sipma et al., 2010). On the other hand, removal and biodegradation studies of antibiotics in anaerobic systems is incipient.

In Brazil, where the anaerobic treatment technology is very applicable and widespread, it is necessary to evaluate the performance of anaerobic systems in removing pharmaceutical compounds. Some studies have been conducted to evaluate the removal of antibiotics in anaerobic treatment systems such as UASB (Queiroz et al., 2012) and horizontal-flow anaerobic immobilized biomass (Chatila et al., 2015).

The application of fixed-bed bioreactors as alternative for the anaerobic treatment of domestic and industrial wastewater has increased in recent years. A fixed bed reactor consists of biomass immobilized on inert materials (such as low-density polyethylene, polyurethane foam and ceramic), forming a biofilm. Among the advantages of this reactor can be mentioned its ability to maintain high solids retention time (high biomass concentration) even when operated at low hydraulic retention times; high performance and stability; low content of suspended solids effluent (Cuel et al., 2011; Mockaitis et al., 2014). In addition, biofilm formation can increase the resistance to toxic and recalcitrant compounds, as well as the enhancement of biodegradation.

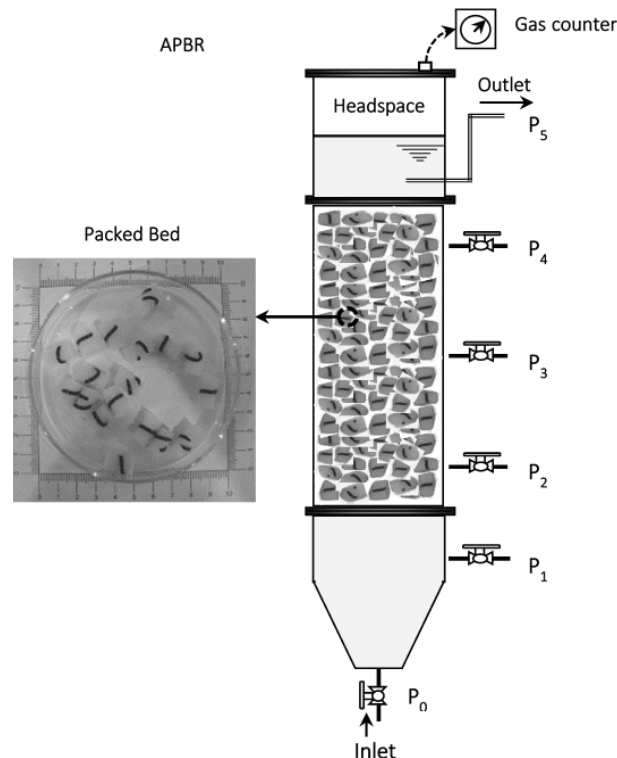
Polyurethane foam has been widely studied for diverse applications as a support matrix to immobilize anaerobic biomass (Santos et al., 2016; Godoi et al., 2015; Chatila et al., 2015). Gizgen et al. (1988) and Varesche et al. (1997) observed that the polyurethane foam matrices offered excellent conditions for anaerobic growth and adhesion. Other advantages of using polyurethane foam is its high porosity, low cost and easy acquisition.

The aim of this work was to evaluate the influence of hydraulic retention time (HRT) on the performance of anaerobic packed bed reactor (APBR) at removing the antibiotics sulfamethoxazole (SMX) and ciprofloxacin (CIP) from a low strength synthetic domestic sewage.

## MATERIALS AND METHODS

### Bioreactor and support media configuration

This study employed a bench-scale anaerobic packed bed reactor (APBR) using polyurethane foam as support media – Figure 2. The bioreactor was made of acrylic with a working total volume, discounting support media, of 2.69 L. The support media applied in the reactors had the following features: porosity of 92%, apparent density of 23 g.L<sup>-1</sup>, and specific surface area of 43.8 m<sup>2</sup>.g<sup>-1</sup> (Silva et al., 2006). The reactor was filled with cylindrical matrices of polyurethane foam with a diameter of 0.8 cm and height of 1.2 cm, resulting in bed porosity of 59%.



**Figure 2.** Experimental apparatus of the APBR

### Operational Conditions

Before the reactor operation start-up, the support media was inoculated with granular sludge obtained from an UASB bioreactor treating poultry slaughterhouse with total volatile solids of 26.5 gTVS.L<sup>-1</sup>. The feeding of the reactors was performed continuously and in up-flow through peristaltic pumps (Gilson MINIPULS® 3). The temperature was kept in 30°C. The reactor operation was divided into three phases with different HRT – 12 h (I), 8 h (II) and 4 h (III). COD, SMX and CIP removal profiles were evaluated for each HRT.

### Synthetic Wastewater Composition

During the experiment, the reactor was fed with synthetic (lab-made) wastewater, simulating domestic sewage, with a theoretical total chemical oxygen demand (COD) of 500 mg.L<sup>-1</sup>. The synthetic medium was composed by sucrose (43), cellulose (42.5), starch (135), meat extract (219), NaHCO<sub>3</sub> (300), KH<sub>2</sub>PO<sub>4</sub> (15), NaCl (250), CaCl<sub>2</sub>.2H<sub>2</sub>O (7), MgCl<sub>2</sub>.6H<sub>2</sub>O (4.5), anionic surfactant (15), and soybean oil (31) - values in mg.L<sup>-1</sup>. The wastewater was amended with



NaHCO<sub>3</sub> in order to maintain the pH and alkalinity at a desirable range to methanogenesis. Surfactant was added to the medium in order to emulsify the soybean oil.

The antibiotics sulfamethoxazole and ciprofloxacin were added to the synthetic medium at concentration around of 400 ng.L<sup>-1</sup>, based on average values from samples of domestic sewage collected by Gomes et al. (2015). This concentration is considered relevant for domestic sewage, since it is within the range of values indicated in reported studies in the literature.

### **Analytical Methods**

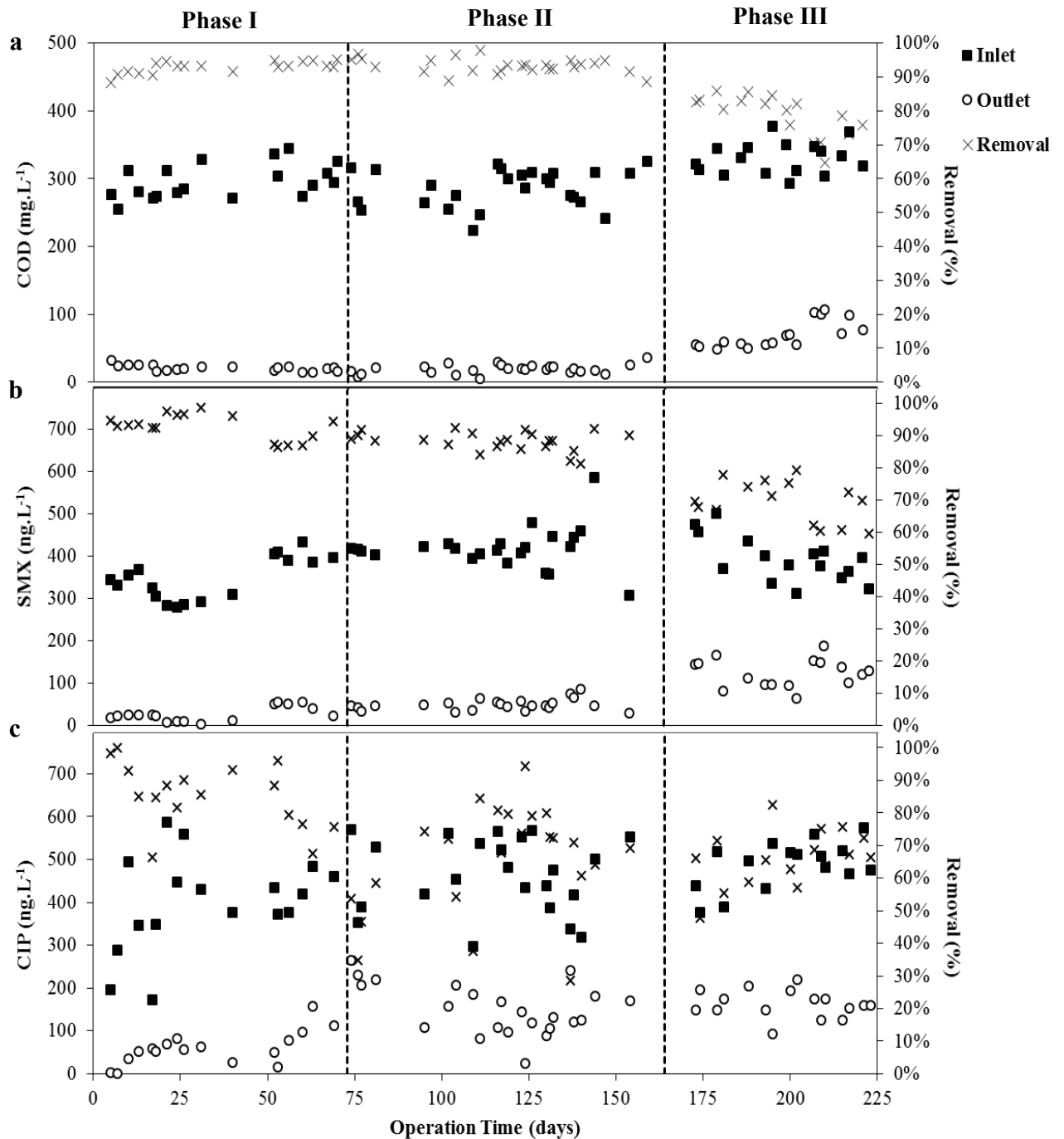
The system performance was monitored by physical chemical analysis in influent and effluent samples of the reactor, according to the methods described in APHA (2005): pH (4500-H<sup>+</sup> B), COD (5220-D), and Suspended Solids (2540-E). Alkalinity was measured according to Ripley et al. (1986). The biogas composition (carbon dioxide, methane and sulfide) was monitored by gas chromatography (GC 2010 Shimadzu<sup>®</sup> Scientific Instruments). The biogas flow rate was measured with a gas meter model MGC-1 V30 (Ritter<sup>®</sup>).

The SMX and CIP concentrations in the aqueous samples were determined by using a column-switching online solid phase extraction coupled to a liquid chromatography/tandem mass spectrometry (SPE-LC-MS/MS) method - Chromatograph Agilent<sup>®</sup> 1200 LC series and hybrid triple quadrupole-linear ion trap mass spectrometer AB SCIEX QTRAP<sup>®</sup> 5500. Influent and effluent samples were subjected to a simple pre-treatment: pH was adjusted to 3.0 using 0.1% of formic acid and filtered using 0.22 µm acetate cellulose membrane. Internal standards, isotopically labeled - <sup>13</sup>C-SMX and CIP-D<sub>8</sub>, were used in order to reduce the extent of possible losses during the analytical procedure. The reagents SMX, CIP, <sup>13</sup>C<sub>6</sub>-SMX and CIP-D<sub>8</sub> were obtained from Sigma-Aldrich<sup>®</sup> (Gomes et al., 2015).

### **RESULTS AND DISCUSSION**

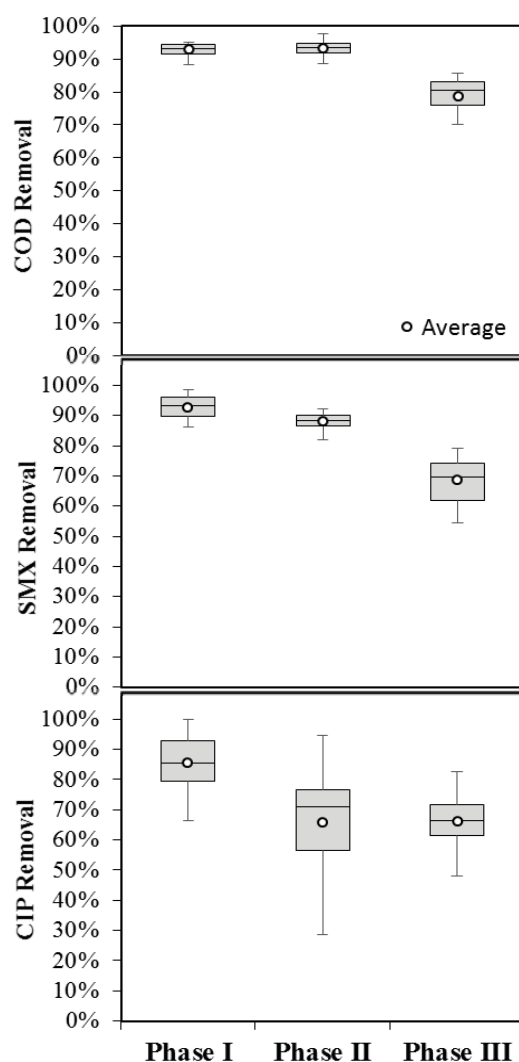
Figure 3 shows the COD, SMX and CIP removal variation throughout the operational period. In Figure 4 are the boxplot graphs of COD, SMX and CIP removal for phases from I to III. As the HRT decreases, the organic load rate (OLR) applied is increased by increasing of the inflow without changing the affluent COD concentration. Considering the results presented in the graphs, it can be observed that, with the reduction of HRT applied from 12 to 8 h, there was no significant reduction of COD and SMX removal from the system, while for CIP this reduction affected the performance of the reactor. With the reduction to 4 h of HRT, there was a decrease in the reactor performance in the removal of COD, which was also accompanied by a decrease in the efficiency of SMX. This result implies a strong correlation between the removal of COD and sulfamethoxazole, which did not necessarily occur for ciprofloxacin. This may be due to cometabolic biodegradation in sulfonamide removal.

It has also been hypothesized that, with the decrease in HRT and consequent increase in the ascending velocity in the bed, it may have caused a decrease of the diffusive transport to the biofilm and / or increased the CIP desorption capacity of the bed, resulting in the decrease of the reactor performance. It should be noted that the increase in the inflow load of SMX and CIP antibiotics with the decrease in HRT did not interfere directly on the removal of COD in Phase II, but may have had an impact in Phase III.



**Figure 3.** Temporal variation of affluent concentration, effluent concentration and removal efficiency of COD (a), SMX (b) and CIP (c)

Table 1 shows the results regarding methane production and yield in the reactor. It can be observed that the decrease of HRT caused a significant increase of the molar flow, volumetric production and yield of CH<sub>4</sub>. This was due to the increase in the produced biogas flow rate, due to the higher OLR removed from the medium, accompanied by the higher ascending velocity, which resulted in a lower resistance to the gas transfer to the headspace. Thus, increasing the affluent load of antibiotics did not affect methane production and yield. Moreover, the high content of CH<sub>4</sub> ( $X_{CH_4} > 90\%$ ) in biogas highlights the optimal performance of methanogenic archaea in the medium. Hydrogen and sulfide gas were not detected in the biogas.



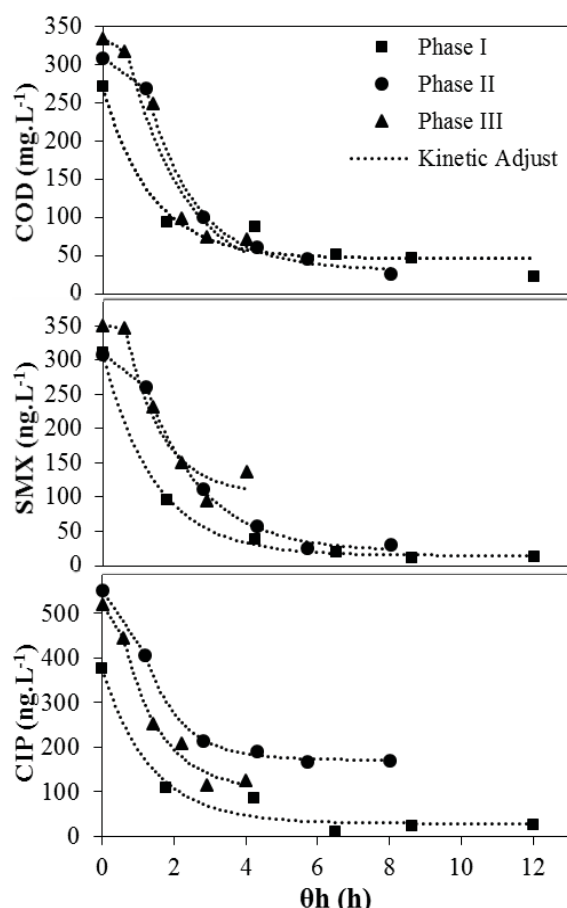
**Figure 4.** Boxplot Graph for COD, SMX and CIP removal

**Table 1.** Results regarding methane production and yield; and organic load rate applied and removed from the system. Bold values correspond to the mean and the other ones to the standard deviation.

Parameter (Unit)	Phase I	Phase II	Phase III
Biogas Flow Rate (mL.d <sup>-1</sup> )	<b>319</b> 23	<b>438</b> 44	<b>562</b> 70
Volumetric Methane Production Rate (mLCH <sub>4</sub> .L <sup>-1</sup> .d <sup>-1</sup> )	<b>139</b> 10	<b>194</b> 19	<b>248</b> 31
Molar Methane Flow Rate (mmolCH <sub>4</sub> .d <sup>-1</sup> )	<b>10,6</b> 0,7	<b>14,9</b> 1,5	<b>19,0</b> 2,4
Methane Yield (mLCH <sub>4</sub> .g <sup>-1</sup> CODremovida)	<b>252</b> 34	<b>366</b> 44	<b>473</b> 51
X <sub>CH<sub>4</sub></sub> (%)	<b>92,2</b> 0,3	<b>92,7</b> 0,4	<b>92,4</b> 0,6
OLR applied (kgCOD.m <sup>-3</sup> .d <sup>-1</sup> )	<b>0,59</b> 0,05	<b>0,86</b> 0,08	<b>1,98</b> 0,14
OLR removed (kgCOD.m <sup>-3</sup> .d <sup>-1</sup> )	<b>0,54</b> 0,05	<b>0,80</b> 0,07	<b>1,56</b> 0,17

Stimulus-response hydrodynamic experiments indicated that the reactors behaved as plug-flow, since the dispersion number ( $D/u.L$ ) value obtained was 0.0035 (Levenspiel, 1999). Considering this, and according to COD, SMX and CIP decay profiles presented in Figure 5, the kinetic model with best fit of the data was the first order model with residual concentration, expressed by equation 1. In this expression,  $C$  is the concentration in the bulk liquid,  $C_0$  is the concentration in the influent stream,  $\theta_h$  is the hydraulic retention time;  $k^{app}$  is the apparent first-order kinetic constant, and  $C_R$  is the residual concentration. These parameters are presented in Table 2.

$$C = C_R + (C_0 - C_R) \cdot e^{(-k^{app} \cdot \theta_h)} \quad (1)$$



**Figure 5.** COD, SMX and CIP removal spatial profiles along the bioreactor.

The increase in the antibiotic load from Phase II to Phase III resulted in a decrease in the removal kinetic constant for COD. Regarding SMX and CIP, the kinetic constants were not affected, but a higher residual concentration of these compounds was observed. It was also observed that  $k^{app}$  of CIP was greater than  $k^{app}$  of SMX, which may be due to the fact that CIP removal is linked to the amount of biomass present in the reactor, since this is more concentrated in the lower part of the reaction bed.

## CONCLUSIONS

The APBR was able to remove the antibiotics SMX and CIP from a synthetic wastewater simulating domestic sewage for HRT of 12 h. CIP removal was affected by the decrease in HRT from 12 to 8 h and in HRT of 4 h there was also a decrease in the efficiency of removal of COD and SMX. This may be due to the increase in the influent load of antibiotics, but also

**Table 2.** First-order kinetic expressions estimated for the degradation of COD, SMX and CIP

	$C_0^*$	$C_r^*$	$k^{app**}$	$r^2$
COD Phase I	269	46	0,74	0,929
COD Phase II	267	31	0,73	0,993
COD Phase III	317	14	0,62	0,860
SMX Phase I	309	15	0,70	0,997
SMX Phase II	262	21	0,63	0,992
SMX Phase III	347	104	1,00	0,891
CIP Phase I	375	29	0,74	0,960
CIP Phase II	407	172	1,00	0,992
CIP Phase III	443	104	0,95	0,948

\* Units of  $C_0$  and  $C_r$  in  $mg.L^{-1}$  for COD and  $ng.L^{-1}$  for SMX and CIP;

\*\* Unit of  $k^{app}$  in  $h^{-1}$ .

possibly by the decreasing of the diffusive transport to the biofilm, resulting from the higher ascending velocity in the bed. The application of HRT less than 12 hours is not adequate for CIP removal. For SMX, there is a minimum limit of 8 hours of HRT for its effective removal in anaerobic fixed bed. A strong correlation was found between the removal of COD and SMX, which may be due to cometabolic biodegradation in the micropollutant removal. On the other hand, removal of CIP seems to be associated with the concentration of biomass present in the bed, possibly due to the sorption mechanism. The fixed bed reactor with polyurethane foam are a promising technology to remove recalcitrant compounds with high efficiency using low HRT, and they can be applied with success in the domestic sewage treatment.

## REFERENCES

- APHA – American Public Health Association; AWWA – American Water Works Association; WEF – Water Environment Federation. Standard methods for the examination of water and wastewater. 21st. Edition. Washington D.C., 2005.
- Bila, Daniele Maia; Dezotti, Márcia. Fármacos no meio ambiente. *Química Nova*, v. 26, n. 4, p. 523-530, 2003.
- Bouki, Chryssa; Venieri, Danae; Diamadopoulos, Evan. Detection and fate of antibiotic resistant bacteria in wastewater treatment plants: a review. *Ecotoxicology and environmental safety*, v. 91, p. 1-9, 2013.
- Chatila, Sami et al. Sulfamethoxazole and ciprofloxacin removal using a horizontal-flow anaerobic immobilized biomass reactor. *Environmental technology*, p. 1-7, 2015.
- Clara, Manfred et al. Removal of selected pharmaceuticals, fragrances and endocrine disrupting compounds in a membrane bioreactor and conventional wastewater treatment plants. *Water research*, v. 39, n. 19, p. 4797-4807, 2005.
- Cuel, Maressa Fabiano et al. Solution of a heterogeneous modeling of a horizontal-flow anaerobic immobilized biomass (HAIB) reactor by the sequencing method. *Canadian Journal*
- Gijzen, H. J. et al. Anaerobic degradation of papermill sludge in a two-phase digester containing rumen microorganisms and colonized polyurethane foam. *Biotechnology letters*, v. 10, n. 1, p. 61-66, 1988.
- Göbel, Anke et al. Occurrence and sorption behavior of sulfonamides, macrolides, and trimethoprim in activated sludge treatment. *Environmental Science & Technology*, v. 39, n. 11, p. 3981-3989, 2005.
- Godoi, L. A. G.; Damianovic, M. H. R. Z.; Foresti, E. Sulfidogenesis interference on methane production from carbohydrate-rich wastewater. *Water Science and Technology*, v. 72, n. 9, p. 1644-1652, 2015.
- Gomes, Paulo CF Lima et al. Rapid determination of 12 antibiotics and caffeine in sewage and bioreactor effluent by online column-switching liquid chromatography/tandem mass spectrometry. *Analytical and bioanalytical chemistry*, v. 407, n. 29, p. 8787-8801, 2015.
- Heberer, Thomas. Occurrence, fate, and removal of pharmaceutical residues in the aquatic environment: a review of recent research data. *Toxicology letters*, v. 131, n. 1, p. 5-17, 2002.
- Hirsch, Roman et al. Occurrence of antibiotics in the aquatic environment. *Science of the Total Environment*, v. 225, n. 1, p. 109-118, 1999.
- Huang, Ching-Hua et al. Assessment of potential antibiotic contaminants in water and preliminary occurrence analysis. *Journal of Contemporary Water Research and Education*, v. 120, n. 1, p. 4, 2001.
- Karthikeyan, K. G.; Meyer, Michael T. Occurrence of antibiotics in wastewater treatment facilities in Wisconsin, USA. *Science of the Total Environment*, v. 361, n. 1, p. 196-207, 2006.
- Kümmerer, K. The presence of pharmaceuticals in the environment due to human use – present knowledge and future challenges. *The Journal of Environmental Management*, v. 90, p. 2354-2366, 2009.
- Levenspiel O, *Chemical Reaction Engineering*, 3rd edn. Wiley, New York (1999).
- Miège, Cecile et al. Fate of pharmaceuticals and personal care products in wastewater treatment plants—Conception of a database and first results. *Environmental Pollution*, v. 157, n. 5, p. 1721-1726, 2009.
- Mockaitis, G. et al. Continuous anaerobic bioreactor with a fixed-structure bed (ABFSB) for wastewater treatment with low solids and low applied organic loading content. *Bioprocess and biosystems engineering*, v. 37, n. 7, p. 1361-1368, 2014.
- Queiroz, F. B. et al. Occurrence of pharmaceuticals and endocrine disruptors in raw sewage and their behavior in UASB reactors operated at different hydraulic retention times. *Water Science & Technology*, v. 66, n. 12, 2012.
- Ripley, L. E.; Boyle, W. C.; Converse, L. C. (1986). Improved alkalimetric monitoring for anaerobic digestion of high-strength wastes. *Journal WPCF*, v. 58, p. 106-111.
- Sahoo, Krushna et al. Antibiotic use, resistance development and environmental factors: a qualitative study among healthcare professionals in Orissa, India. *BMC Public Health*, v. 10, n. 1, p. 1, 2010.
- Santos, C. E. D., Moura, R. B., Damianovic, M. H. R. Z., Foresti, E. (2016). Influence of COD/N ratio and carbon source on nitrogen removal in a structured-bed reactor subjected to recirculation and intermittentaeration (SBRRIA). *Journal of environmental management*, 166, 519-524.
- Segura, Pedro A. et al. Review of the occurrence of anti-infectives in contaminated wastewaters and natural and drinking waters. *Environ Health Perspect*, v. 117, n. 5, p. 675-684, 2009.
- Silva, A. J. et al. Evaluation of support materials for the immobilization of sulfate-reducing bacteria and methanogenic archaea. *Anaerobe*, v. 12, n. 2, p. 93-98, 2006.
- Sipma, Jan et al. Comparison of removal of pharmaceuticals in MBR and activated sludge systems. *Desalination*, v. 250, n. 2, p. 653-659, 2010.
- Varesche, M. B. et al. Microbial colonization of polyurethane foam matrices in horizontal-flow anaerobic immobilized-sludge reactor. *Applied Microbiology and Biotechnology*, v. 48, n. 4, p. 534-538, 1997.
- Zorita, Saioa; mårtensson, Lennart; Mathiasson, Lennart. Occurrence and removal of pharmaceuticals in a municipal sewage treatment system in the south of Sweden. *Science of the total environment*, v. 407, n. 8, p. 2760-2770, 2009.

# **Influence of nutrients and pH on the efficiency of vertical flow constructed wetlands treating winery wastewater**

Ref # S2SMALL-94718

O.G. Gonzalo, M. Sánchez, S. Yáñez, I. Ruiz, M. Soto\*

Dept. of Chemistry. *Faculty of Sciences & CICA. University of A Coruña, E-15071, A Coruña, Galiza, Spain. \*m.soto@udc.gal*

## **Abstract**

Winery wastewater is characterized by high organic content, low nutrient content and low pH at least during vintage periods. The effect of nutrient shortage and low pH on constructed wetlands (CWs) operation was scarcely studied, but early field studies indicate that some operational problems can arise. This work aims to determine the effect of nutrient shortage and acidic pH during the treatment of high organic load wastewater in one-step vertical subsurface flow (VF) CWs. A synthetic substrate simulating winery wastewater (about 2000 mg COD/L) was fed to two lab scale VF units at hydraulic loading rates over 75 mm/d and surface loading rate in the range of 110-170 g COD/m<sup>2</sup>·d. Effluent characteristics in steady state conditions were determined for subsequent operational periods with and without nutrients in the influent as well as for periods with influent pH of 7.0 and 4.5. The results showed that neither low nutrient nor low pH impair organic matter removal whilst low pH decreased nitrogen removal rates.

## **Keywords**

Constructed wetlands, subsurface flow, winery wastewater, high organic load, low pH, nutrient shortage

## **INTRODUCTION**

The wine industry produces wastewater throughout the different processes of wine production. Winery wastewater comes mainly from the washing waters of equipment and bottles and from the cooling processes and represents a serious environmental problem in wine-producing countries. This requires the adoption of measures ensuring that their potential environmental impacts are minimal and within an acceptable range (Bolzonella and Rosso, 2009; Masi et al., 2015).

Wastewater flow and concentration greatly vary over the year in relation to the working period (vintage, racking, bottling), the size of the winery (most of them are relatively small), the product (red, white and special vines, and sub-products such as spirits), or the strategy for the management of wastes (Petruccioli et al., 2002; Fernández et al., 2007). Winery wastewaters contain higher concentrations of soluble organic matter readily biodegradable and a lower content of suspended solids. Chemical oxygen demand (COD) concentrations vary from 340 to 49.000 mg/L, total suspended solids (TSS) from 12 to 18.300 mg/L and biological oxygen demand (BOD<sub>5</sub>) is about 0.4-0.9 of the COD value (Shepher et al, 2001; Petruccioli et al, 2002; Mosteo et al. 2006; Masi et al, 2015).

The concentration of nitrogen and phosphorus compounds in winery wastewaters is usually low and the pH shows acidic values varying from 3.5 to 7. Low pH is due to the presence of organic



acids therein, but high COD concentration is due to ethanol and sugar, which represent more than 90% of the organic load. Then the recalcitrant constituents represent about 0.1-5% the total COD (Rodríguez et al., 2007; Vymazal, 2014).

Conventional treatment systems are not effective for the wine industry (Petruccioli et al., 2002; Mosteo et al., 2006), as wastewater from these facilities is highly concentrated in terms of COD and have shown highly variable flows and loadings (daily and seasonal). So, the need for the development of non-conventional biotreatments, either aerobic or anaerobic treatments arise (Petruccioli et al., 2002; Grismer et al., 2003; Artiga et al., 2005; Mosteo et al., 2006). Natural treatments like constructed wetlands (CWs) have also been taken into consideration (Masi et al., 2002; Grismer et al., 2003; Mulidzi, 2007; Vymazal, 2014). CW can assimilate large variable flows and organic loadings, neutralizing pH, and, due to its low maintenance and operational costs, makes them an attractive treatment system for moderately sized wineries.

In the last two decades, CWs have been successfully applied to different kind of effluents, including wastewater from petrochemical industry, food industry (meat processing, dairy industry, fruit and vegetable canning), forestry, winery and distillery, textile, tanning, aquaculture, metal finishing and mining, among others (Vymazal, 2014; de la Varga et al., 2016). The application of wetland systems for the treatment of wineries wastewater started in around 2000s in the USA, France, Italy, Germany, Spain and South Africa. Nowadays, there are, for instance, about 100 CW systems operating in Northern and Central Italy for wineries wastewater (Masi et al., 2015). The surface loading rates (SLRs) applied to the 13 CW systems reviewed by Masi et al. (2015) ranged from about 30 up to about 5,000 g COD/m<sup>2</sup> d, with the 80th percentile of the reported values being below 297 g COD/m<sup>2</sup> d and the median at 164 g COD/m<sup>2</sup> d. The highest SLR values have in all cases been measured during the peak season (vintage) and often linked to lower surface removal rates (SRRs). Percentage removal rate showed a high variability, ranging from 49% to 99%. Single stage CW, horizontal subsurface flow beds in most cases or also vertical subsurface flow beds are used for smaller size wineries whilst for the bigger wineries instead the more adopted solutions are combinations of wetland systems (called multistage treatment wetlands) or combinations of CWs with other technologies, like anaerobic digestion systems or aerobic biological treatments (Masi et al., 2015).

Among the main problems in processing winery wastewater, Masi et al. (2015) listed variable pH and low nutrient content and consequent unfavorable C/N ratio for the microbial growth. Wallace and Liner (2010) indicated that a key index which appears to control wetland treatment effectiveness is the availability of sufficient nutrients to allow adequate growth of microbial communities in response to pollutant loadings. The positive effect of nutrient addition was demonstrated in two wetland systems treating a nutrient-deficient waste stream (aircraft deicing runoff) in which the treatment performance improved in response to nutrient addition and operational problems such as foaming and slime formation were eliminated (Wallace and Liner, 2010, 2011; Murphy et al., 2014).

Aircraft deicing runoff shows long periods of low BOD<sub>5</sub> concentrations followed by sudden shock loads caused by a de-icing event lasting for approximately one month (Murphy et al., 2014). This flow profile is similar to that of most wineries. Masi et al. (2015) stated that a cause of some of the different performances observed in CW systems treating winery effluents could be the content in nutrients as a limiting factor for the bacterial activity. Because the processes in the HF CW are mainly anaerobic and in the VF CW are aerobic and anaerobic bacteria require much less nutrients than aerobes, a large negative effect of nutrient shortage can be more expected in the case of VF CWs than for HF CWs. However, Masi et al. (2015), points out that even VF CWs are extensive systems in which the growth and accumulation of biomass should

be low, and then the need of nutrients should also be low. However, Murphy et al. (2014) found high yield ratios (0.77-0.90 kg bacteria per kg BOD<sub>5</sub>) which were typical of technologies with rapid growth of bacteria, whilst technologies that rely on very stable and mature bacteria populations have lower yield ratios (Wallace and Liner, 2011). Thus, considering the large variability of treatment efficiency and surface removal rates in CW systems treating winery wastewater and the sudden increase in applied loading rates during the vintage period, our hypothesis is that a negative effect of nutrient shortage on the treatment efficiency of CW treating this kind of effluents may not be discarded. Low nutrient effects would likely be present in the case of VF CWs units treating winery effluents diverted from other wastewater streams such as black water from restrooms and nearby households and restaurants. In some cases, these different kinds of effluents can increase the level of nutrients in the treated wastewater (Serrano et al., 2011; Rozema et al., 2016).

The acidity of winery wastewater in particular during vintage can also be considered as another factor influencing the performances, even though in most of the experiences examined by Masi et al. (2015), the need for chemical neutralization has not been considered. However, Serrano et al. (2009, 2011) indicated the possibility of a negative effect caused by the low pH values registered, which ranged from 3.3 to 7.2, and reported the use of sodium hydroxide addition to the influent.

This work aims to determine the effect of nutrient shortage and acidic pH during the treatment of high organic load wastewater in VF CWs.

## **MATERIAL AND METHODS**

Two lab columns (VF1 and VF2 units) of 13.9 cm diameter were used as VF CW systems. The effective height was 50 cm, consisting of an upper layer of 5 cm of 0.25-2 mm sand, a main filtering layer of 35 cm of 4-8 mm gravel, and a 10 cm drainage layer at the bottom of 8-16 mm gravel. FV units were fed intermittently by pulses each 3 hours for 4 days with rest periods of 3 days a week. Both columns were planted with *Phragmites australis* and monitored during subsequent operational periods with and without nutrients in the influent (VF1) as well as with an influent pH of 6.5 and 4.5 (VF2).

The influent entered the VF units over the filtering medium by means of a peristaltic pump (Dinko Instruments D-21V) in an intermittent mode and drained by gravity to the bottom of the column and from there to a receiving tank. The units were operated without resting (12 pulses per day) during start-up period and, onwards, with a week regime of 4 days feeding and 3 days resting (8 pulses per day). The infiltration rate was periodically determined in both columns. For this, the effluent flow was measured for an entire dosing cycle in order to obtain the effluent flow profile and derived parameters, particularly the mean retention time ( $t_m$ ), defined as the time required to drain off the 50% of the wastewater volume added in a feeding pulse.

Total suspended solids (TSS), chemical oxygen demand (COD), biochemical oxygen demand (BOD<sub>5</sub>), total nitrogen (TN), nitrate nitrogen NO<sub>3</sub><sup>-</sup>-N, ammonia nitrogen (NH<sub>4</sub><sup>+</sup>-N) and phosphates (PO<sub>4</sub><sup>3-</sup>-P) were determined in weekly composite samples. Besides, in situ measurement of pH, dissolved oxygen (DO) and oxidation-reduction potential (ORP) was carried out. Allylthiourea was used as a nitrification inhibitor in BOD<sub>5</sub> assays. Analytical methods were carried out in duplicated as described in Standard Methods (APHA, 2005). An integrated pH & redox 26 Crison electrode was used for pH and ORP determination, a selective electrode (Crison 9663) for ammonia and a YSI ProODO electrode for DO. The determination of NO<sub>3</sub><sup>-</sup>-N was made in a Biochrom Libra S6 spectrophotometer following the second derivative method of the UV absorption spectrum (APHA, 2005). To analyze TN, samples were

first digested with potassium persulfate to oxidize all the nitrogenous compounds to  $\text{NO}_3^-$  and after that the nitrates were determined by spectrophotometry.

To prepare the synthetic feed, red wine and white vinegar have been used as sources of organic matter, whose COD concentrations were 203 g/L and 71 g/L, respectively. These components as well as sources of macro and micro nutrients were added as indicate in Table 1 to prepare a concentrate stock solution. From several considerations about the requirements of N and P for bacterial growth and typical biomass yields in CWs (Henze et al., 2002; Wallace and Liner, 2011), a COD/N/P ratio of 250/7/1 was used as reference for non-limitation of nutrients. The concentrated was first diluted with distilled water to the required concentration and the pH was regulated to circa neutral (6.5-7.0) or acidic (4.5) values, as required. On the other hand, nutrients were not added to the VF1 unit during some operational periods.

**Table 1. Concentrate stock solution composition for synthetic wastewater preparation.**

Compound	Added amount
Red wine (mL/L)	33
White vinegar (mL/L)	188
$\text{NH}_4\text{Cl}$ (mg/L)	2140
$\text{MgHPO}_4 \cdot 3\text{H}_2\text{O}$ (mg/L)	220
$\text{K}_2\text{HPO}_4 \cdot 3\text{H}_2\text{O}$ (mg/L)	290
Peptone (mg/L)	300
$\text{FeSO}_4 \cdot 7\text{H}_2\text{O}$ (mg/L)	100
$\text{CaCl}_2$ (mg/L)	100
$\text{Cr}(\text{NO}_3) \cdot 9\text{H}_2\text{O}$ (mg/L)	15
$\text{CuCl}_2 \cdot 2\text{H}_2\text{O}$	10
$\text{MnSO}_4 \cdot \text{H}_2\text{O}$	2
$\text{NiSO}_4 \cdot 6\text{H}_2\text{O}$	5
$\text{PbCl}_2$	2
$\text{ZnCl}_2$	5

## RESULTS AND DISCUSSION

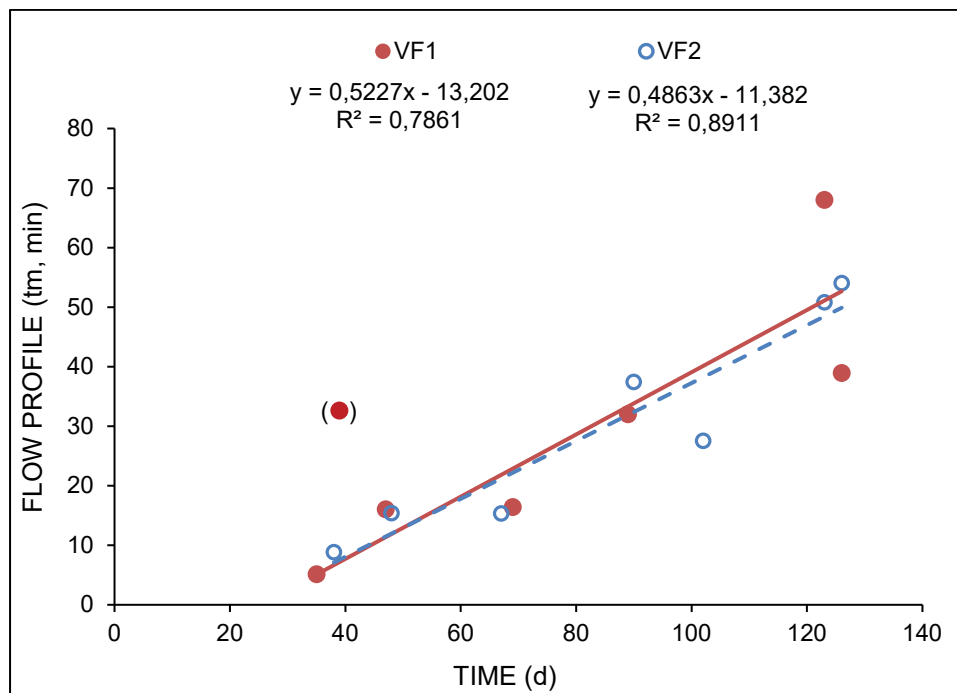
### Start-up and operation of VF units treating high strength winery wastewater

The operational characteristics of the VF units are shown in Tables 2 and 3. The start-up period lasted 43 days and was followed by a reference period of 2-3 weeks in which both columns operated in the same conditions. Subsequently, VF1 unit was subjected to nutrient shortage and VF2 unit to low pH for about 2 months of operation (Table 2). The influent COD concentration was established in the range of 1500 to 2100 mg/L, which was considered representative of winery wastewater during harvesting and wine making periods (Serrano et al., 2011).

During the start-up period, both columns were fed with a high hydraulic loading rate and so with a high surface loading rate, which averaged  $133 \pm 13$  and  $172 \pm 44$  g COD/m<sup>2</sup>·d for VF1 and VF2 CW units, respectively. The higher SLR applied in VF2 in relation to VF1 can explain the higher effluent concentration in COD and BOD<sub>5</sub> and the slightly lower COD and BOD<sub>5</sub> percentage removal in VF2. In any case, COD removal was high, reaching 88% in VF2 and 95% in VF1, whilst BOD<sub>5</sub> removal was approximately 97% in both cases.

Nutrient removal was high during the start-up period, reaching 86-89% removal of ammonia and total nitrogen, and 60% to 76% of phosphorus. Nutrient SLR were relatively high meaning that the columns removed about 3.5-4.5 g TN/m<sup>2</sup>·d. Accounting up for COD and TN removal, the performance of both VF units is indicative of high oxygen transfer rates (Torrijos et al., 2016). During start-up, a large part of the removed nutrients had probably been used for biomass growth, as suggested by estimation of biomass yields and required nutrient availability in similar conditions (Murphy et al., 2014). Nutrient limitations have not been observed because the effluent of both columns still contained sufficient nitrogen and phosphorus compounds (Table 3).

DO concentration and ORP was about 6 mg/L and 90 mV, respectively, at the end of the start-up period of both columns. Mean effluent BOD<sub>5</sub> ranged from 34 mg/L (VF1) to 42 mg/L (VF2) indicating that both columns were slightly overloaded. The flow profile of each feeding pulse showed a mean retention time ranging from 5 to 10 min (Fig. 1). However, VF1 column suddenly increased the pulse mean retention time to approximately 30 min (day 39 of operation), indicating a risk of flow clogging. Two measures have been applied in order to improve operation and reduce the risk of clogging. The feeding regime was changed by introducing resting periods, the columns being fed on a 4 days feeding and 3 days resting, on a week basis. In addition, the influent concentration was reduced as indicated in Table 2, reducing the SLR to 111±6 g COD/m<sup>2</sup>·d and 67±4 mg BOD<sub>5</sub>/m<sup>2</sup>·d as mean values for both columns since the end of the start-up period to the end of operation period. In this way, during periods II to IV (Table 2) both columns received similar and constant HLR and SLR (COD and BOD<sub>5</sub>) which were only 2.4% higher in VF1 in comparison to VF2.



**Fig. 1.** Evolution of mean retention time ( $t_m$ ) in both VF units over the operation time (the VF1 point into brackets was not included in the regression fit).

The flow profile was similar in both units throughout the entire period of operation (Fig. 1), but  $t_m$  increased steadily over the operation time. After approximately 100 d of operation,  $t_m$  reached 40 min and the columns began to experience clogging episodes revealed by more prolonged flooding of the surface after a feeding event. This situation coincided with a strong increase of suspended solids content in the effluent of both units (Fig. 2A). In addition, a clear, although limited, decrease in DO content took place (Fig. 2D). Effluent TSS was lower in VF1 than in

VF2 during the first three months of operation but onwards became higher. In overall, effluent concentration of TSS was higher than influent concentration and probably corresponded to the washout of active biomass. Washed TSS were mainly volatile and contributed to an increase in COD and BOD<sub>5</sub> in the effluent (Fig. 2B and C).

### The effect of nutrient shortage on the VF unit performance

The shortage of nutrients in the influent reduced both the effluent concentration and the percentage removal of nitrogen and phosphorus, but the effect on COD and BOD<sub>5</sub> was negligible (Table 3). SS concentration in effluent ranged from 10 to 30 mg/L, being not affected by the changes in nutrient content or pH, but by the operation time as discussed in Section 3.1.

**Table 2.** Characteristics of the synthetic winery wastewater fed to both CW units.

Period (CW)	pH	TSS	COD	BOD <sub>5</sub>	TN	NO <sub>3</sub> -N	NH <sub>4</sub> -N	PO <sub>4</sub> -P	Q <sub>v</sub> VF1	Q <sub>v</sub> VF2
I) Start-up (VF1, VF2)	6,9	23	2128	1290	64,4	3,8	64,4	9,3	964	1247
II) Reference (VF1, VF2)	6,5	18	1573	954	47,6	2,9	47,6	6,9	1093	1026
III) Low nutrients (VF1) <sup>a</sup>	6,5	18	1573	954	3,4	2,6	2,0	0,7	1090	-
IV) Low nutrients (VF1) <sup>a</sup>	6,5	5	1573	954	1,6	2,0	2,0	0,6	1087	-
III) Low pH (VF2)	4,5	18	1573	954	47,6	2,9	47,6	6,9	-	1079
IV) Reference pH (VF2)	6,5	18	1573	954	47,6	2,9	47,6	6,9	-	1132

Concentration in mg/L, except pH. Q<sub>v</sub> in mL/d. <sup>a</sup> The synthetic wastewater contained only wine, vinegar and peptone (Period III) or only wine and vinegar (Period IV).

Significant differences were not found for effluent COD from VF1 at period III (without nutrient addition) with respect to period II of both VF1 and VF2 nor with respect to period III of VF2. Although effluent COD from VF1 at period III (also without nutrient addition) was higher than effluent COD from VF1 at period II, this can be attributed to the TSS washout due to partial clogging of filtering media (as discussed in Section 3.1) and not to the effect of the lack of nutrients. In fact, effluent COD from VF1 at period III was not statistically different from effluent COD of VF2 at period IV (with nutrient addition and circa neutral influent pH). In this way, the mean COD and BOD<sub>5</sub> removal during an operation period of about 2 months with high organic load (1573 mg COD/L, 954 mg BOD<sub>5</sub>/L) and very low nitrogen and phosphorus load (below 3 mg N/L and 1 mg P/L) remained above 93 and 97%, respectively, and very close to those of reference period.

The change of the influent with nutrients to the influent without nutrients had a reduced effect on the effluent concentration of nitrogen and phosphorus compounds because this concentration was already very reduced due to the efficient removal in the reference period. The effluent concentration of nutrient compounds still decrease during period III and positive removal percentages were maintained. However, during period IV, mainly during the last days of this period, the increase in effluent TSS (Fig. 2A) was accompanied by a slight increase in nutrient concentration which led to negative removal percentages during period IV of VF1 (Table 3).

Murphy et al. (2014) pointed out that the metabolic response of heterotrophic bacteria growing under nutrient-limited conditions is to produce an excess of polysaccharide slime, which can result in reduced hydraulic performance. In this situation, an increase of viscosity occurs. However, in our study, effluent viscosity was low, being only 7% (VF1) and 3% (VF2) higher than that of distilled water at period IV. Richard (2003) stated that checking for nutrient deficiency is to be sure that some ammonia or nitrate and ortho-phosphate remain in the effluent at all times, and recommended effluent total inorganic nitrogen (ammonia plus nitrate) and ortho-phosphate concentrations of 1-2 mg/L to ensure sufficient nutrients. Following these



criteria, nutrient deficiency did not occur in this study during the treatment of low nutrient wastewater. In fact, effluent concentration of inorganic nitrogen and ortho-phosphate still increased during the last days of period IV (VF1) probable due to nutrient recycling in the filtering bed.

**Table 3.** Effluent concentration and removal efficiency of the VF1 and VF2 columns.

Period	VF1				VF2			
	I	II	III	IV	I	II	III	IV
Operation days	0-43	44-59	60-80	81-124	0-43	44-65	66-113	114-128
pH	7.37±0.12	6.93±0.26	7.0±0.13	7.18±0.14	7.36±0.12	6.9±0.24	5.64±0.25	7.05±0.07
DO (mg/L)	4.24±2.25	7.35±0.46	8.75±0.57	8.01±1.8	4.02±2.62	6.81±0.94	8.43±1.06	7.26±0.27
ORP (mV)	94.0±50.9	151±22	164±23	206±18	83±57	131±39	298±22	193±26
TSS (mg/L)	27±10	11±4	13±2	48±38	33±9	18±5	17±4	101±72
COD (mg/L)	102.2±42.9 <sup>b</sup>	40±16 <sup>a</sup>	47±8 <sup>a</sup>	106±58 <sup>b</sup>	261±144 <sup>c</sup>	48±22 <sup>a</sup>	37±16 <sup>a</sup>	158±75 <sup>b,c</sup>
BOD <sub>5</sub> (mg/L)	34.0±nd	15±7	15±5	27±12	41±8	10±8	9±7	32±nd
TN (mg/L)	9.2±1.9	2.8±(nd)	1.4±1.1	2.1±1.7	8.3±1.8	3.2±1.6	28±3.9 <sup>d</sup>	17.5±11.3
NO <sub>3</sub> <sup>-</sup> -N (mg/L)	1.2±1.7	0.5±0.6	0.4±0.7	0.4±0.6	nd	1.5±0.6	3.5±0.5	1.3±0.6
NH <sub>4</sub> <sup>+</sup> -N (mg/L)	7.3±2.2	5.8±2.0	2.4±1.4	3.1±1.0	8.6±4.9	4.9±2.3	37.7±0.8 <sup>d</sup>	5.6±3.6
PO <sub>4</sub> <sup>3-</sup> -P (mg/L)	3.8±3.3	1.7±0.2	0.6±0.4	0.7±0.3	2.3±1.4	2.7±0.7	2.2±0.4	6.3±1.9
Removal								
COD (%)	95.2±1.3	97.4±1.0	97.0±0.5	93.3±3.7	87.7±6.8	97.0±1.4	97.7±1.0	90.0±4.8
BOD <sub>5</sub> (%)	97.4±1.0	98.4±0.7	98.4±0.5	97.1±1.3	96.8±0.6	99.0±0.9	99.1±0.8	96.6±nd
TN (%)	85.7±3.0	92.5±6.2	58.8±33.6	-32±107	87.2±6.8	93.2±3.3	41.2±8.2	63.3±18.1
NH <sub>4</sub> <sup>+</sup> -N (%)	88.7±3.4	87.7±4.3	17.5±10.6	-54±52	86.6±7.7	89.6±4.7	20.8±1.6	88.3±21.1
PO <sub>4</sub> <sup>3-</sup> -P(%)	59.4±34.8	75.8±3.1	10.9±66.2	-19.8±54	75.9±14.8	60.7±10.4	68.4±6.5	9.4±33.4

<sup>a,b,c</sup> Statistical analysis of effluent COD (pair comparison through one-way ANOVA): different letters indicated statistically differences between mean values. <sup>d</sup> Steady state concentrations achieved 3 weeks since influent pH reduction.

In this work, a COD/N/P ratio of 250/7/1 was used for the start-up and reference periods (I and II for VF1), which corresponded to a potential biomass yield of 0.66 g biomass/g BOD<sub>5</sub> (assuming BOD<sub>5</sub>/COD ratio of 0.5 and 8.5 N of cell composition). During low nutrient periods (III and IV), the COD/N/P ratio increased up to 7500/7/2.5 (potential yield of 0.02). Although the COD/TN ratio in the influent was very low, the small amounts of nutrients available in the synthetic winery wastewater in combination with nutrient recycling in VF1 CW appear to be sufficient for efficient treatment. On the other hand, if nutrients were to be added, the required amounts would be much lower than those proposed by Murphy et al. (2014) for CWs treating aircraft de-icing runoff, who indicate nutrient dosing for a yield of 1.0.

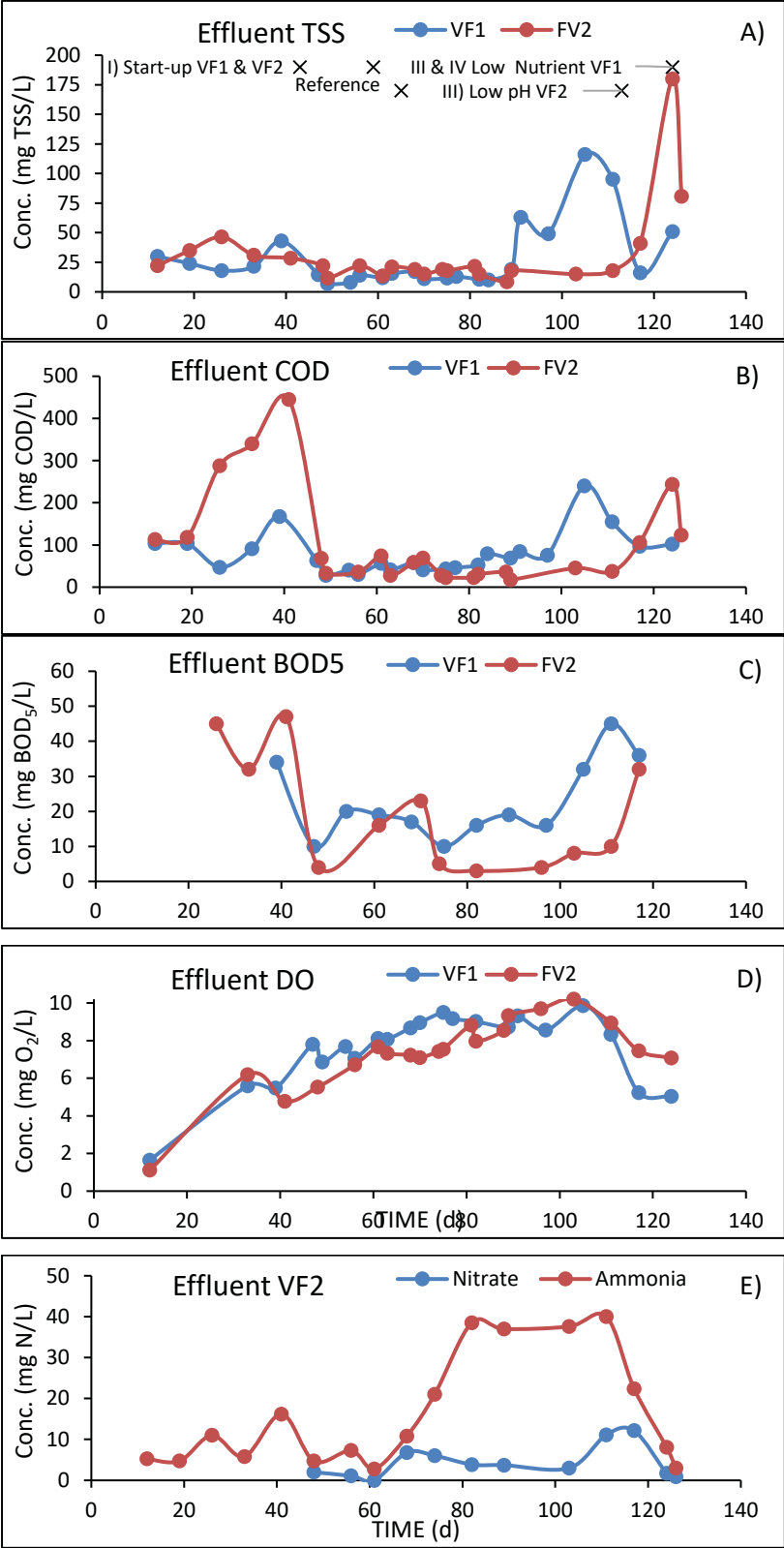
According to de la Varga et al. (2016), winery wastewater should not be diverted from other wastewater streams generated in the winery in order to guarantee a minimal level of nutrient availability. In fact, different kind of effluents can increase the level of nutrients in the treated wastewater (Serrano et al., 2011; Rozema et al., 2016).

### The effect of low pH on the VF unit performance

The operation at low pH of 4.5 (period III, VF2) did not reduce the COD, BOD<sub>5</sub> and phosphate removal efficiency (Table 3). Significant differences were not found for effluent COD from



VF2 at period III (influent pH of 4.5) with respect to period II (influent pH of 6.5) of both VF1 and VF2. High percentage removals of 97-98% (COD), 99% (BOD5) and 61-68% ( $\text{PO}_4^{3-}\text{-P}$ ) were obtained at both influent pH values of 6.5 and 4.5.



**Fig. 2.** Evolution of VF1 and VF2 effluent concentration of TSS (A), COD (B), BOD<sub>5</sub> (C), DO (D) and VF2 nitrate and ammonia concentration (E).

These results are in accordance with the suggestion of Serrano et al. (2011). From multivariate analysis applied to a hybrid CW system treating winery wastewater on a field scale, these authors found that the long-term effect of low pH on the treatment efficiency (COD and BOD<sub>5</sub>) was insignificant. pH effect on the performance of horizontal subsurface flow CWs was also discarded by de la Varga et al. (2013).

However, low pH clearly reduces ammonia and total nitrogen removal (Fig. 2E). Effluent concentration of ammonia in VF2 showed a continuous increase during approximately 3 weeks after lowering the influent pH and then remained stable for the rest of period III. TN followed the same trend of ammonia, whilst nitrate suffered an initial increase up to 7 mg N/L and progressively decreased to 3.5 mg N/L. In spite of the reduction of nitrification, effluent nitrate during period III was higher than during period II and period IV (Table 3). In addition, ammonia removal decrease from 90% to 21% and TN removal from 93% to 41%. Thus, low influent pH impaired both nitrification and denitrification process. These effects of acidic influent pH occurred in spite that the effluent pH was kept above 5.5 (mean value of  $5.64 \pm 0.25$  during period III of VF unit, Table 3). This behaviour is typical of CW systems treating winery wastewaters. CWs have the capacity to increase the winery wastewater pH in some extension. For example, Serrano et al. (2011) reported a pH increase from  $5.0 \pm 1.2$  to  $6.0 \pm 0.9$  when treating winery wastewater at high SLR.

The fact that pH increases or decreases during wastewater treatment depends not only on the pH of the influent but also on the nature and extent of conversion processes in the CW. Treating domestic wastewater, VF CWs clearly enhance nitrification in comparison to horizontal flow CWs, but nitrate trend to accumulate in the final effluent and limit TN removal. Limited nitrogen removal was due to the pH decrease to approximately 4.5 which impaired both nitrification and denitrification in a two-step VF+VF CWs system (Torrijos et al, 2016). These authors reported that maintaining effluent pH above 6 through alkalis addition clearly increased nitrification and TN removal.

As indicated by Masi et al. (2015), potential effects of acidic influent pH on the efficiency of CWs treating winery wastewater remain unknown. Reports on this subject for other kind high organic load wastewater are scarce. Similar to winery wastewater, woodwaste leachate was characterized by high oxygen demand, tannin and lignin, and volatile fatty acids (VFAs), but low pH and nutrients. During woodwaste leachate treatment in CWs, nutrient addition and pH adjustments helped to improve contaminant removal (Masbough et al., 2005). Closer to neutral pH circumstances, along with higher mean temperatures during the warmer period of year, favoured microbial activity. Besides, Lattrie et al. (2005) reported that a CW treating multiple livestock wastewaters was not capable of reducing high levels of pollutants from the high strength silage leachate and its low pH. However, the results of the present study clearly indicate that an acidic influent of 4.5 pH did not impair the organic matter and phosphorus removal, whilst nitrogen removal rates appeared clearly reduced. This fact must be taken into account when operating CW systems that treat combined winery and another type of wastewater containing large amounts of nitrogen. As highlighted by Masi et al. (2015), this is a frequent situation in many small wineries in Europe.

In the present study, the negative effects of low influent pH were progressively overcome in a short 10 day period after influent pH increase as indicated by the results of period IV VF2 (Table 3).

## CONCLUSIONS

One-step VF CW units receiving influent COD concentration in the range of 1500 to 2100 mg/L reached percentage removals of 88-98% COD, 96-99% BOD<sub>5</sub>, 59-93% total nitrogen, 87-90%

ammonia and 59-76% phosphorus at high surface loading rate which ranged from 110 to 172 g COD/m<sup>2</sup>·d. Typical nutrient shortage of winery effluents and low pH do not affect the removal efficiency of COD and BOD<sub>5</sub>. The VF CW unit receiving an influent with a COD/N/P ratio 3500-7500/7/2.5 for a period of 2 months (approximately the length of peak loading of winery wastewater) maintained reduced but steady nutrient concentrations in the effluent due to the low biomass yield and nutrient recycling, which contributed to maintain the high treatment efficiency. However, low pH clearly produced high ammonia concentrations if nitrogen is present in the influent.

## REFERENCES

- APHA, 2005. Standard Methods for the Examination of Water and Wastewater, 21st ed. American Public Health Association/American Water Works Association/Water Environment Federation, Washington.
- Artiga, P., Ficara, E., Malpei, F., Garrido, J.M., Méndez, R. (2005). Treatment of two industrial wastewaters in a submerged membrane bioreactor. *Desalination* 179: 161-169.
- Bolzonella, D., Rosso, D., 2009. Winery wastewater characterization and biological treatment options. In: Proceedings of the Fifth International Specialized Conference on Sustainable Viticulture: Vinery Waste and Ecologic Impacts Management, Trento and Verona, Italy.
- de la Varga, D., Ruiz, I., Soto, M. (2013). Winery Wastewater Treatment in Subsurface Constructed Wetlands with Different Bed Depths. *Water Air Soil and Pollution* 224:1485-1497.
- de la Varga, D., Soto, M., Arias, C.A., van Oirschot, D., Kilian, R., Pascual, A., Álvarez, J.A. (2016). Constructed wetlands for industrial wastewater treatment and removal of nutrients. *En Val, A. Campos, J.L, Mosquera, A. (Ed.). Technologies for the Treatment and Recovery of Nutrients from Industrial Wastewater*. IGI Global, Hershey PA (USA), 202-230.
- Fernández, B., Seijo, I., Ruiz-Filippi, G., Roca, E., Tarenzi, L. and Lema, J.M. (2007). Characterization, management and treatment of wastewater from white wine production. *Water Science and Technology* 56: 121-128.
- Grismer, M.E., Carr, M.A. and Shepherd, H.L. (2003). Evaluation of constructed wetland treatment performance for winery wastewater. *Water Environmental Research*, 75(5): 412-421.
- Henze, M., Harremoës, P., Jansens, J., Arvin, E. (2002). *Wastewater treatment*. Springer-Verlag, New York.
- Lattrie, S., Gordon, R., Madani, A., Stratton, G. 2005. Performance evaluation of a constructed wetland treating multiple wastewaters. Paper presented at the ASAE Annual International Meeting, 17–20 July 2005; American Society of Agricultural Engineers: Tampa, Florida.
- Masbough, A., Frankowski, K., Hall, K.J., Duff, S.J.B. (2005). The effectiveness of constructed wetland for treatment of woodwaste leachate. *Ecological Engineering* 25, 552-566.
- Masi, F., Conte, G., Martinuzzi, N. and Pucci, B. (2002). Winery high organic content wastewaters treated by constructed wetland in mediterranean climate. IWA 8<sup>th</sup> International Conference on Wetland Systems for Water Pollution Control. Arusha, Tanzania, September, 2002.
- Masi, F., Rochereau, J., Troesch, S., Ruiz, I., Soto, M. (2015). Wineries wastewater treatment by constructed wetlands: a review. *Water Science and Technology* 71(8), 1113-1127.

- Mosteo, R., Ormad, P., Mozas, E., Sarasa, J. and Ovelleiro, J.L. (2006). Factorial experimental design of winery wastewaters treatment by heterogeneous photo-Fenton process. *Water Research*, 40: 1561-1568.
- Mulidzi, A.R. 2007. Winery wastewater treatment by constructed wetlands and the use of treated wastewater for cash crop production. *Water Science and Technology* 56: 103-109.
- Murphy, C.; Wallace, S.; Knight, R.; Cooper, D.; Sellers, T. (2014). Treatment performance of an aerated constructed wetland treating glycol from de-icing operations at a UK airport. *Ecological Engineering* 80. 117–124
- Petrucchioli, M., Duarte, J.C., Eusebio, A., Federici, F. (2002). Aerobic treatment of winery wastewater using a jet-loop activated sludge reactor. *Process Biochemistry*, 37: 821-829.
- Rodríguez, L. V., J.; Fernández, F.J. and Buendí, I.M. (2007). "Anaerobic co-digestion of winery wastewater." *Water Science and Technology* 56: 49–54.
- Rozema, E. R., Rozema, L.R., Zheng, Y. (2016). A vertical flow constructed wetland for the treatment of winery process water and domestic sewage in Ontario, Canada: Six years of performance data. *Ecological Engineering* 86, 262-268.
- Serrano, L; de la Varga, D; Díaz, M.A; Ruiz, I; Bondelle, R; Soto, M. (2009). HUSB-CW treatment system for winery wastewater. *Proceedings of the Fifth International Specialized Conference on Sustainable Viticulture: Vinery Waste and Ecologic Impacts Management, Trento and Verona, Italy.* 317-234.
- Serrano, L., de la Varga, D., Ruiz, I., Soto, M. (2011). Winery wastewater treatment in a hybrid constructed wetland. *Ecological Engineering* 37, 744–753.
- Shepher, H., Grismer, M.E., Tchobanoglous, G., 2001. Treatment of high-strength winery wastewater using a subsurface-flow constructed wetland. *Water Environmental Research*, 73(4): 394-403.
- Torrijos, V., Gonzalo, O.G., Trueba-Santiso, A., Ruiz, I., Soto, M., 2016. Effect of bypass and effluent recirculation on nitrogen removal in hybrid constructed wetlands for domestic and industrial wastewater treatment. *Water Res.* 103, 92–100.
- Vymazal, J. (2014). Constructed wetlands for treatment of industrial wastewater: A review. *Ecological Engineering* 73, 724–751.
- Wallace, S., Liner, M. (2010). Nutrient limitations in industrial treatment wetlands. 12th International Conference on Wetland Systems for Water Pollution Control, 1071-1074.
- Wallace, S; Liner, M. (2011). Design and performance of the wetland treatment system at the Buffalo Niagara International Airport. Accessible at: [http://www.intensifiedwetland.com/docs/95\\_IWA%20Newsletter.pdf](http://www.intensifiedwetland.com/docs/95_IWA%20Newsletter.pdf) (last access: 01/09/2016).

# Metagenomic 16S rRNA analysis of wastewater from a freshwater fish farm

Makino, I.<sup>1</sup>, Yahagi, Y.<sup>2</sup>, Nakayama, T.<sup>3</sup>

<sup>1</sup> Tohoku University, 1-1 Katahira, Aoba-ku, Sendai 9808579, Japan

<sup>2</sup> Shibaura Institute of Technology, 3-7-5 Toyosu, Koto-ku, Tokyo 1358548, Japan

<sup>3</sup> Tohoku Chemical Co., Ltd. Morioka, Iwate, Japan 020-0022

**Keywords:** 16rRNA Metagenomic analysis, fish farm, wastewater, fish pathogenic bacteria

## Introduction

Until 1980's, in Japan, water pollution phenomena in river and dam reservoirs had been not occurred in the mountain region. However, recently even in an altitude more than 500m of the mountain area, the serious water pollution is occurring (Tokyo Waterworks, 2011). We construct a hypothesis that the main reason of the water pollution is feeder rivers wastewater of the fish farm. We investigated the 16S Metagenomic analysis for the microbe group of the fish farm along river. The catchments area of water conservation forests for this study is located Kanto mountain aria covering west end Tokyo and east end Yamanashi. The Okutama dam reservoir is made lake and has four major feeder rivers, which are Taba, Ushiroyama, Kosuge, and Minetani. The total catchments area is 262.9km<sup>2</sup> and four rivers occupied 88.2% of the total river basin.

## Material and Methods

16S rRNA gene amplicon sequencing for Genomic DNA was extracted from each sample of environmental points with MagDEA DNA 200 (Precision System Science CO., Ltd, USA) according to manufacturers protocols. A 16S rRNA library preparation was performed according to 16S Metagenomic Sequencing Library Preparation protocol from Illumina (Illumina, 2016). Briefly, the V3-V4 hyper-variable regions of the 16S rDNA gene were amplified from purified genomic DNA with using primers attached overhang adapters. The monthly water quality survey data submitted by the Tokyo metropolitan bureau from 1977 to 2010 was used for water quality (Tokyo Waterworks, 1977 - 2011).

## Results and Discussion

Figure 1 shows the loading rate of total nitrogen (TN) in four feeder rivers. Figure 2 shows that of total phosphor (TP). Each loading rates calculated by total load of four feeder rivers defined 100. As shown in Figure 1 and 2, more than 40% of nutritive salts loading are occupied by Kosuge Rivers. There are five fish farms along Kosuge river.

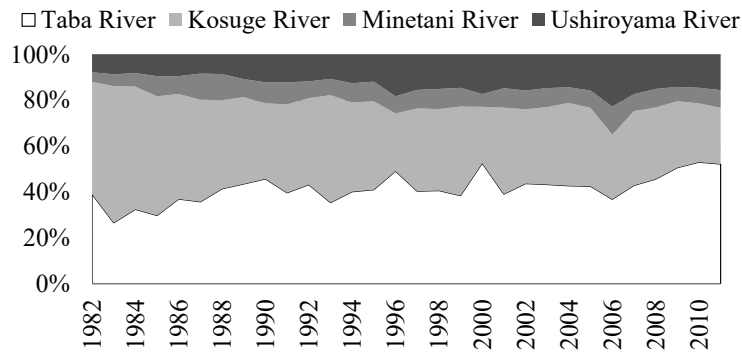


Figure 1. Runoff rate of TN in four inflow rivers

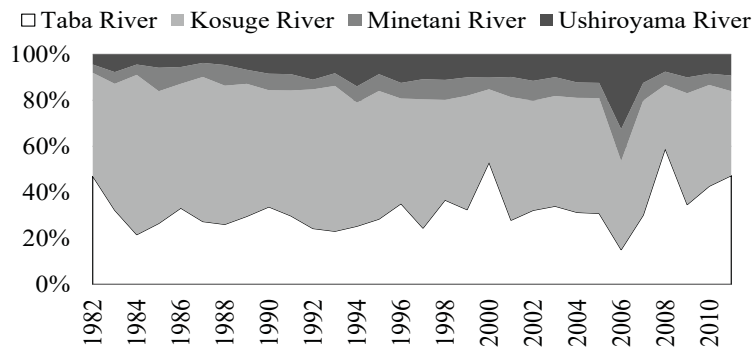


Figure 2. Runoff rate of TP in four inflow rivers

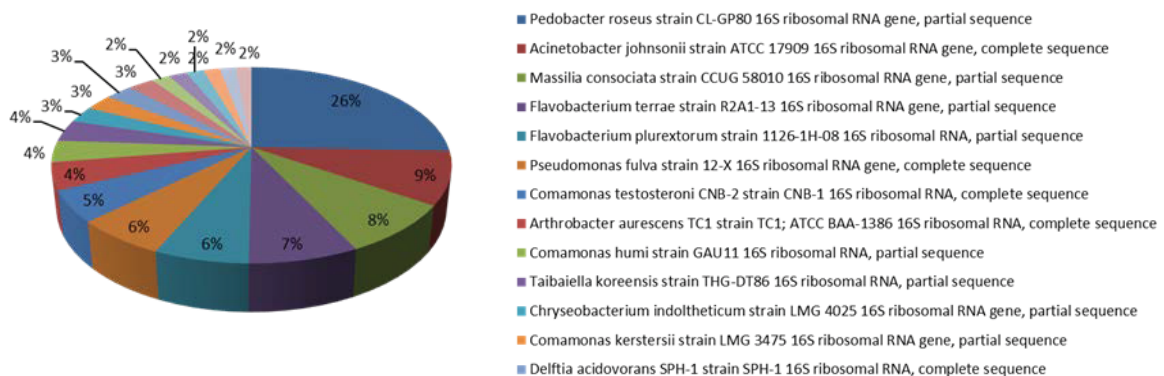


Figure 3. 16S Metagenomic analysis by wastewater of the fish farm

Figure 3 shows the 16s rRNA gene amplicon sequencing about wastewater of the fish farm. *Flavobacterium* (*Flavobacterium terrae* strain R2A1-13 16S ribosomal RNA gene, partial sequence and *Flavobacterium plurextorum* stain 1126-1H 08 16s ribosomal RNA, partial sequence) that causes cold water disease was 13% of the whole. These results suggested that fish farms are not only related to the water pollution of the rivers, but also have a direct influence on the growth of aquatic life.

## References

- Tokyo Waterworks, 2006. Reservoir management annual report in Tokyo Waterworks.
- Illumina, 2016. 16S Metagenomic Sequencing Library Preparation, 16s-metagenomic-library-prep-guide.
- Tokyo Waterworks, 1982-2011. Reservoir management annual report in Tokyo Waterworks.



## **Novel materials for catalytic ozonation of wastewater for disinfection and removal of micropollutants**

*Petr Kolosov, Viviane Yargeau, Francois-Johan Chassing*

Department of Chemical Engineering, McGill University, Montreal, Quebec, Canada

### **ABSTRACT**

This work aimed at the identification of novel materials to be used for the treatment by catalytic ozonation of wastewater to improve the removal of micropollutants and disinfection. Selection of the tested materials was based on their commercial availability, composition including elements known to have catalytic effects, and economic viability for use in the small and medium size treatment plants. Polonite<sup>®</sup>, wollastonite, zeolite, TiO<sub>2</sub>-Al<sub>2</sub>O<sub>3</sub> (8%/92%) were selected and tested in comparison to ozonation alone for the removal of contaminants of emerging concern (CECs) such as atrazine, ibuprofen, naproxen and gemfibrozil, as well as for disinfection based of *E. coli*. Synthetic wastewater was used to mimic municipal secondary effluent while obtaining constant and reproducible treatment conditions. Zeolite and wollastonite did not significantly promote disinfection and CEC removal in the range of conditions tested. TiO<sub>2</sub>-Al<sub>2</sub>O<sub>3</sub> provided significant improvement for both selected criteria - disinfection and CECs removal – when compare to the same ozone doses used in absence of the catalyst. Polonite<sup>®</sup> did not enhance the removal of CEC but lead to higher *E. coli* inactivation. These results suggest that both materials can act as catalyst and would lower the ozone dose required to reach the target disinfection in comparison to ozonation. We are currently continuing research with Polonite<sup>®</sup> and TiO<sub>2</sub>-Al<sub>2</sub>O<sub>3</sub> to investigate kinetics, mechanisms of action and reusability.

# Development and validation of performance evaluation protocol for small wastewater treatment MBR systems

Ref # S2SMALL- 38665

O. Kulesha<sup>1,2\*</sup>, Z. Maletskyi<sup>1</sup>, D. Todt<sup>3</sup>, H.Ratnaweera<sup>1</sup>

<sup>1</sup> Norwegian University of Life Sciences, PO Box 5003, 1432 Aas, Norway

<sup>2</sup> Kyiv Polytechnic Institute, 03056 Kyiv, Ukraine

<sup>3</sup> Ecomotive AS, Runde Miljøbygg, 6096 Runde, Norway

\* Corresponding Author: [olga.kulesha@nmbu.no](mailto:olga.kulesha@nmbu.no)

**Keywords:** submerged MBR, fouling, operation

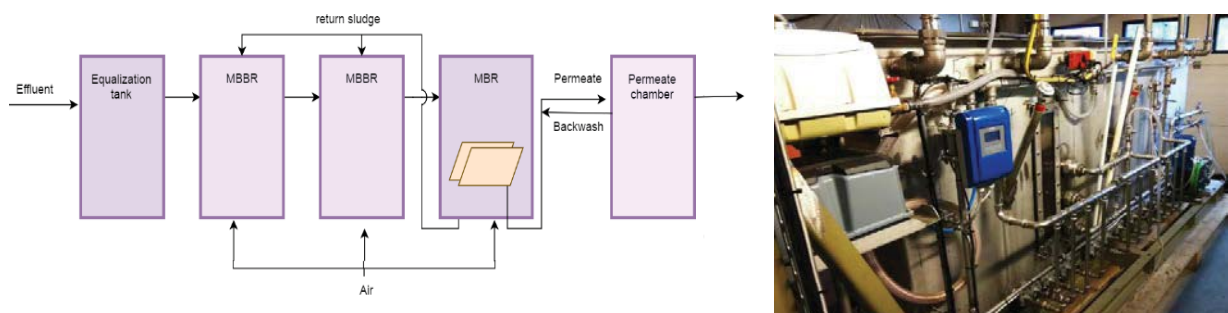
## INTRODUCTION / MAIN METHODS

Membrane fouling remains the main drawback to wider application of MBR technology in decentralized wastewater treatment (Hai et al., 2014). All known physical, chemical and biological prevention strategies require representative and continuous evaluation of MBR system performance. Conventional laboratory approach, based either on monitoring of trans-membrane pressure development during filtration at constant flux or flux decrease at constant pressure, together with chemical and biological indicators, does not suit needs of full-scale or pilot systems, where separation process is being run in cycle, when filtration phase alternates with relaxation, backwash with permeate or chemically enhanced backwash. Large-scale industrial MBR plants are monitored comprehensively and continuously supervised by qualified staff, which takes decision about acceptable hydraulic parameters, energy consumption and cleaning frequency. Both approaches are not suitable for small MBRs, intended for decentralized wastewater treatment, where qualified staff is involved during installation and commissioning at best.

Thereby, the objective of the present work is to define performance indicators of the membrane separation process in submerged MBR, which can be monitored during continuous run of small decentralized wastewater treatment system and interlinked with chemical and biological parameters into performance evaluation protocol.

## Material and Methods

The experimental plant has a design of submerged MBR in external configuration, with separate biological and filtration tanks, connected by overflow (Figure 1).



**Figure 1.** Pilot-scale experimental setup.

Ceramic-plate microfiltration membranes with 0.1  $\mu\text{m}$  pores were applied (Cembrane, Denmark). Three membrane modules with total filtering area of 0.828  $\text{m}^2$  were connected in parallel to the peristaltic pump. Membranes were aerated from the bottom diffuser with oxygen excess. Biology was inoculated with sludge from municipal wastewater treatment plant (BEVAS, Oslo). Pre-screened wastewater was supplied at 0.3  $\text{m}^3/\text{d}$  and obtained by mixing 10% black and 90% grey water. Black water is the wastewater discharged from toilets, while grey water is the washwater – all wastewater except for toilet wastes and food wastes from garbage grinders. The mixture was characterized by TSS 0.03...1.27  $\text{g/L}$ , COD 99...342  $\text{mgO}_2/\text{L}$ . Inlet mixture was obtained from the wastewater fractions originated from student dormitories that are equipped with source separating sanitation and vacuum toilets (Todt et al., 2015).

Mixed liquor (ML) was characterized by MLSS, sludge volume index (SVI) and relative hydrophobicity (RH), analysed periodically according to SMWW (22nd edition). Flow in permeate line, and transmembrane pressure (TMP) were measured with flow and pressure sensors (Krohne) and logged every second to PLC together with filtration cycle settings.

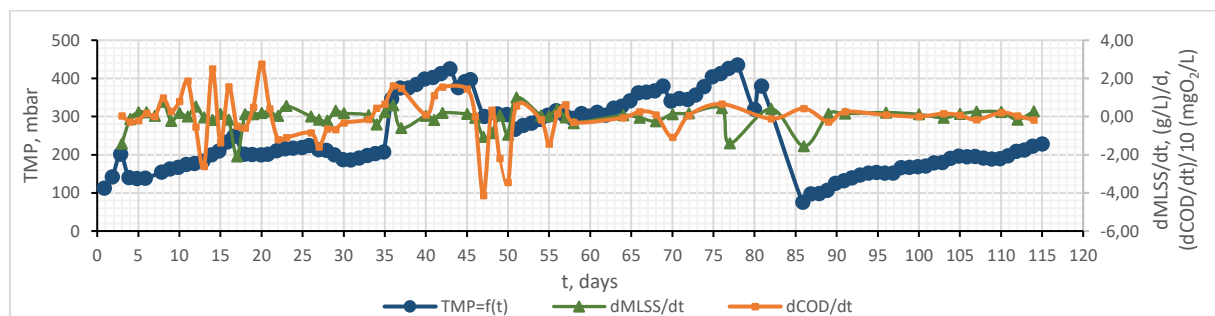
## MAIN RESULTS AND CONCLUSIONS

Obtained permeate flows were recalculated to membrane flux  $J$ , LMH (1), normalized to 20  $^\circ\text{C}$  as  $J_N$  (2) and used to calculate normalized permeability  $P_N$  (3) and the fouling rate  $dP_N/dt$  (4):

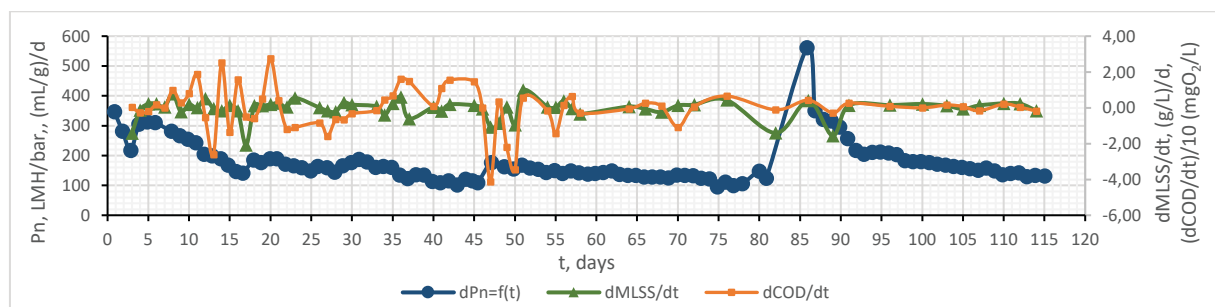
$$J = \frac{F}{S_f}, \quad (1) \quad J_N = J \cdot e^{(-0.032 \cdot (t-20))} \quad (2) \quad P_N = \frac{J_N}{TMP} \quad (3) \quad \frac{dP_N}{dt} = \frac{P_{N_i} - P_{N_{i-1}}}{t_i - t_{i-1}} \quad (4)$$

where  $F$  is permeate flow, L/h;  $S_f$  is the active filtration surface,  $\text{m}^2$ .

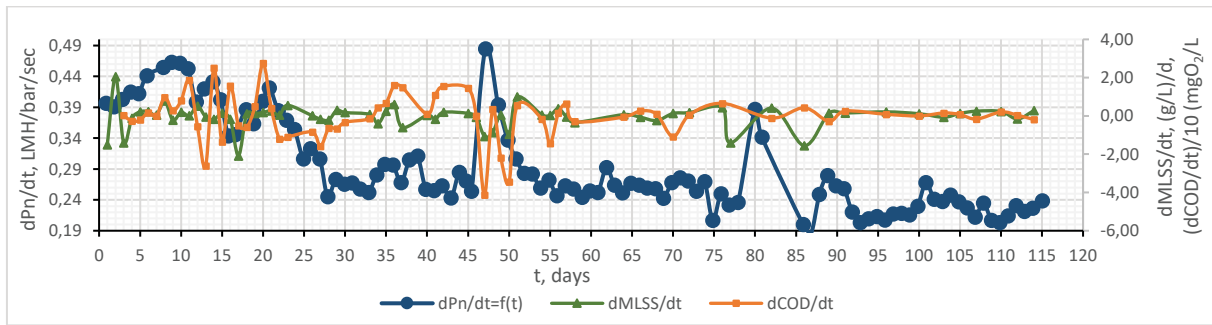
Data array of hydraulic parameters was statistically treated and 8 representative filtration cycles for each day were selected for further analysis. For each cycle, a set of average initial ( $TMP_i, J_{N_i}, P_{N_i}$ ) and final parameters ( $TMP_{i-1}, J_{N_{i-1}}, P_{N_{i-1}}$ ) has been calculated, excluding ramp and relaxation periods of the peristaltic pump. The following plots were acquired (Figure 2-4).



**Figure 2.** Development of TMP and the change of biomass characteristics in time.



**Figure 3.** The change of normalized permeability and mixed liquor parameters over time.



**Figure 4.** The development of fouling rate and mixed liquor parameters over time.

Recovery of permeability was in the range 88...126%.

The characteristics of activated sludge and their change over time in the separation chamber were monitored to establish the correlation between them and the filtration performance (Table 1).

**Table 1.** Parameters of the mixed liquor in separation chamber

Parameter	MLSS (g/L)	dMLSS/dt ((g/L)/day)	SVI (mL/g)	dSVI/dt ((mL/g)/day)	RH, (%)	dRH/dt
Value	5.0...6.50	-0.61...2.06	118...272	-91...57	20.5...61.5	-27...35

According to multiple regression analysis the characteristics of mixed liquor exhibited poor correlation with the indicators of fouling development: Pearson coefficient  $R^2=0.52$  ( $TMP=f(x_i)$ ),  $R^2=0.50$  ( $P_n=f(x_i)$ ),  $R^2=0.35$  ( $dP_n/dt=f(x_i)$ ).

Meanwhile, the monitoring of the changes in MLSS and SVI has still remained an essential part of the protocol since they reflect the biomass activity. These indicators were used to adjust system settings (RAS pumping intensity, the frequency of desludge), which allowed to maintain the stability of the system operation and, hence, the permeate quality: MBR installation assured 98.4...100% MLSS elimination and 66.7...89.6% treatment efficiency in terms of COD removal.

Obtained results show that developed protocol allows the evaluation of the performance of small wastewater treatment MBR system, simultaneously accounting treatment efficiency parameters, standard membrane filtration characteristics, fouling development indicators (TMP,  $P_n$ ,  $dP_n/dt$ ) and membrane cleaning efficiency (permeability recovery). This approach allows maintaining the system within stable operation range and treatment efficiency independently from fluctuations in membrane separation part.

## REFERENCES

- Hai F.I., Yamamoto K. and Lee C-H (Eds.) 2014 *Membrane Biological Reactors. Theory, Modeling, Design, Management and Applications to Wastewater Reuse*. IWA Publishing, United Kingdom.
- Todt D., Heistad A., Jenssen PD. 2015 Load and distribution of organic matter and nutrients in a separated household wastewater stream. *Environmental Technology*, **36**(9-12), 1584-1593.

The reviewer's comments:

The abstract fit within the conference scope

The experimental setup is not clear, a schematic representation or a photograph would help. The authors did not define what the meant by "black and grey water". The variables in eq. 1-6 are not explained. Table 1 is not referenced in the abstract. Further, the VSS and TSS concentration of the AS is not logical, maybe it should be g/L (and not mg/L)? The authors did not discuss the relevancy of RH CST and SVI to their work.

# Decontamination of urban wastewater loaded with psychoactive drugs via photocatalytic processes

Ref # S2SMALL-121334

S. Tsoumachidou<sup>1\*</sup>, I. Poulivos<sup>1</sup>

<sup>1</sup> Laboratory of Physical Chemistry, Department of Chemistry, Aristotle University of Thessaloniki, 54124 Thessaloniki, Greece.

\* Corresponding Author: stsoum@gmail.com

**Keywords:** AOPs, photocatalytic oxidation, phytotoxicity, psychoactive drugs, urban wastewater, wastewater management.

## INTRODUCTION / MAIN METHODS

In the last years humanity is faced with the problem of water pollution, an issue that threatens people's health and also degrades the quality of life. According to the World Health Organization (WHO), globally, 663 million people rely on sources of questionable quality and at least 1.9 billion people use a drinking-water source contaminated by the discharge of biological effluents. At the same time, the growth of the world population is accompanied by an increase in industrial, agricultural and recreational activities, leading to increased demand for fresh water. For this reason, in the next few decades, access to clean fresh water sources will be a serious global problem (Rodríguez-Chueca *et al.* 2014). Water is an essential resource for survival of all living creatures. Safe and sufficient quantity of water is necessary for a healthy growth. A third of the world's population is facing some form of water scarcity (Ghaitidak & Yadav 2013); a worldwide problem, even in places that were traditionally conceived as water ample regions (Europe, Japan, etc.), which needs to be prevented with several actions to guarantee the water supply for all the people.

The marked depletion of fresh water resources along with continuously escalating climate changes and extended pollution of the aquatic environment, render sustainable water management an essential need. Given the worldwide water scarcity and future demands, the debate on the utilization of recycled wastewater as an alternative water source is gaining increasing attention. Wastewater recycling is emerging as an integral part of water demand management. The primary purpose of the reclamation and reuse of water is to draw water directly from non-traditional sources, such as industrial or municipal wastewaters, and to restore it to higher quality (Shannon *et al.* 2008). Wastewater reuse may provide a new and stable source of water for agriculture, industrial processes, and some domestic uses that do not require potable water. The potential benefits for agriculture, environmental preservation, and energy conservation may be even more important (Rodríguez-Chueca *et al.* 2014). Urban wastewater contains a great diversity of chemical pollutants and pathogens, and it includes a large amount of organic matter, all of which must be removed or transformed into harmless compounds.

During the current economic crisis in Greece, the consumption of psychoactive substances has risen significantly, resulting in an increase in their concentration in urban wastewater (Thomaidis *et al.* 2016). The presence of psychoactive substances and/or their metabolites is confirmed, not only in urban wastewater, but also in aquatic plants and animal tissues (Chu & Metcalfe 2007; Metcalfe *et al.* 2010; Rodayan *et al.* 2016), underlining the possible consequences for human health and ecosystems balance. According to scientific reports, the removal of these substances from sewage treatment plants is often incomplete, as the biological treatment that has been adopted as the best available technology only provides partial removal. In order to solve various problems encountered by conventional methods for

the degradation of xenobiotics in water and liquid wastes, many researchers have turned their attention to a particular group of oxidation techniques called Advanced Oxidation Processes (AOPs). AOPs include heterogeneous and homogeneous photocatalytic oxidation which has emerged as a highly effective and environmentally friendly technology for water and wastewater decontamination. At the same time, this method has the potential to utilize solar energy, thus integrating mild energy into the process of protecting the environment.

The aim of this work was the application of the preceding methods at the degradation of psychoactive drugs contained in urban wastewater, in order to provide a further insight to oxidation kinetics (i.e. determination of factors affecting oxidation rate) and estimate mineralization degree towards the corresponding oxidation process. Subsequently, photocatalytic oxidation method was applied to simulated wastewater loaded with psychoactive drugs under artificial and solar illumination, so that process effectiveness unto urban wastewater mineralization and reuse could be evaluated. In addition, phytotoxicity testing was carried out to investigate the possibility of reuse of treated wastewater in applications such as irrigation.

Bench-scale experiments were performed in a thermostated pyrex cell of 0.25 L capacity. The reaction vessel was fitted centrally with either a UV-A or visible, 9W light of identical dimensions and geometry. The photocatalytic reactor was covered with a black cloth to avoid interactions with ambient light. The artificial light sources were an Osram Dulux® S blue UV-A lamp (9W/78, 350–400 nm) and an Osram Dulux® S blue lamp (9W/71, 400–550 nm). Solar experiments were conducted in an open pyrex glass cell of 0.2 L capacity with continuous magnetical stirring under natural sunlight during the spring-summer season (May-June) from 12.00 to 16.00 pm. A Solar Light Company PMA2100 UV radiometer was used during the experimental runs in order to determine the intensity of the solar illumination.

Sample absorbance was scanned in the 200-400 nm wavelength region on a Shimadzu UV-1700 spectrophotometer. Changes in sample absorbance were monitored to assess the extent of degradation that had occurred during photocatalytic treatment. Mineralization was followed by measuring the dissolved organic carbon (DOC) by direct injection of filtered samples into a Shimadzu VCSH Total Organic Carbon Analyzer.

## MAIN RESULTS AND CONCLUSIONS

In the present work the photocatalytic degradation of two psychoactive drugs that exist in urban wastewater, duloxetine (DLX) and fluvoxamine (FVX), has been demonstrated. At heterogeneous photocatalytic oxidation, with the use of TiO<sub>2</sub> P25 as photocatalyst under UV-A illumination, total degradation and mineralization of the organic molecules occurred after 1 and 2 h, respectively. Degradation rate and DOC removal increased with the increasing catalyst dosage from 0.1 up to 0.75 g L<sup>-1</sup>.

The next step of this study focused on enhancing the photocatalytic reaction by adding H<sub>2</sub>O<sub>2</sub> at different concentrations to the initial solution. The addition of electron scavengers to TiO<sub>2</sub> suspensions is a well-known and extensively studied procedure and in many cases leads to an acceleration of the rate of the photocatalytic degradation of a variety of organic pollutants. The effect of hydrogen peroxide addition on the degradation of DLX and FVX was studied under various amounts of H<sub>2</sub>O<sub>2</sub> i.e. 0.025, 0.05, 0.075, 0.1, 0.15 and 0.2 g L<sup>-1</sup>. The photocatalytic efficiency increased as the concentration of H<sub>2</sub>O<sub>2</sub> was increased until a certain value (0.075 g L<sup>-1</sup>). Further increment of H<sub>2</sub>O<sub>2</sub> dosage led to a decrease in the reaction rate.

In an attempt to enhance the efficiency of the photocatalytic process, ferric ion Fe<sup>3+</sup> (FeCl<sub>3</sub>·6H<sub>2</sub>O) was introduced in the reaction solution at different concentrations (i.e. 0.00175,



0.0035, 0.005, 0.007 and 0.014 g L<sup>-1</sup>). The amount of ferric or ferrous ion is one of the main parameters to influence the Fenton and photo-Fenton processes. In most cases, when the iron concentration is increased, the catalytic effect is enhanced, since we have more hydroxyl radicals' production. The increment of ferric ions from 0.00175 to 0.014 g L<sup>-1</sup> led to an increase on the initial degradation rate until a certain value. Too high concentrations of iron can generate dark zones in the photoreactor, because the incident ray is attenuated too strongly along the optical path length, reducing, therefore, the process efficiency.

In the photo-Fenton process, HO<sup>•</sup> radicals are generated by the reactions of Fe ions with hydrogen peroxide and light energy. The increment of ferric ions from 0.00175 to 0.014 g L<sup>-1</sup> led to an increase on the mineralization of DLX and FVX photo-Fenton oxidation when the solution was illuminated by UV-A or visible light.

The influence of H<sub>2</sub>O<sub>2</sub> concentration on kinetics was investigated by several previous studies and the main findings have shown that neither too low hydrogen peroxide concentration (leading to a rate reduction of the Fenton reaction) nor too high concentration may be applied (H<sub>2</sub>O<sub>2</sub> competes successfully for hydroxyl radicals and becomes decomposed into molecular oxygen and water, while oxidizing the pollutant). Usually, however, there is a rather broad concentration interval between both extremes, where none of these two phenomena occur. Increasing the concentration of H<sub>2</sub>O<sub>2</sub> from 0.025 to 0.2 g L<sup>-1</sup> an increment in the mineralization of both psychoactive drugs occurred.

## ACKNOWLEDGEMENTS

This research project was funded by IKY, through «IKY Fellowships of Excellence for Postgraduate Studies in Greece – Siemens Program».

## REFERENCES

- Chu S. and Metcalfe C. D. (2007). Analysis of paroxetine, fluoxetine and norfluoxetine in fish tissues using pressurized liquid extraction, mixed mode solid phase extraction cleanup and liquid chromatography–tandem mass spectrometry. *Journal of Chromatography A* **1163**(1), 112-8.
- Ghaitidak D. M. and Yadav K. D. (2013). Characteristics and treatment of greywater--a review. *Environ Sci Pollut Res Int* **20**(5), 2795-809.
- Metcalfe C. D., Chu S., Judt C., Li H., Oakes K. D., Servos M. R. and Andrews D. M. (2010). Antidepressants and their metabolites in municipal wastewater, and downstream exposure in an urban watershed. *Environ Toxicol Chem* **29**(1), 79-89.
- Rodayan A., Afana S., Segura P. A., Sultana T., Metcalfe C. D. and Yargeau V. (2016). Linking drugs of abuse in wastewater to contamination of surface and drinking water. *Environ Toxicol Chem* **35**(4), 843-9.
- Rodríguez-Chueca J., Polo-López M. I., Mosteo R., Ormad M. P. and Fernández-Ibáñez P. (2014). Disinfection of real and simulated urban wastewater effluents using a mild solar photo-Fenton. *Applied Catalysis B: Environmental* **150**, 619-29.
- Shannon M. A., Bohn P. W., Elimelech M., Georgiadis J. G., Marinas B. J. and Mayes A. M. (2008). Science and technology for water purification in the coming decades. *Nature* **452**(7185), 301-10.
- Thomaidis N. S., Gago-Ferrero P., Ort C., Maragou N. C., Alygizakis N. A., Borova V. L. and Dasenaki M. E. (2016). Reflection of Socioeconomic Changes in Wastewater: Licit and Illicit Drug Use Patterns. *Environmental Science & Technology* **50**(18), 10065-72.

**Pilot scale testing of the use and production of Terra Preta and other soil improving products like Phosphate Rich Organic Manure for increased agricultural productivity**

**Ravi Kiran Shet<sup>1</sup>, Katja Albrecht<sup>2</sup>, Stefan Schmid<sup>2</sup>, Srikanth Mutnuri<sup>1</sup>**

1 - *Applied and Environmental Biotechnology Laboratory, Department of Biological Sciences, Birla Institute of Technology and Science –Pilani, K. K .Birla Goa campus, Goa, India*  
Tel: 0091 832 2580125, Fax: 0091 832 2557033, Email: [srikanth.mutnuri@gmail.com](mailto:srikanth.mutnuri@gmail.com),  
[srikanth@goa.bits-pilani.ac.in](mailto:srikanth@goa.bits-pilani.ac.in)

2 – *Natura Resource Management Programme, Soil Protection and Rehabilitation for Food Security in India, giz* | Deutsche Gesellschaft für Internationale Zusammenarbeit (GIZ) GmbH, New Delhi, 110029, India

There is too much pressure on natural resources due to increasing population. About 854 million people in 46 countries are chronically hungry due to extreme poverty (FAO) and an estimated 2.2 billion people are suffering from micronutrient deficiencies. World population could rise by 2 billion in the next 25 years which requires agricultural production to double. The increased demand for food led to intensification and industrialisation of agricultural production which resulted in increased use of energy & chemical fertilizers. This pilot study is being carried out in the context of the GIZ/NABARD project “Soil Protection and Rehabilitation for Food Security” which forms part of the initiative “One World – No Hunger” that was started by the German Federal Ministry for Economic Cooperation and Development (BMZ). It is implemented jointly by the National Bank for Agriculture and Rural Development (NABARD) and GIZ in seven districts of Maharashtra and Madhya Pradesh in India. The main focus of the proposed pilot project is to increase soil fertility by applying Terra Preta (TP) or Phosphate Rich Organic Manure (PROM) and compare the crop productivity in comparison with chemical fertilizers or the current practices, the farmers practice at selected sites. The produced TP and PROM were tested on Rabi and Kharif crops i.e Wheat, Bengal Gram, Onion, Rice, Finger Millet, Blackgram, Soybean in one acre area for each crop. The results will be discussed during the conference.

### Urban flood-risk management

#### **254 - Biodegradation of Tetrabromobisphenol A by Enterobacter sp. NJUST20 Isolated from Anaerobic Sludge**

QIAO Li - *School of Environmental and Biological Engineering, Nanjing University of Science and Technology*

### Water reuse, recycle and conservation

#### **255 - Improving solid potato waste treatment by microbial fuel cell using waste activated sludge**

DU HAIXIA - *Nanjing Tech University*

#### **306 - Effectiveness of minerals formed by chemical precipitation in landfill leachate ammonia removal process as source of plant nutrients**

SCHNEIDER Jerusa - *School of Civil Engineering, Architecture and Urban Design, University of Campinas*

#### **545 - 4KET4Reuse: seeking sustainable solutions for removing emerging contaminants in wastewater**

ARAGON CARLOS A. - *Centro de las Nuevas Tecnologías del Agua*

# Biodegradation of Tetrabromobisphenol A by *Enterobacter* sp. NJUST20 Isolated from Anaerobic Sludge

Li, Q.<sup>1,2</sup>, Wen, J.P.<sup>1,2</sup>, Liu, C.C.<sup>1,2</sup>, Sun, X.Y.<sup>1,2</sup>

<sup>1</sup> Jiangsu Key Laboratory of Chemical Pollution Control and Resources Reuse, Nanjing, China

<sup>2</sup> School of Environmental and Biological Engineering, Nanjing University of Science and Technology, Nanjing, China

**Abstract:** A bacterial strain capable of degrading tetrabromobisphenol A (TBBPA) was isolated from anaerobic sludge. This strain was identified and named as *Enterobacter* sp. NJUST20. NJUST20 showed maximal degradation activity at 35°C and pH 7.0. Under the optimal conditions, about 81.9 % of the initial TBBPA (10 mg/L) could be degraded after 6 days of cultivation. The degradation process fit the first order model. The degradation rate constant ( $k$ ) and degradation half-live ( $T_{1/2}$ ) was found to be 0.4020 d<sup>-1</sup> and 1.6 d, respectively. The biodegradation pathway and the fate of the intermediate metabolites were speculated. It is promising for the remediation of environmental media contaminated by TBBPA.

**Key words:** Anaerobic Biodegradation; Bisphenol A (BPA); Debromination; *Enterobacter* sp. NJUST20; Metabolites; Tetrabromobisphenol A (TBBPA)

## 1. Introduction

Tetrabromobisphenol A (TBBPA) is widely used in electronic circuit boards, ABS, HIPS, unsaturated polyester, adhesive and dope as reactive or additive flame retardant with the largest production volume today (Bromine Science Environmental Forum 2013). Though the risk assessments of TBBPA made by Commission of the European Communities (2008) and European Food Safety Authority (Alexander et al. 2011) showed that had no acutely toxic on human beings, TBBPA had been detected in variety samples in the environment and caused adverse effects (Yu and Hu 2007; Johnson-Restrepo et al. 2008). TBBPA is extremely poisonous to aquatic organisms. Furthermore, it has been demonstrated as cytotoxin, neurotoxin and endocrine disruptor (Canesi et al. 2005; Zatecka et al. 2013). In recent years, more and more attention has been paid to the negative effects of TBBPA.

Biodegradation is more economical and efficacious than other degradation technologies in the mineralization of TBBPA. The biodegradation of TBBPA under either aerobic or anaerobic conditions has been investigated in some studies (Arbeli et al. 2006; Peng et al. 2012; Ronen and Abeliovich 2000). But the biodegradation pathways for TBBPA are not clear at present. Four possible primary metabolic pathways of TBBPA in the slurries were proposed as oxidative skeletal rearrangements, O-methylation, ipso-substitution and reductive

debromination by Li et al. (2014). Similar reductive debromination of TBBPA to bisphenol A (BPA) under anaerobic conditions also had been mentioned in several reports (Arbeli et al. 2006; Ronen and Abeliovich 2000; Voordeckers et al. 2002). The degradation progresses of TBBPA in aerobic conditions were also presented in some studies (An et al. 2011). However, there are limited papers (Peng et al. 2013; An et al. 2011) about the isolation and cultivation of single strain capable of degrading TBBPA. In addition, the research about the TBBPA degradation conditions and pathways in anaerobic conditions is also insufficient.

In order to simplify the study of TPPBA biodegradation by anaerobic bacteria, a strain with the potential ability to degrade high-concentration TBBPA (10 mg/L) was isolated and identified. The optimal degradation conditions including temperature and pH were investigated. The biodegradation pathway and the fate of the metabolites were speculated.

## **2. Material and Methods**

### **2.1 Sources of sewerage sludge and cultivation media**

Sludge for the acclimatization of TBBPA degradation bacteria was taken from a sewage treatment plant in Nanjing, China. The composition of synthetic medium (SM) can be found in supplementary information. The solid synthetic medium (SSM) was 2 % agar SM. Nitrogen sparging and sterilization was carried out before the media applied.

### **2.2 Acclimatization, isolation and identification of TBBPA degradation bacterium**

After 100 days of acclimatization in continue mode, the microorganisms in the anaerobic reactor were able to degrade high-concentration TBBPA (10 mg/L) effectively. The alternation of SM culture and SSM culture was applied until the individual colonies were isolated on SSM plates using gradient dilution and plate smearing methods. The single strain with the highest TBBPA degradation rate was chosen for subsequent experiments. The species of the bacterial strain was identified by 16S rDNA sequence analysis and physio-biochemical characteristics. More experimental details can be found in supplementary information.

### **2.3 Effects of temperature and pH**

In order to determining the optimal growth conditions for TBBPA-degrading strain, pH (6.0, 7.0, 8.0, 9.0) and temperature (25, 30, 35, 40 °C) were studied at the shaking of 180 r/min with an inoculum of 1% OD<sub>600</sub>= 0.6. The control groups were cultivated in the same conditions without inoculum. The concentrations of TBBPA were determined at given time intervals. All operations were completed in an anaerobic box.

## 2.4 Analysis

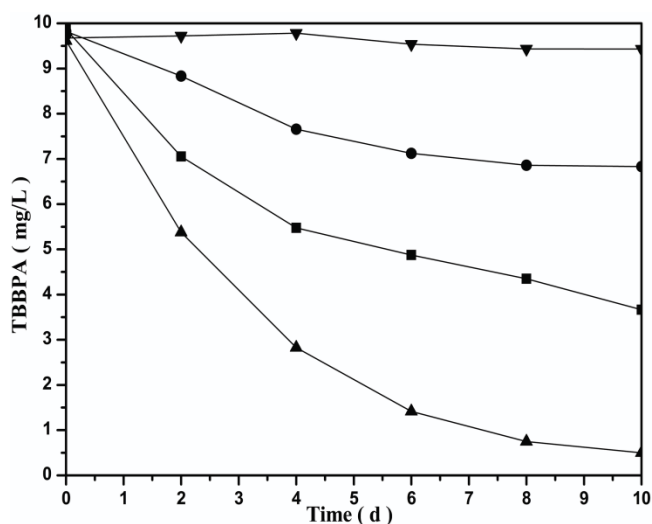
The pH of the samples was adjusted above 9.0 to ensure TBBPA separated and desorbed in water phase (Kuramochi et al. 2008). After centrifugation and filtration by 0.22  $\mu\text{m}$  filters, TBBPA and the metabolites were detected by high-performance liquid chromatograph (HPLC, Waters 1525, America) which was equipped with photodiode array detector (Waters 2996, America) and CNW C18-WP column (250 $\times$ 4.6 mm, 5  $\mu\text{m}$ , ANPEL, China). The column was set at 35  $^{\circ}\text{C}$ . The mobile phase was composed of water and methanol (15:85, v/v). Injection volume was 20  $\mu\text{L}$ . The detection was applied at 290 nm.

The metabolites of TBBPA were identified by gas chromatography-mass spectrometry (GC-MS). More details about GC-MS can be found in supplementary information.

## 3. Results and discussion

### 3.1 Selection of TBBPA degradation bacterium

Several bacterial strains were isolated from the agar plates with 10 mg TBBPA  $\text{L}^{-1}$  after isolation and purification. The one with the highest TBBPA degradation rate (62.85%), named as NJUST20, was selected for subsequent experiments. The reduction of TBBPA in the blank (without inoculum) was not obvious. The results of acclimatization and the comparison of TBBPA degradation between the blank and strain NJUST20 can be found in Fig. 1.



**Fig. 1** Biodegradation of TBBPA. Symbols: Blank without inoculum (▼), TBBPA degradation by original sludge in the reactor (●), TBBPA degradation by strain NJUST20 (■), TBBPA degradation by acclimatized sludge in the reactor (▲).

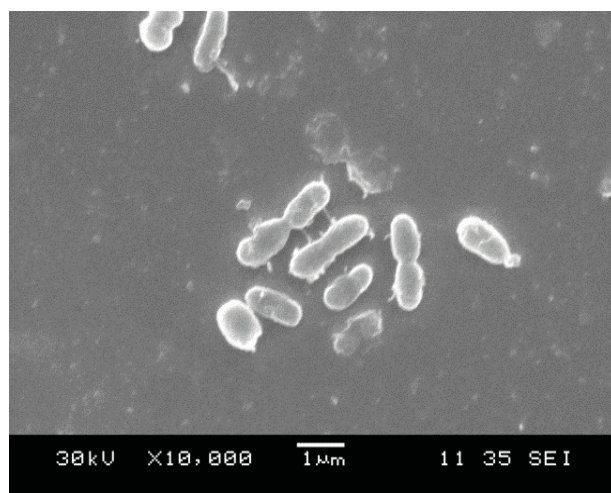
### 3.2 Identification of strain NJUST20

The colonies of strain NJUST20 on SSM plates were yellowish white with regularly edges and concave surfaces. 2 days later, the diameter of the colonies was 2-4 mm. The cells

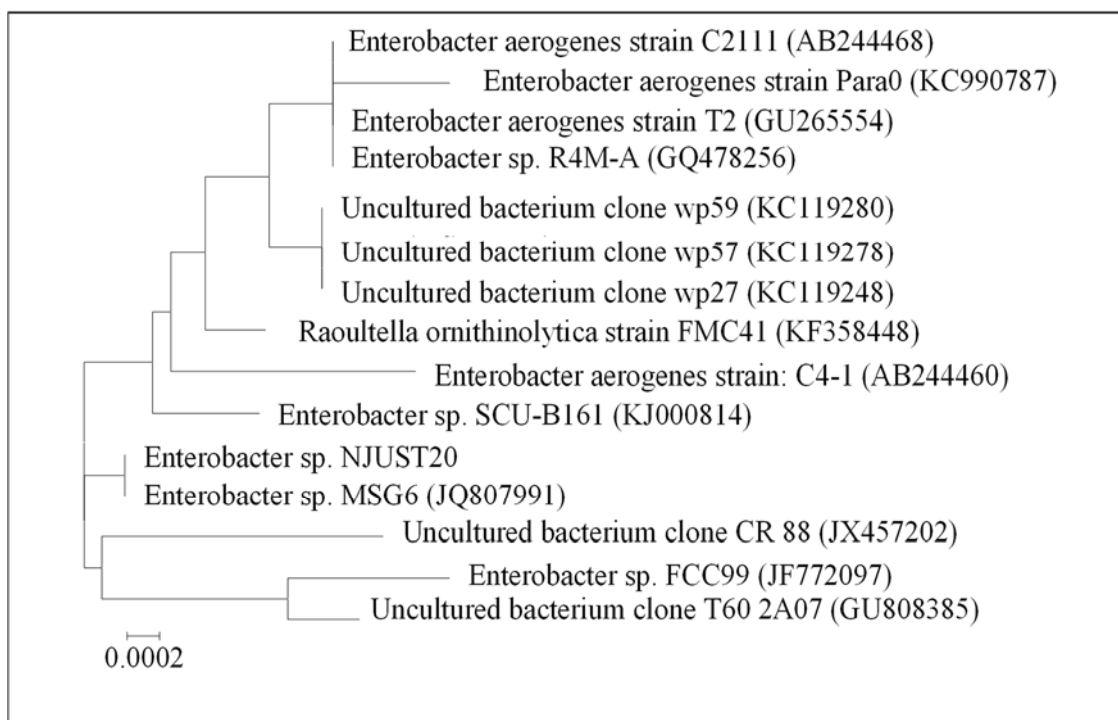


of strain NJUST20 were straight rod in shape and about  $0.61 \times 1.27$ - $1.87 \mu\text{m}$  in size and peritrichous under SEM (Fig. 2). The 16S rDNA gene sequences similar to NJUST20 were obtained from GenBank. The phylogenetic tree (Fig. 3) was completed by MEGA version 6.06 using the Neighbor-Joining method. *Enterobacter* sp. MSG6, *Enterobacter* sp. R4M-A and *Enterobacter aerogenes* strain T2 had the highest sequence identity (over 99%) with NJUST20. The results of biochemical experiments were shown in Table 1. Comparison of the characteristics between NJUST20 and the species of the genus *Enterobacter* showed that NJUST20 was closer to *Enterobacter gergoviae*.

In conclusion, strain NJUST20 was closer to *Enterobacter gergoviae*. The name *Enterobacter* sp. NJUST20 was proposed. The 16S rDNA sequence of NJUST20 in this study has been deposited in the GenBank under accession number KM434200. There were several strains able to degrade TBBPA effectively under anaerobic conditions. Peng et al. (2013) reported that *Comamonas* sp. JXS-2-02 was able to degrade TBBPA (0.5 mg/L) under 30 °C and pH 7.0 with an inoculum of 1%  $\text{OD}_{600} = 0.6$  and the degradation rate was 86% after 10 days. The degradation rate constant ( $k$ ) and degradation half-live ( $T_{1/2}$ ) was  $0.1898 \text{ d}^{-1}$  and 3.7 d, respectively. Wang et al. (2013) mentioned the addition of cyanocobalamin, riboflavin, 2-hydroxy-1,4-naphthoquinone and Aldrich humic acid promoted the degradation of TBBPA by *Shewanella* sp. XB. A combination of *Pseudomonas* sp. and *Streptococcus* sp. (Peng et al. 2014) was presented to completely degrade  $0.5 \text{ mg TBBPA L}^{-1}$  within 10 days.



**Fig. 2** Scanning electron microscope figure (SEM) of strain NJUST20.



**Fig. 3** Phylogenetic tree of strain NJUST20 and the related species. The scale bars represent 0.0002 substitutions per site.

**Table 1** Morphological and biochemical characteristics of NJUST20

Characteristics	Results	Characteristics	Results
Motility(36 oC)	+	Methyl red	-
Gram-reaction	-	Soluble pigment	-
Voges-Proskauer	+	Gelatin hydrolysis at 22 °C	-
Catalase	+	Esculin hydrolysis	+
H <sub>2</sub> S production	-	Lysine decarboxylase	+
Ornithine decarboxylase	+	Malonate test	(+)
Arginine dihydrolase	-	Citrate test	+
Utilization of:			
Glucose	+	Fructose	+
Maltose	+	Acetate	+
Glycerol	+	Butyrate	-
Propionate	-	Adonitol	-

**Note:** +, positive in 1–2 days; (+), positive in 1–4 days; -, negative in 4 days.

### 3.3 Effects of temperature and pH

Temperature and pH are both important for the degradation of TBBPA. The results in Fig. 2 and Fig. 3 indicated that the optimum conditions for strain NJUST20 were 35 °C and pH 7.0.

6 days later, the residual TBBPA and the degradation rate were 1.8 mg/L and 81.9%, respectively.

In order to determine the degradation rate constant and the degradation half-life, the algorithm: (Voordeckers et al. 2002) was used to express the kinetic.  $C_0$  is the original concentration of TBBPA at time zero,  $C_t$  is the concentration of TBBPA at time  $t$ ,  $k$  and  $t$  are degradation rate constant and days of the degradation period, respectively. The theoretical degradation half-life ( $T_{1/2}$ ) was calculated with the algorithm: .

The data under the optimum conditions were put into the algorithms above. Degradation rate constant ( $k$ ) was  $0.4020 \text{ d}^{-1}$  and degradation half-life ( $T_{1/2}$ ) was 1.6 d. The value of  $R^2$  was 0.9855. It indicated that the degradation of TBBPA in our experimentation fit well with the first order model.

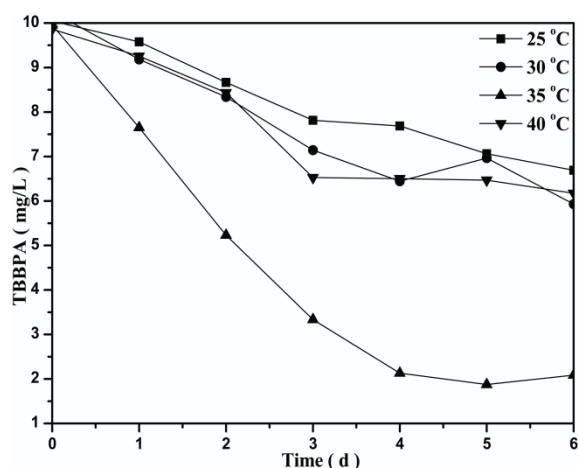


Fig. 2 Degradation of TBBPA under different temperature at pH 7.0.

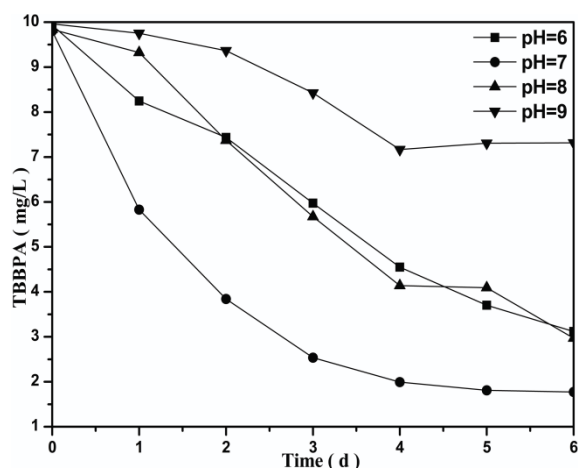


Fig. 3 Degradation of TBBPA at different pH under 35 °C.

#### 4. Conclusions

A TBBPA-degrading strain was isolated from the anaerobic sludge after acclimatization. The strain was classified as *Enterobacter sp.* according to biochemical characteristics and 16S rDNA sequence analysis and named as *Enterobacter sp.* NJUST20. At the temperature of 35 °C, initial pH 7.0 and initial TBBPA of 10 mg/L, the TBBPA degradation rate of strain NJUST 20 was 83.7% after 10 days of cultivation. The TBBPA degradation process of strain NJUST20 fit the first order model, the degradation rate constant was 0.4020 d<sup>-1</sup> and degradation half-live was 1.6045 d. This is the first report of degrading TBBPA by *Enterobacter sp.* strains. It is a significant work for the further mineralization of TBBPA under either anaerobic or aerobic conditions. It is also potentially promising for the remediation of water, sludge, sediment and soil contaminated by TBBPA.

#### References

- [1] Alexander J, Benford D, Boobis A, et al. Scientific Opinion on Tetrabromobisphenol A (TBBPA) and its derivatives in food: EFSA Panel on Contaminants in the Food Chain (CONTAM)[J]. EFSA Journal , 2011, 9:2477.
- [2] An T, Zu L, Li G, et al. One-step process for debromination and aerobic mineralization of tetrabromobisphenol-A by a novel *Ochrobactrum sp.* T isolated from an e-waste recycling site[J]. Bioresource Technology, 2011, 102:9148-9154.
- [3] Arbeli Z, Ronen Z, Díaz-Báez M C. Reductive dehalogenation of tetrabromobisphenol-A by sediment from a contaminated ephemeral streambed and an enrichment culture[J]. Chemosphere, 2006 , 64:1472-1478.
- [4] Bromine Science Environmental Forum (BSEF) (2013) Tetrabromobisphenol A for Printed Circuit Boards and ABS plastics. <http://www.bsef.com>
- [5] Canesi L, Lorusso L C, Ciacci C, et al. Effects of the brominated flame retardant tetrabromobisphenol-A (TBBPA) on cell signaling and function of *Mytilus* hemocytes: Involvement of MAP kinases and protein kinase C[J]. Aquatic toxicology, 2005, 75:277-287.
- [6] Commission of the European Communities. Communication from the Commission on the results of the risk evaluation and the risk reduction strategies for the substances: sodium chromate, sodium dichromate and 2,2',6,6'-tetrabromo-4,4'-iso-propylidenediphenol (tetrabromobisphenol A)[J]. Official Journal of the European Union C, 2008, 152:11.
- [7] Johnson-Restrepo B, Adams D H, Kannan K. Tetrabromobisphenol A (TBBPA) and hexabromocyclododecanes (HBCDs) in tissues of humans, dolphins, and sharks from the United States[J]. Chemosphere, 2008, 70:1935-1944.

- [8] Kuramochi H, Kawamoto K, Miyazaki K, et al. Determination of physicochemical properties of tetrabromobisphenol A[J]. *Environmental Toxicology and Chemistry*, 2008, 27:2413-2418.
- [9] Li F, Wang J, Nastold P, et al. Fate and metabolism of tetrabromobisphenol A in soil slurries without and with the amendment with the alkylphenol degrading bacterium *Sphingomonas* sp. strain TTNP3[J]. *Environmental Pollution*, 2014, 193:181-188.
- [10] Peng X, Qu X, Luo W, et al. Co-metabolic degradation of tetrabromobisphenol A by novel strains of *Pseudomonas* sp. and *Streptococcus* sp.[J]. *Bioresource Technology*, 2014, 169:271-276.
- [11] Peng X, Zhang Z, Luo W, et al. Biodegradation of tetrabromobisphenol-A by a novel *Comamonas* sp. strain, JXS-2-02, isolated from anaerobic sludge[J]. *Bioresource Technology*, 2013, 128:173-179.
- [12] Ronen Z, Abeliovich A. Anaerobic-aerobic process for microbial degradation of tetrabromobisphenol A[J]. *Applied and environmental microbiology*, 2000, 66:2372-2377.
- [13] Voordeckers J W, Fennell D E, Jones K, et al. Anaerobic biotransformation of tetrabromobisphenol A, tetrachlorobisphenol A, and bisphenol A in estuarine sediments[J]. *Environmental science & technology*, 2002, 36:696-701.
- [14] Wang J, Fu Z, Liu G, et al. Mediators-assisted reductive biotransformation of tetrabromobisphenol-A by *Shewanella* sp. XB[J]. *Bioresource Technology*, 2013, 142:192-197.
- [15] Yu C, Hu B. Novel combined stir bar sorptive extraction coupled with ultrasonic assisted extraction for the determination of brominated flame retardants in environmental samples using high performance liquid chromatography[J]. *Journal of Chromatography*, 2007, 1160:71-80.
- [16] Zatecka E, Ded L, Elzeinova F, et al. Effect of tetrabromobisphenol A on induction of apoptosis in the testes and changes in expression of selected testicular genes in CD1 mice[J]. *Reproductive Toxicology*, 2013, 35:32-39.

# Improving solid potato waste treatment by microbial fuel cell using waste activated sludge

Ref # S2SMALL-82428

H.X. Du<sup>1\*</sup>, F.S. Li<sup>2</sup>

<sup>1</sup> College of Urban Construction, Nanjing Tech University, Nanjing 211800, China

<sup>2</sup> River Basin Research Center, Gifu University, 1-1 Yanagido, Gifu 501-1193, Japan

\* Corresponding Author: [kejwdy@126.com](mailto:kejwdy@126.com)

**Abstract:** The effect of waste activated sludge (WAS) on electricity generation of MFC from solid potato waste was investigated with mixed feedstock of solid potato and fresh anaerobically cultured WAS with and without undergoing inactivation under different ratios. Columbic efficiency was significantly enhanced from 6.1 to 31.1 % when the cultured WAS was mixed at the ratio of 1:4. The final utilization of the feedstocks (evaluated by COD<sub>C</sub>) varied within 39.5 - 89.6 %, following the order of potato > mixture of potato & WAS/inactivated WAS > inactivated WAS > WAS. Stable isotope ratio ( $\delta^{13}\text{C}$ ) analysis indicated that, for the mixed feedstocks, WAS was more easily digested than potato, making the mass fractions of potato and WAS remaining after treatment differed from those before treatment. Fluorescence excitation emission matrix (EEM) showed that WAS enhanced humification of solid potato and inactivated WAS supported more protein-like substances.

**Keywords:** Vegetable waste; waste activated sludge; microbial fuel cell; electricity generation; anaerobic digestion; renewable energy.

## INTRODUCTION

Potato is widely planted, processed and consumed in the world. Waste potato without proper handling is the reason for many pests and odours, and the discarded potato to soil environment can also increase greenhouse gas emissions (Justin Cook, 2014; Yan et al., 2014). Microbial fuel cell (MFC) is a technology that can convert organic matter into electricity through anaerobic biodegradation (Logan et al., 2006). So far, many studies have been conducted using MFC to treat organic waste in the form of leachate or masticated slurries (including food waste, activated sludge, etc.) (Durruty et al., 2012; Xiao et al., 2013; Goud et al., 2011; Li et al., 2014). The direct feeding of solid potato waste to MFC is of greater application significance since a larger part of the potato waste from cultivation, storage and processing is in solid forms. For this, methods that can accelerate the hydrolysis of solid potato inside the MFC are expected since a previous study of the authors has found that particulate solid potato with larger sizes requires a longer time for hydrolysis to occur, leading to obvious decreases of current density and columbic efficiency (Du and Li, 2016).

The idea of mixing waste activated sludge (WAS) to enhance the performance of MFC in treatment of solid potato waste is newly formed based on the following considerations: 1) WAS contains rich microflora and some species after simple anaerobic culturing may join the bacteria originally populated in the anode chamber of MFC to promote the hydrolysis of solid potato waste; 2) the amount of WAS generated worldwide is continuously increasing and many developing countries are striving hard to find more effective disposal approaches that can replace conventional practices (including incineration that has been widely adopted in most industrialized countries, and landfilling and direct dumping that have been applied in most developing countries) to realize simultaneous stabilization and resource recovery; and 3) WAS itself contains high content of organic matter and can be used as an unceasing



renewable energy source, and sustainable approaches more beneficial to the total environment than conventional ones (e.g. digestion, carbonization and composting) are widely expected.

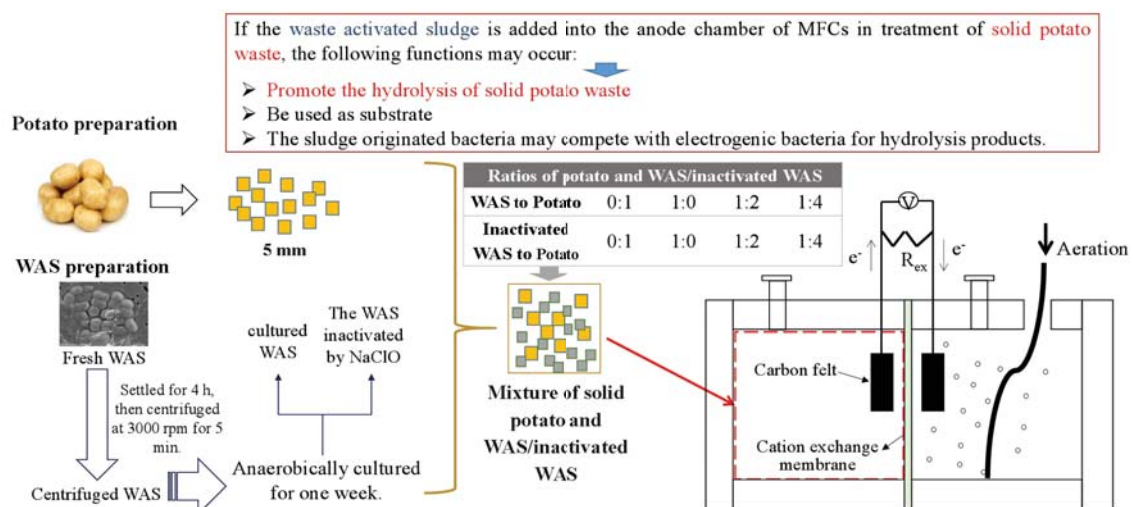
Accordingly, the major objective of this study was to investigate the effect of mixed feeding of WAS on the performance of MFC in treatment of solid potato waste. For this, four two-chamber MFCs fed with mixtures of solid potato with anaerobically cultured WAS from a municipal WWTP with and without undergoing inactivation by chlorine was operated. As control, three MFCs fed respectively with solid potato, the anaerobically cultured WAS and the WAS after inactivation were also operated. The effect on electricity generation was evaluated on the basis of current density, power density and columbic efficiency. And, the treatment efficiency for the solid potato and WAS was evaluated on the basis of COD and fluorescence excitation emission matrix (EEM). Moreover, with the aid of stable isotope ratio analysis of carbon ( $^{13}\text{C}$ ), the final composition of the mixed feedstocks remaining after MFC treatment was quantitatively evaluated.

## MATERIALS AND METHODS

Four two-chamber MFCs, with a total volume of 250 mL and the working volume of 240 mL for each chamber, fed with mixtures of solid potato and anaerobically cultured WAS from a municipal wastewater treatment plant with and without undergoing inactivation by chlorine was operated. As control, three MFCs fed respectively with solid potato, the anaerobically cultured WAS and the WAS after inactivation were also operated.

The initial COD loading of MFC 1 - 3 was 3360, 1569 and 1769 mg/L and it of MFC 4 - 7 was 4245, 3802, 4145 and 3752 mg/L, respectively. All seven MFCs were operated with an external resistance of 100  $\Omega$  for 87 days under 30 °C. Every four to six days, pH of the anodic solution was adjusted to about 7.0 - 7.1 using 1 N-HCl or NaOH. The cathode chamber of all MFCs was fed with the PBS solution and aerated continuously with an air pump.

The effect on electricity generation was evaluated based on current density, power density and columbic efficiency; and the treatment efficiency for the solid potato and WAS was evaluated based on COD and Fluorescence EEM. By analysing the observed time profiles of COD in the water phase of the anode chamber with a sequential first-order hydrolysis and degradation model, the magnitudes of the rate parameters under different conditions were estimated. Moreover, with the aid of stable isotope ratio analysis of carbon ( $\delta^{13}\text{C}$ ), the final composition of the mixed feedstocks remaining after MFC treatment was quantitatively evaluated. The schematic diagram of the experiment setup is shown in **Figure 1**.

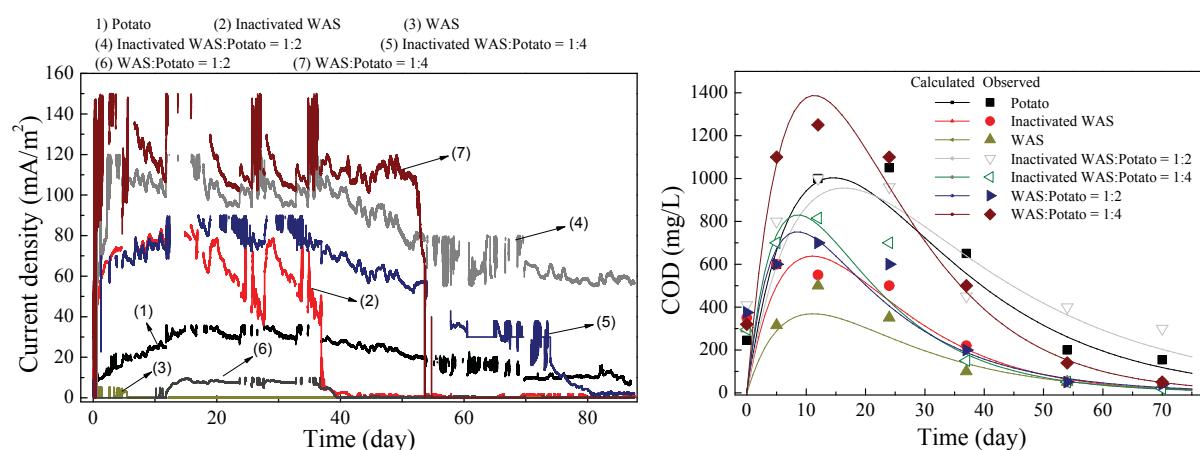


**Figure 1.** The schematic diagram of the experiment setup.

## RESULTS AND DISCUSSION

### *Current density and COD changes*

As shown in **Figure 2**, mixing WAS effectively increased the hydrolysis rate of solid potato. The increased hydrolysis products were preferentially used by electrogenic bacteria, leading to significantly enhancement of current density when the ratio of WAS to potato was at 1:4. However, with the larger ratio of WAS (1:2), the increased hydrolysis products seemed to be preferentially used by the ordinary heterotrophic bacteria brought from the WAS, resulting in a marked decrease in current density. Serving only as an additional organic source, the mixed feeding with inactivated WAS also enhanced electricity generation. The final utilization of the feedstocks varied within 39.5 - 89.6 %, following the order of potato > mixture of potato & WAS/inactivated WAS > inactivated WAS > WAS. Columbic efficiency was enhanced from 6.1 to 31.1 % when the cultured WAS was mixed at the ratio of 1:4. This effect was associated with the accelerated hydrolysis rate from 0.056 to 0.089 day<sup>-1</sup> due to the involvement of bacteria from the WAS. Stable isotope ratio ( $\delta^{13}\text{C}$ ) analysis indicated that, for the mixed feedstocks, WAS was more easily digested than potato, making the mass fractions of potato and WAS remaining after treatment differed from those before treatment.



**Figure 2.** Effect of mixing anaerobically cultured WAS with and without undergoing inactivation on the current density and soluble COD of MFCs treating solid potato.

### *Columbic efficiency*

Based on the observed profiles of current density and the profiles of COD to be shown later in Figure 1, the columbic efficiency of the seven MFCs was estimated respectively, as shown in **Table 1**. The largest one (43.6 %) was found for the MFC fed with the inactivated WAS alone and the smallest one (0.3 %) with the MFC fed with the fresh anaerobically cultured WAS alone, This implies that the inactivated WAS was effectively used as a substrate for electricity generation; while, in contrary, the fresh WAS alone was not used for electricity generation due probably to the preferential consumption of the organic substrate by the larger number of heterotrophic bacteria brought from the added sludge in the anodic chamber.

In addition, compared to the columbic efficiency (6.1 %) of the MFC fed with potato alone (MFC 1), the columbic efficiency (31.1 %) of the MFC treating the same amount of potato in mixture with the smaller amount of fresh WAS (MFC 7; the case with the mass ratio of 1:4) was 5 times larger. This clearly indicates that mixing a certain amount of cultured WAS could greatly enhance the electricity generation efficiency of raw solid potato. The enhancement was probably due to a favorable balance reached between the expected positive effect of the bacteria brought from the cultured sludge in promoting the hydrolysis of the solid potato and a likely negative effect of the increased number of bacteria's competition with the electrogenic

bacteria for the increased amount of hydrolysis products. Comparison of the columbic efficiency (31.1 %) with documented ones in literature also made clear that the electricity generation efficiency was higher than those of MFCs treating raw vegetable waste (Venkata Mohan et al., 2010), mixed food waste of breakfast, lunch and dinner (Jia et al., 2013) and waste activated sludge (Suor et al., 2014).

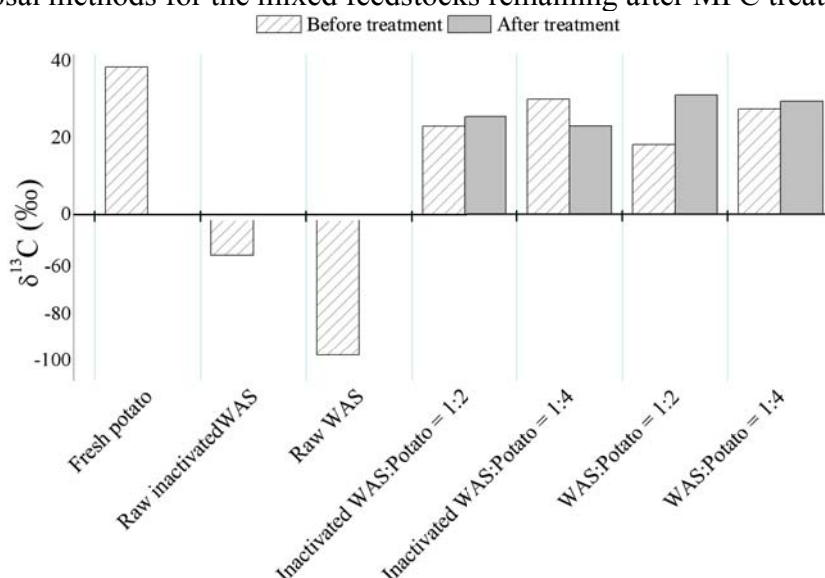
**Table 1** Comparisons of the performance of MFCs of this study with previous ones treating vegetable waste, food waste or waste activated sludge available in literature.

Substrate type	Substrate form/ratio	MFC type	Initial COD (mg/L)	COD removal (%)	Current density (mA/m <sup>2</sup> )	Maximum power density (mW/m <sup>2</sup> )	Columbic efficiency (%)	
Solid potato & WAS before and after inactivation	Solid potato	Two chamber	3360	89.6	36	2.3	6.1	This study
	WAS		1569	39.5	5	0	0.3	
	Inactivated WAS		1769	40.6	85	1.4	43.6	
	Inactivated WAS & Potato with ratio of 1:2		4245	56.4	120	4.0	31.0	
	1:4		3802	73.7	90	4.0	16.5	
	WAS & Potato with ratio of 1:2		4145	71.1	10	0	0.9	
	1:4		3752	66.7	150	6.8	31.1	
Potato	Masticated liquid after removing debris by settling	Two chamber	833	91.1	100.2	3.5	17.3	Du et al., 2015
Tomato			833	89.6	86.7	3.4	21.2	
Lettuce			833	93.2	72.2	2.8	15.6	
Composite vegetable waste	Liquid of masticated vegetable waste after removing pulp	Single chamber	700 - 2100 mg/L/day	62.9	87.1 - 160	15.4 - 26.4	-	Venkata Mohan et al. 2010
Mixed food waste of breakfast, lunch and dinner (in volume ratio of 1:2:2)	Filtrate of masticated food waste	Single chamber	2000 - 4900	77.2 - 86.4	-	371 - 556	23.5 - 27.0	Jia et al. 2013
Waste activated sludge	Raw sludge	Single chamber	8906	4.5 - 14.6	Power density (0.2 - 0.7 W/m <sup>3</sup> )	-	1.6 - 4.1	Suor et al. 2014
Waste activated sludge	Alkaline pretreated sludge	Two chamber	10560	-	Power density (46.8 - 55.9 mW/m <sup>2</sup> )	-	-	Xiao et al. 2013

***Stable isotope ratio ( $\delta^{13}C$ ) changes and the estimated mass fractions of potato and WAS in their mixed feedstocks remaining after treatment***

The values of  $\delta^{13}\text{C}$  for fresh potato, WAS and inactivated WAS are plotted in **Figure 3**. Within this figure, the values of  $\delta^{13}\text{C}$  for the mixed feedstocks of WAS/inactivated WAS into the potato before and after MFC treatment are also plotted.  $\delta^{13}\text{C}$  of the fresh potato, WAS and inactivated WAS was 38.6, - 54.9 and - 97.5 ‰, indicating a significant difference in the carbon source of the two substrates. For all four mixed feedstocks, compared to their initial  $\delta^{13}\text{C}$  values, the values after consumption were slightly higher for the three MFCs with the inactivated WAS at 1:2 (MFC 4), and the WAS at 1:2 (MFC 6) and 1:4 (MFC 7); and slightly lower for the MFC with the inactivated WAS at 1:4 (MFC 5).

The estimated mass fractions of potato and WAS in the mixed feedstocks remaining after treatment are shown in **Table 2**. In this table, the values of total COD before and after operation of all seven MFCs are also included. For all four mixtures (MFC 4 - 7), through MFC operation the mass fractions of potato increased from its beginning values of 79.2 - 89.6 % to the final values of 86.2 - 93.4 %; and, in contrary, those of both inactivated WAS and WAS decreased from 10.4 - 20.8 % to 6.6 - 13.8 %. This indicates that in mixed treatment of potato and WAS, WAS was consumed more easily than potato. The identification of the final composition is very useful because it will serve as important information for consideration of effective disposal methods for the mixed feedstocks remaining after MFC treatment.



**Figure 3** The stable isotope ratio ( $\delta^{13}\text{C}$ ) of the fresh potato, inactivated WAS and WAS; and the mixtures of potato and WAS before and after MFC operations.

**Table 2** The total COD of the anodic solution before and after MFC operations; and the changes of the mass fractions of potato and WAS in their mixed feedstocks.

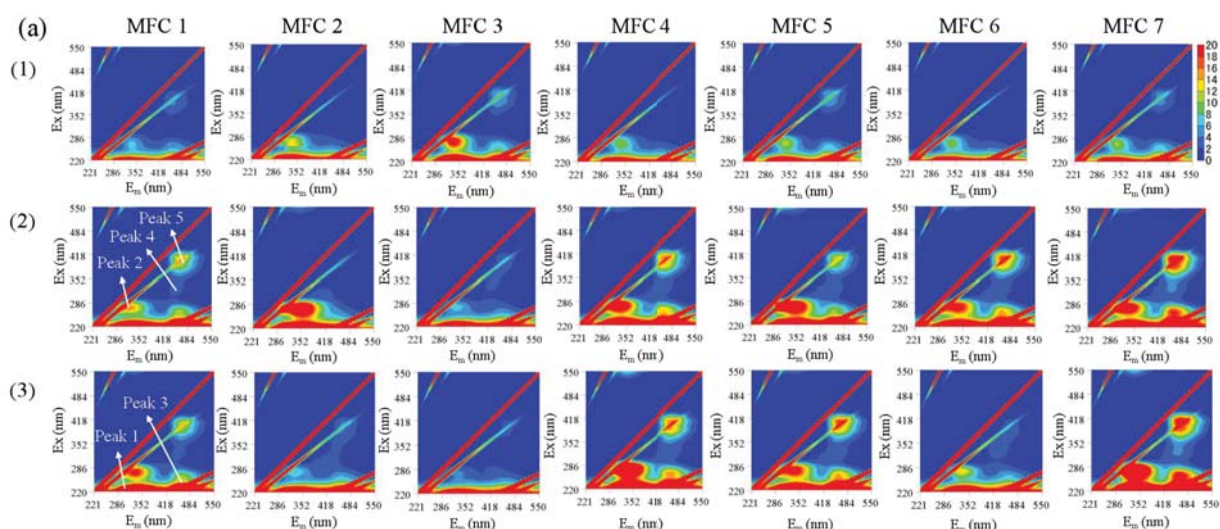
	MFC 1	MFC 2	MFC 3	MFC 4	MFC 5	MFC 6	MFC 7			
Before treatment	Initial total COD (mg/L)									
	3360	1769	1569	4245	3802	4145	3752			
	-			Mass fractions of potato & WAS (%)						
After treatment	Total COD remaining (mg/L)									
	350	1050	950	1850	1200	1000	1250			
	-			Mass fractions of potato & WAS (%)						
			86.2	13.8	92.1	7.9	88.7	11.3	93.4	6.6

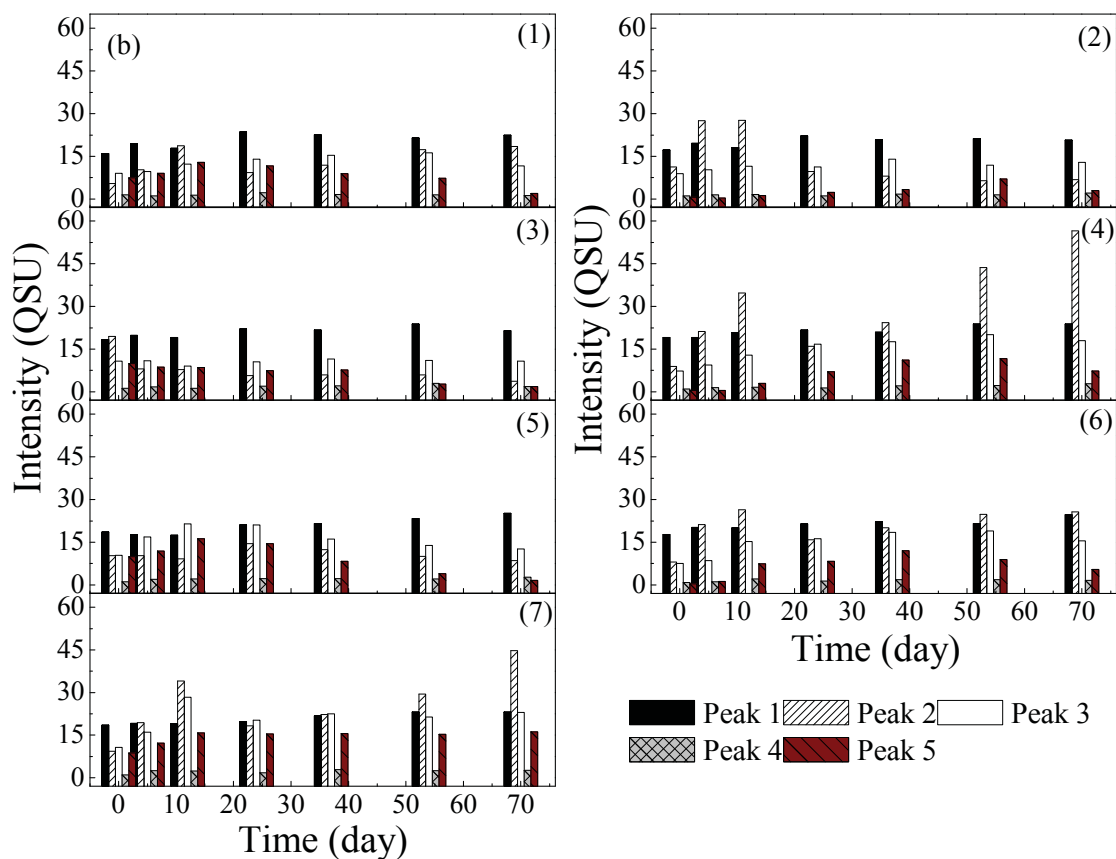


The fluorescence EEM spectra of dissolved organic matter in the anodic solution at different periods of the operation are shown in **Figure 4a**. At the initial starting period (day 0), Peak 1 and Peak 2 at the  $E_x/E_m$  of 225/340 nm and 280/344 nm, reported to reflect tyrosine-like aromatic amino acids and aromatic protein-like substances (Chen et al., 2003), appeared in all the MFCs with the ones of the inactivated WAS and WAS possessing higher intensity, which was probably because that, compared to the solid potato, more dissolved organic matter was released from the sludge.

At the period with the highest current density (Du and Li., 2017), Peak 5 at the  $E_x/E_m$  of 405/468, characterized as humic acid-like substances (Chen et al., 2003), obviously appeared in all samples except the ones of the Inactivated WAS alone and WAS alone, reflecting effective humification of the solid potato. Meanwhile, the intensity of the Peak 2 in all the samples significantly increased, indicating effective hydrolysis of both solid potato and sludge. It was very interesting that, for the mixture of the solid potato and sludge, the intensities of Peak 2 and Peak 5 of the WAS/Potato of 1:4 were much higher than them of the others until the end of the operation, indicating, coupled with the current density (Du and Li., 2017), that small amount of WAS significantly enhanced humification and stabilization of solid potato by the electrogenic bacteria. At the end of the operation, Peak 5 almost disappeared and the intensity of Peak 2 significantly decreased for the WAS/Potato of 1:2 while them of the others had some slight changes. Regarding the current density (Du and Li., 2017), this was probably because that organic matter released from the potato and sludge was almost depleted. Peak 3 and Peak 4 at the  $E_x/E_m$  of 240/436 and 405/468 nm, corresponding to fulvic acid-like and humic acid-like substances (Chen et al., 2003), slightly increased during the whole operation even with low intensities, indicating effective hydrolysis and degradation of the solid potato and sludge as well as accumulation of some types of humic acid-like substances.

The fluorescence intensity of all detected peaks are summarized in **Figure 4b**. The intensity of Peak 2 of the WAS/Potato of 1:4 and Inactivated WAS/Potato of 1:2 was higher than that of the others and displayed an obvious increase trend during the operation, indicating more aromatic protein-like substances being released due to enhanced hydrolysis of solid potato by mixing the WAS and more organic constituents in the inactivated WAS. After 70 days' operation, Peak 2 displayed higher intensity for the Inactivated WAS/Potato of 1:2 and WAS/Potato of 1:2 and 1:4 and Peak 5 displayed higher intensity for the WAS/Potato of 1:2 and 1:4, strongly verifying that the WAS enhanced the humification of the solid potato and the inactivated WAS supported more tyrosine-like aromatic amino acids and aromatic protein-like substances.





**Figure 4** Fluorescence EEMs of dissolved organic matter in the anodic solution of MFCs treating solid potato and sludge at (1) the initial starting period (day 0); (2) the period with the highest current density; (3) the end of the operation.

\*Peak 1: tyrosine-like aromatic amino acids; Peak 2: aromatic protein-like substances; Peak 3: fulvic acid-like substances; Peak 4, 5: humic acid-like substances.

\*MFC 1 - 7: Potato; Inactivated WAS; WAS; Mixture of inactivated WAS to potato at the ratio of 1:2 and that at 1:4; Mixture of WAS to potato at the ratio of 1:2 and that at 1:4.

## CONCLUSIONS

Mixing anaerobically cultured WAS into solid potato could effectively increase the hydrolysis rate of solid potato. The increased hydrolysis products were preferentially used by electrogenic bacteria, leading to significantly enhanced electricity generation for the case when the mixing ratio of WAS to potato was smaller. However, for the case with the larger mixing ratio of WAS, the increased hydrolysis products seemed to be preferentially used by the larger number of ordinary heterotrophic bacteria brought from the WAS into the system, resulting in a marked decrease in electricity generation. Serving only as an additional organic source, the mixed feeding with inactivated WAS also enhanced electricity generation. Mixing less WAS dramatically enhanced biodegradation, humification and stabilization of solid potato and release/utilization of organic carbon in solid potato, and obviously increased concentration of viable bacteria. Compared to solid potato, more dissolved organic matter was released from sludge.

The results of this study demonstrated the effects of mixed feeding of waste activated sludge on the performance of MFC in realizing simultaneous potato waste treatment and electricity generation, and also the possibility of simultaneous treatment of waste activated sludge by



MFC. The findings obtained are considered very useful as important reference for both fundamental studies and practical applications of MFC for effective electricity generation from not only vegetable waste but also the large amount of WAS produced in the increasing number of WWTPs throughout the world. Further studies relating to the changes in the bacterial structure (both density and species) and optimum mixing ratios are important for designing optimal operation conditions when MFC is adopted for field applications to treat solid potato waste, or mixed feedstocks of solid potato and WAS.

## REFERENCES

- Chen, W., Westerhoff, P., Leenheer, J. A. & Booksh, K. 2003 Fluorescence excitation-emission matrix regional integration to quantify spectra for dissolved organic matter. *Environmental Science Technology* 37 (24), 5701-5710.
- Du, H. X. & Li, F. S. 2016 Size effects of potato waste on its treatment by microbial fuel cell. *Environmental Technology* 37 (10), 1305-1313.
- Du, H.X. & Li, F.S. 2017 Enhancement of solid potato waste treatment by microbial fuel cell with mixed feeding of waste activated sludge. *Journal of Cleaner Production* 143, 336- 344.
- Durruty, I., Bonanni, P. S., Gonzalez, J. F. & Busalmen, J. P. 2012 Evaluation of potato-processing wastewater treatment in a microbial fuel cell. *Bioresource Technology* 105, 81-87.
- Goud, R. K., Babu, P. S. & Venkata Mohan, S. 2011 Canteen based composite food waste as potential anodic fuel for bioelectricity generation in single chambered microbial fuel cell (MFC): Bio-electrochemical evaluation under increasing substrate loading condition. *International Journal of Hydrogen Energy* 36 (10), 6210-6218.
- Jia, J., Tang, Y., Liu, B. F., Wu, D., Ren, N.Q. & Xing, D. F. 2013 Electricity generation from food wastes and microbial community structure in microbial fuel cells. *Bioresource Technology* 144, 94-99.
- Justin Cook, C. 2014 Potatoes, Milk, and the Old World Population Boom. *Journal of Development Economics* 110, 123-138.
- Li, Z., Haynes, R., Sato, E., Shields, M. S., Fujita, Y. & Sato, C. 2014 Microbial Community Analysis of a Single Chamber Microbial Fuel Cell Using Potato Wastewater. *Water Environment Research* 86 (4), 324-330.
- Logan, B. E. 2007 Microbial fuel cells. John Wiley and Sons, Inc., New Jersey.
- Suor, D., Ma, J., Wang, Z., Li, Y., Tang, J. & Wu, Z. 2014 Enhanced power production from waste activated sludge in rotating-cathode microbial fuel cells: the effects of aquatic worm predation. *Chemical Engineering Journal* 248, 415-21.
- Venkata Mohan, S., Mohanakrishna, G. & Sarma, P. N. 2010. Composite vegetable waste as renewable resource for bioelectricity generation through non-catalyzed open-air cathode microbial fuel cell. *Bioresource Technology* 101, 970-976.
- Xiao, B., Yang, F. & Liu, J. 2013 Evaluation of electricity production from alkaline pretreated sludge using two-chamber microbial fuel cell. *Journal of hazardous materials* 254, 57-63.
- Yan, J. Y., Chou, S. K., Desideri, U. & Lee, D. J. 2014 Transition of clean energy systems and technologies towards a sustainable future. Fifteenth International Conference on Atmospheric Electricity (ICAE 2014), Norman, Oklahoma, USA, *Applied Energy* 160, 619-1006.

# EFFECTIVENESS OF MINERALS FORMED BY CHEMICAL PRECIPITATION IN LANDFILL LEACHATE AMMONIA REMOVAL PROCESS AS SOURCE OF PLANT NUTRIENTS

Ref # S2SMALL-17497

J. Schneider<sup>1\*</sup>, D. Silva<sup>2</sup>, R.P.S. Silva<sup>3</sup>, J. L. Paixão-Filho<sup>1</sup>, J. P. O. Ferreira<sup>4</sup>, A. L. Tonetti<sup>1</sup>

<sup>1</sup> School of Civil Engineering, Architecture and Urban Design – FEC, Sanitation and Environment Dept., University of Campinas – UNICAMP, PO Box 6021, 13083-889 Campinas (SP) Brazil.

<sup>2</sup> Institute of Geosciences, University of Campinas, PO Box 6152, Campinas 13083-970, São Paulo, Brazil.

<sup>3</sup> Egrégora Inteligência Consulting, Imaculada Conceição 81 / 174, São Paulo, SP, Brazil.

<sup>4</sup> School of Agricultural Engineering (FEAGRI), University of Campinas, Cândido Rondon, 501, Campinas, SP, Brazil.

\* Corresponding Author: [jerusasch@gmail.com](mailto:jerusasch@gmail.com) (J. Schneider)

**Keywords:** Carnallite, Landfill leachate, Phosphorus, Sustainable fertilizer

## INTRODUCTION / MAIN METHODS

Recover nutrients contained in landfill leachate represent a sustainable way to supply the agricultural sector demand these essential resources. The leachate has a high concentration of ammonia, toxic to living organisms that must be removed in pretreatment before its disposal. During the ammonia removal process, we may have precipitation of struvite ( $\text{MgNH}_4\text{PO}_4 \cdot 6\text{H}_2\text{O}$ ) (Paixão-Filho et al, 2017). Producing struvite to supply plant nutrients may transform waste and leachate into an alternative source to meet the demand for phosphorus-based fertilizers (Sigurnjak et al., 2016). However, the quality of the input material will influence the agricultural productivity obtained when it is used as a substitute for mineral fertilizers (Uysal et al., 2014).

This study aims to evaluate the potential of struvite formed from the chemical precipitation of leachate from landfill in the release of essential nutrients for lettuce (*Lactuca sativa* L.) and wheat (*Triticum aestivum* L.)

The struvite used was obtained from leachate of the Delta A landfill, located in the city of Campinas, São Paulo, by means of precipitation tests using  $\text{MgCl}_2 + 6\text{H}_2\text{O}$  e  $\text{Na}_2\text{HPO}_4 + 12\text{H}_2\text{O}$ .

X-ray diffraction analysis was used to characterize the precipitated material samples. From these analyses, two samples were selected from the precipitated material: i) Sample with struvite presence (S), and ii) Sample with presence of struvite and carnallite (SC). Carnallite ( $\text{KMgCl}_3 \cdot 6\text{H}_2\text{O}$ ) is an important mineral because it can be a source of potassium for plants.

The study was conducted under greenhouse conditions in the School of Agricultural Engineering (FEAGRI) at University of Campinas (UNICAMP), Brazil from November 2015 till June 2016. The soil used as a substrate was a eutrophic red argisol, which was collected in the experimental area of the Department of Sanitation and Environment of the Faculty of Civil Engineering, Architecture and Urbanism (FEC), on the campus of UNICAMP, in Campinas-SP, Brazil. We collected soil samples from the surface layer (0–0.2 m in depth). The samples were air-dried, ground to pass a 2 mm mesh sieve and homogenized. Results of soil physical and chemical composition is presented in Table 1.

**Table 1.** Chemical and physical description of soil used for cultivation of lettuce and wheat.

Chemical characterization													
pH <sup>(1)</sup>	P <sup>(2)</sup>	K <sup>(2)</sup>	Ca <sup>(2)</sup>	Mg <sup>(2)</sup>	OM <sup>(3)</sup>	H + Al <sup>(4)</sup>	BS <sup>(5)</sup>	CEC <sup>(6)</sup>	V% <sup>(7)</sup>	Cu <sup>(8)</sup>	Fe <sup>(8)</sup>	Mn <sup>(8)</sup>	Zn <sup>(8)</sup>
-	mg/dm <sup>3</sup>	mmolc/dm <sup>3</sup>	mmolc/dm <sup>3</sup>	mmolc/dm <sup>3</sup>	g/dm <sup>3</sup>	mmolc/dm <sup>3</sup>	mmolc/dm <sup>3</sup>	mmolc/dm <sup>3</sup>	%	mg/dm <sup>3</sup>	mg/dm <sup>3</sup>	mg/dm <sup>3</sup>	mg/dm <sup>3</sup>
6.6	16	4.4	105	11	82	24	120.4	144.4	83	3.8	14	5.7	1.8
Physical characterization													
Clay <sup>(9)</sup> < 0,002 mm				Silt <sup>(9)</sup> 0,053 – 0,002 mm				Total sand <sup>(9)</sup> 2,00 – 0,0053 mm					
g.kg <sup>-1</sup>													
506				106				388					

(1) Calcium Chloride 0.01 mol L<sup>-1</sup>; (2) Ion exchange resin; (3) Organic matter-oxidation:  $\text{Na}_2\text{Cr}_2\text{O}_7$  4N +  $\text{H}_2\text{O}_4$  10N; (4) Potential acidity at pH 7.0 extracted with 1 mol L<sup>-1</sup> calcium acetate; (5) Base saturation; (6) Cation exchange capacity; (7) Percent base saturation; (8) Extractor with DTPA complexing solution; (9) Pipette method (Gee and Bauder, 1986).

The precipitated material containing struvite (S) and struvite + carnallite (SC) were applied to the soil and the dosages of the precipitate per pot were determined based on the amount of total phosphorus of the precipitate obtained, soil analysis and on fertilization recommendations for lettuce and wheat.

Lettuce seedlings containing three to four leaves and pre-germinated wheat seeds were transplanted to pots with 1 kg soil capacity. The experiment was conducted randomly with eight treatments with four replicates, totaling 32 plots per crop species as presented in Table 2.

**Table 2.** Composition of the treatments used for the installation of the experiment

Treatments	Nutrient source
T0	Control without fertilizers
T1	Mineral fertilizer, NPK (10:10:10)
T2	S applied at half the recommended dose P
T3	SC applied at half the recommended dose P
T4	S applied at the recommended dose of P
T5	SC applied at the recommended dose of P
T6	S applied at twice the dose of P
T7	SC applied at twice the dose of P

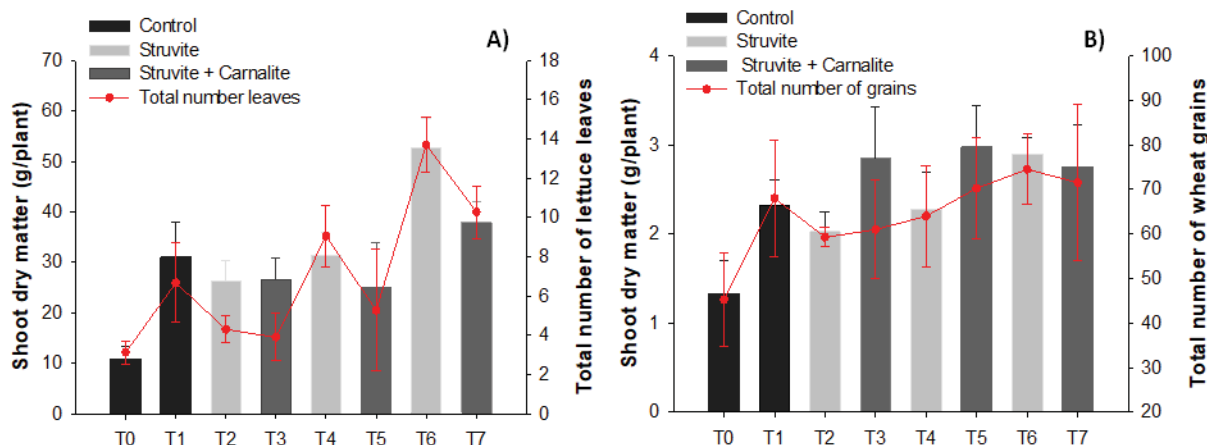
At 40 days after transplantation of lettuce and 180 days of wheat sowing, the plants were harvested and the number of leaves per plant, fresh masses and number of grains were measured. Samples were taken for circulation forced air oven at 65°C for 48 h to obtain the shoots dry matter (SDM).

## MAIN RESULTS AND CONCLUSIONS

Regarding the phytomass production of lettuce plants, it was possible to observe that the treatments at the recommended dose (T4) presented similar results to the treatment with mineral fertilizer, NPK. Those in T6 (doubled P dose) presented the highest number of leaves and a higher phytomass production, and those in T7 (double P dose with SC) presented results close to that of mineral fertilizer, NPK (T1) (Figure 1A).

However, treatments that received SC for wheat showed higher phytomass production (T3, T5 and T7) and higher grain yield in treatments (T5 and T6) when compared to control treatments (T0 and T1). On the other hand, S Treatments T4 and T6 obtained similar and superior production in relation to the NPK commercial fertilizer (T1), respectively (Figure 1B).

Unlike the results found in this work, Ackerman et al (2013) observed that shoot biomass Canola (*Brassica napus* L) had a higher phytomass production in the use of mineral fertilizers (monoammonium phosphate). According to Vogel et al (2015) the nutrient use efficiency may be related to the plant species used. The release of organic acids by the root system of some species of plants contributes to improve the release of nutrients applied to the soil by struvite (Talboys et al., 2015). In an experiment with maize higher phytomass production was observed upon treatment with struvite and this phytomass was superior to treatment with mineral fertilizer (Vogel et al., 2015).



**Figure 1.** Dry matter of shoots and total number of lettuce leaves (A) and wheat grains (B) submitted to different doses of struvite and struvite + carnallite. Vertical bar represents the standard deviation, n= 4.

Our conclusion is that these results are important to show that struvite and carnallite obtained from leachate can be used as sources for plant nutrients, thus helping to lower the costs of leachate disposal treatments and promoting the integration among agricultural production and soil/ water preservation.

#### ACKNOWLEDGEMENTS

The authors would like to thank FAPESP (São Paulo Research Foundation, PROCESSO 2011/21919-7) for financing this study. Jerusa Schneider thanks the CAPES-PNPD program (PROJECT PNPD N° 20131777) for research fellowships.

#### REFERENCES

- Ackerman J.N., Zvomuya F., Cicek N. & Flaten D. 2013. Evaluation of manure-derived struvite as a phosphorus source for canola. *Canadian Journal of Plant Science*, 93, 419-424. DOI: 10.1139/CJPS2012-207
- Paixão-Filho J.L., Tonetti A.L., Guimarães M.T. & Silva D. 2017 Nutrient recovery from airplane wastewater: composition, treatment and ecotoxicological assay. *Water Science and Technology*, 75, (7-8) 1952-1960. DOI: 10.2166/wst.2017.081
- Sigurnjak I., Michels E., Crapé S., Saski B., Tack F.M.G. & Meers E. 2016 Utilization of derivatives from nutrient recovery processes as alternatives for fossil-based mineral fertilizers in commercial greenhouse production of *Lactuca sativa* L. *Scientia horticultrae*, 198, 267-276. DOI: 10.1016/j.scienta.2015.11.038
- Talboys P.J., Heppell J., Roose T., Healey J.R., Jones D.L. & Withers, P.J.A. 2015. Struvite: a slow-release fertilizer for sustainable phosphorus management? *Plant and Soil*, 401, 109-123, DOI 10.1007/s11104-015-2747-3
- Vogel T., Nelles M. & Eichler-Lobermann, B. 2015. Phosphorus application with recycled products from municipal waste to different crop species. *Ecological engineering*, 83, 466-475. DOI: 10.1016/j.ecoleng.2015.06.044
- Uysal A., Demir S., Sayilgan E., Eraslan F. & Kucukyumuk Z. 2014 Optimization of struvite fertilizer formation from baker's yeast wastewater: growth and nutrition of maize and tomato plants. *Environment Science Pollution Research*, 21, (5) 3264-3274. DOI 10.1007/s11356-013-2285-6

## **4KET4Reuse: seeking sustainable solutions for removing emerging contaminants in wastewater**

**Aragón, C.<sup>1</sup>, Chiron, S.<sup>2</sup>, Couto, N.<sup>3</sup>, Undabeytia, T.<sup>4</sup>, Pascoal, A.<sup>5</sup>, Berná, A.<sup>6</sup>**

<sup>1</sup> Centro de las Nuevas Tecnologías del Agua. Autovía Sevilla-Huelva (A49), km. 28. 41820. Carrión de los Céspedes, España.

<sup>2</sup> UMR HydroSciences Montpellier, Institut de Recherche pour le Développement. - Université de Montpellier -300, avenue du Professeur Emile Jeanbrau, 34090 Montpellier, France.

<sup>3</sup> Faculdade de Ciência e Tecnologia da Universidade de Lisboa. Departamento de Ciências e Engenharia do Ambiente- CENSE. Campus de Caparica. 2829-516 Caparica, Portugal.

<sup>4</sup> CSIC, Instituto de Recursos Naturales y Agrobiología. Departamento de Agroquímica, Microbiología Ambiental y Conservación de Suelos. Reina Mercedes 10. Apdo. 1052. 41080 Sevilla, España

<sup>5</sup> Associação Parque de Ciência e Tecnologia Almada/Setúbal - Madan Parque. Rua dos Inventores. 2825182.Caparica, Portugal.

<sup>6</sup> Nanoelectra S.L. Av. Punto Com, 2. 28805. Alcalá de Henares, España.

**Keywords:** emerging contaminants, key enabling technologies, water reuse, bioelectrogenesis, modified clays, electrokinetic processes, photocatalysis.

### **Introduction**

Water is considered an unlimited resource no longer. The potential role of treated wastewater reuse as an alternative source of water supply is now well acknowledged and embedded within international, European and national strategies (EIP Water, 2012).

In the last decade, a wide range of technologies for wastewater treatment and reuse has been launched to obtain high-quality effluents reusable for multiple purposes. However, many of those technologies are not able to remove emerging contaminants (ECs). These contaminants, such as pharmaceutical products and their derivatives, are raising concerns due to both their biological activity and their non-biodegradability which motivates their bioaccumulation in the food chain (for example, in plants in case of irrigation).

The main objective of 4KET4Reuse project is the validation of four key enabling technologies (KET) for the removal of emerging contaminants in reclaimed water and their promotion in the market of the SUDOE space. Since the conceptual design of the four targeted KETs, sustainability and eco-friendly criteria will be adopted, thus, meaning a feasible solution for small and medium size populations.

4KET4Reuse is financed by the Cooperation Programme Interreg V-B Southwest Europe (Interreg Sudoec), approved on the 18th of June 2015 by the European Commission.



## Material and Methods

The work plan of 4KET4Reuse is composed of four technical work packages (WP) and three transversal ones (management, communication and monitoring). WP1 aims at defining a common framework for the validation of the four targeted KET in the SUDOE space. That common approach involves the identification of relevant ECs and the definition of a joint validation strategy. WP2 focuses on the design, construction, operation and optimization of the targeted KET. The three participating regions and their technological contribution are:

- Andalucía (Spain): filtering systems based on modified clays (nanomaterials) and bioelectrogenic systems.
- Languedoc-Roussillon (France): photo-catalytic systems.
- Lisbon (Portugal): electro-kinetic processes.

4KET4Reuse aims at positioning those innovative processes in a place close to the market, breaking down the existing barriers between the academic and water sectors and promoting the employment creation in the SUDOE space. For that purpose, not only pilot actions (TRL 5-6) in the three participating regions are foreseen, but also the definition of business plans (WP3) and the celebration of workshops for the transference of the main results, among other capitalisation activities (WP4).

## Results and Discussion

According to the information compiled in each participating region in the frame of WP1, a total of 30 ECs are considered of special interest due to their concentration and their frequency of appearance in wastewater. Those ECs will be employed for the validation of the four targeted KET.

**Table 1. List of twelve ECs considered of special relevance in the frame of 4KET4Reuse project**

EC	Category	Frequency of appearance (%)		
		ES	FR	PT
Ibuprofen	Anti-inflammatory	100	100	89
Atenolol	$\beta$ - blocker	100	100	44
Diclofenac	Anti-inflammatory	62	100	22
Ketoprofen	Anti-inflammatory	29	53	55
Carbamazepine	Anticonvulsant	3	72	11
Sulfametoxazol	Antibiotics	15	39	11
Clarithromicine	Antibiotics	6	100	44
Venlafaxine	Antidepressant	100	100	-
Salicylic acid	Analgesic	100	-	100
Sotalol	$\beta$ - blocker	5	100	-
Tonalide	Fragrance	-	100	100
Trimetoprim	Antibiotics	3	100	-

## References

European Innovation Partnership Water. Strategic Implementation Plan. Brussels. December 2012.



## Our sponsors and partners



**IMT Atlantique**  
Bretagne-Pays de la Loire  
École Mines-Télécom

