



HAL
open science

Prototyping of Open Source NB-IoT Network

Chiehchun Chen, Ray-Guang Cheng, Chung-Yin Ho, Matthieu Kanj, Bruno Mongazon-Cazavet, Navid Nikaein

► **To cite this version:**

Chiehchun Chen, Ray-Guang Cheng, Chung-Yin Ho, Matthieu Kanj, Bruno Mongazon-Cazavet, et al.. Prototyping of Open Source NB-IoT Network. IEEE Global Communications Conference (IEEE GLOBCOM), Dec 2020, Taipei, Taiwan. <hal-02952116>

HAL Id: hal-02952116

<https://hal.science/hal-02952116v1>

Submitted on 29 Sep 2020

HAL is a multi-disciplinary open access archive for the deposit and dissemination of scientific research documents, whether they are published or not. The documents may come from teaching and research institutions in France or abroad, or from public or private research centers.

L'archive ouverte pluridisciplinaire HAL, est destinée au dépôt et à la diffusion de documents scientifiques de niveau recherche, publiés ou non, émanant des établissements d'enseignement et de recherche français ou étrangers, des laboratoires publics ou privés.



HAL Authorization

Prototyping of Open Source NB-IoT Network

Chieh-Chun Chen*, Ray-Guang Cheng*, Chung-Yin Ho*, Matthieu Kanj**,
Bruno Mongazon-Cazavet⁺, Navid Nikaein⁺⁺,

*National Taiwan University of Science and Technology (NTUST), **B-COM, France,

⁺Nokia Bell Labs, France, ⁺⁺EURECOM, France

Email: crg@gapps.ntust.edu.tw; bruno.mongazon-cazavet@nokia-bell-labs.com

Abstract—

Narrowband Internet-of-Things (NB-IoT) is one of the major access technologies proposed to support massive machine type communications (mMTC) services for the 5th generation (5G) mobile networks. Many emerging services and networking paradigms are expected to be developed on top of NB-IoT networks. This paper summarizes the steps required to build up an open source narrowband Internet-of-Things (NB-IoT) network. This work is a joint research and development (R&D) result from industry and academic collaboration. The open source NB-IoT enhanced Node B (eNB) is jointly developed by B-COM and NTUST based on the well-known OpenAirInterface™ (OAI) open source Long-Term Evolution (LTE) eNB developed by EURECOM. The NB-IoT eNB is successfully connected to an evolved packet core (EPC) developed by Nokia Bell Lab. We demonstrate how to use commercial off-the-shelf (COTS) NB-IoT module to forward its sensing data to the Internet via the open source NB-IoT network.

Index Terms—NB-IoT, MAC, open source

I. INTRODUCTION

The 5th generation (5G) network is designed to support three primary use cases of enhanced mobile broadband (eMBB), ultra-reliable and low latency (uRLLC) and massive machine type communications (mMTC). The deployment of new services/applications in ever-changing fast paced cellular networks may greatly change the way we live, work, and play. Current generations of hardware/software for radio access network (RAN) consist of many proprietary elements, which increase the cost for the operators and stifle innovation. Open source software and hardware reference design, which enables faster and permissionless innovation, is one of the most efficient ways to accelerate 5G/B5G product development [1]. Open source software running on general purpose processors can greatly simplify network access, reduce cost, increase flexibility, improve innovation speed and accelerate time-to-market for introducing new services [2].

OpenAirInterface™ (OAI) [3] is one of the open-source solutions implementing the 3rd Generation Partnership Project (3GPP) Long-Term Evolution (LTE) standard developed by EURECOM. Based on the initial work of OpenAirInterface™, a non-profit consortium named OpenAirInterface™ Software Alliance (OSA) [2] is funded to foster a community of industrial and research contributors for open source software and hardware development for the core network (EPC), radio access network (RAN) and user equipment (UE) of 5G cellular

stack on commercial off-the-shelf (COTS) hardware. One of the on-going projects in OSA is narrowband Internet-of-Things (NB-IoT) eNB [4]. The OAI NB-IoT eNB project implements the physical layer functions and the protocols stacks 3GPP R'13 standard. NB-IoT is a 3GPP standard defined to support mMTC service. NB-IoT is evolved from LTE-Advanced (LTE-A) standard orthogonal frequency-division multiple access (OFDMA) technology but each carrier only requires 180 kHz bandwidth. It supports ‘stand-alone,’ ‘in-band,’ and ‘guard band’ modes. NB-IoT utilizes repetitions to enhance the coverage of the eNB. Up to three coverage enhancement (CE) levels can be supported by one eNB [5].

The general principle in implementing an NB-IoT eNB is to start with the LTE protocols and reduce them to a minimum with functionalities optimized for NB-IoT. The protocol stacks of NB-IoT are the same as LTE, which include packet data convergence protocol (PDCP), radio resource control (RRC), radio link control (RLC) and MAC layers. We replace the whole MAC layer and revise the radio link control (RLC) and packet data convergence protocol (PDCP) protocols. The physical (PHY) layer functionalities are developed by B-COM. All downlink/uplink channels and signals were developed taking into account the new requirements of NB-IoT system (e.g. repetitions, 15 kHz and 3.75 kHz subcarrier spacing, etc.). Most of the effort in implementing the OAI NB-IoT eNB was mainly on the medium access control (MAC) layer. It is because the repetition technique adopted by NB-IoT results in a totally different implementation of random-access channel and medium access control (MAC) scheduler than that of LTE. The challenge and the basic design concept of an NB-IoT MAC scheduler was introduced in [6]. In [7], the background knowledge required (e.g., key messages and their scheduling interval required by UE to attach the NB-IoT eNB); the flow chart of the main function; the MAC layer architecture; and the flow chart of the MAC scheduler were elaborated. Note that the proposed open source NB-IoT eNB further supports the functional split option 6. The standard interface between MAC and PHY layers follow the standard functional application platform interface (FAPI) and network functional application platform interface (nFAPI) specification defined by Small Cell Forum [8]. Currently, we can use COST UE to connect the proposed NB-IoT eNB, and ping a Google server via Nokia’s EPC.

This paper presents the steps and software tools required for installing an open source NB-IoT network. The open source NB-IoT network can be used by academic and industrial researchers to develop and test their own emerging services and networking paradigms. The rest of the paper is organized as

below. Section II summarizes the guideline for installing NB-IoT eNB and UE. This paper focuses on the building up the NB-IoT testing environment, and the demonstration of the data transition is given in Sec. III. Conclusion and the future work are given in Sec. IV.

II. GUIDELINE FOR INSTALLING NB-IoT eNB & UE

A. Environment

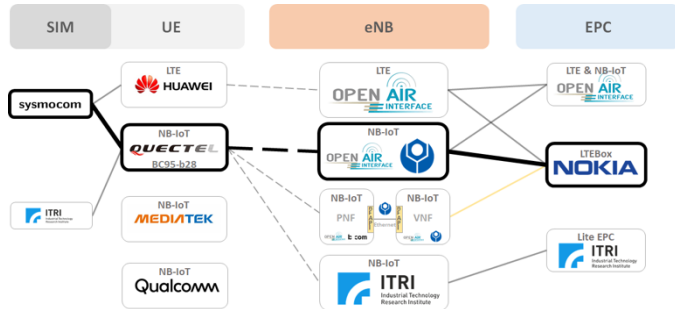

Fig. 1 The testing environment in BMW Lab.

Figure 1 shows the testing environment adopted in Broadband Multimedia Wireless Laboratory (BMW Lab.), NTUST. We setup an OAI LTE network, where a COST UE can connect to OAI LTE eNB and OAI EPC for surfing the Internet. We also build up a commercial version of NB-IoT eNB and EPC running on the same personal computer (PC) developed by Industrial Technology Research Institute (ITRI), Taiwan. We further setup two versions of the NB-IoT eNB. The first version implements the functional-split feature of the eNB using nFAPI, where the PHY and the higher stacks are running in a physical network function (PNF) and a virtual network function (VNF), respectively. VNF and PNF are run on two PCs connected by Ethernet. The details of design of this version can be referred to [7]. The second version is an integrated NB-IoT eNB considered in this paper. The COST UE consists of a Quectel BC95-B28 Module [9] and a configurable SIM card purchased from sysmocom [10]. The source code of NB-IoT eNB can be downloaded from OAI develop-nb-iot branch (ae16b6fde164869825a6bae84175d158e1f4fac9) [11]. The eNB is installed on a PC with Ubuntu16.04 operational system with a Universal Software Radio Peripheral (USRPTM) B200 or B210 software-defined radio kit [12]. We utilize Nokia LTEBox as EPC since OAI EPC does not support NB-IoT at this moment. Note that academic researchers may contact with Burno to request for non-disclosure agreement (NDA) from Nokia Bell Lab., France, to use the LTEBox. We use BC95-B28, its frequency band is 28.

B. Install NB-IoT eNB

STEP 1: Follow the commands shown in Fig. 2 to build NB-IoT eNB

STEP 2: Copy the configuration file and modify the physical parameters as illustrated in Fig. 3 And set the IP addresses of the mobility management entity (MME) and eNB as shown in Fig. 4. The example is shown below:

```
mme_ip_address = { { ipv4 = "192.168.0.1" ;
```

```
...
```

```
NETWORK_INTERFACE:
```

```
{
```

```
ENB_INTERFACE_NAME_FOR_S1_MME = "eth0";
```

```
ENB_IP4_ADDRESS_FOR_S1_MME = "192.168.0.2/24";
```

```
ENB_INTERFACE_NAME_FOR_S1U = "eth0";
```

```
ENB_IP4_ADDRESS_FOR_S1U = "192.168.0.2/24";
```

```
ENB_PORT_FOR_S1U = 2152;
```

```
};
```

The example of connection between the eNB and MME is shown as Fig. 5.

STEP 3: Follow the commands shown in Fig. 6 to run NB-IoT eNB

- Clone the source code & Install the packages

```
$ git clone https://gitlab.eurecom.fr/oai/openairinterface5g.git
$ cd openairinterface5g; git checkout develop; cd cmake_targets
$ sudo ./build_oai -I --eNB -x --install-system-files -w USRP
```

- Checkout to the develop-nb-iot branch & Build the eNB (commit: ae16b6fde164869825a6bae84175d158e1f4fac9)

```
$ cd openairinterface5g; git checkout develop-nb-iot
$ cd cmake_targets; sudo ./build_oai -w USRP -x -c -eNB
```

Fig. 2 Build NB-IoT eNB

- Copy the configuration file

```
$ cd openairinterface5g/targets/PROJECTS/GENERIC-LTE-EPC/CONF
$ cp enb.nbiot.band7.tm1.50PRB.usrbp210.config ~/nbiot_test.conf
```

- Modify the following parameters in configuration file

```
component_carriers =
```

```
{ { ...
```

```
  eutra_band = 28;
```

```
  downlink_frequency = 780000000L;
```

```
  uplink_frequency_offset = -55000000;
```

```
  ...
```

```
  rach_raResponseWindowSize_NB = 8;
```

```
  rach_macContentionResolutionTimer_NB = 32;
```

```
  rach_preambleInitialReceivedTargetPower_NB = -90;
```

```
  nprach_SubcarrierMSG3_RangeStart = "zero"
```

```
  maxNumPreambleAttemptCE_NB = 3;
```

```
  numRepetitionsPerPreambleAttempt = 1;
```

```
  npdcch_NumRepetitions_RA = 4;
```

```
  npdcch_StartSF_CSS_RA = 2;
```

```
  npdcch_Offset_RA = "oneFourth";
```

```
});
```

Fig. 3 Modify the physical parameters configuration file

```

#----- SCTP definitions
SCTP :
{
    # Number of streams to use in input/output
    SCTP_INSTREAMS = 2;
    SCTP_OUTSTREAMS = 2;
};

////////// MME parameters:
mme_ip_address = { (Ipv4 = "192.178.0.1"; #IP address of LTEBox
    Ipv6 = "192:168:301:11";
    active = "yes";
    preference = "Ipv4";
});

NETWORK_INTERFACES :
{
    ENB_INTERFACE_NAME_FOR_S1_MME = "eth0"; #Interface of your NB-IoT eNB
    ENB_IPV4_ADDRESS_FOR_S1_MME = "192.178.0.2/24"; #IP address of your NB-IoT eNB/subnet mask
    ENB_INTERFACE_NAME_FOR_S1U = "eth0"; #Interface of your NB-IoT eNB
    ENB_IPV4_ADDRESS_FOR_S1U = "192.178.0.2/24"; #IP address of your NB-IoT eNB/subnet mask
    ENB_PORT_FOR_S1U = 2152; # Spec 2152
};

```

Fig. 4 Modify the IP address in configuration file

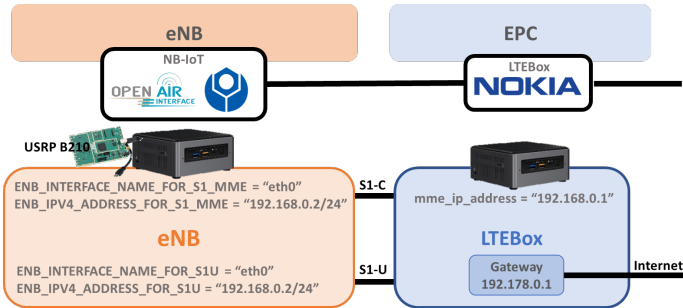

Fig. 5 The connection between the eNB and LTEBox

```

• Run the NB-IoT eNB by your config file (e.g. nbiot_test.conf)
$ cd openairinterface5g/cmake_targets/lte_build_oai/build
$ sudo ./lte-softmodem -O ~/nbiot_test.conf

```

Fig. 6 Run NB-IoT eNB

C. Configure the UE module

STEP 1: Install UE Logviewer

STEP 2: Install AT COMMAND tool (Q Navigator [13]), and set serial port parameter shown in Fig. 7

STEP 3: Run UE Logviewer, and choose the Debug port to see the message at the UE side as Fig. 8

STEP 4: Run AT COMMAND to reboot the module and lock the frequency

Reboot the module: **AT+NRB [14]**

Lock the frequency: **AT+NEARFCN=0,9448 [14]**

STEP 5: Using different filter condition in UE Logviewer to know the message that receive and send by the UE module shown in Fig. 9. There have some filter conditions we used as below:

RRC_DEBUG_ASN: message in RRC layer of UE side

NAS_DBG_NAS_MSG: message in NAS layer of UE side

RACH: procedure in UE side

D. Configure the LTEBox EPC

There have two S1 interface including control plane and user plane in the EPC. The NB-IoT eNB only support the control plane case, so the IP address of S1 user plane interface must be set same as S1 control plane.

E. Configure the SIM card

STEP 1: Prepare a PC/SC Smart Card Reader that can be used in Linux.

STEP 2: Install the necessary software for the card reader as shown in Fig. 10. If the installation is correct, the `pcsc_scan` should be executed after the SIM card is inserted into the card reader, then we can see the information of card reader as illustrated in Fig. 11.

STEP3: Install the burning software (PySIM[15]) by the command shown in Fig. 12.

STEP4: Start burning the SIM card by the information provided from the Gitlab Wiki of `openairinterface5G` [16]. After burning the SIM card successfully, it will show the information as Fig. 13.

STEP5: If you want to see the SIM card information after burning, you need to checkout to master branch and run the command shown as Fig. 14.

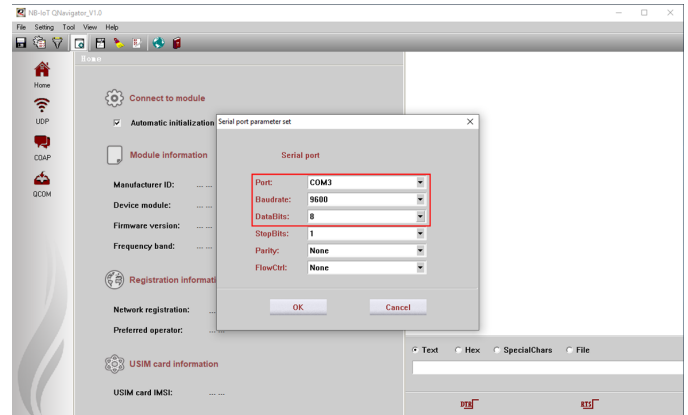

Fig. 7 Set the serial port in AT command tool[13]

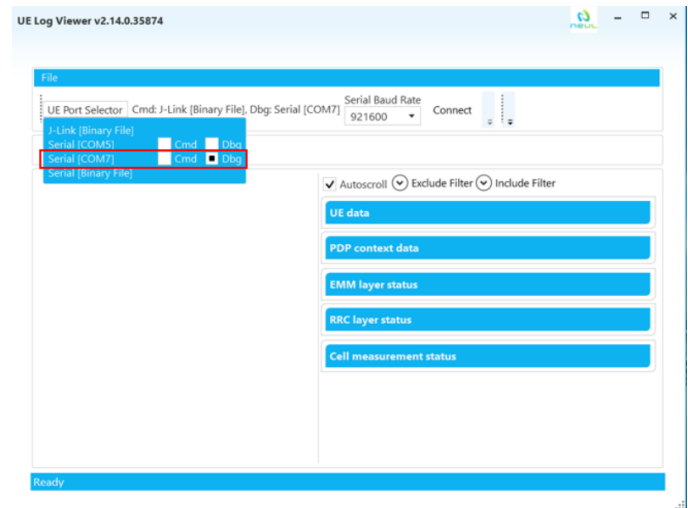

Fig. 8 Select the debug port

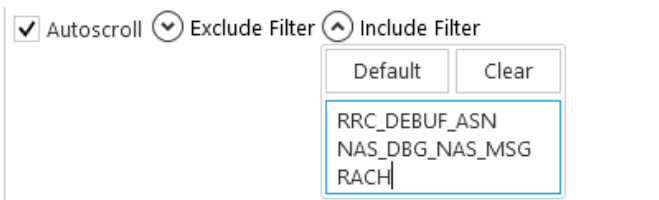

Fig. 9 Filter the specific message

• **Install the card reader software**

```
$ sudo apt-get install pcscd pcsc-tools libccid libpcsc-lite-dev
$ sudo pcsc_scan /* Can see the card reader information */
```

Fig. 10 Install the card reader software

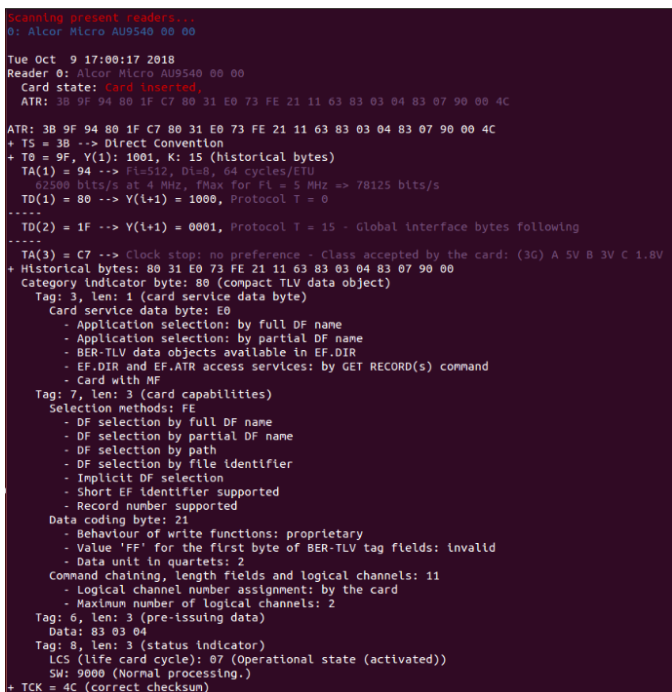

Fig. 11 SIM card information

• **Install PySIM**

```
$ git clone git://git.osmocom.org/pysim pysim; cd pysim
• Install the PySIM requirements
$ sudo apt-get install python-pyscard python-serial python-pip
$ sudo pip install pytlv
$ git checkout zecke/tmp2
```

Fig. 12 Install PySIM

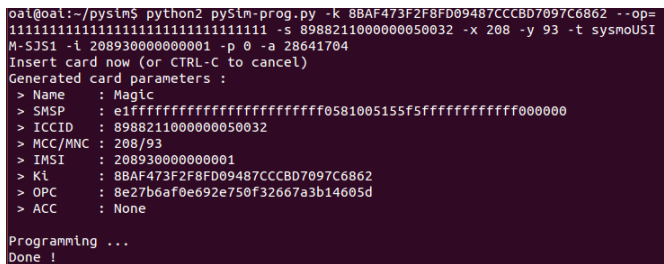

Fig. 13 Burning successfully

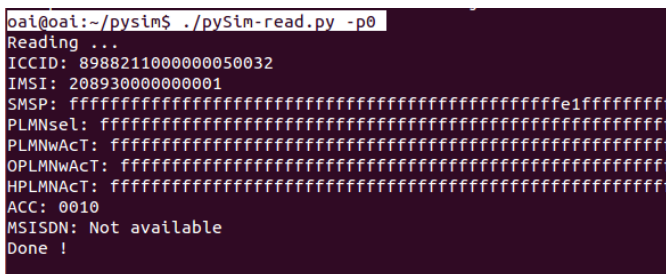

Fig. 14 SIM card information after burning

III. DEMONSTRATIONS

The network configuration of NB-IoT testing is shown in Fig. 15. We use three PCs running the NB-IoT eNB, LTEBox and UE module, respectively. The NB-IoT UE module is connected to the NB-IoT eNB by doing the random-access procedure, after that the NB-IoT UE module would do the attach procedure with LTEBox to authenticate the SIM card information. During the attach procedure, the NB-IoT UE module transmits the message and the NB-IoT eNB forward these messages to the LTEBox. To see the attach procedure between the eNB and LTEBox, we can get the SIAP message by the Wireshark as shown in Fig. 16.

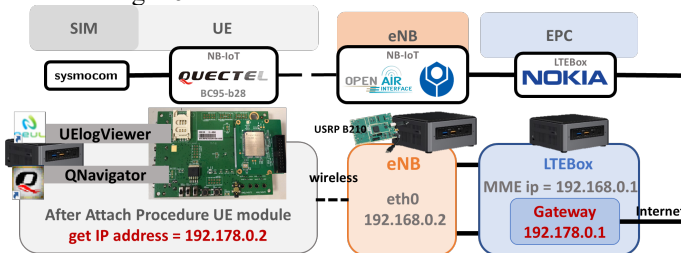

Fig. 15 Network configuration for NB-IoT testing

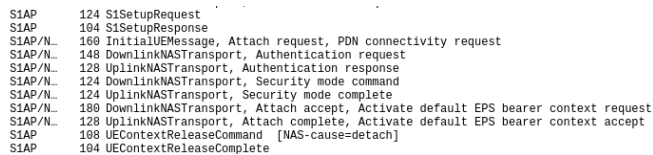

Fig. 16 Attach procedure between the eNB and MME

After completing the attach procedure, the NB-IoT UE module will get an IP address from the gateway and we use AT command to ping to Google DNS server (8.8.8.8), as illustrated in Fig. 17

Time	Source	Destination	Protocol	Length	Info
1743.10347.503701	eNB ip address	MME ip address	SIAP	124	S1SetupRequest
1743.10347.504659	MME ip address	eNB ip address	SIAP	104	S1SetupResponse
1747.10364.405380	eNB ip address	MME ip address	SIAP/NL	180	InitialUEMessage, A
1747.10364.412458	MME ip address	eNB ip address	SIAP/NL	112	DownlinkNASTranspor
1748.10365.645238	eNB ip address	MME ip address	SIAP/NL	128	UplinkNASTransport,
1748.10365.653122	MME ip address	eNB ip address	SIAP/NL	148	DownlinkNASTranspor
1749.10366.981229	eNB ip address	MME ip address	SIAP/NL	128	UplinkNASTransport,
1749.10366.985524	MME ip address	eNB ip address	SIAP/NL	124	DownlinkNASTranspor
1750.10368.181234	eNB ip address	MME ip address	SIAP/NL	124	UplinkNASTransport,
1750.10368.196568	MME ip address	eNB ip address	SIAP/NL	180	DownlinkNASTranspor
1751.10369.509272	eNB ip address	MME ip address	SIAP/NL	128	UplinkNASTransport,
1751.10369.717762	192.178.0.2	8.8.8.8	ICMP	60	ping request
1751.10369.725873	8.8.8.8	192.178.0.2	ICMP	60	ping response

Fig. 17 Ping test from UE to 8.8.8.8

Besides, we also can use AT command to send a UDP packet to the LTEBox shown as Fig. 18. At the LTEBox side, we need to open the UDP port to receive the data from NB-IoT UE module as shown in Fig. 19. Also, we can get the information between the LTEBox and UE by the Wireshark as shown in Fig.

20. Follow the AT command manual [14], the command for sending the UDP packet can be explained as below:

```
AT+NSOST = <socket number>, <remote ip address >,
<remote port>, <length>, <data> [14]
<socket number>: 0
<remote ip address >: LTEBox ip address, ex:192.168.0.2
<remote port>: 50000
<length>: data length(bytes)
<data>: 48656c6c6f204e54555354(hex)
```

```
[2020-01-08 17:27:18:871_S_] AT+NRB
[2020-01-08 17:27:18:883_R_]
[2020-01-08 17:27:18:899_R_] REBOOTING
[2020-01-08 17:27:19:555_R_] 痲?
[2020-01-08 17:27:23:008_R_] REBOOT_CAUSE_APPLICATION_AT
[2020-01-08 17:27:23:041_R_] Neul
[2020-01-08 17:27:23:057_R_] OK
[2020-01-08 17:27:23:696_S_] AT+NEARFCN=0,9448
[2020-01-08 17:27:24:080_R_]
[2020-01-08 17:27:24:096_R_] OK
[2020-01-08 17:27:25:544_S_] AT+NSOCR=DGRAM,17,8888,1
[2020-01-08 17:27:25:583_R_] 0
[2020-01-08 17:27:25:583_R_] OK
[2020-01-08 17:27:31:768_S_] AT+NSOST=0,140.118.123.99,50000,11,48656c6c6f204e54555354
[2020-01-08 17:27:31:835_R_]
[2020-01-08 17:27:31:851_R_] 0,11
```

Fig. 18 Send UDP data from UE by AT command

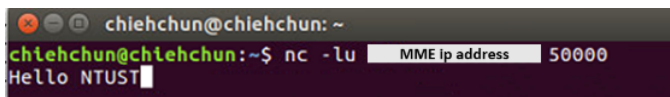

Fig. 19 Receive UDP data in LTEBox

eNB ip address	MME ip address	S1AP	124 S1SetupRequest
MME ip address	eNB ip address	S1AP	104 S1SetupResponse
eNB ip address	MME ip address	S1AP/N..	180 InitialUEMessage, At
MME ip address	eNB ip address	S1AP/N..	112 DownlinkNASTransport
eNB ip address	MME ip address	S1AP/N..	128 UplinkNASTransport,
MME ip address	eNB ip address	S1AP/N..	148 DownlinkNASTransport
eNB ip address	MME ip address	S1AP/N..	128 UplinkNASTransport,
MME ip address	eNB ip address	S1AP/N..	124 DownlinkNASTransport
eNB ip address	MME ip address	S1AP/N..	124 UplinkNASTransport,
MME ip address	eNB ip address	S1AP/N..	180 DownlinkNASTransport
eNB ip address	MME ip address	S1AP/N..	128 UplinkNASTransport,
192.178.0.2	140.118.123.99	S1AP/N..	168 UplinkNASTransport,

Fig. 20 Get the UDP packet from wireshark

IV. CONCLUSIONS AND FUTURE WORK

This paper summarizes the steps required to build up an open-source NB-IoT network. We describe the installation and configuration procedures of UE module, NB-IoT eNB and EPC in a step-to-step manner. Currently, the uplink data transmission is completed and the server can successfully receive the UDP packet. However, we found that the transmission of a data packet longer than 4 bytes may not be successfully decoded at the PHY layer of eNB. We use hardcode to revert some specific bits to fix the bugs by setting the compiling flag of NB_IOT_CRC_RECOVERY to TRUE in cmake_targets/CMakeLists.txt. Everyone can set the flag to be FALSE for revealing the issue and help us to solve the bugs. Multiple UEs stability testing can then be conducted.

ACKNOWLEDGMENT

This work was supported in part by the Ministry of Science and Technology, Taiwan, under Contract 108-2221-E-011-041-MY2 and is conducted under the “Flagship Program on 5G Communication Systems and Intelligent Applications” of the Institute for Information Industry which is subsidized by the Ministry of Economic Affairs of the Republic of China. This work is a joint work contributed by Bing-Zhi Hsieh, Wan-Rong Tsai, Kai-Hsiang Hsu, Tian-Jen Liu, Wei-Tai Chen, Yi-Chun Lin, Li-Ping Yu, Cheng-Hsun Yang, Chin-Wei Kang, and Chieh-Chun Chen.

REFERENCE

- [1] O-RAN Alliance, <https://www.o-ran.org/resources>
- [2] OpenAirInterface™ Software Alliance (OSA), <https://www.openairinterface.org/>
- [3] N. Nikaein, *et al.*, “Openair-interface: A flexible platform for 5G research,” ACM SIGCOMM Computer Communication Review, vol. 44, no. 5, pp. 33–38, 2014.
- [4] R. G. Cheng, *et al.*, “Demo abstract – Design and implementation of an open source NB-IoT eNB,” *IEEE INFOCOM 2018 – IEEE Conference on Computer Communications Workshops (INFOCOM WKSHPS)*, Honolulu, U.S.A., April 2018.
- [5] R. Harwahu, *et al.*, “Repetitions vs retransmissions: Trade-off in configuring NB-IoT random access channels,” *IEEE Internet of Things Journal*, vol. 6, no. 2, pp. 3796-3805, April 2019.
- [6] B. Z. Hsieh, *et al.*, “Design of a UE specific uplink scheduler for narrowband Internet-of-Things (NB-IoT) systems,” in The 3rd International Conference on Intelligent Green Building and Smart Grid (IGBSG 2018), YiLan, Taiwan, April 2018.
- [7] C. Y. Ho, *et al.*, “Open NB-IoT network in a PC,” *2019 IEEE Globecom Workshops (GC Wkshps)*, Waikoloa, HI, USA, Dec. 2019.
- [8] SCF082.09.05, Small Cell Forum (SCF) FAPI and nFAPI Specifications, May 2017.
- [9] BC95-B28 NB-IoT Module, <https://www.quectel.com/product/bc95g.htm>
- [10] sysmocom, <http://shop.sysmocom.de/products/sysmousim-sjs1>
- [11] OAI NB-IoT source code, <https://gitlab.eurecom.fr/oai/openairinterface5g/tree/develop-nb-iot>
- [12] USRS B210, <https://www.ettus.com/all-products/ub210-kit/>
- [13] Q Navigator, https://www.quectel.com/bbs/detail_72.htm
- [14] BC95 AT command Manual, https://www.quectel.com/UploadImage/Downlad/Quectel_BC95_AT_Commands_Manual_V1.9.pdf
- [15] PySIM, <https://github.com/osmocom/pysim>
- [16] SimCardConfig, <https://gitlab.eurecom.fr/oai/openairinterface5g/-/wikis/SimCardConfig>