



HAL
open science

Membrane gas separations and post-combustion carbon dioxide capture: Parametric sensitivity and process integration strategies

Bouchra Belaissaoui, David Willson, Eric Favre

► To cite this version:

Bouchra Belaissaoui, David Willson, Eric Favre. Membrane gas separations and post-combustion carbon dioxide capture: Parametric sensitivity and process integration strategies. *Chemical Engineering Journal*, 2012, 211-212, pp.122-132. 10.1016/j.cej.2012.09.012 . hal-02943395

HAL Id: hal-02943395

<https://hal.science/hal-02943395>

Submitted on 28 Apr 2024

HAL is a multi-disciplinary open access archive for the deposit and dissemination of scientific research documents, whether they are published or not. The documents may come from teaching and research institutions in France or abroad, or from public or private research centers.

L'archive ouverte pluridisciplinaire **HAL**, est destinée au dépôt et à la diffusion de documents scientifiques de niveau recherche, publiés ou non, émanant des établissements d'enseignement et de recherche français ou étrangers, des laboratoires publics ou privés.



Distributed under a Creative Commons Attribution - NonCommercial - NoDerivatives 4.0 International License

Membrane gas separations and post-combustion carbon dioxide capture: parametric sensitivity and process integration strategies

Bouchra Belaissaoui¹, David Willson², Eric Favre^{1,*}

1 : Université de Lorraine, LRGP, UPR CNRS 3349

1, rue Grandville
54001 Nancy
FRANCE

2: Stanbridge Capital
37 East 18th Street
New York , NY 10003
USA

* : Corresponding author :
tel. +33 383 17 53 90
Email: Eric.Favre@univ-lorraine.fr

Manuscript submitted to the Chemical Engineering Journal (June 2012)

Abstract

Reducing the Energy Cost is the primary challenge for post-combustion CO₂ capture technologies. Growing interest is being shown in membrane processes as an alternative to the reference technologies (such as gas-liquid absorption in MEA). However, these membrane processes remain energy intensive when the recommended CO₂ purity and capture ratio (both typically at 90%) are imposed. In this study, a systematic parametric analysis of the energy requirement of a membrane gas separation module has been performed. Different inlet CO₂ contents and membrane selectivity performances have been compared. In contrast to previous studies, the capture ratio and CO₂ purity constraints have been relaxed below the 90% target in order to possibly identify the most appropriate role and place of membrane processes in a Carbon Capture and Storage (CCS) framework. It is shown that diluted CO₂ feed streams (such as natural gas turbine flue gases) systematically require excessive energy for CO₂ capture. However, membrane units offer however interesting possibilities with a very low energy requirement when used as a pre-concentration step for a moderate inlet CO₂ content (15 to 30%) or as a final step for concentrated streams (50% inlet CO₂ content or more). Finally, guidelines for improved integration strategies of membrane units in different carbon capture scenarios, with a particular emphasis on hybrid processes, are proposed.

Keywords: carbon capture; gas separation; energy; simulation

Nomenclature

| | |
|-----------|---|
| P_u | Membrane module upstream side pressure (Bar) |
| P_d | Membrane module downstream side pressure (Bar) |
| P_{in} | Feed mixture pressure of the hybrid process, fixed to 1 bar. |
| P_{out} | Outlet pressure, fixed to 1bar. |
| ρ | Membrane permeability coefficient ($\text{mol}\cdot\text{m}^{-1}\cdot\text{s}^{-1}\cdot\text{Pa}^{-1}$) |
| z | Membrane thickness (m) |
| Q_{in} | Inlet total flow rate (mol/s) |
| Q_P | Permeate flow rate (mol/s) |
| Q_R | Retentate flow rate (mol/s) |
| R | Carbon dioxide capture ratio [-] |
| R | Ideal gas constant ($8.314 \text{ J}\cdot\text{mol}^{-1}\cdot\text{K}^{-1}$) |
| s | non-dimensional membrane surface area (-) |
| A_1 | Membrane surface area for compression+ERS strategy (m^2/kg of recovered $\text{CO}_2 \cdot\text{s}^{-1}$) |
| A_2 | Membrane surface area vacuum pumping strategy ($\text{GJ}_{th}/\text{ton}$ of recovered CO_2) |
| T | Temperature (K) |
| x_{in} | CO_2 mole fraction in the feed mixture (-) |
| y | CO_2 mole fraction in the permeate side (-) |
| E_1 | Energy requirement of the vacuum pumping ($\text{GJ}_{th}/\text{ton}$ CO_2 recovered) |
| E_2 | Energy requirement of compression+ERS ($\text{GJ}_{th}/\text{ton}$ CO_2 recovered) |
| E_C | Energy requirement of the compressor ($\text{GJ}_{th}/\text{ton}$ CO_2 recovered) |
| E_T | Energy recovery of the expander ($\text{GJ}_{th}/\text{ton}$ CO_2 recovered) |

Greek letters

| | |
|----------|---|
| α | Membrane selectivity [-] |
| γ | Adiabatic gas expansion coefficient [-] |
| ψ | Membrane module pressure ratio (P''/P') [-] |
| θ | Membrane module stage cut (Q_p/Q_{in}) [-] |
| η_C | Compressor isentropic efficiency (-) |
| η_V | Vacuum pump efficiency (-) |
| η_E | Expander efficiency (-) |

1. Introduction

CO₂ capture from large sources attracts considerable attention as a key strategy to mitigate greenhouse gas emissions. Among the different possibilities, post-combustion Carbon Capture and Storage (CCS) is particularly interesting because it can be in principle applied to any type of emission and offers retrofit possibilities. Nevertheless, whatever the strategy (oxy-combustion, pre-combustion or post-combustion), reducing the energy cost (and hence also the parasitic power loss) is the main challenge for the capture step. A 90% CO₂ capture ratio and 90% CO₂ purity are targets that have been imposed by the EIA in Europe and the DOE in the US.

In this context, many studies are dedicated to improve existing and already mature technologies (i.e gas-liquid absorption in amine solvents, cryogenic separation, adsorption) or to develop innovative process design. Their success hinges on their possibility of lowering the cost of CO₂ capture while still attaining the targets for CO₂ purity and for the recovery ratio.

In early selection studies membrane processes have been discarded for CO₂ capture applications. A too low CO₂/N₂ selectivity (below 50) was often mentioned as a major bottleneck. Nevertheless, a steadily increasing number of publications have recently reported on the significant challenges for carbon capture; numerous studies can be found on tailor-made polymeric membranes [1-3], fixed site reactive membranes [4-7] and zeolites [8]. Impressive improvements in CO₂/N₂ selectivity have been more recently reported, with values up to 500 [White et al.]. This new developments should promote the study of membrane processes for CO₂ capture. However, relatively few studies have been reported on engineering and process design analyses. Table 1 summarizes the characteristics of some of the key references in this domain. This study intends to contribute to engineering and process design analyses for unexplored issues.

Compared to other capture processes, membrane separation shows a very high parametric sensitivity, especially in terms of CO₂ content in the feed stream [9-12]. Additionally, simulations have shown that strong limitations occur when 90% capture ratio and 90% CO₂ purity are imposed for a single stage process. More specifically, given the performance of existing membrane materials, the target purity and capture ratio of 90% can be attained in a single stage membrane module only providing that a flue gas stream with relatively concentrated CO₂ is to be treated (typically >20% CO₂ in the feed stream) [9,13]. Unfortunately, a very large majority of CO₂ sources have a lower CO₂ content, such as 15% for coal power plants or 5% for natural gas turbine flue gases. In these cases, multistage membrane units [12, 14-15] or hybrid process design are needed [16-19], unless a concerted effort is first made to increase the CO₂ concentration through a mixture of Flue Gas Recirculation (FGR), supplementary firing, and combustion using Oxygen Enhanced Air (OEA).

It is important to stress however that the different studies which have been reported on membrane processes for CO₂ capture (Table 1) almost systematically refer to the classical baseline case: a 15% CO₂ feed stream is treated and a 90% capture ratio associated to a high CO₂ purity (80% or more) is aimed. A systematic analysis of the precise conditions (feed composition, capture ratio, purity, membrane selectivity) which minimize the energy requirement of a membrane CO₂ capture unit has not been reported yet, and this is the starting point of this study. More specifically, in contrast to previous studies, the capture ratio and CO₂ purity constraints have been relaxed and a large range of CO₂ feed contents has been tested (from 5% to 70%). The objective is to identify, through a systematic parametric study (~~and by making use of master curves~~), the most relevant role and place of membrane processes in different CCS frameworks. To that respect, the energy requirement has been considered as the main performance parameter and will be compared to the reference CO₂ capture technology (namely MEA absorption).

Table 1: Overview of key process design studies publications on membrane processes and carbon capture.

| <i>Process type</i> | <i>Feed condition</i> | <i>Process conditions and Membrane Parameters</i> | <i>Reference</i> |
|---|---------------------------|--|------------------|
| <i>Single stage process</i> | 10 to 30% CO ₂ | Feed compression/vacuum pumping α CO ₂ /N ₂ = 1-200 | 9 |
| | 10 to 15% CO ₂ | Feed compression/vacuum pumping α CO ₂ /N ₂ =29.5 ϕ CO ₂ =11-27 GPU | 10 |
| | 10 to 15% CO ₂ | Feed compression/vacuum pumping /gas sweep α CO ₂ /N ₂ =50-200 ϕ CO ₂ =100-1000 GPU | 12 |
| | 10 to 13% CO ₂ | Feed compression/ vacuum pumping α CO ₂ /N ₂ =10-200 ϕ CO ₂ =18-1100 GPU | 11 |
| <i>Multistage process (Two membrane stages)</i> | 10-20% CO ₂ | Feed compression/vacuum pumping α CO ₂ /N ₂ =29.5 ϕ CO ₂ =11-27 GPU | 10 |
| | 15% CO ₂ | Feed compression /gas sweep α CO ₂ /N ₂ =200 ϕ CO ₂ =365.5 GPU | 15 |
| | 10% CO ₂ | Feed compression/vacuum pumping α CO ₂ /N ₂ =50 ϕ CO ₂ =1000 GPU | 12 |
| | 14 % CO ₂ | Feed compression/vacuum pumping α CO ₂ /N ₂ =10-200 ϕ CO ₂ =182.75-1827.5 GPU | 14 |
| <i>Hybrid process</i> | Methane combustion | Flue gas recycle with an oxygen enriched feed mixture and CO ₂ capture by membranes α CO ₂ /N ₂ =50-200 Feed compression | 18 |
| | 5 à 30% CO ₂ | Hybrid membrane cryogenic separation for CO ₂ capture | 19 |
| | Coal combustion | Energy integration of a supercritical coal-fired power plant with CO ₂ capture by membranes α CO ₂ /N ₂ =200 | 20 |
| | Natural gas turbine | Combicap: Interconnected gas turbines with membrane CO ₂ capture unit and integrated combustor-heat exchange system | 21 |
| | 15% CO ₂ | Membrane / PSA hybrid process | 22 |

2. Membrane module simulation framework

2.1. Model description

In order to achieve gas permeation, a driving force, expressed through the pressure ratio ($\psi = P''/P'$) is required. From a material point of view, a selective membrane is obviously necessary; since only CO₂ selective membranes are available with polymeric materials, a CO₂ enriched stream is produced on the permeate side (y) from a post-combustion flue gas (x_{in}). For all simulations, similarly to a large majority of publications on carbon capture processes, a binary CO₂/N₂ dry mixture is assumed in the feed.

For a given set of conditions (such as feed composition x_{in}), the key variables influencing the process performances are as follows:

- i) The pressure ratio ($\psi = P''/P'$) between the downstream and the upstream compartments.
- ii) The membrane selectivity ($\alpha \equiv \frac{P_{CO_2}}{P_{N_2}}$) corresponding to the ratio of the permeabilities of CO₂ over N₂.
- iii) The carbon dioxide recovery ratio, $R = \theta \cdot \frac{y_p}{x_{in}}$ corresponding to the fraction of inlet CO₂ recovered in the permeate stream. $\theta = Q_p/Q_{in}$, is the stage cut defined as the ratio of permeate to feed flow rates.
- iv) The non-dimensional membrane surface area s .

The modelling of CO₂ capture by a gas separation membrane is classically based on a so-called cross-plug flow model which has been shown to offer realistic predictions of the separation performances of industrial modules (Humphrey, 1997, stern, 1990). For the specific CO₂ / N₂ mixture, under low pressure conditions such as post combustion emissions, the major model hypotheses have been reported to be valid by several authors (Merkel, Hughes...).

A schematic representation of the membrane module is given in figure 1.

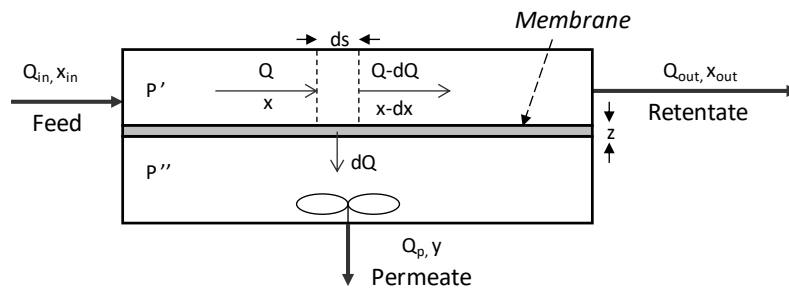

Figure 0: Schematic representation of a one stage gas permeation module for cross plug flow conditions

The cross-plug flow model assumes perfect plug flow on the upstream (feed) side of the membrane and free flow on the downstream (permeate) side. The model is based on the following assumptions:

- Steady state condition.
- Isothermal conditions.
- A constant permeability (nondependent of pressure).
- Negligible pressure drop on each side of the membrane.
- No flux coupling.
- Perfect gas law.

This set of hypotheses proved to be acceptable for post-combustion CO₂ capture [12, 14].

The mathematical model used for the one stage membrane module simulation, is based on the following equations:

- A mass balance over a differential surface area ds leads to the following differential equation:

$$Q^* \cdot \frac{dx}{ds} = - \left(x - \psi \cdot y_p + x \cdot \frac{dQ^*}{ds} \right) \quad (1)$$

where x is the upstream CO_2 mole fraction, s is the dimensionless membrane area. The real membrane area A can be calculated using this relation:

$$s = \frac{A \wp_{\text{CO}_2} P'}{z Q_{in}} \quad (2)$$

with \wp_{CO_2} is the CO_2 permeability).

Where Q^* is the ratio $Q^* = \frac{Q}{Q_{in}}$.

The flux relationships for each component can be written as follows:

$$-d(Qx) = \frac{\wp_{\text{CO}_2} P'}{z} (x - y_p \psi) ds \quad (3)$$

$$-d[Q(1-x)] = \frac{\wp_{\text{N}_2} P'}{z} [(1-x) - (1-y_p)\psi] ds \quad (4)$$

The combination of these two equations leads to the following expression:

$$\frac{dQ^*}{ds} = - \left(x - \psi \cdot y_p + \frac{1}{\alpha} (1-x - \psi \cdot (1-y_p)) \right) \quad (5)$$

The definition of the permeate composition and the mass transfer give leads to the following expression:

$$\frac{y_p}{1-y_p} = \alpha \cdot \left(\frac{x - \psi \cdot y_p}{1-x - \psi \cdot (1-y_p)} \right) \quad (6)$$

The performances of the separation can be simulated based on the numerical resolution of the set of equations 1, 5, and 6. The system is solved using the DASSL (differential/algebraic system solver) method [22]. Numerical details can be found in several articles [9,23].

2.2. Separation performances computation

In order to provide the driving force of the separation, different compression strategies can be proposed. In this study, two different configurations of a single stage membrane unit are considered for a given pressure ratio ψ across the membrane. Figure 2 shows schematic diagram of these configurations.

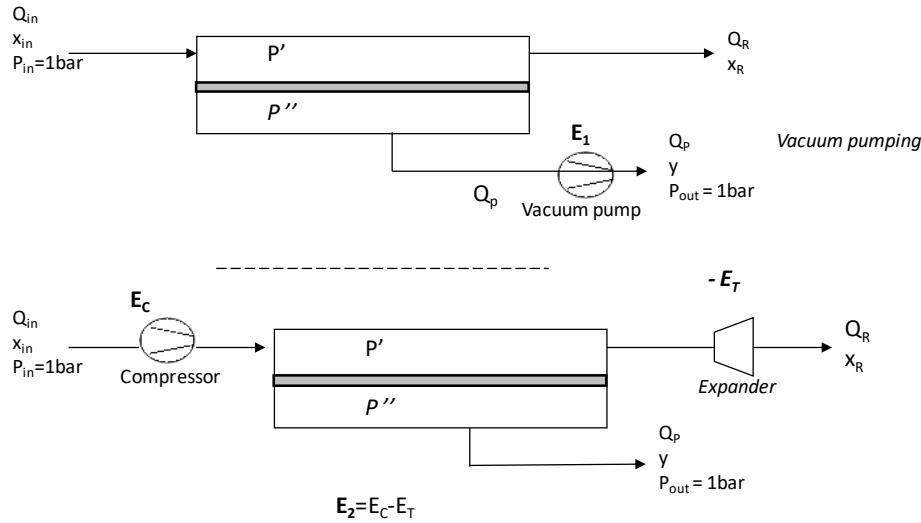

Figure 1: Schematic representation of the different compression strategies of a single stage membrane unit for post-combustion CO₂ capture.

In this study, the following simulation strategy, sketched on Figure 2, has been applied: inlet feed composition (x_{in}), membrane selectivity α , CO₂ purity (y) and capture ratio (R) have been fixed. The pressure ratio (ψ) and non dimensional surface area (s) which respect these constraints can then be identified by resolution. These two key data are the starting point of technico-economical studies. They can be used indeed in order to evaluate the energy requirement of the separation unit (from ψ) and the membrane surface area (from St). The first one is a major contribution of operating expenses (OPEX), while the second is, together with compression or vacuum equipment, the main part of capital expenses (CAPEX).

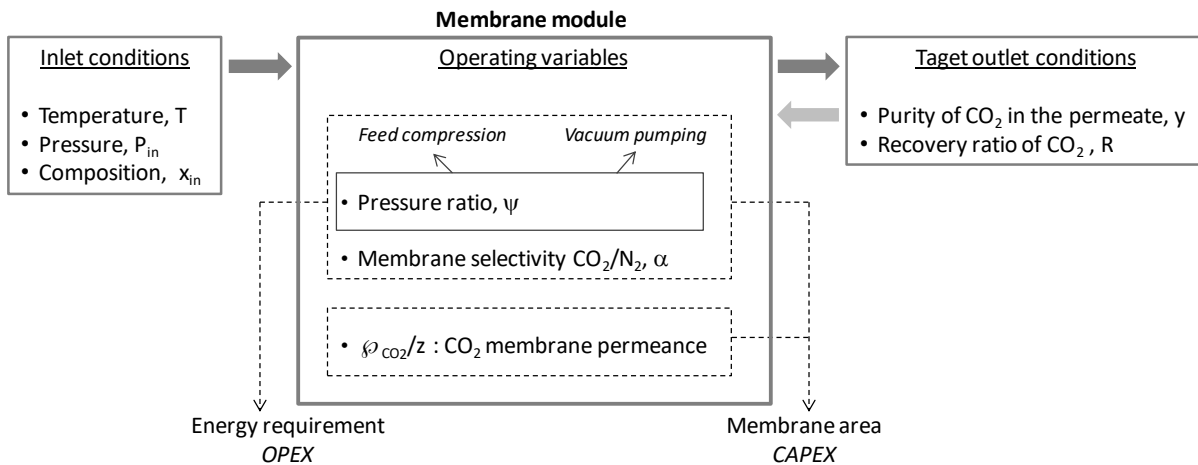

Figure 2: Schematic representation of the simulation framework used in this study for membrane separation

2.3. Simulation conditions

The specifications of the different variables used for the simulations performed in this study are summarised in Table 2. As indicated in the introduction, particular attention has been paid to the inlet CO₂ concentration and the set of data tested for this variable are reported in Table 2.

The influence of membrane selectivity has been explored through three different values which cover the range of existing ($\alpha = 50$) and more prospective membrane materials ($\alpha = 100$ and $\alpha = 200$).

A selectivity of 50 together with a permeance of 1000 GPU (Gas Permeation Unit) are typical of the best commercial membrane materials which have been obtained to date for CO₂ capture thanks to dense, non reactive membranes (Mekel,2010) such as Polaris TM developed by MTR. A selectivity of 100 was reported for chemically reactive membranes such as: polyvinyl amine (PVAm) and polyvinyl alcohol (PVA) blend membrane (xomeritakis, 2005, Huang 2008, Deng 2009).

A selectivity of 200 was reported for inorganic membrane based on molecular sieve separation mechanism such as NAY zeolite membrane (Krishna, 2010). It should be noted that more recently, a selectivity of 500 has been reported with a zeolite membrane by White et al. [].

The membranes of selectivity 100 (chemically reactive membranes) and 200 (inorganic membranes) are not based on the so called solution-diffusion mechanism. Thus, the celebrated membrane selectivity-permeability trade-off no more takes place. For those membranes, we chose to set the membrane permeance to a value of 1000 GPU, value that corresponds to the best high-selectivity membranes Polaris TM membrane (merkel, 2010).

More specifically, it should be stressed that no membrane materials with a selectivity larger than 50 is commercially available today. The objective of this study is to evaluate the potential interest for CO₂ capture of the various improved selectivity materials which have been already reported on laboratory scale but are not commercially available yet. As a consequence, the comparison with the currently available technology, namely absorption in a chemical solvent, could be considered as highly prospective.

Table 2: Membrane process specifications used for the simulation.

| <i>Parameter</i> | |
|--|--|
| Feed pressure | 1 Bar |
| Gas Inlet Temperature | 30 C |
| Thermodynamic model | Perfect gas |
| Membrane selectivity α | 50, 100,200 |
| Membrane permeance (GPU) | 1000 |
| Inlet CO ₂ content (vol %) and corresponding industrial situation | 5% Natural Gas Turbine flue gas [24] |
| | 15% Coal power plant [28] |
| | 30% Power plant with Oxygen Enriched Air combustion [9] Steel production [25] |
| | 50% Cement production [26] Biogas combustion [16] |
| | 70% Biogas combustion [16] Oxy-combustion [27] Fermentation [28] |

2.4. Energy and membrane area calculation

Coming back to Figure 2, different compression strategies can be proposed when a given pressure ratio ψ is computed by simulation. Each one will translate into a specific energy requirement (E, classically expressed in GJ, thermal basis, per ton of captured CO₂ in CCS studies) and a specific membrane surface area (S,

expressed in m² per kg CO₂.s). Table 3 details the expression which enables E and S to be calculated for each configuration. The 2.7 factor corresponds to the conversion of the electrical energy, obtained by the compression equation, to a thermal energy basis, taken as reference in energy requirement for CO₂ capture studies [18]. T is the inlet temperature (in K) and R is the gas perfect constant (R= 8.314 J/(mol.K)). γ is the adiabatic expansion factor of the gas mixture.

This situation logically addresses the question of the most appropriate strategy, when the energy requirement and aggregate membrane surface area are taken into account. The vacuum pumping option shows the lowest energy requirement [9], at the expense however of the largest surface requirement due to the low driving force which is generated. The lower energy requirement in this case results from the fact that the permeate flux only (Q_p) has to be pumped. At the contrary, a direct flue gas compression will minimize the membrane area together with a maximal energy requirement, the total feed flow rate (Q_{in}) being integrally compressed. In that context, the compression + Energy Recovery System (ERS), shown in Figure 1, intuitively appears to possibly offer an interesting trade-off: feed compression minimizes the membrane area while a large part of the compression energy can be recovered thanks to the ERS. It is obvious that the selection of the most efficient strategy requires a detailed technico-economical analysis, which is beyond the scope of this study; previous studies show indeed that different conclusions will be obtained depending on the specific cost of the membrane and of the ERS [27, 29, 30].

Table 3: Expressions used for calculation of the energy requirement (E) and the specific membrane surface area (A) for the different configurations shown on Figure 1.

| Compression strategy | Expression of the specific energy in GJ/ton of recovered CO ₂ (thermal basis) |
|--|---|
| Vacuum pumping | $E_1 = 2.7 \cdot 10^{-3} \frac{1}{\eta_v(\psi)} \frac{1}{y \cdot M(CO_2)} \frac{\gamma R T}{\gamma - 1} \left[\left(\frac{1}{\Psi} \right)^{\frac{\gamma-1}{\gamma}} - 1 \right] \quad (7)$ <p>η_v : Vacuum pump efficiency [24] : $\eta_v(\psi) = 0.1058 \times \ln(\psi) + 0.8746$</p> |
| Feed compression with energy recovery in the retentate | $E_2 = E_C - \eta_E * 2.7 * 10^{-3} \times \left(\frac{1}{\theta} - 1 \right) \times \frac{1}{y \cdot M(CO_2)} \frac{\gamma R T}{\gamma - 1} \left[\left(\frac{1}{\Psi} \right)^{\frac{\gamma-1}{\gamma}} - 1 \right] \quad (8)$ $E_C = 2.7 \cdot 10^{-3} \cdot \frac{1}{\eta_c} \cdot \frac{1}{y \cdot M(CO_2) \cdot \theta} \frac{\gamma R T}{\gamma - 1} \left[\left(\frac{1}{\Psi} \right)^{\frac{\gamma-1}{\gamma}} - 1 \right] \quad (9)$ <p>η_E : Expander efficiency =0.90 η_C : Compressor efficiency =0.90</p> |

| Compression strategy | Expression of surface membrane area in m ² /(Kg of recovered CO ₂ .s ⁻¹) |
|----------------------|---|
| Vacuum pumping | $A_1 = \frac{1}{y \cdot M(CO_2) \cdot 10^{-3}} V_M \frac{1}{permeance} \frac{1}{P' \theta} \quad (10)$ <p>P'=1bar</p> |
| Feed compression | $A_2 = \frac{1}{y \cdot M(CO_2) \cdot 10^{-3}} V_M \frac{1}{permeance} \frac{1}{P' \theta} \quad (11)$ <p>P' = P''/\psi, P''= 1 bar</p> |

3. Results and discussion

3.1. Role of pressure ratio and membrane stage cut

In order to evaluate the role of the key variables: pressure ratio and membrane stage cut, on the energy requirement of the process, figure 1 gives an illustrative example. This figure shows the energy requirement (case of feed compression strategy) and the membrane upstream pressure as a function of CO₂ recovery ratio for inlet CO₂ concentration of $x_{in}=0.3$ and permeate CO₂ purity of $y=0.9$. The results are given for a membrane selectivity of $\alpha=100$.

It can be seen that the energy requirement for high recovery ratios ($R>0.7$) corresponding to the desired region for post-combustion CO₂ capture strategy, together with the required membrane upstream pressure increase sharply with increasing CO₂ recovery ratio (and thus the stage cut). In this region, the energy requirement is controlled by the membrane pressure ratio. In the region corresponding to low recovery ratio, the energy requirement per ton of recovered CO₂ is controlled by the stage cut and logically decreases as the CO₂ recovery ratio increases.

Moreover, in order to evaluate the effect of membrane selectivity on the pressure ratio, figure 2 gives an illustrative example. In this figure, the membrane upstream pressure is shown as a function of inlet CO₂ concentration for a permeate CO₂ purity of $y=0.9$. The results are given for different membrane selectivity of $\alpha=50,100$ and 200 .

First, one can remark that logically the required upstream pressure decreases as the inlet CO₂ concentration increases. Moreover, it can be seen that generally the membrane pressure ratio needed to attain the CO₂ capture specifications is higher for less selective membranes. The effect of membrane selectivity decreases as inlet CO₂ concentration increases.

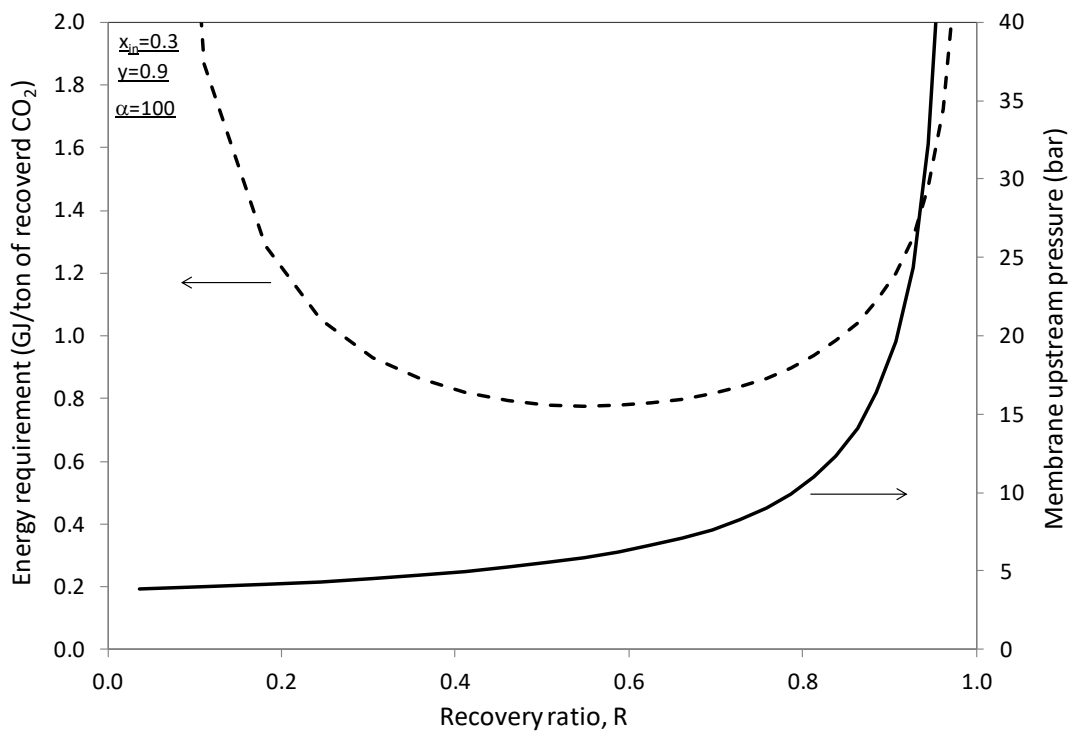

Figure 1.a : Energy requirement and membrane upstream pressure as a function of CO₂ recovery ratio for inlet CO₂ concentration of $x_{in}=0.3$ - CO₂ purity in the permeate of $y=0.9$. Results for a membrane selectivity of $\alpha=100$.

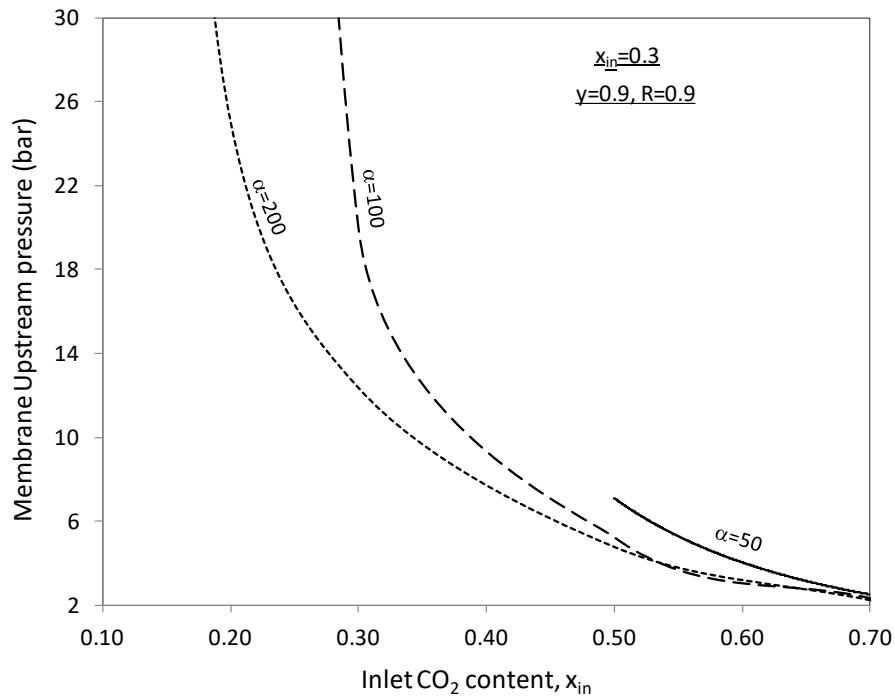

Figure 2: Membrane upstream pressure as a function of inlet CO₂ concentration - CO₂ purity in the permeate of $y=0.9$. Results for different membrane selectivity $\alpha=50,100$ and 200 .

3.2. Compression strategy selection

A sensitivity analysis has been explored in order to quantitatively evaluate the qualitative commentary outlined above. Figure 3 examines the aggregate membrane surface area (“Area”) and the energy needed for vacuum pumping and compression with an Energy Recovery System (ERS), such as turbo-expander (“Expander”). The results are presented for $x_{in}=0.3$, a membrane selectivity of 100, CO₂ permeance of 1000 GPU and CO₂ permeate purity of 0.9. In terms of energy requirement, one may note that the two strategies lead to values which are similar, the vacuum pumping energy requirement being slightly lower for lower values of the recovery ratio. Nevertheless, it can also be noticed from Figure 3 that the feed compression strategy leads to a significantly lower membrane surface area than that required for the vacuum pumping strategy.

Furthermore, Figure 3 illustrates the compromise existing between energy requirement and membrane surface. Indeed, when the recovery ratio increases, the energy requirement increases sharply while the specific membrane surface decreases. This suggests the existence of an optimal recovery ratio for each strategy with a minimum total cost that could be determined with a technico-economical analysis (which is out of the scope of this work, as indicated before).

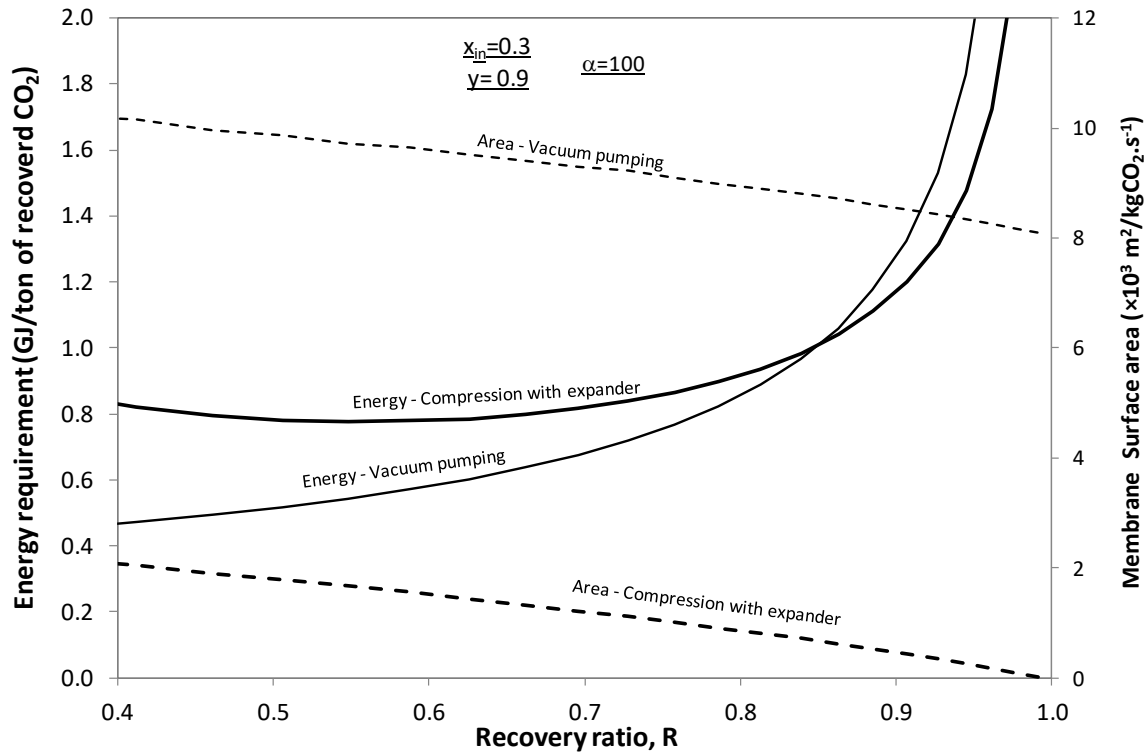

Figure 3: Energy and membrane area as a function of CO₂ recovery ratio. Results are presented for two compression strategies : (i) compression with turbo-expander (ii) vacuum pumping (or permeate vacuum). Results for $x_{in}=0.3$ and membrane selectivity of 100.

In summary, the parametric sensitivity study set forth below has been performed exclusively based on the “*Compression + ERS*” flow scheme. The energy requirement data being very similar to that of “*Vacuum Pumping*”, a discussion on the optimal use of membrane units in carbon capture flow sheets with respect to the energy requirement is provided below.

3.3. Influence of CO₂ inlet concentration

Given the strong parametric sensitivity of membrane processes, a set of simulations showing the interplay of CO₂ inlet concentration vs CO₂ purity has been performed as a first step. The objective is to achieve an overview of the possibilities and limitations of a membrane module with respect to different variables.

Figure 4 shows an example of simulation results for a single stage membrane module. The CO₂ recovery ratio is fixed to 0.9 ($R=0.9$). In this figure the process energy requirement is plotted as a function of the CO₂ permeate purity for different inlet CO₂ content. The energy requirement corresponding to the reference capture technology, namely gas-liquid absorption in MEA, has been added for sake of comparison. A 3.5 GJ per ton of recovered CO₂, thermal basis, is taken for that purpose [24]. The membrane selectivity is set at a value of 100. It can be observed that a permeate CO₂ purity of 90% could be attained in a one stage membrane with an acceptable energy requirement providing that a concentrated CO₂ flue gas stream ($x_{in}>0.3$) is to be treated. However, for more diluted CO₂ flue gas, a multi-stage membrane process is needed in order to attain the desired CO₂ purity.

More generally, one may note that the energy requirement decreases significantly for higher values of the inlet CO₂ mole fraction. Thus, there is a substantial benefit derived from strategically increasing the feed gas CO₂ concentration by any number of resourceful means, including flue gas recirculation for turbines, supplementary firing, and combustion in oxygen enhanced air (OEA) [18].

For a given CO₂ inlet content in the flue gas, one can also observe that the energy requirement increases sharply when high purity in the permeate is desired. This observation raises the question of whether the membrane stage could play an efficient role as a pre-concentration step (with moderate intermediate purity ($y = 0.3-0.5$) combined with a technology such as cryogenic separation that benefits from a higher inlet CO₂ concentration. For very concentrated CO₂ flue gas ($x_{in} = 0.5-0.7$) corresponding to biogas combustion or emission sources in mild oxy-combustion processes or sodium carbonate synthesis processes, the membrane process shows very low energy requirement. Consequently, a membrane unit could play in this case a polishing function in order to attain more than 90% CO₂ purity with a very low energy requirement (0.2-0.5 GJ/ton).

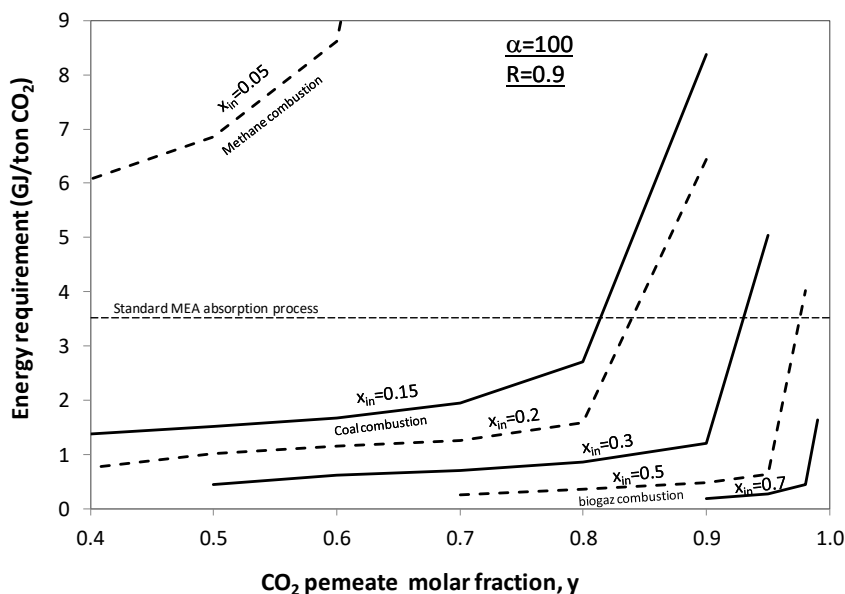

Figure 4: An example of simulation results for a single stage membrane module. Influence of CO₂ inlet fraction on the attainable CO₂ permeate purity (y). A membrane selectivity of 100 and a CO₂ recovery ratio of 0.9 (R) have been imposed for the calculations.

In these first results, the simulations are achieved for a fixed membrane selectivity of 100 and a fixed recovery ratio (R) of 0.9. In the following sections, we examine the effect of relaxing the CO₂ recovery ratio target and the impact of various membrane selectivity (α) on the energy capture requirement. An extensive array of cases in terms of CO₂ purity and recovery ratio will be investigated and their related energy requirements evaluated and compared to the reference technology (of MEA absorption). The objective of this systematic parametric analysis is to highlight the potentially valuable role of membrane processes for CO₂ capture.

3.4. Diluted CO₂ feeds: natural gas turbine ($x_{in} = 0.05$) and coal power plant ($x_{in} = 0.15$) flue gases

Figures 5 and 6 present the energy requirement as a function of CO₂ recovery ratio for inlet CO₂ concentration of $x_{in}=0.05$ and 0.15 typical of a natural gas turbine flue gas and coal combustion respectively. As expected, the energy requirement increases when increasing the desired CO₂ purity in the permeate. It can be seen also that this energy requirement significantly decreases with increasing the membrane selectivity, all parameters being equal (comparison between Figure 5.a and 5.b and 5.c). The curves also indirectly highlight the trade-off between the recovery ratio (R) and the permeate CO₂ concentration. In general, as R increases, the attainable CO₂ purity in the permeate (y) decreases.

Nevertheless, for $x_{in}=0.05$ (Figure 5), the energy requirement remains systematically above the value of 3.5 GJ/ton corresponding to the reference technology, MEA absorption, whatever the membrane selectivity. The conclusion of this first set of data is clear: a single membrane module can by no means offer attractive performances in terms of energy requirement for natural gas turbine flue gases: whatever the CO₂ purity level

or capture ratio or membrane selectivity, membrane process are too energy intensive. Alternative capture processes (absorption, adsorption, oxycombustion...), or hybrid approaches [18-19] should clearly be considered in that case.

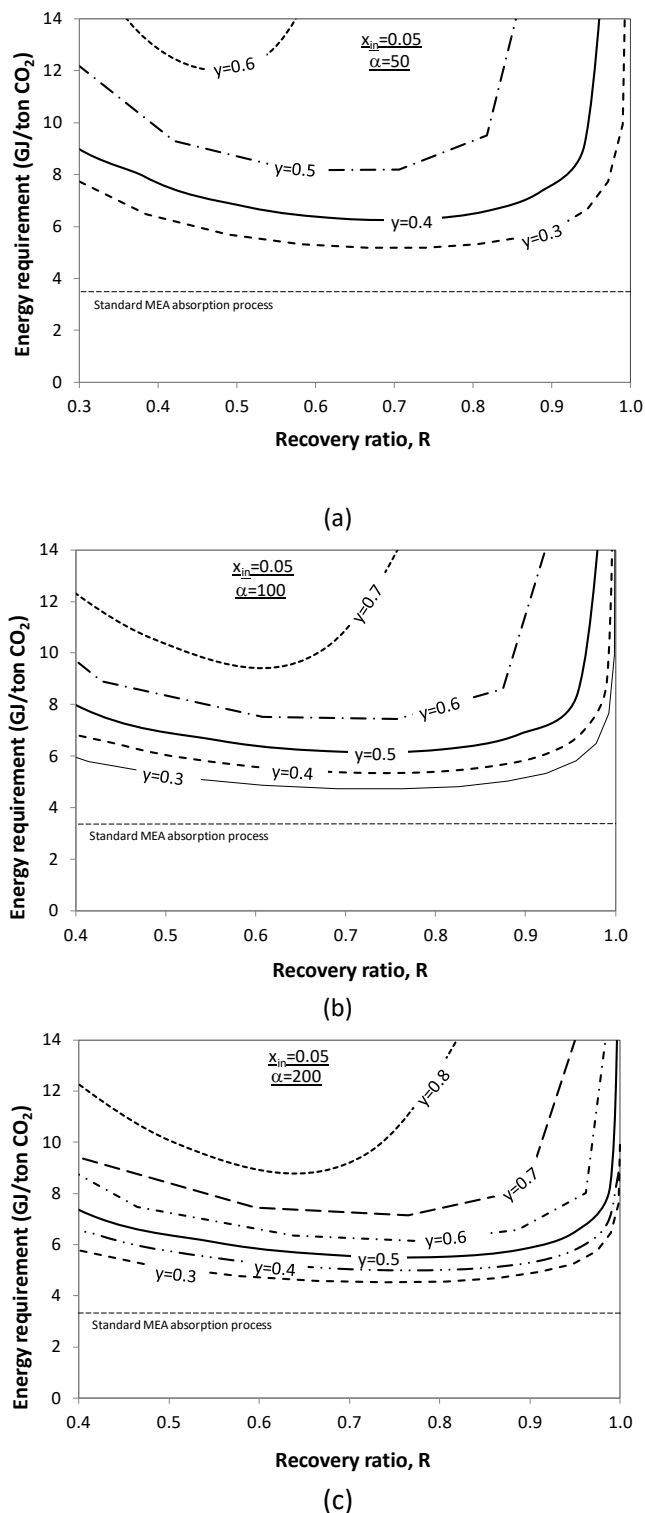
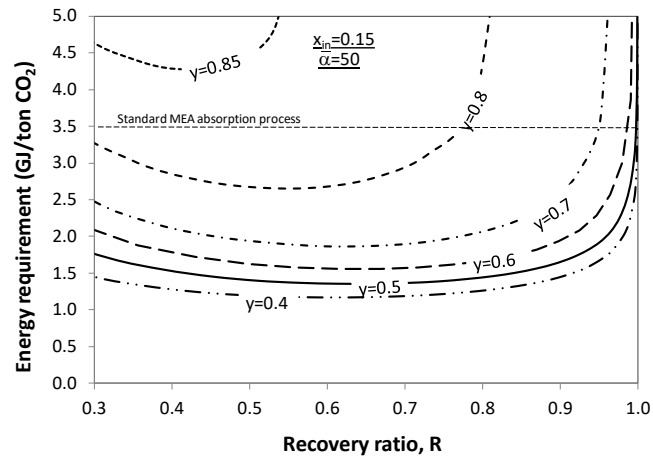
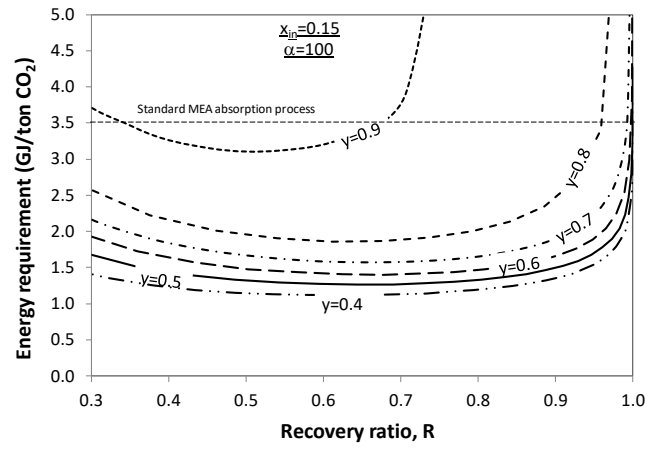

Figure 5: Energy requirement as a function of CO₂ recovery ratio for $x_{in}=0.05$. Results for different levels of CO₂ purity in the permeate. (a) $\alpha=50$ (b) $\alpha=100$ (c) $\alpha=200$

A different outcome is obtained for coal flue gases ($x_{in}=0.15$). In Figure 6 below, one may note that a very low energy requirement can be obtained for either (i) a moderate purity and/or (ii) a capture ratio below the 0.9 target. If both a 0.9 purity and 0.9 capture ratio are targeted, the energy required exceeds the energy requirement for MEA absorption. Nevertheless, for membrane selectivity of 200, a target of 90% CO₂ purity and recovery ratio are both attained with competitive energy cost of 3 GJ/ton.



(a)



(b)

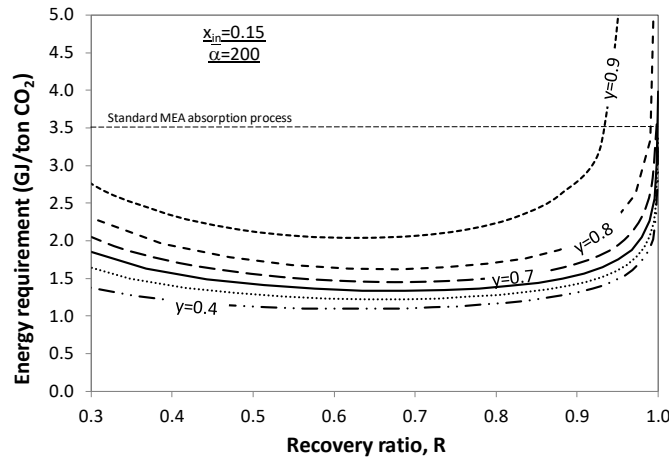

(c)

Figure 6: Energy requirement as a function of CO₂ recovery ratio for $x_{in}=0.15$. Results for different CO₂ purity in the permeate. (a) $\alpha=50$ (b) $\alpha=100$ (c) $\alpha=200$

Moreover, for moderate CO₂ purity ranging between 0.4 and 0.7, there is a potential benefit to considering a membrane process as a pre-concentration step in a hybrid process or multi-stage membrane process configuration. In this case, the membrane unit may require a low energy requirement (1 to 2 GJ/ton). Furthermore (and because the curves are relatively flat), for moderate y -values, we can get a high recovery ratio with almost the same energy requirement. These results suggest the exploration of combinations of a membrane pre-concentration unit, with a 0.9 capture ratio combined with a moderate purity (typically $y = 0.4$ - 0.7); if a low energy intensive purification process can be identified, attractive performance could result. More

generally, a similar analysis suggests the exploration of two-stage membrane processes, as proposed by different authors for coal power plant flue gases.

3.5. Concentrated CO₂ feeds: OEA combustion, steel, cement, biogas

Figure 7 presents the energy requirement as a function of CO₂ recovery ratio for inlet CO₂ concentration of $x_{in}=0.3, 0.5$ and 0.7 and for fixed CO₂ purity $y=0.9$. The results are shown for different membrane selectivities ($\alpha=50-100-200$).

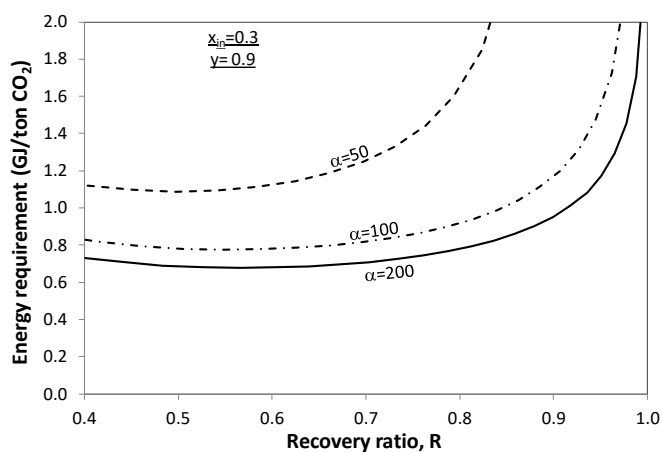

(a)

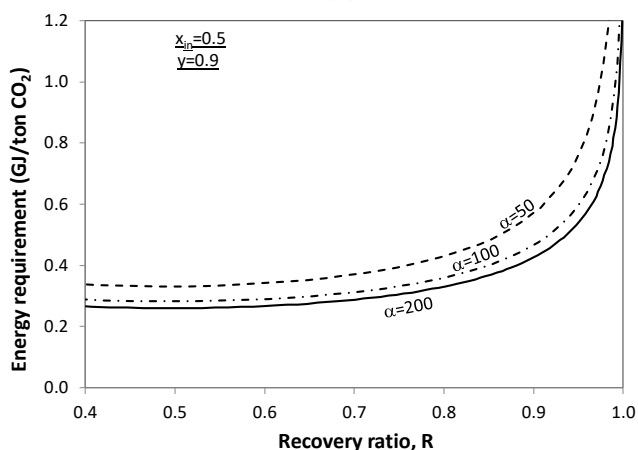

(b)

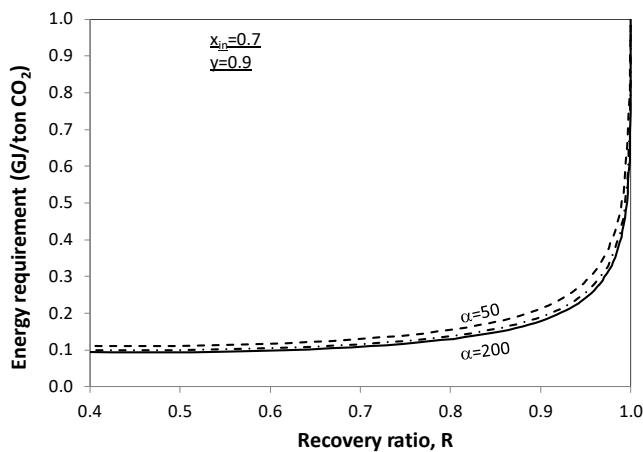

(c)

Figure 7 : Energy requirement as a function of CO₂ recovery ratio for $y=0.9$. Results for different membrane selectivities (respectively, 50x, 100x, and 200x) and inlet CO₂ concentrations (a) $x_{in}=0.3$ (b) $x_{in}=0.5$ (c) $x_{in}=0.7$

In this figure, it can be observed that the energy requirement is far below the energy requirement of the MEA absorption (3.5 GJ/ton) and more specifically below the European Union recommendation of 2GJ/ton [31].

As we have seen in the previous section, the energy requirement generally decreases with increasing membrane selectivity. Interestingly (and as shown in Figure 7 above), this effect decreases with higher CO₂ inlet concentrations.

For $x_{in}=0.3$ with $R=0.9$, an energy requirement below 2 GJ/ton is not obtained for membrane selectivity of 50. With higher membrane selectivities of 100 and 200, the energy requirement decreases to 1.2 GJ/ton and 0.9 GJ/ton respectively. This shows the benefit of higher membrane selectivity in reducing the capture cost. For $x_{in}=0.5$, the energy cost is of only 0.3-0.5GJ/ton for CO₂ recovery ratio of 0.9. For $x_{in}=0.7$, the energy requirement is very low. These results show the feasibility of using a single stage membrane process for treating concentrated flue gases; alternatively, a membrane unit can also be beneficial in order to play a “polishing” function in a hybrid configuration, which makes use of a first stage capture process producing a CO₂ feed in the 0.5-0.7 range.

Table 4 summarizes the results of a standalone membrane process for the different inlet CO₂ contents ($x_{in}=0.15-0.7$), and for 3 the different membrane selectivities. These data illustrate the critical role of the inlet CO₂ content on the energy requirement, and the decreasing benefit from highly selective materials when more concentrated feed streams can be treated.

Table 4: Standalone membrane process: Energy requirement with the target: $y=0.9$ and $R=0.9$. Results for various CO₂ inlet content for the 3 different membrane selectivities.

| CO ₂ inlet content, x_{in} | Energy requirement, GJ/ton CO ₂ | | |
|---|--|------|------|
| | α_{CO_2/N_2} | | |
| | 50 | 100 | 200 |
| 0.15 | - | - | 2.90 |
| 0.20 | - | 4.70 | 1.60 |
| 0.30 | 5.20 | 1.20 | 0.95 |
| 0.50 | 0.59 | 0.48 | 0.43 |
| 0.70 | 0.23 | 0.19 | 0.18 |

As a conclusion, an illustrative diagram of the major results of this parametric study is provided as Figure 8. The role of membrane processes in post-combustion strategy, depending on the emission sources (i.e flue gas CO₂ content) is represented. The curves corresponding to MEA absorption and cryogenic process are also reported for sake of comparison. The dominant role of hybrid processes making use of a membrane unit either for a pre-concentration or “polishing” role is clear. It has to be noticed however that design studies on hybrid processes based on a membrane unit for carbon capture are scarce. Consequently, this study suggests a more systematic exploration of these types of configurations would be constructive. More generally, the conclusions of this study corroborate a classical statement in separation science: hybrid processes are indeed often recommended when both a high purity and high recovery are needed [32-33].

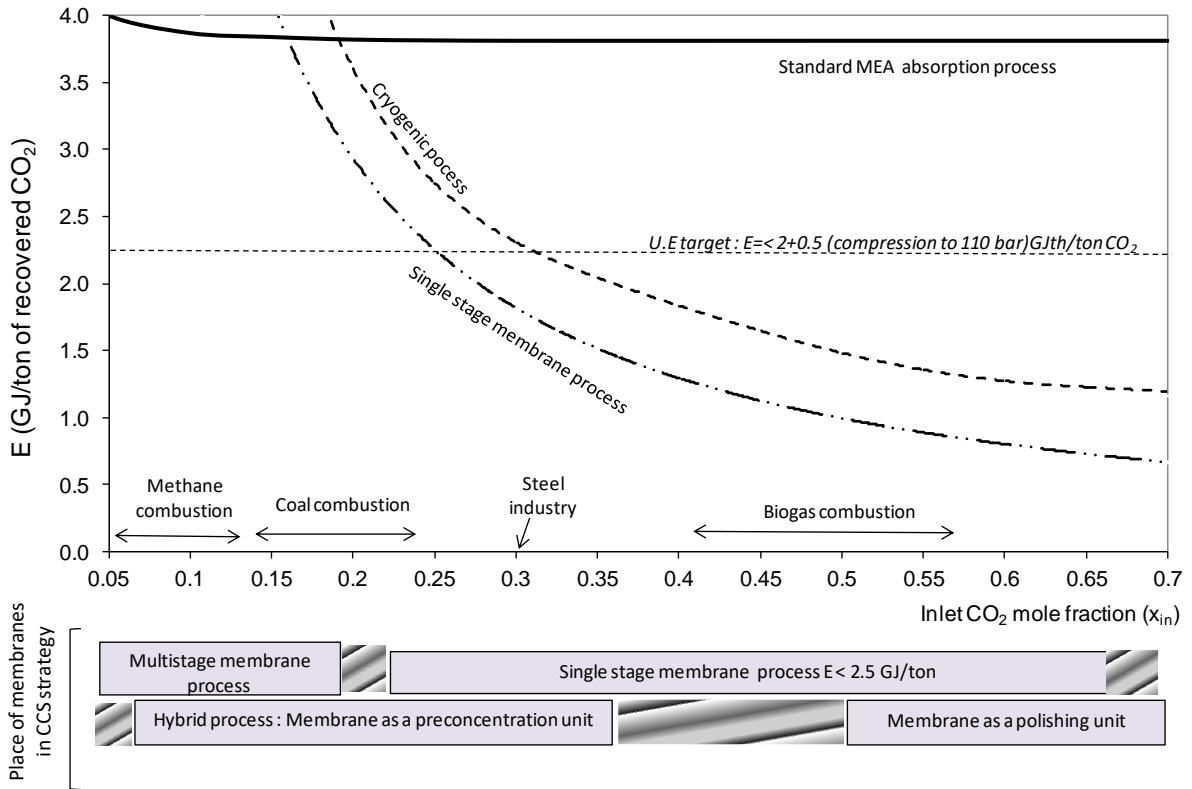

Figure 8: Schematic representation of the different carbon capture technologies in post-combustion as a function of the inlet CO_2 mole fraction. A selectivity of 100 has been taken for the single stage membrane unit computations.

4. Conclusions

The objective of this parametric study was to systematically explore the most effective place and role of a membrane unit in a post-combustion carbon capture framework. The *Feed Compression with ERS* strategy appears to realize lower energy costs, and has been preferred in our analysis; this configuration clearly leads to much lower membrane surface area, while the energy requirement remains almost the same as for the *Permeate Vacuum* case.

The major conclusions can be summarized as follows:

- In most cases, a less stringent recovery ratio of $R=0.8$ instead of 0.9 can significantly decrease the energy requirement of the process.
- For diluted CO_2 flue gases ($x_{\text{in}} < 0.1$), a membrane process cannot fulfill both the CO_2 purity and recovery ratio ($R=0.9$ and $y=0.9$) targets, even if the membrane selectivity is 200. In this case, multi-stage membrane processes are needed to achieve the capture target. Usually, two membranes stages are considered [Merkel, Zaho, Sluis, Minh]. For these types of cascades, different compression strategies (feed compression or/and vacuum pumping), numerous configurations, membrane performances and costs together with different economic assumptions can be considered. Globally speaking, multistaged systems may offer attractive improvements in terms of energy requirement, at the expense of an increased membrane area. For instance, Zaho et al. concluded at a slight energetic advantage in comparison with MEA absorption. Consequently, the effective evaluation of the performances of these types of systems requires detailed technico-economical analyses.
- For CO_2 inlet flue gas in the range of 0.15 , a membrane with very high selectivity ($\alpha > 100$) is required to reach the target of CO_2 purity and recovery ratio, but the process is very energy intensive and not competitive with MEA absorption process. However, with moderate CO_2 purity in the permeate, the energy requirement decreases significantly, suggesting that membrane process could play the beneficial role of a pre-concentration process (as a technology that benefits from a higher inlet CO_2 concentration).
- For more concentrated CO_2 inlet flue gas ($x_{\text{in}} > 0.2$), a standalone membrane process can fulfill the target of CO_2 purity and recovery ratio with a lower energy requirement than a standard MEA absorption process.
- For concentrated CO_2 feed streams ($x_{\text{in}} > 0.5$), the specific energy requirement to fulfill the target of CO_2 purity and recovery ratio ($R=0.9$ and $y=0.9$) is very low. Thus, membranes also offer attractive performance as a standalone process when the flue gases contains 50% or more CO_2 . Therefore, the performance of hybrid configurations that make use of a capture process which achieves a moderate CO_2 purity ($y \sim 0.5$) with a low energy requirement can benefit from a “polishing” step with a membrane unit. This strategy, which is almost unexplored up to now, should be more systematically investigated.

Finally, it is important to emphasize that the analysis set forth in this paper has focused on the energy requirement target, which is the most important objective in CCS studies. For the different situations corresponding to a superior energy requirement which have been identified in this paper, a more detailed evaluation has now to be performed. Technico-economic analyses are needed at this stage in order to determine the optimum operating parameters and configuration which will achieve the lowest cost, taking into account both the CAPEX and OPEX of the process.

Acknowledgements Financial support of the Institut Carnot Energie Environnement de Lorraine (ICEEL) is gratefully acknowledged.

References

- [1] H.B. Park, S.H. Han, C.H. Jung, Y.M. Lee, A. J. Hill, Thermally rearranged (TR) polymer membranes for CO₂ separation, *Journal of Membrane Science*, 359, 1–2 (2010) 11-24.
- [2] X. Ren, J. Ren, H. Li, S. Feng, M. Deng, Poly (amide-6-b-ethylene oxide) multilayer composite membrane for carbon dioxide separation, *International Journal of Greenhouse Gas Control*, 8 (2012) 111-120,
- [3] S.J. Metz, M.H.V. Mulder, M. Wessling, Gas permeation properties of poly(ethylene oxide) poly(butylenes terephthalate) block copolymers, *Macromolecules*, 37 (2004) 4590-4597.
- [4] G. Xomeritakis,, C.Y. Tsai, C.J. Brinker, Microporous sol-gel derived aluminosilicate membrane for enhanced carbon dioxide separation, *Separation and Purification Technology*, 42 (2005) 249-257.
- [5] J. Huang, J. Zou and W.S.W. Ho, Carbon dioxide capture using a CO₂-selective facilitated transport membrane, *Industrial Engineering Chemistry Research*, 47 (2008) 1261–1267.
- [6] W. Yave, A. Car, K.V. Peinemann, Nanostructured membrane material designed for carbon dioxide separation, *Journal of Membrane Science*, 350 (2010) 124-129.
- [7] L. Deng, T.-J. Kim and M.-B. Hagg, Facilitated transport of CO₂ in novel PVAm/PVA blend membrane, *Journal of Membrane Science*, 340 (2009) 154-163.
- [8] R. Krishna, J.M van Baten, In silico screening of zeolite membranes for CO₂ capture, *Journal of Membrane Science*, 360 (2010) 323-333.
- [9] N Bounaceur, N. Lape, D. Roizard, C. Vallières, E. Favre, Membrane processes for post-combustion carbon dioxide capture: a parametric study, *Energy*, 31 (2006) 2556-2570.
- [10] X. He, M.B Hägg, Hollow fiber carbon membranes: Investigations for CO₂ capture, *Journal of Membrane Science*, 378, 1–2 (2011) 1-9.
- [11] L. Zhao, E. Riensche, R. Menzer, L. Blum, D. Stolten, A parametric study of CO₂/N₂ gas separation membrane processes for post-combustion capture, *Journal of Membrane Science*, 325 (2008) 284–294.
- [12] T. Merkel, H. Lin, X. Wei, R. Baker, Power plant post-combustion carbon dioxide capture: An opportunity for membranes, *Journal of Membrane Science*, 359, 1–2 (2010) 126-139.
- [13] E. Favre, carbon dioxide recovery from post combustion processes: Can gas permeation membranes compete with absorption? *Journal of Membrane Science* 294 (2007) 50-59.
- [14] L. Zhao, R. Menzer, E. Riensche, L. Blum, D. Stolten, Multi-stage gas separation membrane processes with post-combustion capture: energetic and economic analyses, *Journal of Membrane Science*, 359 (2010) 160–172.
- [15] A. Hussain, M.B Hägg, A feasibility study of CO₂ capture from flue gas by a facilitated transport membrane, *Journal of Membrane Science*, 359, 1–2 (2010) 140-148.
- [16] E. Favre, R. Bounaceur, D. Roizard, Biogas, membranes and carbon dioxide capture, *Journal of Membrane Science*, 328 (2009) 11-14.
- [17] E. Favre, R. Bounaceur, D. Roizard, A hybrid process combining oxygen enriched air combustion and membrane separation for postcombustion carbon dioxide capture, *Separation and Purification Technology* 68 (2009) 30-36.
- [18] B. Belaissaoui, G. Cabot, M.S Cabot, D. Willson, E. Favre, An energetic analysis of CO₂ capture on a gas turbine combining flue gas recirculation and membrane separation, *Energy*, 38 (2012) 167-175.
- [19] B. Belaissaoui, Y. Le Moullec, D. Willson, E. Favre, Hybrid Membrane Cryogenic Process for Post-Combustion CO₂ Capture, *Journal of Membrane Science* (2012) available on line.
- [20] J. Kotowicz, Ł. Bartela, Optimisation of the connection of membrane CCS installation with a supercritical coal-fired power plant, *Energy*, 38, Issue 1 (2012) 118-127.
- [21] A. Lynghjem, J. Jakobsen, H. Kobro, A. Lund, M. Gjerset, The Combicap cycle-efficient combined cycle power plant with CO₂ capture, 2nd Trondheim Conference on CO₂ Capture, Trondheim, Norway, October 24-25 2004.
- [22] J.K. Jeon, S.K. Ihm, Y.K. Park, J.S. Kim, J.I. Dong, S. Kim, J.M. Kim, S.. Kim, K.S. Yoo, Membrane / PSA hybrid process for carbon dioxide recovery at low concentration, *Studies in Surface Science and Catalysis*, 153 (2004) 543-546.

- [23] L.R. Petzold, A description of DASSL: A differential/algebraic system solver, in Scientific Computing, eds. R.S. Stepleman et al., North- Holland, Amsterdam, 1983.
- [24] R. Steeneveldt, B. Berger, T.A. Torp, CO₂ capture and storage: closing the knowing doing gap. Chemical Engineering Research & Development, 84-A9 (2006) 739-763.
- [25] J.A. Lie, T. Vassbotn, M.B. Hagg, D. Grainger, T.J. Kim, T. Mejdell, Optimization of a membrane process for CO₂ capture in the steelmaking industry, International Journal of Greenhouse Gas Control, 1 (2007) 309-317.
- [26] Sheinbaum, C., Ozawa, L., Energy use and CO₂ emissions for cement industry, Energy, 23 (1998) 725-732.
- [27] C. Hendriks, E. Visser, D. Jansen, M. Carbo, G. J. Ruijg, J. Davison, Capture of CO₂ from medium-scale emission sources, Energy Procedia, 1, Issue 1 (2009) 1497-1504.
- [28] O. Davidson, B., Metz, Special Report on Carbon Dioxide Capture and Storage, International Panel on Climate Change, Geneva, Switzerland, 2005 (www. ipcc.ch).
- [29] M. T. Ho, G. Allinson, D. E. Wiley, Comparison of CO₂ separation options for geo-sequestration: are membranes competitive? Desalination, 192, 1-3 (2006) 288-295.
- [30] T. C. Merkel, M. Zhou, R.W. Baker, Carbon dioxide capture with membranes at an IGCC power plant, Journal of Membrane Science, 389 (2012) 441-450.
- [31] P. Descchamps, P.A. Pilavachi, Research and development actions to reduce CO₂ emissions within the European Union, Oil Gas Science & Technology 59(3) (2004) 323-30.
- [32] R. Agrawal, S.R. Auvil, J.S. Choe, D.W. Woodward, Membrane/cryogenic hybrid scheme for argon production from air, Gas Separation & Purification, 4, 2 (1990) 75-80.
- [33] R. Agrawal, S.R. Auvil, S.P. DiMartino, J.S. Choe, J.A. Hopkins, Membrane/cryogenic hybrid processes for hydrogen purification, Gas Separation & Purification, 2 (1988) 9-15.
- [34] N. Matsumiya, M. Teramoto, S. Kitada, H.Matsuyama, Evaluation of energy consumption for separation of CO₂ in flue gas by hollow fiber facilitated transport membrane module with permeation of amine solution, Separation and Purification Technology, 46 (2005) 26-32.