



HAL
open science

A simple and low-cost integrative sensor system for methane and hydrogen measurement

Damien Ali Hamada Fakra, Dolly Armel Sylvain Andriatoavina, Ny Aina Manitra Nany Razafindralambo, Kamil Abdallah Amarillis, José Marie Michel Andriamampianina

► To cite this version:

Damien Ali Hamada Fakra, Dolly Armel Sylvain Andriatoavina, Ny Aina Manitra Nany Razafindralambo, Kamil Abdallah Amarillis, José Marie Michel Andriamampianina. A simple and low-cost integrative sensor system for methane and hydrogen measurement. *Sensors International*, 2020, 1, pp.100032. 10.1016/j.sintl.2020.100032 . hal-02938019

HAL Id: hal-02938019

<https://hal.science/hal-02938019>

Submitted on 11 Mar 2021

HAL is a multi-disciplinary open access archive for the deposit and dissemination of scientific research documents, whether they are published or not. The documents may come from teaching and research institutions in France or abroad, or from public or private research centers.

L'archive ouverte pluridisciplinaire **HAL**, est destinée au dépôt et à la diffusion de documents scientifiques de niveau recherche, publiés ou non, émanant des établissements d'enseignement et de recherche français ou étrangers, des laboratoires publics ou privés.



A simple and low-cost integrative sensor system for methane and hydrogen measurement



Damien Ali Hamada Fakra^{a,*}, Dolly Armel Sylvain Andriatoavina^{b,c},
Ny Aina Manitra Nany Razafindralambo^c, Kamil abdallah Amarillis^{a,d},
José Marie Michel Andriamampianina^{b,c}

^a Physics and Mathematical Engineering Laboratory for Energy and Environment (PIMENT), University of La Réunion, 117 General Ailleret Street, 97430, Le Tampon, La Réunion, France

^b Laboratory of Atmospheric, Climate and Ocean Dynamics (DyACO) University of Antananarivo, BP 566, Antananarivo 101, Madagascar

^c Higher Institute of Technology of Antananarivo (I.S.T.-T), Ministry of Higher Education and Scientific Research, Iadiambola Ampasampito, Po Box 8122, Antananarivo 101, Madagascar

^d Laboratory of Food, Reactivity and Synthesis of Natural Substances (LAR2SN) - Faculty of Science and Technology - University of Comoros, Corniche Street, Moroni, Comoros

ARTICLE INFO

Keywords:

Gas analyzer
Low-cost
Hydrogen
Methane
MQ-4 and MQ-8 sensors

ABSTRACT

Energy production by methanization or gasification of biomass is dependant on the chemical composition of the gas generated. The resistive sensors based on semiconductor metal oxides, like the MQ series sensors, are inexpensive and frequently used in gas detection. These sensors, initially dedicated to detecting gas leaks in safety systems, have relatively small measurement ranges (i.e. limited to concentrations below 10,000 ppm). It is therefore necessary to find solutions to adapt these categories of sensors for gas measurements in the energy sector where the gas concentration is much more significant. In this article, we propose a protocol using an adaptable capsule for MQ-4 and MQ-8 sensors to measure high concentrations of CH₄ and H₂ respectively. The technique consists of diluting the gas to be studied in a known volume of air. Three methods are proposed and compared regarding the linearity and the repeatability of the measurements. The first method was done in an airtight enclosed chamber, the second method consists of directly injecting the gas on the sensor placed in an open environment, and the final method was accomplished by direct injection of the gas on the sensor placed in a partially closed capsule. Comparisons show that the first technique provides the best repeatability, with a maximum standard deviation of 13.88% for CH₄ measurement and 5.1% for H₂. However, its linearity is weak (i.e. $R^2 = 0.8637$ for CH₄ and $R^2 = 0.5756$ for H₂). The second technique has better linearity but bad repeatability. The third technique presents the best results with R^2 values of 0.9973 for the CH₄ measurement and 0.9472 for H₂. The use of the partially closed capsule resulted in an acceptable linear response of the sensors by up to 20% concentration of CH₄ and until 13.33% concentration of H₂ in the studied gas. The use of this simple and low-cost technique facilitates the characterization of combustible gases in isolated areas. It allows local operators of biomass valorization systems to control and improve their installations while avoiding the high costs of conventional measurement devices. This study, hence, contributes to the development of rural electrification projects in remote areas.

* Corresponding author. .

E-mail address: fakra@univ-reunion.fr (D.A.H. Fakra).



Production and hosting by Elsevier

<https://doi.org/10.1016/j.sintl.2020.100032>

Received 16 June 2020; Received in revised form 12 August 2020; Accepted 13 August 2020

Available online 11 September 2020

2666-3511/© 2020 The Authors. Production and hosting by Elsevier B.V. on behalf of KeAi Communications Co., Ltd. This is an open access article under the CC BY-

NC-ND license (<http://creativecommons.org/licenses/by-nc-nd/4.0/>).

1. Introduction

In engineering, the control of any process requires the measurement of the physical phenomena involved in the transformation of inputs to outputs. In the scientific field, the understanding of all physical phenomena requires its measurement to carry out any study or analysis. The measurement of a physical quantity uses a sensor that can generate an output signal, often electronic, in response to the stimulation of the measurand [1] and [2]. Sensors, therefore, are used in all fields of science and engineering [1] as in biomedical [3–9], pharmaceutical [10], environmental [6–9,11–14], industrial [2,9,11], robotics [9], automotive [8, 9,11,15], transport and logistics [8], aerospace [9,15], communication [7], food [9] and even cosmetics and fragrances [9].

This article studies the application of sensors for gas measurement in the biomass energy sector. The purpose of the measurement is to evaluate the heating value of gas from the concentration of its combustible elements. Measuring devices such as chromatographs are available on the market to perform gas analysis [16]. However, because of their high price and the transport difficulties related to their bulkiness, these devices are often unsuitable for use in remote rural areas [17]. For this reason, this article presents the design and validation of a simple, low-cost, and easily transportable gas analyzer that can be used in remote rural areas.

Gas measurement can be performed by different methods such as optical, acoustic, calorimetric, or chromatographic methods, but the most commonly used is the electrical method, i.e., through the variation of the electrical property of a material in the presence of a targeted gas [18]. The sensitive material used may be semiconductor metal oxides, polymers, carbon nanotubes, or a moisture-absorbing material [18]. Considering their low manufacturing cost, linked to their ease of large-scale production, and their good measurement performance (sensitivity, robustness, quick response time), semiconductor metal oxide sensors largely dominate the gas sensor market [13,18].

Semiconductor materials can be classified into two groups: oxides and non-oxides (e.g., silicone). Non-oxide semiconductors are covered with a protective insulating layer, thus, they cannot act as sensors but are only used as transducers. On the other hand, oxide semiconductors can be used both as sensors and transducers due to their chemical and physical stability at high temperatures. There are five categories of semiconductor sensors depending on the type of transducer used: resistors, diodes, MIS (metal-insulator-semiconductor capacitor), MIS FET (metal-insulator-semiconductor field-effect transistor) and oxygen concentrator cells. Owing to a greater technological maturity compared to other types, resistive sensors are the most widely used [19].

Resistive sensors based on metal oxide semiconductors detect the presence of gas through oxidation-reduction reactions between the target gas and the sensitive layer [18]. If the semiconductor used is of the n-type (i.e., the majority charge carriers are electrons), the presence of a reducing gas decreases its electrical resistance and the presence of an oxidizing gas increases it. If the semiconductor is p-type (i.e., the majority charge carriers are holes), its electrical resistance changes in the opposite direction [13]. The n-type and p-type semiconductors also differ in the influence of temperature on their sensitivity: as the temperature increases, the sensitivity of the n-type increases while that of the p-type decreases. Therefore, the operating temperature of the p-type is lower than that of the n-type [18].

The n-type metal oxides can be made from SnO_2 , In_2O_3 , WO_3 , ZnO , or $\gamma\text{-Fe}_2\text{O}_3$ and the p-type ones from CuO or CO_3O_4 [19]. Other materials can also be mixed with oxides such as PdO , Pt , or Fe_2O_3 to improve sensitivity, alumina as a skeleton material, or silica as a binder. The most commonly used material for manufacturing gas sensors is tin dioxide (SnO_2) due to its high sensitivity to various reducing gases such as liquefied petroleum gas (LPG), methane, or carbon monoxide. This sensitivity requires a certain working temperature, varying between 25 and 500 °C, which is obtained using a heating filament [18].

A large part of the application of gas sensors concerns fire safety systems that detect the presence of gas leaks and trigger an alarm or

automatically send a message from a certain preset threshold [20–26]. Gas sensors can also be integrated into air quality monitoring systems such as those in the work of Amin et al. [27], Heyasa et al. [28], or Zoest et al. [29]. A significant part of the use of gas sensors also includes the design of electronic noses dedicated to the recognition of a particular odor, related to a biological process, such as the degree of maturity or spoilage of food products [30–33]. Other studies have also been conducted on the performance of gas sensors concerning temperature or humidity variation [34,35]. Even if most of the research found in the scientific literature concerns gas sensors based on metal oxides [36–39], some articles explore other means of detection such as the use of amperometric sensors [40], fuel cell [41], carbon nanotube [42], Raman Lidar measurement technology [43], ultrasound [44] or conductive ink based on nail polish and graphite powder [45].

But the use of low-cost gas sensors in the biomass energy sector is relatively recent and still not much treated. Two examples of the use of low-cost sensors to measure the methane content of biogas are given in the works of Ahmed et al. [46] and Yang et al. [17]. Ahmed et al. [46] used an MQ-2 sensor to measure biogas production from a wastewater treatment biodigester. Yang et al. [17] designed an MQ-4-based device to measure the methane content of biogas produced by the anaerobic digestion of distillation residues from a cellulosic ethanol plant. Ahmed et al. [46] and Yang et al. [17] have used the MQ sensors to monitor anaerobic digestion, which is a wet biomass energy recovery process [47]. For dry biomass (maximum moisture content of 20% for updraft reactors and 50% for downdraft reactors), the appropriate process is gasification [48]. Gasification consists of transforming carbon-rich biomass into a fuel gas through its partial oxidation [49,50]. Unlike the biogas analyzed in the work of Ahmed et al. [46] and Yang et al. [17], the gas resulting from gasification, called syngas, contains several combustible gases (H_2 , CH_4 , CO) [51]. This paper, therefore, proposes a simple technique for measuring CH_4 and H_2 that can be used to monitor gasification systems.

The devices presented in this article are based on the MQ-4 and MQ-8 sensors for measuring CH_4 and H_2 respectively. The MQ sensors are resistive semiconductors based on metal oxides made of tin oxide (SnO_2). The choice of these sensors is justified by their low price and ease of use. Indeed, the MQ sensors can be powered by a simple Arduino UNO board which will also ensure the transmission of the electrical signal emitted by the sensors to a computer.

However, one challenge in adapting MQ sensors for gas concentration measurement is the need to improve their measurement range. As MQ sensors were originally designed for gas leakage detection, their measuring ranges are between 200 and 10,000 ppm (0.02–1%). However, the gas to be analyzed in the energy sector can contain elements with much higher concentrations. The novelty proposed in this article is therefore to find a simple solution to enable the MQ-4 and MQ-8 sensors to measure concentrations higher than 1%.

Three techniques for the measurement of CH_4 and H_2 are proposed: gas measurement by injection into an airtight enclosed chamber, gas measurement by direct injection in an open environment, and gas measurement by direct injection into a partially closed capsule. These three techniques are compared according to two criteria: the linearity between the gas concentration and the sensor response, allowing the linear dynamic range value to be established; and the repeatability of the measurement. The standard gas used to test the measurement of methane is composed of 20% CH_4 , 10% CO_2 , and 70% He, while the standard gas used to test the measurement of hydrogen is composed of 99.99% H_2 .

2. MQ-4 and MQ-8 sensor operating principles

MQ sensors are gas sensors that are classified as resistive sensors. Their detection system is based on the variation in the electrical resistance of a sensitive layer according to the presence of the gas of interest. The electrical equivalent scheme for MQ sensors is shown in Fig. 1 where V_C represents the supply voltage. The sensitive part of the MQ series

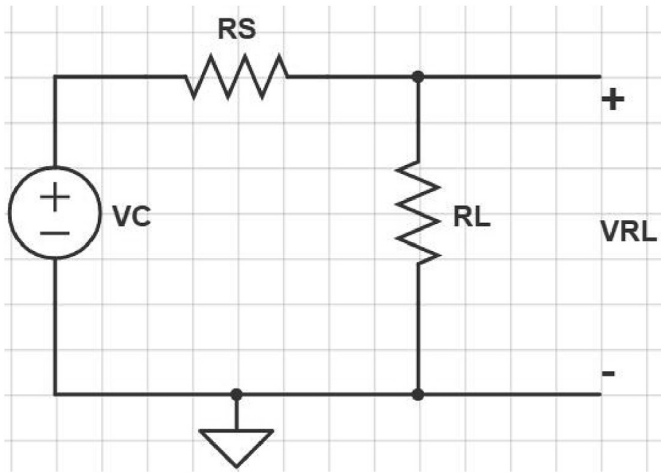

Fig. 1. Equivalent circuit scheme for MQ sensors [53], [54].

sensors consists of an Al_2O_3 ceramic tube covered with a layer of SnO_2 . In the presence of air, oxygen molecules are adsorbed onto the surface of the semiconductor, thereby increasing the resistance of the component. In the presence of reducing gas, an oxidation reaction takes place between the gas and the oxygen. The resistance of the sensor is thus decreased [52]. The adsorption by the sensitive layer of the sensor is facilitated by heat, so a heating resistor is inserted inside the ceramic tube to bring it into the right operating conditions.

To measure several types of gases, the sensitivity of each type of MQ sensor is varied by doping the sensitive layer with other elements and at different concentrations. Although both the MQ-4 and the MQ-8 react to hydrogen and methane, their sensitivities are different as can be observed from the calibration graphs supplied by the manufacturer (Fig. 2). In addition to the sensitive resistor (R_S), MQ sensors contain a load resistor (R_L) that can be varied to change the sensitivity.

The sensing layer resistor (R_S) change is calculated from the measured output voltage (V_{RL}) according to eq. (1).

$$R_S = \left[\frac{(V_C \times V_L)}{V_{RL}} \right] - R_L \quad (1)$$

The V_{RL} output voltage is deduced from the value of the analog signal (A) sent by the sensor to the Arduino board. For Arduino UNO, the maximum value of this analog signal is 1024 (the resolution of each analogical pin is 10 bits; i.e., the output signal varies from 0 to

$2^{10} = 1024$). Consequently, the V_{RL} voltage is calculated according to eq. (2).

$$V_{RL} = A \times \left(\frac{V_C}{1024} \right) \quad (2)$$

Before each new measurement, a calibration procedure is necessary to determine the value of the sensor resistance in pure air (R_0). The concentration of the sample gas is then deduced from the value of the ratio R_S/R_0 using the calibration graphs of Fig. 2.

3. Measuring technique using an airtight enclosed chamber

According to the manufacturer, the measuring range of the MQ-4 and MQ-8 sensors is 200 to 10,000 ppm, i.e., a maximum concentration of 1% (Fig. 2). This range is well suited to the application of these sensors for leak detection, as the most important thing is the activation of a safety system as soon as a minimum threshold is reached. However, for applications in quantitative gas measurement, the upper limit of 1% severely restricts the use of these sensors as the concentration of the gas components to be measured can exceed this limit. For example, during gasification in a downdraft gasifier using air as the oxidizing gas, the H_2 content of the syngas can vary from 7 to 30% and the CH_4 content from 0.5 to 7% [55]. The main objective of this study is therefore to find a technique to allow the measurement of CH_4 and H_2 having a concentration higher than 1% with the MQ-4 and MQ-8 sensors.

Yang et al. [17] proposed a solution to the problem. They demonstrated that it is possible to adjust the concentration of the gas to be within the measuring range of the MQ sensor by diluting it with air in an enclosed hermetic recipient. The true concentration (X) of the gas, which must be identified, is then given by eq. (3).

$$X = M \times \frac{(Vol_{inj} + Vol_{chamb})}{Vol_{inj}} \quad (3)$$

where M is the concentration measured by the MQ-sensor, Vol_{inj} the volume of injected gas, and Vol_{chamb} is the free part of the enclosed test chamber. The complexity of this approach lies in the approximation of the volume Vol_{chamb} , which is not evident to assess due to the presence of the electronic sensors and Arduino UNO data acquisition inside the chamber.

In the system designed by Yang et al. [17] the gas is injected through a hole in the lid of the chamber and another hole serves as a passage for the connecting wires between the device and the Arduino board. In the present study, the hermeticity of the system was improved by reducing

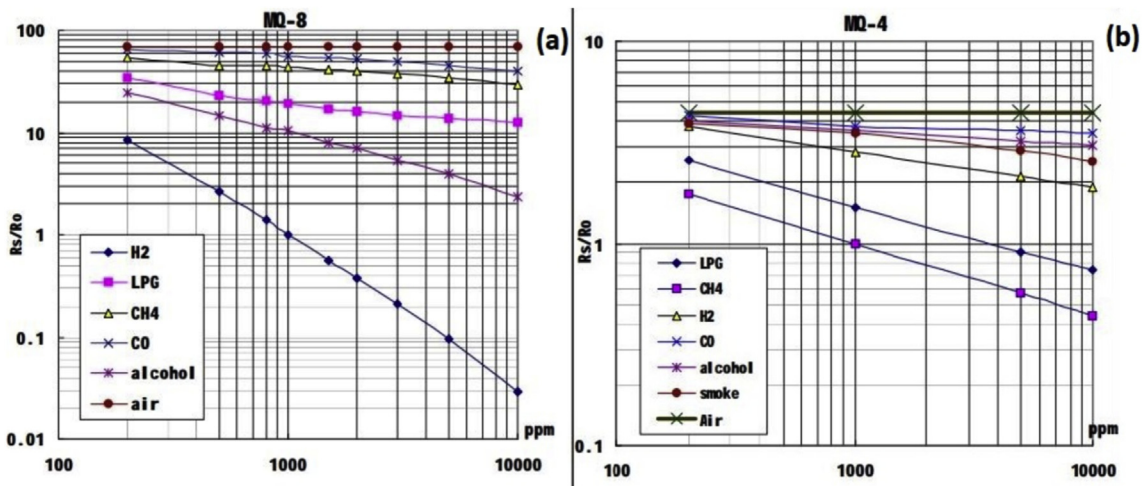

Fig. 2. (a): Sensitivity of MQ-8 at 20°C, 65% relative humidity, and loadresistor $R_L = 10 \text{ k}\Omega$ [53] ; (b): Sensitivity of MQ-4 at a temperature of 20°C, 65% relative humidity, and load resistor $R_L = 20 \text{ k}\Omega$ [54].

the number of holes in the lid (see Fig. 3).

3.1. Experimental setup and data acquisition chain of the hermetic system

The test chamber, containing the MQ sensor and the Arduino board, powered by a 9 V battery, is a 1-L plastic container (of the “Tatay” brand) (Fig. 3a). To improve the hermeticity of the chamber, only one hole was made on the lid for gas injections. So, data transmission from the sensor to the computer is done wirelessly with a 433 MHz transmitter-receiver module. The reception of this signal is ensured by another Arduino board connected to a computer (Fig. 3b). A valve is mounted on the injection tube to prevent leaks after the injection. The injection tube was made from a perfusion set (available at pharmacies).

To control the tightness of the test chamber, a BME280 sensor is placed inside it to monitor the pressure. When the system is tightly sealed, the pressure inside the test chamber varies linearly as a function of the injected gas volume. This condition is necessary to ensure the quality of the gas measurement and the stability of the system (i.e., no gas exchange between the inside and the outside of the airtight test chamber during measurement). A drop in pressure after the valve was closed indicates a gas leak, resulting in a change of the initial injected gas concentration. A drop in pressure after the valve was closed indicates a gas leak, resulting in a change of the initial injected gas concentration.

A series of preliminary measurements were performed to check the test chamber for leaks. Three different volumes of air were injected inside the test chamber: 20 ml, 40 ml, and 60 ml. Fig. 4 shows the experimental results of the hermeticity test. The pressure increases linearly with the injected volume, with a linear correlation coefficient R^2 of 0.9995. The recipient thus perfectly conserves the air injected.

3.2. Methane measurement with an MQ-4 sensor

The measurement of the CH_4 concentration in a standard gas was performed inside the airtight enclosed chamber with an MQ-4 sensor. The standard gas contains 20% CH_4 , 10% CO_2 , and 70% He. Six volumes of the standard gas were injected in the chamber: 10 ml, 20 ml, 30 ml, 40 ml, 50 ml and 60 ml. Fig. 5 shows the evolution of the pressure inside the container for the six volumes of gas injected with two series of tests. It can be seen that the pressure became stable 30 s after each injection. Values recorded after 5 minutes can, therefore, be considered as representative of each measurement.

Fig. 6a shows the evolution of the recorded pressure values as a function of the volume injected. With linear correlation coefficient R^2 of 0.997, a good proportionality between the injected volume and the pressure in the test chamber is observed. Following the model by Yang et al. [17], this linearity makes it possible to establish a relationship between the pressure and the volume. The standard deviation of two

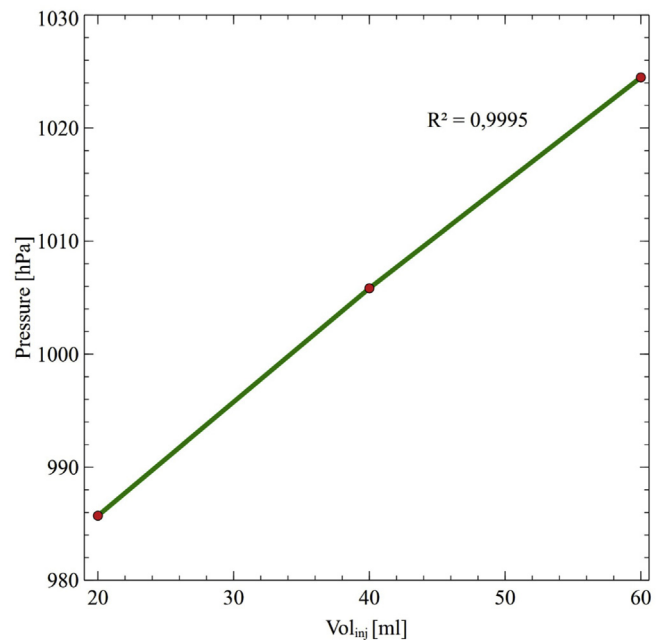

Fig. 4. Linearity between the volume of injected air and the pressure inside the recipient.

pressure values for the same volume of injected gas indicates the fidelity of the device over two series of measurements. A maximum rate of 0.18% of the average (corresponding to gas injections of 50 ml) demonstrates the reliability of the protocol adopted for measuring CH_4 in the airtight enclosed chamber.

The representations of the temporal variation of the CH_4 concentration (Fig. 7) for the six volumes injected over two tests show the stability of the values obtained after approximately three minutes. Five minutes is, therefore, a reasonable time to obtain a stable measurement of gas concentration with this device.

Fig. 8a shows the evolution of the concentration measured after five minutes in function of the injected volume. It is clear that even if the concentration increases with the volume, the relationship is not proportional, the linear correlation coefficients being 0.8135. The non-linearity is more pronounced for smaller volume, exhibiting a steeper slope. Hence, measurements of injections above 30 ml show better linearity. Besides, the standard deviations are at their minimums for 40 ml (0.32%) and 50 ml (2.39%) injections but reach their maximum at 10 ml (13.88%). Thus, for the CH_4 measurements, the proposed device offers better operation for gas volumes between 30 ml (i.e., representing 3% of

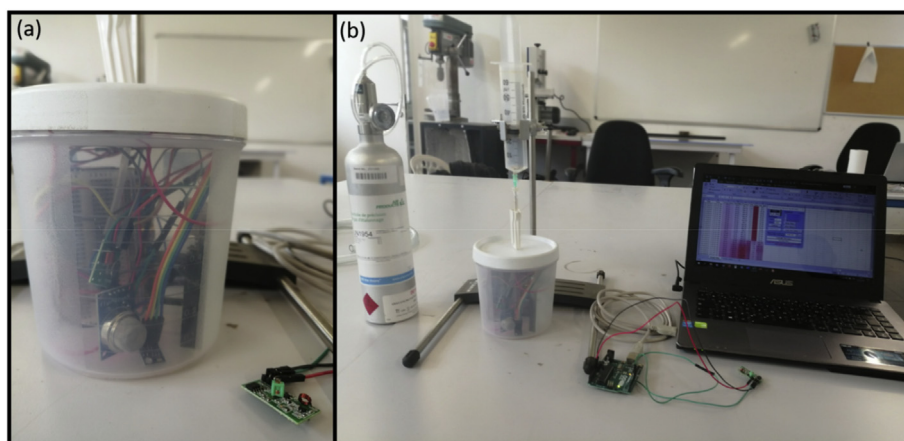

Fig. 3. (a) Hermetic test chamber with the sensors and Arduino board inside; (b) Acquisition chain.

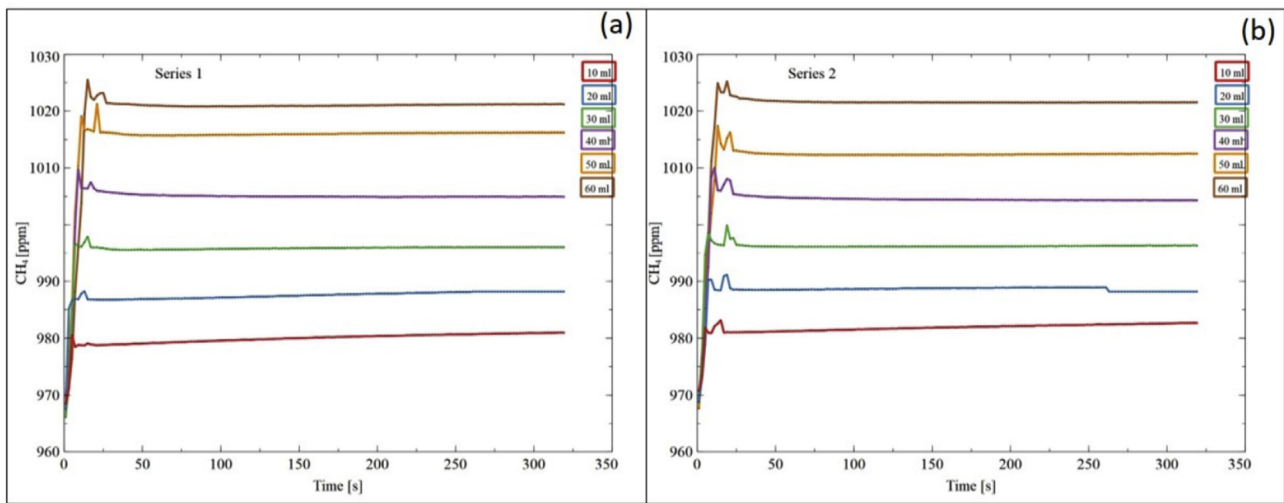

Fig. 5. Pressure evolution for six volumes of injection of the standard gas (methane).

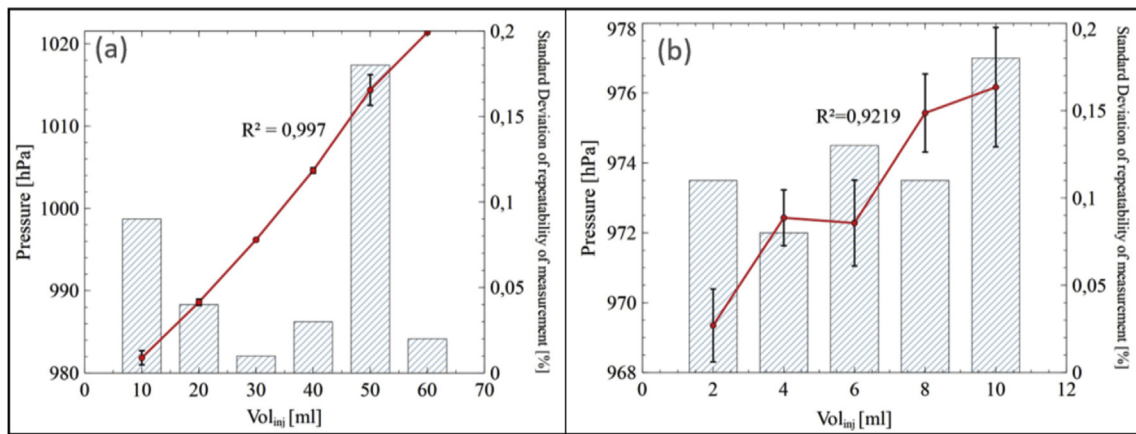

Fig. 6. Pressure vs Volume of standard gas injected in the airtight enclosed chamber (a) 10–60 ml of CV₄; (b) 2–10 ml of H₂. Error bars represent absolute errors and histograms represent standard deviations (expressed as % of the mean).

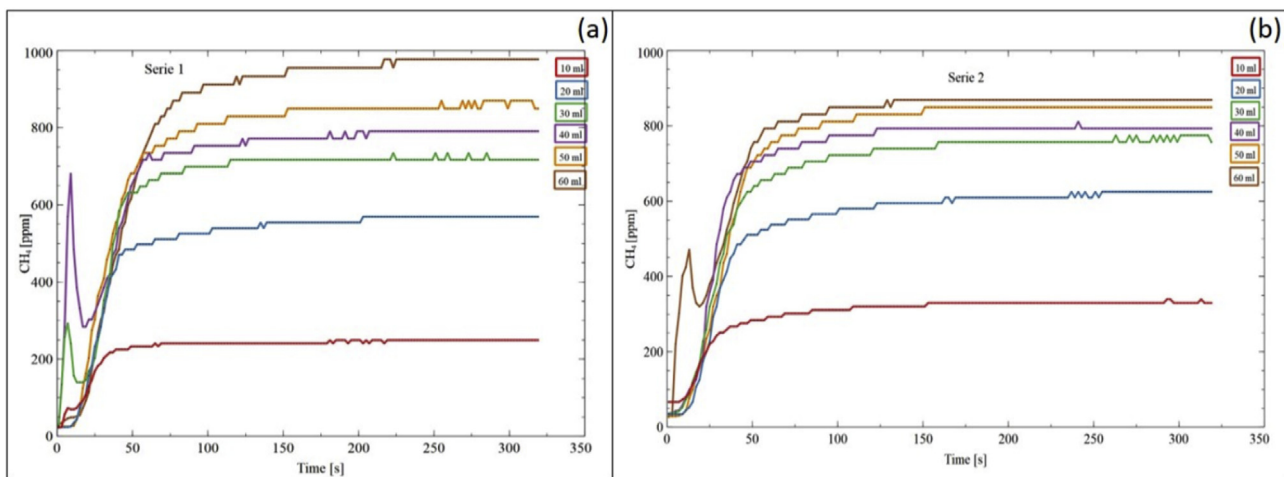

Fig. 7. Temporal evolution of the CH₄ concentration measured for 6 injected volumes of standard gas.

the hermetic test chamber test) and 50 ml (i.e., representing 5% of the hermetic test chamber test).

The ppm concentrations measured by the sensor are still far from the concentration of the mixture because the maximum value measured here

is 868 ppm (i.e., 0.08%), whereas the exact methane content of the standard gas is 20%. Two explanations can be advanced. First, the distance that separates the injection needle from the sensor may cause this difference. Because methane is lighter than air, the injected volume of

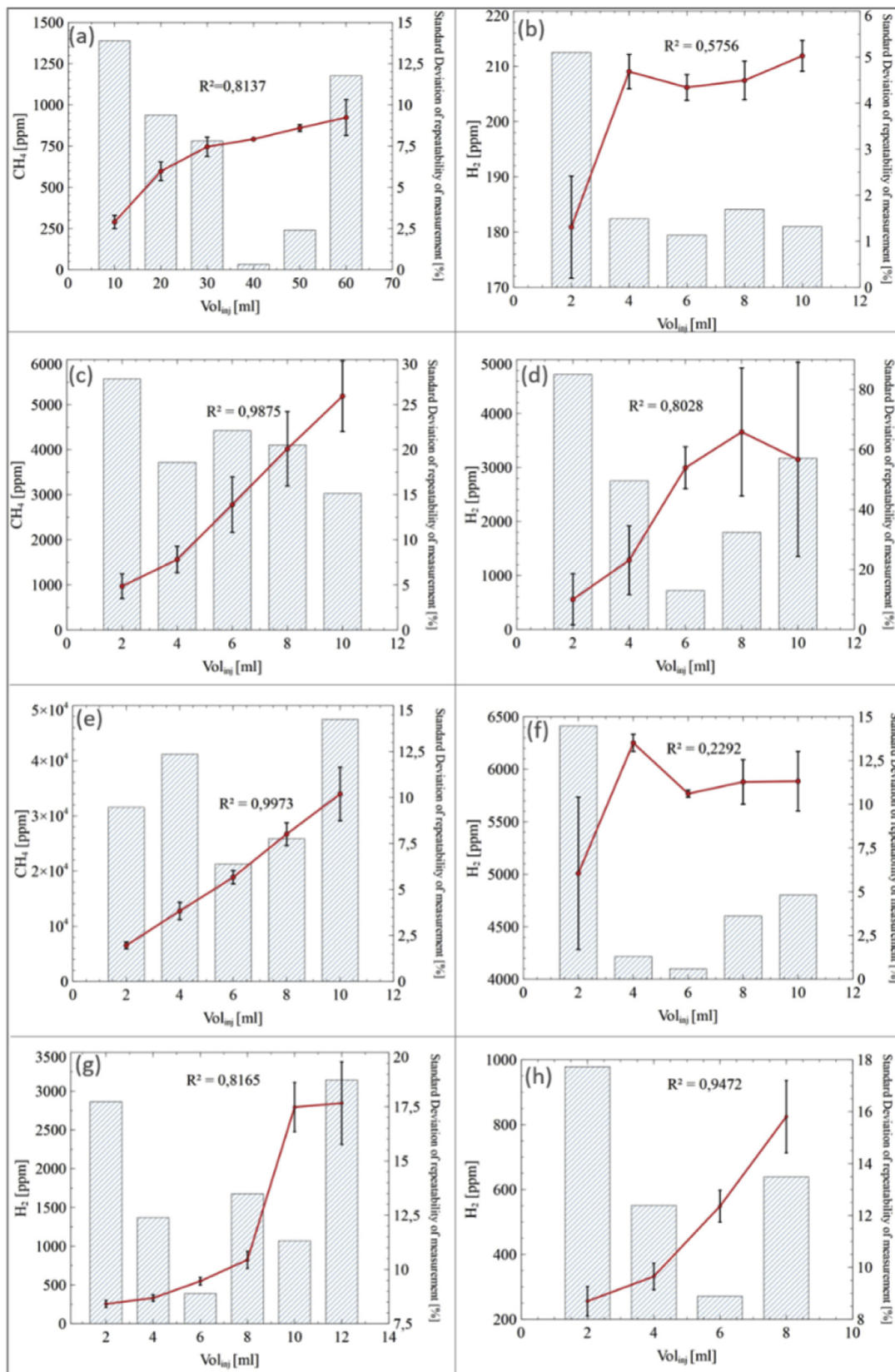

Fig. 8. Gas concentration vs Volume of standard gas injected (a) 10–60 ml of CH₄ in the airtight enclosed chamber; (b) 2–10 ml of H₂ in the airtight enclosed chamber; (c) 2–10 ml of CH₄ in 10 ml of mixture in an open environment; (d) 2–10 ml of H₂ in 10 ml of mixture in an open environment; (e) 2–10 ml of CH₄ in 10 ml of mixture in the partially closed capsule; (f) 2–10 ml of H₂ in 10 ml of mixture in the partially closed capsule; (g) 2–10 ml of H₂ in 60 ml of mixture in the partially closed capsule; (h) 2–8 ml of H₂ in 60 ml of mixture in the partially closed capsule. Error bars represent absolute errors and histograms represent standard deviations (expressed as % of the mean).

methane may not properly cover the sensor but can stay at a certain distance above it. Then, the amount of space available inside the test chamber may reduce the homogeneity of the mixture of the air and the standard gas.

3.3. Hydrogen measurement with an MQ-8 sensor

The same measurement tests defined in paragraph 3.2 have been applied to measure the H_2 concentration of the second standard gas. The experiment was performed with three series of measurements. Six injection volumes of 10, 20, 30, 40, 50, and 60 ml were used for each series. Fig. 9 shows the pressure variations inside the test chamber after the injection of different volumes of the standard gas. In contrast to the results for CH_4 , the evolution of the pressure in the recipient shows a regression over time. This pressure drop is more pronounced when the injected volume is higher. According to these measurements, the

recipient is no longer hermetic at H_2 volumes greater than 10 ml. The technique is therefore not applicable for measuring the H_2 concentration since the injected gas is not conserved. The difference between the molecules may explain this discrepancy in the retention of CH_4 and H_2 . CH_4 molecules containing one carbon atom and four hydrogen atoms occupy more volume than dihydrogen molecules containing two hydrogen atoms.

Because gas leaks have been detected at injection volumes of 10–60 ml, the measurement protocol was applied to volumes of 2, 4, 6, 8, and 10 ml. Three series of measurements were performed for each volume. Fig. 10 shows the pressure evolution of each injection. For volumes of 2 to 6 ml, a slight increase in pressure is noted over time, unlike the 8 and 10 ml injection volumes, which are more stable. These experiments show that it is more appropriate to use the 8 and 10 ml volumes to obtain relatively stable measurements for hydrogen.

Fig. 6b presents the pressure variation recorded after five minutes as a

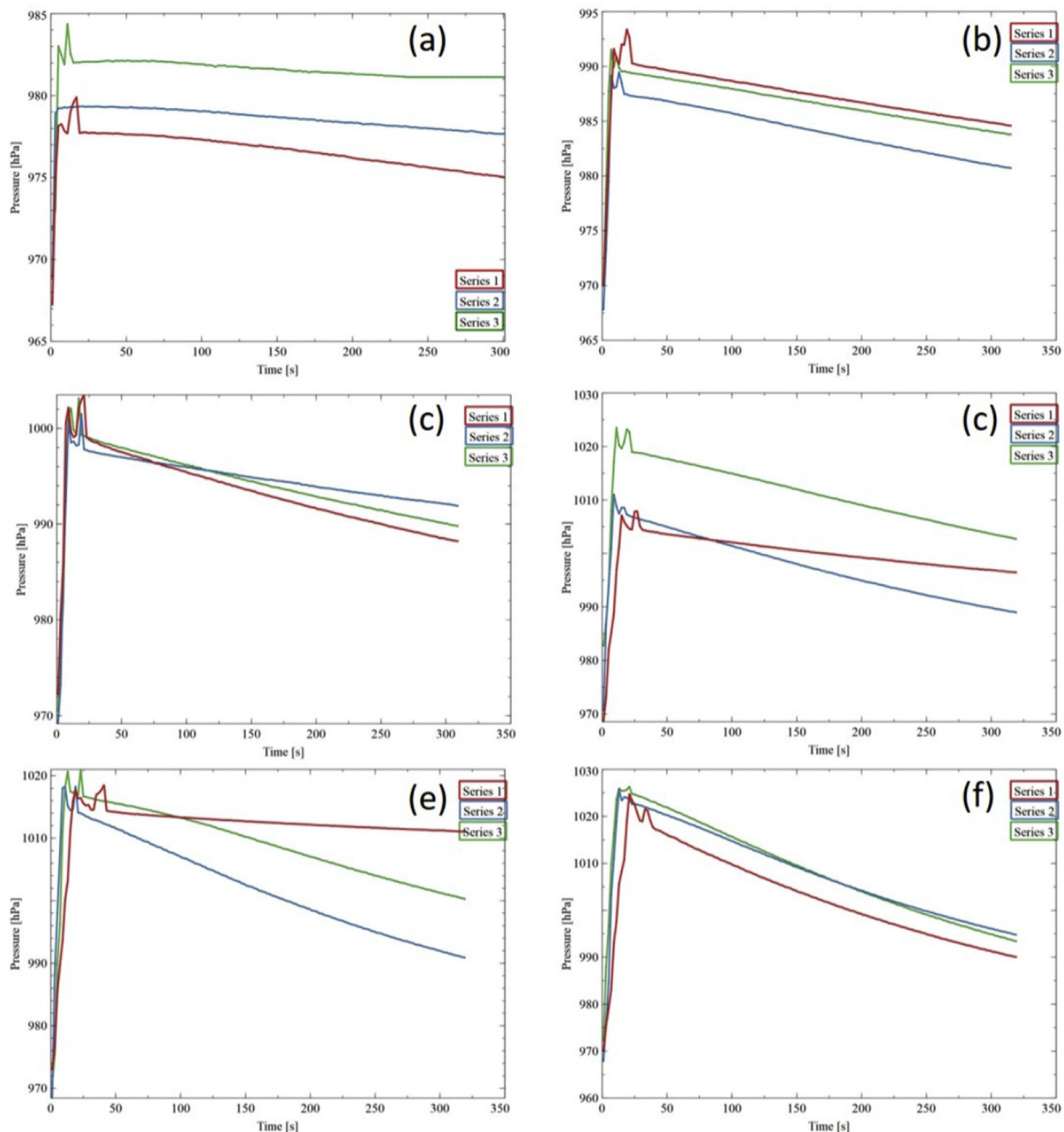

Fig. 9. Pressure evolution of H_2 injection: (a) 10 ml, (b) 20 ml, (c) 30 ml, (d) 40 ml, (e) 50 ml, (f) 60 ml.

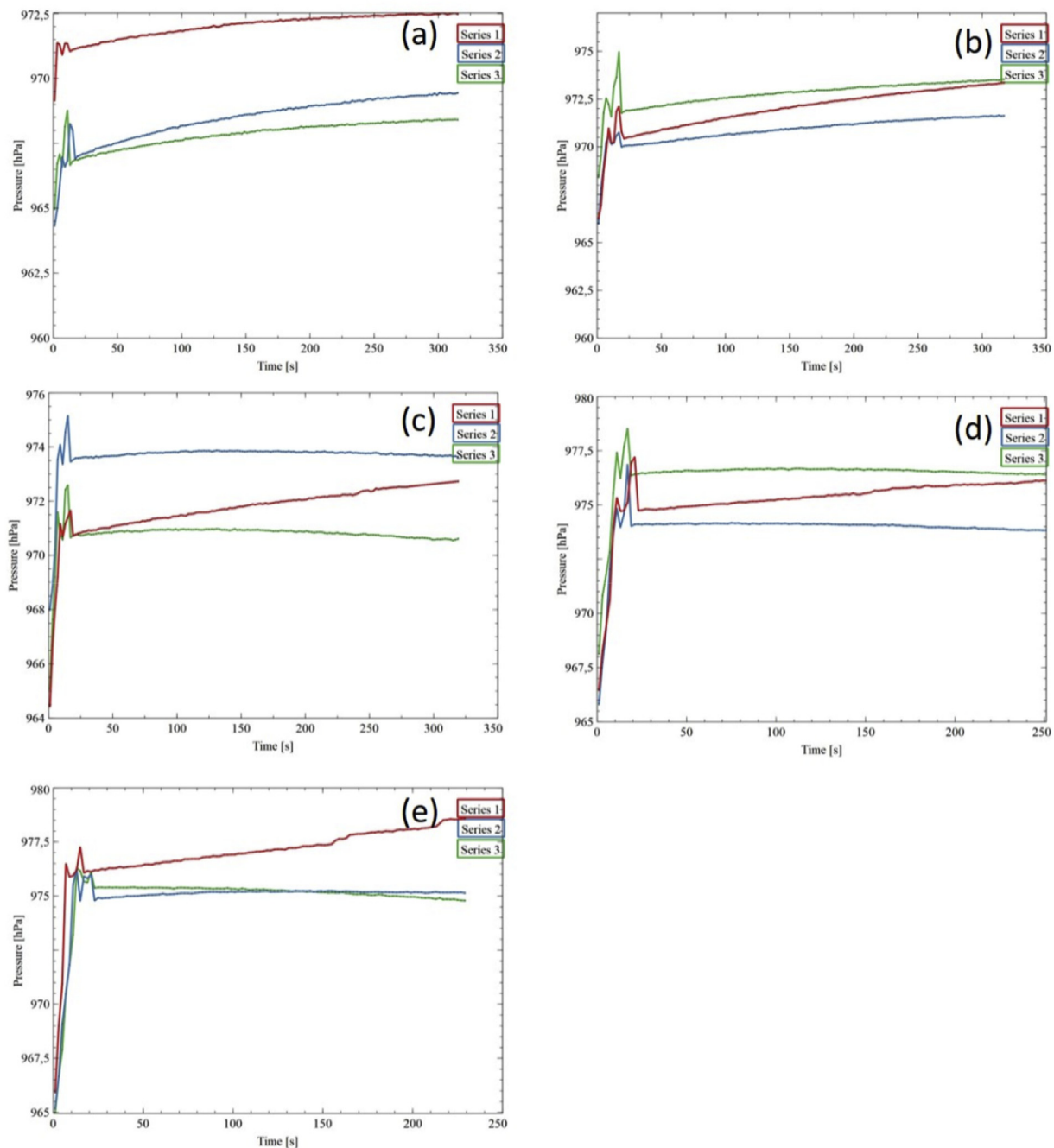

Fig. 10. Pressure evolution of H_2 injection: (a) 2 ml, (b) 4 ml, (c) 6 ml, (d) 8 ml, (e) 10 ml.

function of the volumes injected from 2 to 10 ml. An increase in pressure is observed in relation to the injected volume, indicating the conservation of the gas in the container. The good repeatability of the protocol is demonstrated by a maximum standard deviation of 0.18% (corresponding to the volume injection of 10 ml).

Fig. 8b shows the H_2 concentration measurements as a function of the injected gas volume. For injections of 4 to 10 ml (i.e. (b), (c), (d), (e), (f) and (g) of the Fig. 8), the values obtained here indicate good repeatability. However, the sensor is unable to distinguish the gas concentrations since the recorded values are all approximately 200 ppm despite the increase of the injected volume. These values are far from the standard H_2 gas concentration used in the experiment (i.e., 99.99% diluted in air). The volume of the test chamber and the distance between the injection needle and the sensor are the origins of the H_2 measurement errors (see paragraph 3.2 for additional explanations). Therefore, the hermetic test

chamber is not adapted to measure the H_2 concentration.

3.4. Analysis, advantages, and disadvantages of the measuring technique using an airtight enclosed chamber

The measurement of gas concentration inside the airtight enclosed chamber ensures isolation from the environment in which the gas is brought into contact with the sensor. Parameters such as temperature, humidity, and pressure of the environment of the sensor are easily measured. And the values of pressure or concentration reported are those recorded after a scan time, and so, are stable. That's why this technique provides good repeatability of the measurement.

However, the technique has disadvantages. Operating of the BME280 sensor and the 433 MHz transmitter module in connection with the MQ sensor requires more energy, resulting in a rapid decrease in the battery

voltage. A regular check of the power supply is therefore necessary before each measurement series. Concerning the dilution technique proposed by Yang et al. [17], the values recorded during the CH_4 and H_2 measurements are very low, contrary to the expected standard values, because the air and gas mixture in the airtight test chamber is not homogeneous. Moreover, the presence of the electronic components causes difficulties in determining the volume (Vol_{chamb}) available in the recipient used in eq. (3).

4. Measuring technique in an open environment

During the experiment on the airtight test chamber (i.e. paragraph 3.4) it's was demonstrated that the distance between the injection syringe and the sensor was crucial for collecting correct measurement values. In this paragraph, a direct measurement protocol is proposed to reduce these measurement errors.

4.1. Experimental setup and data acquisition chain for the open system

The solution suggested here consists of injecting the gas directly on the sensor placed in an open environment and to consider the peak of the recorded values (see Fig. 11). The dilution phase was performed inside the syringe before injection on the sensor. Five volumes of gas were taken with the syringe: 2, 4, 6, 8, and 10 ml. Air was then sucked into the syringe to fill it up to 10 ml. Thus, for each volume of gas (i.e. 2, 4, 6, 8 and 10 ml), 8, 6, 4, 2 and 0 ml of air are added for balance, respectively.

4.2. Methane measurement with an MQ-4 sensor

Fig. 8c shows the measured CH_4 concentrations for each volume of standard gas in the mixture. Six series of measurements were performed using the same protocol described in paragraph 3.4. It can be observed that the gas concentrations measured during this open environment experiment have higher amplitudes than those recorded with the airtight test chamber (see Fig. 8a for the experimental results of the airtight test chamber). For example, when injecting 10 ml of the standard gas (6th series), the sensor measured 6217 ppm of CH_4 with direct injection, whereas with the airtight test chamber, the maximum value was 868 ppm for an injection of 60 ml of the same gas. However, the recorded values show a significant fluctuation because the measurements were made in an open environment. The standard deviations between the six measurements for each volume are between 15.13% and 27.84% of the mean. The measurements are, therefore, less repeatable, and the results are unreliable. Nevertheless, good linearity between the injected volume and

the measured concentrations (average of the six series), with a linear correlation coefficient of 0.9875, is noted.

4.3. Hydrogen measurement with an MQ-8 sensor

The same protocol used in paragraph 4.2 to mix air with the standard gas in the syringe before injection was applied for H_2 measurement. Six series of measurements were also performed for each volume of standard gas injected. Fig. 8d shows the concentrations measured for each volume of H_2 in the mixture. It is observed that, as in the case of the CH_4 measurement, the sensor gave better results when the gas was injected directly on the sensor. For example, in the second series of measurements, a maximum value of 5238 ppm is obtained with an injection of a mixture containing 10 ml of H_2 . However, the injection of hydrogen in an open environment causes even larger fluctuations than with CH_4 . Poor repeatability of the measurements is also demonstrated by the values of the standard deviation, reaching 85.02% for 2 ml of H_2 . In addition, the average concentration recorded for 8 ml of H_2 is higher than that corresponding to 10 ml. These results are due to the volatility of hydrogen, especially when the mixture contains large amounts of H_2 . Finally, the linear correlation coefficient of 0.8028 indicates disproportionality between the injected volume of H_2 and the measured concentration.

4.4. Analysis, advantages, and disadvantages of the measuring technique in an open environment

Measuring the gas by direct injection on the sensor allows the latter to detect the gas better because of its greater gas exposure. In addition, the dilution volume in which the gas is mixed is directly controlled and known owing to the graduated syringe. The device consists only of an MQ sensor connected to the Arduino board and can be powered directly through a USB cable which also transmits the signal to the computer. The technique, therefore, has the advantages of a simple implementation and a relatively stable power supply.

However, placing the sensor in the open air causes considerable variations in the measurements. The phenomenon is even more pronounced when the gas is highly volatile, like hydrogen. The repeatability of the test measurements showed that the technique applied to measure methane and hydrogen concentrations in an open environment is not reliable. The direct application of the injection needle onto the sensor allows for better detection, but the gas injected evacuates quite quickly, which does not give enough time for the sensor to measure the concentration appropriately.

5. Measuring technique in a partially closed capsule

Both the CH_4 and H_2 measurement techniques proposed so far have the following disadvantages: in the first concept (measurement in an airtight enclosed chamber), the space between the injection syringe and the gas detector greatly reduces the sensor's measuring capacity. In the second concept, injecting the gas in an open environment does not allow the gas to remain sufficiently in contact with the sensor and consequently reduces the quality of the measurement. Besides, the repeatability of the measurement becomes dependent on possible air movements around the sensor.

To cope with these problems, a third prototype is proposed: that of putting the sensor in a partially closed capsule. As shown in Fig. 12, the capsule has a reduced volume that limits the movement of gas inside. The small space available between the internal walls of the capsule and the active surface of the sensor allows the sensor to react better to the gas and can thus solve the problem of the first concept.

To allow gas injection, the capsule has a 25 mm long tube with an open-end (Fig. 12). Apart from this opening, the capsule isolates the sensor from the outside environment. This partial isolation slows down the evacuation of the gas and increases the contact time between the gas and the sensor. Moreover, the isolation brought by the capsule eliminates

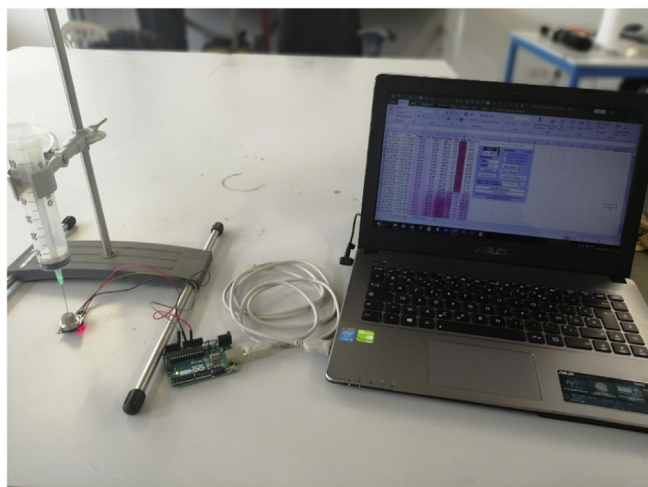

Fig. 11. Gas measurements in an open environment: syringe, sensors and acquisition chain.

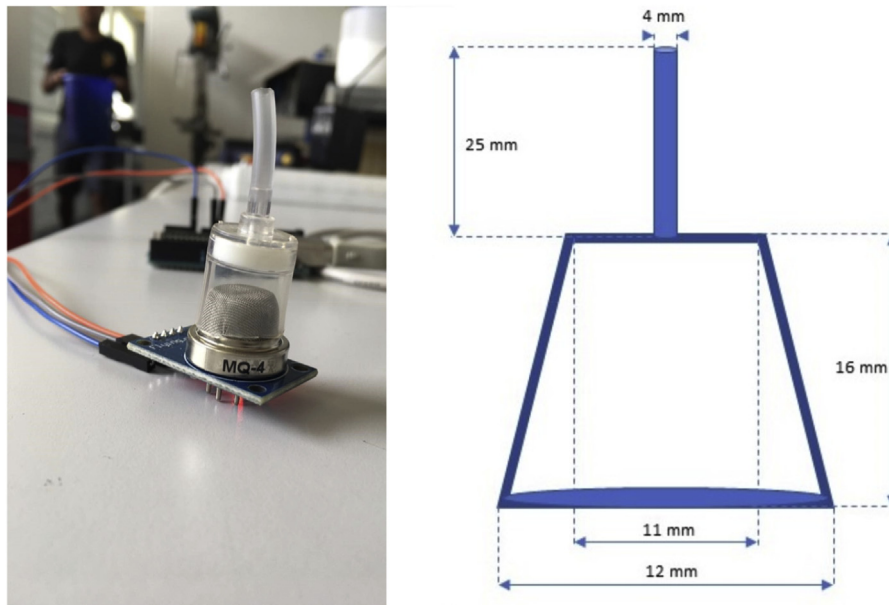

Fig. 12. The partially closed capsule for direct gas measurement and its dimensions.

influences of air movement from the outside environment on the measurement and can improve the repeatability.

5.1. Experimental setup and data acquisition chain for the new method

The measurement protocol is the same as that described in the measurement technique in an open environment (see paragraph 4.1). The only difference was the addition of a partially closed cylindrical minicapsule to the sensor head (see Fig. 12). The capsule (see the dimension in Fig. 12) can easily be built from a 3D printer. It has a tube on its top to allow gas injections from the syringe.

The capsule is not completely hermetic and therefore does not allow for stable measurement values. As discussed in Chap 4, the value considered is, therefore, the peak recorded after each injection.

Fig. 13 shows the measurement acquisition chain consisting of the encapsulated MQ sensor, a graduated syringe for the gas dilution and injection, and an Arduino board that connects the sensor to a computer for data collection.

MQ sensors are not suitable for measuring very high concentrations

(more than 10,000 ppm). To resolve the problem, a proportional coefficient C must be defined for each sensor to account for the sensitivity of the measurements. The constant parameter C of the sensor was defined in the present study using eq. (4):

$$C = \frac{\sum_{i=1}^n Y_i}{n} \quad (4)$$

with

$$Y_i = \frac{R_i}{M_i} \quad (5)$$

where Y_i is the proportionality ratio of a given volume i , M_i is the value of the gas concentration measured by the sensor for a given volume i , R_i is the target gas concentration in the standard gas for a given volume i and n is the number of injections considered.

C becomes the “multiplier factor” of the MQ sensor for adjusting and obtaining the real concentration values.

5.2. Methane measurement with an MQ-4 sensor

Fig. 8e shows the recorded data for six series of CH_4 measurements in the standard gas composed of 20% CH_4 , 10% CO_2 , and 70% He. As for the direct injection in an open environment in Chap 4, six different volumes of the standard gas were collected and then mixed with air inside the syringe to form a 10 ml mixture: (2 ml of gas + 8 ml of air), (4 ml of gas + 6 ml of air), (6 ml of gas + 4 ml of air), (8 ml of gas + 2 ml of air), and finally 10 ml of gas. Compared to the values obtained by open-environment injection, shown in Fig. 8c, there is a considerable difference between the measured concentrations. If the maximum value is 6217 ppm for a gas injection of 10 ml in the open environment, then for the same volume, the sensor is capable of detecting up to 42,924 ppm in the partially closed capsule. It should be noted that this value exceeds the measuring range of 200 to 10,000 ppm indicated by the manufacturer. However, the average concentration curve for the six series of measurements shows that the sensor response is quite linear in relation to the injected gas volume, with a linear correlation coefficient of 0.9973. It is therefore justified to take these values into account. The possibility of using the sensor beyond the measuring range indicated by the manufacturer was also noted by Yang et al. [17] who even measured up to 110,000 ppm of CH_4 in biogas with the MQ-4.

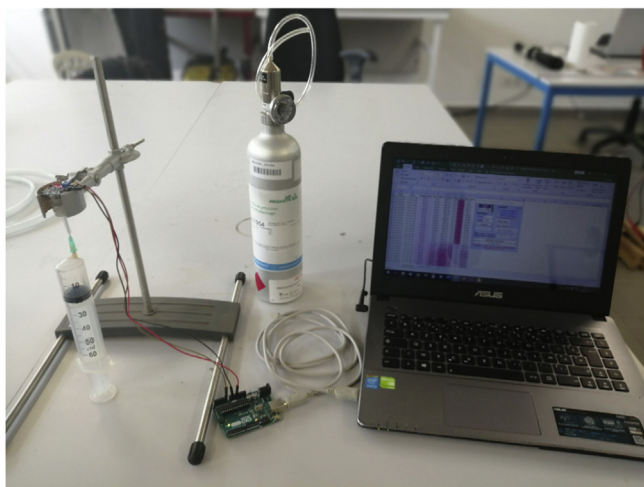

Fig. 13. New method for measuring gas: the sensor inside the partially closed minicapsule, the Arduino board, the syringe, and the computer.

The integration of the partially closed capsule onto the sensor also improved the repeatability of the measurement. As shown in Fig. 8e, the maximum standard deviation for the six series of the measurements is 14.28% with 10 ml of standard gas. This maximum value is lower than the minimum standard deviation of 15.13% calculated for open-environment injection (Fig. 8c).

The results presented in Fig. 8e show that the use of the partially closed capsule provides good linearity between the injected volume and the detected concentration as well as good repeatability of the measurement. Nevertheless, the recorded values do not correspond to the CH_4 concentration of the injected mixture even though the sensor is more accurate for its detection. Thereby, a calibration coefficient C was calculated and is equal to 6.19 (see eq. (4) for the calculation of C and Table 1 for that of Y_i). The experimental values (CH_{4_meas}) delivered by the sensor were then multiplied by this calibration coefficient C to determine the real concentration of the gas (CH_{4_adj}). Hence, the application of this coefficient to each volume of gas allows the measurement to be corrected. The absolute errors between the concentrations of the injected standard gas (CH_{4_std}) and the adjusted values (CH_{4_adj}) calculated after the correction are between 0.03 and 1.02% with an average absolute error of 0.40%. We noted that the minimum absolute error of 0.03% was recorded when the volume of the standard gas in the mixture was equal to the available volume inside the capsule which is approximately 2 ml.

5.3. Hydrogen measurement with an MQ-8 sensor

The same protocol used for the CH_4 measurement was applied to the H_2 measurement with the sensor inserted into a partially closed capsule. To limit the movement of gas favored by the volatility of hydrogen, the sensor is positioned upside-down as shown in Fig. 14.

Fig. 8f illustrates the concentration values given by the sensor for H_2 volumes of 2–10 ml mixed with air to give a 10 ml mixture. It can be seen that, as in the case of the use of the airtight test chamber in Fig. 8b (paragraph 3.3), the sensor is unable to distinguish the different concentrations corresponding to each volume. Although the recorded values are higher, with a maximum of 6332 ppm, the excessively high H_2 content of the mixture does not allow the sensor to function effectively. However, good repeatability of the measurements is noted for volumes varying from 4 to 10 ml, with a maximum standard deviation of 4.81%.

To improve the measurement and bring it inside the range defined by the manufacturer, the proportion of air was increased to have a mixture of 60 ml for each injection. Fig. 8g shows the results obtained for volumes of H_2 varying from 2 to 12 ml over four series of measurements. A better response of the sensor is observed compared to the standard deviations reported in Fig. 8f. The differences in recorded values between each series are smaller for H_2 volumes of 2 to 8 ml. So, when the results corresponding to 10 and 12 ml of H_2 are excluded, the linear correlation coefficient between volume and concentration increases from 0.8165 to 0.9472 (Fig. 8h). Sensor calibration was therefore performed for these volumes of H_2 volumes (i.e., 2 ml to 8 ml). A multiplier factor C of the MQ-8 sensor is determined from the measured H_2 values and the H_2 content of each gas mixture. In this experiment, C is equal to 168.77 (see Table 2 for the calculation of Y_i). Using this coefficient to correct the measurement, absolute errors ranging from 0.58% to 1.06% are obtained between the corrected values and the mixture contents, with an average absolute error of 0.84%. The minimal absolute error of 0.58% is obtained when the injected gas volume is 4 times the available volume of the capsule, so, the optimum volume of the gas to be collected using this technique is 8 ml.

5.4. Analysis, advantages, and disadvantages of the measuring technique in a partially closed capsule

Measuring the gas concentration by direct injection onto the sensor in a partially closed capsule improves the repeatability of the measurement

Table 1
Calculation of the MQ-4 calibration coefficient.

Vol_inj [ml]	CH_{4_std} [%]	CH_{4_meas} [%]	Y_i	CH_{4_adj} [%]	Errors [%]
2	4	0,65	6,14	3,99	0,03
4	8	1,28	6,27	7,83	0,10
6	12	1,89	6,36	11,57	0,32
8	16	2,67	5,99	16,36	0,52
10	20	3,40	5,89	20,82	1,02

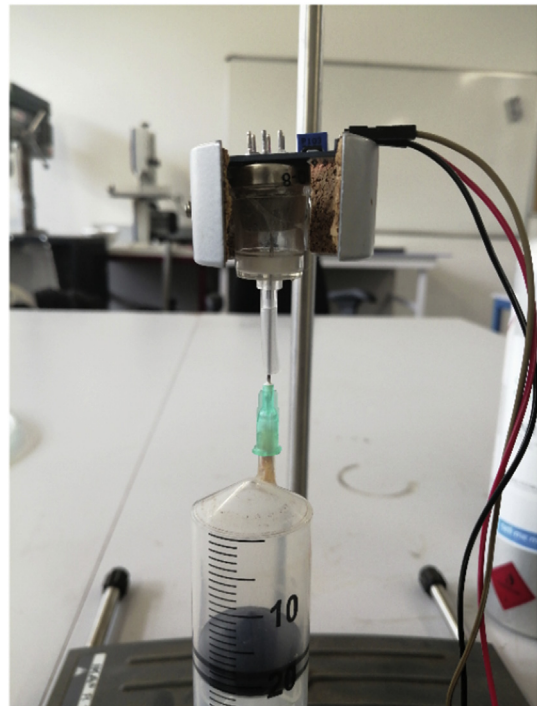

Fig. 14. Position of the MQ-8 for H_2 measurement in the capsule.

Table 2
Calculation of the calibration coefficient for MQ-8.

Vol_inj [ml]	H_{2_std} [%]	H_{2_meas} [%]	Y_i	H_{2_adj} [%]	Errors [%]
2	3,33	0,048	130,32	4,32	0,98
4	6,67	0,033	200,82	5,60	1,06
6	10,00	0,055	182,25	9,26	0,74
8	13,33	0,082	161,69	13,92	0,58

because of better control of the environment where the sensor is placed. Because the gas movement is restricted by the limited volume available in the capsule, the sensitive layer of the sensor is in contact with a larger portion of the gas. The measured values are therefore more relevant. Compared to the use of the airtight enclosed chamber, this technique also offers the advantages of simple handling and a more stable supply.

Because the capsule is not entirely hermetically closed, the injected gas is not retained at the sensor. The values under consideration are then the measured peaks but not the stable values as in the case of the airtight enclosed chamber. In addition, due to the small size of the capsule, it is difficult to place other sensors inside to measure environmental parameters such as the temperature, humidity, or pressure. Finally, despite the improved measurements, there are still discrepancies between the measured values and the content of the injected mixture. For this reason, the technique requires a calibration step with standard gas, performed before starting the measurement, to correct the values given by the sensor. The volume of the capsule is important for good measurement

and the optimal size varies according to the concentration of the tested gas. The higher is the concentration of methane or hydrogen in the tested gas, the larger is the volume of the capsule.

Regarding the quantity of gas to be injected into the capsule, two conditions are required: for methane, the injected volume must be equal to the available volume inside the capsule. For hydrogen, the injected volume should be twice the available volume of the capsule. These considerations considerably improve the accuracy of the measurement.

6. Discussion

Three techniques for measuring CH_4 and H_2 using the MQ-4 and MQ-8 sensors are proposed in this article. The evolution of the measurement quality between the three techniques is summarized in Table 3. Each technique is evaluated according to two parameters: linearity and measurement repeatability. The linearity of the measurement, i.e., the correlation between the injected volume and the measured concentration is necessary to select the dynamic range value. It is characterized by the linear correlation coefficient R^2 . The repeatability of the measurement represents the ability of each technique to give more or less the same result when several series of measurements are carried out under the same conditions. It is characterized by the standard deviation expressed as a percentage of the mean of the values obtained in each series of measurements.

As can be seen in Table 3, the reduction of the space between the injection needle and the sensor has improved the linearity of the measurement. For both CH_4 and H_2 , the value of R^2 has increased between the measurement in the airtight enclosed chamber and the measurement in an open environment. Compared to direct injection in an open environment, placing the sensor in the partially closed capsule further improved the linearity of the measurement, especially for H_2 . With a linear correlation coefficient value of 0.9973 for CH_4 and 0.9472 for H_2 , gas measurement in the partially closed capsule is, therefore, the best technique concerning linearity. According to the experiments carried out, it allows a linear measurement for a CH_4 concentration between 4 and 20% and an H_2 concentration between 3.33 and 13.33%.

However, according to the datasheet provided by the manufacturers (see Fig. 2), the MQ-4 and MQ-8 sensors can detect the presence of CH_4 and H_2 between 200 ppm and 10,000 ppm, i.e. from 0.02% to 1%. As the technique of diluting the gas in the syringe before injection has pushed the upper limit of detection, it can, therefore, be stated that the measurement in the partially closed capsule has a dynamic range of 0.02% to 20% for CH_4 and 0.02% to 13% for H_2 . In the case of H_2 , linearity between gas concentration and the system response is no longer ensured beyond 13%. But for CH_4 , the upper detection limit of 20% is linked to the composition of the standard gas used (20% CH_4 , 10% CO_2 , and 70% He). Indeed, as can be seen in Fig. 6 the response of the system remained linear even with the maximum CH_4 in the syringe. It is therefore possible that the sensor response remains linear for CH_4 concentrations above this value.

Concerning repeatability, Table 3 indicates that the technique that gives the best measurement fidelity is the use of the airtight enclosed

chamber. This performance is due to the complete isolation of the gas after injection into the vessel. Thus, this technique allows for stable values to be considered after 5 min of scanning. For measurements by direct injection on the sensor, the standard deviation values are much higher and can even be up to 85.02% of the mean in the case of H_2 measurement in an open environment. This is due to the consideration of the peaks recorded after each injection instead of stable values after a scan time. However, a clear improvement in repeatability can be observed with the addition of the partially closed capsule on the sensor. The standard deviation has thus evolved from 85.02% to 17.73% for H_2 measurement and from 27.84% to 14.26% for CH_4 . These results also indicate that the improvement provided by the partially closed capsule is much more significant for H_2 , which is more volatile, than for CH_4 . Finally, it can be noted that in almost all cases, the maximum standard deviation corresponds to the mixture that contains the minimum amount of gas to be measured. This can be explained by the low amount of gas that reacts with the sensitive layer of the sensor, decreasing the fidelity of the measurement.

Regarding the selectivity of the system, it depends particularly on the calibration curve of each sensor (see Fig. 2). The MQ-4 and MQ-8 sensors used are resistive semiconductor sensors based on tin oxide (SnO_2) which react simultaneously to several reducing gases. If a gas contains both CH_4 and H_2 in equal proportion, then the sensor response may cause confusing values regarding the two calibration curves supplied by the manufacturer [6,18,36,56]. In our field application (energy sector), this will never be a problem because the proportion of these gases (CH_4 and H_2) is never balanced. For example, in the case of syngas (i.e. our study), H_2 composition is far higher than CH_4 [55], so the influence of CH_4 during H_2 measurement can be negligible when using the MQ-8 and inversely, the influence of H_2 during the measurement of CH_4 using the MQ-4 is negligible.

7. Conclusion

In this article, we propose a low-cost device for the measurement of CH_4 and H_2 using MQ-4 and MQ-8 respectively. The objective of the study is to find a simple and innovative solution to be able to measure gas concentrations higher than 1% with MQ sensors which have a measurement range limited to 10,000 ppm. Three techniques are proposed and compared according to the linearity and repeatability of the measurement.

The first technique consists of injecting the gas into an airtight enclosed chamber. The air already present in the container acts as a diluent to bring the gas concentration back into the sensor's measuring range. The insulation provided by the airtight enclosed chamber allows stable measurements, but the space available inside reduces the contact between the gas and the sensor. Moreover, unlike CH_4 , the recipient cannot correctly contain the hydrogen for injected gas volumes greater than 10 ml, whereas, with smaller volumes, it is the sensor that cannot distinguish the concentration corresponding to each volume injected. Among the three techniques, the measurement in the airtight enclosed chamber allows the best repeatability, with a maximum standard deviation of 13.88% for the measurement of CH_4 and 5.1% for H_2 , but is limited in terms of linearity, with an R^2 of 0.8637 for CH_4 and 0.5756 for H_2 .

The second technique consists of directly injecting the gas on the sensor placed in an open environment. The dilution, necessary to bring the gas concentration back into the sensor's measuring range, is then carried out in the syringe before injection. Direct injection of the gas on the sensor has greatly improved linearity (R^2 of 0.9875 for CH_4 measurement and 0.8028 for H_2) but the fluctuations of the measurement have become too significant due to the influence of the external environment (maximum standard deviation of 27.84% for CH_4 measurement and 85.02% for H_2).

The third technique consists of injecting the gas directly on the sensor

Table 3
Comparison of the three gas measurement techniques.

	vol_{inj}	R^2	Standard deviation max (%) ^a
Airtight enclosed chamber			
CH_4	10–60 ml	0.8637	13.88% (10 ml)
H_2	2–10 ml	0.5756	5.1% (2 ml)
Open environment			
CH_4	2–10 ml	0.9875	27.84% (2 ml)
H_2	2–10 ml	0.8028	85.02% (2 ml)
Partially closed capsule			
CH_4	2–10 ml	0.9973	14.26% (10 ml)
H_2	2–8 ml	0.9472	17.73% (2 ml)

^a Corresponding Vol_{inj}

placed in a partially closed capsule. As for the second technique, the dilution is carried out in the syringe before injection. The purpose of the capsule is to reduce the space available between the sensor and the gas, thus improving the reaction between the two, and to isolate the system from the outside environment. This technique has resulted in an R^2 coefficient of 0.9973 for the CH_4 measurement and 0.9472 for the H_2 measurement. The addition of the partially closed capsule also improved the repeatability even if the value of R^2 is not better than that obtained with the airtight enclosed chamber (maximum standard deviation of 14.26% for CH_4 measurement and 17.73% for H_2). Among the three techniques proposed, the direct injection of the gas into a partially closed capsule is therefore the most adequate for the measurement of CH_4 and H_2 . Experiments have shown that this technique has a linear response with a gas containing up to 20% of CH_4 or 13.33% of H_2 .

This simple, low-cost and easily transportable measurement technique represents a very attractive solution for monitoring biomass gasification systems located in remote rural areas. It allows local operators to control and improve existing installations while avoiding the high costs associated with the purchase and operation of conventional measuring devices such as gas chromatographs. So, this study contributes to the development of rural electrification in remote areas.

Declaration of interest

The authors declare that they have no known competing financial interests or personal relationships that could have appeared to influence the work reported in this paper.

Acknowledgement

The authors would like to thank the European Union for funding their research internship through the ERASMUS + project.

References

- [1] N. Ida, Sensors, Actuators, and Their Interfaces: a Multidisciplinary Introduction, SciTech Publishing Inc., 2020, <https://doi.org/10.1049/PBCE127E>. URL: oCLC: 1144181265.
- [2] S. Fericcan, Inductive Sensors for Industrial Applications, Artech House Publishers, 2019. URL: <https://us.artechhouse.com/CloudPublish/book.aspx?isbn&equals%3A9781630816605>. oCLC: 1085159307.
- [3] A. Kumar, B. Purohit, P.K. Maurya, L.M. Pandey, P. Chandra, Engineered nanomaterial assisted signal amplification strategies for enhancing analytical performance of electrochemical biosensors, *Electroanalysis* 31 (2019) 1615–1629, <https://doi.org/10.1002/elan.201900216>. URL: <https://onlinelibrary.wiley.com/doi/abs/10.1002/elan.201900216>.
- [4] P. Chandra, R. Prakash (Eds.), *Nanobiomaterial Engineering: Concepts and Their Applications in Biomedicine and Diagnostics*, Springer Singapore, Singapore, 2020, <https://doi.org/10.1007/978-981-32-9840-8>. URL: <http://link.springer.com/10.1007/978-981-32-9840-8>.
- [5] P. Chandra, Y.N. Tan, S.P. Singh (Eds.), *Next Generation Point-of-care Biomedical Sensors Technologies for Cancer Diagnosis*, Springer Singapore, Singapore, 2017, <https://doi.org/10.1007/978-981-10-4726-8>. URL: <http://link.springer.com/10.1007/978-981-10-4726-8>.
- [6] H. Hallil, H. Heidari (Eds.), *Smart Sensors for Environmental and Medical Applications*, 1 ed., Wiley, 2020 <https://doi.org/10.1002/9781119587422>. URL: <https://onlinelibrary.wiley.com/doi/book/10.1002/9781119587422>.
- [7] S.C. Mukhopadhyay, K.P. Jayasundera, O.A. Postolache (Eds.), *Modern Sensing Technologies*, Volume 29 of Smart Sensors, Measurement and Instrumentation, Springer International Publishing, Cham, 2019, <https://doi.org/10.1007/978-3-319-99540-3>. URL: <http://link.springer.com/10.1007/978-3-319-99540-3>.
- [8] V.L. Boginski, C.W. Commander, P.M. Pardalos, Y. Ye (Eds.), *Sensors: Theory, Algorithms, and Applications*, Volume 61 of Springer Optimization and its Applications, Springer New York, New York, NY, 2012, <https://doi.org/10.1007/978-0-387-88619-0>. URL: <http://link.springer.com/10.1007/978-0-387-88619-0>.
- [9] T.C. Pearce, S.S. Schiffman, H.T. Nagle, J.W. Gardner, *Handbook of Machine Olfaction: Electronic Nose Technology*, 1 ed., Wiley, 2002 <https://doi.org/10.1002/3527601597>. URL: <https://onlinelibrary.wiley.com/doi/book/10.1002/3527601597>.
- [10] V.V. Coofre, R.P. Buck, *Pharmaceutical Applications of Membrane Sensors*, CRC Press, Boca Raton, 1992, p. 24628940. OCLC.
- [11] K.T.V. Grattan, C. on, Sensors and their applications, in: *Sensors and Their Applications XI: Proceedings of the Eleventh Conference on Sensors and Their Applications Held at City University, London, UK, September 2001*, Series in Sensors, Institute of Physics Publ, Bristol, 2001. Meeting Name: Conference on Sensors and their Applications OCLC: 248173768.
- [12] L.M. Moretto, K. Kalcher (Eds.), *Environmental Analysis by Electrochemical Sensors and Biosensors*, Nanostructure Science and Technology, Springer New York, New York, NY, 2015, <https://doi.org/10.1007/978-1-4939-1301-5>. URL: <http://link.springer.com/10.1007/978-1-4939-1301-5>.
- [13] G.F. Fine, L.M. Cavanagh, A. Afonja, R. Binions, Metal oxide semi-conductor gas sensors in environmental monitoring, *Sensors* 10 (2010) 5469–5502, <https://doi.org/10.3390/s100605469>. URL: <http://www.mdpi.com/1424-8220/10/6/5469>.
- [14] M. Wu, L. Tan, N. Xiong, Data prediction, compression, and recovery in clustered wireless sensor networks for environmental monitoring applications, *Inf. Sci.* 329 (2016) 800–818, <https://doi.org/10.1016/j.ins.2015.10.004>. URL: <https://linkinghub.elsevier.com/retrieve/pii/S0020025515007124>.
- [15] S. Bhattacharya, A.K. Agarwal, O. Prakash, S. Singh (Eds.), *Sensors for Automotive and Aerospace Applications*, Energy, Environment, and Sustainability, Springer Singapore, Singapore, 2019, <https://doi.org/10.1007/978-981-13-3290-6>. URL: <http://link.springer.com/10.1007/978-981-13-3290-6>.
- [16] F. Meng, H. Wang, Q. Ma, D. Wang, J. Lin, Emission characteristics of vehicles fueled by hydrogen-enriched syngas under no-load condition, *Int. J. Hydrogen Energy* (2019), <https://doi.org/10.1016/j.ijhydene.2019.02.007>. URL: <https://linkinghub.elsevier.com/retrieve/pii/S0360319919305051>.
- [17] S. Yang, Y. Liu, N. Wu, Y. Zhang, S. Svoronos, P. Pullammanappallil, Low-cost, Arduino-based, portable device for measurement of methane composition in biogas, *Renew. Energy* 138 (2019) 224–229, <https://doi.org/10.1016/j.renene.2019.01.083>. URL: <https://linkinghub.elsevier.com/retrieve/pii/S0960148119300965>.
- [18] X. Liu, S. Cheng, H. Liu, S. Hu, D. Zhang, H. Ning, A survey on gas sensing technology, *Sensors* 12 (2012) 9635–9665, <https://doi.org/10.3390/s120709635>. URL: <http://www.mdpi.com/1424-8220/12/7/9635>.
- [19] R. Jaanisoo, O.K. Tan, *Semiconductor Gas Sensors*, Elsevier, 2019, p. 1130294623. OCLC.
- [20] M. Ayaz, H. Yksel, Design of a New Cost-Efficient Automation System for Gas Leak Detection in Industrial Buildings, *Energy and Buildings* 200, 2019, pp. 1–10, <https://doi.org/10.1016/j.enbuild.2019.07.038>. URL: <https://linkinghub.elsevier.com/retrieve/pii/S0378778819307935>.
- [21] A. Banik, B. Aich, S. Ghosh, Microcontroller based low cost gas leakage detector with SMS alert, in: *2018 Emerging Trends in Electronic Devices and Computational Techniques (EDCT)*, IEEE, Kolkata, 2018, pp. 1–3, <https://doi.org/10.1109/EDCT.2018.8405094>. URL: <https://ieeexplore.ieee.org/document/8405094/>.
- [22] R. Chen, X. Ruan, W. Liu, C. Stefanini, A reliable and fast hydrogen gas leakage detector based on irreversible cracking of decorated palladium nanolayer upon aligned polymer fibers, *Int. J. Hydrogen Energy* 40 (2015) 746–751, <https://doi.org/10.1016/j.ijhydene.2014.11.026>. URL: <https://linkinghub.elsevier.com/retrieve/pii/S0360319914031048>.
- [23] R.K. Kodali, S. Yerroju, IoT based smart emergency response system for fire hazards, in: *2017 3rd International Conference on Applied and Theoretical Computing and Communication Technology (iCATcT)*, IEEE, Tumkur, 2017, pp. 194–199, <https://doi.org/10.1109/ICATcT.2017.8389132>. URL: <https://ieeexplore.ieee.org/document/8389132/>.
- [24] V. Ramya, Embedded system for hazardous gas detection and alerting, *IJDPS 3* (2012) 287–300, <https://doi.org/10.5121/ijdps.2012.3324>. URL: <http://www.airccse.org/journal/ijdps/papers/0512ijdps24.pdf>.
- [25] D. Chengjun, L. Ximao, D. Ping, Development on gas leak detection and location system based on wireless sensor networks, in: *2011 Third International Conference on Measuring Technology and Mechatronics Automation, IEEE, Shanghai, China, 2011*, pp. 1067–1070, <https://doi.org/10.1109/ICMTMA.2011.267>. URL: <https://ieeexplore.ieee.org/document/5720970/>.
- [26] A. Shrivastava, R. Prabhakar, R. Kumar, R. Verma, GSM based gas leakage detection system, *Int. J. Tech. Res. Appl.* 1 (2013) 4. URL: <https://pdfs.semanticscholar.org/7132/cfba6e4e31ce3c6a5b0d6edf65b973e3d926.pdf>.
- [27] M. Miftakul Amin, M. Azel Aji Nugratama, A. Maselelo, M. Huda, K. Azmi Jismi, Design of cigarette disposal blower and automatic fresher using mq-5 sensor based on atmega 8535 microcontroller, *Int. J. Eng. Technol.* 7 (2018) 1108, <https://doi.org/10.14419/ijet.v7i3.11917>. URL: <https://www.sciencepubco.com/index.php/ijet/article/view/11917>.
- [28] B.B.L. Heyasa, V.R.K.R. Galarpe, Preliminary development and testing of microcontroller-MQ2 gas sensor for university air quality monitoring, *IOSR J. Electr. Electron. Eng.* 12 (2017) 47–53, <https://doi.org/10.9790/1676-1203024753>. URL: <http://www.iosrjournals.org/iosr-jeec/Papers/Vol12/20Issue/203/Version-2/F1203024753.pdf>.
- [29] V. van Zoest, F.B. Osei, A. Stein, G. Hoek, Calibration of Low-Cost NO₂ Sensors in an Urban Air Quality Network, *Atmospheric Environment* 210, 2019, pp. 66–75, <https://doi.org/10.1016/j.atmosenv.2019.04.048>. URL: <https://linkinghub.elsevier.com/retrieve/pii/S1352231019302754>.
- [30] S.I. Sabilla, R. Sarno, J. Siswanto, Estimating gas concentration using artificial neural network for electronic nose, *Procedia Computer Science* 124 (2017) 181–188, <https://doi.org/10.1016/j.procs.2017.12.145>. URL: <https://linkinghub.elsevier.com/retrieve/pii/S1877050917329137>.
- [31] F. Tian, S. Yang, K. Dong, Circuit and noise analysis of odorant gas sensors in an E-nose, *Sensors* 5 (2005) 85–96, <https://doi.org/10.3390/s5010085>. URL: <http://www.mdpi.com/1424-8220/5/1/85>.
- [32] D.R. Wijaya, R. Sarno, E. Zulaika, Gas concentration analysis of resistive gas sensor array, in: *2016 International Symposium on Electronics and Smart Devices (ISESD)*, IEEE, Bandung, Indonesia, 2016, pp. 337–342, <https://doi.org/10.1109/ISESD.2016.7886744>. URL: <http://ieeexplore.ieee.org/document/7886744/>.

- [33] D.R. Wijaya, R. Sarno, E. Zulaika, Sensor array optimization for mobile electronic nose: wavelet transform and filter based feature selection approach, *IRECOS 11* (2016) 659, <https://doi.org/10.15866/irecos.v1i18.9425>. URL: <http://www.praiseworthyprize.org/jsm/index.php?journal=irecos&page=article&op=view&path%5b%5d=19107>.
- [34] O. Anisimov, N. Maksimova, E. Chernikov, E. Sevastyanov, N. Sergeychenko, The effect of humidity and environment temperature on thin film Pt/SnO₂:Sb gas sensors, in: 2007 Siberian Conference on Control and Communications, IEEE, Tomsk, Russia, 2007, pp. 202–206, <https://doi.org/10.1109/SIBCON.2007.371325>. URL: <http://ieeexplore.ieee.org/document/4233304/>.
- [35] N. B. rsan, U. Weimar, Understanding the fundamental principles of metal oxide based gas sensors; the example of CO sensing with SnO₂ sensors in the presence of humidity, *J. Phys. Condens. Matter* 15 (2003) R813–R839, <https://doi.org/10.1088/0953-8984/15/20/201>. URL: <https://iopscience.iop.org/article/10.1088/0953-8984/15/20/201>.
- [36] D. Dorcea, M. Hnatiuc, I. Lazar, Acquisition and calibration interface for gas sensors, in: 2018 IEEE 24th International Symposium for Design and Technology in Electronic Packaging (SIITME), IEEE, Iasi, 2018, pp. 120–123, <https://doi.org/10.1109/SIITME.2018.8599253>. URL: <https://ieeexplore.ieee.org/document/8599253/>.
- [37] E.A. Florido, B.D. Cruz, Y.A. Pasion, Gas response of tin oxide film sensor to varying methane gas concentration, *Mater. Today: Proceedings* 5 (2018) 11140–11143, <https://doi.org/10.1016/j.matpr.2018.01.033>. URL: <https://linkinghub.elsevier.com/retrieve/pii/S2214785318300397>.
- [38] G. Kiriakidis, K. Moschovis, I. Kortidis, V. Binas, Ultra-low gas sensing utilizing metal oxide thin films, *Vacuum* 86 (2012) 495–506, <https://doi.org/10.1016/j.vacuum.2011.10.013>. URL: <https://linkinghub.elsevier.com/retrieve/pii/S0042207X11003769>.
- [39] F. Lu, Y. Liu, M. Dong, X. Wang, Nanosized tin oxide as the novel material with simultaneous detection towards CO, H₂ and CH₄, *Sensor. Actuator. B Chem.* 66 (2000) 225–227, [https://doi.org/10.1016/S0925-4005\(00\)00371-3](https://doi.org/10.1016/S0925-4005(00)00371-3). URL: <https://linkinghub.elsevier.com/retrieve/pii/S0925400500003713>.
- [40] G. Fadeyev, A. Kalyakin, E. Gorbova, A. Brouzgou, A. Demin, A. Volkov, P. Tsiakaras, A simple and low-cost amperometric sensor for measuring H₂, CO, and CH₄, *Sensor. Actuator. B Chem.* 221 (2015) 879–883, <https://doi.org/10.1016/j.snb.2015.07.034>. URL: <https://linkinghub.elsevier.com/retrieve/pii/S0925400515300915>.
- [41] N. Montpart, M. Baeza, J.A. Baeza, A. Guisasaola, Low-cost fuel-cell based sensor of hydrogen production in lab scale microbial electrolysis cells, *Int. J. Hydrogen Energy* 41 (2016) 20465–20472, <https://doi.org/10.1016/j.ijhydene.2016.09.169>. URL: <https://linkinghub.elsevier.com/retrieve/pii/S0360319915311460>.
- [42] Keat Ghee Ong, Kefeng Zeng, C. Grimes, A wireless, passive carbon nanotube-based gas sensor, *IEEE Sensor. J.* 2 (2002) 82–88, <https://doi.org/10.1109/JSEN.2002.1000247>. URL: <http://ieeexplore.ieee.org/document/1000247/>.
- [43] S. Sugimoto, I. Asahi, T. Shiina, Hydrogen Gas Concentration Measurement in Small Area Using Raman Lidar Measurement Technology, *EPJ Web of Conferences* 176, 2018, <https://doi.org/10.1051/epjconf/201817601019>, 01–19. URL: <https://www.epj-conferences.org/10.1051/epjconf/201817601019>.
- [44] H. Fukuoka, J. Jung, M. Inoue, H. Fujita, Y. Kato, Absolute concentration measurement for hydrogen, *Energy Procedia* 29 (2012) 283–290, <https://doi.org/10.1016/j.egypro.2012.09.034>. URL: <https://linkinghub.elsevier.com/retrieve/pii/S1876610212014543>.
- [45] I.A. de Araujo Andreotti, L.O. Orzari, J.R. Camargo, R.C. Faria, L.H. Marcolino-Junior, M.F. Bergamini, A. Gatti, B.C. Janegitz, Disposable and flexible electrochemical sensor made by recyclable material and low cost conductive ink, *J. Electroanal. Chem.* 840 (2019) 109–116, <https://doi.org/10.1016/j.jelechem.2019.03.059>. URL: <https://linkinghub.elsevier.com/retrieve/pii/S1572665719302206>.
- [46] W.A. Ahmed, M. Aggour, M. Naciri, Biogas control: Methane production monitoring using Arduino, *International Journal of Biotechnology and Bioengineering* 11 (2017) 4.
- [47] M. Tabatabaei, H. Ghanavati (Eds.), *Biogas: Fundamentals, Process, and Operation, Volume 6 of Biofuel and Biorefinery Technologies*, Springer International Publishing, Cham, 2018, <https://doi.org/10.1007/978-3-319-77335-3>. URL: <http://link.springer.com/10.1007/978-3-319-77335-3>.
- [48] P. Bajpai, Biomass conversion processes, in: *Biomass to Energy Conversion Technologies*, Elsevier, 2020, pp. 41–151, <https://doi.org/10.1016/B978-0-12-818400-4.00005-0>. URL: <https://linkinghub.elsevier.com/retrieve/pii/B9780128184004000050>.
- [49] N. Indrawan, A. Kumar, M. Moliere, K.A. Sallam, R.L. Huhnke, Distributed power generation via gasification of biomass and municipal solid waste: a review, *J. Energy Inst.* (2020), <https://doi.org/10.1016/j.joei.2020.07.001>. S1743967120301239. URL: <https://linkinghub.elsevier.com/retrieve/pii/S1743967120301239>.
- [50] R. Thomson, P. Kwong, E. Ahmad, K. Nigam, Clean syngas from small commercial biomass gasifiers; a review of gasifier development, recent advances and performance evaluation, *Int. J. Hydrogen Energy* (2020), <https://doi.org/10.1016/j.ijhydene.2020.05.160>. S0360319920319625. URL: <https://linkinghub.elsevier.com/retrieve/pii/S0360319920319625>.
- [51] Y.A. Situmorang, Z. Zhao, A. Yoshida, A. Abudula, G. Guan, Small-scale biomass gasification systems for power generation (<200 kW class): A review, *Renew. Sustain. Energy Rev.* 117 (2020) 109486, <https://doi.org/10.1016/j.rser.2019.109486>. URL: <https://linkinghub.elsevier.com/retrieve/pii/S136403211930694X>.
- [52] Dingjun Xu, Zhengyong Zhang, Characteristic analysis of gas detection basing on metal oxide semiconductor sensor, in: 2009 International Conference on Industrial Mechatronics and Automation, IEEE, Chengdu, China, 2009, pp. 61–64, <https://doi.org/10.1109/ICIMA.2009.5156560>. URL: <http://ieeexplore.ieee.org/document/5156560/>.
- [53] H.E. Co, Technical data MQ-8 gas sensor, URL: <https://datasheetspdf.com/pdf-file/904642/HANWEIELECTRONICS/MQ-8/1>, 2018.
- [54] H.E. Co, Technical data MQ-4 gas sensor, URL: <https://www.datasheetspdf.com/pdf-file/904637/HenanHanweiElectronics/MQ-4/1=>, 2018.
- [55] J.D. Martnez, K. Mahkamov, R.V. Andrade, E.E. Silva Lora, Syngas production in downdraft biomass gasifiers and its application using internal combustion engines, *Renew. Energy* 38 (2012) 1–9, <https://doi.org/10.1016/j.renene.2011.07.035>. URL: <https://linkinghub.elsevier.com/retrieve/pii/S0960148111004186>.
- [56] C.-D. Kohl, T. Wagner (Eds.), *Gas Sensing Fundamentals, Volume 15 of Springer Series On Chemical Sensors and Biosensors*, Springer Berlin Heidelberg, Berlin, Heidelberg, 2014, <https://doi.org/10.1007/978-3-642-54519-1>. URL: <http://link.springer.com/10.1007/978-3-642-54519-1>.