



**HAL**  
open science

## **A three-dimensional synthesis study of $\delta$ 18 O in atmospheric CO 2 : 1. Surface fluxes**

Philippe Ciais, A. Scott Denning, Pieter Tans, Joseph Berry, David Randall, G. James Collatz, Piers Sellers, James White, Michael Trolier, Harro Meijer, et al.

### **► To cite this version:**

Philippe Ciais, A. Scott Denning, Pieter Tans, Joseph Berry, David Randall, et al.. A three-dimensional synthesis study of  $\delta$  18 O in atmospheric CO 2 : 1. Surface fluxes. *Journal of Geophysical Research: Atmospheres*, 1997, 102 (D5), pp.5857-5872. <10.1029/96JD02360>. <hal-02923804>

**HAL Id: hal-02923804**

**<https://hal.science/hal-02923804v1>**

Submitted on 28 Oct 2020

**HAL** is a multi-disciplinary open access archive for the deposit and dissemination of scientific research documents, whether they are published or not. The documents may come from teaching and research institutions in France or abroad, or from public or private research centers.

L'archive ouverte pluridisciplinaire **HAL**, est destinée au dépôt et à la diffusion de documents scientifiques de niveau recherche, publiés ou non, émanant des établissements d'enseignement et de recherche français ou étrangers, des laboratoires publics ou privés.



HAL Authorization

# A three-dimensional synthesis study of $\delta^{18}\text{O}$ in atmospheric $\text{CO}_2$

## 1. Surface fluxes

Philippe Ciais,<sup>1</sup> A. Scott Denning,<sup>2</sup> Pieter P. Tans,<sup>3</sup> Joseph A. Berry,<sup>4</sup>  
David A. Randall,<sup>2</sup> G. James Collatz,<sup>5</sup> Piers J. Sellers,<sup>5</sup> James W. C. White,<sup>6</sup>  
Michael Trolrier,<sup>3,6</sup> Harro A. J. Meijer,<sup>7</sup> Roger J. Francey,<sup>8</sup>  
Patrick Monfray,<sup>9</sup> and Martin Heimann<sup>10</sup>

**Abstract.** The isotope  $^{18}\text{O}$  in  $\text{CO}_2$  is of particular interest in studying the global carbon cycle because it is sensitive to the processes by which the global land biosphere absorbs and respire  $\text{CO}_2$ . Carbon dioxide and water exchange isotopically both in leaves and in soils, and the  $^{18}\text{O}$  character of atmospheric  $\text{CO}_2$  is strongly influenced by the land biota, which should constrain the gross primary productivity and total respiration of land ecosystems. In this study we calculate the global surface fluxes of  $^{18}\text{O}$  for vegetation and soils using the SiB2 biosphere model coupled with the Colorado State University general circulation model. This approach makes it possible to use physiological variables that are consistently weighted by the carbon assimilation rate and integrated through the vegetation canopy. We also calculate the air-sea exchange of  $^{18}\text{O}$  and the isotopic character of fossil emissions and biomass burning. Global mean values of the isotopic exchange with each reservoir are used to close the global budget of  $^{18}\text{O}$  in  $\text{CO}_2$ . Our results confirm the fact that the land biota exert a dominant control on the  $\delta^{18}\text{O}$  of the atmospheric reservoir. At the global scale, exchange with the canopy produces an isotopic enrichment of  $\text{CO}_2$ , whereas exchange with soils has the opposite effect.

## 1. Introduction

Increasing attention has been given recently to the terrestrial biosphere in controlling atmospheric  $\text{CO}_2$  levels because the carbon stored in the aboveground biomass and in soil organic matter can be exchanged rapidly with the atmosphere. It is well recognized that land ecosystems take up and release large quantities of  $\text{CO}_2$  not only on a daily and seasonal timescale but also in the long term. Several models of the global biosphere on land have been developed which simulate the behavior of various ecosystems and have been used in order to predict the carbon fluxes exchanged with the atmosphere under specific scenarios of future climate change including ele-

vated atmospheric  $\text{CO}_2$  levels, changing nutrient availability, temperature, and precipitation patterns.

Models of ecosystem functioning have become progressively more process oriented, especially regarding the photosynthetic uptake of  $\text{CO}_2$ . A few global mechanistic models based on external “climatic” forcing, such as the incident solar flux, the water availability for plants, and the temperature, are able to calculate the gross fluxes of  $\text{CO}_2$  exchanged between land ecosystems and the atmosphere. Figure 1a gives a schematic picture of the cycling of carbon between plants, soils, and the atmosphere. Of particular importance to the atmospheric  $\text{CO}_2$  budget is the uptake of  $\text{CO}_2$  by photosynthesis ( $A$  is gross primary productivity (GPP) minus leaf respiration  $\mathfrak{R}_l$ ) and the accompanying ecosystem total respiration ( $\mathfrak{R}$ ). Respiratory  $\text{CO}_2$  emissions include aboveground plant respiration ( $\mathfrak{R}_{\text{plants}}^A$ ) and belowground root respiration ( $\mathfrak{R}_{\text{plants}}^B$ ) as well as heterotrophic soil respiration ( $\mathfrak{R}_{\text{soils}}$ ), the total  $\text{CO}_2$  efflux from soils being called  $F_{\text{soils}}$ . Over the course of the year, the annual mean assimilation  $A$  is almost entirely compensated by respiration emissions.

The  $\text{CO}_2$  biospheric fluxes calculated by ecosystem models can be partially validated against atmospheric observations. For instance, a very useful validation is to compare the seasonal variation in atmospheric  $\text{CO}_2$  simulated with given biospheric fluxes to the well-documented observational record at numerous sites around the world [Conway *et al.*, 1994]. This is commonly done by coupling the calculated field of the net ecosystem flux of  $\text{CO}_2$ , the difference between  $A$  and  $\mathfrak{R}$ , to an atmospheric transport model, and comparing the results to observations. This approach has proven very valuable for testing the seasonality of net  $\text{CO}_2$  fluxes [e.g., Fung *et al.*, 1987] but does not constrain the gross fluxes of  $\text{CO}_2$  separately.

The global budget of atmospheric  $\text{CO}_2$  has also been studied using measurements of the  $\delta^{13}\text{C}$  of atmospheric  $\text{CO}_2$ . The

<sup>1</sup>Laboratoire de Modélisation du Climat et de l'Environnement, Commissariat à l'Energie Atomique l'Orme des Merisiers, Gif sur Yvette, France.

<sup>2</sup>Department of Atmospheric Sciences, Colorado State University, Fort Collins.

<sup>3</sup>Climate Monitoring and Diagnostic Laboratory, NOAA, Boulder, Colorado.

<sup>4</sup>Department of Plant Biology, Carnegie Institution of Washington, Stanford, California.

<sup>5</sup>NASA Goddard Space Flight Center, Greenbelt, Maryland.

<sup>6</sup>Institute of Arctic and Alpine Research and Department of Geological Sciences, University of Colorado, Boulder.

<sup>7</sup>Centrum voor Isotopen Onderzoek, University of Groningen, Groningen, Netherlands.

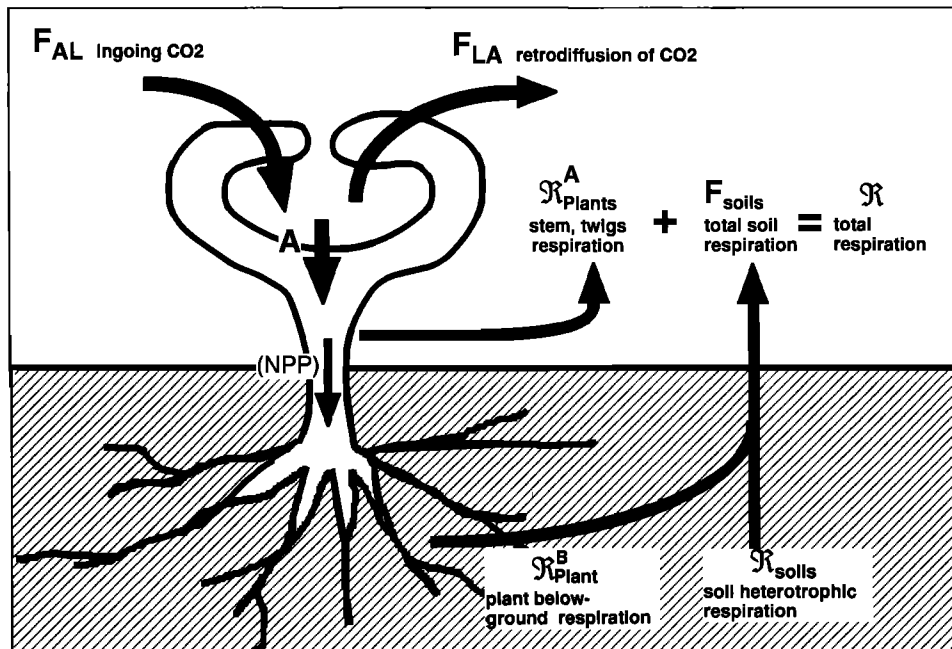
<sup>8</sup>Division of Atmospheric Research, Commonwealth Scientific and Industrial Research Organisation, Melbourne, Victoria, Australia.

<sup>9</sup>Centre des Faibles Radioactivités, Laboratoire de Modélisation du Climat et de l'Environnement, Gif sur Yvette, France.

<sup>10</sup>Max-Planck-Institut für Meteorologie, Hamburg, Germany.

Copyright 1997 by the American Geophysical Union.

Paper number 96JD02360.  
0148-0227/97/96JD-02360\$09.00



**Figure 1a.** (a) The cycling of carbon between the land biosphere and the atmosphere. The ecosystem represented is in equilibrium since the annual mean uptake of  $\text{CO}_2$  by photosynthesis ( $A$ ) compensates exactly the total respiratory loss ( $R$ ).

method relies on the interpretation of atmospheric  $\delta^{13}\text{C}$  variations as indicating net biospheric fluxes [Tans *et al.*, 1993; Francey *et al.*, 1995; Keeling *et al.*, 1995; Enting *et al.*, 1993, 1995; Ciais *et al.*, 1995]. The method is limited by uncertainty concerning the influence of isotopic disequilibria between atmosphere and surface reservoirs. Such disequilibria can be transferred to the atmosphere by gross exchange fluxes, even in the absence of net exchange.

The Earth's vegetation likely exerts a major influence on the  $^{18}\text{O}/^{16}\text{O}$  ratio of atmospheric  $\text{CO}_2$  [Keeling, 1995]. Francey and Tans [1987] first pointed out that the isotopic exchange with water in leaves (and possibly soils) may determine the observed persistent north-south differences in  $^{18}\text{O}$  of atmospheric  $\text{CO}_2$ . Farquhar *et al.* [1993] further quantified the global role of leaf exchange and calculated a global atmospheric budget of  $^{18}\text{O}$  in  $\text{CO}_2$ . Specifically, the  $^{18}\text{O}/^{16}\text{O}$  ratio of atmospheric  $\text{CO}_2$  is controlled by the fluxes  $A$  and  $R$ . We present here a synthesis simulation of  $^{18}\text{O}$  in  $\text{CO}_2$  that we compare with atmospheric measurements. In the present paper we focus on the mechanisms that govern the  $^{18}\text{O}/^{16}\text{O}$  ratio in  $\text{CO}_2$ . Specifically, we have calculated on a  $4^\circ$  by  $5^\circ$  grid the isotopic fluxes associated with the terrestrial and oceanic reservoirs, as well as with anthropogenic  $\text{CO}_2$  emissions. In the companion paper by Ciais *et al.* [this issue] we have prescribed these fluxes in the three-dimensional atmospheric tracer model TM2 and compared the simulated  $\delta^{18}\text{O}$  values to atmospheric observations.

### 1.1. Conventions and Units

In this paper, sinks correspond to a negative net flux of carbon ( $\text{CO}_2$  is removed from the atmosphere) and sources correspond to a positive net flux ( $\text{CO}_2$  is released to the atmosphere). Isotopic ratios are expressed in per mil ( $\text{‰}$ ), defined as

$$\delta^{18}\text{O} = 1000 \left[ \frac{(^{18}\text{O}/^{16}\text{O})_{\text{sample}} - (^{18}\text{O}/^{16}\text{O})_{\text{standard}}}{(^{18}\text{O}/^{16}\text{O})_{\text{standard}}} \right]$$

For  $\text{CO}_2$ , all isotopic values are given relative to the standard isotopic ratio Vienna Pee Dee belemnite (VPDB)- $\text{CO}_2 = 0.002088349077$  as recommended by Allison *et al.* [1995]. For  $\text{H}_2\text{O}$  we express isotopic abundance relative to the standard Vienna SMOW (VSMOW) = 0.00200520 [Baertchi and Macklin, 1965]. We must subtract 41.47 $\text{‰}$  to express VSMOW values in the VPDB- $\text{CO}_2$  scale. This includes a difference of  $-30.9\text{‰}$  between VSMOW and VPDB-calcite [Hut, 1987] and accounts for the  $^{18}\text{O}$  fractionation during  $\text{CO}_2$  evolution at  $25^\circ\text{C}$  with 100% phosphoric acid [Friedman and O'Neill, 1977] between VPDB-calcite and VPDB- $\text{CO}_2$ .

### 1.2. Climate Variables Used in This Study: CSU GCM and SiB2 Model

The Colorado State University (CSU) general circulation model (GCM) is derived from the University of California, Los Angeles, (UCLA) GCM, which was developed at UCLA over a period of 20 years by A. Arakawa and collaborators. A copy of the model was brought to the Goddard Laboratory for Atmospheres in 1982 and from there to CSU in 1988. Many changes have been made since the model left UCLA, including revised parameterizations of solar and terrestrial radiation [Harshvardhan *et al.*, 1987], the planetary boundary layer (PBL) [Randall *et al.*, 1992], cumulus convection [Randall and Pan, 1993], cloud microphysical processes [Fowler *et al.*, 1995], and land-surface processes [Sellers *et al.*, 1986, 1992a, b, 1996a, b]. Some recent results are presented by Randall *et al.* [1989, 1991, 1996], Fowler *et al.* [1995], and Fowler and Randall [1995a, b].

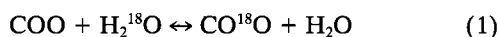
The prognostic variables of the CSU GCM are potential temperature; the horizontal wind components; the surface pressure; the PBL's depth and turbulence kinetic energy; the mixing ratio of three phases of water plus rain and snow; the temperatures of the plant canopy, the ground surface, and the deep soil; the water contents of four aboveground and three

belowground moisture stores; the stomatal conductance of the plant canopy; and the ice temperature at land ice and sea ice points. The governing equations are finite-differenced, using highly conservative schemes [Arakawa and Lamb, 1977, 1981]. The model is formulated in terms of a modified sigma coordinate, in which the PBL top is a coordinate surface, and the PBL itself is identified with the lowest model layer [Suarez et al., 1983]. The mass sources and sinks for the PBL consist of large-scale convergence or divergence, turbulent entrainment, and the cumulus mass flux. Turbulent entrainment can be driven by positive buoyancy fluxes or by shear of the mean wind in the surface layer or at the PBL top.

For vegetated land points the surface fluxes of sensible and latent heat, radiation, moisture, and momentum are determined using the simple biosphere (SiB) parameterization developed by Sellers et al. [1986]. SiB has recently undergone substantial modification [Sellers et al., 1996a, b; Randall et al., 1996] and is now referred to as SiB2. The number of biome-specific parameters has been reduced, and most are now derived directly from processed satellite data rather than prescribed from the literature. The vegetation canopy has been reduced to a single layer. Another major change is in the parameterization of stomatal and canopy conductance [Collatz et al., 1991, 1992; Sellers et al., 1992a, b, 1996a] used in the calculation of the surface energy budget over land. This parameterization involves the direct calculation of the rate of carbon assimilation by photosynthesis, making possible the calculation of  $\text{CO}_2$  exchange between the atmosphere and the terrestrial biota at the dynamic time step (6 min) of the CSU GCM [Denning, 1994; Denning et al., 1996; Denny and Randall, 1996]. Details of the carbon flux calculations and their use in isotopic exchange calculations are presented in Appendix B.

## 2. Oxygen Isotope Fractionation Between $\text{CO}_2$ and $\text{H}_2\text{O}$

Of major importance for the isotopic composition of  $\text{CO}_2$  in the atmosphere is the fact that dissolved  $\text{CO}_2$  may exchange an  $^{18}\text{O}$  atom with water according to the isotopic equilibrium reaction (1):



where O stands for  $^{16}\text{O}$ , the dominant oxygen isotope.

When reaction (1) occurs in nature, there is more water than  $\text{CO}_2$  by several orders of magnitude. This implies that  $\delta^{18}\text{O}$  of  $\text{CO}_2$  is entirely determined by  $\delta^{18}\text{O}$  of the reacting water, whereas  $\delta^{18}\text{O}$  of water is negligibly altered by the reaction. For  $\text{CO}_2$  isotopically equilibrated with water according to reaction (1), the equilibration factor  $\alpha_{\text{eq}}$  is defined as

$$\alpha_{\text{eq}}(T) = \frac{^{18}\text{O}/^{16}\text{O} \text{ ratio of } \text{CO}_2 \text{ after equilibration}}{^{18}\text{O}/^{16}\text{O} \text{ ratio of reacting } \text{H}_2\text{O}} \quad (2)$$

We use the value of  $\alpha_{\text{eq}}(T)$  determined by Brenninkmeier et al. [1983].

$$\alpha_{\text{eq}}(T) = \left( 1 + \frac{\varepsilon_{\text{eq}}}{1000} \right)$$

with

$$\varepsilon_{\text{eq}} = 17604/T - 17.93$$

At 25°C,  $\varepsilon_{\text{eq}} = +41.11\%$  and  $d\varepsilon_{\text{eq}}/dT = -0.20\% \text{ } ^\circ\text{C}^{-1}$ .

Direct isotopic exchange between  $\text{CO}_2$  and  $\text{H}_2\text{O}$  vapor is excluded because the rate of hydration is slow (several minutes) and only a very small fraction of  $\text{CO}_2$  is dissolved in liquid water at any time [Francey and Tans, 1987]. However, the enzyme carbonic anhydrase (CA), ubiquitous in plant tissues, catalyzes the hydration and strongly accelerates the rate of reaction (1) [Silverman, 1982]. In living plant tissues the isotopic equilibrium between  $\text{CO}_2$  and  $\text{H}_2\text{O}$  is reached quasi-instantaneously. Little is known of CA activity in soils, but  $\text{CO}_2$  produced from decaying plant tissues remains in contact with soil water for sufficient time (see below) for reaction (1) to occur and most likely yield full isotopic equilibration of  $\text{CO}_2$  with water, even in the absence of CA. The  $\delta^{18}\text{O}$  of  $\text{CO}_2$  in leaves and in soils can therefore be predicted by reaction (1), provided we know the  $\delta^{18}\text{O}$  of water reacting with  $\text{CO}_2$  and the temperature of reaction.

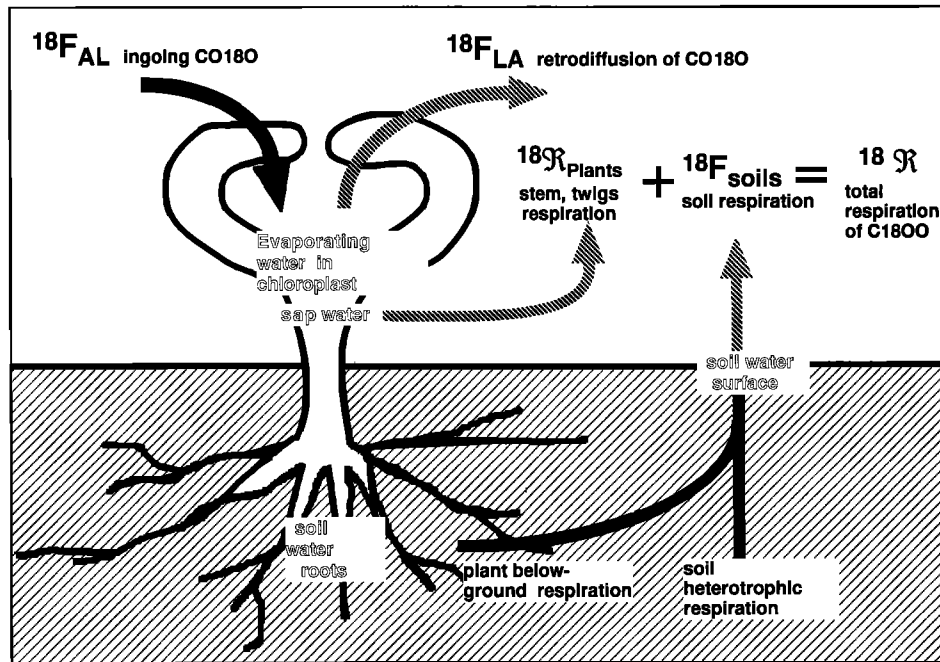
One difficulty is to clearly identify the isotopic composition of water that exchanges isotopically with  $\text{CO}_2$ . Thus it is important to characterize precisely in which leaf organ and in which soil compartment the isotopic reaction of  $\text{CO}_2$  with water occurs [e.g., Yakir et al., 1994]. Generally, such information is not directly available from experiments, and we have to make a few arbitrary but reasonable assumptions in order to calculate the surface fluxes of  $^{18}\text{O}$  in  $\text{CO}_2$ . In the following, we detail the parameterization of the isotopic exchange with the biospheric and oceanic reservoirs and the isotopic character of  $\text{CO}_2$  derived from fossil fuel burning. The  $\text{CO}_2$  oxygen isotope fluxes with the land biota are shown in Figure 1b.

## 3. Isotopic Exchange in Soils

Processes which oxidize carbon in soils usually cause  $\text{CO}_2$  levels to be greater in the soil than in the atmosphere, by up to several thousands of parts per million [Dörr and Munnich, 1987]. A complication arises because root respiration and the decomposition of dead organic matter by microorganisms emit  $\text{CO}_2$  at various depths. However, even without catalysis of the reaction (1) by the enzyme CA,  $\text{CO}_2$  would diffuse upward slowly enough to fully exchange  $^{18}\text{O}$  with water in the soil.

From the diffusivity ( $D$ ) of  $\text{CO}_2$  in soils,  $D = \kappa \varepsilon_0 (1 - \beta) D_a$  [Hesterberg and Siegenthaler, 1991], with  $\varepsilon_0$  the dry porosity (0.5),  $(1 - \beta)$  the air-filled pore fraction of the soil (0.20),  $\kappa$  the tortuosity (0.66), and  $D_a$  the diffusivity of  $\text{CO}_2$  in air ( $0.15 \text{ cm}^2 \text{ s}^{-1}$ ), we estimate that the average time taken by a  $\text{CO}_2$  molecule emitted at  $x = 30 \text{ cm}$  depth to reach the atmosphere is 6 hours ( $t = x^2/4D$ ) (the tortuosity accounts for the fact that the shortest path of  $\text{CO}_2$  can be blocked by soil particles). This is much longer than the time necessary for the hydration of  $\text{CO}_2$  in the soil pores  $\approx k_0 \varepsilon_0 \beta$  which is approximately 7 min, given  $k_0$  the rate of hydration in bulk water at 10°C ( $6.9 \cdot 10^{-3} \text{ s}^{-1}$ ). This holds if the Bunsen (volumetric) solubility coefficient is close to 1, which is true for  $\text{CO}_2$ . Practically, this means that  $\text{CO}_2$  equilibrates with water within the top 4 cm of soils, whatever its original isotopic composition at depth. In the presence of active CA in soil organic matter the isotopic exchange would be even much faster.

Thus we calculate  $\delta^{18}\text{O}$  of  $\text{CO}_2$  in soils from surface ground temperature and from  $\delta^{18}\text{O}$  of water at the soil surface, which is derived from meteoric water [Jouzel et al., 1987]. Consequently,  $\delta^{18}\text{O}$  of  $\text{CO}_2$  respired by soils is expected to follow the seasonal changes in the isotopic composition of precipitation and in temperature. The respired flux of species  $\text{CO}^{18}\text{O}$  is given by



**Figure 1b.** The pertinent  $^{18}\text{O}$  exchange fluxes. Atmospheric  $\text{CO}_2$  entering the leaves reacts isotopically with water in the chloroplast and is retrodiffused with a different isotopic label;  $\text{CO}_2$  produced in the soils by roots and decomposers reacts isotopically with water at the ground surface, roughly the top 4–5 cm (see text).

$$^{18}F_{soils} = \alpha_s R_s F_{soils} \quad (3)$$

$F_{soils}$  is the flux of  $\text{CO}_2$  emitted by soils (sum of plant below-ground respiration and soil heterotrophic respiration as in Figure 1b);  $R_s$  is  $^{18}\text{O}/^{16}\text{O}$  ratio of  $\text{CO}_2$  equilibrated with surface groundwater;  $\alpha_s = 1 + (\epsilon_s/1000)$  is the fractionation of  $^{18}\text{O}$  during diffusion between the soil surface and the atmosphere. We infer  $\epsilon_s = -5\%$  from the global budget of atmospheric  $\delta^{18}\text{O}$  (see section 7).

### 3.1. $\text{CO}_2$ Exchange Fluxes

It is important to note that the flux of  $\text{CO}_2$  respired below-ground,  $F_{soils}$ , includes both root respiration and heterotrophic respiration. Whatever the  $\delta^{18}\text{O}$  of  $\text{CO}_2$  produced at depth, its final  $\delta^{18}\text{O}$  is determined by the isotopic composition of water at the surface of the soil. Additionally, a small fraction of the plant respiration flux is emitted aboveground by stems and twigs. We assume that  $\text{CO}_2$  in stems is in isotopic equilibrium with water and that stem water  $\delta^{18}\text{O}$  is identical to groundwater  $\delta^{18}\text{O}$  because of negligible fractionation during the uptake of water by roots and the ascent of sap. The fact that there is almost no difference between  $\delta^{18}\text{O}$  of groundwater and of water in the plants organs, leaves excepted, has been clearly demonstrated by *Bariac et al.* [1994a, b]. Consequently, we can treat the isotopic exchange of  $\text{CO}_2$  respired by stems in the same manner as  $\text{CO}_2$  respired belowground, which means that  $F_{soils}$  in (3) must be augmented by the stem respiration flux. In other words, we replace  $F_{soils}$  by the total respiration flux  $R$  defined in Figure 1a.

### 3.2. The $\delta^{18}\text{O}$ of Water in Soils

Assuming isotopic equilibrium of  $\text{CO}_2$  with water at the soil surface, we have

$$R_s = \alpha_{eq}(T_s) R_s^w \quad (4)$$

where  $R_s^w$  is  $^{18}\text{O}/^{16}\text{O}$  ratio of surface groundwater and  $T_s$  is surface ground temperature.

In (4) we use the temperature fields predicted by the GCM. The isotopic composition of surface groundwater  $R_s^w$  is very close to that of meteoric water, which we take from the Goddard Institute for Space Studies (GISS) GCM [Jouzel *et al.*, 1987] (see Appendix A for details). Alternatively, we could have used a global regression of the available data for  $\delta^{18}\text{O}$  of meteoric water [International Atomic Energy Agency (IAEA), 1981] as proposed by *Farquhar et al.* [1993], but we prefer the GISS simulation for consistency because our modeling of canopy processes (section 4) also requires the use of the field of  $\delta^{18}\text{O}$  in water vapor as calculated by the GISS model, for which there is no global data set. The annual mean  $\delta^{18}\text{O}$  in meteoric water calculated by *Jouzel et al.* [1987] is nevertheless in satisfactory agreement with the data of the IAEA global network [IAEA, 1981]. However, over South America and Africa, the GISS GCM may underestimate  $\delta^{18}\text{O}$  in precipitation by 2–3% [Jouzel *et al.*, 1987].

Plate 1a shows the annual mean  $\delta^{18}\text{O}$  in surface groundwater,  $R_s^w$ . This variable, following  $\delta^{18}\text{O}$  in meteoric water, decreases at high latitudes and over continental areas because the heavy isotope of water is progressively removed by condensation from air masses initially formed over the ocean and advected inland. Owing to large-scale circulation patterns and to temperature, the lowest values of  $\delta^{18}\text{O}$  in surface groundwater occur over inland North America and over Siberia, with an average decrease of  $-14\%$  between the equator and the arctic (ice sheets excepted).

Plate 1b shows the isotopic composition of  $\text{CO}_2$  in the soil surface layer (i.e.,  $\text{CO}_2$  exchanged between the surface groundwater and the atmosphere). Common features with the map of  $\delta^{18}\text{O}$  in surface groundwater include depletion of  $^{18}\text{O}$  at high latitudes. However, the latitudinal dependence of the factor

$\alpha_{\text{eq}}$  in (4) opposes the latitudinal profile of  $\delta^{18}\text{O}$  in groundwater: colder temperatures at high latitudes increase the value of  $\alpha_{\text{eq}}$  (i.e., produce an isotopic enrichment of  $\text{CO}_2$ ). As a result, the  $\delta^{18}\text{O}$  difference in soil  $\text{CO}_2$  between the tropics and the high northern latitudes is only of  $-7\text{‰}$  (Plate 1b), compared to  $-14\text{‰}$  for  $\delta^{18}\text{O}$  in soil water.

#### 4. Isotopic Conversion in Leaves

Tans *et al.* [1986] first suggested that the isotopic exchange of  $\text{CO}_2$  and water in leaves may exert a large control on  $\delta^{18}\text{O}$  in atmospheric  $\text{CO}_2$  to explain the observed isotopic depletion of the atmosphere at high northern latitudes. The role of leaves was further quantified by extending the physiological properties of different kinds of plants to global ecosystems [Farquhar *et al.*, 1993]. These interpretations rely on the assumption that  $\text{CO}_2$  equilibrates instantly with water in leaves because CA is ubiquitous. The presence of CA guarantees fast isotopic equilibrium, whereas without CA,  $\text{CO}_2$  diffusing from the mesophyll cell would not reach full equilibrium. Given  $D_w$  the diffusivity of  $\text{CO}_2$  in water ( $1.5 \cdot 10^{-5} \text{ cm}^{-2} \text{ s}^{-1}$  at  $10^\circ\text{C}$ ), the average time to cross a distance  $x = 10^{-5} \text{ m}$  within the mesophyll cell (from the site of carboxylation to the stomatal cavity) is roughly  $0.02 \text{ s}$  ( $t = x^2/4D_w$ ), much less than the time required for hydration of  $\text{CO}_2$  in bulk water, approximately 3 min at  $10^\circ\text{C}$ . Note also that only isotopic exchange with water inside the leaf is considered and that we do not treat the exchange with dew or with water intercepted by the canopy.

Interactions with leaf water involve an even larger flux of  $\text{CO}_2$  than the gross photosynthetic rate of carbon assimilation. All of the atmospheric  $\text{CO}_2$  which enters the leaf undergoes hydration and isotopic equilibration with water, but less than half of that  $\text{CO}_2$  is fixed, with the remainder returning to the atmosphere. The exchange of  $\text{CO}^{18}\text{O}$  is therefore fundamentally different from other  $\text{CO}_2$  exchange. Only the net ecosystem flux of  $\text{CO}_2$  is needed for the simulation of  $\text{CO}_2$  concentrations and  $^{13}\text{C}/^{12}\text{C}$  isotope ratios in the atmosphere. With respect to  $\delta^{18}\text{O}$  in atmospheric  $\text{CO}_2$ , however, the gross leaf exchange is very important because retrodiffused  $\text{CO}_2$  carries an isotopic label distinct from  $\text{CO}_2$  going into the leaf (Figure 1b). The net flux of  $\text{C}^{18}\text{OO}$  which interacts with the  $^{18}\text{O}$  reservoir of leaf water is given by

$$^{18}F_{\text{Leaves}} = -\alpha_d R_a F_{\text{aL}} + \alpha_d R_L F_{\text{La}} \quad (5)$$

The equivalent net flux of  $\text{CO}_2$  is

$$A = -F_{\text{aL}} + F_{\text{La}} \quad (6)$$

where

- $A$  assimilation rate of carbon ( $<0$ );
- $R_L$   $^{18}\text{O}/^{16}\text{O}$  ratio of  $\text{CO}_2$  in isotopic equilibrium with leaf water;
- $R_a$   $^{18}\text{O}/^{16}\text{O}$  ratio of  $\text{CO}_2$  in the atmosphere at the leaf surface;
- $F_{\text{aL}}$  mean flux of  $\text{CO}_2$  entering the leaf ( $\text{CO}_2$  which crosses the stomate and further diffuses to the chloroplast but without being reduced by photosynthesis), defined as a positive quantity;
- $F_{\text{La}}$  mean flux of retrodiffused  $\text{CO}_2$  ( $\text{CO}_2$  which diffuses back to the atmosphere), defined as a positive quantity;
- $\alpha_d$  kinetic fractionation of  $\text{C}^{18}\text{OO}$  for diffusion in air, identical to  $1 + (\epsilon_d/1000)$  ( $\epsilon_d = -8.8\text{‰}$ ).

Equation (5) can be rewritten as

$$^{18}F_{\text{Leaves}} = \alpha_d R_a A - \alpha_d F_{\text{La}} (R_a - R_L) \quad (7)$$

Equation (7) formally separates the isotopic exchange of  $\text{CO}_2$  between leaves and atmosphere into two terms. The left-hand member represents the isotopic fractionation associated with the net flux into the leaves. It represents  $\text{CO}_2$  that is almost matched isotopically with the atmospheric value (proportional to  $R_a$ ), thus having a very limited influence on it. The right-hand member is an "isotopic disequilibrium flux," proportional to the  $^{18}\text{O}/^{16}\text{O}$  difference in  $\text{CO}_2$  between the leaves and the atmosphere and therefore exerting a strong control on the atmospheric signature. In the following, we detail the expression of each variable in (7), starting with the  $\text{CO}_2$  exchange fluxes represented in Figure 1a.

##### 4.1. $\text{CO}_2$ Exchange Fluxes

The gross assimilation rate of  $\text{CO}_2$  ( $A$ ) is given by

$$A = -g_s (C_a - C_c) \quad (8)$$

where  $C_c$  is  $\text{CO}_2$  concentration inside the leaf,  $C_a$  is  $\text{CO}_2$  concentration in the air outside the leaf, and  $g_s$  is stomatal conductance.

The flux  $A$  is the net assimilation of carbon, in other words, the amount of  $\text{CO}_2$  that is reduced by photosynthesis and stored into plant assimilates.  $A$  is the difference between the GPP and the leaf respiration ( $\mathfrak{R}_d$ ). Thus leaf respiration is part of the retrodiffused flux  $F_{\text{La}}$ . Globally,  $\mathfrak{R}_d$  consumes about 12% of annual GPP in the model, so  $A = 88\%$  of GPP. Also, we treat the full diffusive path of  $\text{CO}_2$  from outside the leaf to the site of carboxylation using one single conductance,  $g_s$ , here called "stomatal conductance" which accounts in fact for the diffusion of  $\text{CO}_2$  through the leaf aerodynamic boundary layer, the stomate, and the recess of stomatal cavities. We use fields of  $A$  and  $C_c$  calculated by SiB2, as detailed in Appendix B [Sellers *et al.*, 1996a; Randall *et al.*, 1996; Denning *et al.*, 1996]. The one-way gross fluxes  $F_{\text{La}}$  and  $F_{\text{aL}}$  of (7) are expressed by

$$F_{\text{aL}} = g_s C_a \quad F_{\text{La}} = g_s C_c \quad (9)$$

Substituting for  $g_s$  from (8) into (9) yields

$$F_{\text{aL}} = -\frac{C_a}{(C_a - C_c)} A \quad F_{\text{La}} = -\frac{C_c}{(C_a - C_c)} A \quad (10)$$

A global estimate of fluxes in (7) is possible since it is commonly observed that  $C_c \approx 2/3 C_a$  for C3 plants (see Table 1), which yields  $F_{\text{aL}} \approx 3A$  and  $F_{\text{La}} \approx 2A$ . We find that  $F_{\text{aL}}$  and  $F_{\text{La}}$ , equal  $22.7$  and  $14.2 \text{ Pmol yr}^{-1}$ , respectively, with  $A \approx 8.5 \text{ Pmol yr}^{-1}$  from SiB2. The fluxes  $F_{\text{aL}}$  and  $F_{\text{La}}$  of  $\text{CO}_2$  are enormous. They imply that every molecule of  $\text{CO}_2$  in the atmosphere has only a 14% chance to be actually assimilated by photosynthesis against a 40% chance to enter a leaf within a year!

The flux calculations presented here were conducted off-line using monthly mean fields of parameter values calculated by SiB2, as detailed in Appendix B [Sellers *et al.*, 1996a; Randall *et al.*, 1996; Denning *et al.*, 1996]. The carbon and water budget of the land surface is calculated explicitly and interactively by the SiB2 model coupled to the CSU GCM. This approach has the advantage that monthly means reflect well-resolved diurnal cycles of the relevant variables in a dynamically consistent way. The disadvantage is that one has to rely on the climate simulated by the CSU GCM rather than on observations.

**Table 1.** Notations and Principal Fractionations, Diagnostics, and Physiological Variables That Enter in the  $\delta^{18}\text{O}$  Sources

$\text{CO}_2$ Fluxes*	Description	Global Mean	Unit of Measure
$F_{aL}$	atmospheric $\text{CO}_2$ entering the leaf	22.7	Pmol $\text{CO}_2$
$F_{La}$	$\text{CO}_2$ retrodiffused out of the leaf	14.2	Pmol $\text{CO}_2$
$F_{soils}$	$\text{CO}_2$ efflux from soils, augmented by stems and twigs	8.5	Pmol $\text{CO}_2$
$A$	respiration (equals total respiration) net carbon assimilation rate (gross primary productivity minus leaf respiration)	8.5	Pmol $\text{CO}_2$
$F_{oa}$	gross $\text{CO}_2$ transfer from ocean to atmosphere	7.5	Pmol $\text{CO}_2$
$F_{ao}$	gross $\text{CO}_2$ transfer from atmosphere to ocean	7.7	Pmol $\text{CO}_2$
$F_o$	net air-sea flux of $\text{CO}_2$	167	Tmol $\text{CO}_2$
$F_f$	fossil $\text{CO}_2$ emissions	500	Tmol $\text{CO}_2$
$F_{bur}$	biomass burning $\text{CO}_2$ emissions	283	Tmol $\text{CO}_2$

Physical and Physiological Variables	Description	Global Mean	Unit of Measure
$h$	leaf surface relative humidity	0.8	
$T_L$	leaf temperature	12.1	$^{\circ}\text{C}$
$T_s$	ground surface temperature	12.0	$^{\circ}\text{C}$
$T_o$	sea surface temperature	17.9	$^{\circ}\text{C}$
$C_i$	$\text{CO}_2$ mixing ratio inside leaf		
	average for C3 plants only	220	ppm
	average for C4 plants only	113	ppm
	average for both C3 and C4	195	ppm

Atmospheric $\delta^{18}\text{O}$ and $\text{CO}_2$ Mixing Ratios	Description		
$\delta_a, C_a$	$\delta^{18}\text{O}, \text{CO}_2$ in the atmosphere		
$\delta_L, C_L$	$\delta^{18}\text{O}, \text{CO}_2$ resulting from leaf exchange		
$\delta_s, C_s$	$\delta^{18}\text{O}, \text{CO}_2$ resulting from soil exchange		
$\delta_o, C_o$	$\delta^{18}\text{O}, \text{CO}_2$ resulting from ocean exchange		
$\delta_b, C_b$	$\delta^{18}\text{O}, \text{CO}_2$ resulting from biomass burning		
$\delta_f, C_f$	$\delta^{18}\text{O}, \text{CO}_2$ resulting from fossil fuel emissions		

Fractionation Factors of Oxygen Isotope	Description	$\epsilon = (\alpha - 1)10^{-3}, \text{‰}$	Comments
$\alpha_{eq}$	fractionation of $\text{CO}^{18}\text{O}$ in the isotopic reaction with water	+41.15	Equilibrium value at $25^{\circ}\text{C}$
$\alpha_s$	fractionation of $\text{CO}^{18}\text{O}$ during diffusion from the soil surface to the atmosphere	-5	Molecular and turbulent diffusion
$\alpha_d$	fractionation of $\text{CO}^{18}\text{O}$ during diffusion between the chloroplast and the atmosphere	-8.8	Molecular diffusion
$\alpha_w$	fractionation of $\text{CO}^{18}\text{O}$ during diffusion and hydration in water	+0.8	
$\alpha_{L-vap}^w$	fractionation of $\text{H}_2^{18}\text{O}$ with respect to the liquid phase during the Liquid $\rightarrow$ vapor phase transition	+9.39	Equilibrium value at $25^{\circ}\text{C}$
$\alpha_k^w$	fractionation of $\text{H}_2^{18}\text{O}$ during the diffusion of water vapor from inside the leaf to the air	-26.3	Molecular and turbulent diffusion
$\Delta_a$	discrimination of $^{18}\text{O}$ by leaf exchange	7.22	Global average value weighted by monthly GPP ( $A$ )

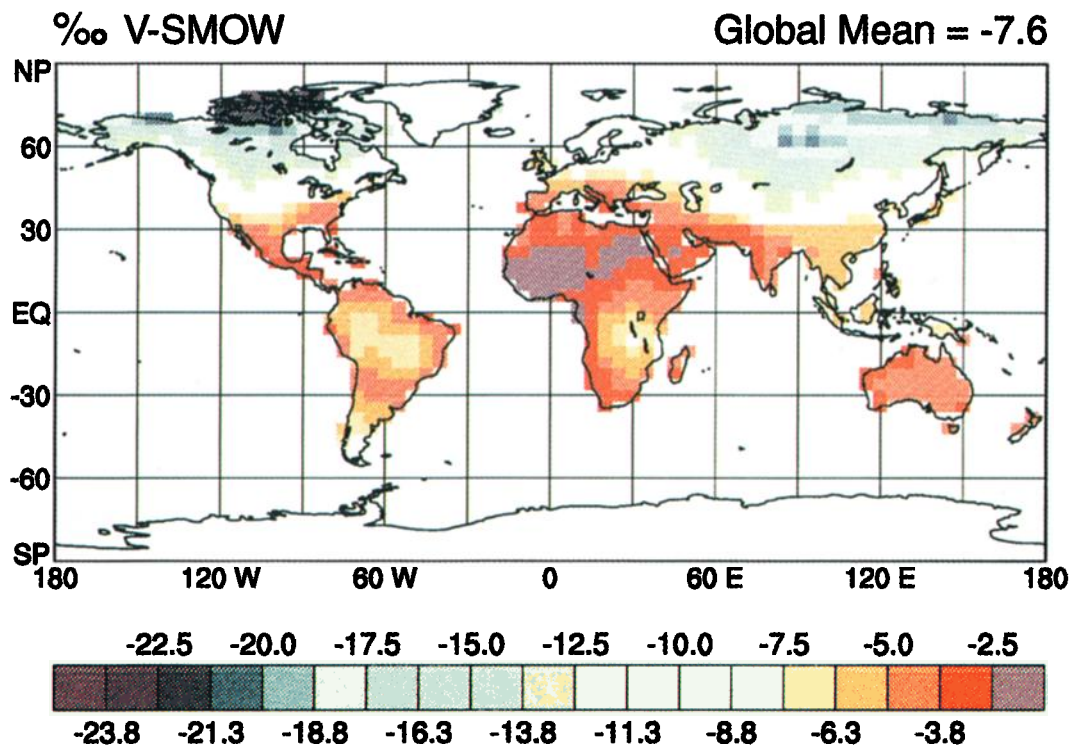
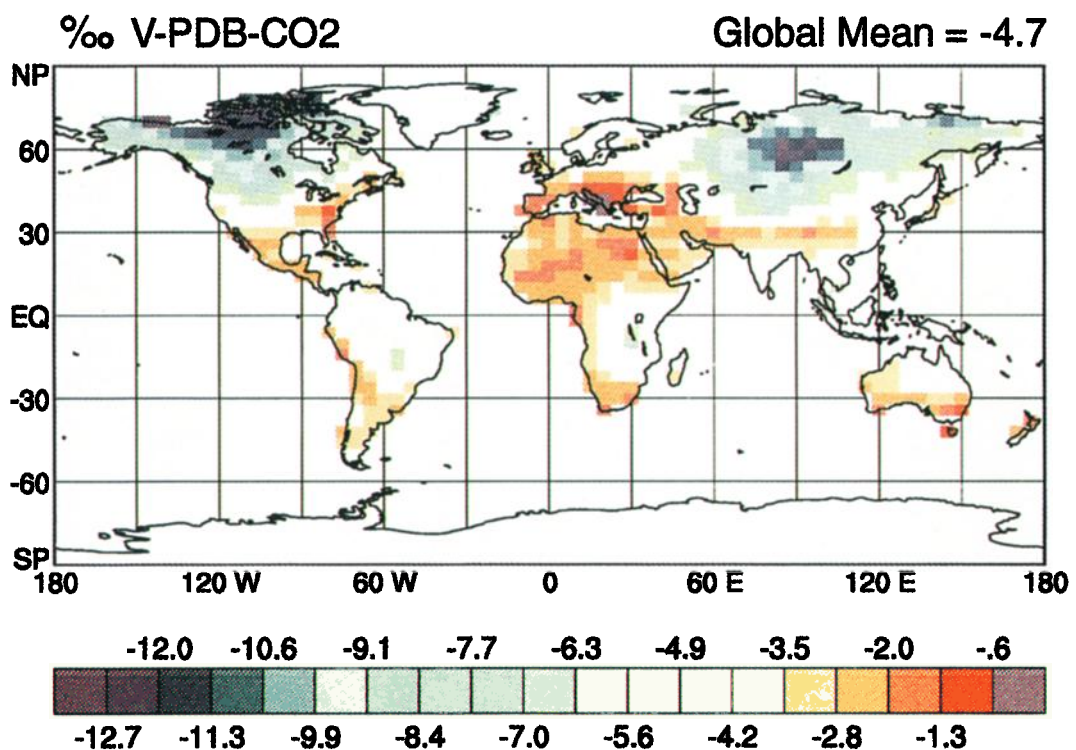
Isotopic Ratios†	Description	Global Mean, $\text{‰}$	Comments
$R_a$	atmospheric $\text{CO}_2$	0.18	PDB- $\text{CO}_2$ scale
$R_s$	$\text{CO}_2$ in isotopic equilibrium with surface groundwater	-5.15	
$R_L$	$\text{CO}_2$ in isotopic equilibrium with leaf water	3.27	
$R_o$	$\text{CO}_2$ in isotopic equilibrium with ocean surface water	+1.75	
$R_f$	$\text{CO}_2$ produced by combustion with atmospheric $\text{O}_2$	-17	
$R_p^w$	meteoric water over continents	-7.88	VSMOW scale
$R_s^w$	surface groundwater	-7.55	
$R_z^w$	intermediate (root zone) groundwater	-7.55	
$R_l^w$	evaporating water in leaves	0.40	
$R_{vap}^w$	water vapor in the canopy	-17.9	
$R_o^w$	ocean surface water	0.26	

\*The same notations with an exponent 18 are used for the  $\text{CO}^{18}\text{O}$  surface fluxes.

†The same subscripts are used for  $\delta$ .

Some of the calculations in this study required special averaging to avoid errors due to nonlinear interactions. For example, because  $C_c$  covaries with  $A$ , the calculated monthly sum of  $F_{La}$  (equation (10)) would be expected to be very different if

evaluated as the sum of every time step for a month, or if evaluated using the mean monthly values of  $C_c$ ,  $C_a$ , and  $A$  for that month. In other words, the mean of the product of terms is not equal to the product of the means of those terms. The

a)  $\delta^{18}\text{O}$  in Surface Ground Waterb)  $\delta^{18}\text{O}$  in  $\text{CO}_2$  at the Soil Surface

**Plate 1.** (a) Surface groundwater annual mean  $\delta^{18}\text{O}$  determined from the isotopic composition of meteoric water in the NASA GISS isotopic GCM, after Jouzel *et al.* [1987] and Appendix A. (b) Annual mean isotopic composition of  $\text{CO}_2$  at the soil surface assuming full isotopic equilibrium with surface groundwater. The  $\delta^{18}\text{O}$  of  $\text{CO}_2$  in soils, mediated by the respiration efflux, directly influences the atmospheric  $\delta^{18}\text{O}$ .

correct answer can be calculated on-line, or off-line by using an average value of  $C_c$  weighted for the value of  $A$  in each time step. We did the latter. The product  $A$  by  $C_c$  was calculated at each time step of the GCM run (excluding times when  $A$  was negative). This product was summed for the averaging period and divided by the sum of  $A$  for that period, yielding a flux-weighted average. Canopy temperature was similarly weighted for physiological activity. We are aware of additional possibilities for nonlinear averaging errors in the use of mean monthly GCM fields for calculation of isotopic fluxes (for example, the time average humidity at the leaf surface was used, and we recognize that this should ideally be weighted for the rate of  $\text{CO}_2$  exchange). It would obviously be best to include all of these calculations explicitly in the model. This will be done in a future study.

#### 4.2. The $\delta^{18}\text{O}$ in Leaf $\text{CO}_2$

We calculate the  $^{18}\text{O}/^{16}\text{O}$  ratio of leaf  $\text{CO}_2$ ,  $R_L$ , based on  $R_L^w$  the isotopic composition of evaporating leaf water (see below), assuming that  $\text{CO}_2$  reaches full isotopic equilibration with water evaporating in the mesophyll cells at leaf temperature  $T_L$  [Farquhar et al., 1993]:

$$R_L = \alpha_{\text{eq}}(T_L) R_L^w \quad (11)$$

A recent set of experiments by Yakir et al. [1994] suggests that  $\text{CO}_2$  may not in reality exchange isotopically with evaporating water but with a pool of leaf water which is at an intermediate isotopic state between evaporating water at  $\delta_L^w$  and water supplied to the leaf by roots at  $\delta_r^w$ . If this is confirmed, we would then infer leaf  $\text{CO}_2$  to be too enriched by following Farquhar et al. [1993].

Evaporating water in leaves is enriched in  $^{18}\text{O}$ . At steady state, and for a constant leaf water volume, the evaporating leaf water  $^{18}\text{O}/^{16}\text{O}$  ratio  $R_L^w$  is given by [Craig and Gordon, 1965]

$$R_L^w = \alpha_{L-\text{vap}}^w \left( \frac{(1-h) R_i^w}{\alpha_k^w} + h R_{\text{vap}}^w \right) \quad (12)$$

Using the  $\delta$  notation, (12) can also be written as

$$\delta_L^w = \varepsilon_{L-\text{vap}}^w + (1-h)(\delta_r^w - \varepsilon_k^w) + h \delta_{\text{vap}}^w \quad (12')$$

where

- $h$  relative humidity at the leaf surface;
- $\alpha_{L-\text{vap}}^w$  fractionation of  $\text{H}_2^{18}\text{O}$  for the liquid-vapor phase transition, equal to  $1 + (\varepsilon_{L-\text{vap}}^w/1000) \equiv R_L^w/R_{\text{vap}}^w$ ;
- $\alpha_k^w$  kinetic fractionation of  $\text{H}_2^{18}\text{O}$  versus  $\text{H}_2^{16}\text{O}$  in the diffusion of water vapor across the stomatal cavity and leaf boundary layer, equal to  $1 + (\varepsilon_k^w/1000)$ ;
- $R_{\text{vap}}^w$   $^{18}\text{O}/^{16}\text{O}$  ratio of water vapor in the air outside the leaf;
- $R_i^w$   $^{18}\text{O}/^{16}\text{O}$  ratio of groundwater which is taken up by roots.

The first important parameter in (12') is  $\delta_r^w$ , the  $\delta^{18}\text{O}$  of groundwater delivered to the leaf. At steady state an equivalent amount of water delivered to the leaf and lost by transpiration must be pumped from the soil by the root system. Following the hypothesis of the SiB2 model soil hydrology, we consider that the roots pump groundwater from an intermediate soil layer beneath the surface (Figure A1 in Appendix A). Assuming that no isotopic fractionation occurs during the root uptake of water [Bariac et al., 1994b], we calculate  $\delta_r^w$  from the

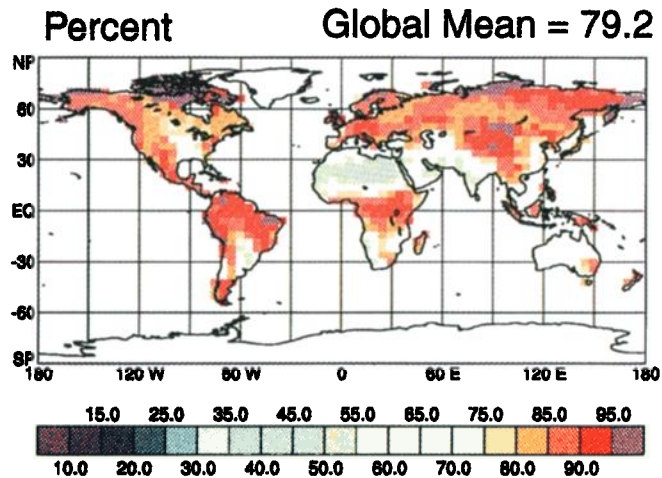
$\delta^{18}\text{O}$  of meteoric water and from the soil water fluxes in SiB2 through a mass balance of groundwater isotopes as described in Appendix A.

A second important parameter in (12') is the kinetic fractionation of water vapor in leaves  $\varepsilon_k^w$ , which bears a large uncertainty. The value of  $\varepsilon_k^w$  is greater for molecular diffusion ( $-28.5\%$ ) [Merlivat, 1978] than for turbulent diffusion and may thus be species specific [White, 1983] and depend on the wind velocity [Förstel et al., 1975]. However, this source of uncertainty is diminished by the fact that  $\varepsilon_k^w$  is multiplied by a factor of  $(1-h)$  which takes on low values almost everywhere (Plate 2a). The only exceptions correspond to dry areas, but these regions are usually associated with very small  $\text{CO}_2$  fluxes (negligible GPP). We have taken  $\varepsilon_k^w = -26.3\%$  [Farquhar et al., 1989] constant everywhere. A detailed study of the sensitivity of  $\delta^{18}\text{O}$  in atmospheric  $\text{CO}_2$  to  $\varepsilon_k^w$  will be presented elsewhere.

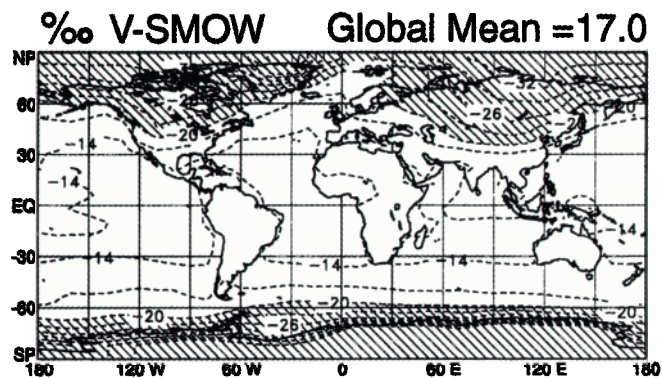
The third important parameter in (12) is  $\delta^{18}\text{O}$  in the canopy water vapor. Because there are only sparse measurements of this quantity around the world, we use the GISS GCM simulation at ground level as plotted in Plate 2b. As pointed out in section 3.2, consistency dictates that we also use  $\delta^{18}\text{O}$  of surface groundwater (close to meteoric water) from the same model since the difference between these fields enters in (12'). The condensation processes which form the precipitation in clouds follow an isotopic fractionation which systematically depletes  $^{18}\text{O}$  in the vapor with respect to the precipitation. On average,  $\delta^{18}\text{O}$  in water vapor is lower than  $\delta^{18}\text{O}$  in meteoric water by about 10‰. One large source of uncertainty is that the  $\delta^{18}\text{O}$  of the vapor in open air from the GISS GCM may not be representative of the situation in forest canopies. This source of uncertainty is augmented in (12') by the fact  $\delta^{18}\text{O}$  of water vapor is multiplied by the relative humidity at the leaf surface, which is generally close to unity within the leaf boundary layer (Plate 2a). In canopies, substantial quantities of water vapor are derived from plant transpiration with an isotopic label identical to groundwater (10‰ above the tropospheric vapor value). To the extent that water in the canopy air space reflects this source, the  $\delta^{18}\text{O}$  in water vapor inferred from the GISS model is probably too low. From isotopic measurements in water vapor over a grassland in Switzerland, Jacob and Sonntag [1991] suggest that the share of vapor released by plants varies between 15% in winter and 80% in July–September. Measurements in a temperate forest by White and Gedzelman [1984] suggest that the relative humidity can be used to distinguish between free tropospheric vapor ( $\delta^{18}\text{O} \rightarrow \delta_{\text{vap atm}}^w$ ) in the limit  $h \rightarrow 0$  and plant transpired vapor ( $\delta^{18}\text{O} \rightarrow \delta_r^w$ ) in the limit  $h \rightarrow 1$ . We did not extrapolate this empirical regression to the global level to correct  $\delta^{18}\text{O}$  of vapor in canopy, however. By using the GISS model fields we instead assume a lower boundary for  $\delta^{18}\text{O}$  in water vapor and hence for  $\delta^{18}\text{O}$  of  $\text{CO}_2$  in leaves.

Plate 2c shows  $\delta^{18}\text{O}$  of leaf  $\text{CO}_2$ , which decreases toward high latitudes. Over dry areas,  $\delta^{18}\text{O}$  of leaf  $\text{CO}_2$  is larger than 6‰, with a maximum over the Sahara Desert of 15‰. This is mostly due to low relative humidity which increases the value of  $\delta_L$  in (12). Note, however, that the maximum values obtained in deserts is not likely to influence the atmospheric  $\delta^{18}\text{O}$  because it is associated with a negligible exchange of  $\text{CO}_2$ . The simulated isotopic composition of leaf  $\text{CO}_2$  is as low in tropical rainforests as in Siberian forests (roughly  $-3\%$ ), despite the fact that leaf water is more depleted in  $^{18}\text{O}$  in Siberia. As

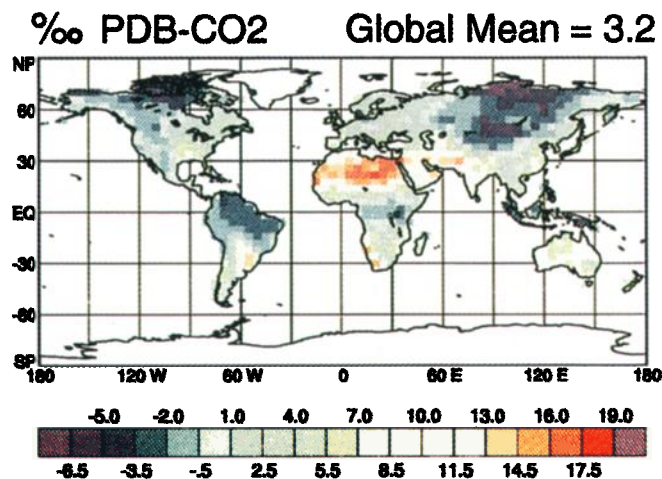
a) Relative Humidity at the Leaf Surface



b)  $\delta^{18}\text{O}$  in Water Vapor at Ground Level

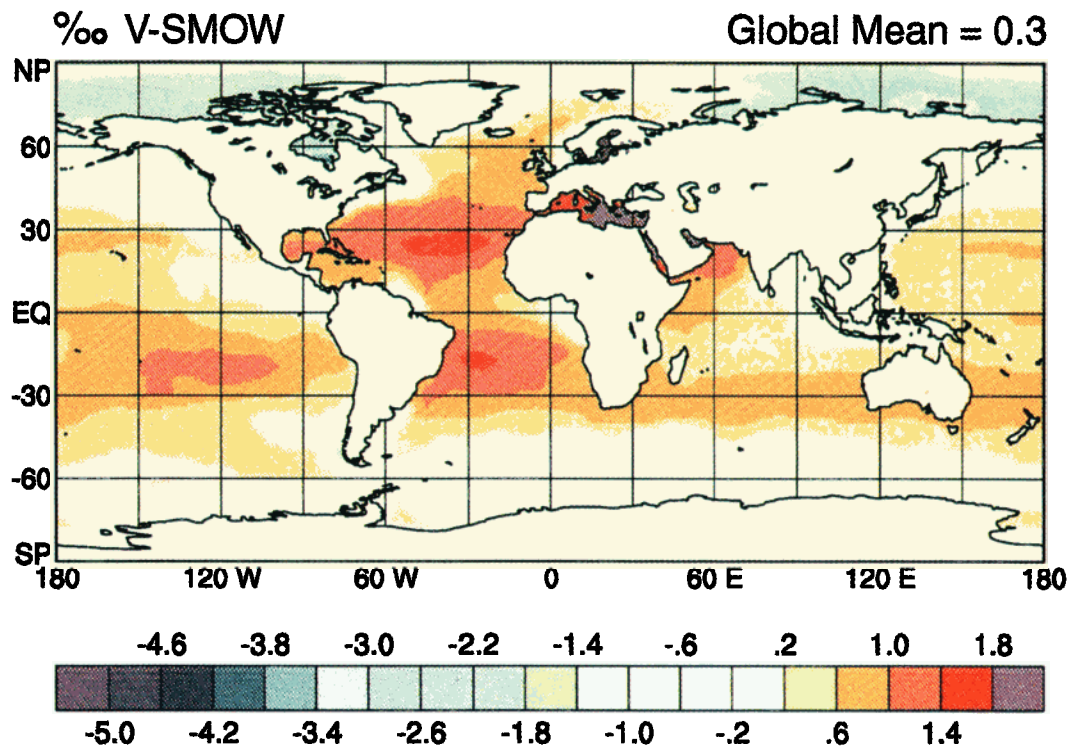


c)  $\delta^{18}\text{O}$  of  $\text{CO}_2$  in Leaves

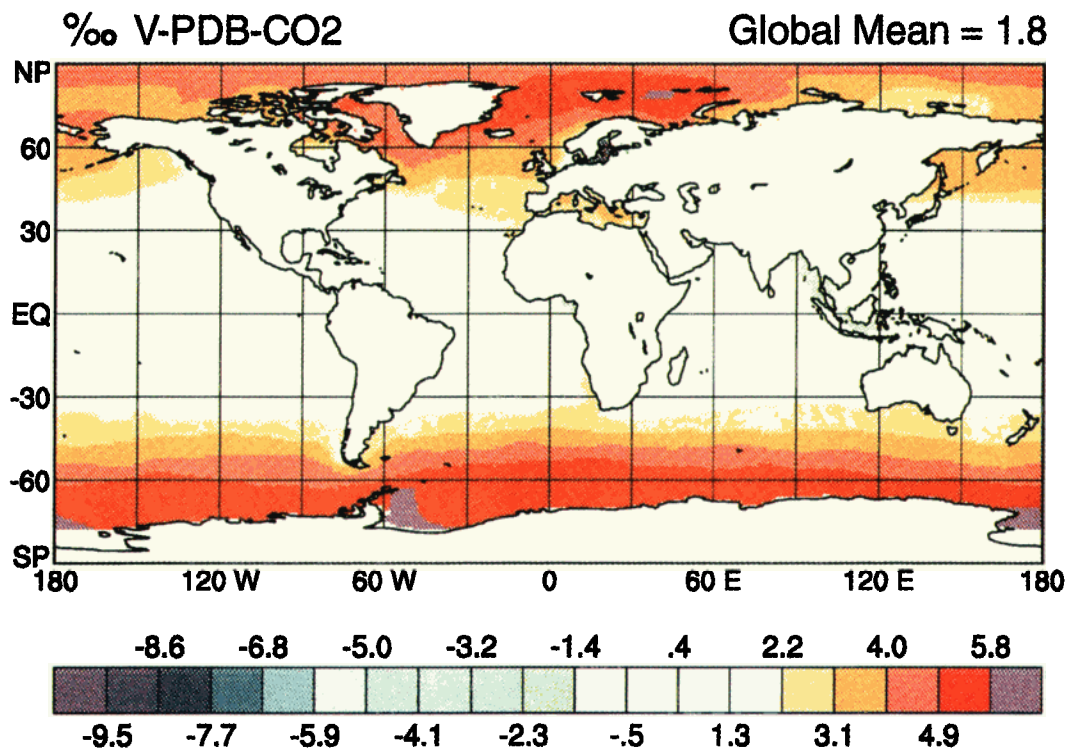


**Plate 2.** (a) Relative humidity at the leaf surface (annual average) in the photosynthesis model SiB2 coupled with the CSU climate model. Because of plant transpiration the relative humidity at the leaf surface is higher than in the free atmosphere above the canopy. (b) Annual mean  $\delta^{18}\text{O}$  of atmospheric water vapor at ground level in the NASA GISS isotopic model [after Jouzel *et al.*, 1987]. The vapor phase is isotopically depleted by  $\sim 10\text{‰}$  with respect to meteoric water due to the isotopic fractionation resulting from in-cloud condensation processes. (c) Annual mean  $\delta^{18}\text{O}$  of  $\text{CO}_2$  in leaves, that is, in isotopic equilibrium equilibrated with evaporating leaf water. This corresponds to the  $\delta^{18}\text{O}$  which influences the atmosphere, mediated by the photosynthesis flux.

a)

 $\delta^{18}\text{O}$  in Ocean Surface Water

b)

 $\delta^{18}\text{O}$  in  $\text{CO}_2$  at the Ocean Surface

**Plate 3.** (a) Ocean surface water  $\delta^{18}\text{O}$  regressed after salinity. The decrease near the ice sheets and in the rivers estuaries is due to the input to the oceans of freshwater depleted in  $^{18}\text{O}$ . (b) Isotopic composition of dissolved  $\text{CO}_2$  emitted to the atmosphere through air-sea exchange processes, assuming full isotopic equilibrium of  $\text{CO}_2$  with seawater.

outlined for soils, this is due to the effect of temperature on  $\alpha_{\text{eq}}$  and to a lesser extent on  $\alpha_{\text{L-vap}}^{\text{w}}$ .

## 5. Exchange of $^{18}\text{O}$ With the Ocean

The net  $\text{CO}_2$  flux between the ocean and atmosphere is given by

$$F_o = -F_{\text{ao}} + F_{\text{oa}} = K_{\text{ex}} \Delta p \text{CO}_2 \quad (13)$$

where  $F_{\text{ao}}$  ( $F_{\text{oa}}$ ) is the one-way flux of  $\text{CO}_2$  from (to) the atmosphere,  $K_{\text{ex}}$  is the air-sea gas exchange coefficient, and  $\Delta p \text{CO}_2$  is the difference in partial pressure of  $\text{CO}_2$  between ocean and atmosphere.

The air-sea gas exchange coefficient  $K_{\text{ex}}$  is taken from the stability dependent theoretical formulation of *Erickson* [1993]. The field of  $\Delta p \text{CO}_2$  is calculated by the ocean general circulation model HAMOCC (Max Planck Institute, Hamburg) which includes a parameterization of biological processes in the ocean [*Maier-Reimer*, 1993; K. Kurz and E. Maier-Reimer, Geochemical cycles in an ocean general circulation model: Plankton succession and seasonal  $p\text{CO}_2$ , submitted to *Global Biogeochemical Cycles*, 1996]. Note that the  $\Delta p \text{CO}_2$  fields are for the preindustrial era, which is not consistent with our simulation of today's  $^{18}\text{O}$  cycle. However, the isotopic flux proportional to the net ocean flux has only a small effect on the atmospheric  $\delta^{18}\text{O}$  value (see below) so that at this stage, using a preindustrial  $\Delta p \text{CO}_2$  field introduces only a very small bias. For consistency with our atmospheric transport model, the ocean-atmosphere  $\text{CO}_2$  fluxes are masked over regions covered by sea ice.

Regarding the isotopic fluxes, we have made the assumption that dissolved  $\text{CO}_2$  is in isotopic equilibrium with seawater according to reaction (1). We account for no catalytic process that could yield isotopic equilibration during a short contact between atmospheric  $\text{CO}_2$  and ocean water. Excluding the possibility of rapid hydration of  $\text{CO}_2$  with a time constant shorter than the crossing of the diffusive film at the air-sea interface is supported by the fact that no evidence for CA catalysis has been found so far in the ocean. The net air-sea flux of  $\text{C}^{18}\text{OO}$  has an expression similar to that for isotope  $^{13}\text{C}$  [*Tans et al.*, 1993; *Ciais et al.*, 1995] and is given by

$$^{18}F_o = -\alpha_w R_a F_{\text{ao}} + \alpha_w R_o F_{\text{oa}} \quad (14)$$

where  $\alpha_w$  is fractionation associated with  $\text{CO}_2$  diffusion at the air-sea interface [*Vogel et al.*, 1970] and  $R_o$  is  $^{18}\text{O}/^{16}\text{O}$  ratio of dissolved  $\text{CO}_2$ . Here (14) can be rewritten in the form

$$^{18}F_o = \alpha_w R_a F_o + \alpha_w (R_o - R_a) F_{\text{oa}} \quad (15)$$

The left-hand term of (14) is an isotopic "equilibrium" flux  $F_{o \text{ eq}}$ , which hardly influences the  $\delta^{18}\text{O}$  of atmospheric  $\text{CO}_2$  since it is proportional to the isotopic ratio  $R_a$ . The right-hand flux  $F_{o \text{ dis}}$  corresponds to an isotopic "disequilibrium" flux which can be interpreted as a tendency toward local isotopic balance between atmospheric  $\text{CO}_2$  and  $\delta^{18}\text{O}$  in dissolved  $\text{CO}_2$ . By definition, the isotopic ratio  $R_o$  of  $\text{CO}_2$  in isotopic equilibrium with water is given by

$$R_o = \alpha_{\text{eq}}(T_o) R_o^{\text{w}} \quad (16)$$

where  $T_o$  is sea surface temperature and  $R_o^{\text{w}}$  is  $^{18}\text{O}/^{16}\text{O}$  ratio of surface waters.

We have calculated  $R_o^{\text{w}}$  in a manner similar to that of *Farquhar et al.* [1993].  $R_o^{\text{w}}$  is a function of salinity using the em-

pirical regression initially proposed by *Craig and Gordon* [1965] and further update by J. C. Duplessy (personal communication, 1994):

$$\delta_o^{\text{w}} = a_1 + a_2 S \quad (17)$$

where  $S$  is sea surface salinity in grams per kilogram [*Levitus*, 1982].

The empirical value of the  $\delta_o^{\text{w}}$  versus  $S$  linear slope,  $a_2 = 0.5\text{‰ g}^{-1} \text{ kg}$ . The value of the intercept  $a_1 = -16.75\text{‰}$  is determined so as to yield a mean value of  $0\text{‰}$  VSMOW for  $\delta_o^{\text{w}}$  averaged over the world oceans between  $60^\circ\text{S}$  and  $60^\circ\text{N}$ , excluding polar oceans which deviate significantly from the VSMOW value. Plate 3a indicates that  $\delta_o^{\text{w}}$  takes lower values where large amounts of freshwater are delivered to the ocean, because continental freshwater is depleted in  $^{18}\text{O}$  with respect to seawater by the isotopic distillation of moist air moving from the oceans to the continents. The isotopic composition of the ocean surface is thus depleted by about  $1\text{‰}$  at high latitudes around Antarctica and Greenland because of the massive discharge of icebergs and in the estuaries of the largest rivers.

Plate 3b shows  $\delta^{18}\text{O}$  of  $\text{CO}_2$  in isotopic equilibrium with ocean water,  $\delta_o$ . The temperature dependence of the equilibrium fractionation factor  $\alpha_{\text{eq}}$  has the effect of increasing  $\delta_o$  at high latitudes by a few per mil, which opposes the latitudinal variation of  $\delta_o$ . The result is an overall increase of  $\delta_o$  as a function of latitude, with maximum values of  $5\text{--}6\text{‰}$  near the sea ice margin around Greenland and Antarctica.

## 6. Anthropogenic Emissions: Fossil Fuels and Biomass Burning

Carbon dioxide derived from the combustion of hydrogen-bound carbon bears an isotopic label of  $-17\text{‰}$  PDB- $\text{CO}_2$ , which corresponds to the isotopic value of atmospheric oxygen [*Kroopnick and Craig*, 1972]. Anthropogenic fluxes of the isotopic species  $\text{CO}^{18}\text{O}$  are thus proportional to the  $\text{CO}_2$  fluxes. For fossil  $\text{CO}_2$  emissions we used the estimates of *Marland et al.* [1985], distributed according to population density by *Fung et al.* [1987]. For biomass burning emissions, we have used a compilation of observational data which include forest and savanna burning (seasonal) as well as agricultural wastes and fuel wood burning (annually constant) [*Hao and Liu*, 1994]. We need the gross flux of  $\text{CO}_2$  resulting from biomass burning,  $F_{\text{bur}}$ , for calculating  $\delta^{18}\text{O}$  in the atmosphere, not the net deforestation flux which is significantly lower since it includes the uptake of  $\text{CO}_2$  due to regrowth of burned ecosystems [*Houghton et al.*, 1987]. Conceptually, regrowth should be treated for  $\delta^{18}\text{O}$  as an additional component of the leaf exchange flux (linked to GPP), but we neglected it, first, because it is a small flux compared to the natural components  $F_{\text{La}}$  and  $F_{\text{aL}}$  and, second, because it has a minor isotopic disequilibrium with the atmosphere:  $\delta^{18}\text{O}$  of leaf  $\text{CO}_2$  is in the range  $0\text{--}4\text{‰}$  in the tropics compared to  $-17\text{‰}$  when plants are burned:

$$^{18}F_{\text{fos}} = R_f F_{\text{fos}} \quad (18)$$

$$^{18}F_{\text{bur}} = R_f F_{\text{bur}} \quad (19)$$

where  $R_f$  is the isotopic ratio of  $\text{CO}_2$  produced by combustion ( $\delta_f = -17\text{‰}$ )

## 7. Global Budget of $\delta^{18}\text{O}$ in Atmospheric $\text{CO}_2$

Before coupling the fluxes as calculated above to a three-dimensional atmospheric transport model for calculating the

atmospheric  $\delta^{18}\text{O}$ , it is useful to test the values we have determined for the model parameters by closing the global budget. The global mean value of  $\delta^{18}\text{O}$  in the atmosphere,  $\delta_a$ , is influenced by soils, vegetation, and air-sea exchange (anthropogenic emissions are omitted). The annual mean trend of  $\delta^{18}\text{O}$  in atmospheric  $\text{CO}_2$  is close to zero [Francey and Tans, 1987] and it is given by the following expression to a good approximation [Farquhar et al., 1993]:

$$\frac{d\delta_a}{dt} = 0 \quad (20)$$

$$\frac{d\delta_a}{dt} = \frac{1}{C_a} [F_{oa}(\delta_o - \delta_a) + \epsilon_w(F_{ao} - F_{oa}) + F_{soils}(\delta_s - \delta_a + \epsilon_s) + A\Delta_a]$$

where  $\Delta_a$  stands for the discrimination of oxygen isotope by conversion in leaves:

$$\Delta_a = -\epsilon_d + \frac{C_c}{C_a - C_c} (\delta_L - \delta_a) \quad (21)$$

The two most important terms in (20) are those relative to leaf and to soil isotopic exchange, whereas the ocean flux is relatively minor. Global numbers for GPP, discrimination, and other parameters bear a large uncertainty so that there is not a unique solution to (20) yielding  $d\delta_a/dt = 0$ . Alternatively, we solved (20) for  $\epsilon_s$ , the diffusive fractionation of  $\text{CO}_2$  respired by soils. Using the values given in Table 1 for the global quantities which appear in (20), we infer  $\epsilon_s = -5\%$ . This working value of  $\epsilon_s$  is significantly lower than the value of  $-8.8\%$  corresponding to strictly molecular diffusion. Possibly, turbulent diffusion plays an important role in transferring  $\text{CO}_2$  from the soil surface to the atmosphere, which would lower  $\epsilon_s$ . Another explanation for the relatively low value of  $\epsilon_s$  that we infer by solving (20) would be that the production of  $\text{CO}_2$  in soils occurs mainly near the surface, which would diminish the influence of the diffusive fractionation in the isotopic composition of  $\text{CO}_2$  emitted by soils as shown by Hesterberg and Siegenthaler [1991] in the case of an exponential decrease in the  $\text{CO}_2$  production at depth.

Farquhar et al. [1993] infer that  $\epsilon_s = -7.6\%$ , a value closer to molecular diffusion, from a budget equation similar to (20). This is mostly because they employ a higher value of the global discrimination than the one we establish in this paper. Nevertheless, although its value is plausible, the global significance of  $\epsilon_s = -5\%$  awaits further explanations, and it should be considered as a tuning that we apply to the global budget so as to yield a zero long-term trend in  $\delta_a$ .

## 8. Conclusions

We have calculated the surface fluxes that control the  $\delta^{18}\text{O}$  in atmospheric  $\text{CO}_2$ . The most crucial assumption is that  $\text{CO}_2$  exchanges isotopically to fully reach isotopic equilibrium with water available in leaves (because of the presence of carbonic anhydrase) and in surface soil. The validity of this assumption should be further investigated through laboratory experiments. The calculation of terrestrial carbon fluxes is based on the SiB2 photosynthesis model coupled with the CSU GCM. The isotopic composition of meteoric water comes from the NASA GISS climate model. The air-sea  $\delta^{18}\text{O}$  exchange is calculated using  $\Delta p\text{CO}_2$  from the HAMOCC ocean model and stability-

dependent gas transfer velocities. The  $\delta^{18}\text{O}$  of  $\text{CO}_2$  emitted by the combustion of hydrogen-bound carbon is isotopically depleted with respect to the mean atmospheric value and has the same isotopic character as atmospheric  $\text{O}_2$  ( $-17\%$ ). We account for fossil fuel industrial emissions in the northern hemisphere and biomass burning in the tropics. There is some inconsistency in assembling fields generated by different climate models to infer the terrestrial isotopic exchange. Ideally, the isotopic composition of water and  $\text{CO}_2$  would be calculated simultaneously within a single GCM, with fully interactive isotopic hydrology, physiology, and photosynthesis. Unfortunately, such a model does not exist at present.

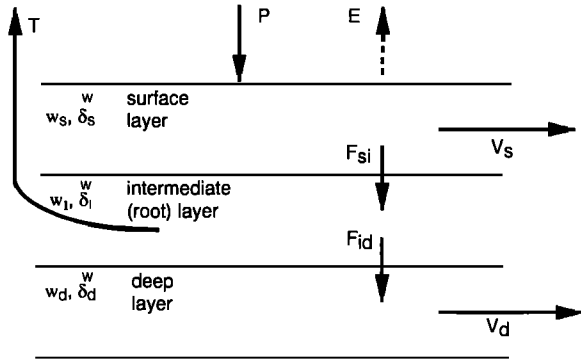
The oxygen isotope fluxes have been tested against the global trend in atmospheric  $\delta^{18}\text{O}$ , which is observed to be close to zero. This condition can be met if the global average fractionation at the soil-air interface is of  $-5\%$ , a value smaller than the one inferred by Farquhar et al. [1993] in an independent calculation ( $-7.6\%$ ), although it lies within a physically acceptable range. Overall, the oceanic and anthropogenic contributions are relatively minor compared to the isotopic exchange with the terrestrial biota. We confirm the fact that leaf exchange globally enriches in  $^{18}\text{O}$  the atmospheric  $\text{CO}_2$  reservoir, whereas soil exchange has the opposite role. Apart from the global budget, we expect that the geographical differences in the isotopic fluxes have an influence on the spatial distribution of  $\delta^{18}\text{O}$  in atmospheric  $\text{CO}_2$ . In a companion paper [Ciais et al., this issue] describing a three-dimensional tracer simulation, we provide a more detailed assessment of the respective role of each reservoir, with special emphasis on vegetation and soils.

## Appendix A: Groundwater $\delta^{18}\text{O}$ Inferred From the Soil Hydrology in the SiB2 Model

We detail in the following how the  $\delta^{18}\text{O}$  of water in soils is obtained from the  $\delta^{18}\text{O}$  of meteoric water using the parameters of soil hydrology in SiB2. The soil column is divided into three layers (Figure A1). The surface layer receives precipitation and loses water through surface runoff, evaporation, and infiltration to the intermediate layer. The intermediate layer corresponds to the rooting zone of plants, in which plants take up water to transpire to the atmosphere and has no runoff. The deep soil layer receives water by infiltration from the layer above and loses it by deep runoff. Only evaporation fractionates the heavy isotope of water; all other fluxes conserve the isotopic ratios. The isotopic effects of the interception of precipitation by the canopy are neglected.

In Figure A1,

- $w_s(R_d^w, \delta_d^w)$  integrated water content ( $^{18}\text{O}/^{16}\text{O}$ ,  $\delta^{18}\text{O}$ ) of the surface layer (mm);
- $w_i(R_i^w, \delta_i^w)$  integrated water content ( $^{18}\text{O}/^{16}\text{O}$ ,  $\delta^{18}\text{O}$ ) of the intermediate (rooting) layer;
- $w_d(R_d^w, \delta_d^w)$  integrated water content ( $^{18}\text{O}/^{16}\text{O}$ ,  $\delta^{18}\text{O}$ ) of the deep (recharge) layer (mm);
- $\alpha_{L-\text{vap}}^w$  fractionation of  $\text{H}_2^{18}\text{O}$  for the liquid-vapor phase transition, equal to  $(1 + (\epsilon_{L-\text{vap}}^w/1000))$ ;
- $P$  precipitation reaching the ground surface ( $\text{mm d}^{-1}$ );
- $E$  evaporation from the ground surface ( $\text{mm d}^{-1}$ );
- $T$  uptake of water by roots equals transpiration by plants ( $\text{mm d}^{-1}$ );
- $F_{si}$  infiltration of water from surface to intermediate soil layer ( $\text{mm d}^{-1}$ );



**Figure A1.** Fluxes of  $\text{H}_2\text{O}$  in soils as calculated by the SiB2 model including three soil compartments. The isotopic composition of groundwater is calculated off-line from these fluxes: solid lines are fluxes that take place with no isotopic fractionation, and the dashed line includes the specific fractionation of water isotopes during evaporation.

- $F_{id}$  infiltration of water from intermediate to deep soil layer ( $\text{mm d}^{-1}$ );  
 $V_s$  surface runoff ( $\text{mm d}^{-1}$ );  
 $V_d$  deep runoff ( $\text{mm d}^{-1}$ ).

The mass balance of  $\text{H}_2\text{O}$  and  $\text{H}_2^{18}\text{O}$  in each layer is written

$$dw_s = P - E - F_{si} - V_s \quad (\text{A1})$$

$$dw_1 = F_{si} - T - F_{id} \quad (\text{A2})$$

$$dw_d = F_{id} - V_d \quad (\text{A3})$$

$$d(R_s^w w_s) = R_p^w P - \alpha_{L-\text{vap}}^w R_s^w E - R_s^w F_{si} - R_s^w V_s \quad (\text{A4})$$

$$d(R_1^w w_1) = R_s^w F_{si} - R_1^w T - R_1^w F_{id} \quad (\text{A5})$$

$$d(R_d^w w_d) = R_1^w F_{id} - R_d^w V_d \quad (\text{A6})$$

Using  $d(Rw) = w dR + R dw$  and the definition  $R = (1 + \delta/1000) R_{\text{VSMOW}}$ , we substitute (A1)–(A3) into (A4)–(A6) to obtain the set of differential equations (A7)–(A9) describing the variation in  $\delta^{18}\text{O}$  of water in each soil layer.

$$d\delta_s^w = w_s^{-1} [P(\delta_p^w - \delta_s^w) + E(\epsilon_{L-\text{vap}})] \quad (\text{A7})$$

$$d\delta_1^w = w_1^{-1} F_{si} (\delta_s^w - \delta_1^w) \quad (\text{A8})$$

$$d\delta_d^w = w_d^{-1} F_{id} (\delta_1^w - \delta_d^w) \quad (\text{A9})$$

We integrate these equations numerically to calculate the monthly mean values of  $\delta_s^w$  and  $\delta_1^w$  which are, respectively, used to express the isotopic composition of  $\text{CO}_2$  in soils and in leaves (sections 3 and 4).

## Appendix B: Biospheric $\text{CO}_2$ Fluxes in the SiB2 Model

### B.1. Photosynthesis

Following Collatz *et al.* [1991, 1992] and Ball [1988], stomatal conductance, the carbon assimilation rate, and the  $\text{CO}_2$  concentration at the leaf surfaces are assumed to be related by

$$g_s = m \frac{Ah}{C_s} + b \quad (\text{B1})$$

where  $g_s$  is the stomatal conductance to water vapor,  $A$  is the net assimilation rate of  $\text{CO}_2$ ,  $h$  and  $C_s$  are the relative humidity and mixing ratio of  $\text{CO}_2$  at the leaf surface (for simplicity,  $C_s$  is taken equal to the atmospheric value  $C_a$ ),  $p$  is the atmospheric pressure, and  $m$  and  $b$  are empirically derived parameters.

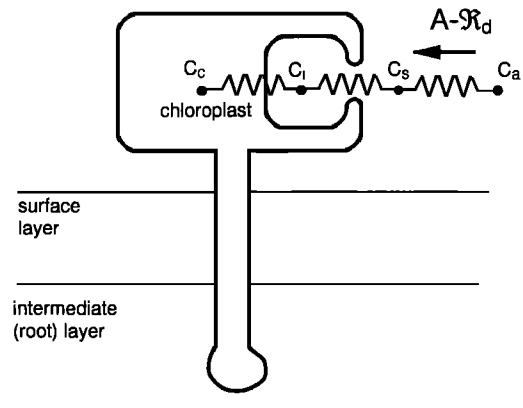
The net assimilation rate  $A$  is modeled as limited by the kinetics of the carboxylation enzyme Rubisco, by electron transport (a series of reactions that take place when green plant cells are illuminated with visible radiation), and by buildup of the sugars and starches that are the end products of photosynthesis. Farquhar *et al.* [1980] used a simple minimum of the three limits to calculate the net carbon assimilation rate

$$A = \min(\omega_c, \omega_e, \omega_s) - \mathfrak{R}_d \quad (\text{B2})$$

where  $\omega_c$  is the carbon-limited rate of photosynthesis (often referred to as Rubisco-limited, since the rate is determined by Rubisco enzyme kinetics),  $\omega_e$  is the rate limited by electron transport (light-limited),  $\omega_s$  is the end product-limited (or sink-limited) rate, and  $\mathfrak{R}_d$  is the rate of carbon loss from the canopy due to “dark” respiration. SiB2 uses a similar approach but replaces the simple minimum in (B2) with a smoothed function to avoid abrupt transitions from one limitation to another [Collatz *et al.*, 1991]. The Rubisco-limited and light-limited assimilation rates are calculated from enzyme kinetics models developed by Collatz *et al.* [1991]. For C3 vegetation the sink-limited rate is parameterized as a simple fraction of the Rubisco activity, and for C4 vegetation,  $\omega_s$  refers to PEP-carboxylase limitation according to the model of Collatz *et al.* [1992]. Leaf respiration  $\mathfrak{R}_d$  is parameterized according to Rubisco activity and canopy temperature.

All three photosynthetic rates and the leaf respiration are scaled by nondimensional parameters ( $f_{\text{HOT}}$ ,  $f_{\text{COLD}}$ ,  $f_{\Psi}$ ,  $f_{\text{RH}}$ , and  $f_{\text{FRZ}}$ ) representing environmental stresses due to excessively high or low canopy temperature, drought, low relative humidity, and frozen soils. The leaf-level assimilation rate, stomatal conductance, and other physiological parameters are scaled to the canopy using an assumed optimal relationship between leaf nitrogen (and hence Rubisco) and the time-mean profile of photosynthetically active radiation in the canopy. Details of the parameterization are presented by Sellers *et al.* [1996a, Appendix C].

The partial pressure of  $\text{CO}_2$  in the leaf interior ( $C_i$ ) is



**Figure B1.** Resistance to the diffusion of  $\text{CO}_2$  from the canopy to the leaf chloroplast. During the assimilation there is a gradient in the  $\text{CO}_2$  partial pressure from  $C_a$  to  $C_c$ .

diagnosed using a resistance network (Figure B1) from the stomatal conductance, the net assimilation rate, and the rate of  $\text{CO}_2$  efflux due to soil respiration. The partial pressure in the chloroplast  $C_c$ , is slightly smaller than  $C_i$  due to the resistive path of  $\text{CO}_2$  across the mesophyll cell [see, e.g., Farquhar et al., 1993] but we make the approximation that

$$C_c \approx C_i \quad (\text{B3})$$

## B.2. Respiration

The relative intensity of soil respiration, denoted by  $\mathfrak{R}^*$ , is diagnosed from soil moisture and soil temperature at each model time step following the method used by Raich et al. [1991] in the terrestrial ecosystem model. The soil respiration diagnostic  $\mathfrak{R}^*$  is defined as

$$\mathfrak{R}^* = 2.0^{Q_1} f(w) \quad (\text{B4})$$

where

$$f(w) = 0.2 + w_{\text{sat}}^B \quad (\text{B5})$$

$$B = \left( \frac{w_{z_m} - w_{\text{opt}}}{w_{\text{opt}} - 100^{z_m}} \right)^2$$

In the temperature response function,  $Q_1 = (T - 298)/10$ . The temperature used to define  $Q_1$  in (B3) is the warmer of the surface soil temperature and the deep soil temperature. The variable  $w$  in (B4) is the fraction of the pore space occupied by water in the root zone (middle layer) of the soil. The parameters  $w_{\text{sat}}$ ,  $w_{\text{opt}}$ , and  $z_m$  are prescribed according to soil texture using values suggested by Raich et al. [1991]. Soil respiration is a maximum for some value  $w_{\text{opt}}$  of soil moisture, and respiration is less efficient under very dry or very wet conditions.

A dimensionless monthly mean soil respiration rate is defined as

$$\bar{\mathfrak{R}}(t) = \frac{\overline{\mathfrak{R}^*(t)}}{\sum_{1 \text{ year}} \mathfrak{R}^*(t) \Delta t} \quad (\text{B6})$$

where the overbar indicates the monthly mean. The flux of  $\text{CO}_2$  from the soil due to respiration is computed from this dimensionless rate by assuming a local steady state for carbon storage in terrestrial ecosystems on an annual basis, that is, that the annual sum of respiration loss is equal to the annual net carbon assimilation (ANA), defined as

$$\text{ANA} = \sum_{1 \text{ year}} \bar{A}(t) \Delta t \quad (\text{B7})$$

where  $\bar{A}(t)$  is the monthly mean net assimilation. The flux of  $\text{CO}_2$  from the ecosystem due to respiration is calculated from  $\bar{\mathfrak{R}}(t)$  according to

$$\overline{\mathfrak{R}^*(t)} = \bar{\mathfrak{R}}(t) \text{ANA} \quad (\text{B8})$$

so that the net annual flux of  $\text{CO}_2$  from every grid point is zero.

The model was integrated for 10 years on a low-resolution grid ( $7.2^\circ$  latitude  $\times$   $9^\circ$  longitude) to allow soil moisture fields to equilibrate with the simulated climate. After this "spin-up" period the model was integrated for an additional 4 years on a  $4^\circ \times 5^\circ$  grid with 17 vertical layers and a time step of 6 min. The fields used to drive the  $^{18}\text{O}$  calculation were monthly means for the final year of the simulation. The spatial and seasonal distribution of net primary productivity (NPP) simulated by the

SiB2 model are similar to those found in previous studies, and the seasonal and diurnal cycles of net carbon flux to the atmosphere compare favorably with the limited field observations available [Denning et al., 1996]. When these fluxes were used in the CSU GCM to calculate the full three-dimensional concentration field of atmospheric  $\text{CO}_2$ , the results compared very favorably with the data of the NOAA/CMDL flask station network [Denning, 1994; Denning and Randall, 1996].

## References

- Allison, C. E., R. J. Francey, and H. A. Meijer, Recommendations for the reporting of stable isotope measurements of carbon and oxygen in  $\text{CO}_2$  gas, in *References and Intercomparison Materials for Stable Isotopes of Light Elements, Proceedings of a Consultants Meeting held in Vienna, 1-3 December 1993 IAEA-TECDOC-825*, pp. 155-162, Int. At. Energy Agency, Vienna, 1995.
- Arakawa, A., and V. R. Lamb, Computational design of the basic dynamical processes of the UCLA general circulation model, *Methods Comput. Phys.*, **17**, 173-265, 1977.
- Arakawa, A., and V. R. Lamb, A potential enstrophy and energy conserving scheme for the shallow water equations, *Mon. Weather Rev.*, **109**, 18-36, 1981.
- Baertchi, I. H., and W. C. Macklin, Absolute  $^{18}\text{O}$  content of standard mean ocean water, *Earth Planet. Sci. Lett.*, **31**, 341-344, 1965.
- Ball, J. T., An analysis of stomatal conductance, Ph.D. thesis, 89 pp., Stanford Univ., Stanford, Calif., 1988.
- Bariac, T., J. Gonzalez-Dunia, F. Tardieu, D. Tessier, and A. Mariotti, Variabilité spatiale de la composition isotopique de l'eau ( $^{18}\text{O}$ ,  $^2\text{H}$ ) au sein des organes des plantes aériennes, 1, Approche en conditions contrôlées, *Chem. Geol.*, **115**, 307-315, 1994a.
- Bariac, T., J. Gonzalez-Dunia, N. Katerji, O. Béthénod, J. M. Bertolini, and A. Mariotti, Variabilité spatiale de la composition isotopique de l'eau ( $^{18}\text{O}$ ,  $^2\text{H}$ ) dans le continuum sol-plante-atmosphère, 2, Approche en conditions naturelles, *Chem. Geol.*, **115**, 317-333, 1994b.
- Brenninkmeier, C. A. M., P. Kraft, and W. G. Mook, Oxygen isotope fractionation Between  $\text{CO}_2$  and  $\text{H}_2\text{O}$ , *Isotope Geosci.*, **1**, 181-190, 1983.
- Ciais, P., P. P. Tans, J. W. White, M. Trolier, R. Francey, J. A. Berry, D. Randall, P. J. Sellers, J. G. Collatz, and D. S. Schimel, Partitioning of ocean and land uptake of  $\text{CO}_2$  as inferred by  $\delta^{13}\text{C}$  measurements from the NOAA Climate Monitoring and Diagnostic Laboratory global air sampling network, *J. Geophys. Res.*, **100**, 5051-5070, 1995.
- Ciais, P., et al., A three-dimensional synthesis study of  $\delta^{18}\text{O}$  in atmospheric  $\text{CO}_2$ , 2, Simulations with the TM2 transport model, *J. Geophys. Res.*, this issue.
- Collatz, G. J., J. T. Ball, C. Grivet, and J. A. Berry, Physiological and environmental regulation of stomatal conductance, photosynthesis, and transpiration: A model that includes a laminar boundary layer, *Agric. For. Meteorol.*, **54**, 107-136, 1991.
- Collatz, G. J., M. Ribas-Carbo, and J. A. Berry, Coupled photosynthesis-stomatal conductance model for leaves of C4 plants, *Aust. J. Plant Physiol.*, **19**, 519-538, 1992.
- Conway, T. J., P. P. Tans, L. S. Waterman, K. W. Thoning, D. R. Kitzis, K. A. Masarie, and N. Zhang, Evidence for interannual variability of the carbon cycle from the National Oceanic and Atmospheric Administration/Climate Monitoring and Diagnostic Laboratory Global air sampling network, *J. Geophys. Res.*, **99**, 22,831-22,855, 1994.
- Craig, H., and A. Gordon, Deuterium and oxygen-18 variations in the ocean and the marine atmosphere, in *Stable Isotopes in Oceanic Studies and Paleotemperatures*, Lab. Geol. and Nuclear Sci., Pisa, Italy, 1965.
- Denning, A. S., Investigations of the transport, sources, and sinks of atmospheric  $\text{CO}_2$  using a general circulation model, *Atmos. Sci. Pap.* **564**, Colo. State Univ., Fort Collins, 1994.
- Denning, A. S., and D. A. Randall, Simulations of terrestrial carbon metabolism and atmospheric  $\text{CO}_2$  in a general circulation model, 2, Simulated  $\text{CO}_2$  concentrations, *Tellus*, in press, 1996.
- Denning, A. S., J. G. Collatz, C. Zhang, D. A. Randall, J. A. Berry, P. J. Sellers, and S. C. Wofsy, Simulations of terrestrial carbon metabolism and atmospheric  $\text{CO}_2$  in a general circulation model, 1, Surface carbon fluxes, *Tellus*, in press, 1996.

- Dórr, H., and K. O. Munnich, Annual variation in soil respiration in selected areas of the temperate zone, *Tellus, Ser. B*, 39, 114–121, 1987.
- Enting, I. G., C. M. Trudinger, R. J. Francey, and H. Granek, Synthesis inversion of atmospheric  $\text{CO}_2$  using the GISS tracer transport model, *Div. Atmos. Res. Tech. Pap. Aust. C.S.I.R.O.*, 29, 1–44, 1993.
- Enting, I. G., C. M. Trudinger, and R. J. Francey, A synthesis inversion of the concentration and  $\delta^{13}\text{C}$  of atmospheric  $\text{CO}_2$ , *Tellus, Ser. B*, 47, 35–52, 1995.
- Erickson, D. J., III., A stability dependent theory for air-sea exchange, *J. Geophys. Res.*, 98, 8471–8488, 1993.
- Farquhar, G. D., S. von Caemmerer, and J. A. Berry, A biochemical model of photosynthetic  $\text{CO}_2$  assimilation in C3 plants, *Planta*, 149, 78–90, 1980.
- Farquhar, G. D., K. T. Hubick, A. G. Condon, and R. A. Richards, Carbon isotope fractionation and plant water-use efficiency, in *Stable Isotopes in Ecological Research*, edited by P. W. Rundel et al., pp. 21–40, Springer-Verlag, New York, 1989.
- Farquhar, G. D., J. Lloyd, J. A. Taylor, L. B. Flanagan, J. P. Syvertsen, K. T. Hubick, S. C. Wong, and R. Ehleringer, Vegetation effects on the isotope composition of oxygen in atmospheric  $\text{CO}_2$ , *Nature*, 363, 439–443, 1993.
- Förstel, H., A. Putral, G. Schleser, and H. Leith, The world pattern of oxygen-18 in rainwater and its importance in understanding the biogeochemical oxygen cycle, in *Isotope Ratios as Pollutant Source and Behavior Indicators*, pp. 323–344, Int. At. Energy Agency, Vienna, 1975.
- Fowler, L. A., and D. A. Randall, Liquid and ice cloud microphysics in the CSU general circulation model, II, Impact on cloudiness, the Earth's radiation budget, and the general circulation of the atmosphere, *J. Clim.*, 9, 530–560, 1995a.
- Fowler, L. A., and D. A. Randall, Liquid and ice cloud microphysics in the CSU general circulation model, III, Sensitivity to modeling assumptions, *J. Clim.*, 9, 561–586, 1995b.
- Fowler, L. A., D. A. Randall, and S. A. Rutledge, Liquid and ice cloud microphysics in the CSU general circulation model, I, Model description and simulated microphysical processes, *J. Clim.*, 9, 486–529, 1995.
- Francey, R. J., and P. P. Tans, Latitudinal variation in oxygen-18 of atmospheric  $\text{CO}_2$ , *Nature*, 495–497, 1987.
- Francey, R. J., C. E. Allison, I. G. Enting, J. W. C. White, M. Trolrier, and P. P. Tans, Changes in the oceanic and terrestrial carbon uptake since 1982, *Nature*, 373, 326–330, 1995.
- Friedman, I., and J. R. O'Neill, Compilation of stable isotope fractionation factors of geochemical interest, *U.S. Geol. Surv. Prof. Pap.*, 440-KK, 1977.
- Fung, I. Y., C. J. Tucker, and K. C. Prentice, Application of advanced very high resolution radiometer vegetation index to study atmosphere-biosphere exchange of  $\text{CO}_2$ , *J. Geophys. Res.*, 92, 2999–3013, 1987.
- Hao, W.-M., and M.-H. Liu, Spatial and temporal distribution of tropical biomass burning, *Global Biogeochem. Cycles*, 8, 495–503, 1994.
- Harshvardhan, R., D. A. Davies, D. Randall, and T. G. Corsetti, A fast radiation parameterization for general circulation models, *J. Geophys. Res.*, 92, 1009–1016, 1987.
- Hesterberg, R., and U. Siegenthaler, Production and stable isotopic composition of  $\text{CO}_2$  in a soil near Bern, Switzerland, *Tellus, Ser. B*, 43, 197–205, 1991.
- Houghton, R. A., et al., The flux of carbon from terrestrial ecosystems to the atmosphere in 1980 due to changes in land use: Geographic distribution of the global flux, *Tellus, Ser. B*, 39, 122–139, 1987.
- Hut, G., Report to the Director General on the consultants' group meeting on stable isotope reference samples for geochemical and hydrological investigations, report, 41 pp., Int. Atomic Energy Assoc., Vienna, 1987.
- International Atomic Energy Agency (IAEA), Statistical treatment of environmental isotope data in precipitation, *Tech. Rep. Ser. I.A.E.A.*, 206, 1–256, 1981.
- Jacob, H., and C. Sonntag, An 8-year record of the seasonal variation of  $^2\text{H}$  and  $^{18}\text{O}$  in atmospheric water vapor and precipitation at Heidelberg, Germany, *Tellus, Ser. B*, 43, 291–300, 1991.
- Jouzel, J., G. L. Russell, R. J. Suozzo, R. D. Koster, J. W. C. White, and W. S. Broecker, Simulations of the HDO and  $\text{H}_2^{18}\text{O}$  atmospheric cycles using the NASA/GISS general circulation model: The seasonal cycle for present-day conditions, *J. Geophys. Res.*, 92, 14,739–14,760, 1987.
- Keeling, C. D., T. P. Whorf, M. Wahlen, and J. Van der Plicht, Interannual extremes in the rate of rise of atmospheric carbon dioxide since 1980, *Nature*, 375, 666–670, 1995.
- Keeling, R., The atmospheric oxygen cycle: The oxygen isotopes of atmospheric  $\text{CO}_2$  and  $\text{O}_2$  and the  $\text{O}_2/\text{N}_2$  ratio, *U.S. Natl. Rep. Int. Union Geod. Geophys. 1991–1994, Rev. Geophys.*, 33, 1253–1262, 1995.
- Kroopnick, P., and H. Craig, Atmospheric oxygen: Isotopic composition and solubility fractionation, *Science*, 175, 54–55, 1972.
- Levitus, S., *Climatological Atlas of the World Ocean, Prof. Pap.*, 173, U.S. Gov. Print. Off., 1982.
- Maier-Reimer, E., Geochemical cycles in an ocean general circulation model: Preindustrial tracer distribution, *Global Biogeochem. Cycles*, 7, 645–677, 1993.
- Marland, G., R. M. Rotty, and N. L. Treat,  $\text{CO}_2$  from fossil fuel burning: Global distribution of emissions, *Tellus, Ser. B*, 37, 243–258, 1985.
- Merlivat, L., Molecular diffusivities of  $\text{H}_2^{18}\text{O}$  in gases, *J. Chem. Phys.*, 69, 1864–2871, 1978.
- Raich, J. W., E. B. Rastetter, J. M. Melillo, D. W. Kicklighter, P. A. Steudler, and B. J. Peterson, Potential net primary productivity of South America: Application of a global model, *Ecol. Appl.*, 1, 399–429, 1991.
- Randall, D. A., and D.-M. Pan, Implementation of the Arakawa-Schubert parameterization with a prognostic closure, in *The Representation of Cumulus Convection in Numerical Models*, edited by K. Emanuel and D. Raymond, pp. 137–144, Am. Meteorol. Soc., Boston, Mass., 1993.
- Randall, D. A., Harshvardhan, D. A. Dazlich, and T. G. Corsetti, Interactions among radiation, convection, and large-scale dynamics in a general circulation model, *J. Atmos. Sci.*, 46, 1943–1970, 1989.
- Randall, D. A., Harshvardhan, and D. A. Dazlich, Diurnal variability of the hydrologic cycle in a general circulation model, *J. Atmos. Sci.*, 48, 40–62, 1991.
- Randall, D. A., Q. Shao, and C.-H. Moeng, A second-order bulk boundary-layer model, *J. Atmos. Sci.*, 49, 1903–1923, 1992.
- Randall, D. R., et al., A revised land-surface parameterization (SiB2) for GCMs, 3, The greening of the Colorado State University general circulation model, *J. Clim.*, 9, 738–763, 1996.
- Sellers, P. J., Y. Mintz, Y. C. Sud, and A. Dalcher, A simple biosphere model (SiB) for use within general circulation models, *J. Atmos. Sci.*, 43, 505–531, 1986.
- Sellers, P. J., J. A. Berry, G. J. Collatz, C. B. Field, and F. G. Hall, Canopy reflectance, photosynthesis, and transpiration, III, A reanalysis using enzyme kinetics—Electron transfer models of leaf physiology, *Remote Sens. Environ.*, 42, 1–20, 1992a.
- Sellers, P. J., M. D. Heiser, and F. G. Hall, Relations between surface conductance and spectral vegetation indices at intermediate (100  $\text{m}^2$  to 15  $\text{km}^2$ ) length scales, *J. Geophys. Res.*, 97, 19,033–19,059, 1992b.
- Sellers, P. J., D. R. Randall, J. A. Collatz, J. A. Berry, C. B. Field, D. A. Dazlich, C. Zhang, and L. Bounoua, A revised land-surface parameterization (SiB2) for atmospheric GCMs, 1, Model formulation, *J. Clim.*, 9, 676–705, 1996a.
- Sellers, P. J., S. O. Los, C. J. Tucker, C. O. Justice, D. A. Dazlich, G. J. Collatz, and D. A. Randall, A revised land surface parameterization (SiB2) for atmospheric GCMs, 2, The generation of global fields of terrestrial biophysical parameters from satellite data, *J. Clim.*, 9, 706–737, 1996b.
- Silverman, D. N., Carbonic Anhydrase: Oxygen-18 exchange catalyzed by an enzyme with rate-contributing proton transfer steps, *Methods Enzymol.*, 87, 733–753, 1982.
- Suarez, M. J., A. Arakawa, and D. A. Randall, Parameterization of the planetary boundary layer in the UCLA general circulation model: Formulation and results, *Mon. Weather Rev.*, 111, 2224–2243, 1983.
- Tans, P. P., R. J. Francey, and G. I. Pearman, Large scale variations in  $\delta^{18}\text{O}$  of tropospheric  $\text{CO}_2$ , in *Baseline 1983–1984*, edited by R. J. Francey and B. W. Morgan, Dep. of Sci., Bur. of Meteorol./CSIRO Div. of Atmos. Res., Melbourne, Victoria, Australia, 1986.
- Tans, P. P., J. A. Berry, and R. F. Keeling, Oceanic  $^{13}\text{C}$  data: A new window on  $\text{CO}_2$  uptake by the oceans, *Global Biogeochem. Cycles*, 7, 353–368, 1993.
- Vogel, J. C., P. M. Grootes, and W. G. Mook, Isotopic fractionation between gaseous and dissolved carbon dioxide, *Z. Phys.*, 230, 225–238, 1970.

- White, J. W. C., The climatic significance of D/H ratios in white pine in the northeastern United States, 331 pp., Ph.D. thesis, Columbia Univ., New York, 1983.
- White, J. W. C., and S. D. Gedzelman, The isotopic composition of atmospheric water vapor and the concurrent meteorological conditions, *J. Geophys. Res.*, **89**, 4937–4939, 1984.
- Yakir, D., J. A. Berry, L. Giles, and C. B. Osmond, Isotopic heterogeneity of water in transpiring leaves: Identification of the component that controls  $\delta^{18}\text{O}$  of atmospheric  $\text{CO}_2$  and  $\text{O}_2$ , *Plant Cell Environ.*, **7**, 73–80, 1994.
- 
- J. A. Berry, Department of Plant Biology, Carnegie Institution of Washington, 290 Panama Street, Stanford, CA 94305. (e-mail: joeberry@biosphere.stanford.edu)
- P. Ciais, LMCE, CEA l'Orme des Merisiers, Commissariat à l'Énergie Atomique, Bâtiment 709, Saclay 91191 Gif sur Yvette, France. (e-mail: ciais@obelix.saclay.cea.fr)
- G. J. Collatz and P. J. Sellers, NASA Goddard Space Flight Center, MC 923, Biosphere Sciences Branch, Greenbelt, MD 20771.
- A. S. Denning and D. A. Randall, Department of Atmospheric Sciences, Colorado State University, Fort Collins, CO 80523-1370. (e-mail: scott@abyss.atmos.colostate.edu)
- R. J. Francey, Division of Atmospheric Research, CSIRO, PMB Aspendale, Melbourne, Victoria 3195, Australia.
- M. Heimann, Max-Planck Institut für Meteorologie, Bundesstrasse 55, D-20146 Hamburg, Germany.
- H. A. J. Meijer, CIO, University of Groningen, 9722 JX Groningen, Netherlands. (e-mail: meijer@phys.rug.nl)
- P. Monfray, Centre des Faibles Radioactivités, Bâtiment 709/LMCE, 91191 Gif sur Yvette, France.
- P. P. Tans, Climate Monitoring and Diagnostic Laboratory, NOAA, ERL 3, 325 Broadway, Boulder, CO 80303.
- M. Trolier and J. W. C. White, Institute of Arctic and Alpine Research, University of Colorado, Campus Box 450, Boulder, CO 80303.

(Received November 18, 1995; revised June 25, 1996; accepted July 12, 1996.)