



HAL
open science

Progress of acetone-butanol-ethanol (ABE) as biofuel in gasoline and diesel engine: A review

Ibham Veza, Mohd Muhammad Said, Zulkarnain Abdul Latiff

► To cite this version:

Ibham Veza, Mohd Muhammad Said, Zulkarnain Abdul Latiff. Progress of acetone-butanol-ethanol (ABE) as biofuel in gasoline and diesel engine: A review. *Fuel Processing Technology*, 2019, 196, pp.106179. 10.1016/j.fuproc.2019.106179 . hal-02923473

HAL Id: hal-02923473

<https://hal.science/hal-02923473v1>

Submitted on 27 Aug 2020

HAL is a multi-disciplinary open access archive for the deposit and dissemination of scientific research documents, whether they are published or not. The documents may come from teaching and research institutions in France or abroad, or from public or private research centers.

L'archive ouverte pluridisciplinaire **HAL**, est destinée au dépôt et à la diffusion de documents scientifiques de niveau recherche, publiés ou non, émanant des établissements d'enseignement et de recherche français ou étrangers, des laboratoires publics ou privés.

Progress of acetone-butanol-ethanol (ABE) as biofuel in gasoline and diesel engine: A review

Ibham Veza*, Mohd Farid Muhammad Said, Zulkarnain Abdul Latiff

Automotive Development Centre, School of Engineering, Faculty of Engineering, Universiti Teknologi Malaysia, 81310, Johor Bahru, Malaysia.

* **Corresponding author.** Mailing address: Automotive Development Centre, School of Engineering, Faculty of Engineering, Universiti Teknologi Malaysia, 81310, Johor Bahru, Malaysia; E-mail address: veza.ibham@graduate.utm.my (Ibham Veza); Phone: +6075535449; Fax: +6075535811

Abstract

The properties of butanol offer more promising results compared to those of lower chain alcohol such as methanol or ethanol. However, butanol as a biofuel has not yet been commercially produced due to its costly process. Butanol is generally produced via the process of Acetone-Butanol-Ethanol (ABE) fermentation and can only be acquired after it was recovered from the ABE solvent. Despite the efforts and recent developments, obtaining higher butanol concentration from ABE fermentation is still relatively expensive and challenging. The idea of using ABE directly in internal combustion engines is then proposed to eliminate the recovery process. Several preliminary studies have reported several promising results of using ABE blends in both gasoline and diesel engines. However, researches in this area are still in the early stages, and thorough investigations are required. This review paper aims to provide essential findings from the latest development in the addition of ABE both with gasoline and diesel fuel in Spark Ignition (SI) and Compression Ignition (CI) engines. A brief discussion on ABE properties will be firstly given before the effects of its addition on SI and CI engine is comprehensively reviewed. The end of this article highlights some possible contributions and research gaps.

Keywords: butanol; biofuel; acetone-butanol-ethanol (ABE); gasoline; diesel, SI, CI

1. Introduction	2
2. ABE properties	5
3. ABE addition in gasoline engine	8
3.1 Performance	8
3.2 Combustion.....	13
4. ABE addition in diesel engine.....	17
4.1 Performance	17
4.2 Spray and combustion.....	27
4.3 Emission	30
5. Research gaps	38
Acknowledgment	39
References	39

Nomenclature

ABE	acetone-butanol-ethanol
B	Biodiesel

BA	butanol-ethanol
BaPeq	toxicity equivalent of phase
BP	brake power
BSFC	brake specific fuel consumption
BTE	brake thermal efficiency
Bu	Butanol
CI	compression ignition
CO	carbon monoxide
CO ₂	carbon monoxide
DI	direct injection
EGR	exhaust gas recirculation
EGT	Exhaust gas temperature
ø	equivalence ratio
FLoL	flame-lift off length
HC	unburned hydrocarbons
LTC	low temperature combustion
ICD	Initial Combustion Duration
ISFC	indicated specific fuel consumption
ITE	indicated thermal efficiency
MCD	Main Combustion Duration
MFB	Mass Fraction Burnt
NO _x	nitrogen oxides
PFI	port fuel injection
PM	particulate matter
SI	spark ignition
SINL	space integrated natural luminosity
SMD	sauter mean diameter
SOC	start of combustion
TINL	time integrated natural luminosity

1. Introduction

Modern engines face challenging targets to meet the increasing emissions regulation and to increase the engine thermal efficiency [1, 2]. To address these two issues, the use of alcohol biofuels such as methanol, ethanol, and butanol has attracted many attentions because of their physico-chemical properties [3-7]. They can be produced using renewable sources and agricultural waste material [8-12]. Unlike bio-diesel that can only be used in CI engine, alcohol fuels can be used both in CI and SI engines despite blending more easily with gasoline [13-15]. Ethanol is arguably the most successful alcohol fuel that has been mass produced and used in large scale [16-19]. Brazil has developed ethanol from sugarcane since 1975 with the PRO-ALCOOL programme and has reduced its dependency on fossil fuel imports [20-25]. However, ethanol has several problems to solve. It can only be used in small concentrations caused by its hygroscopicity and lower energy density than those of conventional fuel [26, 27]. In terms of fuel properties, higher alcohol such as butanol is a more favourable alcohol fuel compared to ethanol due to its higher heating value, good solubility and less corrosive to the existing pipelines [28-32].

Butanol emerges as a promising biofuel to achieve a clean, efficient and affordable combustion engine [33-35]. It is produced through Acetone-Butanol-Ethanol (ABE) fermentation process with a typical ratio of 3:6:1 or known as bio-butanol [36-40], while that of produced from petrochemical process is called petro-butanol [41, 42]. However, although butanol properties offer more promising results compared to ethanol, its application as a biofuel has not yet been commercially mass-produced. While

petro-butanol is strongly affected by the global oil prices, bio-butanol suffers from its low production capacity. The use of butanol in the internal combustion engine is hindered by its low production efficiency and high production cost [43-45]. The butanol quantity and productivity from the typical ABE fermentation process are exceptionally low, only 12-18 g/l [46-49]. In addition to that, ABE fermentation also produces large amounts of organic wastewater where one-ton ABE production produces around 45 tons of wastewater comprising various organic acids [50]. Although several efforts have been done, its production efficiency is still relatively low [29]. For comparison, the production rate of yeast ethanol is 10-30 times higher than butanol [46]. Besides its low production, the dehydration and recovery of butanol from ABE fermentation mixture requires a considerable amount of energy [29, 51]. The conventional distillation of butanol from ABE is expensive since the boiling point of butanol is 118 °C [52-54], which requires high-energy input in the distillation process caused by different boiling points of each butanol's isomers [55]. Several alternative recovery methods have been proposed [56-58]. These include adsorption [59-62], gas stripping [63-67] and pervaporation [68-79]. Despite being relatively efficient processes, such proposed recovery approaches are still not widely implemented in large scale [52]. Therefore, butanol's low productivity and expensive recovery process have delayed its application as the next biofuel.

Upon requirements, the ABE ratio can be altered. Some straightforward non-in-situ ABE recovery methods could modify ABE ratio at will. Liu et al. used a nonconventional method to generate an optimised downstream process of ABE fermentation [80]. It was found that the optimal and near-optimal flowsheets could be achieved using several separation techniques including gas stripping, distillation and extraction. This study implied that in some cases, building new recovery process could be less economically feasible than merely modifying the existing process. For instance, the direct sequence of distillation columns could be simply modified to the indirect sequence, which would increase its economic value by 33%. However, despite being more efficient compared to the simple traditional distillation process, the energy required for recovery process was still significantly higher than the energy content of butanol at a factor of 10%, a target for energy efficiency in the ABE recovery process [55]. Moreover, gas stripping may be a straightforward method compared to liquid-liquid extraction, but the overall process could be less economically viable due to the expensive of azeotropic systems to obtain pure ABE final products from stripped gas.

Liu et al. used a more complex biochemical production in their subsequent study [81]. The P-graph was still used, due to its excellent insight, to retrofit the recovery process of ABE fermentation so that its energy efficiency could be improved. This study combined the adsorption with conventional recovery methods such as distillation, liquid-liquid extraction and gas stripping. It was found that the optimal flowsheet was comprised of a gas-stripper, two adsorption columns and two distillation columns as illustrated in Fig. 1. This optimal flowsheet could reduce its total cost by 44% compared to the group's previous study. This is because the gas stripping was used before adsorption. As a result, only a few fermentation broths were fed to the adsorption unit, thus significantly minimising the size of the equipment as well as reducing its capital cost. Note that this study assumed that most of the products were recovered by gas stripping, while the excess water was removed by adsorption.

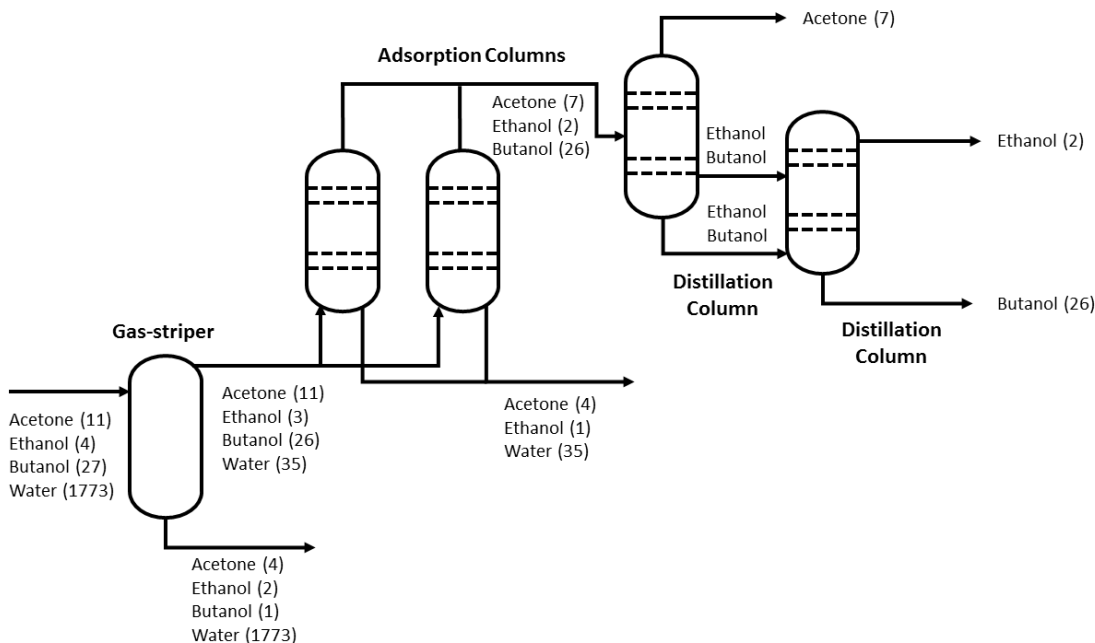

Fig. 1. Optimal flowsheet for downstream processing of ABE fermentation with values in bracket being on mass basis, reproduced from [81]

As the major by-product of ABE fermentation (the second metabolite after butanol), acetone plays an important role in the economics of ABE industry due to its valuable chemical content. It can be regulated and maximised during ABE fermentation. By using co-culturing *Clostridium acetobutylicum*/*Saccharomyces cerevisiae* with the addition of exogenous acetate addition, Luo et al. found that the survival of *C. acetobutylicum* in the cells was improved, while NADH synthesis rate was successfully limited at moderately low level to increase acetone synthesis. Both acetone and butanol concentrations increased from 5.86 g/L to 8.27-8.55 g/L and from 11.63 g/L to 13.91-14.23 g/L, respectively [82]. In another study, Luo et al. reported that by using a glucose/acetone co-substrate system combined with *C. acetobutylicum*/*S. cerevisiae* co-culturing with glucose limitation, the acetone production was improved [83]. The acetone concentration and the ratio of acetone/butanol could reach 11.74 g/l and 1.02 without sacrificing the production of butanol. The normal butanol synthesis could be maintained; thus total ABE concentration could be improved by 38%-56%. This finding indicates that the flexibility of ABE fermentation products could be achieved where bio-acetone could be produced utilising renewable feedstocks.

Low production of butanol due to its culture toxicity has increased the cost and energy requirement for the subsequent recovery process [84]. As a result, separation and purification of butanol contribute 14% of the total production cost, the second after feedstock cost (79%) [85, 86]. Also, Qureshi and Blaschek found that major equipment for recovery processes such as distillation columns, boilers, heat exchangers and storage tanks made up almost 80% of the initial investment cost of butanol production from corn [87]. In terms of energy demand for the butanol recovery process, the well-established conventional distillation requires 79.5 MJ/kg. Considering that the energy content of butanol is only 36 MJ/kg, the energy demand for the recovery process alone reach a factor of 220% of the energy content of butanol itself [88].

Although several in situ and hybrid recovery techniques have been extensively studied to lower recovery cost and energy requirement of butanol, a significant amount of energy is still required. Huang et al. reported that by using a hybrid process gas-stripping/distillation, the energy demand

could be reduced to 21 MJ/kg [89]. Kurkijärvi et al. found that by using a liquid-liquid extraction/distillation, the energy consumption for the recovery process was as low as 3.76 MJ/kg [90]. Furthermore, Águeda et al. investigated the use of an adsorption/drying/desorption and found that only 3.4 MJ/kg was required for the recovery process [91]. Despite being able to reduce energy demand for the butanol recovery process, achieving higher butanol production with lower energy consumption is challenging, and a significant amount of energy is still required. Therefore, the idea of using ABE solvent as biofuel instead of butanol would eliminate such process. The whole process of ABE fermentation can be grouped into five main steps as illustrated in Fig. 2. The first process ABE fermentation begins with the selection of feedstock and ends with acetone, butanol and ethanol being produced. By using ABE directly, the fourth step (the downstream process) that typically requires high cost and energy demand could be eliminated.

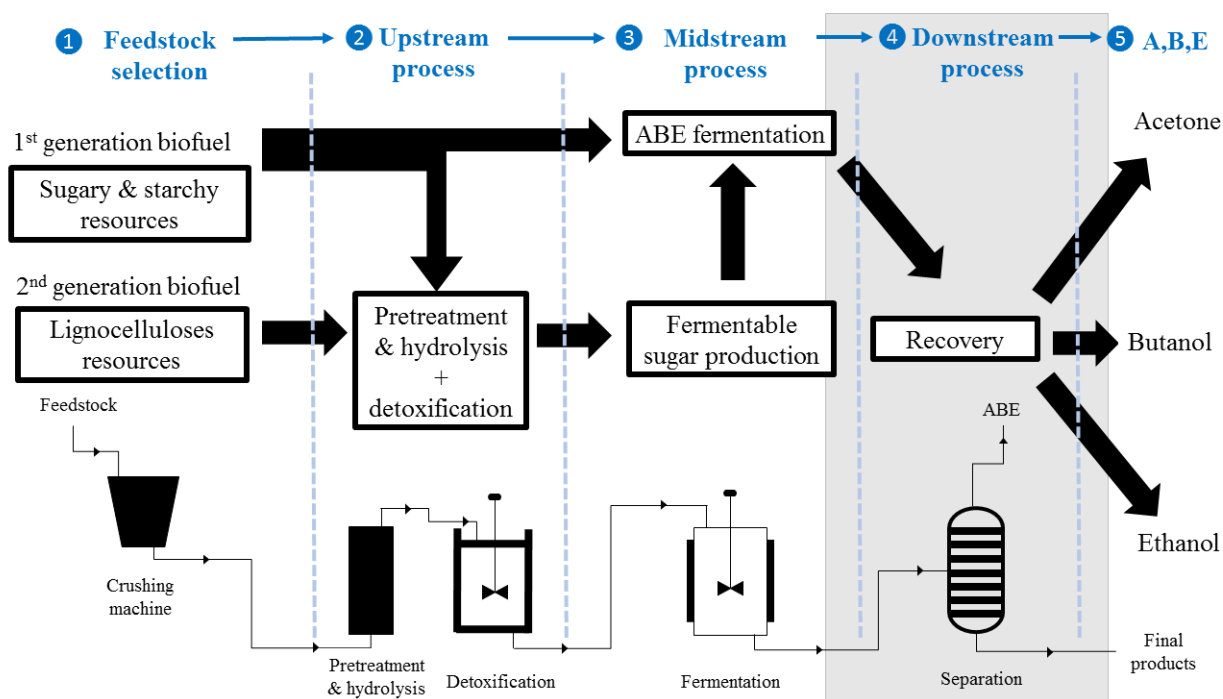

Fig. 2. Schematic overview of ABE process from raw material to final product

Given the challenges with bio-butanol production process mentioned above, using ABE directly as a biofuel is considered as a promising approach as it can eliminate the recovery step resulting in considerable cost and energy savings [92-94]. A slight difference between ABE's molecular structure and butanol's may not significantly affect important combustion characteristics such as heat release and the main combustion products [95]. Two review articles have been published on the use of ABE as biofuel [95, 96]. However, the emphasis of its use as an alternative fuel on the internal combustion engine was moderately discussed since some sections were devoted to ABE's production process and historical development. This review article aims to focus on the addition of ABE in an internal combustion engine, both in SI and CI engines. The term of butanol and bio-butanol are used interchangeably in this article. Discussion on ABE properties will be firstly given before the effects of its addition on the engine is comprehensively reviewed.

2. ABE properties

Since a typical of ABE is produced at a volumetric ratio of 3:6:1, the butanol content is the dominant factor in ABE composition [29, 97, 98]. However, recent development in ABE fermentation technology

has allowed the volumetric percentage of acetone, butanol, and ethanol to be controlled precisely [99-102]. It is possible to designate a specific volumetric ratio such as 6:3:1, 5:14:1 and 0:10:0 to achieve better engine performance, combustion and emission characteristics [103, 104]. By eliminating the ethanol content, recent studies have also reported the use of BA (butanol-ethanol) mixtures [105-107].

It is important to note that with the addition of multi-component fuels such as ABE into the conventional petrol fuel, the physico-chemical of the fuel will also change. Table 1 shows the properties of ABE components compared to conventional petrol fossil fuels. No information can be found in the literature regarding the cetane number of acetone, but considering its high octane number, it is speculated that the cetane number of acetone will be reasonably low [108-110]. This will reduce the overall of ABE's cetane number, particularly with the addition of ABE using high acetone content such as 5:4:1 or 6:3:1. Besides its low cetane number, another noticeable characteristic of ABE is its high latent heat of vaporisation. With higher latent heat compared to gasoline or diesel fuel, it is expected that the engine volumetric efficiency will increase as the charge density increases with the addition of alcohol fuel [111, 112]. High latent heat will also cause the charge cooling effect that will retard the fuel vaporisation [113-117]. The fuel is vaporized in the compression stroke, and the mixture will be more easily to compress.

In the diesel engine, the lower cetane number and higher latent evaporation are expected to retard the start of combustion due to a longer ignition delay and charge cooling effect, respectively [118-122]. Also, the lower density and viscosity of alcohol fuel ABE could enhance the spray characteristics and improve the mixing process of air and fuel [123-126]. As a result, more fuel is burned at the premixed stage, and higher maximum pressure is expected to occur [127-130]. Moreover, the presence of oxygen content in ABE can increase the air-fuel ratio, improve the combustion efficiency and increase the thermal efficiency [131-134]. As for gasoline engine, Van Geem et al. [135] found that the ABE had relatively higher laminar flames speed. In fact, the laminar flame speed of ethanol and butanol were found higher than iso-octane [136-140] and n-heptane [138]. Therefore, the higher flame speeds of ABE will result in faster flame propagation and more complete combustion of a gasoline engine, thus reducing the heat losses and increasing the thermal efficiency [30, 141]. However, the fuel consumption of both diesel and gasoline engine are expected to increase due to ABE's lower heating value [142-144].

Factors that can improve engine performance, combustion and emissions are expected to compete with factors that can deteriorate them. Higher volatility characteristics represented by fuel's low viscosity, boiling point, and high saturation pressure, for instance, may lead to better fuel atomization and air-fuel mixing, thus improving its spray and combustion characteristics [145-147]. However, ABE's higher latent heat may also result in evaporative cooling effect and will offset the improvement caused by its higher volatility qualities. Further details on the impact of those factors will be discussed in the following section. Table 2 shows the calculated properties of ABE based on their component ratios. The use of ABE is expected to change the spray and flame characteristics; thus engine characteristics will also be affected to some extent.

Table 1. Properties of conventional fuels and ABE components

Properties	Gasoline [148, 149]	Diesel [150]	ABE*		Acetone [151]	Butanol [150, 152]	Ethanol [148, 153]
			3:6:1	6:3:1			
Chemical formula	C ₄ - C ₁₂	C ₁₂ - C ₂₅	C _{3.5} H _{8.4} O	C _{3.2} H _{7.2} O	C ₃ H ₆ O	C ₄ H ₉ OH	C ₂ H ₅ OH
Octane number	88 - 99	20 - 30	102.7	109	117	96	100
Cetane number	0 - 10	40 - 55	-	-	-	25	5 - 8
C/H atom ratio	0.44 (octane)	0.44 (n-heptane)	0.42	0.45	0.50	0.40	0.33
Oxygen content (wt%)	-	-	24.73	26.52	27.59	21.62	34.78
Density at 288 K (g/mL)	0.77	0.82 - 0.86	0.80	0.80	0.79	0.81	0.80
Lower heating value (MJ/kg)	43.40	42.70	31.42	30.37	29.60	33.10	26.80
Energy density (MJ/l)	31.0 - 33.2	35.0 - 36.7	25.29	24.24	23.40	26.90	21.30
Viscosity at 413 K (mm ² /s)	0.49	1.90 - 4.10	1.79	1.11	0.35	2.63	1.08
Stoichiometric AFR	14.70	14.30	10.49	9.99	9.54	11.21	9.02
Boiling point (°C)	38 - 204	200 - 400	94.95	76.80	55.5 - 57.5	117	78
Auto-ignition temp (°K)	300	210	389	425	465	343	434
Latent heat at 298 K (kJ/kg)	380 - 500	270	595	576	518	582	904
Saturation pressure (kPa) at 38 °C	31.00	1.90	18.51	33.57	52.50	2.30	13.80
Laminar flame speed (cm/s)	33 ^a	-	-	-	34 ^b	48 ^c	39 ^a
Solubility in water (g/l) at 25 °C	Immiscible	Immiscible	-	-	Miscible	73	Miscible

*ABE properties are calculated based on components ratios and their chemical formulas are from [154].

^ap = 1 atm, T = 325 K. ^bp = 1 atm, T = 298 K. ^cp = 1 atm, T = 343 K

Table 2. Calculated ABE's properties blends with a typical ratio of 3:6:1

Properties	ABE-diesel			ABE-gasoline		
	ABE20	ABE50	ABE80	ABE20	ABE50	ABE80
Oxygen content (wt%)	4.95	12.36	19.78	4.95	12.36	19.78
Density at 288 K (g/mL)	0.83	0.82	0.81	0.77	0.78	0.80
Lower heating value (MJ/kg)	40.44	37.06	33.68	41.00	37.41	33.82
Stoichiometric AFR	13.54	12.40	11.25	13.86	12.60	11.33
Latent heat at 298 K(kJ/kg)	335	433	530	471	518	564

3. ABE addition in gasoline engine

Table 3 summarises several novelties of recent studies using ABE-gasoline blends in SI engine. Important findings are highlighted and detail discussions are presented in this section.

3.1 Performance

3.1.1 Torque

Due to ABE's higher latent heat of vaporisation, the mixture temperature is expected to reduce due to the charge cooling effect. This will lead to an increase in charge density and as a result, engine torque will increase [155-157]. At a wide equivalence ratios region, the ABE-gasoline blends have the potential to increase the engine torque. A small amount of water addition can also improve the engine torque. With just 0.5% water addition, Li et al. [158] found that ABE29.5W0.5 increased the engine torque by 9.6%-12.7% and 7.9%-10.9% compared to that of gasoline and ABE30 (ABE without water addition) at various equivalence ratios. At stoichiometric condition, the engine torque of ABE29.5W0.5 increased by 12.7% and 10.9% than gasoline and ABE30, respectively. The ABE30 obtained its maximum engine torque at the equivalence ratio of 1.11, while the ABE29.5W0.5 and gasoline achieved its highest torque at the equivalence ratio of 1.0. Li et al. [159] found that the torque of ABE30 and ABE85 increased by 3.1% and 4.6% compared to gasoline, but when 1% water is added, the ABE29W1 increased the torque even further by 3.1-8.2%.

In general, torque will increase with the addition of ABE and water due to a higher charge density resulted from its higher latent heat of vaporisation. The improvement in torque may also be caused due to the higher octane number of ABE. Higher octane number will prolong the fuel ignition delay, leading to a shorter flame and slower energy release rate [160]. The engine heat loss may reduce as the heat does not have sufficient time to reach the coolant. However, this may affect the maximum pressure and reduce the engine power and increase the fuel consumption, yet the extra oxygen content of ABE may improve the combustion efficiency, thus producing a leaner mixture and achieving complete combustion. Therefore, ABE's higher latent heat, octane number, and extra oxygen contribute to the increase of gasoline engine torque.

Table 3. Contributions and main findings of recent studies using ABE-gasoline blends

Operating Conditions	Reference fuel	ABE Percentage	Contribution and novelty	Main Findings	Refs.
SI PFI, 1500 rpm, 20° BTDC, 3.5 bar BMEP, wide open throttle	Gasoline	ABE20 (3:6:1), ABE40	The first to investigate ABE in SI engine without major modifications	<ul style="list-style-type: none"> > ABE20 shows higher and advanced in-cylinder peak pressure ABE40 shows lower but advanced peak pressure > ABE20 gives shorter ignition delay ABE40 gives longer ignition delay > BSFC ↑ with increasing ABE percentage > CO: ABE20 --> ↑ ABE40 --> ↓ > HC: ABE20 --> ↑ ABE40 --> ↑ > NOx: ABE20 --> No changes ABE40 --> No changes 	[161]
SI PFI, 1200 rpm, 20° BTDC, 3 bar BMEP, $\phi=0.83-1.2$	Gasoline	ABE20 (3:6:1), ABE40, ABE60, ABE80	One of the early studies investigating ABE-gasoline blends in SI engine with various ABE concentration; from low, mid to a high percentage	<ul style="list-style-type: none"> > Lower ABE ratio gives a longer ignition delay & retarded 50% MFB > ABE80 has similar combustion phasing with gasoline > BSFC ↑ with increasing ABE percentage > ABE20 & ABE40 displayed ↑ efficiency than gasoline > ↓ CO & HC & no major changes in NOx for all blends 	[162]

SI PFI, 1200 rpm, MBT, 3 and 5 bar BMEP, $\phi=0.83-1.25$	Gasoline	ABE30 (3:6:1), ABE30 (6:3:1)	Investigating the effect of acetone by increasing its ratio from 30% to 60%	<ul style="list-style-type: none"> > Combustion phasing: ABE30 (6:3:1) --> similar to gasoline <li style="padding-left: 20px;">ABE30 (3:6:1) --> advanced phasing > BSFC: ABE30 (6:3:1) --> the lowest <li style="padding-left: 20px;">ABE30 (3:6:1) --> the highest > BTE: ABE30 (6:3:1) --> 1.6% higher than gasoline <li style="padding-left: 20px;">ABE30 (3:6:1) --> 0.5% lower than gasoline > CO: ABE30 (6:3:1) --> similar to gasoline <li style="padding-left: 20px;">ABE30 (3:6:1) --> \uparrow > HC: ABE30 (6:3:1) --> \uparrow due to high evaporability if acetone <li style="padding-left: 20px;">ABE30 (3:6:1) --> \downarrow > NOx: ABE30 (6:3:1) --> No major changes <li style="padding-left: 20px;">ABE30 (3:6:1) --> No major changes 	[163]
SI PFI, 1200 rpm, 18° BTDC & MBT, 3 bar BMEP, $\phi=0.83-1.25$	Gasoline	E85, B85, ABE85 (3:6:1)	Comparatively studying higher ABE percentage (ABE85) with higher concentration of ethanol (E85) and butanol (B85)	<ul style="list-style-type: none"> > In-cylinder peak pressure: <ul style="list-style-type: none"> The highest --> E85, the lowest --> B85 > Combustion phasing: <ul style="list-style-type: none"> The most advanced --> E85, the most retarded: B85 > Ignition delay and combustion duration in the sequence of B85>Gasoline>ABE85>E85 > All blends have \downarrow BTE and \uparrow BSFC > All blends have \downarrow NOx, but B85 gives the highest CO & HC 	[164]
SI PFI, 1200 rpm, MBT, 3 bar BMEP, $\phi=0.83-1.25$	Gasoline	ABE30 (3:6:1), ABE29.5W0.5	The first to investigate water-containing ABE-gasoline blends	<ul style="list-style-type: none"> ABE29.5W0.5 performed better than ABE30 > Longer ignition delay & combustion duration > Torque: \uparrow 9.6-12.7% > BTE: \uparrow 5.2-11.6% > BSFC: similar to gasoline > \downarrow CO, \uparrow HC, \downarrow NOx 	[158]
SI PFI, 1200 rpm, MBT, 3 and 5 bar BMEP, $\phi=0.83-1.25$	Gasoline	ABE30 (3:6:1), ABE85, ABE29.5W0.5, ABE29W1	Investigating ABE-gasoline blends up to 1% water addition	<ul style="list-style-type: none"> ABE29W1 performed better with \uparrow engine torque (3.1-8.2%), \downarrow CO (9.8-35.1%), \downarrow HC (27.4-78.2%) and \downarrow NOx emissions (4.1-39.4%) than those of gasoline 	[159]

SI PFI, 1200 rpm, MBT, 3 and 5 bar BMEP, $\phi=0.83-1.25$	Gasoline	ABE100 (3:6:1), ABE100 (6:3:1), ABE100 (5:14:1)	Examining pure ABE blends (100% ABE)	> The closest combustion phasing to gasoline --> ABE (6:3:1) 100 > \uparrow CO & HC emissions with increasing butanol ratio > ABE with higher acetone ratio, i.e. ABE (6:3:1) was preferred	[165]
SI PFI, 1200 rpm, MBT, 3 and 5 bar BMEP, $\phi=0.83-1.25$	Gasoline	ABE10 (3:6:1), ABE30 (3:6:1), ABE60 (3:6:1), E30, B30 ABE30 (1:8:1), ABE30 (5:4:1), ABE29.5W0.5 (3:6:1), ABE29W1	Investigating ABE concentrations with different volumetric ratios	ABE30 (3:6:1) performed better with \uparrow BTE (0.2-1.4%), \downarrow CO (1.4-4.4%), \downarrow HC (0.3-9.9%) and \downarrow NOx emissions (4.2-14.6%) compared to those of gasoline	[166]
1200 rpm, MBT, 3 and 5 bar BMEP, $\phi=0.83-1.25$	Gasoline	ABE30 (3:6:1), ABE30 (6:3:1)	The first to examine unregulated emissions of ABE-gasoline blends in SI engine	> ABE30 (3:6:1) gives the lowest ethylbenzene, \downarrow toluene, and \downarrow xylene > ABE30 (6:3:1) gives the lowest CO, \downarrow HC, \downarrow benzene, similar NOx to gasoline	[167]
SI, PFI, 1200 rpm, each fuel's MBT, 3,4,5,6 bar BMEP, $\phi=0.83-1.25$	Gasoline	ABE30 (3:6:1), ABE30 (6:3:1), ABE30 (5:14:1), E30, B30	Investigating unregulated emissions classified as air toxics by USEPA	The lowest CO & HC --> ABE30 (6:3:1) The highest acetaldehyde --> B30 The lowest acetaldehyde --> ABE30 (6:3:1) The lowest BTEX --> ABE30 (3:6:1)	[168]

3.1.2 Fuel consumption

Brake specific fuel consumption (BSFC) represents the ratio of mass fuel consumption to the brake power. The use of oxygenated fuel, including the ABE, may increase the BSFC due to its low heating values as shown in Table 1. As a result, the amount of ABE should be increased to obtain the same energy output of gasoline, thus increasing the BSFC. Zhang et al. [164] reported that the ABE85 had higher BSFC (543 g/kWhr) compared to gasoline (382 g/kWhr) and 85% Butanol (509 g/kWhr), but still lower than 85% Ethanol (584 g/kWhr) as shown in Fig. 3. Nithyanandan et al. [162] found an increasing trend of BSFC with the increase of ABE ratio. The increase in BSFC was around 5% for ABE20 and 25% for ABE80 compared to gasoline. Also, Li et al. [159] found that ABE30 and ABE85 increased the indicated specific fuel consumption (ISFC) by 10.1% and 29.4% compared to gasoline. Moreover, Li et al. [166] compared ABE30 with different volumetric ratio and it was found that the ABE30 (3:6:1) gave the lowest BSFC compared to that of ABE (1:8:1) and ABE (5:4:1) due to its relatively shorter combustion duration and higher thermal efficiency.

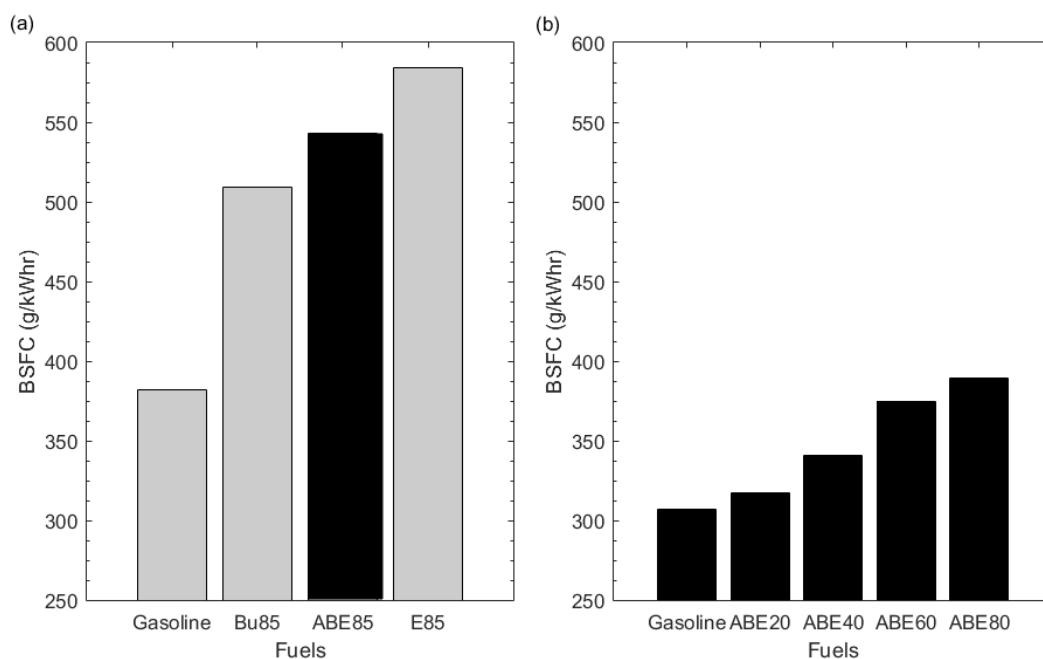

Fig. 3. (a) BSFC of ABE compared to other alcohol fuels at $\phi = 1$, reproduced from [164] and (b) BSFC of various percentage ABE [162]

One crucial factor that may increase BSFC is less fuel conversion efficiency. The start of combustion may be changed with the addition of ABE. In this case, the fuel conversion efficiency may be deteriorated due to altered combustion phasing, thus increasing the BSFC. Nithyanandan et al. [161] found that the centre combustion of ABE20 and ABE40, represented by 50% MFB, were advanced about 1.2° and 0.3° , respectively. Therefore, to achieve the maximum brake torque, the spark timing should be adjusted to avoid the reduction in fuel conversion efficiency that would later increase the BSFC. Li [167] found that equivalence ratio also influenced the BSFC. At lower stoichiometric air/fuel ratio, the ABE-gasoline blends required more fuel, thus increasing the BSFC. Also, Li et al. [158] found that the addition of water was found to reduce the BSFC. It was observed that the BSFC was around 12.1% higher with ABE30 compared to that of gasoline, but with 0.5% water addition, the ABE29.5W0.5 only increased it by 1.4% or similar with that of gasoline, resulted from its higher combustion and thermal efficiency.

3.1.3 Thermal efficiency

Brake thermal efficiency (BTE) shows how efficient the fuel was converted into mechanical energy. BTE may increase with the increasing ABE ratio. Three main factors may contribute to the increase in BTE using ABE in SI engine; (1) its higher latent heat of vaporisation, (2) oxygen content and (3) higher laminar flame speeds compared to those of gasoline fuel. When 0.5% and 1% water was added into the ABE blends, an improvement in BTE was observed, Li et al. [158] reported that ABE29.5W0.5 gave higher BTE by 5.2%-11.6% and 10.7%-12.4% compared to gasoline and ABE30, respectively. Also, Li [167] found that equivalence ratio affected the BTE. At higher stoichiometric air/fuel ratio, it was found that the ABE-gasoline blends gave higher BTE than that of a lower ratio. Nithyanandan et al. [161] reported a slight increase in the BTE for ABE20, while a decrease was observed for ABE40. Nithyanandan et al. [163] found an increase by 1.6% and a reduction by 0.5% in BTE for ABE30 (6:3:1) and ABE30 (3:6:1), respectively. ABE with higher acetone content, i.e. ABE30 (6:3:1) gave higher BTE due to its improved combustion compared to ABE with less acetone and higher butanol i.e. ABE30 (3:6:1). This is because blends with lower carbon number (less butanol ratio) have more oxygen, thus enhancing its combustion and increasing its thermal efficiency. However, although its enhanced combustion resulted from extra oxygen, Li et al. [166] found a BTE reduction in ABE addition. The reduction was because the engine was operated at the spark timing of gasoline's Maximum Brake Torque which was 18° BTDC at 310.33 kPa BMEP and 15° BTDC at 524.07 kPa BMEP. Therefore, the ABE reduction was attributed to improper combustion phasing. Among the tested fuels, ABE30 (3:6:1) gave a marginal BTE reduction by 0.2-1.4% than gasoline, but it still offered a higher BTE compared to ABE30 (1:8:1) and ABE30 (5:4:1).

3.1.4 Exhaust gas temperature (EGT)

EGT represents the cylinder temperature and an indicator of combustion efficiency and NO_x emissions. The use of ABE blends is expected to lower the exhaust gas temperature, and this is caused by its lower heating value and higher latent heat. Higher latent heat means that ABE will generate a significant temperature drop during the intake stroke, thus reducing the temperature at the end of the compression stroke. As a result, for the same heat release, the EGT will be lower after the combustion. Nithyanandan et al. [161] reported a slight decrease in EGT with the addition of ABE. It was found that gasoline gave the highest EGT with 429.5 °C, while ABE20 and ABE40 showed a slight decrease which stood at 426 °C and 420.6 °C, respectively. Nithyanandan et al. [163] observed no significant changes in exhaust gas temperature. The EGT of ABE30 (3:6:1) and ABE30 (6:3:1) had a similar temperature of around 430 °C with gasoline.

3.2 Combustion

Since each ABE component has higher laminar flame speed compared to gasoline, the combustion duration is more likely to be faster. Nithyanandan et al. [161] found that the ABE20 gave a shorter ignition delay and an advanced 50% Mass Fraction Burnt (MFB) location compared to the ABE40, resulted from the higher laminar flame speed of ABE. However, the ABE40 showed deteriorated combustion quality because of improper combustion phasing and high latent heat of vaporisation. In another study, compared to higher ABE ratio, Nithyanandan et al. [162] reported that lower ABE ratio gave a longer ignition delay and retarded 50% MFB location caused by the reduction in laminar flame speed resulted from ABE's evaporative cooling effect. Therefore, higher ABE ratio such as ABE80 was found to have similar combustion phasing with gasoline with shorter ignition delay because of its higher laminar flame speed. Li et al. [166] found that the use of ABE30 (3:6:1) and ABE60 (3:6:1) displayed a relatively early combustion phasing with a shorter Initial Combustion Duration (ICD) and Main Combustion Duration (MCD) than those of gasoline. Comparable results were found by Li et al.

[159] when comparing ABE30 and ABE85 with gasoline. Fig. 4 shows that the ICD and MCD reduce with increasing ABE concentration. However, when water was added, the ICD and MCD were increased for 0.5% water addition but decreased for 1% water. At equivalence ratios ($\phi=0.83-1.25$) and engine loads (3 and 5 bar BMEP), the ABE29 with 1% water addition gave a faster combustion rate than gasoline for leaner mixtures, while the opposite trend was observed for richer mixtures. Also, Li et al. [158] found that ABE29.5W0.5 displayed a longer ignition delay and combustion duration. Water addition was believed to reduce the combustion temperature and led to a lower combustion rate. It is important to note that at higher engine loads, faster combustion duration is expected due to the faster heat release rate.

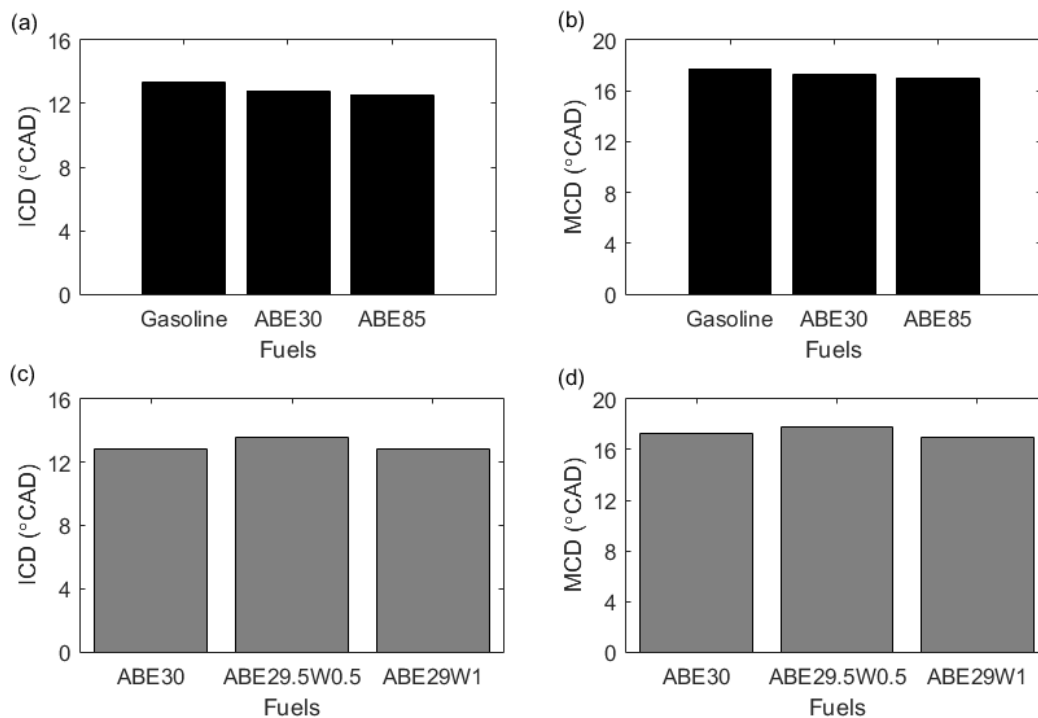

Fig. 4. Comparisons of combustion characteristics between ABE (a and b) and water-containing ABE (c and d) at $\phi = 1$ and 3 bar BMEP, reproduced from [159]

3.3 Emission

3.3.1 CO and HC emission

ABE has the potential to reduce both the CO and HC emissions. Oxygen content found in ABE will generate the leaning effect, improve the combustion efficiency, reduce HC emissions and allow in greater conversion of CO to CO₂, resulting in higher CO₂ emissions of ABE than gasoline. Also, the higher laminar flame speed of ABE can help to achieve complete combustion. However, the lower LHV of ABE may avoid the blends achieving complete combustion. Various operating conditions may also affect the CO and HC emissions.

Li et al. [166] found that ABE30 (3:6:1) gave a lower CO and HC emissions by 1.4-4.4% and 0.3-9.9%, respectively compared to gasoline. Li et al. [167] found that acetone's higher volatility and improved post-flame oxidation are beneficial to reduce CO and HC emissions. It was found that ABE30 (6:3:1) gave lower CO and HC emissions compared to ABE30 (3:6:1) and gasoline as shown in Fig. 5. Also, Li et al. [168] found the lowest CO and HC emissions were achieved at higher acetone content, i.e. ABE30

(6:3:1), compared to ABE30 (3:6:1), and ABE30 (5:14:1). Nithyanandan et al. [163] found decreased HC emissions for ABE30 (3:6:1) due to incomplete combustion. However, when the acetone content was increased to ABE30 (6:3:1), an increased in HC emissions was reported, believed to be from high evaporability of acetone that increased the unburned hydrocarbons in the crevice. Moreover, Nithyanandan et al. [165] found that by increasing the butanol content from ABE (6:3:1) to ABE (3:6:1) and ABE (5:14:1), the CO and HC emissions were found to increase due to incomplete combustion. Nithyanandan et al. [161] found higher CO emission for ABE20 as some fuels were only partly oxidized. Regarding water containing ABE, Li et al. [158] found reduced CO emissions with ABE29.5W0.5 but increased HC emissions due to a retarded HC oxidation resulted from reduced combustion temperature caused by water addition. When water was added up to 1%, Li et al. [159] found that ABE29W1 displayed a more significant reduction of CO and HC emissions by 9.8-35.1% and 27.4-78.2%, respectively.

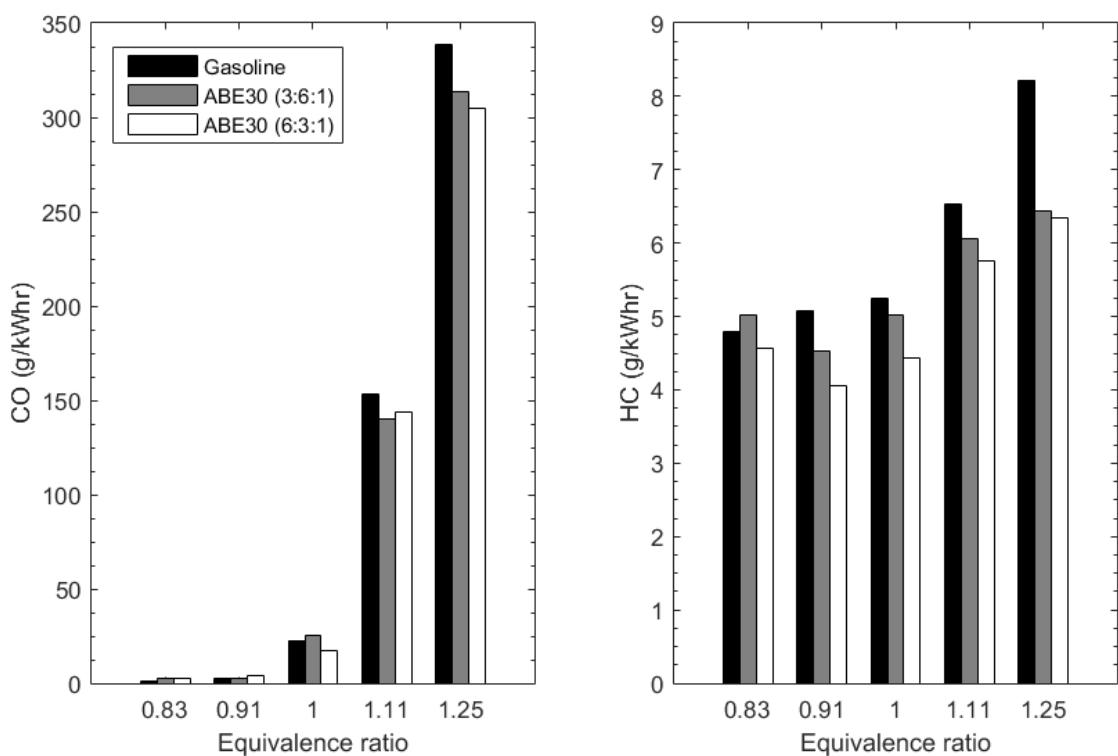

Fig. 5. CO and HC emissions at 3 bar BMEP at different equivalence ratios, reproduced from [167]

In general, the addition of ABE could decrease the CO and HC emissions compared to gasoline fuel due to its leaning effect. It is important to note that different engine operating conditions may also affect such emissions. In a gasoline engine, at high engine loads, the lack of oxygen in the richer region may increase the CO and HC emissions. However, at low engine loads, higher emissions can also still be observed since the mixture is too lean to burn and it is difficult to maintain the flames because of low flame propagation speed. This is where the extra oxygen and higher flame speed provided by the addition of ABE play a vital role to reduce CO and HC emissions at various engine loads. At high engine speeds, although the engine does not have sufficient time to complete combustion, the higher flame speed of ABE is expected to help achieve complete combustion. Moreover, the mixture at high engine speed may be more homogeneous leading to improve combustion and higher in-cylinder temperature. As a result, both CO and HC will reduce at high engine speeds. The trend may be the

opposite for low engine speed as the higher latent heat of ABE may reduce the in-cylinder temperature, thus increasing CO and HC emissions.

3.3.2 NO_x emission

Higher in-cylinder temperature is considered as the significant reason of thermal NO_x formation in a gasoline engine [155]. The oxygen content in ABE fuel may increase the in-cylinder temperature, but the charge cooling effect from ABE's high latent of heat vaporisation may outweigh such effect, thus reducing the in-cylinder temperature. No major changes in NO_x emissions were observed by Li et al. [167] for ABE30 (3:6:1) and ABE30 (6:3:1). Comparable results were also observed in [161], [162], [163] and [167] where ABE blends gave nearly similar NO_x emissions compared to gasoline. However, some studies reported reductions in NO_x emissions. Li et al. [166] reported a reduction in NO_x emissions by 4.2-14.6% using ABE30 (3:6:1) than gasoline. However, Fig. 6 shows the highest NO_x emissions are found at ϕ between 0.9 and 1.0 due to more complete combustion close to the stoichiometric region that leads to a higher peak combustion temperature. Regarding water-containing ABE blends, Li et al. [158] found lower NO_x emissions resulted from reduced combustion temperature caused by 0.5% water addition into the ABE blend. With 1% water content in the ABE blend, Li et al. [159] found that ABE29W1 displayed a more significant reduction of NO_x emissions by 4.1-39.4%. In general, NO_x formation from ABE addition can be reduced or maintained at the same level as that of a gasoline engine. This is attributed to ABE's higher latent heat that results in the cooling effect inside the combustion chamber.

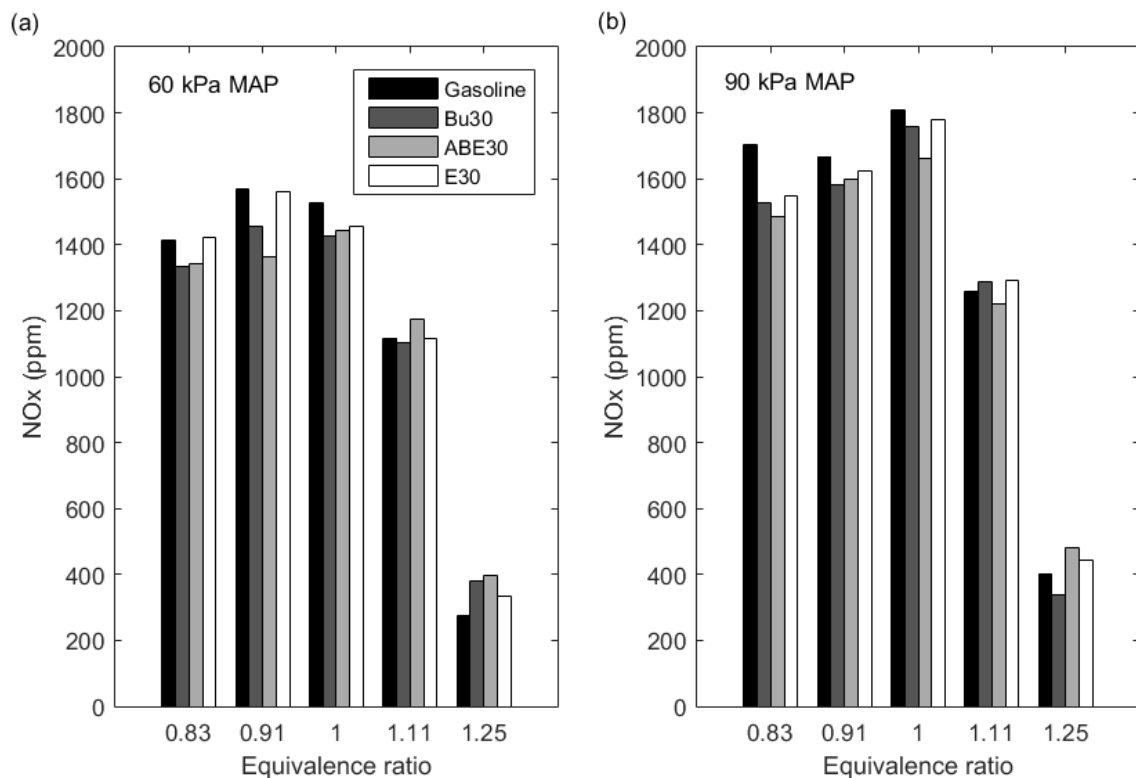

Fig. 6. NO_x emissions of ABE30 in comparison with other alcohol fuels at different equivalence ratios and engine loads; (a) 60 kPa and (b) 90 kPa, reproduced from [166]

3.3.3 Particulate matter (PM) emission

No studies can be found in the literature examining the effect of ABE on PM emissions of a gasoline engine. It is known that conventional port-fuel injection (PFI) gasoline engine produces less soot emission than diesel engine thus more attention to investigate PM emission is directed towards diesel engine. However, gasoline direct injection (GDI) engine may produce higher PM emissions compared to traditional PFI gasoline engine, as a result of its fuel-rich regions and local high temperature from incomplete combustion [169]. Therefore, more researches are needed to examine PM emissions of the GDI engine.

Although previous studies have not yet examined the effect of ABE on PM emissions of a gasoline engine, the effect of its individual component i.e. ethanol and butanol could be found in the literature. Luo et al. found that ethanol/gasoline blend could reduce PM emissions of GDI engine effectively [170]. It was observed that the soot activity was enhanced, and particle number concentrations were successfully decreased. Furthermore, a study by Graves et al. [171] found that particle number concentration reduced with the increase of ethanol fraction. By using 20% ethanol, Peña et al. [172] found reductions in the rate of soot production, the sizes of polycyclic aromatic hydrocarbons and primary particles in soot, and its aromatic character resulting in higher soot oxidative reactivity.

Similar to the combustion of other oxygenated fuels such as ethanol, butanol could decrease the particulate production due to the involvement of the oxygenated compound in the particulate formation. Russo et al. [173] found that a substantial reduction of the soot particles' total amount and size were achieved using butanol isomers. Of four isomers, t-butanol was found as the most effective to reduce particle formation. Furthermore, Hergueta et al. [174] investigated 33% of butanol containing 5% of ethanol (B33) in a gasoline engine. It was found that the gaseous and particle emissions were successfully decreased with primary particle diameter being unaffected. Yu et al. [175] also reported reductions of gaseous emissions using n-butanol/gasoline blends in SI engine. N-butanol could decrease the accumulation mode of particle number, while at the same time increasing its nucleation mode. The lowest total particle number was achieved under a rich mixture with 20% n-butanol.

Despite lacking some fundamental studies, the use of ABE is expected to lower the particle production in gasoline engine due to its oxygen content. Generally, the presence of oxygen atoms in ABE is expected to alter the oxidation pathway by enhancing carbon oxidation to the growth pathways, thus forming high molecular mass compounds [176, 177]. However, it is important to note that fuels with comparable oxygen content may affect particle production differently such as found in diesel engine [178, 179]. This is because other factors may affect fuels' properties such as the oxygenated functional groups.

4. ABE addition in diesel engine

Table 3 summarises several novelties of recent studies using ABE-diesel blends in CI engine. Important findings are highlighted, and detail discussions are presented in this section.

4.1 Performance

4.1.1 Power and torque

Engine power represents the amount of work produced by the engine per unit time, while torque measures rotational work by the piston on the engine crankshaft. ABE may reduce both the engine power and torque due to their lower LHV compared to diesel fuel. Lee et al. [180] found that the use of ABE (3:6:1) in CI engine was found to reduce engine power by 5% at 1200 rpm as shown in Fig. 7.

When the acetone content was increased, and the butanol was decreased from a typical ratio of 3:6:1 to 6:3:1, the ABE (6:3:1) reduced the engine power even further up to 8%. According to table 1, the heating value of ABE (3:6:1) is not much different from ABE (6:3:1), but boiling point of ABE (6:3:1) is far higher than ABE (3:6:1) due to increased acetone and reduced butanol content. Therefore, the reason ABE (6:3:1) gave lower power was not only caused by its lower heating value (3.3% lower) but it was also caused by its far lower boiling point (19.1% lower). The lower boiling point may lead to faster evaporation and better fuel efficiency [105, 181], but it may also result in less penetration, thus reducing the power output. It is important note that the extra oxygen of ABE may improve combustion at higher speeds and offset the power loss caused by its lower heating value and boiling points.

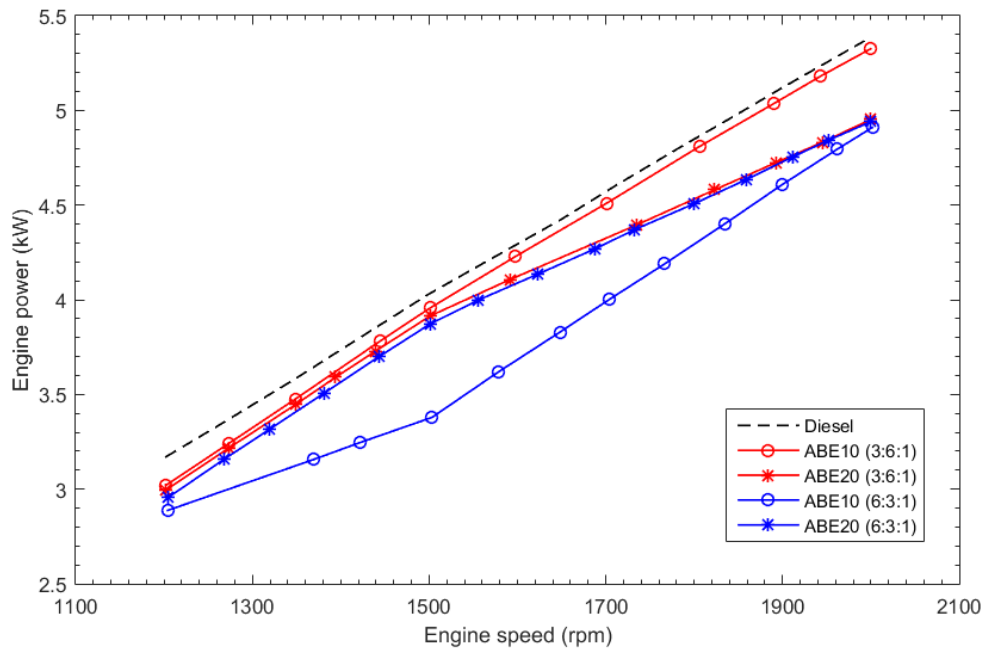

Fig. 7. Engine power of different ABE volumetric ratio at various engine speed, reproduced from [180]

Algayyim et al. [107] compared the use of n-butanol and iso-butanol in butanol-acetone (BA) mixture. For 10% and 20% concentrations of BA, the iso-BA and n-BA reduced the brake power (BP) and torque at all engine speeds; 1400, 2000 and 2600 rpm, except for iso-BA with 10% concentration at the medium speed where 4% increase was observed than those of diesel. In another study, the same author also found comparable results in which 20% and 30% BA mixtures gave lower BP and torque [106]. Only BA with 10% concentration increased the BP and torque. The torque increased slightly, while BP rose by 5% compared to that of diesel at all engine speed.

Reduction of engine power using ABE may be attributed to its lower LHV and boiling points, but other factors may also worsen such power loss. Lower cetane number of ABE for example. Low cetane number will prolong the ignition delay and achieve better fuel-air mixing with stronger premixed combustion. This may result in higher maximum in-cylinder pressure [182], but the mean effective pressure is expected to decrease, thus reducing the overall engine power and torque. Furthermore, lower viscosities of ABE may result in more leakage in the injector where fuel delivery may be affected and decrease the power output [183-186]. More results are required in terms of engine power or torque, but only a few studies reported these two parameters using ABE blends. This is because when

the injection is based on the equal-mass instead of equal-energy, the engine performance is given in efficiency for better comparison.

Table 4. Contributions and main findings of recent studies using ABE-diesel blends

Operating Conditions	ABE%	Contribution and novelty	Main Findings	Refs.
Direct Injection CI engine, (1) Generator 1.6 & 3.2 kW, (2) Dynamometer: 1500 & 1800 rpm, 40 & 80 Nm	ABE10 (5:14:1), ABE20, ABE30 ABE10W0.5, ABE20W0.5, ABE30W0.5 ABE20W1, ABE30W1	The first to investigate water- containing ABE-diesel blends in CI engine	> Clear stable phase of ABE with 0.5-1.0% water addition > ABE20W0.5 shows superior results: ↑ BTE by 3.26-8.56% ↓ PM by 5.82-61.6% ↓ NOx 3.69-16.4% ↓ PAHs by 0.699-31.1% ↓ BaP _{eq} by 2.58-40.2%	[103]
Constant volume chamber Ambient temperature: 900 & 1100 K, Ambient oxygen concentration: 21%	ABE20 (6:3:1), ABE20 (3:6:1), ABE20 (0:10:0)	Exploring the optimal ABE ratio by changing its volumetric ratio	> Ignition delay and the combustion duration are ↓ with ↑ acetone content > ABE20 (6:3:1) has the shortest combustion duration, may ↑ fuel efficiency in real CI engine > ABE20 (6:3:1) has the same ignition delay and premixed combustion with diesel > At 900 K, soot is ↓ due to ↑ soot lift-off length (SL _{oL}) and ↑ ignition delay for all the tested fuels > At 900 K, max combustion pressure is ↑, may ↑ ITE > Natural luminosity is ↓ for ABE20 (3:6:1) and ABE20 (6:3:1)	[104]
Direct Injection CI engine, Speed: 1500 & 2000 rpm, Load: 40 & 80 Nm	Biodiesel25, B50, B75 ABE25B25 (5:14:1), ABE25B50, ABE25B75	Investigating the mix of water- containing ABE (2% water) with biodiesel.	> Water containing ABE lead to ↑ BSFC > ABE-biodiesel-diesel blends result in ↑ BTE by 0.372- 7.88% compared to biodiesel and diesel > ABE-biodiesel-diesel blends shows ↓ PM by 10.9- 63.1%, ↓ NOx by 4.30-30.7% and ↓ PAH emissions by 26.7-67.6%	[187]

Constant volume chamber Ambient temperature: 800, 1000, & 1200 K, Ambient oxygen: 11, 16 & 21%	ABE100 (3:6:1), B100	Investigating the spray and combustion of pure ABE in both conventional and low temperature combustion (LTC) with various oxygen concentration to represent the variations of EGR	<p>> ABE100 shows:</p> <ul style="list-style-type: none"> ↑ flame lift-off length ↓ liquid penetration ↓ local equivalence ratio ↓ flame luminosity ↓ combustion duration with ↓ ambient temperature because of stronger premixed combustion ↑ combustion duration with ↓ ambient oxygen as a result of a dilution effect retarded combustion phasing like butanol under LTC with ↑ EGR 	[188]
Constant volume chamber Ambient temperature: 700, 800, 900, 1000, 1100 & 1200 K, Ambient oxygen: 11, 16 & 21%	ABE20 (3:6:1)	Investigating LTC of the spray and combustion of ABE-diesel blends	<p>> Under all test conditions, ABE20 shows longer ignition delay and soot lift-off length compared to diesel</p> <p>> At low ambient temperature of 800 K and ambient oxygen of 11%, ABE20 shows flameless combustion with almost zero soot luminosity</p> <p>> The multi-component of ABE blends with different volatilities produce micro-explosion that lead to better atomization and air-fuel mixing, thus achieving improved combustion efficiency</p>	[109]
Constant volume chamber Ambient temperature: 800 K Ambient oxygen: 11, 16 & 21%	ABE20 (6:3:1), ABE20 (3:6:1), ABE20 (0:10:0)	Examining the effect of acetone in ABE blends by changing the volumetric ratio from typical fermentation ratio of 3:6:1 to 6:3:1 and 0:10:0 in LTC	<p>> SOC retarded with decreasing ambient oxygen concentration for all fuels, but ABE20 (6:3:1) is similar to that of diesel</p> <p>> ABE20 (6:3:1) shows similar combustion to diesel with shorter ignition delay due to higher acetone content</p> <p>> ABE20 (6:3:1) shows ↓ natural flame luminosity (soot formation) compared to diesel due to its ↓ combustion duration and stronger premixed combustion</p>	[189]

Various ambient temperatures (423-823K) under normal gravity and atmospheric pressure	ABE10 (3:6:1), ABE20, ABE30	Investigating the evaporation characteristics of ABE-diesel droplets	<ul style="list-style-type: none"> > The droplet lifespan of ABE and diesel are ↓ with ↑ ambient temperature > ABE's droplet lifespan is ↓ than diesel with no bubble nucleation, but the difference is smaller at ↑ temperature > ABE droplets evaporate faster than diesel but vary with ambient temperature; two-phase at ↓ temperature and three-phase at ↑ temperature > ABE droplets show bubble formation and rupture at ↑ temperature with strong puffing being observed at 823 K 	[190]
Constant volume chamber Ambient temperature: 800, 1000 & 1200 K, Ambient oxygen: 11, 16 & 21%	ABE20 (3:6:1), ABE50, ABE80	Investigating the spray and combustion of ABE-diesel blends in both traditional and LTC with heavy EGR condition	<ul style="list-style-type: none"> > Spray characteristics are influenced by competing factors between volatility and latent heat with ABE20 = diesel and ABE50 = ABE80. Therefore, critical ratio occurs between ABE20 and ABE50 > Except for ABE50, ignition delay ↑ with ↓ ambient temperature, ↓ oxygen concentration, and ↑ ABE% > Combustion characteristics ABE50 = diesel with the shortest combustion duration of all blends --> may lead to ↑ ITE > Soot (natural flame luminosity) ↓ with ↑ ABE% 	[108]
Constant volume chamber Ambient temperature: 1000 K, Ambient oxygen: 11, 16 & 21%	ABE100 (3:6:1)	Investigating a phenomenological soot model for ABE both experimentally and numerically	<ul style="list-style-type: none"> > Ignition delay retarded and temperature become more homogeneous with ↓ ambient oxygen > Compared to 21% ambient oxygen, the 16% gives ↑ total soot mass due to the ↓ soot oxidation --> ↑ soot > At 11% ambient oxygen, both soot formation and oxidation are ↓, with more ↓ for the soot formation --> ↓ soot 	[191]

Direct Injection CI engine, Speed: 1200, 1500, 2000 rpm, Load: 15, 20, 25 mg fuel/cycle Equivalence ratio: 0.323, 0.431, 0.539 Injection timing 8, 4, 0, -4 °CA BTDC Fuel rail pressure: 600 bar	ABE10 (3:6:1), ABE20 (3:6:1)	Focusing on the HC emissions and on the improvement of efficiency with ABE addition that has not yet reported in the previous paper	> ABE retard the start of auto-ignition At premixed mode: ↓ combustion duration At mixing-controlled mode: ↑ combustion duration > ABE blends have ↑ thermal efficiency due to ↑ pressure rise rate during CA10-CA50 leading to a dominant premixed combustion > ABE have ↓ polytropic & ↑ HC	[192]
Constant volume chamber Ambient temperature: 800 K Simulation with KIVA-3V Release 2 code	ABE20 (6:3:1), ABE20 (3:6:1), ABE20 (0:10:0)	Investigating fundamental numerical methods and chemical kinetic mechanisms for ABE-diesel blends	> ↑ acetone content leads to advanced combustion phasing > ↑ butanol content leads to retarded combustion phasing	[193]
Direct Injection CI engine, Speed: 1200, 1500 & 2000 rpm, Load: 15, 20 & 25 mg fuel/cycle Equivalence ratio: 0.323, 0.431 & 0.539 Injection timing 8, 4, 0, -4 °CA BTDC Fuel rail pressure: 600 bar	ABE10 (3:6:1), ABE20 (3:6:1), ABE10 (6:3:1), ABE20 (6:3:1)	The first to investigate ABE with volumetric ratio of 6:3:1 in CI engine (not in volume constant chamber) and compare it with ABE with a 3:6:1 ratio	> ABE (6:3:1) have retarded combustion, ↑ ignition delay & ↓ emissions compared to ABE (3:6:1) > Small amount of ABE (10%) results in ↑ ITE by 12% > ABE addition cause ↑ heat release during CA10-CA50 as a result of ↑ premixed combustion > NO _x is ↓ with ABE addition and can be reduced even further by tuning the injection timing	[180]
Constant volume chamber Ambient temperature: 800 & 1200 K Ambient oxygen: 16 & 21%	ABE100 (3:6:1)	The first to study the different soot formation between diesel and ABE using phenomenological soot model simulated by KIVA-3V Release 2 code	> ABE100 gives ↓ soot generation compared to diesel > At 800 K and 21% oxygen concentration, soot mass peak of ABE is 1/12 of diesel's, but when oxygen concentration ↓ to 16%, the soot mass peak ↑ by 25%	[194]

Direct Injection CI engine, Speed: 1400, 2000 & 2600 rpm, Full loads	(1) n-butanol: n-BA10, n-BA20 (2) iso-butanol: iso-BA10, iso-BA20	Comparing the use of n-butanol and iso-butanol in BA (1:2.9) mixtures on the spray, combustion, performance and emission characteristics	<ul style="list-style-type: none"> > Spray penetration: ↑ with n-BA and iso-BA n-BA is slightly ↑ than iso-BA > BSFC: ↑ with increasing n-BA and iso-BA > BP: iso-BA10 shows slight ↑ at low & medium speeds > In-cylinder pressure: iso-BA shows ↑ peak led to ↑ HRR > CO: ↓ with increasing n-BA and iso-BA iso-BA has a lower NO_x than n-BA > HC: n-BA: ↓ or the same with diesel iso-BA: ↑ > EGT: ↓ with increasing n-BA and iso-BA > NO_x: ↓ with increasing n-BA and iso-BA n-BA has a lower NO_x than iso-BA 	[107]
Wick-fed burner --> to produce a stable diffusion flame 47 mm filter assembly --> collect the soot particles	ABE10 (3:6:1), ABE20, ABE30	Investigating the soot oxidation reactivity of ABE-diesel blends	With increasing ABE concentration, the size of primary particles ↓, nanocrystallites length ↓, and amount of aromatic C=C functional groups in the soot ↓, while nanocrystallites tortuosity ↑, amount of oxygenated functional groups ↑, and atomic O/C and H/C ratios ↑	[195]
Direct Injection CI engine, Speed: 1400, 2000 & 2600 rpm,	BA10 (1:2.9), BA20, BA30	Investigating the BA-diesel blends without ethanol content	<ul style="list-style-type: none"> > Advanced combustion phasing with increasing BA content > BP: BA10 --> ↑ 5% than diesel BA20 --> no change BA20 --> no change > BTE: BA10 --> no change BA20 --> ↑ 6% than diesel BA20 --> ↑ 8% > CO: ↓ 64.5% (maximum) > HC: ↑ 37.3% (maximum) > NO_x: ↓ 10% (maximum) > EGT: ↓ 15.6% (maximum) 	[106]

4.1.2 Thermal efficiency

The improvement in thermal efficiency may be attributed to the factors that help the completeness of the combustion, shorten the combustion process and improve combustion efficiency. Changing the operating condition will also affect the characteristics of engine thermal efficiency. The thermal efficiency is expected to increase with increasing engine load due to the higher gas temperature inside the cylinder, thus increasing its combustion and thermal efficiency. This is because more fuel is burned and combusted at high engine loads; thus a higher in-cylinder gas temperature is observed.

Slight increase in thermal efficiency can be achieved with a small amount of ABE addition to diesel fuel due to ABE's oxygen content and low boiling points. Extra oxygen of ABE is expected to lower its equivalence ratio, while the low boiling points will enhance its spray characteristics, thus more complete combustion can be achieved in the fuel-rich zone. As a result, engine thermal efficiency will improve. Lee et al. [180] found that with ABE10 (3:6:1), the indicated thermal efficiency (ITE) increased by 4-6% than diesel as shown in Fig. 8. The ITE increased even further up to 7% higher when ABE ratio was increased to 20%. Its nearly similar engine power compared to diesel fuel as discussed in 4.1.1 may also explain the increase in thermal efficiency from the addition of ABE blends. That ABE with its lower heating value can achieve engine power comparable to diesel fuel indicates that there is some improvement in its thermal efficiency. However, by changing the volumetric ratio of ABE from a typical of 3:6:1 to 6:3:1, the ITE was found to reduce. The authors believed that the longer ignition delay of ABE (6:3:1) resulted in a retarded start of combustion. As a result, the SOC extended into expansion stroke and the combustion did not burn to completion, thus reducing ITE.

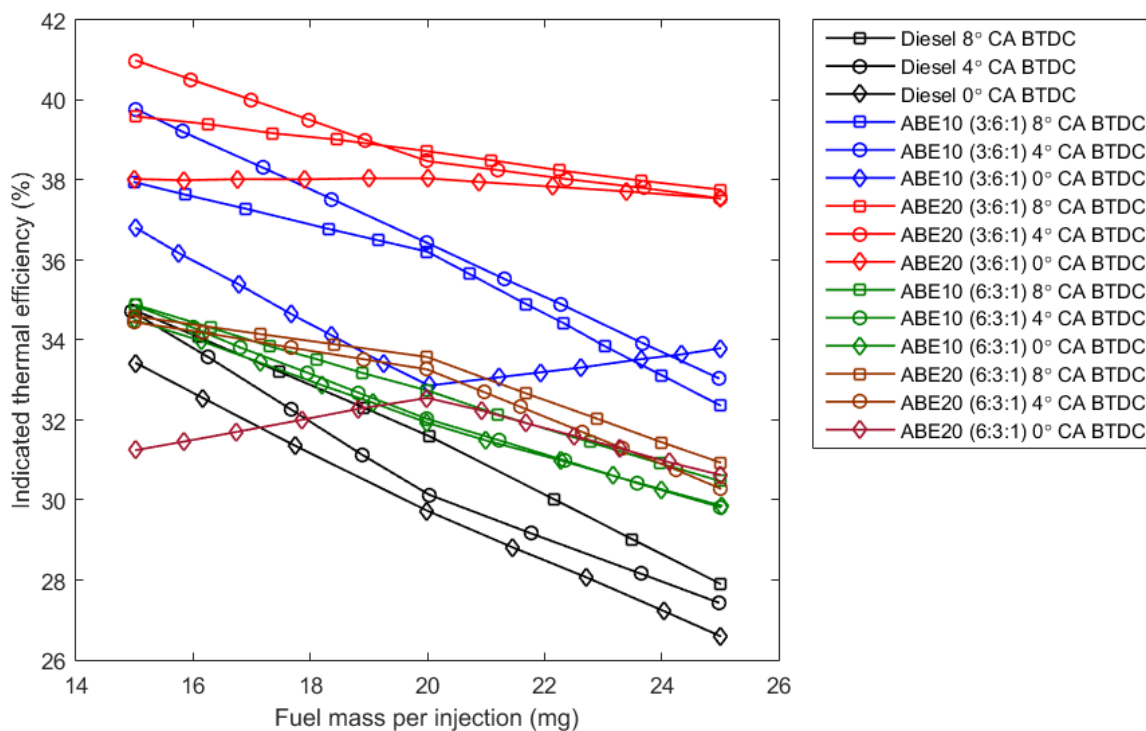

Fig. 8. ITE of different ABE volumetric ratio, reproduced from [180]

The use of water containing ABE can be considered as a favourable approach as it will remove the dehydration process and eliminate the need to add surfactant [103, 187, 190]. Chang [103] found that the addition of 20% ABE with 0.5% water increased higher BTE compared to diesel fuel when running both on engine dynamometer and generator. At dynamometer load of 40 and 80 Nm, the BTE of ABE20W0.5 increased by 3.26-4.52% and 13.0-14.7%, respectively. However, when it was operated on engine generator, while the ABE20W0.5 and ABE30W0.5 were found to increase the BTE, the ABE10W0.5 decreased it. Also, when the water concentration was further increased up to 1%, the ABE20W1 and ABE30W1 gave significant reductions of BTE. The inhomogeneity of the fuel from 1% water addition resulted in a cooling effect and misfiring that caused the unstable condition of the mixtures and incomplete combustion. Based on the fuel stability results conducted in this study, ABE10W0.5 was at the edge between stable and unstable condition.

Only few studies were found investigating ABE with biodiesel addition. Biodiesel is considered a promising biofuel, but its high viscosity may deteriorate engine thermal efficiency [196]. The kinematic viscosity of biodiesel at 40 °C is 4.41 mm²/s, compared to 2.63, 0.35, 2.22 and 1.08 mm²/s for diesel, acetone, butanol, and ethanol, respectively [187]. An et al. [197] have reported the decrease of BTE with biodiesel at low load conditions. They believed that the high viscosity of biodiesel caused poor combustion resulted from less efficient atomization and as a result, decreased BTE was observed. However, the BTE of biodiesel blends may be improved with the addition of ABE due to its extra oxygen content. Chang et al. [187] mixed ABE containing 2% of water with biodiesel in the diesel engine. At various loads and engine speeds, biodiesel addition of 25, 50 and 75% increased the BTE by 0.372-2.74, 3.54-7.88, and 2.44-4.96%, respectively. These results indicate that the extra oxygen content of the ABE and its low viscosity were found to outweigh the negative effect of biodiesel addition.

As for the BA mixtures, the BA-diesel blends gave higher BTE compared to diesel fuel. Algayyim et al. [107] found that the increase BTE of BA with n-butanol was higher than BA with iso-butanol. Higher cetane number and density of n-butanol than those of iso-butanol were believed as the reasons. The cetane number of n-butanol is 25 [198] compared to <15 of iso-butanol [119], while the density of n-butanol is 0.810 compared to 0.802 kg/m³ of iso-butanol [4]. Higher cetane number of n-butanol may decrease the BTE due to deteriorated air/fuel mixing as a result of shorter ignition delay. However, it is important to note that the lower cetane number may also decrease the BTE. The longer ignition delay of iso-butanol caused by its low cetane number may result in the retarded start of combustion. This would extend the SOC into expansion stroke, and the combustion would not burn to completion, thus reducing BTE. In another study by the same authors using BA mixture with n-butanol [106], the BA20 and BA30 increased the BTE by 6% and 8%, while BA10 show similar results with diesel fuel. This time, the authors believed that lower cetane number as the reason higher BTE was observed with BA-diesel blends. Lower cetane number caused longer ignition delay; thus more fuel was burned in the premixed combustion mode, leading to shorter combustion and higher BTE.

The combustion characteristic can provide valuable information regarding engine thermal efficiency. Wu et al. [108] reported that ABE50 had the shortest combustion duration and better thermal efficiency compared to ABE20 and ABE80 due to its similar combustion characteristics with diesel fuel. The micro-explosion may answer why ABE50 had more similar combustion characteristics to diesel as Shen et al. [199] reported that the micro-explosions would be more likely to occur when the blends consist of a 50% high and low boiling point. Therefore, the shorter combustion of ABE50 and better thermal efficiency was observed in [108].

In general, the thermal efficiency of ABE blends is expected to increase due to three significant reasons. The first reason is due to more complete combustion resulted from its oxygen content and low boiling points of each ABE components. Extra oxygen will lower its equivalence ratio, while the low boiling points will improve its spray quality, thus more complete combustion can be achieved. As a result, the combustion efficiency will improve and so will the thermal efficiency. The second reason is caused by its strong premixed combustions due to a longer ignition delay resulted from ABE's low cetane number. Such a lower cetane number is expected to prolong the ignition delay and improve the air/fuel mixing and allowing rapid energy release. Therefore, combustion efficiency will increase. The third reason is due to micro-explosions that can accelerate the combustion rate of ABE blends. As ABE is a multi-component fuel, the different boiling point between each fuel components triggers micro-explosions. Furthermore, higher thermal efficiency may also be caused by the reduction in heat losses. This is because of the cooling effect resulted from ABE's high latent heat, thus reducing the flame temperature. However, the effect of the charge cooling effect may deteriorate the combustion characteristics of the ABE blends and decrease the engine thermal efficiency. The lower heating value of each ABE components compared to diesel may also lower the thermal efficiency. As the ABE concentration increases, the effects from its high latent heat and lower heating value will be more significant.

4.1.3 Fuel consumption

Most results have agreed that the addition of ABE will increase fuel consumption due to its lower calorific values. Chang et al. [103] investigated the BSFC of ABE at two generator engine loads; 1.6 and 3.2 kW. They found that the addition of 20 and 30% ABE increased the BSFC by 4.25-5.71% and 5.47-7.03%, respectively. The BSFC was reported to increase with increasing ABE concentration. This is because the heating value of the blend will decrease with more addition of ABE. However, when water was added into the ABE and ran on a dynamometer engine, the fuel consumption was found to decrease. The BSFC of ABE20W0.5 reduced by 1.76-3.39% and 7.28-8.56% compared to diesel at an engine load of 40 and 80 Nm, respectively. However, the effect of water containing ABE did not seem to give the same effect when blended with biodiesel. Chang et al. [187] reported that the use of 25% water containing ABE with 25, 50 and 75% of biodiesel increased the BSFC by 9.52-13.2, 12.8-15.1 and 20.3-23.0%, respectively. Similar results were shown with BA-diesel blends where the BSFC increased with the increasing BA ratio due to its reduced calorific values [106, 107]. At higher engine loads, the fuel consumption is expected to improve; thus BSFC is more likely to decrease because of high in-cylinder gas temperature.

Overall, several factors may influence the BSFC of ABE. These include higher latent heat, lower heating values, cetane number, viscosity and molecular weight of ABE components compared to diesel fuel. The higher latent of ABE blends may deteriorate the combustion due to its cooling effect. Its lower heating value also means that more fuel is required to match the power output of using diesel fuel, while its lower cetane number indicates that longer ignition delay may cause incomplete combustion. As for ABE's lower viscosity and molecular weight, improved fuel atomization and high volatility are expected, respectively. The lower viscosity will reduce the droplet's Sauter Mean Diameter (SMD). Therefore, the droplets surface area will increase, thus affecting the evaporation time [200, 201].

4.2 Spray and combustion

4.2.1 Spray

ABE may improve the spray characteristics of the ABE-diesel blends. The spray is predicted to become shorter and narrower as the ABE ratio increases, caused by the high volatility of the ABE components. The

properties of ABE as shown in Table 1 show that each component ABE has a higher saturation pressure, lower boiling point and lower viscosity compared to diesel fuel. The saturated vapour of acetone is far higher, 52.5 kPa compared to merely 1.9 kPa of diesel. As the ABE ratio increases, the difference in those values becomes more significant. As a result, the overall volatility increases and its evaporation rate will be faster than diesel fuel. As a result, the size of the ABE spray becomes shorter and narrower. Several studies have confirmed this finding, but some reported that this effect is not linear with the increase of ABE.

Wu et al. [108] used ABE-diesel blends from ABE20, ABE50, ABE80 in a constant volume chamber and compared the results with pure diesel. They found that the ABE50 offered better spray characteristics (shorter and narrower) compared to ABE20. The improvement in spray quality of ABE50 than the ABE20 was believed due to enhanced fuel droplet evaporation rate and spray atomization with the increase ABE ratio, resulted from its higher volatility characteristics as mentioned in the previous paragraph. However, when the ratio of ABE was further increased up to 80%, the spray of ABE80 exhibited a similar characteristic with ABE50. One of the reason might be attributed to the high latent heat of ABE component. As shown in Table 1, each ABE component has a far higher latent heating value (Acetone–518 kJ/kg, Butanol–582 kJ/kg, Ethanol–904 kJ/kg) compared to diesel fuel whose value is just 270 kJ/kg. It is known that high latent heating value will result in a cooling effect inside the combustion chamber. Increasing ABE ratio to a high ratio will reduce the local temperature and decrease the evaporation rate, thus deteriorating spray qualities. Therefore, the factors that improve the spray quality (higher volatility) are competing with the factors that deteriorate it (higher latent heat). This finding showed that there seems a critical ratio of ABE concentration between 20% and 50%. Less than 20% of ABE did not significantly improve its spray characteristics, while more than 50% ABE did not further improve its spray characteristics.

The spray is the evaporation of large droplets and considering the difficulty to examine the evaporation of ABE droplets in a spray, investigating its single droplet is considered a more realistic approach. Ma et al. [190] examined the droplet evaporation of ABE-diesel fuel in a non-combusting droplet chamber at ambient temperatures ranging from 423 to 823 K. The results showed that adding ABE could increase the evaporation speed of droplet, thus decreasing its lifespan. The ABE-diesel blends droplets evaporate faster than diesel but vary with temperature. With increasing ambient temperature, the droplet lifespan of ABE and diesel were decreasing, and smaller difference was observed at a higher temperature. At 623 K, the normalised square droplet diameter of ABE-diesel blends gave comparable results with diesel fuel, and at 823, various ABE-diesel blends also had similar droplet lifespan with diesel fuel. This study did not observe the micro-explosions with the addition of ABE-diesel blends. This is in contrast with the finding found in [109] where micro-explosion was reported with the addition of multi-components fuel such as ABE. However, the addition of water may be the reason for such micro-explosion due to water-in-oil droplets phenomena in the combustion chamber [103].

4.2.2 Combustion

The lower cetane number and higher latent evaporation of ABE are expected to retard the start of combustion due to a longer ignition delay and charge cooling effect. As a result, more fuel is burned at the premixed stage, and higher maximum pressure is expected to occur. Also, the lower density and viscosity of ABE could enhance the spray characteristics and improve the mixing process of air and fuel. Consequently, the maximum pressure and premixed heat release rate will increase. Lin et al. [192] found that the start of auto-ignition was retarded with shorter premixed combustion duration and longer

mixing-controlled duration being observed. ABE-diesel blends had higher pressure rise rate during CA10-CA50 compared to diesel, showing more premixed-dominant combustion [180]. This is because higher oxygen content in the spray is known to decrease the pyrolysis and increase the oxidation, thereby reducing the combustion duration at premixed mode. However, the increase in pressure rise rate may result in increased engine noise and vibration. Also, with faster premixed combustion rate, higher combustion temperature will increase the NO_x emissions. While the premixed combustion duration was shortened, the mixing-controlled duration was longer. The duration of CA50-CA90 was higher at all speeds, showing a slower heat release rate in mixing-control combustion stage. This will cause higher combustion inefficiency leading to increased HC emissions. Under LTC conditions and high EGR, the retardation of combustion phasing was also observed, Wu et al. [188] reported a retarded combustion phasing with the use of neat ABE. However, at 800 K and ambient oxygen of 11%, Zhou et al. [109] found that ABE20 gave improved combustion efficiency than diesel fuel.

Due to its higher volatility, increasing the acetone content can be considered as a promising approach to overcome the ABE's retarded combustion phasing. This would enhance the vaporisation of the fuel mixture and shorten the ignition delay. ABE component ratios could be controlled during the fermentation process, thus allowing the acetone content to be controlled. To get the optimized volumetric ratio for ABE-diesel blends, Wu et al. [104] investigated the various volumetric ratio of ABE (6:3:1; 3:6:1; 0:10:0, vol.%) in a constant volume chamber. The results showed that an increased acetone percentage resulted in an advanced combustion phasing, while butanol would do the opposite. With higher acetone ratio, the ignition delay reduced and the combustion duration become shorter. Faster combustion duration is beneficial to increase the fuel efficiency of diesel engines. The ABE20 (6:3:1) had the shortest combustion duration of all tested fuels with the same ignition delay and premixed combustion with diesel fuel [104].

To understand the combustion characteristic of ABE-diesel blend, both the dynamic of spray and chemistry reaction needs investigating. Similar to their previous study [104], Wu et al. [189] changed the ratio of ABE components ratios to investigate the effect of acetone and single components of ABE in the blends. They focused on the effect of acetone and altered the ABE volumetric ratio from 3:6:1 to 6:3:1 and 0:10:0. The investigation was performed under LTC conditions with optical access. Heat release rate showed that ABE (6:3:1) gave similar combustion characteristics to pure diesel but with a much shorter ignition delay than that of ABE (3:6:1) and ABE (0:10:0), resulted from its higher acetone content. High evaporability of acetone, as well as its low viscosity, accelerated the mixture formation. ABE (6:3:1) gave the shortest combustion duration, whereas the ABE (0:10:0) gave the longest. The start of combustion (SOC) retarded and the peak heat release rate decreased with decreasing ambient oxygen concentration. The ABE (6:3:1) and diesel fuel gave comparable SOC and heat release rate curve, but both fuels were less influenced by the ambient oxygen concentration. ABE with lower acetone ratio such as ABE (3:6:1) and ABE (0:10:0) were more affected by the effect of oxygen concentration.

Zhang et al. [193] constructed a semi-detailed chemical mechanism to model ABE-diesel spray combustion in a constant volume chamber. Results from the literature were used to validate the mechanism comprising ABE and n-heptane as surrogate fuel species. KIVA-3V program combined with the validated mechanism was used to simulate the spray dynamic and combustion characteristics inside the chamber. The results of ignition delay, cylinder pressures and heat release rates from both the simulation in a shock tube and constant volume chamber showed reasonable agreements between the experimental and calculated. The proposed semi-detailed chemical mechanism in this study could maintain the kinetic

behaviour of ABE-diesel blends. It was found that with the increasing of acetone percentage; the combustion phasing advanced significantly, while butanol would offset the advancing effect.

4.3 Emission

4.3.1 CO emission

CO emission is mainly formed as a result of incomplete combustion due to lack of oxygen. ABE may provide extra oxygen content to help the completeness of combustion, but Chang et al. [103] found that CO emissions increased with increasing ABE concentration. For 0.5 and 1% water addition, CO emissions skyrocketed by 34.1-117% and 64.2-197%, respectively. ABE addition may achieve complete combustion resulted from its higher combustion efficiency from extra oxygen [202]. However, most of this oxygen reduced the gross heating value of the mixture. The combustion temperature will decrease and retard the oxidation reaction, thus increasing CO emissions. While the study by Chang et al. reported an increase of CO emissions, Algayyim et al. [106] found a significant decrease of CO emission with BA10, BA20, and BA30 by 18.5-41%, 39.8-64.5%, and 35.6-39.9%, respectively, compared to diesel fuel. The higher oxygen content of BA mixtures was believed to promote the oxidation of CO and assist the completeness of the combustion, thus decreasing CO emissions. The same reason was also attributed to the decrease of CO emissions with the addition of iso-BA and n-BA conducted by the same authors in another study [107]. Higher BA ratio would reduce the CO emissions at all engine speeds. Iso-BA gave lower reduction compared to n-BA with the addition of 20% of iso-BA achieving maximum reduction of CO emission by 35-60% compared to regular diesel. The CO₂ emission was also reported to be higher at medium and high engine speeds compared to diesel, resulted from the enhanced conversion of CO to CO₂. However, at low speed, CO₂ emissions were lower for both iso-BA and n-BA compared to diesel due to their leaner mixture.

In general, the incomplete combustion takes place in locally rich conditions, have inadequate oxidizers and have low combustion temperatures [203]. Conventional diesel fuel, containing zero oxygen in their molecular structure, is therefore expected to produce CO emissions. The oxygen content of ABE blends could improve the combustion and assist its completeness. Furthermore, lower viscosity and density of ABE will lead to better spray thus a faster and better combustion process could be achieved. As a result, the CO emissions will reduce where leaner combustion is expected to occur resulting from the partially oxidized nature of ABE compared to diesel. This will lead to enough oxygen to allow a higher conversion of CO to CO₂.

4.3.2 HC emission

HC emission is mainly caused by the engine configuration, fuel structure, combustion temperature, oxygen availability and residence time [204, 205]. Lin et al. [192] found that HC emissions increased with the addition of ABE. As the ABE percentage from 10% to 20%, the HC emissions increased even more. The authors believed that such an increase was caused by the charge cooling effect leading to combustion incompleteness resulting in retarded combustion phasing. The increased HC emissions can be an indication of combustion inefficiency. However, the increase was still at a relatively low level with the highest being around 64 ppm for ABE20 at low engine speed. Chang et al. [103] also reported an increase when using 20% ABE that contained 0.5% water. The increase was believed to be caused by a higher latent heat value and a lower cetane number of ABE20W0.5 that led to higher HC emissions [150, 206]. However,

despite the increase with ABE addition, the HC emissions were still at a low level and can be eliminated using conventional catalytic converters.

Compared to diesel fuel, Algayyim et al. [106] found that the BA10, BA20, and BA30 increased HC emissions by 8-16.3%, 11.4-37.3%, and 3-12%, respectively at 1400 and 2600 rpm. The lower cetane number of BA was responsible for the longer ignition delay, thus allowing more time for the blends to evaporate. However, the higher latent heat caused slower evaporation that resulted in less time available to complete the reaction. Algayyim et al. also found the same trends with BA addition using n-butanol and iso-butanol [107]. While the iso-BA increased the HC emission, the n-BA gave comparable or fewer HC emissions compared to diesel. This is an interesting finding as the latent heat of n-butanol (582 kJ/kg) is higher than iso-butanol (566 kJ/kg). Therefore, the addition of n-BA was supposed to result in a more cooling effect that will slow the evaporation process and increase the HC emission. There are several possible reasons for the HC emission reduction with n-BA despite its higher latent heat of vaporisation. The higher cetane number of n-butanol could be one potential reason for its lower HC emission. Also, the viscosity of n-butanol (2.22 mm²/s) is lower than iso-butanol (2.63 mm²/s) [4, 46, 198]. This led to a longer and deeper spray penetration resulting in relatively smaller droplets and more contact surface compared to iso-butanol. As a result, improved air-fuel mixing and higher overall reaction rate were achieved for n-BA. However, the authors believed that it was the different molecular chain structure between n-butanol and iso-butanol that influenced the HC emissions. N-butanol is a straight chain isomer with the most inner C-H bonds, while iso-butanol is a branched isomer with the most terminal C-H bonds [119, 207]. The reaction rate is influenced by the C-H bond as different bonds need different energy to crack the bonds [208]. Inner C-H bonds have less energy than terminal bonds [209]. Also, the H-abstraction reaction is higher for a less bond energy leading to a higher overall reaction rate [208, 209]. Therefore, the reaction rate of n-BA is higher with enough time to complete the reaction, thus decreasing the overall HC emission.

Overall, higher latent heat of ABE is expected to lower the combustion temperature, thus lowering the chemical reaction and making it difficult for the fuel to react with the oxygen. However, the change in operating conditions may also affect the HC emissions. At high speeds, the fast combustion with its high temperature characteristics will improve the combustion process so that the reduction in HC emissions may be observed.

4.3.3 NO_x emission

The NO_x formation is mainly affected by the combustion temperature, local oxygen concentration and residence time in the high temperature zone [210]. Lin et al. [192] reported higher NO emissions with ABE addition. They believed that the higher volatility or lower boiling points of ABE components resulted in premixed-dominant combustion that led to faster combustion rate and higher combustion temperature. As a result, higher NO_x emission was reported despite better oxidation resulted from extra oxygen of ABE where reduced local equivalence ratio was observed at the flame front area. Higher NO_x emissions when using ABE was also reported by Lee et al. [180]. However, with retarded injection timing, NO_x was successfully decreased. At 0°CA BTDC, the ABE blends had higher NO_x than diesel, but from 4°CA and 8°CA, a significant reduction of NO_x emissions started to occur. Findings from this study show that by tuning the injection timing, fewer NO_x emissions can be achieved.

Besides tuning the injection timing, using water-containing ABE is also considered as an effective way to reduce NO_x emissions. The actual ABE fermentation product contains a small amount of water [187].

Despite its water content, a study conducted by Chang et al. [103] showed that a stable fuel blend using ABE was achieved without separation. ABE20W0.5 was found to reduce NO_x emissions by 3.69-16.4%. Three factors were attributed to the NO_x reductions; (1) micro explosion resulted from the water-in-oil droplets, (2) extra oxygen content of ABE and (3) evaporative cooling effect. In another study by the same author, water-containing ABE-diesel blends were also investigated and mixed with biodiesel.

Even though biodiesel has a higher NO_x emission, but the addition of 25% water containing ABE showed a significant NO_x reduction [187]. It is worth discussing here that the increase in NO_x emissions of biodiesel may not solely be caused by its higher thermal NO_x resulted from longer ignition delay due to its low cetane number [211]. This is because the ignition timing of biodiesel was found to be similar to the diesel fuel and its in-cylinder temperature was only marginally higher. This finding shows that other NO_x mechanisms increased its overall NO_x emissions other than thermal NO_x. Prompt NO_x formation and N₂O pathway were believed to be the reasons. Prompt NO_x was enhanced since biodiesel produces more fuel-derived radical compared to regular diesel [212], while the N₂O pathway was enhanced for NO_x formation as the experiment was conducted in lean condition with equivalence ratio lower than 0.4 [213]. However, since the addition of biodiesel increased the equivalence ratio, the thermal NO_x may still contribute to the increase of overall NO_x emissions. Therefore, several mechanisms were responsible for the increase in NO_x emissions with biodiesel addition; thermal, prompt NO_x, and N₂O. With the addition of 25% water containing ABE to biodiesel blends, Chang et al. [187] found that NO_x emissions were reduced significantly by 15.6-22.7, 10.1-21.3 and 9.50-19.3% with biodiesel addition of 25, 50 and 75%, respectively. Given that ABE is similar to biodiesel in terms of high oxygen content, low cetane number and more fuel-derived radical, higher NO_x emissions were supposed to be observed. However, high latent heat and low heating value of ABE caused significant evaporative cooling effect, thus reducing the combustion temperature [214]. Moreover, ABE-biodiesel's leaner combustion can reduce the thermal, intermediate and prompt NO_x. Also, water-containing ABE was beneficial to decrease the NO_x formation region, i.e. the resident time at high temperature. Therefore, these factors outweighed those that increased NO_x. As a result, overall NO_x reduction was achieved with the addition of water-containing ABE to biodiesel blends.

Since NO_x emission is formed at high temperature combustion, it is essential to investigate the exhaust gas temperature (EGT). Compared to diesel at three engine speeds, Algayyim et al. [106] found that the EGT reduced by 2.1–3.5%, 3.4–7.3%, and 4.6–15.6% for BA10, BA20, and BA30, respectively. This reduction was consistent with the reduction of NO_x emission. The BA10, BA20, and BA30 gave similar decreases by 2.2–10%, 2.2–7.5% and 2.64–6.6%, respectively. The EGT and NO_x emission were decreasing with the increase of BA ratio. This is because the latent heat of n-butanol (585 kJ/kg) is more than double compared to diesel (250 kJ/kg) [203]. Furthermore, the ratio of butanol used in the BA mixture for this study was 75%. Therefore, further reduction of EGT and NO_x was expected with the increase BA ratio. In another study investigating BA mixture, the same trends were also reported. This time, Algayyim et al. [107] compared the use of n-butanol and iso-butanol for BA mixture. However, the n-BA gave lower EGT and NO_x compared to iso-BA due to a higher latent heat of n-butanol. Moreover, n-butanol has a higher cetane number than iso-butanol, thus decreasing EGT and NO_x emission even more [208, 215].

In general, the addition of ABE, the extra oxygen from each of ABE components is expected to achieve complete combustion, increase the combustion temperature and increase the NO_x emissions. The low cetane number of ABE blends will also prolong the ignition delay; thus more fuel is burned at the premixed combustion stage. However, ABE's lower calorific value and higher latent heat may reduce the NO_x emissions and balance the effects resulted from its extra oxygen content and low cetane number.

Therefore, both factors are competing with each other, and the dominant one will determine the overall NO_x emissions. If the effect of oxygen content and low cetane number outweigh the high latent heat of ABE, the temperature of the cylinder will be higher; thus more NO_x emissions will be produced. Also, given that the temperature will increase with the increase in the engine loads and speeds, it is therefore expected that the NO_x will increase at higher engine loads and speeds.

4.3.4 Soot emission

Soot is an important emission characteristic of a diesel engine. The natural flame luminosity is often used to quantify soot emissions. This is because both chemiluminescence and soot incandescence contribute to the natural luminosity, but the effect from soot incandescence is much significant to the luminosity than that of from chemiluminescence. Therefore, the soot is characterised by broadband luminosity. Although the oxygenated fuels tend to produce less soot emission than diesel, the soot formation mechanism of ABE blends is still not comprehensively understood. However, most of the results found in the literature seem to agree that ABE-diesel blends can reduce soot emissions.

Three factors play significant roles in the soot reduction of ABE-diesel blends. First, it may be contributed to the oxygen content in ABE blends that accelerate soot oxidation during combustion. Second, compared to diesel fuel, the physical properties of ABE as shown in Table 1 show that each ABE component has a higher volatility (lower boiling point, higher saturated vapour, lower viscosity) and lower stoichiometric ratio, thus leading to leaner combustion and as a result, the diffusion combustion will be significantly reduced. Third, the combustion region may affect the soot emissions. If the flame takes place far from the injector tip, the fuel is more likely to mix with the ambient oxygen and reduce the local equivalence ratio.

The general trends show that natural flame luminosity decreases with the increase of ABE concentration. With the increase of ABE ratio, Wu et al. [108] reported that natural flame luminosity was reduced. It was also found that with the addition of 80% ABE ratio, the initial flame was seen farther from the injector tip. The soot reduction was believed not only resulted from the oxygen content that accelerates the soot oxidation but also from the longer flame lift-off length (FLoL) which reduces the local equivalence ratio. Longer FLoL is thought to be from ABE's low cetane number. Table 1 shows that each ABE component has relatively a lower cetane number compared to diesel fuel. The FLoL itself is controlled by cetane number and represents the overall equivalence ratio. Lower cetane number tends to give longer FLoL and lower equivalence ratio [216]. Therefore, by adding fuel with a low cetane number, the equivalence ratio can be reduced, thus suppressing the soot formation. When the overall equivalence ratio was reduced to around two near the lift-off area, soot-free combustion would be achieved [217]. Hence, with the addition of ABE, the ignition delay is expected to be longer due to its low cetane number, and this will result in a longer flame lift-off length. It was also found that longer FLoL was observed with decreasing ambient oxygen concentration and temperature, resulting from longer ignition delay. As longer FLoL allows fuel droplet to mix with ambient air in an extended period and prominent space, soot emission was significantly reduced.

Similar results regarding the FLoL was reported by Wu et al. [188] when comparing 100% ABE and pure butanol to investigate the spray and combustion characteristics on an optical constant volume chamber. Although ABE and butanol have similar characteristics on spray and combustion performance, ABE provided better soot reduction with a longer FLoL and shorter liquid penetration. Longer FLoL and shorter liquid penetration led to a longer gap between the liquid spray and the flame, allowing more time and space for the fuel droplets to evaporate and mix with the ambient air, thus reducing the local equivalence

ratio. As a result, reduced natural flame luminosity was observed for ABE. Another study investigating the soot formation process using 100% ABE was conducted by Fu et al. [194], focusing on the soot generation of ABE and diesel. They found that ABE has a lower tendency of generating soot than diesel fuel. Initial temperature and oxygen concentration have a negligible impact on their soot due to the fuel composition, molecular structure and physicochemical characteristics. However, ambient conditions affected the soot mass peak of ABE. At 800 K and 21% oxygen concentration, the soot mass peak was a 1/12 of the diesel's, but it soared by 25% when the oxygen concentration was reduced to 16%. Zhao et al. also found the same trends where the soot generation mass of ABE increased with decreasing oxygen concentration [191]. At 16% oxygen concentration, high total soot mass was higher compared to that of 21% due to the inhibited soot oxidation. However, at 11% oxygen concentration, although both soot formation and oxidation were suppressed, the soot formation was inhibited more. As a result, soot reduction was achieved at a diluted oxygen condition.

By changing ambient oxygen concentration from 21% to 11%, Zhou et al. [109] found that ABE20 offered lower soot emission with better combustion efficiency compared to the diesel at low ambient temperatures and low ambient oxygen concentrations. This study found that the ignition delays of ABE20 were longer than those of D100 (pure diesel) at low ambient temperatures with longer soot lift-off length, providing more air entrainment of the spray and achieving improved air-fuel mixing, thus lowering soot emissions. At a low ambient temperature of 800 K and ambient oxygen of 11%, ABE20 showed flameless combustion with almost zero soot luminosity. Although previous studies have shown the potential of ABE to reduce soot emissions, it is necessary to examine the variation in the soot oxidation reactivity of ABE-diesel blends. A recent study by Luo et al. [195] has confirmed that the average soot activation energies of the ABE were lower than diesel. The soot particles of ABE blends were more prone to oxidize by oxygen.

Different acetone content and temperature combustion may affect soot emissions. Lower natural luminosity with ABE addition was reported by Wu et al. [104] when examining the optimal ratio of ABE by changing its volumetric ratio. It was found that both the Space Integrated Natural Luminosity (SINL) and Time Integrated Natural Luminosity (TINL) were lower for ABE20 (3:6:1) and ABE20 (6:3:1), but slightly higher for ABE (0:10:0) (Fig. 9). This is because the extra oxygen from ABE addition cause the equivalence ratio to decrease in the diffusion combustion area. The same results were also reported by Wu et al. in another study [189]. The ABE20 (6:3:1) was found to give far lower natural flame luminosity than diesel. Shorter combustion duration and stronger premixed combustion were believed to be the reasons. Furthermore, Wu et al. [104] found that ABE with higher acetone ratio, i.e. ABE20 (6:3:1) had narrow plateau SINL because of its short combustion duration. This is because the low viscosity, low boiling point and high vapour pressure of acetone led to better fuel atomization and air-fuel mixing. At low ambient temperature (900 K), ABE blends gave longer soot lift-off length (SLoL) compared to that of high temperature (1100 K) as shown in Fig. 10. This finding shows that using ABE mixture on LTC can be an effective way to reduce its soot emission. However, Luo et al. [218] found that acetone could deteriorate sooting tendency due to its unsaturation degree, while butanol and ethanol may have a positive effect to reduce soot emissions due to their higher H/C ratio and oxygen content.

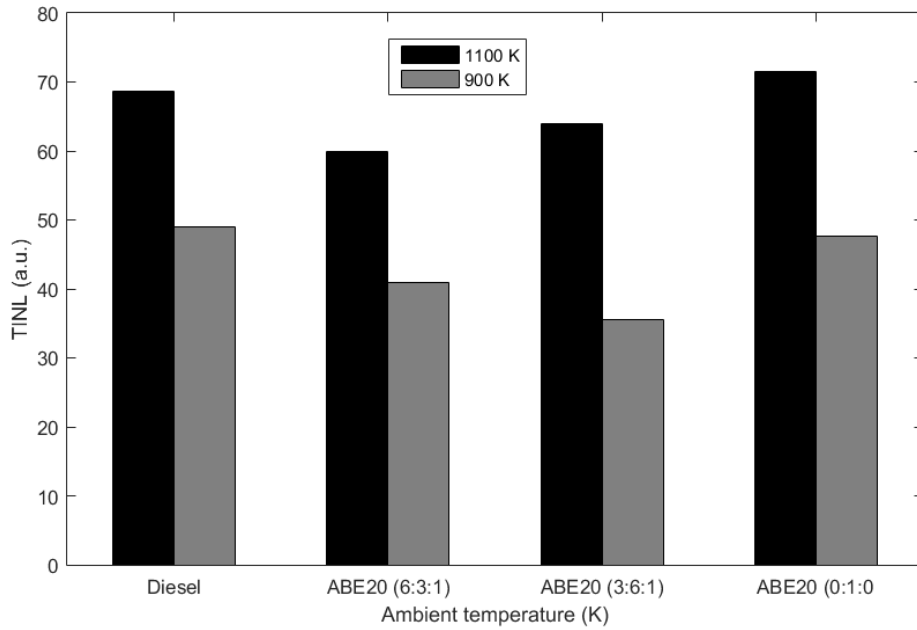

Fig. 9. Time integrated natural luminosity of three ABE with different volumetric ratios compared to diesel fuel at two ambient temperatures, reproduced from [104]

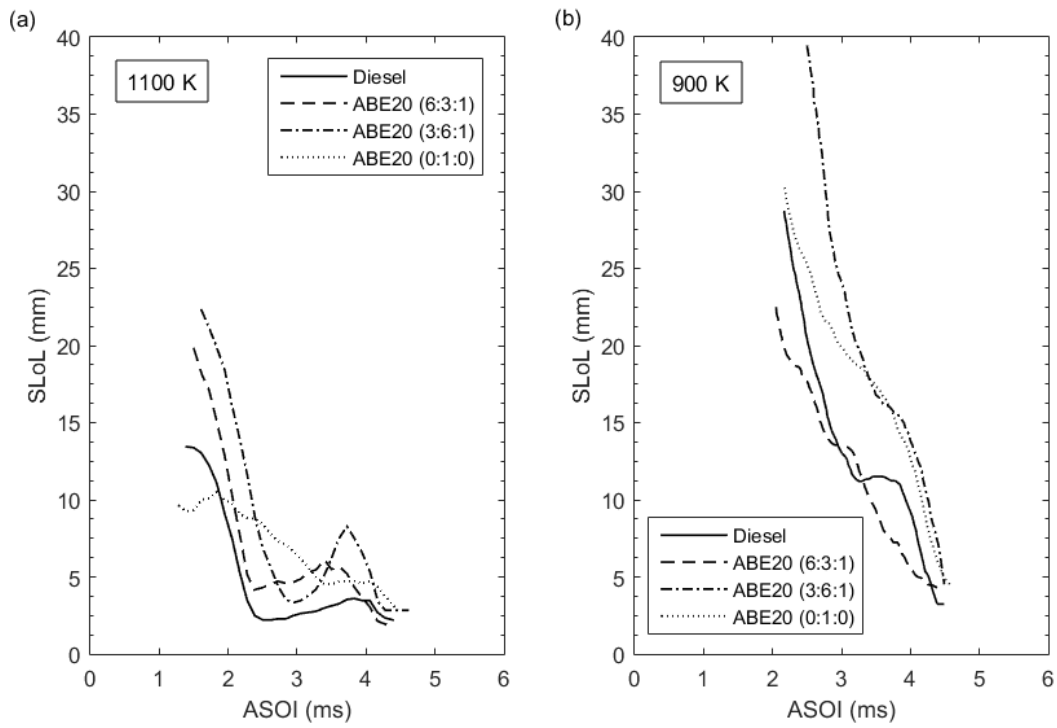

Fig. 10. Soot lift-off length of three ABE with different volumetric ratios compared to diesel fuel at ambient temperature of (a) 1100 K and (b) 900 K, reproduced from [104]

Micro-explosions may reduce the soot emission by improving the fuel atomization, increasing the reaction contact area, achieving complete combustion and suppressing the soot formation. Chang et al. [103] found that the use of ABE20 with 0.5% water addition reduced the particulate matter (PM) emission factors by 5.82-61.6% at various operating conditions. At 3.2 kW generator engine load, the PM emission reduced with the increasing percentage of ABE and water. However, at 1.6 kW, higher PM emission was observed when the water was increased to 1%. This can be explained by the cooling effect of ABE and water addition that retarded the oxidation of the soot and stimulated the condensation of PM emission. Despite an increase at some conditions, but in general, the PM was successfully reduced with increasing ABE ratio. It is important to note that the addition of ABE alone may not lead to the micro-explosions [190]. It is the addition of small water in the ABE mixture than can cause micro-explosions, thus achieving complete combustion and decreasing PM emissions [219, 220].

Although the effect of micro-explosions needs further investigating, three main reasons for PM formation are attributed to soot nucleation, unburned hydrocarbons condensation and sulphuric acid interaction with soot [221]. Several studies have reported fewer PM emissions using oxygenated fuels in diesel engine [222-225]. Additional oxygen content found in ABE can suppress the major precursor of PM nuclei [226] which are the aromatic rings formation and the C₂-species interaction [227]. Both extra oxygen and oxygen radicals into the pyrolysis zone can oxidize the fuel and decrease PM where CO partially substitutes C₂H₂ in the pyrolysis reactions [228]. Also, since the interaction between sulphuric acid and soot can increase PM emission, adding ABE without sulphur content may help to reduce the PM formation. However, sulphuric acid condensation may not be affected as the sulphur content of diesel fuel is already low to meet the regulations.

Biodiesel can reduce PM emission, and with the addition of ABE into biodiesel, a further reduction can be achieved. For biodiesel without ABE content, Chang et al. [187] found that the B25, B50, and B75 reduce PM emissions by 5.86-17.6, 11.5-27.7 and 18.6-32.5%, respectively. These findings are consistent with other findings where two reasons are attributed to this reduction. First is the high oxygen content of biodiesel that results in complete combustion [224, 229, 230]. Second is the lower aromatic content of biodiesel that inhibits the soot formation as aromatic compounds are known to work as a soot precursor [231]. However, the high viscosity of biodiesel can deteriorate the atomization of the fuel, thus assisting the PM formation [230, 232]. Therefore, the PM reduction was not increasing with higher biodiesel ratio because a factor that helps to reduce soot formation (low aromatic content) is outweighed by a factor that helps to increase soot formation (higher viscosity). However, adding 25% water-containing ABE into biodiesel may help to improve PM emissions [187]. It was found that B25ABE25, B50ABE25 and B75 ABE25 reduced PM by 11.6-15.8, 16.2-22.7 and 10.9-18.5%, respectively as shown in Fig. 11. This is because ABE has a lower cetane number, thus delaying the ignition and as a result, leaner conditions are achieved due to strong premixed combustion resulted from longer ignition delay [233, 234]. Given aromatic rings is the main precursor for PM nuclei, with the addition of water-containing ABE, its higher content assists the complete oxidation of the aromatic rings. Moreover, the soot precursors and black carbon can be oxidized by OH radicals that are normally produced by alcohol fuel [235]. The OH radicals can convert hydrogen atoms to molecular hydrogen. With reduced hydrogen atoms, the propagation of aromatic rings and the growth of soot will be slower [235]. Therefore, a significant reduction in PM emission was achieved. Considering the study by Chang et al. [187] also gave lower NO_x emissions as discussed in 4.3.3, the use of ABE-biodiesel is, therefore, a promising approach to solve the NO_x-PM trade-off in the diesel engine.

Fig. 12 shows the NO_x-PM trade-off emissions for the tested fuels. However, more in-depth studies are required because soot can serve as an effective heat radiator. Therefore, with lower soot resulted from the oxidation by extra oxygen content of ABE, higher in-cylinder temperature and NO_x emissions may be observed [236, 237].

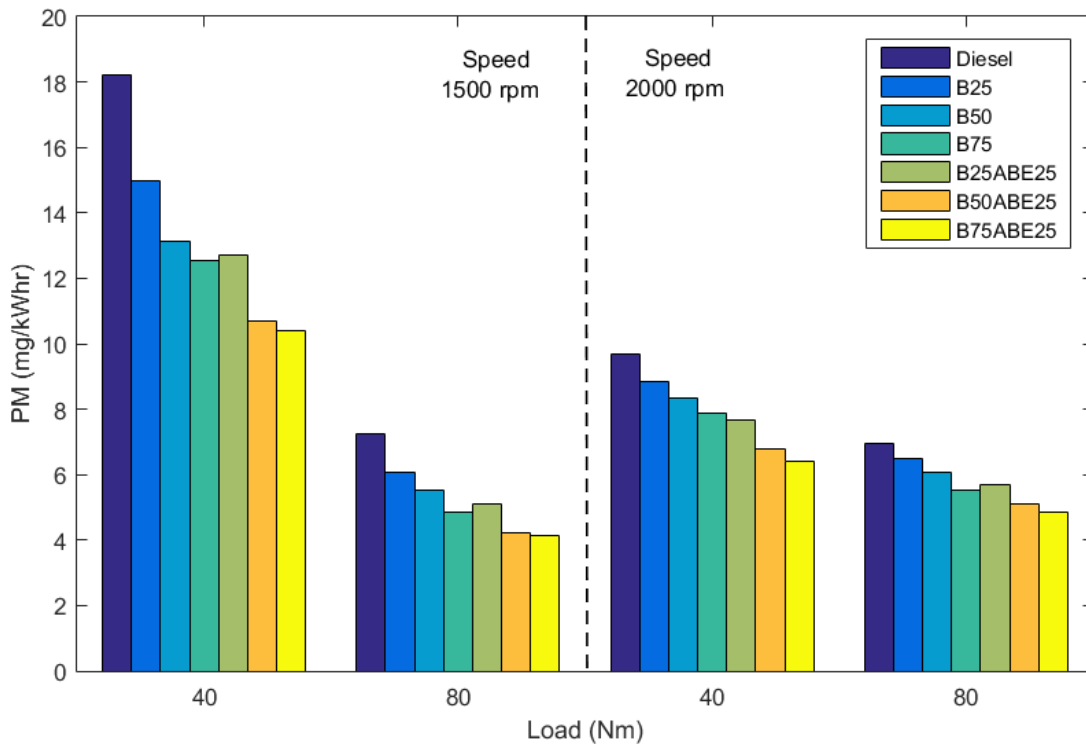

Fig. 11. Comparisons of PM emissions between diesel, biodiesel and biodiesel-ABE blends, reproduced from [187]

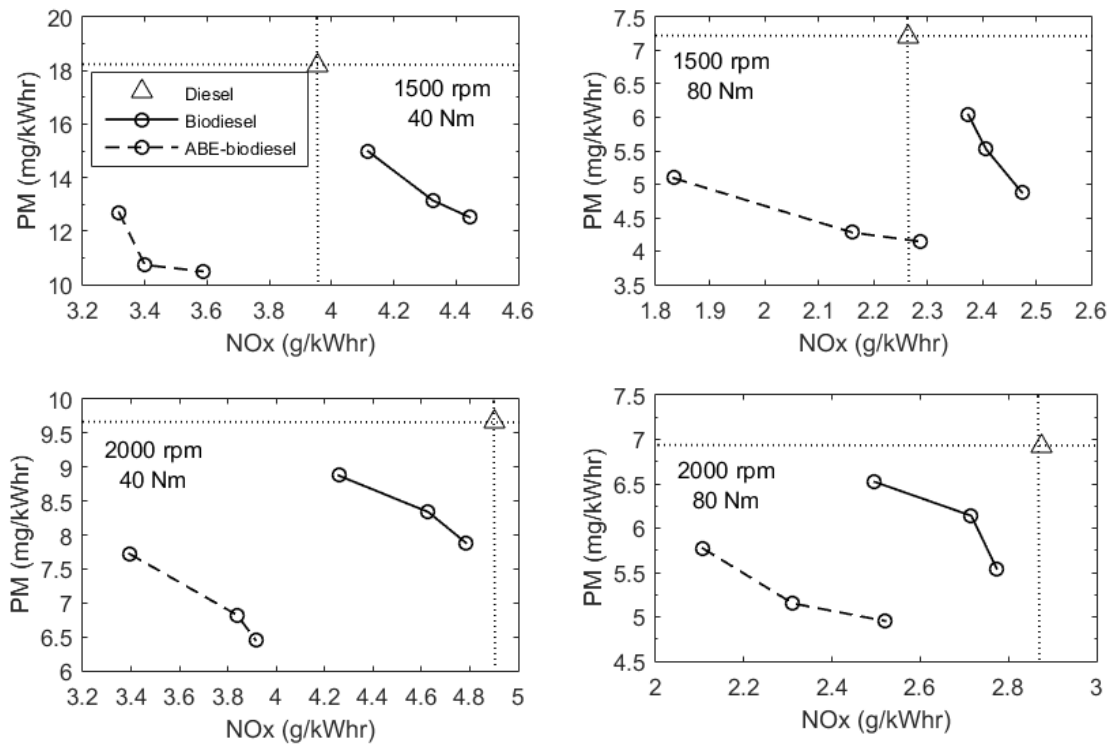

Fig. 12. Trade-off between NOx and PM emissions for two different engine speeds and loads, reproduced from [187]

Overall, the addition of ABE into petrol diesel has the potential to lower its soot emissions. Lower natural flame luminosity is observed due to shorter combustion duration and stronger premixed combustion of ABE blends. Strong premixed combustion rate is attributed to the retarded ignition timing caused by the increase of heat release rate in the premixed combustion stage. As a result, the soot formation is successfully reduced. Moreover, since each component of ABE produces OH radicals and contains less aromatic than diesel, less soot may also be attributed to the fewer soot precursors from the production of OH radicals and the dilution of aromatics of ABE. Furthermore, the addition of ABE may decrease the soot precursors from the initial radicals for the aromatic rings to be formed by reducing the carbon amount for precursor species formation. Also, with the addition of ABE, the formation of rich zones with the high local fuel-air ratio is more likely to reduce, thus improving the soot oxidation of soot nuclei.

5. Research gaps

Fig. 13 generally outlines the next possible contribution of using ABE as a biofuel. In addition to the issues addressed in the figure, several specific contributions are plausible to be conducted in gasoline and diesel engine. In a gasoline engine, the anti-knock ability of ABE has not yet been investigated. The knock resistance may be improved due to significant cooling effect resulting from higher ABE's higher latent heat. With better knock resistance, further improvement in power and efficiency can be achieved using higher compression ratios, optimal spark timing, and significant downsizing. Moreover, despite its

promising role in mitigating knock, studies conducted using EGR have not yet been found using ABE as a biofuel in gasoline engines. In a diesel engine, most studies investigating ABE were conducted on a constant volume combustion chamber to represent a real compression ignition engine characteristics. Also, by changing the ambient temperature and oxygen, the low combustion technology and EGR can be represented. However, direct application of ABE on a real engine is required. In addition to that, more researches are needed to examine the effect of ABE on unregulated emissions.

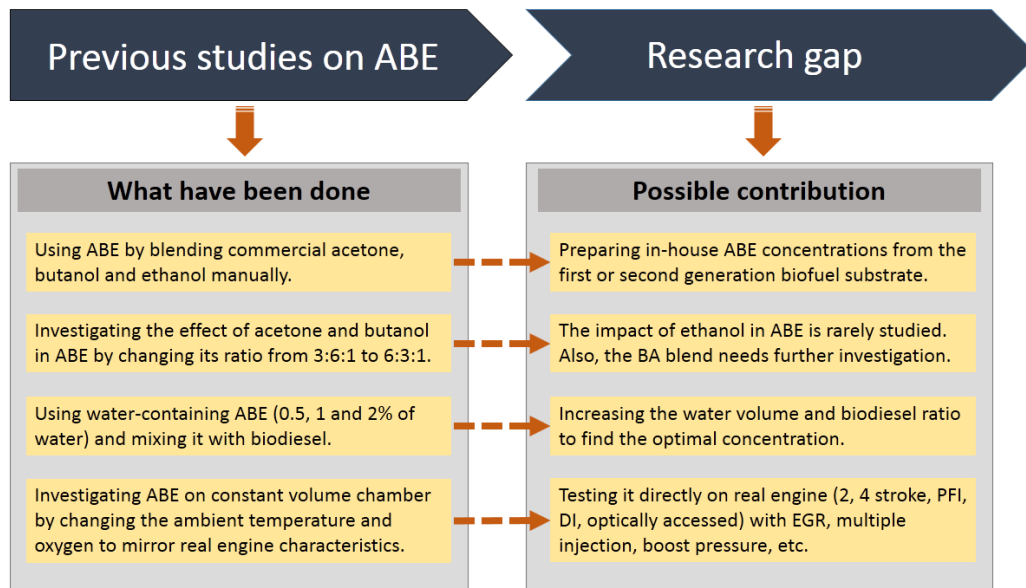

Fig. 13. Future research directions

Acknowledgment

The authors would like to acknowledge the Universiti Teknologi Malaysia (UTM) for financial support under the research university grant Q.J130000.3509.06G97.

References

- [1] A. Alagumalai, Internal combustion engines: Progress and prospects, *Renew. Sust. Energ. Rev.* 38 (2014) 561-571.
- [2] S. Imtenan, M. Varman, H. Masjuki, M. Kalam, H. Sajjad, M. Arbab, I.R. Fattah, Impact of low temperature combustion attaining strategies on diesel engine emissions for diesel and biodiesels: A review, *Energ. Convers. Manage.* 80 (2014) 329-356.
- [3] Y. Li, J. Gong, Y. Deng, W. Yuan, J. Fu, B. Zhang, Experimental comparative study on combustion, performance and emissions characteristics of methanol, ethanol and butanol in a spark ignition engine, *Appl. Therm. Eng.* 115 (2017) 53-63.

- [4] A. Elfasakhany, Investigations on performance and pollutant emissions of spark-ignition engines fueled with n-butanol-, isobutanol-, ethanol-, methanol-, and acetone-gasoline blends: a comparative study, *Renew. Sust. Energ. Rev.* 71 (2017) 404-413.
- [5] X. Zou, H. Wang, Z. Zheng, R. Reitz, M. Yao, Numerical study of the RCCI combustion processes fuelled with methanol, ethanol, n-butanol and diesel, *SAE Tech. Pap.* 2016-01-0777 (2016).
- [6] M. Lapuerta, J. Rodríguez-Fernández, D. Fernández-Rodríguez, R. Patiño-Camino, Modeling viscosity of butanol and ethanol blends with diesel and biodiesel fuels, *Fuel* 199 (2017) 332-338.
- [7] A. Elfasakhany, Exhaust emissions and performance of ternary iso-butanol-bio-methanol-gasoline and n-butanol-bio-ethanol-gasoline fuel blends in spark-ignition engines: Assessment and comparison, *Energy* 158 (2018) 830-844.
- [8] B.R. Kumar, S. Saravanan, Use of higher alcohol biofuels in diesel engines: A review, *Renew. Sust. Energ. Rev.* 60 (2016) 84-115.
- [9] E. Sadeghinezhad, S. Kazi, F. Sadeghinejad, A. Badarudin, M. Mehrali, R. Sadri, M.R. Safaei, A comprehensive literature review of bio-fuel performance in internal combustion engine and relevant costs involvement, *Renew. Sust. Energ. Rev.* 30 (2014) 29-44.
- [10] A. Gupta, J.P. Verma, Sustainable bio-ethanol production from agro-residues: A review, *Renew. Sust. Energ. Rev.* 41 (2015) 550-567.
- [11] H. Zabed, J. Sahu, A. Boyce, G. Faruq, Fuel ethanol production from lignocellulosic biomass: An overview on feedstocks and technological approaches, *Renew. Sust. Energ. Rev.* 66 (2016) 751-774.
- [12] J. Han, J.S. Luterbacher, D.M. Alonso, J.A. Dumesic, C.T. Maravelias, A lignocellulosic ethanol strategy via nonenzymatic sugar production: Process synthesis and analysis, *Bioresour. Technol.* 182 (2015) 258-266.
- [13] N. Gaurav, S. Sivasankari, G. Kiran, A. Ninawe, J. Selvin, Utilization of bioresources for sustainable biofuels: A review, *Renew. Sust. Energ. Rev.* 73 (2017) 205-214.
- [14] S.N. Naik, V.V. Goud, P.K. Rout, A.K. Dalai, Production of first and second generation biofuels: a comprehensive review, *Renew. Sust. Energ. Rev.* 14 (2010) 578-597.
- [15] R.L. Patel, C. Sankhavera, Biodiesel production from Karanja oil and its use in diesel engine: A review, *Renew. Sust. Energ. Rev.* 71 (2017) 464-474.
- [16] D. Khatiwada, S. Leduc, S. Silveira, I. McCallum, Optimizing ethanol and bioelectricity production in sugarcane biorefineries in Brazil, *Renew. Energ.* 85 (2016) 371-386.
- [17] J. Jonker, F. Van Der Hilst, H. Junginger, O. Cavalett, M. Chagas, A. Faaij, Outlook for ethanol production costs in Brazil up to 2030, for different biomass crops and industrial technologies, *Appl. Energ.* 147 (2015) 593-610.
- [18] P. Grad, Biofuelling Brazil: An overview of the bioethanol success story in Brazil, *Refocus* 7 (2006) 56-59.

- [19] M.L. Lopes, S.C. de Lima Paulillo, A. Godoy, R.A. Cherubin, M.S. Lorenzi, F.H.C. Giometti, C.D. Bernardino, H.B. de Amorim Neto, H.V. de Amorim, Ethanol production in Brazil: A bridge between science and industry, *Braz. J. Microbiol.* 47 (2016) 64-76.
- [20] D. Golke, J.L.S. Fagundes, N.P.G. Salau, M.E.S. Martins, Combustion performance of n-butanol, hydrous ethanol and their blends as potential surrogates for the Brazilian gasoline, *SAE Tech. Pap.* 2016-36-0274 (2016).
- [21] P. de Mattos Fagundes, A.D. Padula, A.C.M. Padilha, Interdependent international relations and the expansion of ethanol production and consumption: the Brazilian perspective, *J. Clean. Prod.* 133 (2016) 616-630.
- [22] K. Halsnæs, P. Shukla, Sustainable development as a framework for developing country participation in international climate change policies, *Mitig. Adapt. Strat. Gl.* 13 (2008) 105-130.
- [23] A. de Oliveira, Reassessing the Brazilian alcohol programme, *Energ. Policy* 19 (1991) 47-55.
- [24] F. Rosillo-Calle, L.A.B. Cortez, Towards ProAlcool II—A review of the Brazilian bioethanol programme, *Biomass Bioenergy* 14 (1998) 115-124.
- [25] J.R. Moreira, Sugarcane for energy – Recent results and progress in Brazil, *Energy Sustain. Dev.* 4 (2000) 43-54.
- [26] S.R. Golisz, J.S. Yang, R.D. Johnson, Understanding the effect of CO₂ on the pHe of fuel ethanol, *Fuel* 199 (2017) 1-3.
- [27] L. Caspeta, N.A. Buijs, J. Nielsen, The role of biofuels in the future energy supply, *Energy Environ. Sci.* 6 (2013) 1077-1082.
- [28] B. Ndaba, I. Chiyanzu, S. Marx, n-Butanol derived from biochemical and chemical routes: A review, *Biotechnology Reports* 8 (2015) 1-9.
- [29] J. Zheng, Y. Tashiro, Q. Wang, K. Sonomoto, Recent advances to improve fermentative butanol production: genetic engineering and fermentation technology, *J. Biosci. Bioeng.* 119 (2015) 1-9.
- [30] J.M. Bergthorson, M.J. Thomson, A review of the combustion and emissions properties of advanced transportation biofuels and their impact on existing and future engines, *Renew. Sust. Energ. Rev.* 42 (2015) 1393-1417.
- [31] H. Wei, D. Feng, J. Pan, A. Shao, M. Pan, Knock characteristics of SI engine fueled with n-butanol in combination with different EGR rate, *Energy* 118 (2017) 190-196.
- [32] Q. Li, H. Liu, Y. Zhang, Z. Yan, F. Deng, Z. Huang, Experimental and kinetic modeling study of laminar flame characteristics of higher mixed alcohols, *Fuel Process. Technol.* 188 (2019) 30-42.
- [33] F. Meng, X. Yu, L. He, Y. Liu, Y. Wang, Study on combustion and emission characteristics of a n-butanol engine with hydrogen direct injection under lean burn conditions, *Int. J. Hydrogen Energ.* 43 (2018) 7550-7561.

- [34] T. Su, C. Ji, S. Wang, X. Cong, L. Shi, J. Yang, Improving the lean performance of an n-butanol rotary engine by hydrogen enrichment, *Energ. Convers. Manage.* 157 (2018) 96-102.
- [35] J. Yadav, A. Ramesh, Injection strategies for reducing smoke and improving the performance of a butanol-diesel common rail dual fuel engine, *Appl. Energ.* 212 (2018) 1-12.
- [36] S. Van Wyk, A. Van Der Ham, S. Kersten, Pervaporative separation and intensification of downstream recovery of acetone-butanol-ethanol (ABE), *Chem. Eng. Process.* 130 (2018) 148-159.
- [37] S. Niglio, A. Marzocchella, L. Rehmman, Clostridial conversion of corn syrup to Acetone-Butanol-Ethanol (ABE) via batch and fed-batch fermentation, *Heliyon* 5 (2019) e01401.
- [38] S. Xie, C. Fu, W. Song, Y. Zhang, C. Yi, Highly efficient synthesis and separation of fuel precursors from the concentrated ABE fermentation broth in a biphasic catalytic process, *Fuel* 242 (2019) 41-49.
- [39] A. Jahanmiri, H. Rasooli, On-line states and parameter identification of acetone-butanol-ethanol fermentation process, *Biochem. Eng. J.* 24 (2005) 115-123.
- [40] Y. Tashiro, K. Takeda, G. Kobayashi, K. Sonomoto, High production of acetone-butanol-ethanol with high cell density culture by cell-recycling and bleeding, *J. Biotechnol.* 120 (2005) 197-206.
- [41] L. Qiu, X. Cheng, Z. Li, H. Wu, Experimental and numerical investigation on soot volume fractions and number densities in non-smoking laminar n-heptane/n-butanol coflow flames, *Combust. Flame* 191 (2018) 394-407.
- [42] W.R. da Silva Trindade, R.G. dos Santos, 1D modeling of SI engine using n-butanol as fuel: Adjust of fuel properties and comparison between measurements and simulation, *Energ. Convers. Manage.* 157 (2018) 224-238.
- [43] W. Luo, Z. Zhao, H. Pan, L. Zhao, C. Xu, X. Yu, Feasibility of butanol production from wheat starch wastewater by *Clostridium acetobutylicum*, *Energy* 154 (2018) 240-248.
- [44] Y. Li, Y. Chen, G. Wu, F.L. Chia-fon, J. Liu, Experimental comparison of acetone-n-butanol-ethanol (ABE) and isopropanol-n-butanol-ethanol (IBE) as fuel candidate in spark-ignition engine, *Appl. Therm. Eng.* 133 (2018) 179-187.
- [45] Y. Jiang, T. Zhang, J. Lu, P. Dürre, W. Zhang, W. Dong, J. Zhou, M. Jiang, F. Xin, Microbial co-culturing systems: butanol production from organic wastes through consolidated bioprocessing, *Appl. Microbiol. Biotechnol.* 102 (2018) 5419-5425.
- [46] C. Jin, M. Yao, H. Liu, F.L. Chia-fon, J. Ji, Progress in the production and application of n-butanol as a biofuel, *Renew. Sust. Energ. Rev.* 15 (2011) 4080-4106.
- [47] S. Farmanbordar, K. Karimi, H. Amiri, Municipal solid waste as a suitable substrate for butanol production as an advanced biofuel, *Energ. Convers. Manage.* 157 (2018) 396-408.
- [48] J. Formanek, R. Mackie, H.P. Blaschek, Enhanced butanol production by *Clostridium beijerinckii* BA101 grown in semidefined P2 medium containing 6 percent maltodextrin or glucose, *Appl. Environ. Microbiol.* 63 (1997) 2306-2310.

- [49] B. Ennis, I. Maddox, The effect of pH and lactose concentration on solvent production from whey permeate using *Clostridium acetobutylicum*, *Biotechnol. Bioeng.* 29 (1987) 329-334.
- [50] C. Huang, X.Y. Yang, L. Xiong, H.J. Guo, J. Luo, B. Wang, H.R. Zhang, X.Q. Lin, X.D. Chen, Evaluating the possibility of using acetone-butanol-ethanol (ABE) fermentation wastewater for bacterial cellulose production by *Gluconacetobacter xylinus*, *Lett. Appl. Microbiol.* 60 (2015) 491-496.
- [51] V.H.G. Diaz, G.O. Tost, Energy efficiency of acetone, butanol, and ethanol (ABE) recovery by heat-integrated distillation, *Bioproc. Biosyst. Eng.* 41 (2018) 395-405.
- [52] A. Kujawska, J. Kujawski, M. Bryjak, W. Kujawski, ABE fermentation products recovery methods—A review, *Renew. Sust. Energ. Rev.* 48 (2015) 648-661.
- [53] N. Qureshi, B.C. Saha, M.A. Cotta, V. Singh, An economic evaluation of biological conversion of wheat straw to butanol: A biofuel, *Energ. Convers. Manage.* 65 (2013) 456-462.
- [54] N. Qureshi, V. Singh, Chapter 12 - Process economics of renewable biorefineries: Butanol and ethanol production in integrated bioprocesses from lignocellulosics and other industrial by-products, in: N. Qureshi, D.B. Hodge, A.A. Vertès (Eds.) *Biorefineries*, Elsevier, Amsterdam, 2014, pp. 237-254.
- [55] A. Oudshoorn, L.A. Van Der Wielen, A.J. Straathof, Assessment of options for selective 1-butanol recovery from aqueous solution, *Ind. Eng. Chem. Res.* 48 (2009) 7325-7336.
- [56] I.S. Maddox, The acetone-butanol-ethanol fermentation: Recent progress in technology, *Biotechnol. Genet. Eng. Rev.* 7 (1989) 189-220.
- [57] W. Groot, R. Van der Lans, K.C.A. Luyben, Technologies for butanol recovery integrated with fermentations, *Process Biochem.* 27 (1992) 61-75.
- [58] L.M. Vane, Separation technologies for the recovery and dehydration of alcohols from fermentation broths, *Biofuels, Bioproducts and Biorefining* 2 (2008) 553-588.
- [59] X. Lin, J. Wu, J. Fan, W. Qian, X. Zhou, C. Qian, X. Jin, L. Wang, J. Bai, H. Ying, Adsorption of butanol from aqueous solution onto a new type of macroporous adsorption resin: studies of adsorption isotherms and kinetics simulation, *J. Chem. Technol. Biotechnol.* 87 (2012) 924-931.
- [60] T.J. Levario, M. Dai, W. Yuan, B.D. Vogt, D.R. Nielsen, Rapid adsorption of alcohol biofuels by high surface area mesoporous carbons, *Micropor. Mesopor. Mat.* 148 (2012) 107-114.
- [61] A. Oudshoorn, L.A. van der Wielen, A.J. Straathof, Adsorption equilibria of bio-based butanol solutions using zeolite, *Biochem. Eng. J.* 48 (2009) 99-103.
- [62] P. Sharma, W.-J. Chung, Synthesis of MEL type zeolite with different kinds of morphology for the recovery of 1-butanol from aqueous solution, *Desalination* 275 (2011) 172-180.

- [63] T. Ezeji, N. Qureshi, H. Blaschek, Production of acetone, butanol and ethanol by *Clostridium beijerinckii* BA101 and in situ recovery by gas stripping, *World J. Microbiol. Biotechnol.* 19 (2003) 595-603.
- [64] C.H. Park, M.R. Okos, P.C. Wankat, Acetone-butanol-ethanol (ABE) fermentation and simultaneous separation in a trickle bed reactor, *Biotechnol. Prog.* 7 (1991) 185-194.
- [65] T.C. Ezeji, P.M. Karcher, N. Qureshi, H.P. Blaschek, Improving performance of a gas stripping-based recovery system to remove butanol from *Clostridium beijerinckii* fermentation, *Bioproc. Biosyst. Eng.* 27 (2005) 207-214.
- [66] N. Qureshi, H. Blaschek, Recovery of butanol from fermentation broth by gas stripping, *Renew. Energ.* 22 (2001) 557-564.
- [67] M. Setlhaku, S. Heitmann, A. Górak, R. Wichmann, Investigation of gas stripping and pervaporation for improved feasibility of two-stage butanol production process, *Bioresour. Technol.* 136 (2013) 102-108.
- [68] F. Liu, L. Liu, X. Feng, Separation of acetone–butanol–ethanol (ABE) from dilute aqueous solutions by pervaporation, *Sep. Purif. Technol.* 42 (2005) 273-282.
- [69] A. Rozicka, J. Niemistö, R.L. Keiski, W. Kujawski, Apparent and intrinsic properties of commercial PDMS based membranes in pervaporative removal of acetone, butanol and ethanol from binary aqueous mixtures, *J. Membr. Sci.* 453 (2014) 108-118.
- [70] L.M. Vane, A review of pervaporation for product recovery from biomass fermentation processes, *J. Chem. Technol. Biotechnol.* 80 (2005) 603-629.
- [71] J. Niemistö, W. Kujawski, R.L. Keiski, Pervaporation performance of composite poly (dimethyl siloxane) membrane for butanol recovery from model solutions, *J. Membr. Sci.* 434 (2013) 55-64.
- [72] W. Liu, S.L. Ji, H.X. Guo, J. Gao, Z.P. Qin, In situ cross-linked-PDMS/BPPO membrane for the recovery of butanol by pervaporation, *J. Appl. Polym. Sci.* 131 (2014).
- [73] E.A. Fouad, X. Feng, Pervaporative separation of n-butanol from dilute aqueous solutions using silicalite-filled poly (dimethyl siloxane) membranes, *J. Membr. Sci.* 339 (2009) 120-125.
- [74] S.-Y. Li, R. Srivastava, R.S. Parnas, Separation of 1-butanol by pervaporation using a novel tri-layer PDMS composite membrane, *J. Membr. Sci.* 363 (2010) 287-294.
- [75] V. García, E. Pongrácz, E. Muurinen, R.L. Keiski, Recovery of n-butanol from salt containing solutions by pervaporation, *Desalination* 241 (2009) 201-211.
- [76] H. Tan, Y. Wu, T. Li, Pervaporation of n-butanol aqueous solution through ZSM-5-PEBA composite membranes, *J. Appl. Polym. Sci.* 129 (2013) 105-112.
- [77] C. Tong, Y. Bai, J. Wu, L. Zhang, L. Yang, J. Qian, Pervaporation recovery of acetone-butanol from aqueous solution and fermentation broth using HTPB-based polyurethaneurea membranes, *Sep. Sci. Technol.* 45 (2010) 751-761.
- [78] S. Claes, P. Vandezande, S. Mullens, K. De Sitter, R. Peeters, M.K. Van Bael, Preparation and benchmarking of thin film supported PTMSP-silica pervaporation membranes, *J. Membr. Sci.* 389 (2012) 265-271.

- [79] D.L. Vrana, M.M. Meagher, R.W. Hutkins, B. Duffield, Pervaporation of model acetone-butanol-ethanol fermentation product solutions using polytetrafluoroethylene membranes, *Sep. Sci. Technol.* 28 (1993) 2167-2178.
- [80] J. Liu, L. Fan, P. Seib, F. Friedler, B. Bertok, Downstream process synthesis for biochemical production of butanol, ethanol, and acetone from grains: generation of optimal and near-optimal flowsheets with conventional operating units, *Biotechnol. Prog.* 20 (2004) 1518-1527.
- [81] J. Liu, L. Fan, P. Seib, F. Friedler, B. Bertok, Holistic approach to process retrofitting: Application to downstream process for biochemical production of organics, *Ind. Eng. Chem. Res.* 45 (2006) 4200-4207.
- [82] H. Luo, L. Ge, J. Zhang, J. Ding, R. Chen, Z. Shi, Enhancing acetone biosynthesis and acetone-butanol-ethanol fermentation performance by co-culturing *Clostridium acetobutylicum*/*Saccharomyces cerevisiae* integrated with exogenous acetate addition, *Bioresour. Technol.* 200 (2016) 111-120.
- [83] H. Luo, J. Zhang, H. Wang, R. Chen, Z. Shi, X. Li, J. Ding, Effectively enhancing acetone concentration and acetone/butanol ratio in ABE fermentation by a glucose/acetate co-substrate system incorporating with glucose limitation and *C. acetobutylicum*/*S. cerevisiae* co-culturing, *Biochem. Eng. J.* 118 (2017) 132-142.
- [84] P. Dürre, Fermentative Butanol Production, *Ann. N. Y. Acad. Sci.* 1125 (2008) 353-362.
- [85] E.M. Green, Fermentative production of butanol—the industrial perspective, *Curr. Opin. Biotechnol.* 22 (2011) 337-343.
- [86] P.H. Pfromm, V. Amanor-Boadu, R. Nelson, P. Vadlani, R. Madl, Bio-butanol vs. bio-ethanol: A technical and economic assessment for corn and switchgrass fermented by yeast or *Clostridium acetobutylicum*, *Biomass and Bioenergy* 34 (2010) 515-524.
- [87] N. Qureshi, H. Blaschek, ABE production from corn: a recent economic evaluation, *J. Ind. Microbiol. Biotechnol.* 27 (2001) 292-297.
- [88] A. Friedl, Downstream process options for the ABE fermentation, *FEMS Microbiol. Lett.* 363 (2016).
- [89] H.-J. Huang, S. Ramaswamy, Y. Liu, Separation and purification of biobutanol during bioconversion of biomass, *Sep. Purif. Technol.* 132 (2014) 513-540.
- [90] A. Kurkijärvi, J. Lehtonen, J. Linnekoski, Novel dual extraction process for acetone-butanol-ethanol fermentation, *Sep. Purif. Technol.* 124 (2014) 18-25.
- [91] V.I. Águeda, J.A. Delgado, M.A. Uguina, J.L. Sotelo, Á. García, Column dynamics of an adsorption-drying-desorption process for butanol recovery from aqueous solutions with silicalite pellets, *Sep. Purif. Technol.* 104 (2013) 307-321.
- [92] S. Fournier, G. Simon, P. Seers, Evaluation of low concentrations of ethanol, butanol, BE, and ABE blended with gasoline in a direct-injection, spark-ignition engine, *Fuel* 181 (2016) 396-407.

- [93] Y. Li, L. Meng, K. Nithyanandan, T.H. Lee, Y. Lin, F.L. Chia-fon, S. Liao, Combustion, performance and emissions characteristics of a spark-ignition engine fueled with isopropanol-n-butanol-ethanol and gasoline blends, *Fuel* 184 (2016) 864-872.
- [94] N. Zhou, H. Wu, C.-F. Lee, Q. Wang, M. Huo, P. Wang, Different percentage of acetone-butanol-ethanol (ABE) and diesel blends at low temperature condition in a constant volume chamber, *SAE Tech. Pap.* 2014-01-1257 (2014).
- [95] S.J.M. Algayyim, A.P. Wandel, T. Yusaf, I. Hamawand, Production and application of ABE as a biofuel, *Renew. Sust. Energ. Rev.* 82 (2018) 1195-1214.
- [96] Y. Li, W. Tang, Y. Chen, J. Liu, F.L. Chia-fon, Potential of acetone-butanol-ethanol (ABE) as a biofuel, *Fuel* 242 (2019) 673-686.
- [97] K. Han, B. Pang, X. Ma, H. Chen, G. Song, Z. Ni, An experimental study of the burning characteristics of acetone-butanol-ethanol and diesel blend droplets, *Energy* 139 (2017) 853-861.
- [98] E. Elbeshbishy, B.R. Dhar, H. Hafez, H.-S. Lee, Acetone-butanol-ethanol production in a novel continuous flow system, *Bioresour. Technol.* 190 (2015) 315-320.
- [99] Y.-S. Jang, J.Y. Lee, J. Lee, J.H. Park, J.A. Im, M.-H. Eom, J. Lee, S.-H. Lee, H. Song, J.-H. Cho, Enhanced butanol production obtained by reinforcing the direct butanol-forming route in *Clostridium acetobutylicum*, *MBio* 3 (2012) e00314-00312.
- [100] Y. Tashiro, K. Takeda, G. Kobayashi, K. Sonomoto, A. Ishizaki, S. Yoshino, High butanol production by *Clostridium saccharoperbutylacetonicum* N1-4 in fed-batch culture with pH-stat continuous butyric acid and glucose feeding method, *J. Biosci. Bioeng.* 98 (2004) 263-268.
- [101] X. Li, Z.-G. Li, Z.-P. Shi, Metabolic flux and transcriptional analysis elucidate higher butanol/acetone ratio feature in ABE extractive fermentation by *Clostridium acetobutylicum* using cassava substrate, *Bioresources and Bioprocessing* 1 (2014) 13.
- [102] X. Li, Z. Shi, Z. Li, Increasing butanol/acetone ratio and solvent productivity in ABE fermentation by consecutively feeding butyrate to weaken metabolic strength of butyrate loop, *Bioproc. Biosyst. Eng.* 37 (2014) 1609-1616.
- [103] Y.-C. Chang, W.-J. Lee, S.-L. Lin, L.-C. Wang, Green energy: Water-containing acetone-butanol-ethanol diesel blends fueled in diesel engines, *Appl. Energ.* 109 (2013) 182-191.
- [104] H. Wu, M. Huo, N. Zhou, K. Nithyanandan, C.-F. Lee, C. Zhang, J. Lin, An experimental investigation of the combustion characteristics of acetone-butanol-ethanol-diesel blends with different ABE component ratios in a constant volume chamber, *SAE Tech. Pap.* 2014-01-1452 (2014).
- [105] S.J.M. Algayyim, A.P. Wandel, T. Yusaf, S. Al-Lwayzy, Butanol-acetone mixture blended with cottonseed biodiesel: Spray characteristics evolution, combustion characteristics, engine performance and emission, *P. Combust. Inst.* 37 (2019) 4729-4739.

- [106] S.J.M. Algayyim, A.P. Wandel, T. Yusaf, S. Al-Lwayzy, I. Hamawand, Impact of butanol-acetone mixture as a fuel additive on diesel engine performance and emissions, *Fuel* 227 (2018) 118-126.
- [107] S.J.M. Algayyim, A.P. Wandel, T. Yusaf, I. Hamawand, The impact of n-butanol and iso-butanol as components of butanol-acetone (BA) mixture-diesel blend on spray, combustion characteristics, engine performance and emission in direct injection diesel engine, *Energy* 140 (2017) 1074-1086.
- [108] H. Wu, K. Nithyanandan, J. Zhang, Y. Lin, T.H. Lee, F.L. Chia-fon, C. Zhang, Impacts of Acetone–Butanol–Ethanol (ABE) ratio on spray and combustion characteristics of ABE–diesel blends, *Appl. Energ.* 149 (2015) 367-378.
- [109] N. Zhou, M. Huo, H. Wu, K. Nithyanandan, F.L. Chia-fon, Q. Wang, Low temperature spray combustion of acetone–butanol–ethanol (ABE) and diesel blends, *Appl. Energ.* 117 (2014) 104-115.
- [110] G. Knothe, Dependence of biodiesel fuel properties on the structure of fatty acid alkyl esters, *Fuel Process. Technol.* 86 (2005) 1059-1070.
- [111] Y. Zhuang, G. Hong, Primary investigation to leveraging effect of using ethanol fuel on reducing gasoline fuel consumption, *Fuel* 105 (2013) 425-431.
- [112] M.K. Balki, C. Sayin, M. Canakci, The effect of different alcohol fuels on the performance, emission and combustion characteristics of a gasoline engine, *Fuel* 115 (2014) 901-906.
- [113] N. Yilmaz, A. Atmanli, Experimental evaluation of a diesel engine running on the blends of diesel and pentanol as a next generation higher alcohol, *Fuel* 210 (2017) 75-82.
- [114] T. Zhang, L.J. Nilsson, C. Björkholtz, K. Munch, I. Denbratt, Effect of using butanol and octanol isomers on engine performance of steady state and cold start ability in different types of diesel engines, *Fuel* 184 (2016) 708-717.
- [115] D.H. Qi, K. Yang, D. Zhang, B. Chen, Q. Wei, C.H. Zhang, Experimental investigation of a turbocharged CRDI diesel engine fueled with Tung oil-diesel-ethanol microemulsion fuel, *Renew. Energ.* 113 (2017) 1201-1207.
- [116] M. Yusoff, N. Zulkifli, B. Masum, H. Masjuki, Feasibility of bioethanol and biobutanol as transportation fuel in spark-ignition engine: A review, *RSC Adv.* 5 (2015) 100184-100211.
- [117] A. Jamrozik, The effect of the alcohol content in the fuel mixture on the performance and emissions of a direct injection diesel engine fueled with diesel-methanol and diesel-ethanol blends, *Energ. Convers. Manage.* 148 (2017) 461-476.
- [118] M. Canakci, Combustion characteristics of a turbocharged DI compression ignition engine fueled with petroleum diesel fuels and biodiesel, *Bioresour. Technol.* 98 (2007) 1167-1175.
- [119] M. Karabektas, M. Hosoz, Performance and emission characteristics of a diesel engine using isobutanol–diesel fuel blends, *Renew. Energ.* 34 (2009) 1554-1559.

- [120] S. Puhan, N. Saravanan, G. Nagarajan, N. Vedaraman, Effect of biodiesel unsaturated fatty acid on combustion characteristics of a DI compression ignition engine, *Biomass Bioenergy* 34 (2010) 1079-1088.
- [121] A. Bilgin, O. Durgun, Z. Sahin, The effects of diesel-ethanol blends on diesel engine performance, *Energ. Source.* 24 (2002) 431-440.
- [122] M. Canakci, A.N. Ozsezen, E. Alptekin, M. Eyidogan, Impact of alcohol-gasoline fuel blends on the exhaust emission of an SI engine, *Renew. Energ.* 52 (2013) 111-117.
- [123] F. Li, B. Yi, W. Fu, L. Song, T. Liu, H. Hu, Q. Lin, Experimental study on spray characteristics of long-chain alcohol-diesel fuels in a constant volume chamber, *J. Energy Inst.* (2017).
- [124] D.B. Hulwan, S.V. Joshi, Performance, emission and combustion characteristic of a multicylinder DI diesel engine running on diesel-ethanol-biodiesel blends of high ethanol content, *Appl. Energ.* 88 (2011) 5042-5055.
- [125] Q. Fang, J. Fang, J. Zhuang, Z. Huang, Effects of ethanol-diesel-biodiesel blends on combustion and emissions in premixed low temperature combustion, *Appl. Therm. Eng.* 54 (2013) 541-548.
- [126] D. Qi, K. Yang, D. Zhang, B. Chen, Combustion and emission characteristics of diesel-tung oil-ethanol blended fuels used in a CRDI diesel engine with different injection strategies, *Appl. Therm. Eng.* 111 (2017) 927-935.
- [127] T.J. Jacobs, D.N. Assanis, The attainment of premixed compression ignition low-temperature combustion in a compression ignition direct injection engine, *P. Combust. Inst.* 31 (2007) 2913-2920.
- [128] W. Tutak, K. Lukács, S. Szwaja, Á. Bereczky, Alcohol-diesel fuel combustion in the compression ignition engine, *Fuel* 154 (2015) 196-206.
- [129] X. Li, X. Qiao, L. Zhang, J. Fang, Z. Huang, H. Xia, Combustion and emission characteristics of a two-stroke diesel engine operating on alcohol, *Renew. Energ.* 30 (2005) 2075-2084.
- [130] A. Datta, B.K. Mandal, Impact of alcohol addition to diesel on the performance combustion and emissions of a compression ignition engine, *Appl. Therm. Eng.* 98 (2016) 670-682.
- [131] Q. Zhang, M. Yao, Z. Zheng, H. Liu, J. Xu, Experimental study of n-butanol addition on performance and emissions with diesel low temperature combustion, *Energy* 47 (2012) 515-521.
- [132] J. Lei, L. Shen, Y. Bi, H. Chen, A novel emulsifier for ethanol-diesel blends and its effect on performance and emissions of diesel engine, *Fuel* 93 (2012) 305-311.
- [133] D. Kannan, S. Pachamuthu, M. Nurun Nabi, J.E. Hustad, T. Løvås, Theoretical and experimental investigation of diesel engine performance, combustion and emissions analysis fuelled with the blends of ethanol, diesel and jatropha methyl ester, *Energ. Convers. Manage.* 53 (2012) 322-331.

- [134] H. Aydin, C. İlkılıç, Effect of ethanol blending with biodiesel on engine performance and exhaust emissions in a CI engine, *Appl. Therm. Eng.* 30 (2010) 1199-1204.
- [135] K.M. Van Geem, A. Cuoci, A. Frassoldati, S.P. Pyl, G.B. Marin, E. Ranzi, An experimental and kinetic modeling study of pyrolysis and combustion of acetone–butanol–ethanol (ABE) mixtures, *Combust. Sci. Technol.* 184 (2012) 942-955.
- [136] G. Broustail, F. Halter, P. Seers, G. Moréac, C. Mounaïm-Rousselle, Experimental determination of laminar burning velocity for butanol/iso-octane and ethanol/iso-octane blends for different initial pressures, *Fuel* 106 (2013) 310-317.
- [137] Q. Li, E. Hu, Y. Cheng, Z. Huang, Measurements of laminar flame speeds and flame instability analysis of 2-methyl-1-butanol–air mixtures, *Fuel* 112 (2013) 263-271.
- [138] J. Van Lipzig, E. Nilsson, L. De Goey, A.A. Konnov, Laminar burning velocities of n-heptane, iso-octane, ethanol and their binary and tertiary mixtures, *Fuel* 90 (2011) 2773-2781.
- [139] E. Varea, V. Modica, B. Renou, A.M. Boukhalfa, Pressure effects on laminar burning velocities and Markstein lengths for isooctane–ethanol–air mixtures, *P. Combust. Inst.* 34 (2013) 735-744.
- [140] X. Zhang, C. Tang, H. Yu, Q. Li, J. Gong, Z. Huang, Laminar flame characteristics of iso-octane/n-butanol blend–air mixtures at elevated temperatures, *Energy Fuels* 27 (2013) 2327-2335.
- [141] A.K. Agarwal, H. Karare, A. Dhar, Combustion, performance, emissions and particulate characterization of a methanol–gasoline blend (gasohol) fuelled medium duty spark ignition transportation engine, *Fuel Process. Technol.* 121 (2014) 16-24.
- [142] A.O. Emiroğlu, M. Şen, Combustion, performance and emission characteristics of various alcohol blends in a single cylinder diesel engine, *Fuel* 212 (2018) 34-40.
- [143] A.O. Emiroğlu, M. Şen, Combustion, performance and exhaust emission characterizations of a diesel engine operating with a ternary blend (alcohol-biodiesel-diesel fuel), *Appl. Therm. Eng.* 133 (2018) 371-380.
- [144] E. Galloni, F. Scala, G. Fontana, Influence of fuel bio-alcohol content on the performance of a turbo-charged, PFI, spark-ignition engine, *Energy* 170 (2019) 85-92.
- [145] H. Chen, B. Xie, J. Ma, Y. Chen, NO_x emission of biodiesel compared to diesel: Higher or lower?, *Appl. Therm. Eng.* 137 (2018) 584-593.
- [146] Z. Huang, J. Xia, D. Ju, X. Lu, D. Han, X. Qiao, Z. Huang, A six-component surrogate of diesel from direct coal liquefaction for spray analysis, *Fuel* 234 (2018) 1259-1268.
- [147] F. Li, W. Fu, B. Yi, L. Song, T. Liu, X. Wang, C. Wang, Y. Lei, Q. Lin, Comparison of macroscopic spray characteristics between biodiesel-pentanol blends and diesel, *Exp. Therm. Fluid. Sci.* 98 (2018) 523-533.
- [148] L.A. Graham, S.L. Belisle, C.-L. Baas, Emissions from light duty gasoline vehicles operating on low blend ethanol gasoline and E85, *Atmos. Environ.* 42 (2008) 4498-4516.

- [149] L. Sileghem, V.A. Alekseev, J. Vancoillie, K.M. Van Geem, E.J.K. Nilsson, S. Verhelst, A.A. Konnov, Laminar burning velocity of gasoline and the gasoline surrogate components iso-octane, n-heptane and toluene, *Fuel* 112 (2013) 355-365.
- [150] O. Doğan, The influence of n-butanol/diesel fuel blends utilization on a small diesel engine performance and emissions, *Fuel* 90 (2011) 2467-2472.
- [151] C.T. Chong, S. Hochgreb, Measurements of laminar flame speeds of acetone/methane/air mixtures, *Combust. Flame* 158 (2011) 490-500.
- [152] T. Wallner, A. Ickes, K. Lawyer, Analytical Assessment of C₂–C₈ Alcohols as Spark-Ignition Engine Fuels, in: *Proceedings of the FISITA 2012 World Automotive Congress*, Springer Berlin Heidelberg, Berlin, Heidelberg, 2013, pp. 15-26.
- [153] P.S. Veloo, Y.L. Wang, F.N. Egolfopoulos, C.K. Westbrook, A comparative experimental and computational study of methanol, ethanol, and n-butanol flames, *Combust. Flame* 157 (2010) 1989-2004.
- [154] S. Zhang, T.H. Lee, H. Wu, J. Pei, W. Wu, F. Liu, C. Zhang, Experimental and kinetic studies on laminar flame characteristics of acetone-butanol-ethanol (ABE) and toluene reference fuel (TRF) blends at atmospheric pressure, *Fuel* 232 (2018) 755-768.
- [155] B. Masum, H.H. Masjuki, M.A. Kalam, S. Palash, M. Habibullah, Effect of alcohol–gasoline blends optimization on fuel properties, performance and emissions of a SI engine, *J. Clean. Prod.* 86 (2015) 230-237.
- [156] M. Kapusuz, H. Ozcan, J.A. Yamin, Research of performance on a spark ignition engine fueled by alcohol–gasoline blends using artificial neural networks, *Appl. Therm. Eng.* 91 (2015) 525-534.
- [157] A. Elfasakhany, A.-F. Mahrous, Performance and emissions assessment of n-butanol–methanol–gasoline blends as a fuel in spark-ignition engines, *Alex. Eng. J.* 55 (2016) 3015-3024.
- [158] Y. Li, K. Nithyanandan, J. Zhang, C.-F. Lee, S. Liao, Combustion and emissions performance of a spark ignition engine fueled with water containing acetone-butanol-ethanol and gasoline blends, *SAE Tech. Pap.* 2015-01-0908 (2015).
- [159] Y. Li, K. Nithyanandan, T.H. Lee, R.M. Donahue, Y. Lin, C.-F. Lee, S. Liao, Effect of water-containing acetone–butanol–ethanol gasoline blends on combustion, performance, and emissions characteristics of a spark-ignition engine, *Energ. Convers. Manage.* 117 (2016) 21-30.
- [160] C. Sayin, I. Kilicaslan, M. Canakci, N. Ozsezen, An experimental study of the effect of octane number higher than engine requirement on the engine performance and emissions, *Appl. Therm. Eng.* 25 (2005) 1315-1324.
- [161] K. Nithyanandan, H. Wu, M. Huo, C.-F. Lee, A preliminary investigation of the performance and emissions of a port-fuel injected SI engine fueled with Acetone-Butanol-Ethanol (ABE) and gasoline, *SAE Tech. Pap.* 2014-01-1459 (2014).
- [162] K. Nithyanandan, F.L. Chia-fon, H. Wu, J. Zhang, Performance and emissions of acetone-butanol-ethanol (ABE) and gasoline blends in a port fuel injected spark ignition

- engine, in: ASME 2014 Internal Combustion Engine Division Fall Technical Conference, American Society of Mechanical Engineers, Columbus, IN, USA 2014, pp. 1-11.
- [163] K. Nithyanandan, J. Zhang, L. Yuqiang, H. Wu, C.-F. Lee, Investigating the impact of acetone on the performance and emissions of acetone-butanol-ethanol (ABE) and gasoline blends in an SI engine, SAE Tech. Pap. 2015-01-0909 (2015).
- [164] J. Zhang, K. Nithyanandan, Y. Li, C.-F. Lee, Z. Huang, Comparative study of high-alcohol-content gasoline blends in an SI engine, SAE Tech. Pap. 2015-01-0891 (2015).
- [165] K. Nithyanandan, J. Zhang, Y. Li, H. Wu, T.H. Lee, Y. Lin, F.L. Chia-fon, Improved SI engine efficiency using acetone-butanol-ethanol (ABE), Fuel 174 (2016) 333-343.
- [166] Y. Li, L. Meng, K. Nithyanandan, T.H. Lee, Y. Lin, F.L. Chia-fon, S. Liao, Experimental investigation of a spark ignition engine fueled with acetone-butanol-ethanol and gasoline blends, Energy 121 (2017) 43-54.
- [167] Y. Li, K. Nithyanandan, Z. Ning, C.-F. Lee, H. Wu, Regulated and unregulated emissions from a spark ignition engine fueled with acetone-butanol-ethanol (ABE)-gasoline blends, SAE Tech. Pap. 2017-01-2328 (2017).
- [168] Y. Li, Z. Ning, F.L. Chia-fon, J. Yan, T.H. Lee, Effect of acetone-butanol-ethanol (ABE)-gasoline blends on regulated and unregulated emissions in spark-ignition engine, Energy 168 (2019) 1157-1167.
- [169] Y.-z. An, S.-p. Teng, Y.-q. Pei, J. Qin, X. Li, H. Zhao, An experimental study of polycyclic aromatic hydrocarbons and soot emissions from a GDI engine fueled with commercial gasoline, Fuel 164 (2016) 160-171.
- [170] Y. Luo, L. Zhu, J. Fang, Z. Zhuang, C. Guan, C. Xia, X. Xie, Z. Huang, Size distribution, chemical composition and oxidation reactivity of particulate matter from gasoline direct injection (GDI) engine fueled with ethanol-gasoline fuel, Appl. Therm. Eng. 89 (2015) 647-655.
- [171] B.M. Graves, C.R. Koch, J.S. Olfert, Morphology and volatility of particulate matter emitted from a gasoline direct injection engine fuelled on gasoline and ethanol blends, J. Aerosol Sci. 105 (2017) 166-178.
- [172] G.D.J. Guerrero Peña, Y.A. Hammid, A. Raj, S. Stephen, T. Anjana, V. Balasubramanian, On the characteristics and reactivity of soot particles from ethanol-gasoline and 2,5-dimethylfuran-gasoline blends, Fuel 222 (2018) 42-55.
- [173] C. Russo, A. D'Anna, A. Ciajolo, M. Sirignano, The effect of butanol isomers on the formation of carbon particulate matter in fuel-rich premixed ethylene flames, Combust. Flame 199 (2019) 122-130.
- [174] C. Hergueta, M. Bogarra, A. Tsolakis, K. Essa, J.M. Herreros, Butanol-gasoline blend and exhaust gas recirculation, impact on GDI engine emissions, Fuel 208 (2017) 662-672.
- [175] X. Yu, Z. Guo, L. He, W. Dong, P. Sun, W. Shi, Y. Du, F. He, Effect of gasoline/n-butanol blends on gaseous and particle emissions from an SI direct injection engine, Fuel 229 (2018) 1-10.

- [176] C. Russo, A. D'Anna, A. Ciajolo, M. Sirignano, Analysis of the chemical features of particles generated from ethylene and ethylene/2, 5 dimethyl furan flames, *Combust. Flame* 167 (2016) 268-273.
- [177] M. Sirignano, A. Ciajolo, A. D'Anna, C. Russo, Chemical features of particles generated in an ethylene/ethanol premixed flame, *Energy Fuels* 31 (2017) 2370-2377.
- [178] Z. Xu, X. Li, C. Guan, Z. Huang, Characteristics of exhaust diesel particles from different oxygenated fuels, *Energy Fuels* 27 (2013) 7579-7586.
- [179] J. Song, M. Alam, A.L. Boehman, U. Kim, Examination of the oxidation behavior of biodiesel soot, *Combust. Flame* 146 (2006) 589-604.
- [180] T.H. Lee, Y. Lin, X. Meng, Y. Li, K. Nithyanandan, Combustion characteristics of acetone, butanol, and ethanol (ABE) blended with diesel in a compression-ignition engine, *SAE Tech. Pap.* 2016-01-0884 (2016).
- [181] J. Song, C. Zhang, An experimental study on the performance and exhaust emissions of a diesel engine fuelled with soybean oil methyl ester, *Proc. Inst. Mech. Eng. Pt. D: J. Automobile Eng.* 222 (2008) 2487-2496.
- [182] A.K. Agarwal, D.K. Srivastava, A. Dhar, R.K. Maurya, P.C. Shukla, A.P. Singh, Effect of fuel injection timing and pressure on combustion, emissions and performance characteristics of a single cylinder diesel engine, *Fuel* 111 (2013) 374-383.
- [183] A.C. Hansen, Q. Zhang, P.W.L. Lyne, Ethanol–diesel fuel blends – A review, *Bioresour. Technol.* 96 (2005) 277-285.
- [184] D.-g. Li, H. Zhen, L. Xingcai, Z. Wu-gao, Y. Jian-guang, Physico-chemical properties of ethanol–diesel blend fuel and its effect on performance and emissions of diesel engines, *Renew. Energ.* 30 (2005) 967-976.
- [185] E. Alptekin, M. Canakci, Characterization of the key fuel properties of methyl ester–diesel fuel blends, *Fuel* 88 (2009) 75-80.
- [186] A. Schwab, M. Bagby, B. Freedman, Preparation and properties of diesel fuels from vegetable oils, *Fuel* 66 (1987) 1372-1378.
- [187] Y.-C. Chang, W.-J. Lee, T.S. Wu, C.-Y. Wu, S.-J. Chen, Use of water containing acetone–butanol–ethanol for NOx-PM (nitrogen oxide-particulate matter) trade-off in the diesel engine fueled with biodiesel, *Energy* 64 (2014) 678-687.
- [188] H. Wu, K. Nithyanandan, T.H. Lee, C.-f.F. Lee, C. Zhang, Spray and combustion characteristics of neat acetone-butanol-ethanol, n-butanol, and diesel in a constant volume chamber, *Energy Fuels* 28 (2014) 6380-6391.
- [189] H. Wu, K. Nithyanandan, N. Zhou, T.H. Lee, F.L. Chia-fon, C. Zhang, Impacts of acetone on the spray combustion of Acetone–Butanol–Ethanol (ABE)-Diesel blends under low ambient temperature, *Fuel* 142 (2015) 109-116.
- [190] X. Ma, F. Zhang, K. Han, B. Yang, G. Song, Evaporation characteristics of acetone–butanol–ethanol and diesel blends droplets at high ambient temperatures, *Fuel* 160 (2015) 43-49.

- [191] Z. Zhao, Z. Xu, J. Liu, M. Wang, C.-F. Lee, W. Chang, J. Hou, Experimental and numerical investigation of soot mechanism of acetone-butanol-ethanol (ABE) with various oxygen concentrations, SAE Tech. Pap. 2015-01-0389 (2015).
- [192] Y. Lin, T. Lee, K. Nithyanandan, J. Zhang, Y. Li, C.-F. Lee, Experimental investigation and analysis of combustion process in a diesel engine fueled with acetone-butanol-ethanol/diesel blends, SAE Tech. Pap. 2016-01-0737 (2016).
- [193] S. Zhang, Z. Xu, T. Lee, Y. Lin, W. Wu, C.-F. Lee, A semi-detailed chemical kinetic mechanism of acetone-butanol-ethanol (ABE) and diesel blends for combustion simulations, SAE Int. J. Engines 9 (2016) 631-640.
- [194] J. Fu, J. Shu, Z. Zhao, J. Liu, F. Zhou, Comparative analysis of soot formation processes of diesel and ABE (Acetone-Butanol-Ethanol) based on CFD coupling with phenomenological soot model, Fuel 203 (2017) 380-392.
- [195] J. Luo, Y. Zhang, J. Wang, Q. Zhang, Effect of acetone-butanol-ethanol addition to diesel on the soot reactivity, Fuel 226 (2018) 555-563.
- [196] V.M. Ortiz-Martínez, P. Andreo-Martínez, N. García-Martínez, A.P. de los Ríos, F.J. Hernández-Fernández, J. Quesada-Medina, Approach to biodiesel production from microalgae under supercritical conditions by the PRISMA method, Fuel Process. Technol. 191 (2019) 211-222.
- [197] H. An, W.M. Yang, S.K. Chou, K.J. Chua, Combustion and emissions characteristics of diesel engine fueled by biodiesel at partial load conditions, Appl. Energ. 99 (2012) 363-371.
- [198] X. Gu, G. Li, X. Jiang, Z. Huang, C.-f. Lee, Experimental study on the performance of and emissions from a low-speed light-duty diesel engine fueled with n-butanol-diesel and isobutanol-diesel blends, Proc. Inst. Mech. Eng. Pt. D: J. Automobile Eng. 227 (2012) 261-271.
- [199] C. Shen, W.L. Cheng, C.-F. Lee, Micro-explosion modeling of biofuel-diesel blended droplets, SAE Int. J. Engines 4 (2011) 1445-1454.
- [200] J. Heywood, Internal combustion engine fundamentals, McGraw-Hill, 1988.
- [201] J.M. Desantes, J. Arrègle, J.V. Pastor, A. Delage, Influence of the fuel characteristics on the injection process in a DI diesel engine, SAE Tech. Pap. 980802 (1998) 1185-1195.
- [202] Ö. Can, I. Celikten, N. Usta, Effects of ethanol addition on performance and emissions of a turbocharged indirect injection Diesel engine running at different injection pressures, Energ. Convers. Manage. 45 (2004) 2429-2440.
- [203] D. Rakopoulos, C. Rakopoulos, E. Giakoumis, A. Dimaratos, D. Kyritsis, Effects of butanol-diesel fuel blends on the performance and emissions of a high-speed DI diesel engine, Energ. Convers. Manage. 51 (2010) 1989-1997.
- [204] G. Labeckas, S. Slavinskas, Performance and emission characteristics of a direct injection diesel engine operating on KDV synthetic diesel fuel, Energ. Convers. Manage. 66 (2013) 173-188.
- [205] S.W. Kruczyński, Performance and emission of CI engine fuelled with camelina sativa oil, Energ. Convers. Manage. 65 (2013) 1-6.

- [206] K. Muralidharan, D. Vasudevan, Performance, emission and combustion characteristics of a variable compression ratio engine using methyl esters of waste cooking oil and diesel blends, *Appl. Energ.* 88 (2011) 3959-3968.
- [207] K. Vasu, D. Gupta, S. Naseer, Performance and emission characteristics of n-butanol and Iso-butanol diesel blend comparison, *SAE Tech. Pap.* 2015-01-2819 (2015).
- [208] F. Wu, C.K. Law, An experimental and mechanistic study on the laminar flame speed, Markstein length and flame chemistry of the butanol isomers, *Combust. Flame* 160 (2013) 2744-2756.
- [209] X. Gu, Z. Huang, S. Wu, Q. Li, Laminar burning velocities and flame instabilities of butanol isomers–air mixtures, *Combust. Flame* 157 (2010) 2318-2325.
- [210] S. Fernando, C. Hall, S. Jha, NO_x reduction from biodiesel fuels, *Energy Fuels* 20 (2006) 376-382.
- [211] S.K. Hoekman, C. Robbins, Review of the effects of biodiesel on NO_x emissions, *Fuel Process. Technol.* 96 (2012) 237-249.
- [212] K. Varatharajan, M. Cheralathan, R. Velraj, Mitigation of NO_x emissions from a jatropha biodiesel fuelled DI diesel engine using antioxidant additives, *Fuel* 90 (2011) 2721-2725.
- [213] J. Zheng, J.A. Caton, Effects of operating parameters on nitrogen oxides emissions for a natural gas fueled homogeneous charged compression ignition engine (HCCI): Results from a thermodynamic model with detailed chemistry, *Appl. Energ.* 92 (2012) 386-394.
- [214] G. Chen, Y. Shen, Q. Zhang, M. Yao, Z. Zheng, H. Liu, Experimental study on combustion and emission characteristics of a diesel engine fueled with 2,5-dimethylfuran–diesel, n-butanol–diesel and gasoline–diesel blends, *Energy* 54 (2013) 333-342.
- [215] J.T. Moss, A.M. Berkowitz, M.A. Oehlschlaeger, J. Biet, V. Warth, P.-A. Glaude, F. Battin-Leclerc, An experimental and kinetic modeling study of the oxidation of the four isomers of butanol, *J. Phys. Chem. A* 112 (2008) 10843-10855.
- [216] L.M. Pickett, D.L. Siebers, Soot in diesel fuel jets: effects of ambient temperature, ambient density, and injection pressure, *Combust. Flame* 138 (2004) 114-135.
- [217] L.M. Pickett, D.L. Siebers, C.A. Idicheria, Relationship between ignition processes and the lift-off length of diesel fuel jets, *SAE Tech. Pap.* 2005-01-3843 (2005) 1714-1731.
- [218] J. Luo, Y. Zhang, Q. Zhang, J. Liu, J. Wang, Evaluation of sooting tendency of acetone–butanol–ethanol (ABE) fuels blended with diesel fuel, *Fuel* 209 (2017) 394-401.
- [219] T. Kadota, H. Yamasaki, Recent advances in the combustion of water fuel emulsion, *Prog. Energy Combust. Sci.* 28 (2002) 385-404.
- [220] W.B. Fu, L.Y. Hou, L. Wang, F.H. Ma, A unified model for the micro-explosion of emulsified droplets of oil and water, *Fuel Process. Technol.* 79 (2002) 107-119.
- [221] M.M. Maricq, Chemical characterization of particulate emissions from diesel engines: A review, *J. Aerosol Sci.* 38 (2007) 1079-1118.
- [222] S.-L. Lin, W.-J. Lee, C.-F. Lee, S.-J. Chen, Energy savings and emission reduction of nitrogen oxides, particulate matter, and polycyclic aromatic hydrocarbons by adding

water-containing acetone and neat soybean oil to a diesel-fueled engine generator, *Energy Fuels* 24 (2010) 4522-4533.

[223] Y.-C. Lin, W.-J. Lee, C.-C. Chen, C.-B. Chen, Saving energy and reducing emissions of both polycyclic aromatic hydrocarbons and particulate matter by adding bio-solution to emulsified diesel, *Environ. Sci. Technol.* 40 (2006) 5553-5559.

[224] N. Surawski, B. Miljevic, G. Ayoko, B. Roberts, S. Elbagir, K. Fairfull-Smith, S. Bottle, Z. Ristovski, Physicochemical characterization of particulate emissions from a compression ignition engine employing two injection technologies and three fuels, *Environ. Sci. Technol.* 45 (2011) 5498-5505.

[225] D. Qi, H. Chen, L. Geng, Y.Z. Bian, X.C. Ren, Performance and combustion characteristics of biodiesel–diesel–methanol blend fuelled engine, *Appl. Energ.* 87 (2010) 1679-1686.

[226] C. Cheung, R. Zhu, Z. Huang, Investigation on the gaseous and particulate emissions of a compression ignition engine fueled with diesel–dimethyl carbonate blends, *Sci. Total Environ.* 409 (2011) 523-529.

[227] K.H. Song, P. Nag, T.A. Litzinger, D.C. Haworth, Effects of oxygenated additives on aromatic species in fuel-rich, premixed ethane combustion: a modeling study, *Combust. Flame* 135 (2003) 341-349.

[228] H. Wu, T.H. Lee, C.-f. Lee, F. Liu, B. Sun, Optical soot measurement of bio-butanol upstream product, ABE (Acetone–Butanol–Ethanol), under diesel-like conditions, *Fuel* 181 (2016) 300-309.

[229] K.E. Nord, D. Haupt, Reducing the emission of particles from a diesel engine by adding an oxygenate to the fuel, *Environ. Sci. Technol.* 39 (2005) 6260-6265.

[230] F. Wu, J. Wang, W. Chen, S. Shuai, A study on emission performance of a diesel engine fueled with five typical methyl ester biodiesels, *Atmos. Environ.* 43 (2009) 1481-1485.

[231] C.S. McEnally, L.D. Pfefferle, Sooting tendencies of oxygenated hydrocarbons in laboratory-scale flames, *Environ. Sci. Technol.* 45 (2011) 2498-2503.

[232] E. Sukjit, J.M. Herreros, K.D. Dearn, R. García-Contreras, A. Tsolakis, The effect of the addition of individual methyl esters on the combustion and emissions of ethanol and butanol -diesel blends, *Energy* 42 (2012) 364-374.

[233] D.C. Rakopoulos, C.D. Rakopoulos, E.G. Giakoumis, R.G. Papagiannakis, D.C. Kyritsis, Experimental-stochastic investigation of the combustion cyclic variability in HSDI diesel engine using ethanol–diesel fuel blends, *Fuel* 87 (2008) 1478-1491.

[234] D.C. Rakopoulos, C.D. Rakopoulos, R.G. Papagiannakis, D.C. Kyritsis, Combustion heat release analysis of ethanol or n-butanol diesel fuel blends in heavy-duty DI diesel engine, *Fuel* 90 (2011) 1855-1867.

[235] J. Wu, K.H. Song, T. Litzinger, S.-Y. Lee, R. Santoro, M. Linevsky, M. Colket, D. Liscinsky, Reduction of PAH and soot in premixed ethylene–air flames by addition of ethanol, *Combust. Flame* 144 (2006) 675-687.

- [236] J. Sun, J.A. Caton, T.J. Jacobs, Oxides of nitrogen emissions from biodiesel-fuelled diesel engines, *Prog. Energy Combust. Sci.* 36 (2010) 677-695.
- [237] C. Kumar, M.G. Babu, L.M. Das, Experimental investigations on a karanja oil methyl ester fueled DI diesel engine, *SAE Tech. Pap.* 2006-01-0238 (2006).