



HAL
open science

Design and Characterization of Compact Antennas for Wireless Sensing Applications

Alassane Sidibe, Gael Loubet, Alexandru Takacs, Daniela Dragomirescu

► **To cite this version:**

Alassane Sidibe, Gael Loubet, Alexandru Takacs, Daniela Dragomirescu. Design and Characterization of Compact Antennas for Wireless Sensing Applications. 2020 International Workshop on Antenna Technology (iWAT), Feb 2020, Bucharest, Romania. pp.1-4, <10.1109/iWAT48004.2020.1570616078>. <hal-02919841>

HAL Id: hal-02919841

<https://hal.science/hal-02919841v1>

Submitted on 12 Dec 2024

HAL is a multi-disciplinary open access archive for the deposit and dissemination of scientific research documents, whether they are published or not. The documents may come from teaching and research institutions in France or abroad, or from public or private research centers.

L'archive ouverte pluridisciplinaire **HAL**, est destinée au dépôt et à la diffusion de documents scientifiques de niveau recherche, publiés ou non, émanant des établissements d'enseignement et de recherche français ou étrangers, des laboratoires publics ou privés.



Distributed under a Creative Commons CC BY 4.0 - Attribution - International License

Design and Characterisation of Compact Antennas for Wireless Sensing Applications

Alassane Sidibé
LAAS-CNRS
Université de Toulouse,
CNRS
Toulouse, France
asidibe@laas.fr

Gaël Loubet
LAAS-CNRS
Université de Toulouse,
CNRS
Toulouse, France
gael.loubet@laas.fr

Alexandru Takacs
LAAS-CNRS, UPS
Université de Toulouse,
CNRS
Toulouse, France
atakacs@laas.fr

Daniela Dragomirescu
LAAS-CNRS, INSA
Université de Toulouse,
CNRS
Toulouse, France
daniela@laas.fr

Abstract—This paper addresses the design and the characterization of compact antennas designed for wireless sensing applications. More precisely these antennas have to be integrated in the rectenna part of a battery-free and wirelessly powered wireless sensing node embedded in a concrete material. A 3D compact dipole antenna topology is presented, it exhibits at maximum gain of 1.7 dBi at 868 MHz. By integrating this antenna in a metallic cavity, the gain can be enhanced to 4.5 dBi minimizing also the negative impact and the detuning effect of the concrete material on the antenna performances.

Keywords—compact antenna, wireless sensing, wireless sensors network, wireless power transmission, energy harvesting

I. INTRODUCTION

Through the quick growth and the wide availability of Internet of Things (IoT) technologies, Cyber-Physical Systems (CPS) have been identified as potential solutions for Structural Health Monitoring (SHM) applications [1-2]. In some harsh environments [3-4], the Wireless Sensor Networks (WSN) nodes could become inaccessible once deployed. Thus, some hard constraints apply as the energy autonomy and the reliability for the whole life of the monitored structure. In agreement with these restrictions, a WSN mesh architecture composed of Sensing Nodes (SNs) and Communicating Nodes (CNs) is proposed and presented in Fig. 1 and in [3-4].

The sensing nodes are dedicated to the quantification of the physical world through the sensing of some relevant parameters or properties of the monitored structure. According to the specific targeted application, these nodes must wirelessly transfer the collected data to the communicating nodes over distances between several meters and kilometers. Because the SNs become inaccessible once deployed, they must operate reliably for decades without maintenance. Thus, they are designed to be simple, battery-free and wirelessly powered by a RF source driven by the CNs through a far-field Wireless Power Transmission (WPT) interface. The communicating nodes are dedicated to the recovery, the processing and the storage of the data generated and transmitted by the SNs. They interconnect the physical and digital worlds through an Internet interface (e.g. a 3G cellular network interface). In our case study, CNs are accessible and must not be energy autonomous for their entire lifespan. This paper addresses the design, the implementation and the characterization of a prototype of sensing node for SHM applications in harsh environments. The exposed prototype of sensing node is battery-free, wirelessly powered through a far-field WPT system, performs temperature and relative humidity measurements and communicates the measures thanks to the LoRaWAN protocol over kilometers. The periodicity of the measurement as well as of the unidirectional

communication can be controlled by a well-tuned use of the WPT system, therefore without the need of hardware or software changes. The wireless power transmission and the communication operate at the same ISM 868 MHz frequency band but with orthogonal polarizations (to discriminate the WPT and the wireless communication). Thus the SN meets the paradigm of simultaneous wireless information and power transfer.

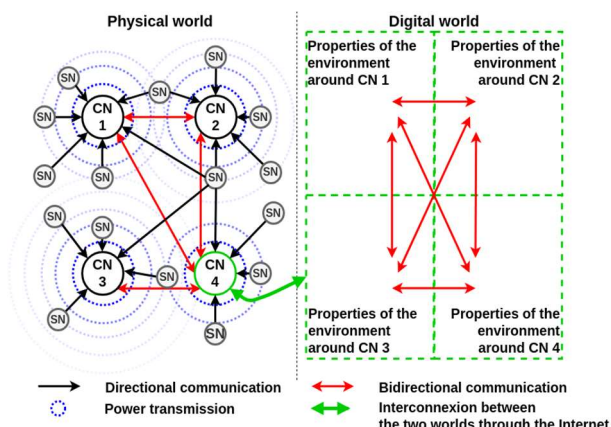

Fig. 1. Proposed architectures for the wireless sensor network

Section II highlights the topology of the sensing node and the main requirements for the design of the compact antennas of the rectenna incorporated in the sensing node. Several antenna topologies were recently designed by our research team and the obtained experimental results are presented in Section III.

II. SENSING NODE TOPOLOGY

The suggested topology for the sensing node is shown in Fig. 2 and introduced in [4]. The SNs embed a temperature and relative humidity sensor to quantify these two physical parameters of their environment. The measured data are then collected and processed by the MicroController Unit (MCU), before being transmitted to the communicating node(s) through a unidirectional wireless RF communication using LoRaWAN protocol. The SNs must be low power, reliable, maintenance-free and as simple as possible (e.g. no data are stored in them). Because they become inaccessible and must operate reliably for decades, the SNs are battery-free and wirelessly powered. A far-field WPT interface including a rectenna is used to recover the RF power generated by a dedicated RF power source controlled by a communicating node. The dc power provided by the rectenna is managed as energy (stored and delivered) by a Power Management Unit (PMU) embedding a dc-to-dc converter. By controlling the transmitted power to the SNs, the CNs -which control or even

generate the RF power density that illuminated the SNs- can manage the functioning periodicity of the SNs. Thus, the periodicity of the measurements and the transmission of collected data are modulated wirelessly by the WPT interface. Nowadays, the limitations in the capabilities of WPT systems are induced by the regulations and not the technology itself.

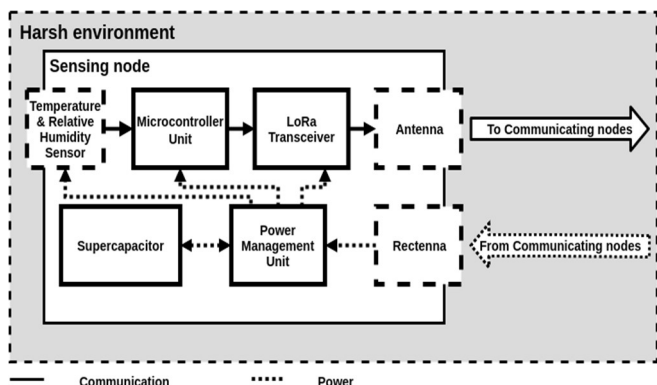

Fig. 2. Proposed architectures for the battery-free and wirelessly powered LoRaWAN sensing node

The rectenna used to harvest the specifically generated far-field RF power density is tuned to operate around the ISM 868/915 MHz bands. A rectenna was already developed for such applications. It is composed of a compact broadband flat dipole antenna CBFDA [5] enclosed by a rectangular ring, a single Schottky diode (Avago HSMS 2850) mounted in series configuration as rectifier. A photo of this rectenna is represented in Fig. 3. An aluminum reflector was placed at 5 cm behind the antenna/rectenna in order to increase the antenna gain and therefore the antenna efficiency. The maximum gain of the CBFDA with the reflector is +6.6 dBi at 868 MHz.

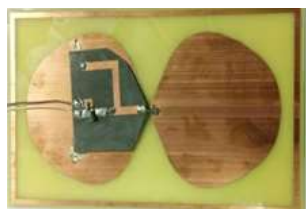

Fig. 3. Photo of the first CBFDA and rectenna integrated into the SN prototype

The surface of the CBFDA is about 11 x 6 cm² (approximately 0.06λ² at 868 MHz). This antenna is compact in term of wavelength but still remains quite large for the targeted application (e.g. a sensing node embedded in concrete).

III. COMPACT ANTENNA: TOPOLOGY, DESIGN AND EXPERIMENTAL RESULTS

The major drawback of the antenna represented in Fig. 3 is its size. In order to overcome this drawback several new compact antenna topologies are introduced in this paper, namely: DPLC1, DPLC2, DPLC3, DPLC5 and DPLC7. The photos of the manufactured antennas are represented in Fig. 4. DPLC1 is a planar antenna while all others are 3D antennas. The antennas were manufactured on a FR4 substrate (thickness: 0.8 mm). The size of 3D antennas is 56 mm (length) x 32 mm (width) x 10 mm (height). DPLC1 is composed by a planar short dipole with a planar capacitive arm. Two supplementary capacitive arms are vertically

connected to DPLC1 in order to form DPLC2 antenna. This vertical capacitive arm can be capacitively coupled (without any electric contact, that is the case of DPLC2 antenna) or electrically connected with the horizontal structure (that is the case of DPLC3, DPLC5 and DPLC7 antennas). As illustrated in Fig. 5, Fig. 6 and Fig. 7 the vertical arm allows us to downshift the resonant frequency of the antennas from 1.12 GHz (DPLC1) to approximately 868 MHz (DPLC5 and DPLC7). As expected the effect of the vertical arm is more important when an electrical contact is made. The position of the electrical short-circuit between the horizontal and vertical capacitive arms impact the resonant frequency of the antenna. The antennas are equipped with a standard 50 Ω UFL connectors [6].

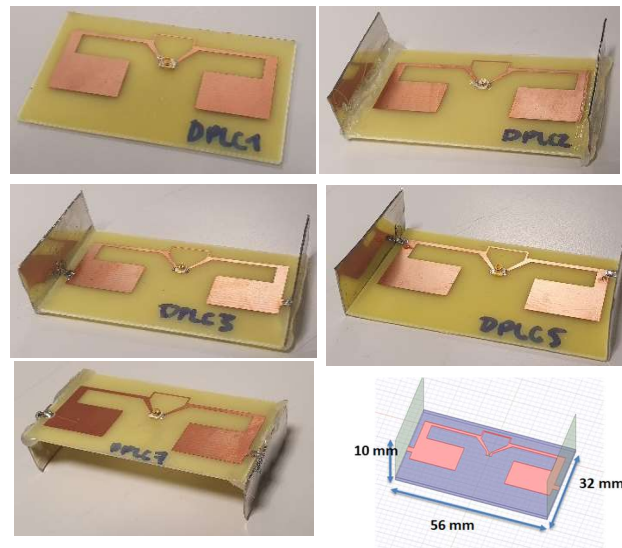

Fig. 4. Photo of several compact rectenna topology designed for the SN rectenna

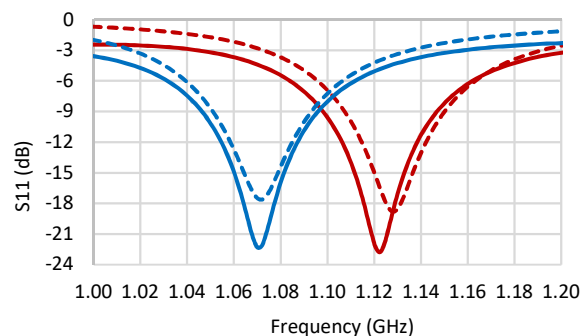

Fig. 5. Experimental (continuous line) and simulation (dashed line) results for DPLC1 (red line) and DPLC2 (blue line). The simulations were performed by using HFSS software

A very good correlation between simulation and experimental results was obtained for DPLC1 and DPLC2. All the simulation presented in this paper were performed by using HFSS software. The maximum frequency shift between simulation and measurement was observed for DPLC3 and DPLC5 (40 MHz, i.e. 4.75%), this frequency shift is mainly due to the manual assembling/connecting of the vertical arm. The radiation pattern of the manufactured antenna was measured in the anechoic chamber of LAAS-CNRS and the obtained radiation pattern (gain measured in the E-plane that is a vertical cut plane perpendicular to the antenna horizontal plane) obtained for the DPLC5 and DPLC7 antenna are represented in Fig. 8 and Fig. 9, respectively. The maximum

measured gain is 1.7 dBi for DPLC5 and 1.54 dBi for DPLC7 antenna. Thus, the DPLC5 antenna was selected to be embedded in the concrete for testing.

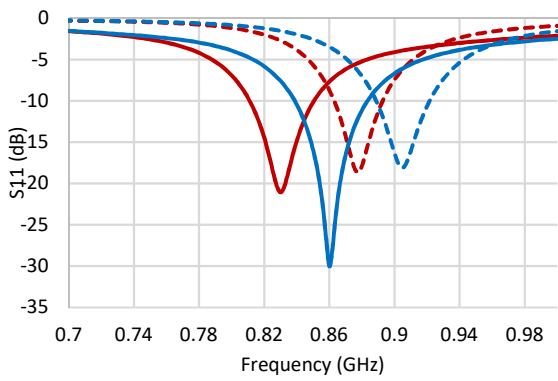

Fig. 6. Experimental (continuous line) and simulation (dashed line) results for DPLC3 (red line) and DPLC5 (blue line)

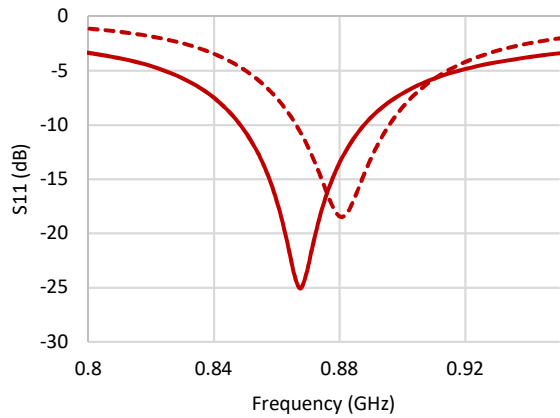

Fig. 7. Experimental (continuous line) and simulation (dashed line) results for DPLC7

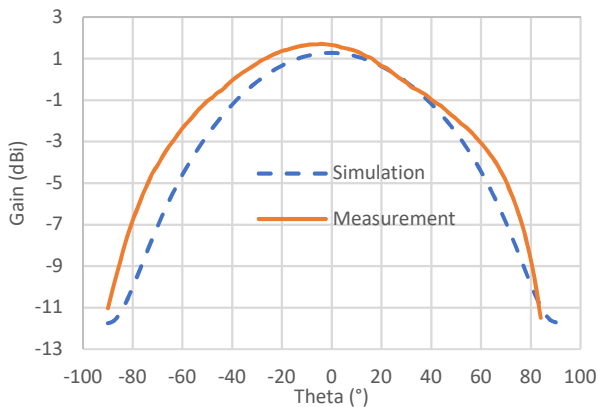

Fig. 8. Radiation pattern (gain in dB) at 868 MHz in the E-plane: experimental (continuous line) and simulation (dashed line) results for the DPLC5 antenna.

Concrete is a lossy material and it is mandatory to minimize its impact on antenna behavior/performances. In order to minimize the impact of the concrete on antenna performances the DPLC5 was introduced in a metallic cavity (100mm x 120mm x 130mm) as shown in Fig. 10 b). The size of the metallic cavity and the position of the DPLC5 antenna inside the cavity were tuned and optimized in order to increase the gain of the antenna and to avoid the antenna detuning.

Note also that the size of the cavity was also kept as minimum as possible for allowing a compact structure. The measured maximum gain of the DPLC5 antenna with its metallic cavity was 4.5dBi at 868MHz as shown in Fig. 11.

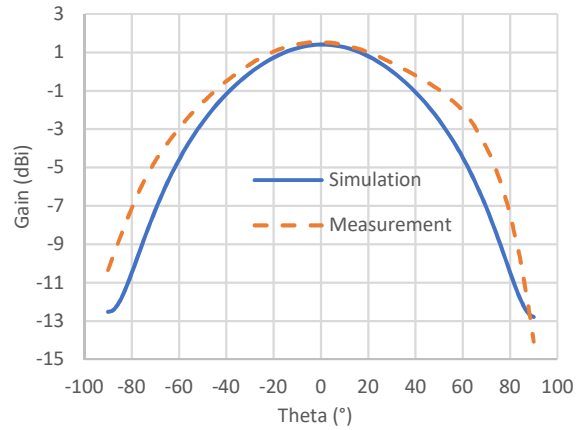

Fig. 9. Radiation pattern (gain in dB) at 868 MHz in the E-plane: experimental (continuous line) and simulation (dashed line) results for the DPLC7 antenna

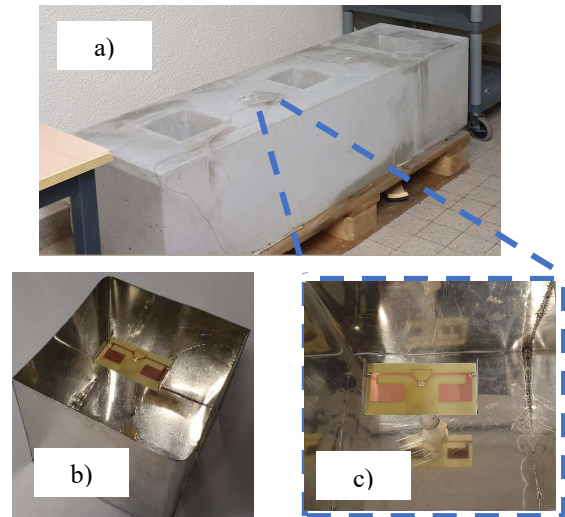

Fig. 10. a) Photo of the manufactured prototype of DPLC5 antenna embedded in a metallic cavity, b) photo of the manufactured concrete beam, c) photo of the DPLC5 antenna with its metallic cavity embedded in the concrete cavity for testing

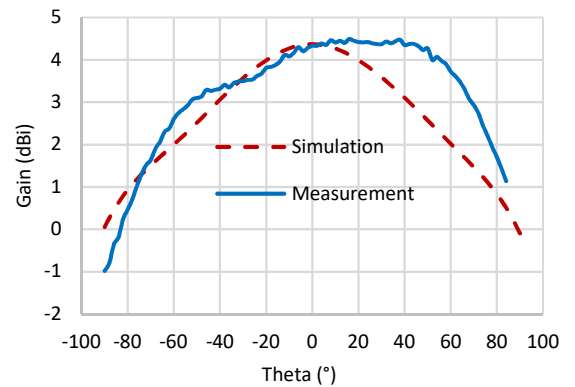

Fig. 11. Radiation pattern (gain in dB) at 868 MHz in the E-plane: experimental (continuous line) and simulation (dashed line) results for the DPLC5 antenna with its metallic cavity.

Experiments are under run in order to test the DPLC5 antenna (with its metallic cavity) embedded in a concrete

beam (represented in Fig. 10 a) available in our laboratory as shown in Fig. 10. It is very difficult to measure the radiation pattern of the antenna embedded in concrete. Consequently, a rectifier will be connected to our antenna to form a rectenna and to perform complete functional test with this rectenna embedded in concrete. Research are underrun and more results will be available at conference time.

IV. CONCLUSION

Compact antennas were developed in order to implement a wireless sensing node embedded in concrete. Especially a compact 3D antenna (volume: 56 mm x 32 mm x 10 mm that is approximately $0.00004\lambda^3$ at 868 MHz) named DPLC5 was mounted in a metallic cavity carefully dimensioned in order to minimize the impact of the concrete on the antenna performances. The maximum measured gain of the DPLC5 antenna with its metallic cavity is 4.5 dBi and this antenna will be integrated in the rectenna part of a battery-less sensing node embedded in concrete for wireless sensing applications.

ACKNOWLEDGMENT

We acknowledge all our partners in the McBIM project, especially FINAO SAS/360SmartConnect for providing the reinforced concrete beam.

REFERENCES

- [1] M.Z.A. Bhuiyan, J. Wu, G. Wang, J. Cao, W. Jiang, and M. Atiquzzaman, "Towards Cyber-Physical Systems Design for Structural Health Monitoring: Hurdles and Opportunities," *ACM Transactions on Cyber-Physical Systems*, vol.1, no.4, pp.1-19, 2017.
- [2] A.B. Noel, A. Abdaoui, T. Elfouly, M.H. Ahmed, A. Badawy, and M.S. Shehata, "Structural health monitoring using wireless sensor networks: A comprehensive survey," *IEEE Communications Surveys & Tutorials*, vol.19, no.3, pp.1403-1423, 2017.
- [3] G. Loubet, A. Takacs, and D. Dragomirescu, "Towards the Design of Wireless Communicating Reinforced Concrete," *IEEE Access Special Section on Wirelessly Powered Networks: Algorithms, Applications and Technologies*, vol.6, pp.1-13, 2018.
- [4] G. Loubet, A. Takacs, E. Gardner, A. De Luca, F. Udrea, and D. Dragomirescu, "LoRaWAN Battery-free Wireless Sensors Network designed for Structural Health Monitoring in the Construction Domain," *MDPI Sensors Special Section on Low Energy Wireless Sensor Networks*, vol.19, no.7, p.1510, 2019.
- [5] A. Okba, A. Takacs and H. Aubert, "Compact Rectennas for Ultra-Low-Power Wireless Transmission Applications," *IEEE Transactions on Microwave Theory and Techniques*, vol. 67, no. 5, pp. 1697-1707, May 2019
- [6] <https://www.hirose.com/product/series/U.FL?lang=en>