



HAL
open science

Identification of dominant noise sources in a diesel power group

Hasan Hassoun, Jaafar Hallal, Mohammad Hammoud, Denis Duhamel

► **To cite this version:**

Hasan Hassoun, Jaafar Hallal, Mohammad Hammoud, Denis Duhamel. Identification of dominant noise sources in a diesel power group. 23rd International Congress on Acoustics, Sep 2019, Aachen, Germany. hal-02915347

HAL Id: hal-02915347

<https://hal.science/hal-02915347>

Submitted on 14 Aug 2020

HAL is a multi-disciplinary open access archive for the deposit and dissemination of scientific research documents, whether they are published or not. The documents may come from teaching and research institutions in France or abroad, or from public or private research centers.

L'archive ouverte pluridisciplinaire **HAL**, est destinée au dépôt et à la diffusion de documents scientifiques de niveau recherche, publiés ou non, émanant des établissements d'enseignement et de recherche français ou étrangers, des laboratoires publics ou privés.

Identification of dominant noise sources in a diesel power group

Hasan HASSOUN^{1, 2*}; Jaafar HALLAL^{2, 3}; Mohammad HAMMOUD^{2, 4}; Denis DUHAMEL¹

¹ Laboratoire Navier—UMR 8205 (Ecole des Ponts Paris Tech — IFSTTAR— CNRS), Cité Descartes —
Champs-sur-Marne, Université Paris-Est, 77455 Marne-la-Vallée Cedex 2, France

² SDM Research Group, School of Engineering, International University of Beirut BIU, Beirut, Lebanon

³ Lebanese University, Faculty of Engineering, Beirut, Lebanon

⁴ School of Engineering, Lebanese International University LIU, Bekaa, Lebanon

ABSTRACT

This paper aims to investigate and determine the primary causes of noise in a diesel engine group using airborne acoustic measurements. The presented work is useful in defining and enhancing the equivalent sound level and sound pressure level (SPL) at a specific octave band. The work first describes the theoretical origins of sound and the benefits of the time-frequency domain for the analysis of airborne acoustic signals. Then, an experimental approach was established to identify the primary sources and the contribution of dominant sources in the total radiated noise upon examination of the measured data. Results showed that engine exhaust noise is the main contributor of noise, especially in the low and mid frequency ranges due to different harmonic exciter orders.

Keywords: Acoustics, Diesel engine group, Harmonic analysis.

1. INTRODUCTION

Diesel engine group consists of an internal combustion engine (ICE) coupled to an alternator to provide electric energy (Figure 1). It is one of the most significant energy users and noise polluters that influence personal comfort as a result of some annoying radiated noise. Although the human range of hearing frequencies is between 20 and 20,000 Hz, there is considerable variation between individuals especially at high frequencies. With the A-weighting function, the sound level is less sensitive to very low and very high frequencies. In this paper, the established measurements will be presented as dB(A) scale considering human hearing. Although sound and absorption materials are practically applied to reduce noise, these passive controls are beneficial at mid and high frequencies, but it is inefficient at low rates (1,2). Thus, reducing low-frequency noise presents a particular challenge as well as the difficulties in attenuating low-frequency noise. Previous researches emphasis on radiated noise from valves, piston slap, injectors and alternators in which their emitted sound concentrated at the mid and high-frequency ranges (3-7). The frequency ranges of the primary noise sources in diesel engine group depend not only on the structure properties (stiffness, mass, damping) but also on the operating speed (excitation frequencies). Analyzing of airborne acoustic signals using time-frequency domain and acoustic spectrum present proper tools for sound analysis because of its rich information contained within the acoustic waveform, although of the difficulties presented in the extraction of features. This difficulty is mainly due to the superposition of numerous frequency components introduced inside the acoustic spectrum. Several existing reviews on condition monitoring and fault diagnosis using vibro-acoustic signals of internal combustion engines were studied (8,9,10).

The applied methodology in the presented work consists first of specifying the dominant frequency range of diesel group noise by analyzing of airborne acoustic measurements. Then, the contribution of the primary noise sources is identified at each octave frequency band. By recovering the spikes in the specified band, the diesel group noise can be reduced effectively by reducing the sound pressure level at identified dominant peaks.

* Corresponding author: hasan.hassoun@enpc.fr

This paper is organized as follows: Section 2 describes the airborne acoustic modelling of diesel engine group. Section 3 presents the experimental approach to determine the main contributor to the overall noise followed by a discussion of the results. Finally, section 4 draws the conclusions.

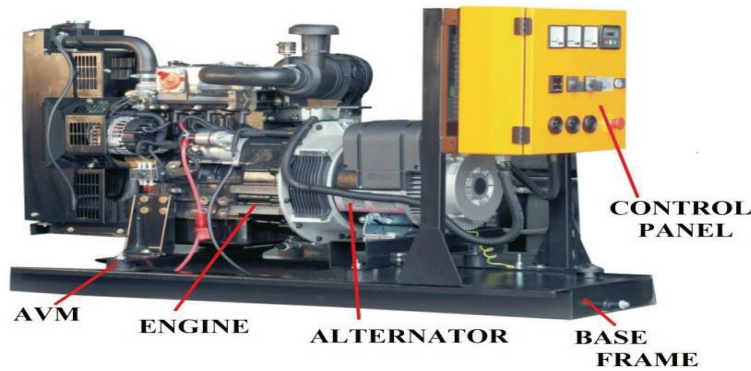

Figure 1 – Components of a diesel engine group (11)

2. AIRBORNE ACOUSTIC MODELING OF DIESEL ENGINE GROUP

The generation of noise in the diesel engine group can be described as mechanical, combustion, aerodynamic and electromagnetic noise due to various types of excitation forces. Emitted sound can be classified as structure-borne, airborne or a mix thereof. In airborne transmission, the acoustic wave directly transferred to the receiver through an air medium. While in structure-borne transmission, the acoustic source shifted through different parts before being transmitted to the receiver. The significant sources of noise and vibration are due to mechanical and combustion forces. These forces are mainly due to the variable gas pressure inside the cylinder, and to the inertial force from moving parts, such as connecting rod, piston, rotor and crankshaft which lead to unbalanced forces. These forces occur over a frequency range and are transmitted to the external surface leading to structural vibrations and noise radiation as a result of the excitation forces as shown in Table 1.

Table 1 – Vibration and Acoustic mechanism in a diesel engine group

| Excitation source | Force applied to structure | Vibration transmission | Noise emitter (Fig. 2) |
|-----------------------|---|--|------------------------------|
| Combustion excitation | Rapid rate of change in cylinder pressure (pulses) | Cylinder head, piston, connecting mechanisms | Manifolds covers, ICE block |
| Mechanical excitation | Mechanical impact, piston slap, bearings, fuel pump | Piston connections, cylinder walls, stator | ICE block sump, timing cover |
| Magnetic excitation | Magnetic force, Torque ripple | Stator yoke | Stator surface |

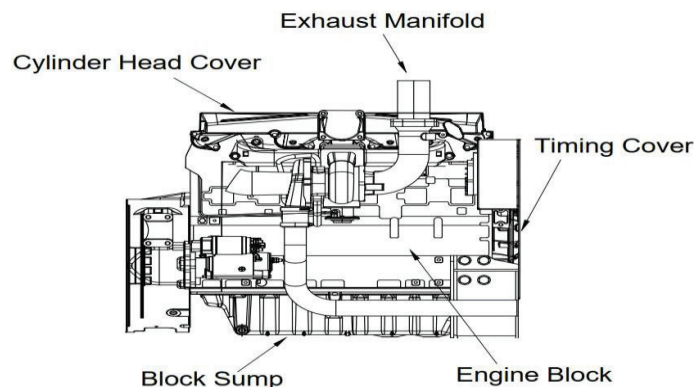

Figure 2 – Engine components

Combustion noise is due to the rapid rate of cylinder pressure variation which causes the vibration of the engine structure. Based on the cylinder pressure spectrum and the superposition principle, the cylinder pressure is the sum of the individual effects of the series of harmonics with different frequencies and amplitudes. Mechanical noise referred to as impact-induced noise results from rotating components and inertial forces. Piston slap is one of the significant mechanical noise resulting from the impact of the piston with cylinder walls as the piston move from Top Dead Center (TDC) to Bottom Dead Center (BDC). Fuel pump, bearing, valves, injector needle are other sources of mechanical noise. Electromagnetic noise is due to the magnetic excitation in the alternator part. Aerodynamic noise is produced from the intake, fan and exhaust system. When inlet and exhaust valves close, the sound is generated in which it can be identified using the time-frequency domain of the air-borne signals.

2.1 Harmonic Exciter Orders

The torque function ($M(\alpha)$) resulting from the excited tangential force (F_t) of the gas and inertia forces can be expanded into harmonic series in terms of the crank angle (α) as shown in Figure 3. As the combustion event occurs around TDC, the engine crankshaft is subjected to twist leading to a torsional vibration at harmonic frequencies. Controlling these harmonics is essential to minimize the load on bearings and other components, thus reducing induced noise. The frequencies (f) of the harmonics orders (i) vary linearly to the crankshaft-rotor speed (N) as shown in equation 1.

$$f(\text{Hz}) = i \frac{N(\text{rpm})}{60} \quad (1)$$

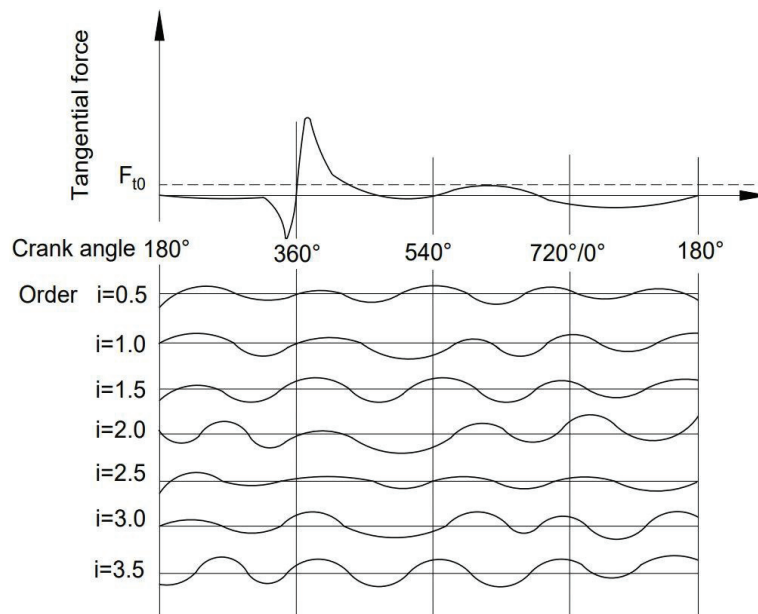

Figure 3 – Harmonic components of the tangential force (F_t) in four-stroke reciprocating piston engine

Due to the periodic properties of the torque function $M(\alpha)$, it can be represented as Fourier series:

$$M(\alpha) = M_k + 2 \sum_{n=1}^{\infty} A_n \cos\left(\frac{2\pi}{T} n \alpha\right) + 2 \sum_{n=1}^{\infty} B_n \sin\left(\frac{2\pi}{T} n \alpha\right) \quad (2)$$

Where M_k represents the mean torque, A_n and B_n are coefficients calculated as below:

$$A_n = \frac{1}{T} \int_0^T M(\alpha) \cos\left(\frac{2\pi}{T} n \alpha\right) d\alpha \quad (3)$$

$$B_n = \frac{1}{T} \int_0^T M(\alpha) \sin\left(\frac{2\pi}{T} n \alpha\right) d\alpha \quad (4)$$

For a 4-stroke engine, each of the four distinct piston strokes takes 180° , thus the overall engine cycle is $T=4\pi(720^\circ)$. Substituting this last value into equations 3 and 4, the components of cosine and

sine functions will be $n\alpha/2$, where $i=n/2$ is the n th order of the developed series representing the number of harmonic oscillations during a whole engine cycle. Thus, in a 4-stroke engine, half orders are present, for example, $n=1, 2, 3, 4$ leading to $i=0.5, 1, 1.5, 2$.

A 3-cylinders 4-stroke engine exhibits orders 1.5 (Number of cylinder/2), $3(2 \times 1.5)$, $4.5(3 \times 1.5)$...as major harmonic orders while 0.5, 2, 3.5... are considered as minor orders. The amplitude of vibration and hence induced noise of the crankshaft vary according to the harmonic order, these variables include the engine order, number of cylinders, crankshaft design and load. Figure 4 shows an example of the main and minor orders of a three-cylinder diesel engine group measured while varying the engine speed. The observed frequencies at each peak can be obtained by multiplying the harmonic order number with the fundamental frequency ($N(\text{rpm})/60$).

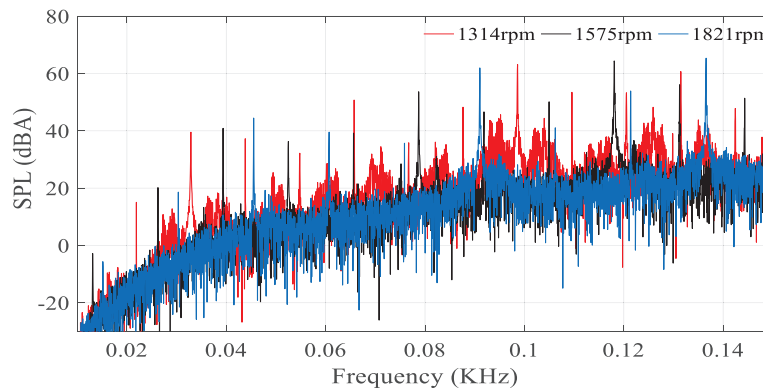

Figure 4 – Acoustic waveform of a 3-cylinder at different rotational speeds till 150 Hz

2.2 Airborne Acoustics Signal Processing

Fast Fourier transform (FFT) technique is practical and useful for analyzing periodical signals. This tool divides signal overtime into frequency components. That is, FFT of the function $x(t)$ is the function $x(f)$ where:

$$x(f) = \int_{-\infty}^{+\infty} x(t) \times e^{-i\omega t} dt \quad (5)$$

Although FFT is widely used, its limitations are in evaluating the time-dependent behavior of elements in frequency. Time-frequency domain such as spectrogram is well suited for non-stationary signals during the engine speed variation to show the time variation of the signal's characteristic frequencies. The spectrogram (SP) is established to show the visual representation of the spectrum of low frequencies inside the sound signal as time varies. This tool corresponds to computing the square of the Short-Time Fourier Transform ($STFT$) of the signal $x(t)$ for a window with w , where:

$$SP = |STFT(\tau, w)|^2 = \left| \int_{-\infty}^{+\infty} x(t) w(t-\tau) e^{-i\omega t} dt \right|^2 \quad (6)$$

3. EXPERIMENTAL MEASUREMENTS AND DISCUSSIONS

3.1 Experimental Measurements

The experiment was carried out using a three cylinder, four stroke diesel engine coupled to a four-pole alternator and installed on a test rig. Noise measurements were carried out using one STO-2 pressure transducer microphone. Firstly, the measured signal at 1m from the engine side operating at 1550 rpm steady state acquired for 25 seconds with a sampling frequency of 44100Hz. FFT was applied to the recorded noise signal to establish the acoustic spectrum (SPL-Frequency) using MatLab as shown in Figure 5. Secondly, the SPL at 1/1 octave frequency band was measured first at the exhaust manifold (Figure 2) followed for the structurally radiated noise to identify the contribution of each noise source as shown in Figure 6.

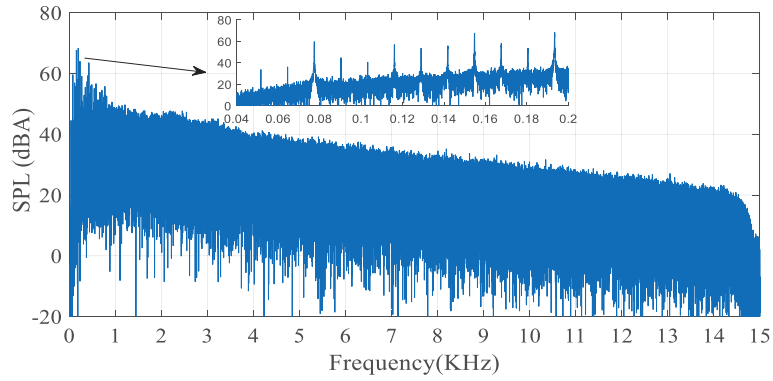

Figure 5 – Acoustic waveform at no electrical load and 1550 rpm for a 3-cylinder diesel group

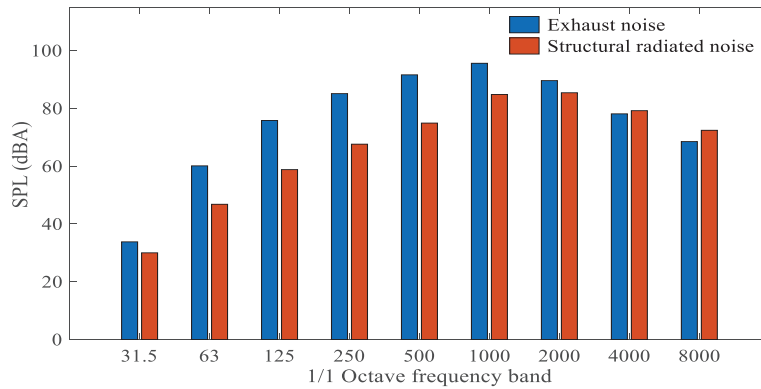

Figure 6 – SPL of dominant sources at 1/1 octave frequency bands

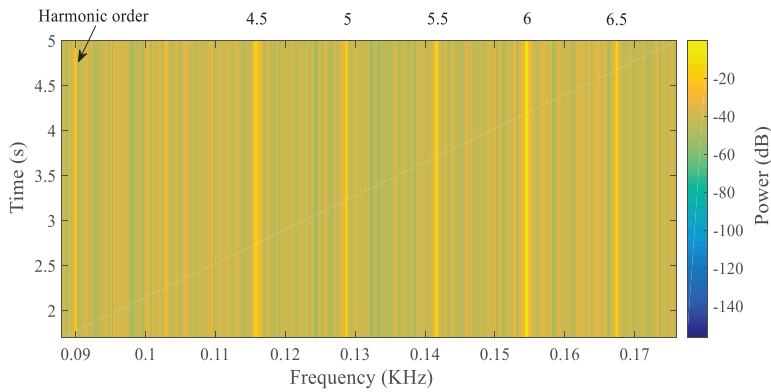

Figure 7 – Time-Frequency plot of exhaust noise at the 125 Hz octave band

3.2 Discussion

In the above acoustic spectrum of Figure 5, it is observed that the dominant heard noise occurs at low and mid frequency range mainly at the 1000Hz octave band, in which the SPL starts to decrease after this band. Thus, to improve the equivalent sound level, it is essential first to reduce the SPL at this octave band. In the low-frequency range of Figure 5 (up to 200 Hz), several peaks can be observed, called harmonic orders. The harmonic frequencies of these orders result from multiplying the harmonious order (i) with the fundamental frequency as established in section 2.1. This spectrum depends on the engine speed, i.e., if the crank speed increases, the rates of the spikes shift to the higher frequencies. Furthermore, the amplitude is highly dependent on the combustion condition and the location of the microphone. In this case, the running speed is 1550 rpm; thus, the first order frequency is 25.83Hz (1550 rpm/60). Moreover, it can be observed that SPL at main exciter orders such as firing frequency (order 1.5) and its harmonic (orders 3, 4.5, 6, 7.5, 9...) is higher than that of the minor orders (0.5, 1, 2, 2.5...).

Figure 6 shows the contribution of primary noise sources to the overall group SPL in terms of 1/1 octave frequency band. It's noticed that the exhaust noise contributes mainly at 1000Hz octave band. Thus, reducing the SPL from the exhaust noise at this octave band can significantly improve the equivalent sound level. Besides, exhaust noise is the main contributor of noise till 4000Hz octave band. After this band, structurally radiated noise, which is composed of radiated noise from different components (Engine block, cylinder head, oil pan, timing covers, stator wall) contributes mainly. At low-frequency range, to reduce the SPL at a specific band, e.g., 125Hz octave band, it is essential to improve the exhaust noise which adds primarily to this band. Figure 7 shows the dominant frequencies in the 125Hz octave band of the exhaust noise. Thus, reducing noise at these harmonic frequencies (orders 3.5, 4, 4.5, 5, 5.5, 6, 6.5) will significantly improve the exhaust noise and hence the equivalent sound level at this specific band. More features can be extracted from Figure 7 which, corresponds to the steady state of emitted noise at observed orders independent on time while measuring at a constant speed (1550 rpm).

4. CONCLUSION

In this paper, the identification of the source of noise in a 3-cylinder diesel engine group has been established. Experiments were conducted based on the analysis of airborne acoustic measurements to identify the main contributor to the overall SPL at different octave bands. The developed work is useful in defining and enhancing the equivalent sound level and SPL at a specific octave band. Experimentally, and at low-frequency range, it was shown that the engine contributes to the overall SPL more than the alternator in which the engine crankshaft is subjected to torsional vibration and induced noise at the investigated exciter harmonic orders. The dominant heard sound from the diesel engine group is mainly at 1000Hz octave band in which the SPL decreases after this band. This latter band is dominated by exhaust noise, thus reducing the SPL at this band will significantly improve the equivalent sound level of the diesel group. Moreover, exhaust noise is the main contributor to the overall sound level below 4000Hz octave band. Therefore, to effectively control group noise below 4000Hz octave band, exhaust noise has to be controlled well.

REFERENCES

1. Schiavi A, Prato A, Vallée J.C. Building components and materials for low frequency airborne and structure-borne sound insulation. In 24th International Congress of Sound and Vibration (ICSV), London 2017. p. 5362-5369.
2. Wise S, Geoff L. Active noise control as a solution to low frequency noise problems. *J Low Freq Noise V A.* 2010; 29(2): 129-37.
3. Albarbar A, Gu F, Ball A D, Starr, A. Acoustic monitoring of engine fuel injection based on adaptive filtering techniques. *Appl Acoust.* 2010; 71(12):1132-41.
4. Yao J, Xiang Y, Qian S, Wang S, Wu, S. Noise source identification of diesel engine based on variational mode decomposition and robust independent component analysis. *Appl Acoust.* 2017; 116:184-94.
5. Leclere Q, Pezerat C, Laulagnet B, Polac L. Application of multi-channel spectral analysis to identify the source of a noise amplitude modulation in a diesel engine operating at idle. *Appl Acoust.* 2005; 66(7):779-98.
6. Bi F, Li L, Zhang J, Ma T. Source identification of gasoline engine noise based on continuous wavelet transform and EEMD–RobustICA. *Appl Acoust.* 2015.100; 34-42.
7. Pan Y, Li Y, Huang M, Liao Y, Liang D. Noise source identification and transmission path optimization for noise reduction of an axial piston pump. *Appl Acoust.* 2018; 130:283-92.
8. Zheng G T, Leung A Y T. Internal combustion engine noise analysis with time-frequency distribution. *J Eng Gas Turb Power.* 2002; 124(3):645-649.
9. Albarbar A, Gu F, Ball A D. Diesel engine fuel injection monitoring using acoustic measurements and independent component analysis. *Measurement.* 2010; 43(10):1376-86.
10. Delvecchio S, Bonfiglio P, Pompoli F. Vibro-acoustic condition monitoring of Internal Combustion Engines: A critical review of existing techniques. *Mechanical Systems and Signal Processing.* 2018; 99:661-683.
11. Hassoun H. (2018). Analyzing and optimizing the vibration and acoustic behavior of a 30 KVA power generation set diesel group (Master dissertation). Retrieved from LIU Library Database.