



HAL
open science

Uniaxial compression test on ceramic green compact with bending consideration using digital image correlation

Caiuã Caldeira de Melo, Matheus Furlan, François Hild, Nicolas Schmitt,
Rodrigo B. Canto

► **To cite this version:**

Caiuã Caldeira de Melo, Matheus Furlan, François Hild, Nicolas Schmitt, Rodrigo B. Canto. Uniaxial compression test on ceramic green compact with bending consideration using digital image correlation. Powder Technology, 2020, 376, pp.136-148. 10.1016/j.powtec.2020.08.002 . hal-02910819

HAL Id: hal-02910819

<https://hal.science/hal-02910819>

Submitted on 3 Aug 2020

HAL is a multi-disciplinary open access archive for the deposit and dissemination of scientific research documents, whether they are published or not. The documents may come from teaching and research institutions in France or abroad, or from public or private research centers.

L'archive ouverte pluridisciplinaire **HAL**, est destinée au dépôt et à la diffusion de documents scientifiques de niveau recherche, publiés ou non, émanant des établissements d'enseignement et de recherche français ou étrangers, des laboratoires publics ou privés.

Uniaxial compression test on ceramic green compact with bending consideration using digital image correlation

Caiuã Caldeira de Melo¹, Matheus Furlan², François Hild³, Nicolas Schmitt³, Rodrigo Bresciani Canto^{1,2,*}

¹*Federal University of São Carlos (UFSCar), Graduate Program in Materials Science and Engineering (PPGCEM), 13565-905 São Carlos/SP, Brazil*

²*Federal University of São Carlos (UFSCar), Department of Materials Engineering (DEMa), 13565-905 São Carlos/SP, Brazil*

³*Université Paris-Saclay, ENS Paris-Saclay, CNRS, LMT – Laboratoire de Mécanique et Technologie 4 avenue des Sciences, 91190 Gif-sur-Yvette, France*

Abstract

A uniaxial compression test was performed on a green compacted alumina powder. Using Digital Image Correlation (DIC), displacement fields of two perpendicular surfaces of the specimen were measured showing unavoidable bending effect. A constitutive model was calibrated through three Finite Element Model Updating approaches. First, an analysis was performed using average axial strains assessed via DIC and resultant forces to identify the constitutive model. Then, a plane stress analysis was conducted out using the displacements of the boundaries of the regions of interest for each camera separately to obtain the sought parameters. Last, a 3D analysis was carried out using the multi-point constraint method to link displacement fields of both surfaces. Because of bending, the first two approaches give rise to two sets of different parameters. The analysis that considers the 3D nature of bending leads to the set of parameters with the highest degree of confidence.

Keywords: Uniaxial compression test, Bending, Green compact, DIC, FEMU.

*Corresponding author. Email: rbcanto@ufscar.br. Address: 13565-905, Rodovia Washington Luís, São Carlos/SP, Brazil

1. Introduction

Uniaxial compression is a well-known experimental procedure to characterize the mechanical properties of metals, polymers, and ceramics, by establishing the relationship between the uniaxial stress state prescribed by the loading condition and the induced triaxial strain state [1]. For an ideal uniaxial compression test, a uniform stress state is expected to arise within the specimen. However, some artifacts may jeopardize this usually assumed stress homogeneity [2, 3]. Features of the test such as the lack of parallelism of the platens and eccentric forces on the specimen usually result in non-uniform stress states. Further, geometrical imperfections of the sample geometry and inhomogeneity may lead to similar issues.

Ceramics are brittle materials, which makes it hard to ensure the desired geometry of the specimen by traditional shaping processes. The difficulty of designing some geometries of specimen and fixture parts to reach the desired stress states may lead to spurious data and erroneous identification of material parameters [4]. As reported in the ASTM C1424-10 standard: “actual studies of the effect of bending on the compressive strength distributions of advanced ceramics do not exist” [5]. This paper aims to propose a procedure that will automatically account for such imperfections.

The accuracy of the material models depends on the calibration quality from mechanical tests. Green compacts are commonly characterized by using mechanical tests such as uniaxial compression and Brazilian tests from which material parameters are identified [6–11]. The classical identification methods of mechanical parameters uses fitting approaches from stress-strain curves obtained in these mechanical tests. For compression tests, the stress distribution is commonly assumed as homogeneous and calculated as the ratio of measured force and cross-sectional area of the specimen. The strains are evaluated from the use of the cross-head displacement (when the machine compliance is negligible with respect to that of the tested sample), strain gauges, optical or mechanical (contacting) extensometers. For verification

26 purposes of the stress and strain state distributions in the specimen for uniaxial compression,
27 multiple strain gauges are installed on the lateral surfaces of the specimen or a verification
28 test specimen is utilized [1, 5]. The difference in measured axial strain values is evidence of
29 imperfect mechanical tests. As the fracture of ceramic materials may be catastrophic, it is
30 not recommended to use conventional contacting extensometers.

31 Full-field measurement methods enrich the identification and calibration of constitutive
32 models [12]. In the present study, FE-based digital image correlation (DIC) [13, 14] was
33 used. In the earlier implementations of DIC, local registrations of small interrogation win-
34 dows were performed [15, 16]. Global approaches were introduced later on [17, 18], often
35 based on finite element discretizations of the measured displacement fields [19–22]. Mea-
36 suring displacement fields may provide a better understanding of mechanical tests. One
37 way of better understanding tests is via numerical simulations. For instance, Finite Ele-
38 ment Model Updating (FEMU) is a widely applied identification method [23]. It consists in
39 minimizing the difference between measured and computed variables such as loads [24, 25],
40 displacements [25, 26], temperatures [27], by an iterative scheme for optimizing the model
41 parameters. The combination of FEMU and DIC techniques has achieved satisfactory re-
42 sults in the calibration of constitutive models [28–34]. Via DIC analyses, Montilha et al. [11]
43 determined the elastic parameters in an alumina green compact and observed dilatancy for
44 the tested material in uniaxial compression. Another route usually consists in utilizing more
45 complex triaxial testing cells to assess dilatancy [35].

46 In this paper, an analysis of a uniaxial compression test on a compacted alumina spec-
47 imen (Section 2) was performed using DIC. Images were captured for two perpendicular
48 surfaces of a cuboid specimen. The degrees of freedom related to the vertical displacement
49 of the common edge in both faces will be coupled by a multi-point constraint approach [36]
50 (Section 3). To the best of the authors’ knowledge, such technique was not reported in the

51 literature for DIC analyses. Despite the non-homogeneous strain field obtained in the stud-
 52 ied uniaxial compression test, it is possible to calibrate some parameters of an elastoplastic,
 53 nonlinear hardening Drucker-Prager model [37, 38] by using three different FEMU-F ana-
 54 lyzes (Section 4). Section 5 describes the experimental and numerical results and shows that
 55 using two of the developed approaches, bending effects may be quantified and accounted for
 56 in the calibration of the parameters of an elastoplastic model.

57 2. Material, experimental procedure and modeling

58 An atomized alumina (Al_2O_3) powder [11, 39] was used to make the cuboid specimen.
 59 This manufacturing process was divided into three steps, namely, (i) isostatic pressing of
 60 the alumina powder at a minimum pressure to handle the sample, (ii) manual sanding, and
 61 (iii) final isostatic pressing. In the first step, the specimen was preformed in an isostatic
 62 AIP CP360 press. The chosen pressure for this step was 10 MPa, which was enough to
 63 press green compacts that are not too brittle to handle, and prevent major distortions in
 64 the geometry of the specimen. In the second step, the remaining geometric distortions were
 65 corrected by sanding the specimen. Last, the specimen was recompactd at 100 MPa The
 66 specimen was not sintered (green compact). Table 1 summarizes the final geometry of the
 67 studied specimen and some characteristics.

Table 1 Basic characteristics/properties of the specimen

Material	Dimensions [mm]			Mass Density [g/cm ³]		Average grain size [μm]
	Thickness	Width	Height	Apparent	Fully-dense	
Compacted alumina powder	20.3	20.3	50.8	2.35	3.74*	75**

* obtained with a helium pycnometer [11]

** before pressing [11]

68 Figure 1(a) shows the tested specimen between the platens of the testing machine. A

69 random speckle pattern was sprayed onto the observed surfaces to increase the number of
70 gray levels and contrast in the image, and make DIC measurements possible.

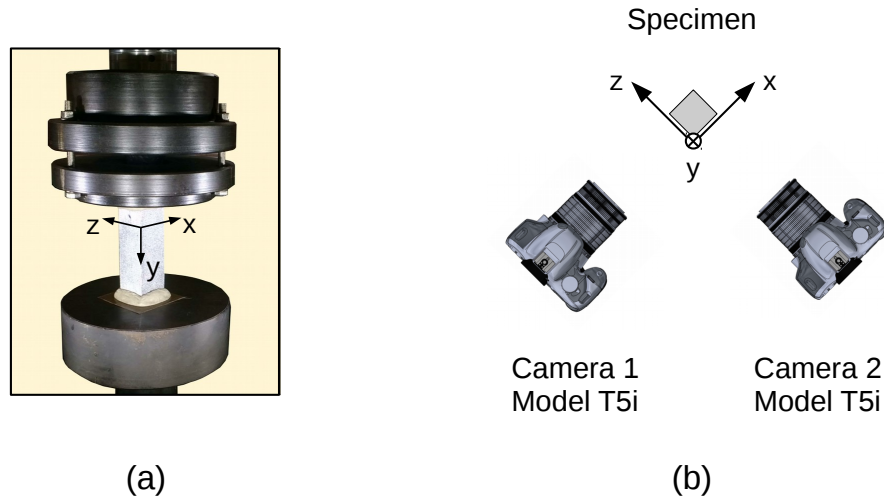

Figure 1 Experimental setup. (a) Specimen ($20.3 \times 20.3 \times 50.8 \text{ mm}^3$) between the testing machine platens, and (b) upper schematic view of the camera disposition to image two adjacent lateral surfaces

71 The images were simultaneously acquired with two cameras monitoring two adjacent
72 lateral surfaces (Fig. 1(b)). The hardware parameters of the optical setup are gathered in
73 Table 2.

Table 2 DIC hardware parameters

Cameras	CANON T5 Rebel
Definition (raw)	3456×5184 pixels (Bayer pixels)
Color filter	Bayer
Gray Levels amplitude	8 bits
Lens	CANON 100-mm macro
Aperture	$f/5.6$
Field of view	$40 \times 60 \text{ mm}^2$
Image scale	11.6 10.9 $\mu\text{m}/\text{pixel}$ (camera 1 2)
Stand-off distance	27 cm 25 cm (camera 1 2)
Image acquisition rate	0.05 – 0.17 fps
Exposure time	1/60 s
Patterning technique	sprayed black paint
Pattern feature size [#]	4 pixels (B/W)

[#]evaluated as full width at half maximum of autocorrelation function

74 The test was performed in a series of loading-unloading cycles on a servohydraulic MTS
75 Bionix testing system equipped with a 15 kN capacity load cell. To reduce the problems
76 related to the lack of parallelism between the loaded surfaces, an epoxy resin was applied
77 on the upper and lower parts of the specimen (Fig. 1). The testing procedure, shown in
78 Fig. 2, consisted of four loading-unloading cycles, followed by a final loading until the force
79 started to decrease. A cross-head speed of 0.1 mm/min was selected, and a preload of 30 N
80 was applied. The number of acquired pictures was equal to 88 for both perpendicular faces
81 (Fig. 1).

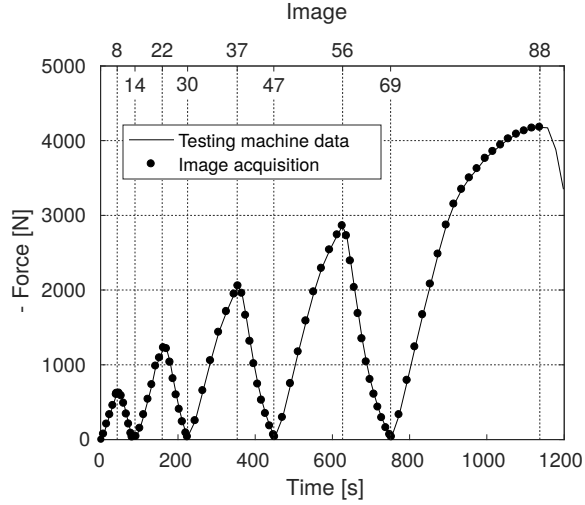

Figure 2 Force history showing the image acquisition instants (depicted with solid circles)

82 The original elastoplastic Drucker-Prager model with nonlinear hardening was chosen
 83 to represent the mechanical behavior of green compacted alumina since this powder (*i.e.*,
 84 unsintered ceramic) has a ductile behavior when considered as a continuous medium [11].
 85 Elasticity was considered as isotropic and linear, characterized by Young's modulus and
 86 Poisson's ratio. This model considers a pressure-dependent yield surface, with a linear form
 87 when expressed in terms of pressure p and von Mises stress q . The equation of the yield
 88 locus is expressed with two parameters, namely, the angle of friction β and an intercept (*i.e.*,
 89 the so-called material cohesion d).

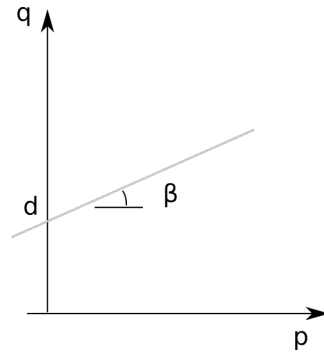

Figure 3 Original Drucker-Prager yield surface represented in a pressure p vs. von Mises stress q plane

90 The hardening response was modeled with Voce’s law [40]

$$\sigma_{ax} = \sigma_{\infty} - (\sigma_{\infty} - \sigma_y) \exp(-b \epsilon_{ax}^p) \quad (1)$$

91 where σ_{ax} is the axial stress, σ_{∞} the compressive strength, σ_y the yield stress, b a hardening
 92 coefficient, and ϵ_{ax}^p the axial plastic strain. One may note that the parameters d and σ_y are
 93 linearly dependent. For the analysis in this work, the identification (described in Section 4)
 94 was not sensitive to the Poisson’s ratio ν and the friction angle β . Both values were taken
 95 from the literature [11, 39], respectively as $\nu = 0.13$ and $\beta = 55^\circ$.

96 3. Digital Image Correlation and multi-point constraint

97 Global digital image correlation aims to find the displacement field \mathbf{u} that minimizes
 98 globally the difference of the gray levels between a reference image f and a deformed image
 99 g corrected by the measured displacement. The corresponding (gray level) conservation law
 100 is written with the following cost function

$$\eta^2 = \sum_i^{N_i} [f(\mathbf{x}_i) - g(\mathbf{x}_i + \mathbf{u}_i)]^2 \quad (2)$$

101 where N_i is the number of pixels in the region of interest (ROI). To ensure a good conditioning
 102 of the minimization, the displacement of the i -th pixel \mathbf{u}_i is represented by a set of degrees
 103 of freedom via finite element (FE) shape functions

$$\mathbf{u}_i = \mathbf{u}(\mathbf{x}_i) = \sum_j^{N_j} \phi_j(\mathbf{x}_i) a_j \quad (3)$$

104 where a_j are the (unknown) nodal displacements, and $\phi_j(\mathbf{x}_i)$ the finite element shape func-
 105 tion [41]. In the present case, linear triangular elements were selected so that the corre-

106 sponding shape functions were linear with respect to the spatial coordinates.

107 To solve the minimization problem, an iterative scheme is proposed where the degrees of
 108 freedom $\{\mathbf{a}\}$ are decomposed as a current guess $\{\mathbf{a}\}^{(n)}$, and incremental updates $\{\delta\mathbf{a}\}$

$$\{\mathbf{a}\}^{(n+1)} = \{\mathbf{a}\}^{(n)} + \{\delta\mathbf{a}\} \quad (4)$$

109 Linearizing the summand of the DIC cost function given in Eq. (2), the solution is found by
 110 solving the following linear system [13, 16, 42]

$$[\mathbf{M}]\{\delta\mathbf{a}\} = \{\mathbf{b}\} \quad (5)$$

111 where

$$M_{jk} = \sum_{i=1}^{N_i} (\nabla f(\mathbf{x}_i) \cdot \phi_j(\mathbf{x}_i)) (\phi_k(\mathbf{x}_i) \cdot \nabla f(\mathbf{x}_i)) \quad (6)$$

112 and

$$b_j = \sum_{i=1}^{N_i} (\nabla f(\mathbf{x}_i) \cdot \phi_j(\mathbf{x}_i)) (f(\mathbf{x}_i) - \tilde{g}(\mathbf{x}_i)) \quad (7)$$

113 where $\tilde{g}(\mathbf{x}_i) = g(\mathbf{x} + \mathbf{u}^{(n)}(\mathbf{x}))$.

114 Constraint conditions, commonly applied in the FE method [43], are used to introduce
 115 additional relationships among degrees of freedom or couple separate regions together. To
 116 couple the common regions observed by both cameras, the multi-point constraint (MPC)
 117 with the linear transformation method [36] was used herein. Alternative constraint proce-
 118 dures such as Lagrange multipliers and penalty methods could also be used. The Lagrange
 119 multiplier approach increases the number of equations of the linear system, while the se-
 120 lected method requires less effort than the others to assemble the global equations. On the
 121 other hand, the penalty method conserves the number of system variables but may lead to
 122 an ill-conditioned set of equations [44].

123 From Eq. (5), the following linear system is written to determine the degrees of freedom
 124 from the separate image acquisitions independently

$$\begin{bmatrix} [\mathbf{M}^{c1}] & \mathbf{0} \\ \mathbf{0} & [\mathbf{M}^{c2}] \end{bmatrix} \begin{Bmatrix} \{\delta \mathbf{a}^{c1}\} \\ \{\delta \mathbf{a}^{c2}\} \end{Bmatrix} = \begin{Bmatrix} \{\mathbf{b}^{c1}\} \\ \{\mathbf{b}^{c2}\} \end{Bmatrix} \quad (8)$$

125 where $c1$ and $c2$ designate the two cameras. It is worth noting that the units of the nodal dis-
 126 placements $\{\mathbf{a}^{c1}\}$ and $\{\mathbf{a}^{c2}\}$ are pixels, which can have different physical dimensions for each
 127 camera, depending on the lens and the magnification. To have a better global perspective
 128 of the system variables, the pixel quantities are converted into usual units of length

$$\{\delta \bar{\mathbf{a}}^c\} = \{\delta \mathbf{a}^c\} \pi^c \quad \text{and} \quad \{\bar{\mathbf{b}}^c\} = \{\mathbf{b}^c\} \pi^c \quad (9)$$

129 where π^c is the physical size of one pixel for a photographed face by camera c . Converting
 130 the displacements and also the right-hand terms $\{\mathbf{b}^c\}$, the linear system (8) is rewritten as

$$\begin{bmatrix} [\mathbf{M}^{c1}] & [\mathbf{0}] \\ [\mathbf{0}] & [\mathbf{M}^{c2}] \end{bmatrix} \begin{Bmatrix} \{\delta \bar{\mathbf{a}}^{c1}\} \\ \{\delta \bar{\mathbf{a}}^{c2}\} \end{Bmatrix} = \begin{Bmatrix} \{\bar{\mathbf{b}}^{c1}\} \\ \{\bar{\mathbf{b}}^{c2}\} \end{Bmatrix} \quad (10)$$

131 If there are two regions that can be coupled using the MPC method, a relationship between
 132 various degrees of freedom may be expressed as $\bar{a}_i^{c1} = \bar{a}_j^{c2}$. One can write a linear transfor-
 133 mation $[\mathbf{T}]$ linking all degrees of freedom ($\{\bar{\mathbf{a}}^{c1}\}$ and $\{\bar{\mathbf{a}}^{c2}\}$) to a unique vector with effective
 134 degrees of freedom $\{\bar{\mathbf{a}}^g\}$

$$\begin{Bmatrix} \{\delta \bar{\mathbf{a}}^{c1}\} \\ \{\delta \bar{\mathbf{a}}^{c2}\} \end{Bmatrix} = [\mathbf{T}] \{\delta \bar{\mathbf{a}}^g\} \quad (11)$$

135 The linear system concerning all effective degrees of freedom reads

$$[\mathbf{M}^g] \{\delta \bar{\mathbf{a}}^g\} = \{\bar{\mathbf{b}}^g\} \quad (12)$$

136 with

$$[\mathbf{M}^g] = [\mathbf{T}]^\top \begin{bmatrix} [\mathbf{M}^{c1}] & \mathbf{0} \\ \mathbf{0} & [\mathbf{M}^{c2}] \end{bmatrix} [\mathbf{T}] \quad \text{and} \quad \{\bar{\mathbf{b}}^g\} = [\mathbf{T}]^\top \left\{ \begin{array}{l} \{\bar{\mathbf{b}}^{c1}\} \\ \{\bar{\mathbf{b}}^{c2}\} \end{array} \right\} \quad (13)$$

137 Vertical misplacement of the mesh boundaries on the two perpendicular analyzed faces of
 138 the specimen may lead to artifacts after coupling the displacements of nodes belonging to the
 139 common edge, thereby resulting in inaccurate displacement fields (see Fig. 8). To solve this
 140 problem, the optimization of the position of the mesh boundaries was conducted. The cost
 141 function given in Eq.(14) is based on the minimization of the global mismatch strain of the
 142 elements that contain a constrained node, as a shift in the position of the mesh boundaries
 143 causes spurious shear strains in these elements

$$e_s = \sum_j^{N_{im}} \sum_i^{N_e} \frac{[\epsilon_{12}^{(i,j)}]^2}{\gamma_s^2} \quad (14)$$

144 where ϵ_{12} denotes the (nodal) shear strain, γ_s the shear strain uncertainty estimated from
 145 ten images acquired before the test when the specimen was pre-loaded, N_{im} the number of
 146 images, and N_e the number of elements that contain constrained nodes.

147 4. Identification framework

148 In this study, Finite Element Model Updating (FEMU) is chosen as an identification
 149 method. FEMU is an approach to calibrate material parameters involved in mechanical
 150 tests by the development of an FE model of the mechanical test, and its comparison with ex-
 151 perimental data [28, 31, 45]. The algorithm uses the results of DIC in FE models to minimize

152 the distance between measured and predicted quantities. It is chosen to use the experimental
 153 geometry and the measured displacement fields as prescribed Dirichlet boundary conditions
 154 on the edges of the FE model. The cost function for the so-called FEMU-F route is based
 155 on the differences between measured and computed reaction forces

$$\chi_F^2(\{\mathbf{p}\}) = \frac{1}{\gamma_F^2 n_t} \sum_t (F_m(t) - F_c(t, \{\mathbf{p}\}))^2 \quad (15)$$

156 where γ_F is the load uncertainty (on F_m), n_t the number of time increments, and F_c the
 157 computed reaction forces, which depend on material parameters gathered in the column vec-
 158 tor $\{\mathbf{p}\}$. The identification methodology consists in a nonlinear least-squares minimization
 159 of this cost function.

160 Considering the current set of parameters $\{\mathbf{p}_n\}$ at iteration n , the minimization is per-
 161 formed by calculating the correction $\{\delta\mathbf{p}\}$ from the linearized computed forces F_c

$$F_c(t, \{\mathbf{p}_n\} + \{\delta\mathbf{p}\}) \approx F_c(t, \{\mathbf{p}_n\}) + \frac{\partial F_c}{\partial \{\mathbf{p}\}}(t, \{\mathbf{p}_n\}) \{\delta\mathbf{p}\} \quad (16)$$

162 about the current estimate $\{\mathbf{p}_n\}$ of the sought parameters. The cost function then becomes

$$\chi_F^2(\{\delta\mathbf{p}\}) = \frac{1}{\gamma_F^2 n_t} \sum_t \left(F_m(t) - F_c(t, \{\mathbf{p}_n\}) - \frac{\partial F_c}{\partial \{\mathbf{p}\}}(t, \{\mathbf{p}_n\}) \{\delta\mathbf{p}\} \right)^2 \quad (17)$$

163 and its minimization with respect to $\{\delta\mathbf{p}\}$ leads to a linear system

$$[\mathbf{H}]\{\delta\mathbf{p}\} = \{\mathbf{h}\} \quad (18)$$

164 where $[\mathbf{H}]$ is the Hessian

$$[\mathbf{H}] = \sum_t \left(\frac{\partial F_c}{\partial \{\mathbf{p}\}}(t, \{\mathbf{p}_n\}) \right)^\top \frac{\partial F_c}{\partial \{\mathbf{p}\}}(t, \{\mathbf{p}_n\}) \quad (19)$$

165 $\{\mathbf{h}\}$ the right-hand member

$$\{\mathbf{h}\} = \sum_t \left(\frac{\partial F_c}{\partial \{\mathbf{p}\}}(t, \{\mathbf{p}_n\}) \right)^\top (F_m(t) - F_c(t, \{\mathbf{p}_n\})) \quad (20)$$

166 and $\frac{\partial F_c}{\partial \{\mathbf{p}\}}(t, \{\mathbf{p}_n\})$ the so-called sensitivity vector [46].

167 Three different FEMU-F approaches were used in this study (Table 3) using Abaqus [38]

168 FE code and Correli 3.0 framework [47] for DIC analyses.

Table 3 Summary of the three different FEMU-F approaches

Type of analysis	Coupled	Mesh boundary correction	Input for identification	FE model
Classical (plane stress)	×	✓	Average strain (DIC gauge)	1 four-noded element (CPS4)
2D Plane Stress	×	✓	Prescribed DIC displacements on boundaries	170 three-noded elements (CPS3)
3D Coupled	✓	✓	Prescribed DIC displacement on boundaries + extrapolations	490 eight-noded brick elements (C3D8)

169 First, a “classical” analysis was conducted using a virtual DIC strain gauge (*i.e.*, averaging
170 the axial strain results over the DIC mesh). An FE model with one element was used to
171 fit the constitutive law with the experimental stress-strain curve. Prescribed displacements
172 were applied, as depicted in Fig. 4, to reach the same average strains as measured by DIC.
173 Assuming uniform stress states, the resultant force was calculated and compared to the
174 experimental load. With this approach, a FEMU-F scheme can be used to calibrate the
175 material parameters.

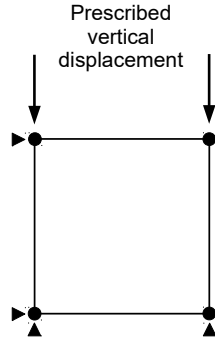

Figure 4 One-element model to calibrate material parameters via FEMU-F using uniform stress assumption

176 Moreover, a plane stress and a three-dimensional analysis were run to compare the
 177 FEMU-F results using the data from each face independently, and using data from both
 178 (coupled) faces in a 3D modeling, respectively. For the 2D Plane Stress analysis, the DIC
 179 meshes (with three-noded triangular elements) were used in the FE analyses. The vertical
 180 displacements obtained for each node in the upper and lower boundaries of the mesh (yellow
 181 circles in Fig. 5(a-b)) were prescribed as Dirichlet boundary conditions.

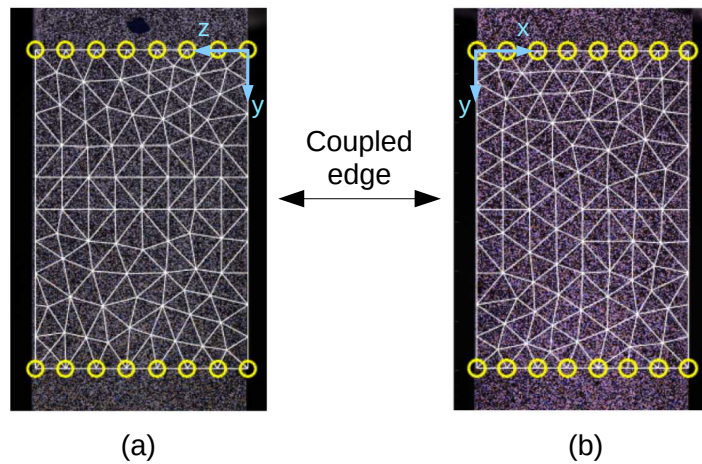

Figure 5 Reference images with mesh and boundary conditions applied in the 2D Plane Stress analysis of faces $y - z$ (a) and $x - y$ (b). The ROI dimensions where the mesh is defined are ≈ 30 mm in height and ≈ 20.3 mm in width

182 In the 3D Coupled analysis, a hexahedron-element mesh was adopted. The vertical dis-

183 placements were applied all over the cross-section of the upper and lower boundaries of
 184 the ROIs. For this purpose, the displacement fields obtained from DIC runs with MPC
 185 (Section 3) were used to fit, for the sake of simplicity, a plane. These results were then
 186 extrapolated for the vertical displacements inside the considered cross-sections of the spec-
 187 imen. Figure 6 shows these extrapolations for the first four force peaks (Fig. 2), following
 188 the coordinate system defined in Fig. 1 (*i.e.*, the vertical axis y is positive downward). The
 189 coefficients of the fitted planes were used as non-uniform distributions of displacement in the
 190 FE model. This approach allows the bending effect in the specimen to be represented as a
 191 measured displacements may induce nonuniform strain distributions.

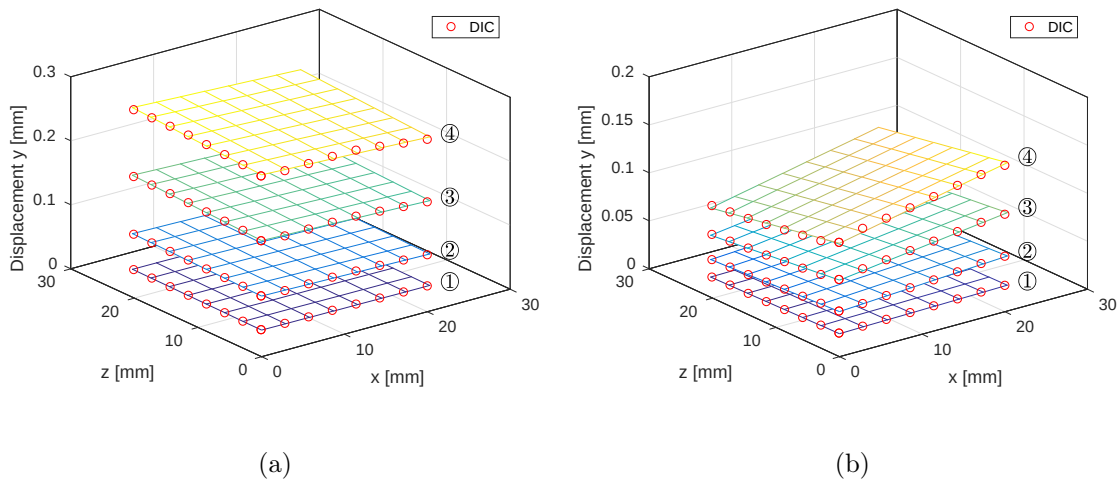

Figure 6 Extrapolated boundary conditions for the first four force peaks of (① to ④): (a) top and (b) bottom surfaces of the 3D model. The red circles depict measured quantities by DIC

192 5. Results

193 Section 5.1 shows the results of the DIC analysis and compares the use or not of the
 194 multi-point constraint (MPC) technique. A FEMU-F analysis using DIC data as virtual
 195 strain gauges (Classical) is shown in Section 5.2. Then, 2D Plane Stress FEMU-F analyses
 196 conducted for both faces independently are compared with the previous one in terms of

197 calibrated parameters (Section 5.3). Last, the 3D Coupled FEMU-F analysis using DIC and
198 MPC techniques is discussed in the Section 5.4.

199 *5.1. Digital image correlation and multi-point constraint*

200 The images were processed using the Correli 3.0 framework [47] in which the additional
201 steps described above were added. Table 4 shows the DIC analysis parameters. Displacement
202 and strain noise-floor levels were calculated by the average of temporal standard deviation
203 of all nodes and elements, respectively, when ten images were analyzed. They were acquired
204 once the sample was mounted and the servohydraulic system was active. Strictly speaking,
205 such uncertainties are no longer noise-floor estimates since they include the fluctuations
206 associated with the hydraulic system. This observation is confirmed by studying the ratio
207 between displacement and strain uncertainties (*i.e.*, about 1230). It is expected that the ratio
208 of the noise-floor estimates would be equal to the element length (*i.e.*, 128 on average) [48].
209 This ten time increase of the displacement fluctuations was already observed when dealing
210 with servohydraulic testing machines [49]. Interestingly, such displacement fluctuations,
211 which are rigid body motions, have a very small impact on the strain fluctuations.

Table 4 DIC analysis parameters

DIC software	Correli 3.0 [47]
Image filtering	RGB2gray
Element length	124 133 pixels (camera 1 2)
Shape functions	linear (T3)
Mesh	unstructured (see Fig. 5)
Matching criterion	sum of squared differences (Eq. (2))
Interpolant	cubic
Displacement uncertainty	0.16 pixel
Strain calculation	derivative of shape functions
Strain uncertainty	1.3×10^{-4}

212 The displacement fields for both surfaces of the specimen under a compressive axial force
 213 of 620 N (first peak force ①, see Fig. 2 at time ≈ 50 s, image 8) are shown in Fig. 7. The
 214 physical size of one pixel was $42.7 \mu\text{m}$ for face $y - z$ and $45.9 \mu\text{m}$ for face $x - y$. DIC is a
 215 full-field technique that also allows checking the “quality” of the test (*i.e.*, how close it is to
 216 *a priori* assumed boundary conditions). In uniaxial compression, for example, the vertical
 217 displacement contours should be horizontal to comply with the hypotheses that the strain
 218 and stress fields should be homogeneous before cracks initiate. Figure 7 shows that the
 219 vertical displacement fields are not satisfying this condition. The inclined contours evidence
 220 the presence of bending of the sample during the test. Bending may have find its origin in the
 221 causes already described in Section 1. A nonuniform stress distribution is a consequence of
 222 bending, which may make the Classical approach inaccurate to treat the results. It is worth
 223 noting that bending may be a consequence of material heterogeneities. However, the pressing
 224 procedure used herein to manufacture the sample minimizes such heterogeneity. Moreover,

225 a local heterogeneous behavior can be seen if the representative elementary volume is not
 226 respected. To avoid this artifact, a specimen with dimensions much larger than the average
 227 granule size of the powder (about $75 \mu\text{m}$ [11]) was used. Local heterogeneities would also
 228 lead to a considerable non-smooth displacement field, which was not observed in this study.

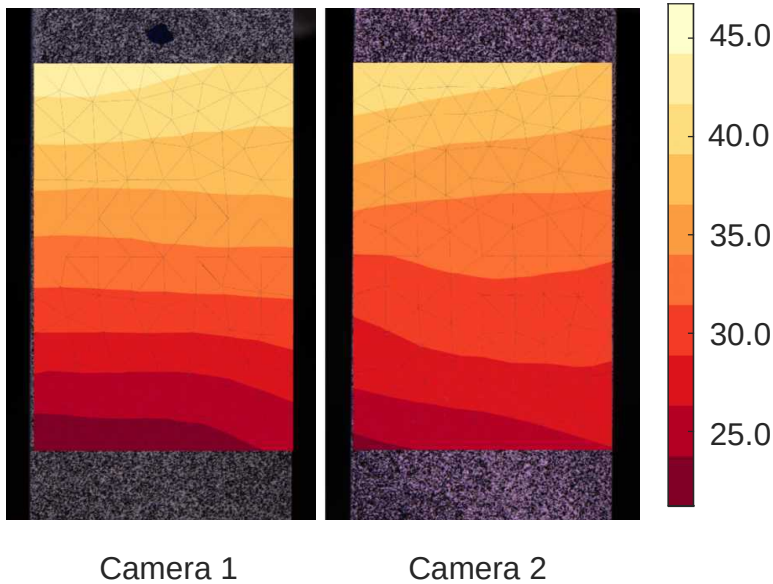

Figure 7 Vertical displacement fields (positive downward, expressed in μm) using independent DIC analyses for faces $y - z$ and $x - y$

229 In spite of the displacement fields measured from faces $y - z$ and $x - y$, (Fig. 7) showing the
 230 same tendency, the displacement levels on the common edge of the sample (right edge $y - z$
 231 and left edge $x - y$) are slightly different. By using the approach described in Section 3, the
 232 displacement field can be measured by prescribing the equality of the vertical displacements
 233 of both faces of the shared edge (MPC technique). Figure 8 shows the DIC results using this
 234 approach. A continuous vertical displacement field is observed for both faces, which means
 235 the technique successfully coupled the vertical degrees of freedom of the common edge in
 236 the two images. However, a numerical artifact emerges in this region, which is evidenced by
 237 the appearance of fluctuations in the form of “waves” in the displacement field. This artifact

238 is a consequence of a vertical misplacement of the mesh boundaries, which were initially
 239 positioned by visual inspection.

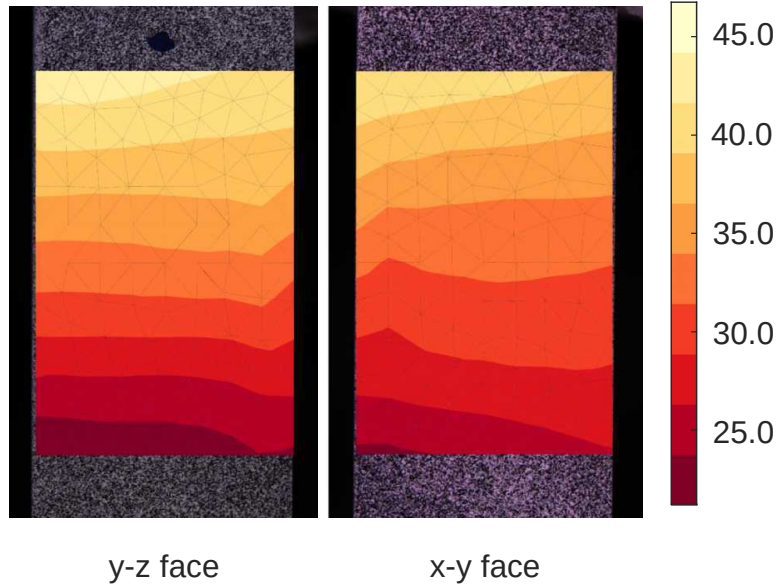
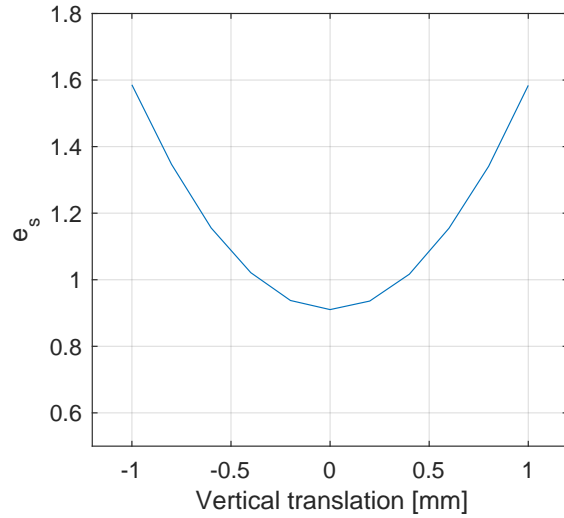

Figure 8 Vertical displacement fields of faces $y - z$ and $x - y$ (positive downward, expressed in μm) when the constraints of equal vertical displacements is prescribed on the common edge

240 To solve this problem, the optimization of the mesh boundary positions was performed
 241 by varying the vertical position of one mesh with respect to the other one. The result of
 242 the minimization of Eq. (14) showed that the meshes had to be shifted by a relative vertical
 243 displacement of 1.48 mm (*i.e.*, ≈ 64 pixels). The visual positioning of mesh boundaries
 244 was estimated to be in the yellow box of Fig. 9(a), and its optimization is depicted in
 245 white. Figure 9(b) shows the “shear” cost function (Eq. (14)) against the vertical mesh
 246 boundary translation about the optimal position. A smooth parabolic shape is observed and
 247 its minimum is close to unity, which means that the shear strain uncertainty γ_s is reached.



(a)



(b)

Figure 9 (a) Initial visual positioning of mesh boundaries (yellow) and after optimization (white).
 (b) Cost function e_s vs. vertical translation of mesh on $x - y$ face

248 Figure 10 shows the displacement field with the corrected mesh position. The artifact is
 249 less pronounced and the displacement field is smoother than in the previous case.

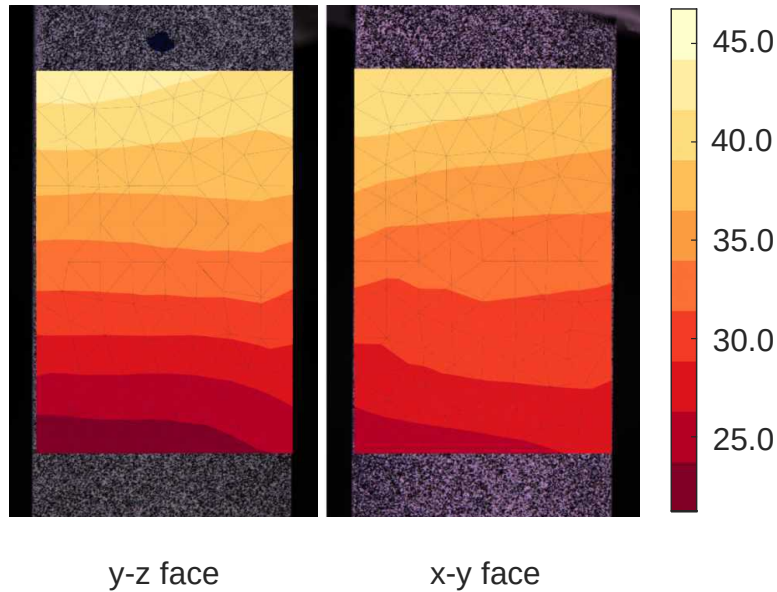

Figure 10 Vertical displacement fields for faces $y - z$ and $x - y$ (positive downward, expressed in μm) when the constraints of equal vertical displacements is prescribed on the common edge and the meshes were repositioned

250 This methodology made possible an analysis of both images in a more consistent way,
251 allowing the use of the displacement fields for FEMU-F optimization with considerations
252 of three dimensions. The corrected mesh was used in all identification approaches. The
253 correction is the most influential in the three-dimensional coupled analysis.

254 *5.2. Classical FEMU-F analysis*

255 By the use of a FEMU-F approach, the Young’s modulus E , yield stress σ_y , harden-
256 ing coefficient b , and compressive strength σ_∞ were identified using the ROI of DIC as a
257 virtual gauge for the sequence of images of $y - z$ and $x - y$ faces independently. Before
258 running the FEMU-F procedure, a sensitivity analysis was conducted (see Appendix A).
259 The identifiability of the sought parameters was checked (and confirmed) for the considered
260 experiment.

261 Figure 11 shows the stress-strain responses for axial strains obtained from independent
262 DIC analyses. From the full-field measurements, the axial strains were evaluated averaging
263 the engineering strain measure of DIC mesh elements (Fig. 5). The numerical results were
264 derived from a one-element FE model. The difference between experimental curves of $y - z$
265 and $x - y$ faces (Fig. 11) are due to bending of the specimen, which should be better captured
266 using the three-dimensional model of Section 5.4.

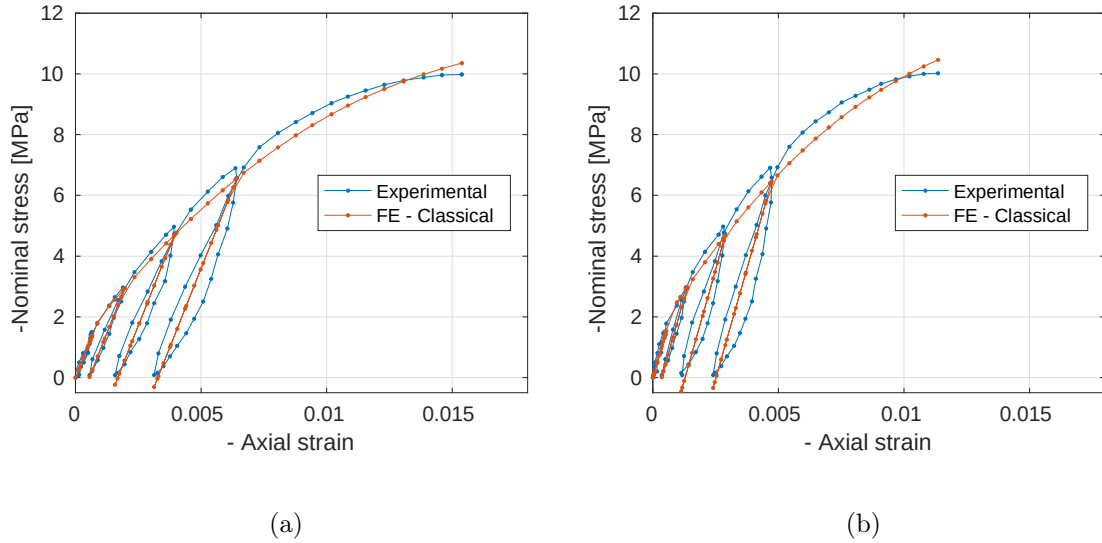

Figure 11 Classical (independent) analyses using DIC as a virtual strain gauge. Experimental and numerical stress-strain curves for (a) $y - z$ face, and (b) $x - y$ face

267 The difference between computed and measured loads, namely load residuals, are reported
 268 in Fig. 12. Their levels are similar for both faces, which is shown by the calculation of the root
 269 mean square (RMS) differences, namely 223 N (or 0.54 MPa) for the $x - y$ face, and 173 N
 270 (or 0.42 MPa) for the $y - z$ face. After the first two cycles, the residuals increase significantly,
 271 in other words, mostly in the plastic regime (Fig. 12). These cycles of loading and unloading
 272 have a better agreement between computed and measured forces, thereby highlighting that
 273 the selected elastic model cannot fully capture the unloading and reloading sequences of the
 274 last three cycles. Damage may explain such differences. The equivalent error (in RMS sense)
 275 for both faces is equal to 200 N, much higher than the load uncertainty, which evidences
 276 that this error has its source in the numerical and material models chosen herein.

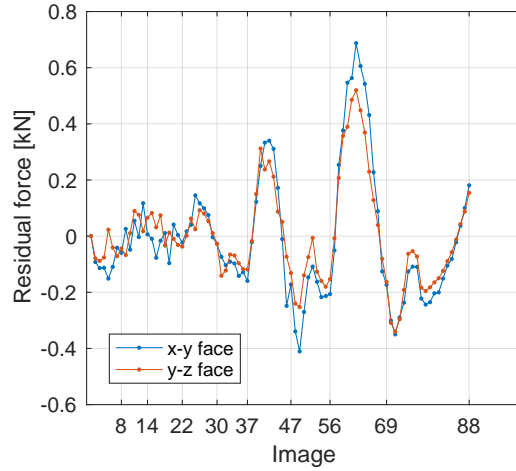

Figure 12 Load residuals for $x - y$ and $y - z$ faces

277 The values of the calibrated parameters are gathered in Table 5. The differences in
 278 levels for each face are mostly related to the assumption of homogeneous stress states in the
 279 specimen, which is not a good representation for this test.

Table 5 Calibrated parameters for Classical FEMU-F analysis

Parameters	$x - y$ face	$y - z$ face	Average
E [GPa]	2.9	2.1	2.5
σ_y [MPa]	2.3	2.0	2.1
σ_∞ [MPa]	12.4	11.6	12.0
b [-]	212	199	206

280 5.3. 2D Plane Stress FEMU-F analysis

281 By using boundary conditions measured via DIC, a plane stress analysis was performed
 282 for both faces independently. In this analysis, a non-homogeneous stress state can be achieved
 283 and bending effects partly taken into account. The same constitutive parameters as in the
 284 previous analysis were inspected. A sensitivity analysis was also performed for all images of

285 the test and the results were similar as before (Appendix A). In Fig. 13, experimental and
 286 numerical forces are compared for $y - z$ and $x - y$ faces. A good agreement is observed.

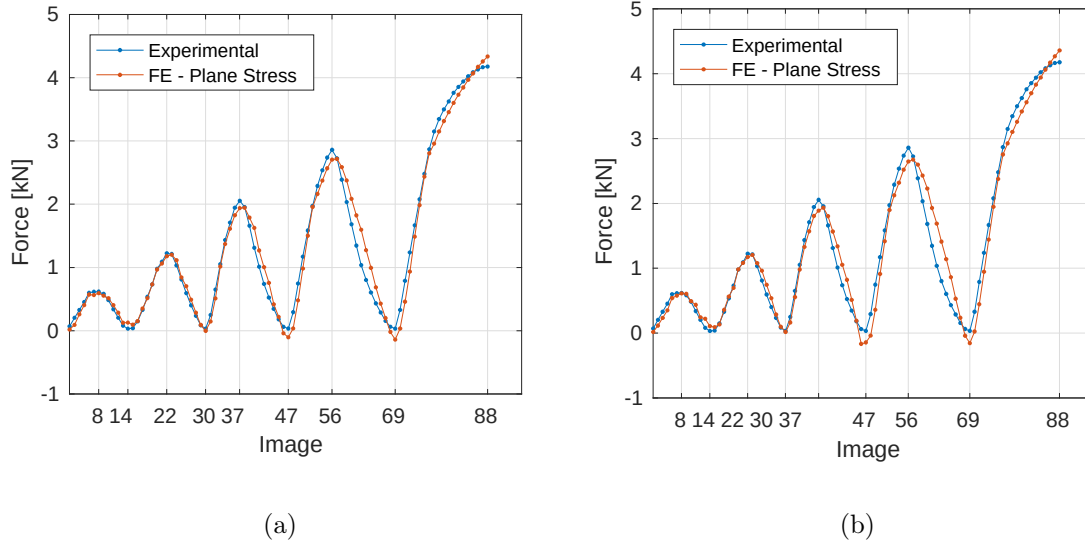

Figure 13 Plane stress analyses using measured boundary conditions. Experimental and computed forces for (a) $y - z$ and (b) $x - y$ faces

287 The difference between computed and measured forces are also very similar for both faces.
 288 The RMS values for the residual forces were evaluated as 221 N for $x - y$ face and 175 N for
 289 $y - z$ face. In the present case, the equivalent RMS error is 199 N, a value very close to that
 290 obtained in the previous analysis, which means that there was no significant improvement
 291 in the representation of the problem by the numerical model.

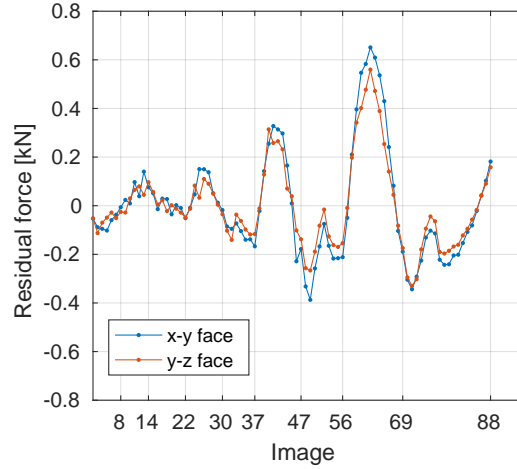

Figure 14 Force residuals for the plane stress analyses

292 Table 6 shows the two sets of parameters obtained for $y - z$ and $x - y$ faces. The
 293 gap between numerical and experimental data was minimized iteratively by the FEMU-F
 294 method (Fig. 13). However, there is a lack of agreement between the calibrated parameters
 295 for the two analyses, showing that the plane stress assumption was not sufficient to treat this
 296 problem. In the present case, bending has a three-dimensional nature, making inaccurate
 297 the previous assumption. Most of calibrated parameters were slightly closer to each other in
 298 comparison with the classical approach (Table 5), which may be related to the consideration
 299 of the bending effect in each face separately thanks to the plane stress analysis.

Table 6 Calibrated parameters for 2D Plane Stress FEMU-F analyses

Parameters	$x - y$ face	$y - z$ face	Average
E [GPa]	2.9	2.2	2.6
σ_y [MPa]	2.2	2.0	2.1
σ_∞ [MPa]	12.8	11.9	12.3
b [-]	209	197	203

300 5.4. 3D Coupled FEMU-F analysis

301 The 3D FEMU-F analysis used the data obtained from DIC using a multi-point constraint
 302 approach to couple the vertical DOFs on the shared edge of the specimen. On the top and
 303 bottom boundaries, the DIC data were extrapolated as described in Section 5.1. Sensitivities
 304 and the Hessian matrix are again very similar to those of the other two methods (Appendix
 305 A). The experimental and computed forces are reported in Fig. 15(a), and the corresponding
 306 residual forces in Fig. 15(b). The residual forces are similar for 3D and plane stress analyses,
 307 the RMS of the residual force for the present case is 191 N, which is lower than the values of
 308 the previous two analyses, thereby showing that the 3D consideration of the bending effect
 309 is an improvement in the numerical representation of the mechanical test.

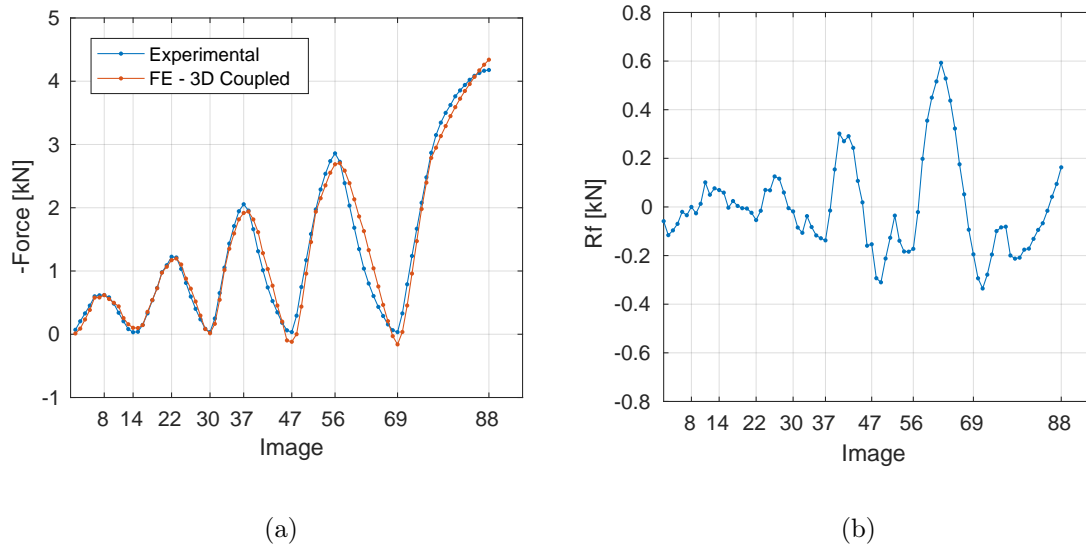

Figure 15 (a) Experimental and computed forces, and (b) corresponding residuals for the 3D Coupled FEMU-F analysis

310 The minimization of the gap between computed and experimental data by the 3D Coupled
 311 FEMU-F algorithm resulted in yet another set of parameters in comparison with the previous
 312 analyses (Table 7). It is interesting to note that their levels lie between those previously found
 313 and close, but not identical, to their averages.

Table 7 Calibrated parameters for 3D FEMU-F analysis

Parameters	3D FEMU-F
E [GPa]	2.5
σ_y [MPa]	2.0
σ_∞ [MPa]	12.4
b [-]	207

314 From the load distribution obtained in the FE model, it was possible to calculate the
 315 load eccentricity (*i.e.*, the point where the resultant moment vanishes) in directions x and
 316 z (Fig. 16). Small eccentricities are observed in both directions. However, neglecting them
 317 may lead to erroneous calibration of material parameters. For example, considering the
 318 parameters in the classical FEMU-F approach for the $x - y$ face, the Young's modulus is
 319 15.4% higher in comparison with that obtained in this last analysis. It is important to note
 320 that care was taken to minimize the bending effect during the test, by the use of epoxy resin
 321 in the end portion of the specimen and checking the parallelism in the platens of the testing
 322 machine. Yet, even with such procedures, it was not possible to fully align the sample.
 323 Further, it is interesting to note that beyond the second cycle, the eccentricity does not
 324 evolve much. This phenomenon is related to the fact that the material is yielding and that
 325 this nonlinearity induces stress (and strain) redistributions that were not possible in the
 326 elastic regime.

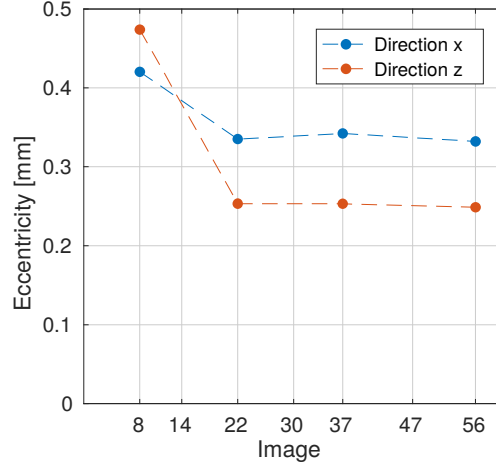

Figure 16 Eccentricity of the load distribution at loading peaks, expressed as distance from the center of the cross section

327 Figure 17(a) shows the FE results of the axial strain distribution in the ROI of the spec-
 328 imen for the last image (*i.e.*, at maximum loading). Non-homogeneous strains are observed
 329 in the specimen. Moreover, the average value of axial strain is close to the diagonal of the
 330 cross-section that is related to the same magnitude of eccentricity shown in Fig. 16. The
 331 so-called percent bending [5] is a quantity defined as the difference between the strain on
 332 the surface and the nominal axial strain divided by the nominal axial strain. It is a measure
 333 of the goodness of uniaxial compression tests. Figure 17(b) shows the average and standard
 334 deviation of the axial strains as functions of the image number. The two quantities are
 335 proportional to each other during the whole test. From such data, it is possible to calcu-
 336 late a maximum percent bending of 23, which is approximately 10 times higher than the
 337 recommended level (*i.e.*, 2.5 [5]).

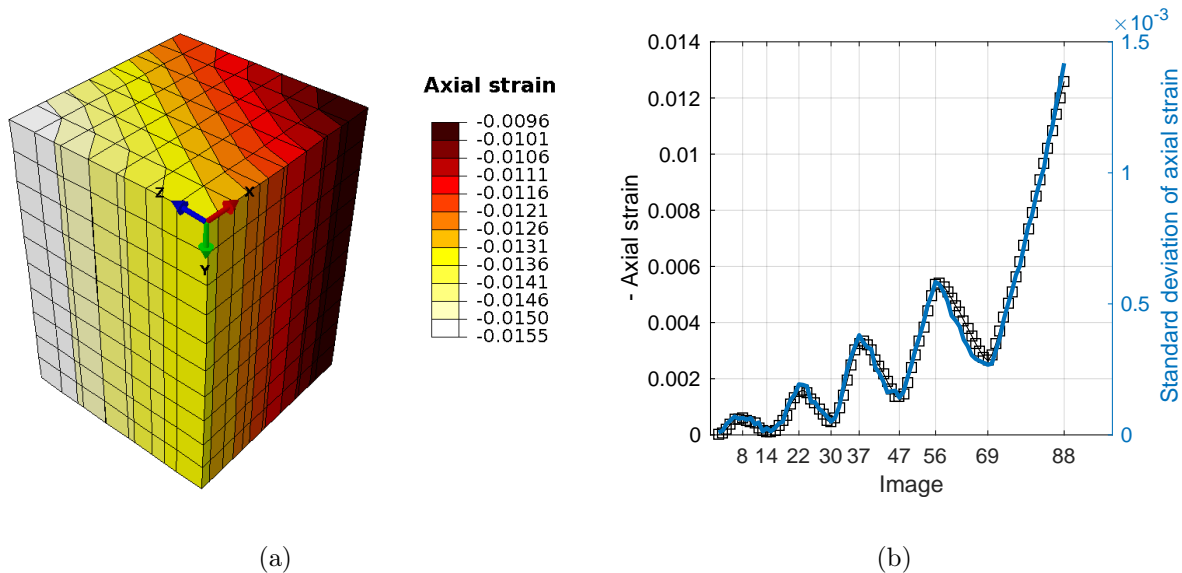

Figure 17 (a) Axial strain distribution in the FE model for the last image (88) and (b) Average (square symbols) and standard deviation (solid blue line) of axial strain vs. image number

338 6. Conclusions

339 Some experimental artifacts in uniaxial compression tests may lead to spurious bending
 340 effects, rendering inaccurate the usual assumption of uniform strain over the cross-section of
 341 the specimen. DIC measurements were conducted by using two cameras that captured images
 342 of two perpendicular free surfaces of the specimen. The multi-point constraint technique was
 343 used to couple the degrees of freedoms of the shared boundary of the images captured from
 344 both faces in a DIC framework.

345 A FEMU-F methodology was applied to calibrate the elastoplastic parameters of a
 346 Drucker-Prager model for three distinct cases:

- 347 • Classical approach where DIC was used as a virtual strain gauge and the constitutive
 348 model was fitted with the load-strain curve independently for the results of both faces;
- 349 • 2D Plane stress analysis where the boundary conditions were prescribed displacements
 350 obtained independently from DIC analyses;

351 • 3D Coupled analysis where the multi-point constraint technique was used to join the
352 results of DIC from image acquisitions of both faces, and extrapolation of the measured
353 boundary conditions to two cross-sections.

354 As expected, the independent analyses for both faces (*i.e.*, classical approach and plane-stress
355 analyses, see Table 3) resulted in different sets of parameters as a consequence of the violation
356 of the uniform strain assumption. As 2D Plane Stress analyses consider the bending effect
357 in their plane, most of the calibrated parameters were closer to each other in comparison
358 with the classical approach. The full consideration of the bending effect in the 3D Coupled
359 analysis leads to a set of parameters that lies within the intervals of the parameters found
360 from the previous two approaches. The average parameters of Classical and 2D Plane Stress
361 analyses are also good approximations of the set of parameters obtained in the 3D analysis.
362 However, the latter led to the lowest identification residuals. This observation shows that
363 the 3D model better captures bending effects and leads to more trustworthy results.

364 The developed procedure permitted to check, measure and consider the bending effects
365 in uniaxial compression tests and their analyses. The implemented procedure was applied to
366 measure the displacement fields on two perpendicular lateral surfaces of the specimen. The
367 use of two cameras is the minimum required to capture the parasite bending effect in both
368 directions perpendicular to the loading axis. In return, the boundary conditions have to be
369 extrapolated on the non-measured surfaces. The procedure can also be applied using a four-
370 camera system. In this case, the extrapolation would be only performed only for bulk nodes.
371 It is worth noting that a multiview correlation framework [50] may have been used. It would
372 not have required the use of multi-point constraint technique to measure the 3D surface
373 displacement fields. However, it would involve a calibration step of the cameras. Last, the
374 boundary conditions could themselves have been introduced as additional unknowns to the
375 minimization problem [51]. As a final perspective, a study with several specimens should be

376 carried out to further evaluate the benefit of the newly developed procedure.

377 **7. Acknowledgments**

378 This study was financed in part by the Coordenação de Aperfeiçoamento de Pessoal
379 de Nível Superior - Brasil (CAPES) - Finance Code 001, and the support by the grants
380 #130167/2018-5, National Council for Technological and Scientific Development - CNPq
381 (Brazil) and #2018/02801-4, #2018/15266-0 and #2018/25419-8, São Paulo Research Foun-
382 dation (FAPESP).

383 **8. References**

- 384 [1] J. Gustkiewicz, Uniaxial compression testing of brittle rock specimens with special con-
385 sideration given to bending moment effects, in: International Journal of Rock Mechanics
386 and Mining Sciences & Geomechanics Abstracts, Vol. 12, Elsevier, 1975, pp. 13–25.
- 387 [2] I. Hawkes, M. Mellor, Uniaxial testing in rock mechanics laboratories, Engineering
388 Geology 4 (3) (1970) 179–285.
- 389 [3] S. D. Peng, Stresses within elastic circular cylinders loaded uniaxially and triaxially,
390 in: International Journal of Rock Mechanics and Mining Sciences & Geomechanics
391 Abstracts, Vol. 8, Elsevier, 1971, pp. 399–432.
- 392 [4] G. Sines, M. Adams, Compression testing of ceramics, in: Flaws and Testing, Springer,
393 1978, pp. 403–434.
- 394 [5] Standard test method for monotonic compressive strength of advanced ceramics at am-
395 bient temperature, Tech. rep., ASTM International (2015).

- 396 [6] R. Westerheide, K. A. Drüsedau, T. Hollstein, T. Schwickert, H. Zipse, Advances in
397 characterisation of machined green compacts, *Journal of the European Ceramic Society*
398 17 (2-3) (1997) 467 – 472. doi:10.1016/S0955-2219(96)00174-4.
- 399 [7] O. Coube, H. Riedel, Numerical simulation of metal powder die compaction with special
400 consideration of cracking, *Powder Metallurgy* 43 (2) (2000) 123–131.
- 401 [8] J. C. Cunningham, I. C. Sinka, A. Zavaliangos, Analysis of tablet compaction. i. char-
402 acterization of mechanical behavior of powder and powder/tooling friction, *Journal of*
403 *Pharmaceutical Sciences* 93 (8) (2004) 2022–2039. doi:{10.1002/jps.20110}.
- 404 [9] V. Mazel, H. Diarra, V. Busignies, P. Tchoreloff, Comparison of different failure tests
405 for pharmaceutical tablets: Applicability of the drucker–prager failure criterion, *Inter-*
406 *national journal of pharmaceutics* 470 (1-2) (2014) 63–69.
- 407 [10] H. Shin, J.-B. Kim, A numerical investigation on determining the failure strength of
408 a powder compact in unconfined compression testing by considering the compressible
409 character of the specimen, *Powder Technology* 277 (2015) 156–162.
- 410 [11] F. S. Montilha, F. O. Rocco, C. C. Melo, V. F. Sciuti, R. B. Canto, Identification
411 of dilatancy in green compacted ceramic powder via digital image correlation, *Powder*
412 *Technology* 330 (2018) 471–476.
- 413 [12] M. Grédiac, F. Hild, Full-field measurements and identification in solid mechanics, John
414 Wiley & Sons, 2012.
- 415 [13] F. Hild, S. Roux, Digital image correlation, in: P. Rastogi, E. Hack (Eds.), *Optical*
416 *Methods for Solid Mechanics. A Full-Field Approach*, Wiley-VCH, Weinheim (Ger-
417 many), 2012, pp. 183–228.

- 418 [14] M. Sutton, Computer vision-based, noncontacting deformation measurements in me-
419 chanics: A generational transformation, *Applied Mechanics Reviews* 65 (AMR-13-1009)
420 (2013) 050802.
- 421 [15] M. Sutton, W. Wolters, W. Peters, W. Ranson, S. McNeill, Determination of displace-
422 ments using an improved digital correlation method, *Im. Vis. Comp.* 1 (3) (1983) 133–
423 139.
- 424 [16] M. A. Sutton, J. J. Orteu, H. Schreier, Image correlation for shape, motion and de-
425 formation measurements: Basic concepts, theory and applications, Springer Science &
426 Business Media, 2009.
- 427 [17] S. Roux, F. Hild, Y. Berthaud, Correlation image velocimetry: A spectral approach,
428 *Applied Optics* 41 (1) (2002) 108–115.
- 429 [18] B. Wagne, S. Roux, F. Hild, Spectral approach to displacement evaluation from image
430 analysis, *European Physical Journal: Applied Physics* 17 (2002) 247–252.
- 431 [19] G. Broggiato, Adaptive image correlation technique for full-field strain measurement,
432 in: C. Pappalettere (Ed.), 12th Int. Conf. Experimental Mechanics, McGraw Hill, Lilan
433 (Italy), 2004, pp. 420–421.
- 434 [20] Y. Sun, J. Pang, C. Wong, F. Su, Finite-element formulation for a digital image corre-
435 lation method, *Applied Optics* 44 (34) (2005) 7357–7363.
- 436 [21] G. Besnard, F. Hild, S. Roux, “Finite-element” displacement fields analysis from digital
437 images: Application to Portevin-Le Chatelier bands, *Experimental Mechanics* 46 (2006)
438 789–803.

- 439 [22] H. Leclerc, J. Périé, S. Roux, F. Hild, Integrated digital image correlation for the identi-
440 fication of mechanical properties, in: A. Gagalowicz, W. Philips (Eds.), MIRAGE 2009,
441 Vol. LNCS 5496, Springer, Berlin (Germany), 2009, pp. 161–171.
- 442 [23] S. Avril, M. Bonnet, A. Bretelle, M. Grédiac, F. Hild, P. Ienny, F. Latourte, D. Lemosse,
443 S. Pagano, E. Pagnacco, F. Pierron, Overview of identification methods of mechanical
444 parameters based on full-field measurements, *Experimental Mechanics* 48 (4) (2008)
445 381–402.
- 446 [24] J. D. Collins, G. C. Hart, T. K. Hasselman, B. Kennedy, Statistical identification of
447 structures, *AIAA Journal* 12 (2) (1974) 185–190.
- 448 [25] K. T. Kavanagh, Extension of classical experimental techniques for characterizing
449 composite-material behavior, *Experimental Mechanics* 12 (1) (1972) 50–56.
- 450 [26] K. T. Kavanagh, R. W. Clough, Finite element applications in the characterization of
451 elastic solids, *International Journal of Solids and Structures* 7 (1971) 11–23.
- 452 [27] K. Sun, Y. Zhao, H. Hu, Identification of temperature-dependent thermal–structural
453 properties via finite element model updating and selection, *Mechanical Systems and*
454 *Signal Processing* 52 (2015) 147–161.
- 455 [28] E. Pagnacco, D. Lemosse, F. Hild, F. Amiot, Inverse strategy from displacement field
456 measurement and distributed forces using fea, in: 2005 SEM annual conference and
457 exposition on experimental and applied mechanics, 2005.
- 458 [29] S. Cooreman, D. Lecompte, H. Sol, J. Vantomme, D. Debruyne, Elasto-plastic mate-
459 rial parameter identification by inverse methods: Calculation of the sensitivity matrix,
460 *International Journal of Solids and Structures* 44 (13) (2007) 4329–4341.

- 461 [30] D. Lecompte, A. Smits, H. Sol, J. Vantomme, D. V. Hemelrijck, Mixed numerical-
462 experimental technique for orthotropic parameter identification using biaxial tensile
463 tests on cruciform specimens, *International Journal of Solids and Structures* 44 (5)
464 (2007) 1643–1656.
- 465 [31] P. Ienny, A.-S. Caro-Bretelle, E. Pagnacco, Identification from measurements of mechan-
466 ical fields by finite element model updating strategies: a review, *European Journal of*
467 *Computational Mechanics/Revue Européenne de Mécanique Numérique* 18 (3-4) (2009)
468 353–376.
- 469 [32] F. Mathieu, H. Leclerc, F. Hild, S. Roux, Estimation of elastoplastic parameters via
470 weighted FEMU and integrated-DIC, *Experimental Mechanics* 55 (1) (2015) 105–119.
- 471 [33] Z. Tomičević, J. Kodvanj, F. Hild, Characterization of the nonlinear behavior of nodular
472 graphite cast iron via inverse identification: Analysis of biaxial tests, *European Journal*
473 *of Mechanics-A/Solids* 59 (2016) 195–209.
- 474 [34] R. Vargas, J. Neggers, R. B. Canto, J. A. Rodrigues, F. Hild, Analysis of a castable re-
475 fractory using the wedge splitting test and cohesive zone model, *Journal of the European*
476 *Ceramic Society* 39 (13) (2019) 3903–3914.
- 477 [35] K. Peng, J. Zhou, Q. Zou, J. Zhang, F. Wu, Effects of stress lower limit during cyclic
478 loading and unloading on deformation characteristics of sandstones, *Construction and*
479 *Building Materials* 217 (2019) 202–215.
- 480 [36] C. A. Felippa, Introduction to finite element methods, Course Notes, Department
481 of Aerospace Engineering Sciences, University of Colorado at Boulder, available at
482 <http://www.colorado.edu/engineering/Aerospace/CAS/courses.d/IFEM.d>.

- 483 [37] D. C. Drucker, W. Prager, Soil mechanics and plastic analysis or limit design, Quarterly
484 Journal of Applied Mathematics 10 (2) (1952) 157–165.
- 485 [38] Dassault Systèmes Simulia Corp., Providence, RI, USA., Abaqus 6.14 Documentation
486 (2014).
- 487 [39] C. C. Melo, A. L. I. Moraes, F. O. Rocco, F. S. Montilha, R. B. Canto, A valida-
488 tion procedure for numerical models of ceramic powder pressing, Journal of the Eu-
489 ropean Ceramic Society 38 (8) (2018) 2928–2936. doi:[https://doi.org/10.1016/j.](https://doi.org/10.1016/j.jeurceramsoc.2018.01.009)
490 [jeurceramsoc.2018.01.009](https://doi.org/10.1016/j.jeurceramsoc.2018.01.009).
- 491 [40] E. Voce, The relationship between stress and strain for homogeneous deformation, Jour-
492 nal of the Institute of Metals 74 (1948) 537–562.
- 493 [41] O. Zienkiewicz, R. Taylor, The Finite Element Method, 4th edition, McGraw-Hill, Lon-
494 don (UK), 1989.
- 495 [42] B. Lucas, T. Kanade, An iterative image registration technique with an application to
496 stereo vision, in: 7th International Joint Conference on Artificial Intelligence, 1981, pp.
497 674–679.
- 498 [43] L. Jendele, J. Červenka, On the solution of multi-point constraints—application to FE
499 analysis of reinforced concrete structures, Computers & Structures 87 (15-16) (2009)
500 970–980.
- 501 [44] R. D. Cook, D. S. Malkus, M. E. Plesha, Concepts and applications of finite element
502 analysis, John Wiley & Sons, 2007.
- 503 [45] M. Grédiac, F. Hild (Eds.), Full-Field Measurements and Identification in Solid Me-
504 chanics, ISTE / Wiley, London (UK), 2012.

- 505 [46] A. Tarantola, Inverse Problems Theory. Methods for Data Fitting and Model Parameter
506 Estimation, Elsevier Applied Science, Southampton (UK), 1987.
- 507 [47] H. Leclerc, J. Neggers, F. Mathieu, S. Roux, F. Hild, Correli 3.0,
508 IDDN.FR.001.520008.000.S.P.2015.000.31500 (2015).
- 509 [48] F. Hild, S. Roux, Comparison of local and global approaches to digital image correlation,
510 Experimental Mechanics 52 (9) (2012) 1503–1519.
- 511 [49] X. Fayolle, F. Hild, Controlling stress intensity factor histories with digital images,
512 Experimental Mechanics 54 (2) (2014) 305–314.
- 513 [50] J.-E. Dufour, F. Hild, S. Roux, Shape, Displacement and Mechanical Properties from
514 Isogeometric Multiview Stereocorrelation, Journal of Strain Analysis for Engineering
515 Design 50 (7) (2015) 470–487.
- 516 [51] M. Bertin, C. Du, J. P. M. Hoefnagels, F. Hild, Crystal plasticity parameter identifi-
517 cation with 3D measurements and integrated digital image correlation, Acta Materialia
518 116 (2016) 321–331.

519 Appendix A: Sensitivity Analysis

520 The sensitivity analysis is part of the calculations performed in the FEMU-F procedure
521 to check the identifiability of the sought parameters (Section 4). The load sensitivities
522 were computed by using Eq. (21) for the three FEMU-F approaches described in this study
523 (Table 3). The derivatives were estimated via forward differences with a perturbation factor
524 $\alpha = 10^{-2}$ of each parameter ($\Delta p_i = \alpha p_i$)

$$S_{F_i}(p_i, t) = \frac{\partial F_c}{\partial p_i}(p_i, t) \approx \frac{F_c(p_i + \Delta p_i, t) - F_c(p_i, t)}{\Delta p_i} \quad (21)$$

525 Note that the variables described in Eq. (21) are the same as those used in Eq. (15).

526 Figure 18 shows the computed load sensitivities \mathbf{S}_F for the different FEMU-F approaches,
527 indicating the influence of the studied material parameters at the different steps of the test.
528 The results of the sensitivity analysis are very similar between the independently analyzed
529 faces (Figure 18(a-b)) and the different FEMU-F approaches. The elastic modulus increases
530 its sensitivity at a higher rate in the elastic regions and a slower rate in the elastoplastic
531 regime, following the loading curve shown in Fig. 2.

532 All the parameters related to plasticity show no sensitivity in elasticity before first yielding
533 (as expected). The yield stress σ_y has a fast increase in sensitivity in the transition from
534 elastic to plastic regimes, and then a slow decrease until the peak stress. The contribution
535 of the hardening coefficient b and compressive strength σ_∞ become more important at the
536 end of the test, where their sensitivities are higher. For all parameters, the load sensitivities
537 are very high (in comparison with the load uncertainty of 4.5 N or the corresponding stress
538 uncertainty of 11 kPa) for a one percent variation of each parameter. This result indicates
539 that the parameters are expected to be identifiable for the considered test and proposed
540 identification route.

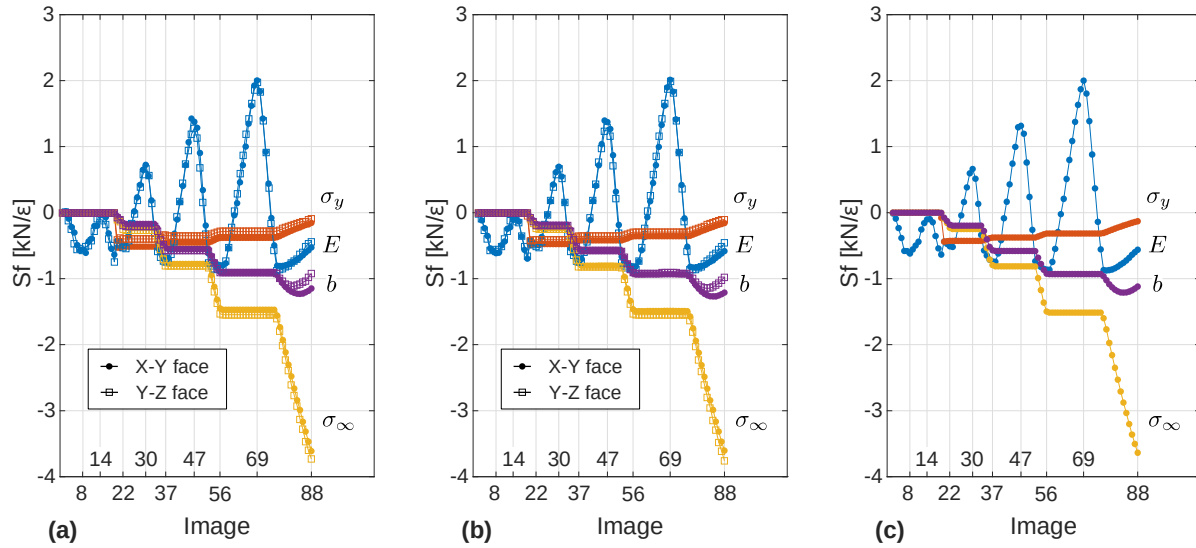

Figure 18 Computed load sensitivity for: (a) Classical analysis, (b) 2D Plane stress FEMU-F analysis and (c) 3D Coupled FEMU-F analysis.

541 Figure 19(a) shows the Hessian matrix in decimal logarithm for the Classical FEMU-F
 542 approach (see Eq. (19)). The sensitivity of the material parameters taken independently is
 543 related to the diagonal terms of the matrix. The off-diagonal terms represent the correla-
 544 tions between two parameters. The spectrum of eigen values (Fig. 19(b)) is not very wide,
 545 which indicates that the overall conditioning of the Hessian matrix is very good, namely,
 546 all parameters should be identifiable. The most sensitive parameters are the hardening and
 547 Young's moduli (*i.e.*, the third and fourth eigen vectors are mostly dependent on these two
 548 parameters), followed by the yield stress and then the ultimate strength.

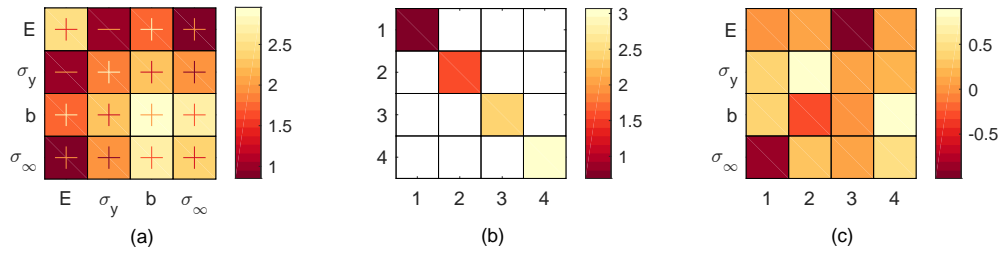

Figure 19 a) Hessian matrix in decimal logarithm for $x - y$ face in the classical FEMU-F analysis, (b) Decimal logarithm of the eigenvalues of Hessian matrix, and (c) corresponding eigenvectors.

549 As a consequence of very similar sensitivities for the FEMU-F approaches (Fig. 18), the
 550 Hessian matrix for the 2D Plane Stress and 3D Coupled approaches are also alike as shown
 551 in Figure 20.

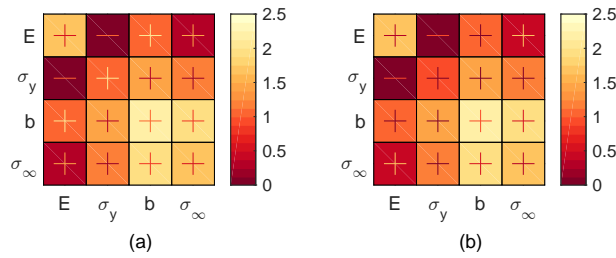

Figure 20 Hessian matrix in decimal logarithm for: (a) 2D Plane Stress and (b) 3D Coupled analyses.