



**HAL**  
open science

## State of knowledge on building construction within black cotton soil areas

Olivier Moles, Michel Dayre, Alexandre Douline, Samuel Dugelay, Philippe  
Garnier, Hugo Houben, Joffroy Thierry

► **To cite this version:**

Olivier Moles, Michel Dayre, Alexandre Douline, Samuel Dugelay, Philippe Garnier, et al.. State of knowledge on building construction within black cotton soil areas: Report to MSF Belgium. [Technical Report] CRAterre. 2006, pp.47. hal-02909749

**HAL Id: hal-02909749**

**<https://hal.science/hal-02909749>**

Submitted on 31 Jul 2020

**HAL** is a multi-disciplinary open access archive for the deposit and dissemination of scientific research documents, whether they are published or not. The documents may come from teaching and research institutions in France or abroad, or from public or private research centers.

L'archive ouverte pluridisciplinaire **HAL**, est destinée au dépôt et à la diffusion de documents scientifiques de niveau recherche, publiés ou non, émanant des établissements d'enseignement et de recherche français ou étrangers, des laboratoires publics ou privés.

# State of knowledge on building construction within black cotton soil areas

## Report to MSF Belgium

Information collected and compiled by CRATerre-ENSAG  
under the coordination of Olivier Moles

September 2006



## **ACKNOWLEDGEMENT**

Our thanks go to MSF-Belgium, in particular to Yannick Garbusinski, MSF Logistic department - construction & rehabilitation / shelter support, to offer us the opportunity to compile useful information to be relevant to projects construction to be implemented in South Sudan to improve the quality of life of people and communities.

## **FOREWORD**

This document is aiming at providing technical information to *Médecins Sans Frontières - Belgium* (MSF) for their building construction programme in South Sudan. This programme is part of the assistance provided by MSF to the local population through the construction of health and sanitary facilities.

We hope that this contribution from CRA Terre can help MSF in its work as an independent humanitarian organisation for medical aid.

This document (or part of it) may not be duplicated or published without the consent of the authors. Re-use of this document (or part of it) for the unique purpose of education and research cannot be done without clear mention of the authors (see references and bibliography). No commercial use of this document is allowed.

Coordination:                      Olivier Moles

Contributions:                    Olivier Moles, Michel Dayre, Alexandre Douline, Samuel Dugelay, Philippe Garnier, Hugo Houben, Thierry Joffroy

CRATerre-ENSAG, September 2006

## TABLE OF CONTENTS

ACKNOWLEDGEMENT .....	1
FOREWORD .....	2
TABLE OF CONTENTS .....	3
INTRODUCTION.....	4
1 EXPANSIVE SOIL / BLACK COTTON SOIL .....	5
1.1 Location in Sudan .....	5
1.2. Soil characteristic.....	6
1.3 Soil properties .....	6
1.4 Building effect on the soil behaviour.....	6
1.5 Soil behaviour effect on the building.....	7
2 COMMON APPROACHES TO BUILD ON EXPANSIVE SOIL .....	9
2.1 General valid for all approaches described in this chapter.....	9
2.2 What should be done.....	10
2.3 What should be avoided in all cases .....	10
2.4 Split construction .....	14
2.5 Reducing the effect of soil movement on the building... ..	18
2.6 Other approach: to replace black cotton soil by inert material .....	27
3 SELECTION OF SITE.....	29
4 ORIENTATION OF THE BUILDINGS.....	30
5 SITE CLEARANCE .....	32
6 INFILL .....	33
7 FLOOR SLABS .....	34
8 BLOCK WORK.....	35
9 RING BEAM .....	38
10 OPENINGS .....	39
11 ROOFING.....	40
12 WATER DISTRIBUTION AND EVACUATIONS.....	41
13 CEILING.....	42
14 VERANDA AND ELEMENTS IN TOUCH WITH THE BUILDING.....	43
15 TREATMENT OF SURROUNDINGS .....	44
BIBLIOGRAPHY .....	45

## INTRODUCTION

This document is a compilation of pieces of literature, project information and research data on "black cotton soil" and how to deal with for building construction purpose and activities. Specific "chemical" treatments (e.g. lime or fly ash) are not cover but can be a good solution to "stabilise" expansive clay. Information on this particular subject is available on the internet<sup>1</sup>.

This document is primarily developed to help technicians, engineers, architects and others building professionals involved with the MSF-Belgium projects in South Sudan to design and build facilities and the other buildings needed to upgrade the health situation of the local population.

This document does not offer ready-made solutions as exact local conditions are not known by the authors but it proposes various options/solutions that people in charge at local level have to select and implement.

All figures were taken from existing literature. A letter place between brackets (e.g. (k.)) next to each figure indicates a reference in the bibliography from which it has been taken.

Within this programme, several building will have to be built: health centres, clinic, etc.

Although these buildings have to be rapidly erected to ensure MSF to be able to run its activities as soon as possible, they have to perform well in the long-term. As MSF programme is foreseen to work on a long-period basis and will require the building of facilities over the period duration, it is of key importance that building design and construction are appropriate in terms of use and maintenance. Architectural and economical aspects are of second importance.

The key challenges that MSF will have to meet are:

- the lack skills labour;
- the difficulty to transport materials due to poor transport network, especially during the raining season;
- the soil conditions on which the building are erected or will be built, as it is black cotton soil (swelling or expansive clays).

If this last aspect is not properly dealt with it can result in building construction disorder and in certain cases severe damages. This particular type of soil follows a "shrinkage-swelling cycle" when moisture ratio varies with dry and wet weather.

This document is a compilation of piece of literature, project information and research works data. It is primarily developed to help Technicians, Engineers and Architects from MSF South Sudan team project to build facilities and other building structures needed by the population, where Black Cotton Soil conditions are met.

---

<sup>1</sup> e.g. basin web site : [www.basin.info](http://www.basin.info)

# 1 EXPANSIVE SOIL / BLACK COTTON SOIL

## 1-1 Location in Sudan

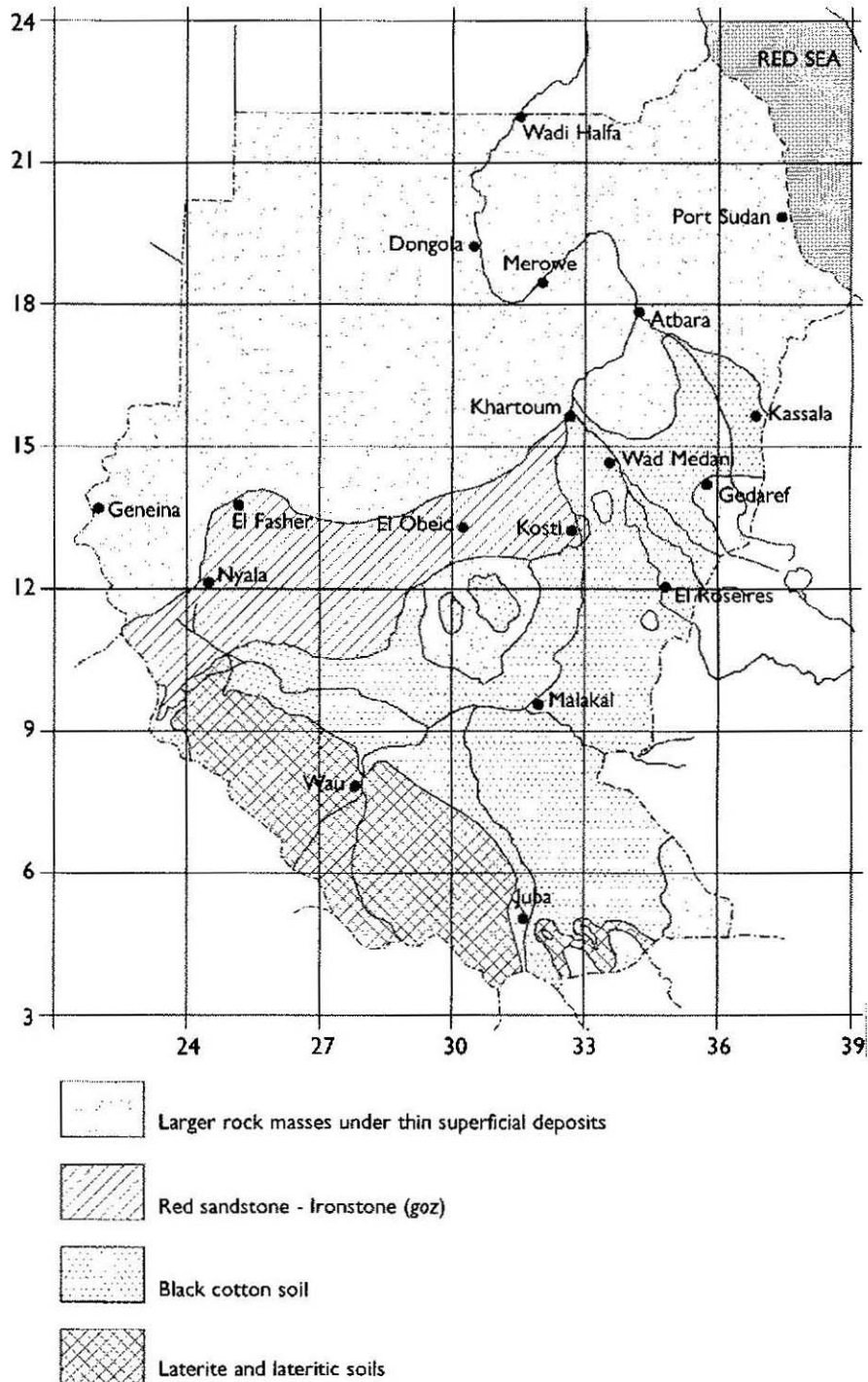

(p)



## 1-2 Soil characteristic

Expansive soils contain clay minerals, such as montmorillonite, which are dimensionally very sensitive to changes in moisture content.

These soils swell when the moisture content increases and shrinks when it dries out.

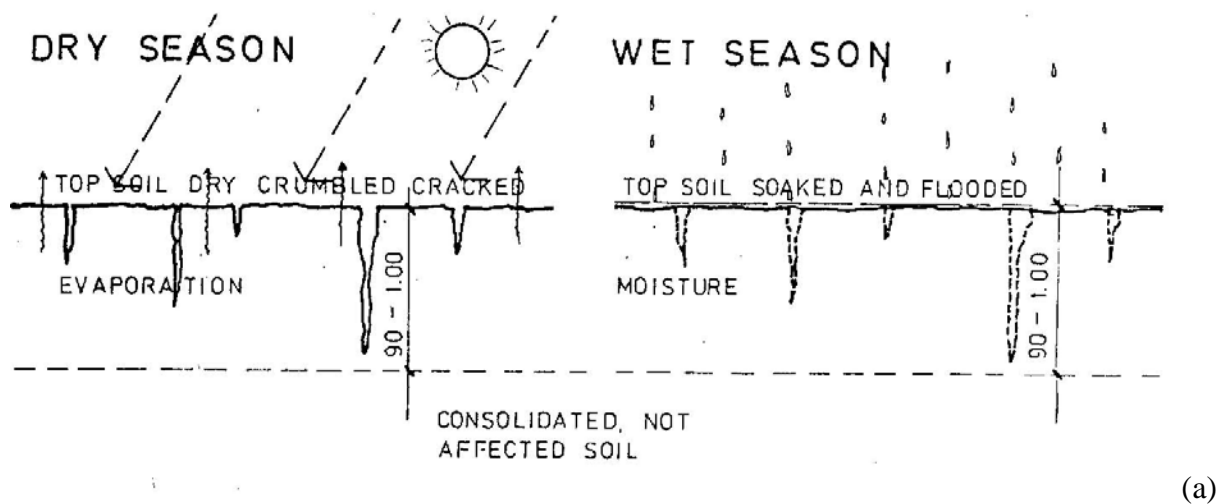

## 1-3 Soil Properties

Seasonal expansion /shrinkage rate of these soils could be around 8 % in volume. As a result, this soil could develop cracks of 8cm thick and 90 to 100 cm deep when it is completely dried

That is to say that, in normal condition, the first 100 cm of soil from the ground level will be affected by this phenomenon of expansion/ shrinkage.

Vertical soil movement can be in extreme cases and conditions up to 50 cm.

## 1-4 Building effect on the soil behaviour

The construction of a building changes both the temperature and the evaporation condition of the soil beneath the area it occupied. This will change moisture movement as well as moisture contents in the concerned zones.

The building will act as an impermeable membrane on the soil. The water under the building cannot escape anymore and will increase the moisture contents of the soil at this particular place. As a result, the soil will expand.

It may happen that some part of this beneath soil will be in touch with water (for example at the side of the building) and start to expand while some other part will remain dried and so keep its original volume (at the centre of the building). This will definitely create some differential movement within the building structure.

To dig trenches to build the foundation will allow the water to penetrate faster (between the existing soil and the substructure) to the base of the foundation. As a consequence, the soil between 90 and 100 cm beneath the base of the foundation will be subject to expansion and shrinkage movement.

### 1-5 Soil behaviour effect on the building

Building erected in such soils without any particular precaution invariably develops cracks that can put its stability in danger.

If it is possible to guarantee that the soil beneath the building will keep constant moisture content after the building has been erected, most of the problems will be solved.

Unfortunately, moisture can come in touch to the soil beneath the building due to various factors:

- From the water table
- From the rain
- Through the trees roots (the soil affected by expansion shrinkage can be up to 5 meter deep from the ground level).
- Through badly achieved technical details during the building construction (bad water drainage...) or failure of technical details during the building life (breakage of water pipe...).
- From evaporation.
- Etc.

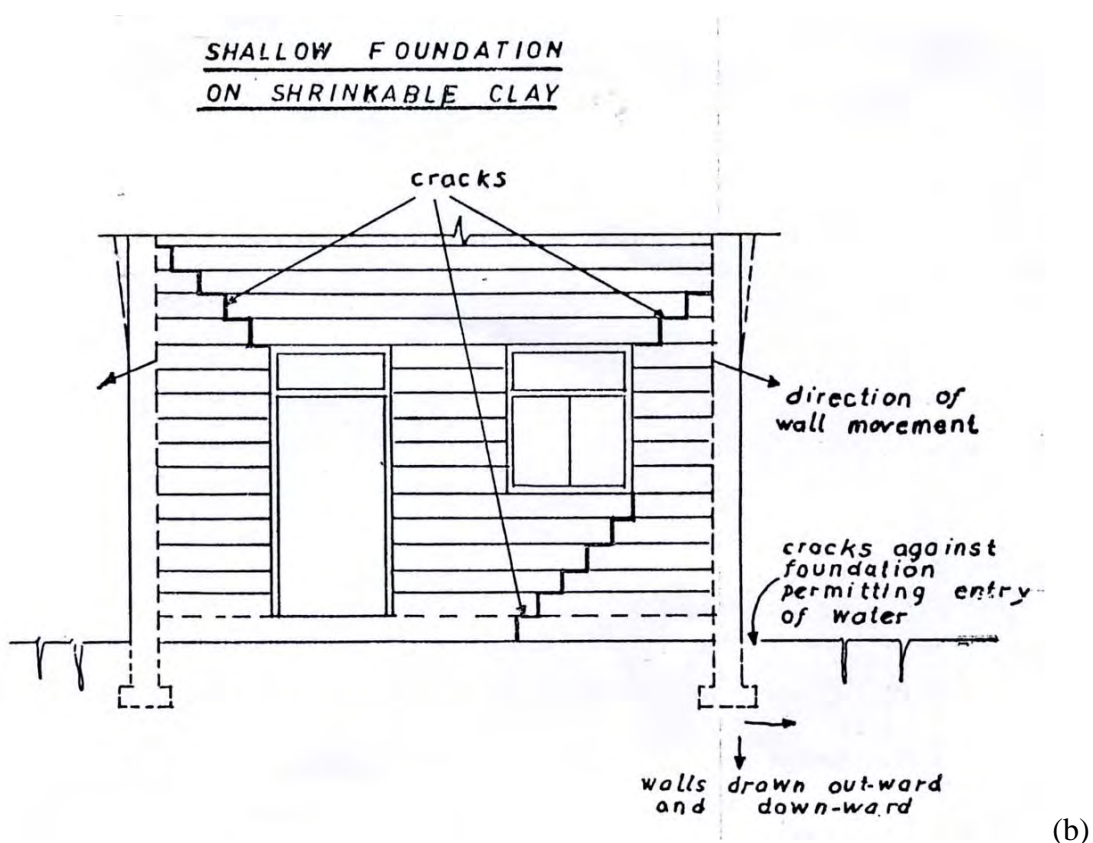

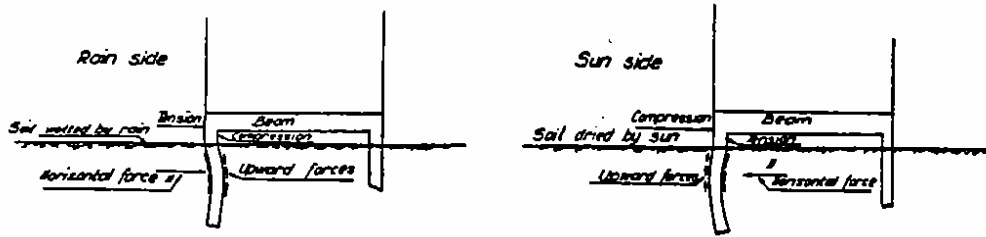

Mechanical actions on the foundations.

(n)

## **2 COMMON APPROACHES TO BUILD ON EXPANSIVE SOIL**

### **2-1 General rules to be applied in all cases**

#### House Drain

Joints between pipes should be flexible. All drainage connected with rigid joints will broke within no time.

#### Water pipes entering the building

Special attention should be paid at the connection between the building and the water network outside the building. A flexible connection should be developed to allow movement in alls direction.

#### Surfaces water drainage

Site selection for building erection should be properly done in order to avoid risk of water stagnation around the building. Moreover, after to be finished, special care will be done to slope the ground surrounding the building to drive the water far from the building position. If not properly done, and latter on, not properly maintained, the use of a concrete epron around the building may create more problems than the one it will solve. If it develops cracks, this epron will concentrate water infiltration at some specific part of the building and will not allow this water to escape through natural evaporation.

## 2-2 What should be done

- To avoid moisture contents variation under the building and at its immediate surrounding.

## 2-3 What should be avoided in all cases

- To think that we can always reach equilibrium between swelling and foundation pressure  
In case of light buildings on isolated small foundation, even at equal pressure, thanks to repartition and dissemination of stress within soil, underneath levels do not compensate each other

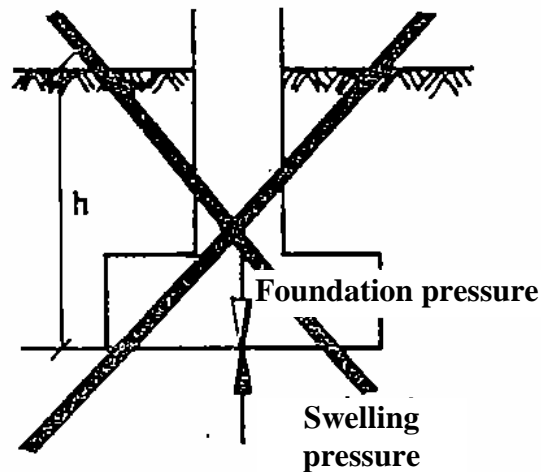

**NO**

(o)

- To put drainage next to foundations thinking that we can stop or reduce water absorption by the clay.

However one has to realise:

- that clay does not drain by gravity
- unless costly and sophisticated technologies are used, drainage get locked and became a water reservoir that contribute to clay / soil swelling

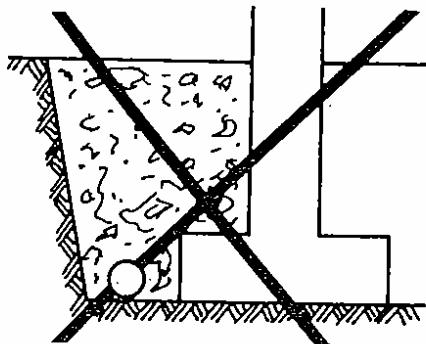

**NO**

(o)

- To think that one can make very resistant and rigid building to resist to swelling pressure
  - In certain cases, swelling pressure can reach several hundreds kPa and none of the normal reinforced concrete can withstand these conditions.

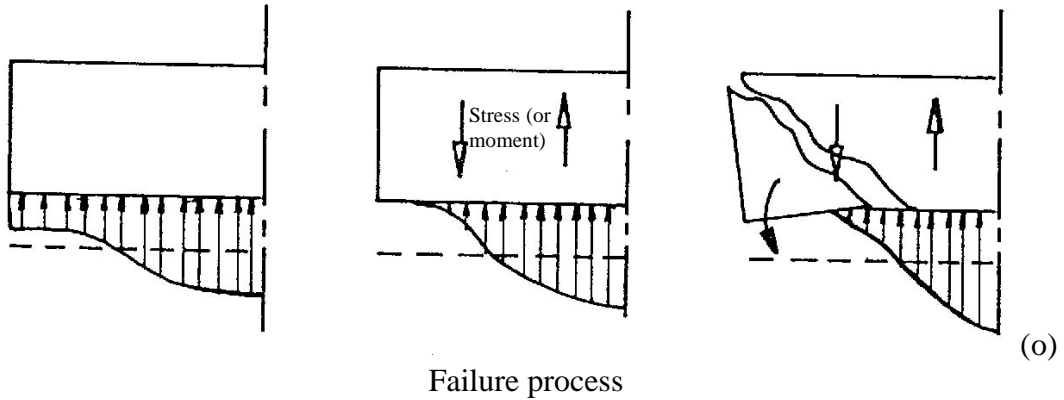

- if the accepted movement is lower the pressure it has to resist is higher, but when the limit of resistance is reached, the breakage can be immediate.
- the rigid "strategy" is only appropriate if  $\sigma_g < 100$  kPa and only for reinforced concrete structure of 6 storeys

- To dig out foundation with short pillars down to non-swelling level but without attention on the pile shaft

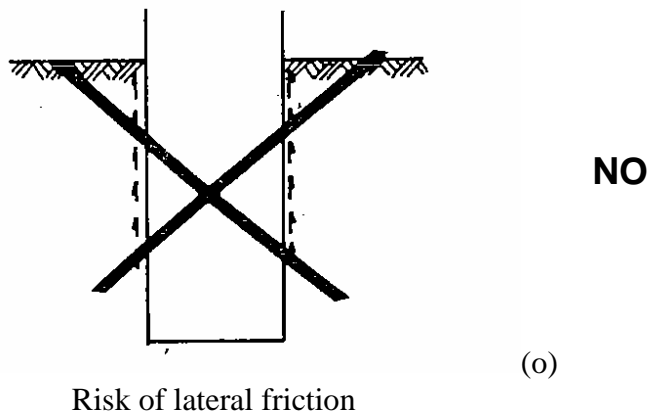

- To dig out appropriate short pillars foundation but to put up the slab directly on the ground  
It is necessary to create a suspended structure and a well dimensioned crawl place/sink hole

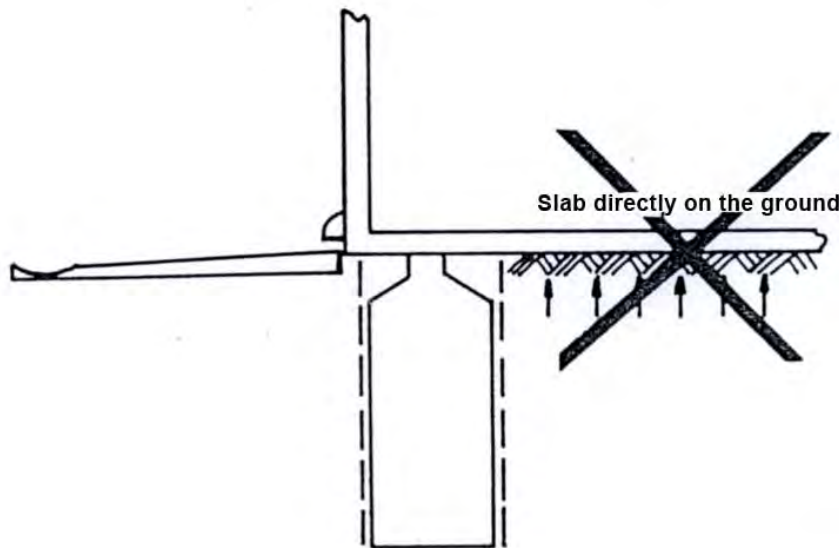

NO

(o)

Importance of air space

- To wet the ground before construction  
Correct options:
  - only if shrinkage can be avoided as the risk is more important when the swelling was also important
  - only if knowledge of swelling cycle is well know and mastered
- To treat the ground with lime only on surface  
This does not change anything to the swelling capacity of the underneath layers and it does not provide any barrier against water penetration

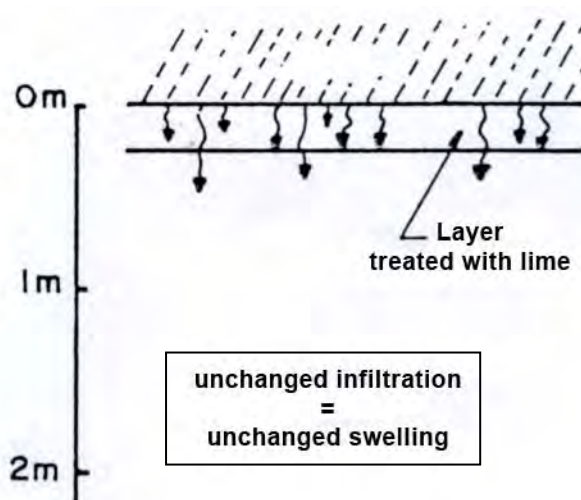

NO

(o)

Worsening building devices:

- Canalisation (distribution and collection of water) connected using rigid connections leading to breakage, leaking, infiltrations and increase of movement.
- Partial cellars
- Trees
- No consideration for differential settlement

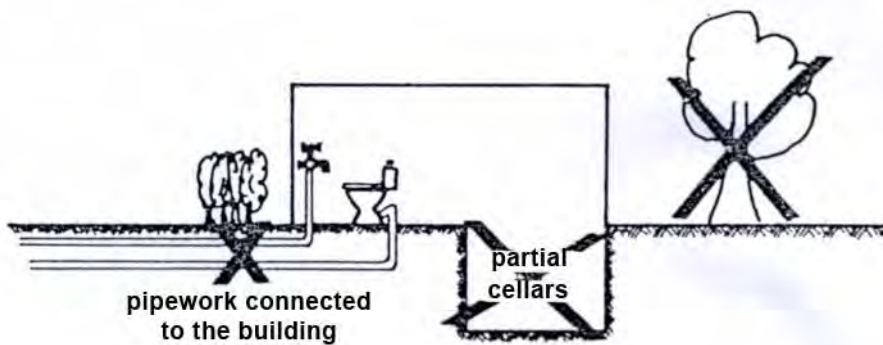

**NO**

(o)

Worsening arrangement

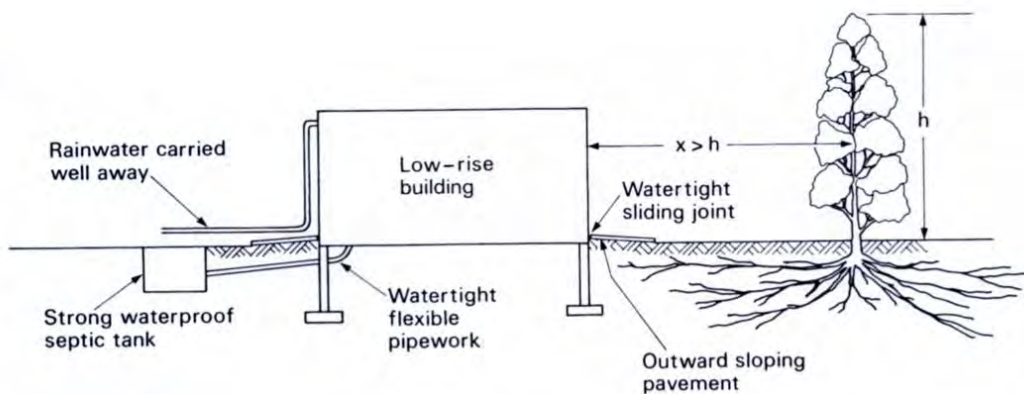

**YES**

(k)

Environmental control measures to minimise building damage



## **2-4 Split Construction**

The underlying principle of “split construction” is to accept the movements. The movements to be provided for are bending movements. The joints will widening or closing at their tops while their bottoms will remain in their original condition.

The building will be divided in self stable units that, all of them able to move relatively from each other.

This technique will concentrate the movement of the building in some particular part (the joint). The whole object is to avoid difficult or expensive maintenance. Knowing that the different part of the building will move according to the frame created, special attention will be paid to ensure that all the different part of the building will be also isolated from each other accordingly to the same frame (e.g ceiling; slab, partition walls, etc...).

Knowing what is the average distance between the vertical cracks that affect local building by simple observation may help to determinate the frame to be applied in the location where the new building should be erected.

Joints in walls both internal and external (1cm thick, fill with compressive material or left empty with provision of details to prevent wind and draught. This coverstrip should be secured on only one side) will be provided in the walls. Sections of walls in between the joints will be shaped as to be self-standing (U, T, I, L shaped).

Some part of the building will be naturally chosen to implement these joint:

- At the connection between walls and steel structure.  
In order to finish properly the building aspect, the masonry wall can fit inside the steel profile, or special details can be fixed on the steel structure to cover the joint between the masonry and the steel frame.
- At door and windows openings  
Walls are naturally weak at these parts, and, as results, cracks usually start from these places. Straight joints can be implemented both on top and down these openings.
- Between external and internal walls  
The partition walls can be place according to the frame given by the steel structure, this naturally creating a straight joint. As for external walls, shape of internal wall should give them self stability.

Floors need to be disconnected from the walls (internal and external) to avoid eventual soil movement under the slab to interact with the walls. At the base of the building, and because most of the cracks will be the fact of bending effect, the opening of the cracks won't be too big. Disconnection between the floor and the walls can be done by doing a dry joint between this two building element.

If materials, equipment and skills are available on MSF site, the best solutions will be to provide suspended floors (including disconnection with the walls) as this will definitely avoid the interaction of potential soil movement to the building structure. If this solution is applied, it will be useful to properly ventilate the structure under the slab in order to help a proper evaporation of water that may eventually come under the building.

Special attention should be paid to the ceiling. Each room should have its own structure. They should not be firmly tightened to the walls but last on them remaining free to move.

Roofing structure should also be linked to the wall in a manner that will allow movement between walls and roof. Within the structure chosen for MSF project in Sudan, the roof will be part of the steel structure. The steel structure will have to be disconnected from the masonry in order to avoid any problems due to the rigidity created by the trusses (walls may move while the roof will act as a whole and will remain rigid. If trusses are firmly anchored to the walls, this will create some horizontal cracks at the level of the trusses anchorage). For the same reasons, special attention will be paid not to link internal walls to the steel structure.

All additional construction to the main building should be properly separated by positioning of a joint of 1 cm thick minimum.

Slope and special protection should be developed in order to avoid this joint to be a place where water will be drive directly down to the base of the building.

If directly in touch with large part of masonry, doors and windows frame may be bended due to effort created by the potential walls movements. Technical details will have to be applied to avoid this risk.

Inside the building, network of water distribution and water evacuation should be properly designed in order to take into account possible differential movement between the different parts of the building. Special attention will be paid to avoid as much as possible that pipes will be connected to two building element separated by an expansion joint. If this needs to happen, the use of flexible connections between the pipes will be highly recommended at this particular place. As the amplitude of the potential walls deformation will be minimal at the closest distance from the ground level, it is highly recommended that pipes network will be positioned as close as possible from the level of the ground. It is recommended to help all pipes to be visible in order to allow control and maintenance. No joint should be placed inside the masonry.

Masonry can also be made flexible by using interlocking building component. The possible cracks will be shared "equally" within each concerned masonry element and reduce the risk of heavy cracks in some particular part of them.

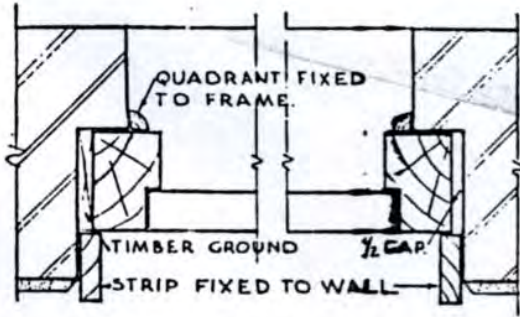

DETAIL OF FRAME

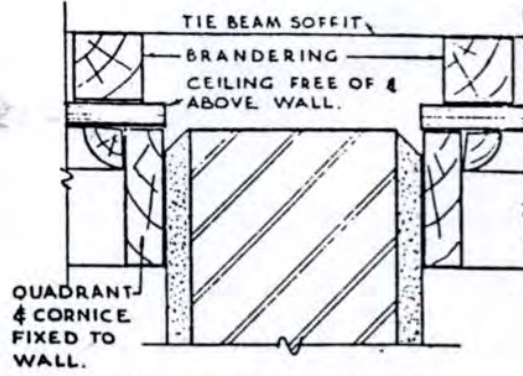

(b) INTERNAL WALL AT CEILING

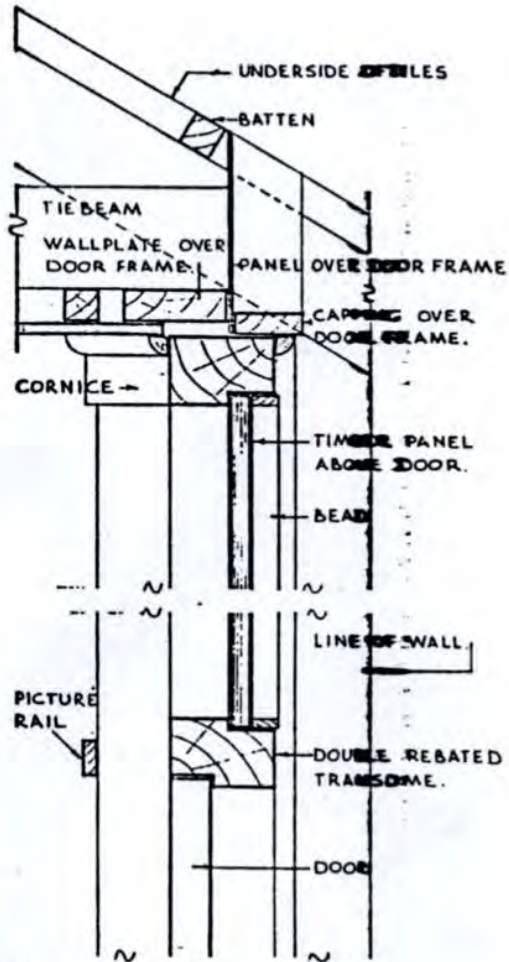

DETAIL AT HEAD OF DOOR

(c) FRAMES FOR EXTERNAL DOOR.

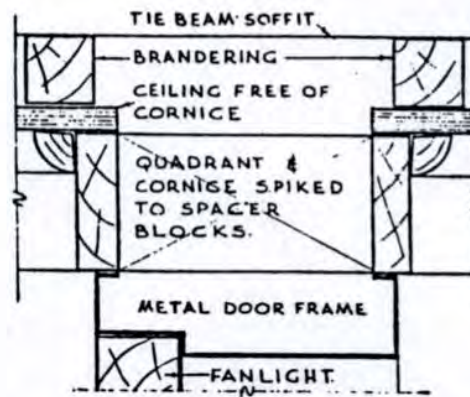

(d) HEAD OF INTERNAL DOOR FRAME.

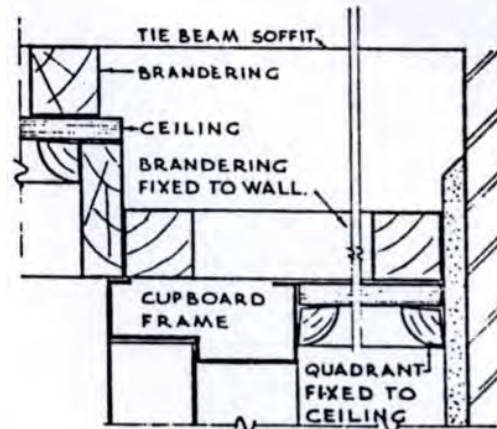

(e) HEAD OF CUPBOARD DOOR FRAME

(c)

High fanlights to doors and wall-to-ceiling for split construction

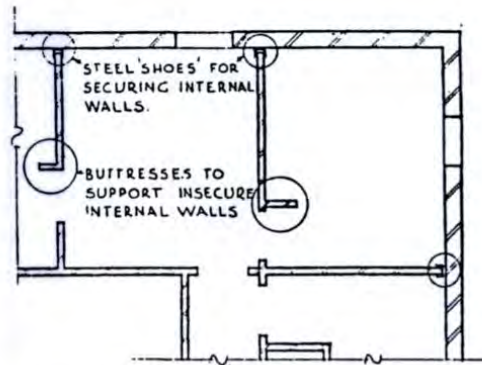
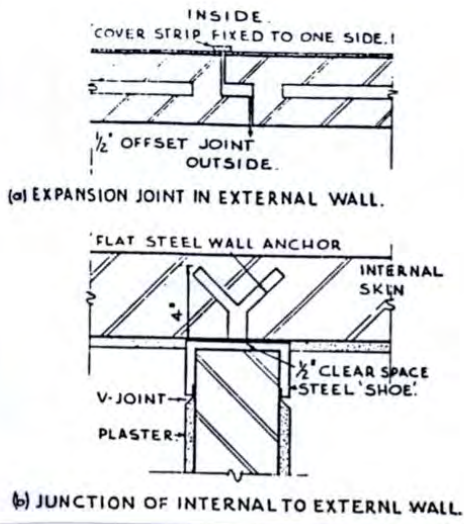

(c) ADDITIONAL BUTTRESSES & STEEL SHOES.  
FIGURE 3: Miscellaneous wall details in split construction.

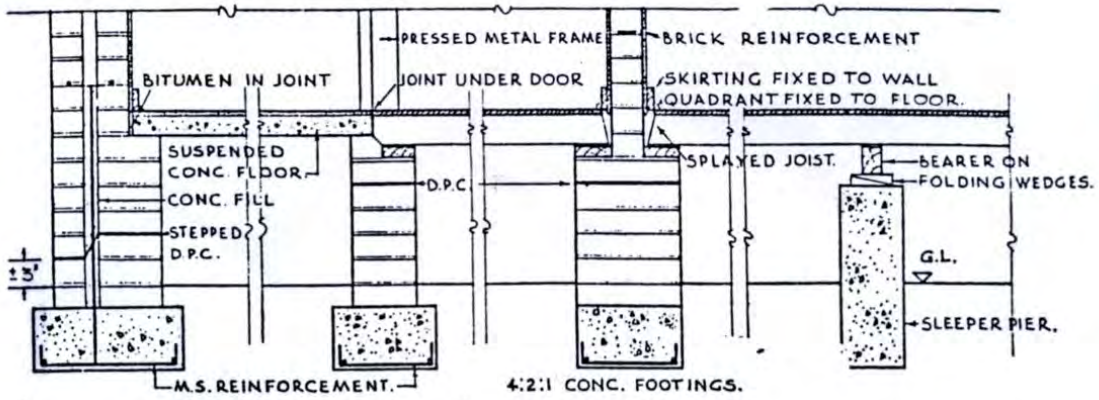

(c)

Suspended floor details – split construction

## **2-5 Reducing the effect of soil movement on the building through implementation of adequate foundation system**

**It is highly recommended to do the foundation excavation and the necessary work to achieve the foundation just after the raining season. At this time, the soil will have expanded and will show the zone affected and the way it could be affected.**

**Do not dig the excavation before the raining season as the zone beneath the foundation itself may be affected by the soil expansion/ shrinkage effect. If it is already done, it is recommended to excavate all the resulting affected soil and backfill it with stable soil before to start the foundation work.**

### **2-5-1 Deep traditional Foundation**

Traditional strip foundation could work if the depth of expansive soil is shallow and well known. According to literature<sup>2</sup>, this kind of foundation remains economic for a depth of maximum 1.8 metre.

If this is the case within MSF project, excavation should be carried down to the depth of stable ground in order to settle the foundation on it. Then the wall construction will proceed.

Special care will be paid to avoid floor to be in touch with the ground level as soil movement under the slab will make it moving with possible effect on the walls and the whole building structure. Suspended floor are highly recommended, but if it is not possible, precaution will be taken to realize the floors as it is recommended for split approach.

Another particular caution will be done to avoid the underground masonry to be vertically in contact with Black cotton soil. Lateral rubbing create by Black cotton soil movement could uplift part of the masonry and create damage on the whole building. In order to avoid this, it is recommended to excavate the Blacks cotton soil 1 metre wide each side of the future masonry and, after the masonry to be finished, to backfill these excavations with inert material (murrum<sup>3</sup>, stabilised black cotton soil, etc...). Some documents recommend to vertically introduce absorbent material between the masonry and the infill material (such as polystyrene...) but there is no data related to the life expectation of such techniques. Some others are recommending to put some grease on the vertical underground masonry in order to reduce rubbing between soil and masonry. Recommendation could be to at least plaster this underground masonry the smother as possible and then, provide a plastic sheet between this masonry and the in-fill material.

The superstructure could be designed as if the building will have been done in a non black cotton soil zone. But we recommend to design the building according to the split approaches, this in order to take into account possible mistake during the construction of the underground structure or any other part in contact with the ground level.

---

<sup>2</sup> Foundation for expansive soils; Sid Ahmed el Jack; National Building Research Station; Sudan

<sup>3</sup> Local name for good backfilling soil

FOOTING ON PARTIAL BACKFILLING  
AND CRAWL PLACE SINK HOLE

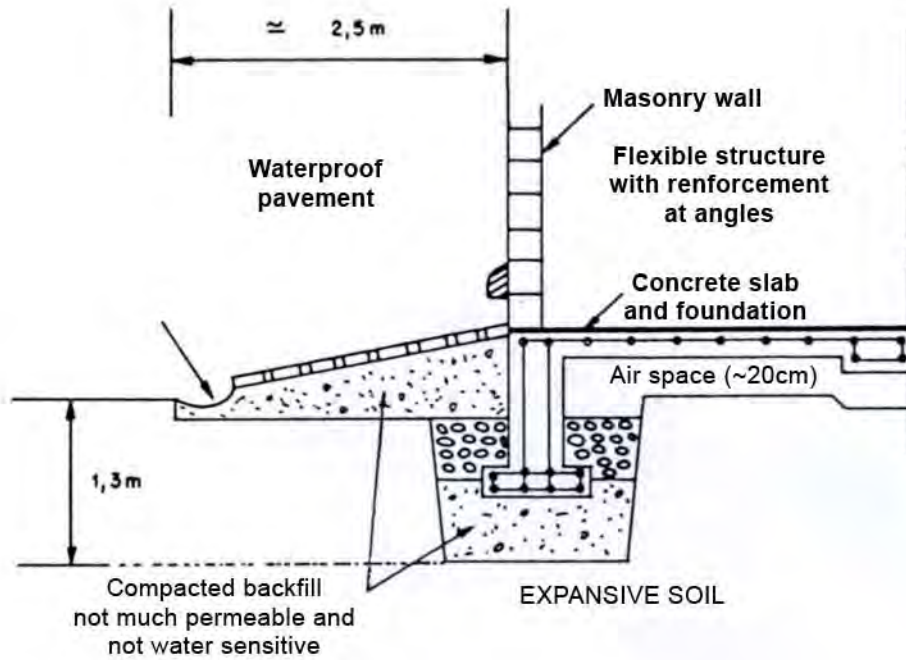

(o)

FOOTING OR RAFT FOUNDATION ON THICK BACKFILLING:  
Same as above with 2 m thick backfilling

**SEMI SUPERFICIAL FOOTING  
(BEAM-LADDER)**

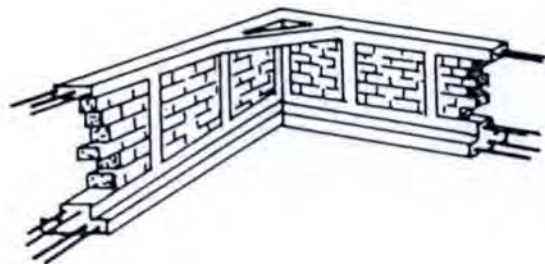
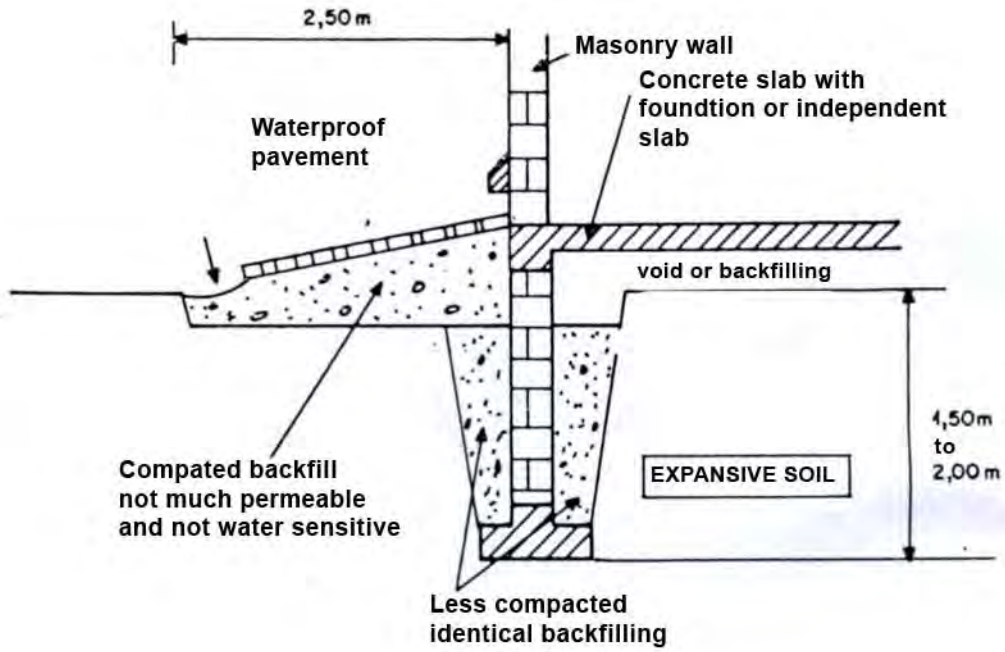

(o)

### **2-5-2 Shallow, strip Foundation**

It can happen that heavy building won't suffer from the heaving effect of black cotton soil. The load they give to the soil may balance its swelling pressure. But to achieve this, most of the time the solution is to build multi storey building. And laboratory calculation will be required to perfectly know about the swell pressure and the volume change zone of the soil in the targeted area. As it is not under the MSF project goals, nor delay, this approach won't be developed in this document.

### **2-5-3 Box type Construction**

In this method, the whole of the structure (walls, foundation and roof) shall be designed as a box strong enough to move as one body with the soil as it heaves.

This technology will require very skilled artisans in concrete work and do not fit with MSF approaches, with the use of steel structure in-fill with masonry.

For these reasons, this approach will not be developed herewith.



## 2-5-4 Slab or Raft Foundation; Stiffened Foundations

The stiffened raft foundation comprises a grid of reinforced concrete beams cast integrally with the floor slab. The building will be erected on top of this slab.

Raft foundation are constructed by forming a level terrace usually above natural ground level, this to promote adequate drainage.

This foundation will act as a whole and so reduces the differential movement of the supporting soil. The superstructure of the building should be able to tolerate the remaining movement. Solid brick work is not recommended unless some joints are provided. Again, the split approaches is recommended to be applied to design the superstructure.

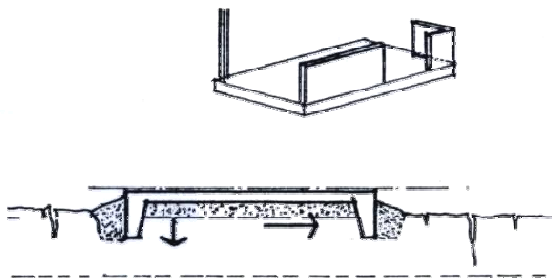

### *Floating- or raft foundation*

Absorbing all forces and loads from the structure, transmitting them uniformly onto the ground.

#### Advantages:

Rigid and self-supporting platform for structure.

#### Disadvantages:

Requires large quantities of reinforced concrete. The reinforcement scheme would have to be designed for all possible load patterns. Very expensive.

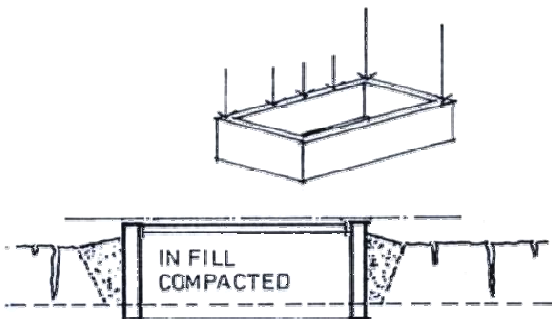

### *Frame foundation, ringbeam*

#### Advantages:

Provides rigid and solid foundation for structure along perimeter.

#### Disadvantages:

Requires large quantities of reinforced concrete and backfill materials. Expensive, time-consuming.

(a)

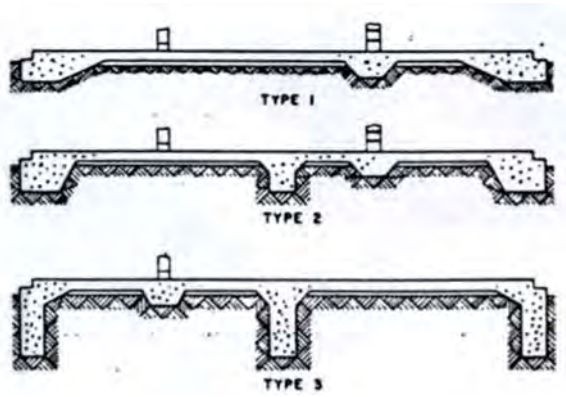

(b)

General illustration of stiffened raft types (Walsh 1974)

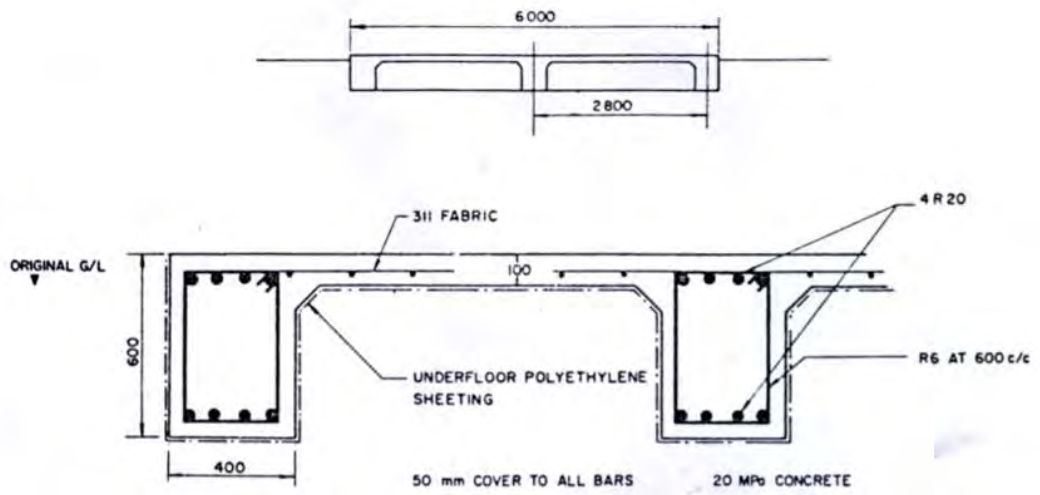

(g)



(e)

**2-5-5 Hard Core Platform Foundation**

This solution can be applied in MSF project as long as hard core to achieve the platform will be available in the area.

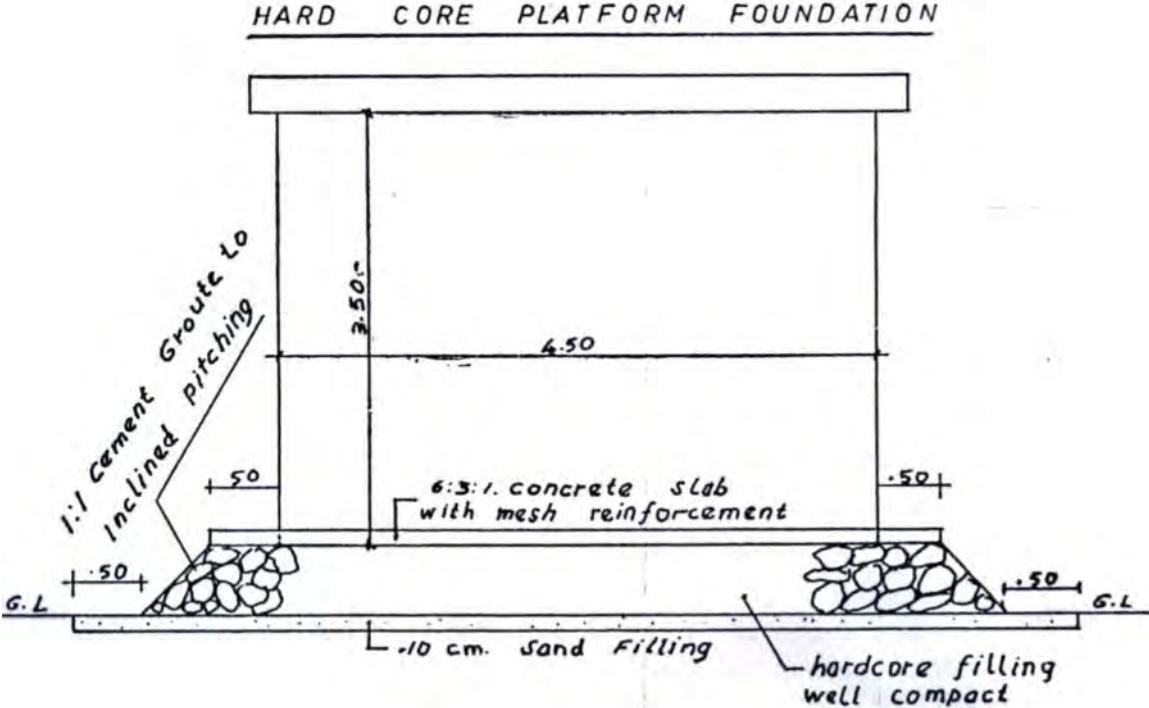

(b)

## 2-5-6 Pile foundation

The principle is to found the building on a zone of no movement. This zone will be where the soil is unaffected by the moisture change after completion of the building.

Building will be founded on piles that will reach the good zone.

These piles can be cast in situ as footing and columns, or footing and masonry, or in bored holes with or without under rammed bases.

These piles will be capped with a ring beam of reinforced concrete that will carry the superstructure load. Special care should be paid to avoid this ring beam to be in touch with the ground level. Another special attention should be given to avoid the pile to be subject on vertical forces given by the lateral rubbing between the pile and the soil. Finally, one should take care to avoid the water to be driven straight to the base of the pile through the interface between the pile and the in-fill material.

Some special detail at the base of the piles can be added in order to reduce the risk of uplifting of such foundation.

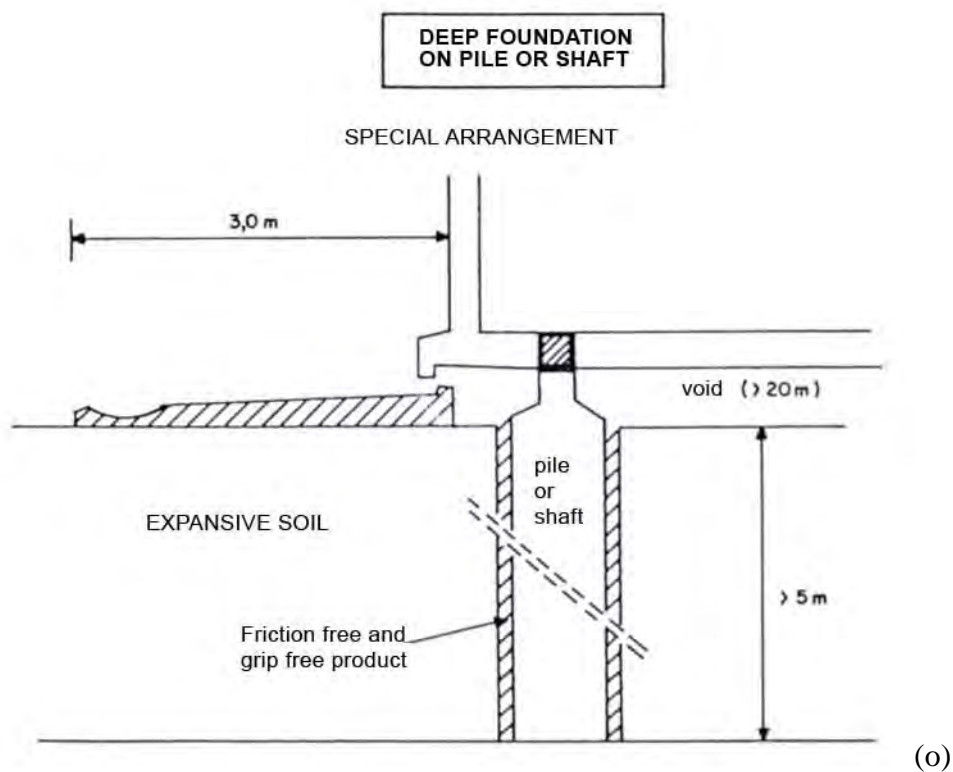

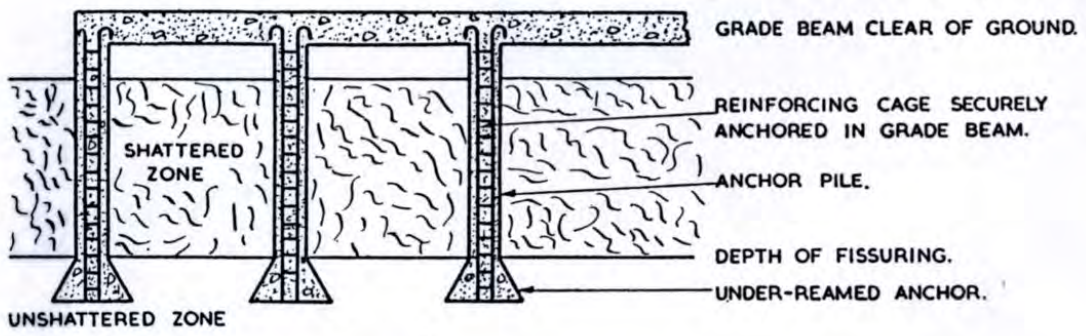

SECTION

(h)



(m)

**2-6 Other approach: to replace black cotton soil by inert material**

**SPREAD FOOTING ON BACKFILLING (= 1.0 m)**

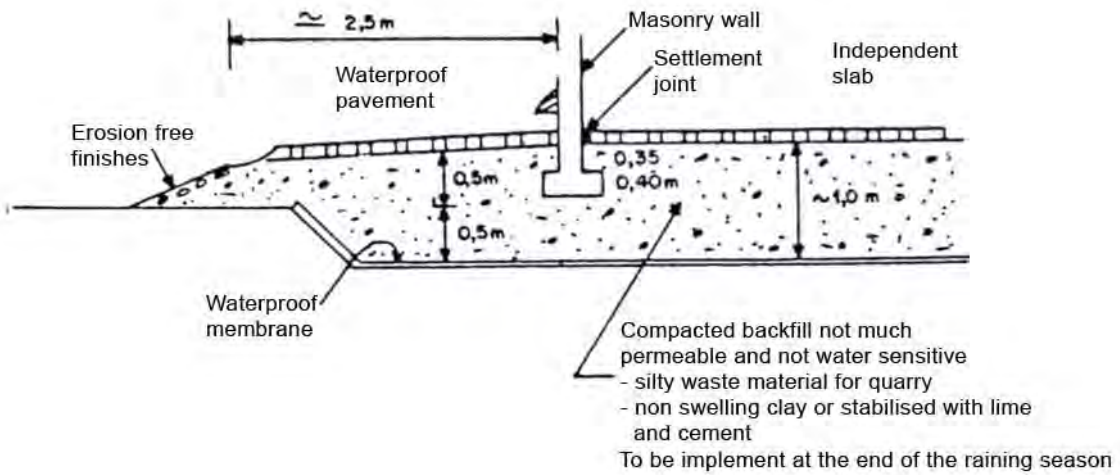

(o)

**RAFT FOUNDATION ON BACKFILLING (= 1.0 m)**  
 Same as above but Raft foundation lightly reinforced and directly put above the backfilling

**SPREAD FOOTING ON BACKFILLING (1.3 - 1.5 m)**

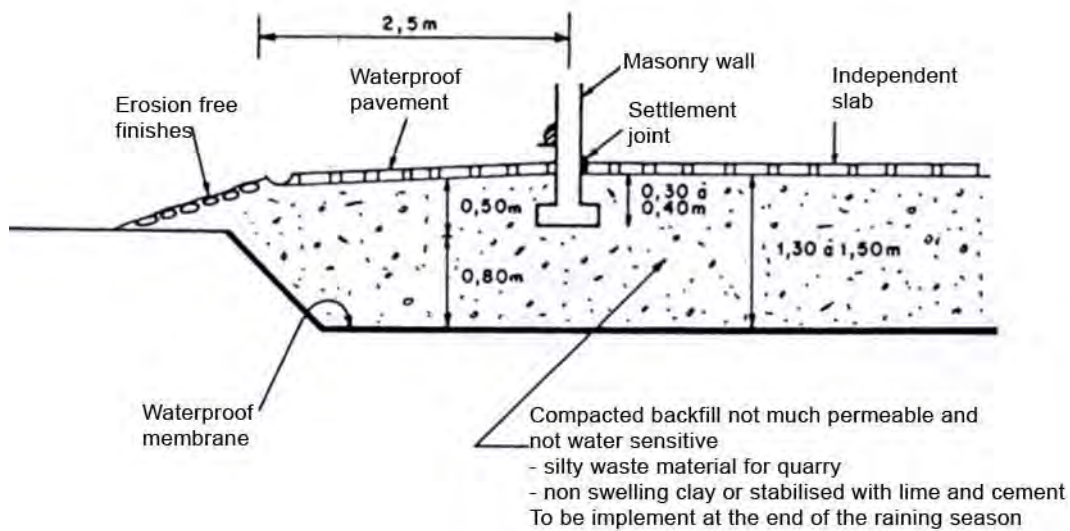

(o)

**RAFT FOUNDATION ON BACKFILLING (= 1.3 - 1.5 m)**  
 Same as above with spread footing lightly reinforced directly on backfilling

**FOUNDATION SLAB ON BACKFILLING AND CRAWL SPACE**

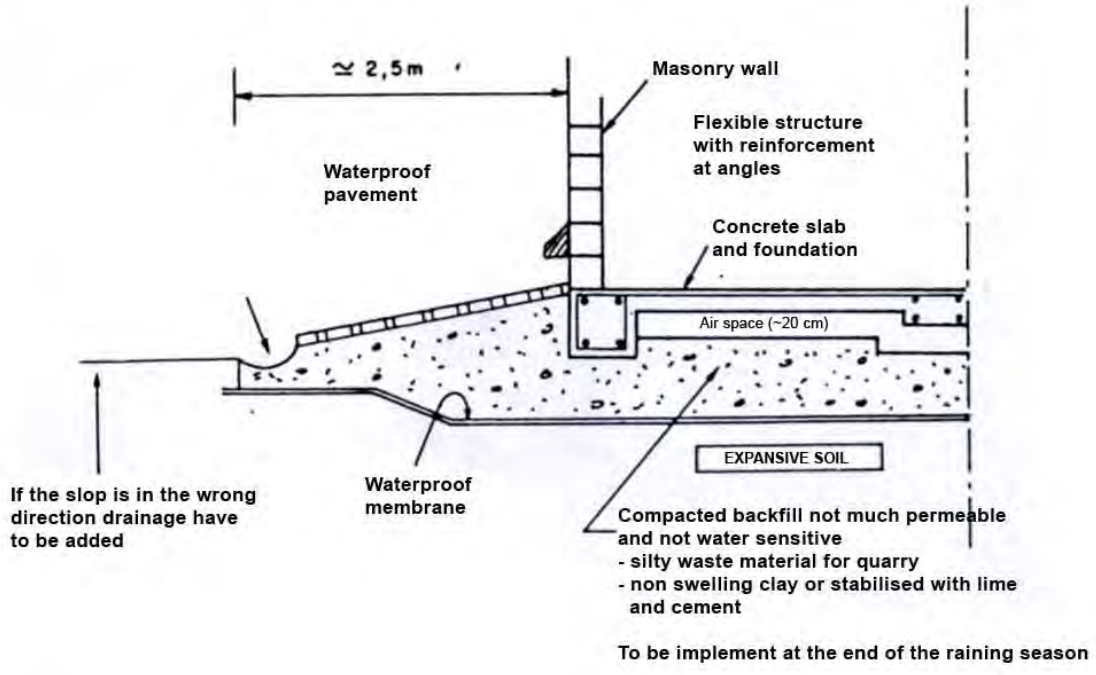

(o)

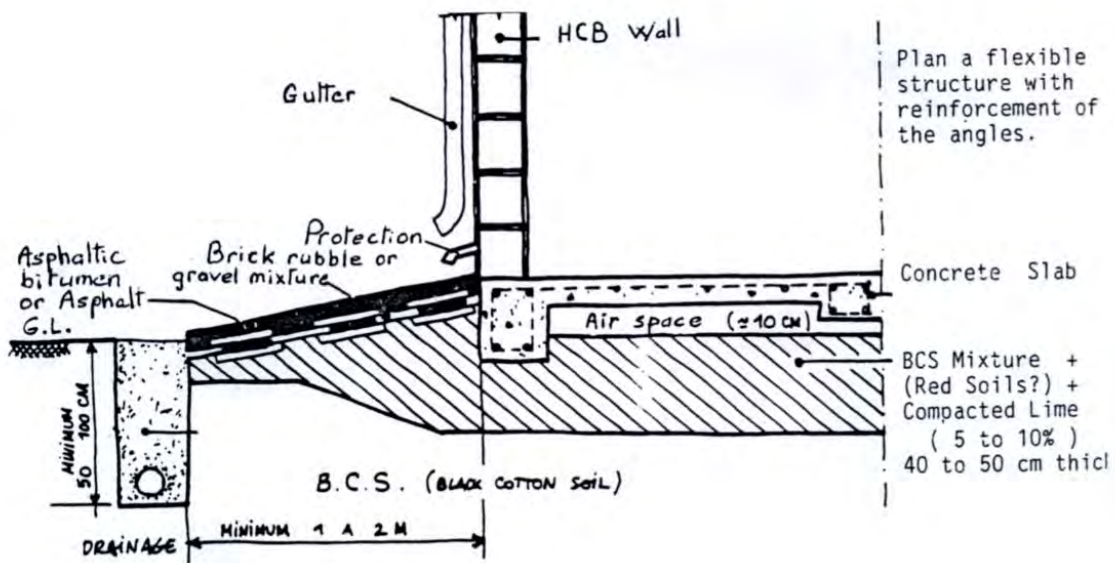

(n)

### 3 SELECTION OF SITE

Proper selection of the building site before construction is of major importance.

- If possible, select a site free of black cotton soil.
- If possible, buildings will be implemented on a land preferably high and slightly sloppy in order to avoid the risks of stagnant water and the over-flow of the rain waters.
- Avoid constructing on a land with too many trees, where roots could affect the construction. No trees of any significant size should be permitted within 10 meter of any building. Trees roots can be as long in any direction as the visible high of this tree. Knowing how high could become a tree will give information on how far the building should be settling from the trees (or how far the trees should be planted from any existing building).
- Do not build close to termites as these would affect the buildings. In presence of termites, the area should be treated to discourage their existence.



## 4 ORIENTATION OF THE BUILDINGS

The durability of a building also depends on its orientation.

- The dominant winds and the strongest rains come from the East. It is necessary to pay particular attention to this side of the building:

Avoid creating openings on the eastern side of the building and note that it is important to site the position of the building towards the Northern and Southern part according to climatic conditions.

Orientate the small sides of the building toward the East and West. It will reduce the exposition to the dominant rains and reduce the risks of erosion of the building. In this sense, there would be less erosion of wall surfaces and risks of rain waters affecting the walls directly.

Protect well the eastern side with important edge for the roof and good quality for the plastering on the wall.

Pay a special attention of the drainage of the ground surface located on the side of the building facing the main rain.

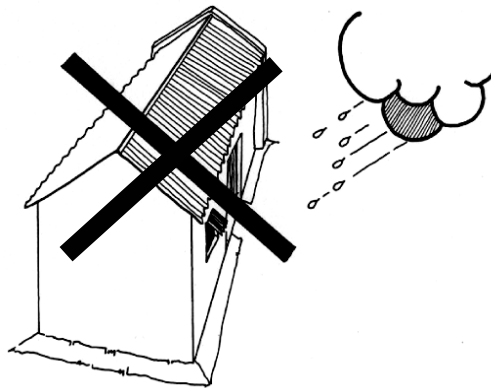

**NO**

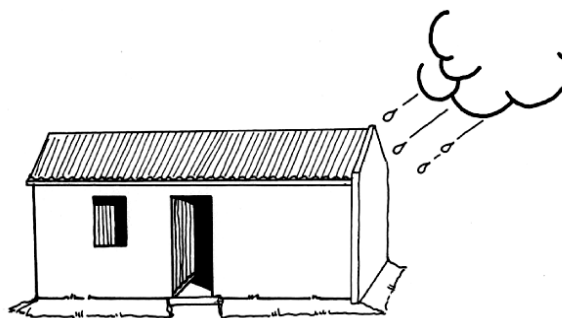

**YES**

- Direct sunshine is stronger at the eastern side in the morning and western side in the afternoon:  
It is therefore better to site the elevation (front) towards north and south with openings (windows and doors). Eastern and western parts should better not be occupied with openings.

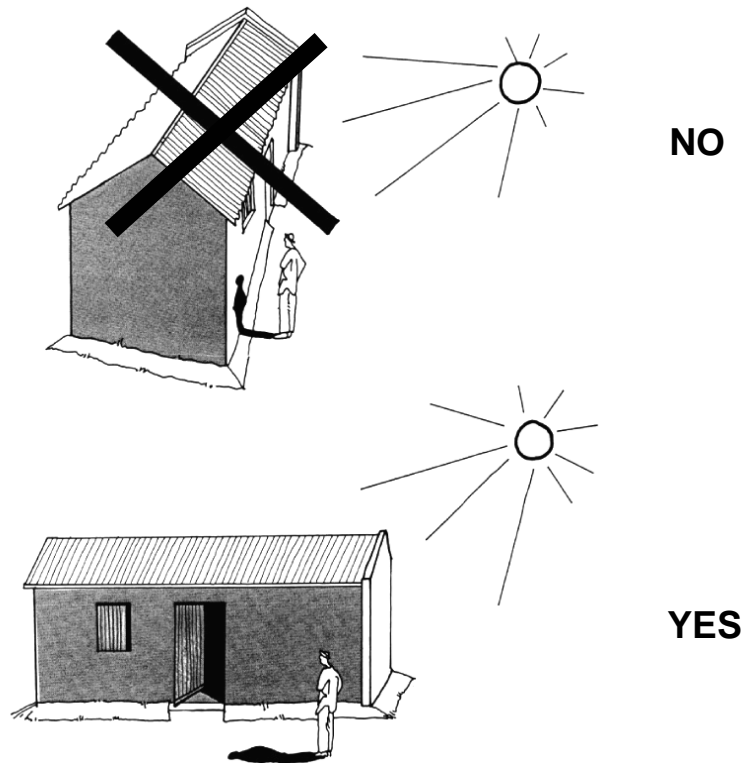

## 5 SITE CLEARANCE

It is necessary to clear the site before any construction:

- Top soil have to be removed up on the whole surface of the building.  
Extra allowance of about 2 meters should be given all over the perimeter of the proposed building.  
The top soil consisting of vegetable matter when cleared could be used for agricultural purposes only, not for construction.
- Remember to remove stones, stumps and roots.  
The presence of organic materials in the site of the building would encourage the presence of termites and rodents around the construction works.  
Clear the site of any ant hill.

## **6 INFILL**

### **6-1 Definition**

The infill is a mass of material provided to raise a land or to fill a hole.

### **6-2 Function**

The infill, or backfill, is essential to protect foundations, basis of the walls and interior of building from water penetration; It needs to reach higher level than natural ground.

### **6-3 Application on Black Cotton Soil**

If possible, nature of raw material used for backfilling will be inert material, not sensitive to water.

If backfilling should be done using Black Cotton Soil, it is important to reduce the activities of this soil before to use it.

This can be achieved by the following method:

- Mixing the Black Cotton Soil with another inert raw material like sand, coarse aggregate, pebble. This will help to give a structure to the resulting backfilling material and will reduce its heaving capacity. Some test will have to be achieved on site (fill a box – for example size of 40 \* 40 \* 40 cm - with a wet mixture; wait for the material will be dried, check the resulting shrinkage, adapt the mixture according to the result obtained. Size of the box should be related to the biggest size of grain contained in the resulting mixture).
- Mix the Black Cotton Soil with lime (range 3 to 7 %) in order to reduce expansiveness of the clay. Lime and soil should be thoroughly mixed to achieve good results.

## 7 FLOOR SLABS

### 7-1 Definition

The slab is a large surface of hard material, generally concrete, used as floor, cover, or artificial soil.

### 7-2 Function

If the slab is independent from the walls, it will just permit to distribute uniformly to the ground the load of people and furniture.

If the slab is not independent from the superstructure, it may help to transmit the load of the building to the ground, but it will allow also to transmit the heaving of the ground to the superstructure.

### 7-3 Application on Black Cotton Soil

Floor directly poured on the original ground level:

If the slab is directly poured on the original ground level and if slab is not part of the foundation system, special attention will be paid to help this slab to move without interacting with the walls or the steel structure. Every single room will need to have its own independent slab.

Ground movement may make the floor to lift up or down. Comfort could be affected by this. Special attention will have to be paid for avoiding the doors to be blocked by a differential change of level between the slabs and the door frame.

Suspended floor:

If slab are independent from the walls, this will avoid any interaction through the slab between the ground potential movements and the building superstructure.

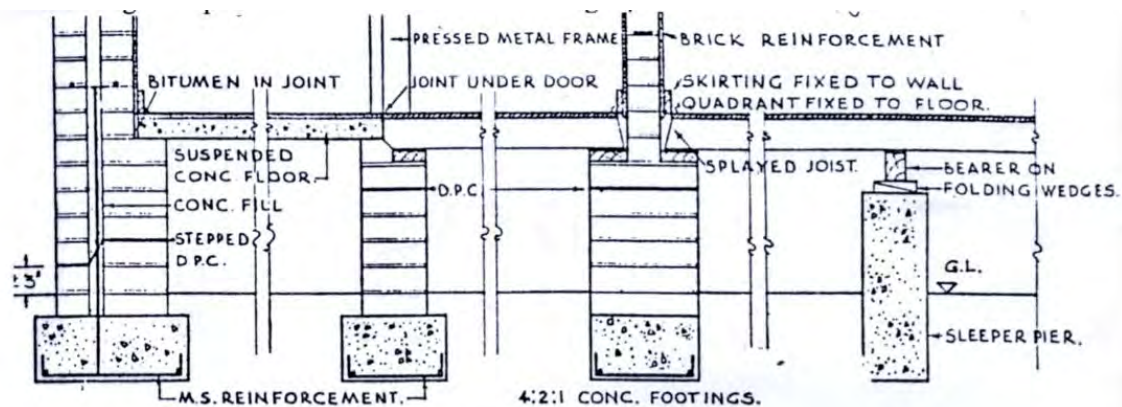

(c)

Suspended floor details – split construction

## 8 BLOCK WORK

### 8-1 Definition

The block work is the part of a building made of blocks (stones or bricks) joined with a binder.

### 8-2 Function

Block work permits to construct thin or thick walls, serving as support or partition.

### 8-3 Application on Black Cotton Soil

#### General

To construct a stable wall, one should respect the following:

- The relation thickness / height of a linear wall made only with masonry must be lower than 1/10. Beyond of that the wall loses its stability
- If this relation is not possible to applied, the wall should be shaped in order to insure its stability.

Wall with  
buttresses  
and angles

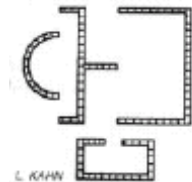

CRATerre

- Stability can also be achieved by introducing pilar (steel, concrete) and ring beams.

### **Blocklaying**

It is the way to assembly and link the blocks between them, in all directions (horizontal, vertical, thickness of the wall).

Joining guarantees stability and solidity of the wall but in the same time may reduce flexibility of these walls.

It joining is provided, it is necessary to respect the following rules:

- The thickness of the mortar joints must not overpass 3 cm (1”).
- Recovery between two bricks from a layer to another must be of minimum 1/4<sup>th</sup> of the brick length

- Mortar characteristics should be as close as bricks one's to permit a homogeneous behaviour of the whole wall under climatic conditions (expansion / shrinkage; moisture movements, etc...).
- Control the horizontal and vertical levels at every course, with spirit levels and lines.
- Do not rise up more than 5 layers of bricks per day.

### Expansion / shrinkage joint

- At the connection between walls and steel structure.

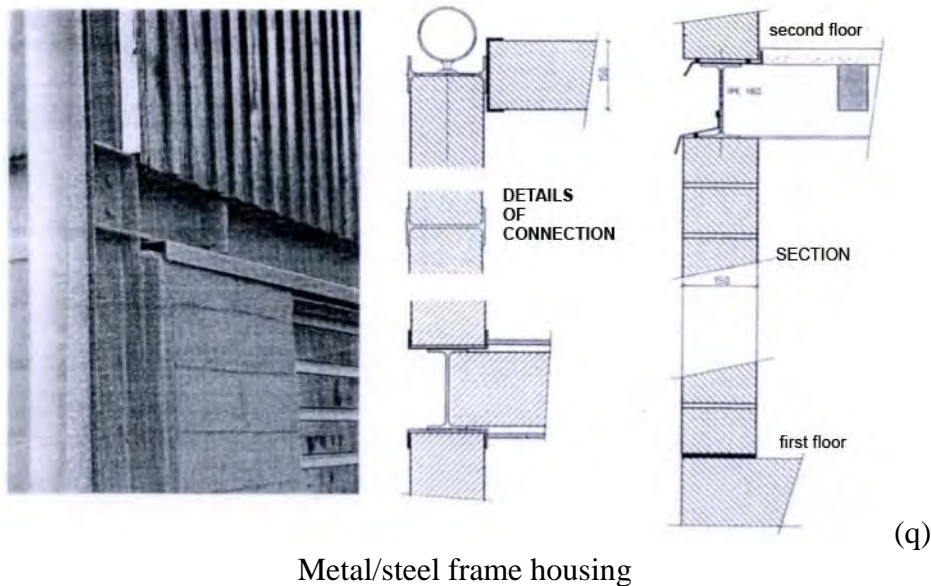

Metal/steel frame housing

Above : photograph, plan and section view of the connection between the frame and the infill CEB masonry wall.

It is important to remember that connection between building material with different characteristics have to be thought in advance and consider through the careful design of details to avoid problems (waterproof, corrosion, differential actions, etc.).

- At door and windows openings
- Between external and internal walls

On top of windows and doors, masonry is disconnected to the other part of the masonry. To facilitate this, here the architect decided to use ventilator bricks to improve aesthetic and answer the necessary needs for air ventilation.



Masonry is not bound between the bottom part of the windows and the pillar between the windows and the door. There is a straight joint. In order to help the stability of the bottom part of the windows, it is liaise to the pillar with some wire mesh integrated in the mortar layer. (r)

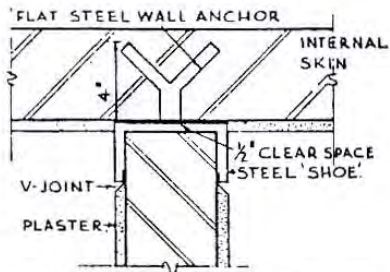

(b) JUNCTION OF INTERNAL TO EXTERNAL WALL.

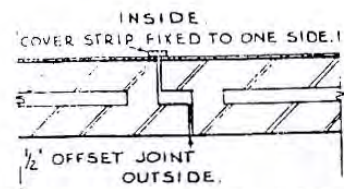

(a) EXPANSION JOINT IN EXTERNAL WALL.

(c)



## **9 RING BEAM**

### **9-1 Definition**

The ring beam is a long concrete, wood or steel piece introduced in the block work, in order to reinforce the structure and to avoid its dislocation.

### **9-2 Function**

The main role of the ring beam is to link walls, to tighten the building in all directions.

To assure its function, and to resist the strengths of traction, the ring beam must be rigid and unalterable.

The ring beam is generally situated in the high part of wall. It can act as support and anchorage for the floors and the roofing, but it can also act as continuous lintel for the openings.

### **9-3 Application on black cotton soil**

Ring beam linking the whole superstructure will not allow any differential movement of the different part of this superstructure.

If architectural design will focus on flexibility (split construction) the positioning of such building component capping the whole structure is not recommended. But each masonry panel can effectively receive an independent ring beam in order to reinforce its self sustainability.

If a complete ring beam is realised, the whole building concept should be thought in order to not allow any flexibility on its structure.

## **10 OPENINGS**

### **10-1 Definition**

The opening is the empty space of a door or a window created in the masonry of the walls.

### **10-2 Function**

The openings permit to illuminate and to ventilate the inside of the building. They represent nevertheless a weak point in the structure of the building. It is often from the openings that appear many cracks. Therefore it is necessary to look after their solidity.

### **10-3 Application on Black Cotton Soil**

#### **10-3-1 Dimensions**

It is necessary to respect some rules in the construction of openings:

- Do not make openings too close one from another (minimum 1 meter).
- Do not place the openings less than 1 meter from an angle of the building.
- Well anchor the lintel in the wall: support it on a minimum of 20 cm inside the wall on each side of the opening.
- Take into account that doors and windows are a weak part of the walls. If it happens that walls will face some deformation, the openings may be blocked by the masonry. It is recommended to introduce some joint between the frame and the masonry, as well as between the frame and the openings.

## **11 ROOFING**

### **11-1 Definition**

The roofing is the cover of a building. The carpentry is the assembling of pieces of wood or metal which sustains the roof.

### **11-2 Function**

The roofing must allow the evacuation of rain waters and preserve the building from humidity and sunshine.

### **11-3 Application on Black Cotton Soil**

#### **11.3.1 Evacuation of water**

- Water should be evacuated from the roofing on the opposite side of the dominant winds to avoid the return of water on the walls, therefore preferably toward west, possibly toward north and south, but never toward east.
- The gutter should be fixed on the roofing edge (not against the wall), should have a large section and a good slope, and should be connected to large drainpipes, which reject water toward a gutter.
- The waterspouts should have a large section, a good slope, and a length of 50 cm to 1 meter out of the wall. They should be oriented westward, but never on top of a window or a buttress. They are made of zinc, galvanized sheet metal, terracotta or treated dug wood.
- The low part of the walls should be protected from splashes and water should be drained toward a gutter.

#### **11.3.2 Roof edges**

The edge of roof has several functions: to reduce the erosion on the top of the wall caused by rain water, to protect the wall from the vertical rain water, to drive the water far from the base of the building, to provide shade.

#### **11.3.3 Anchorage**

The anchorage of the roofing into the wall is indispensable to reduce the risks of distortion and uprising of the roofing under the pressure of strong winds.

## 12 WATER DISTRIBUTION AND EVACUATIONS

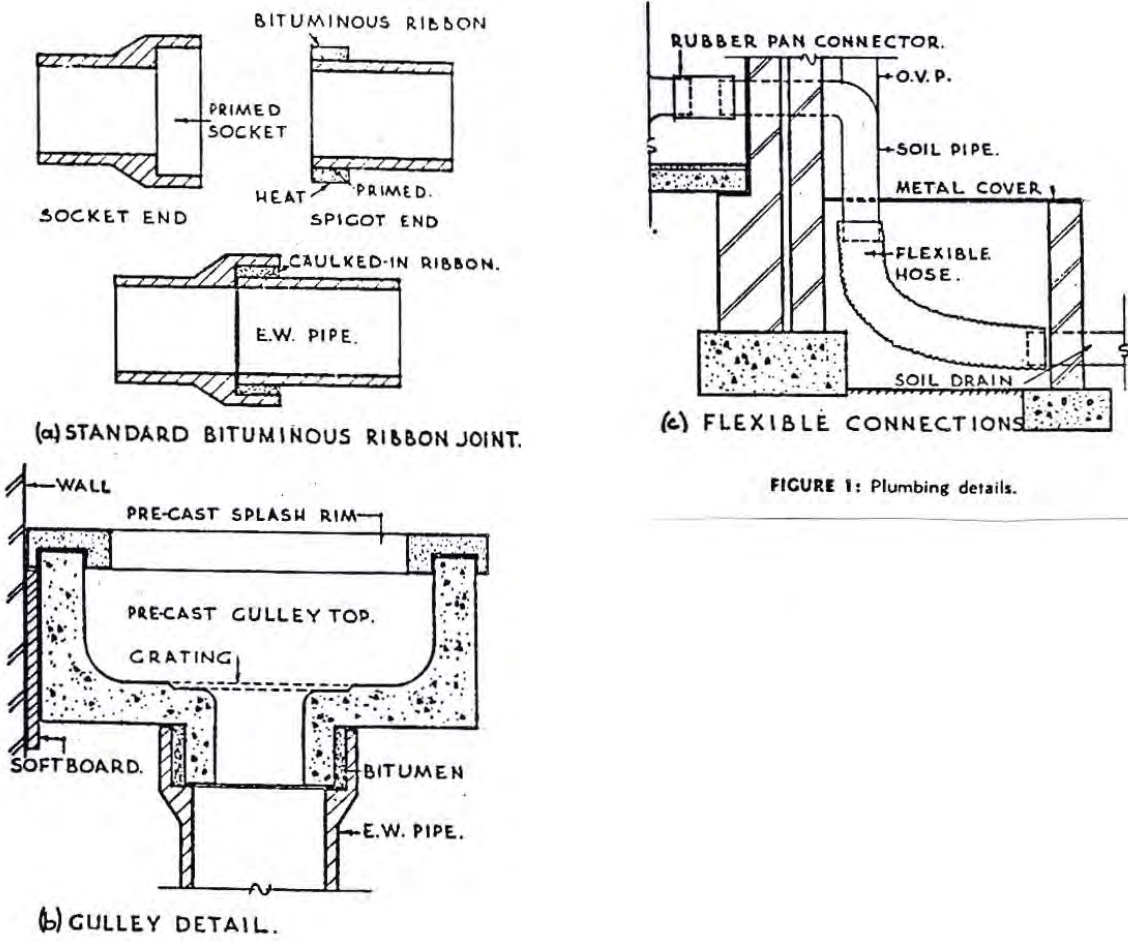
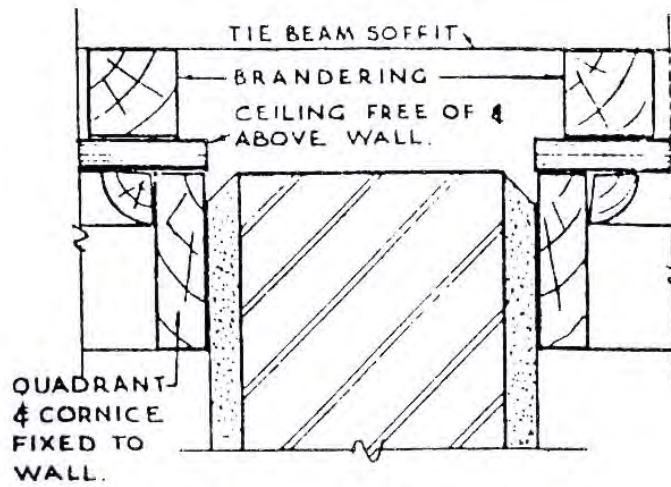

FIGURE 1: Plumbing details.

(c)

# 13 CEILING



(b) INTERNAL WALL AT CEILING

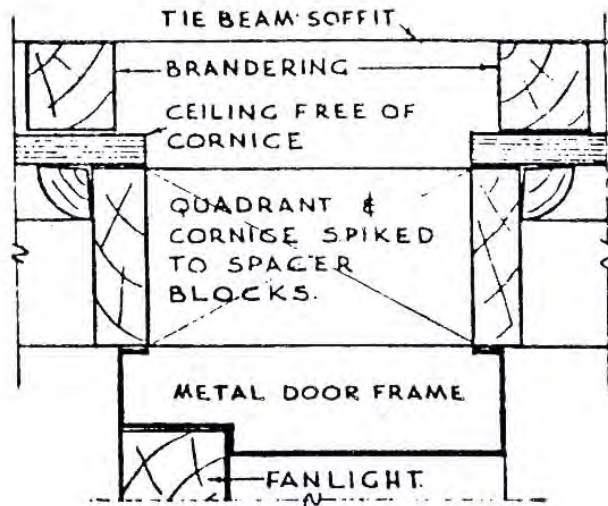

(c) HEAD OF INTERNAL DOOR FRAME

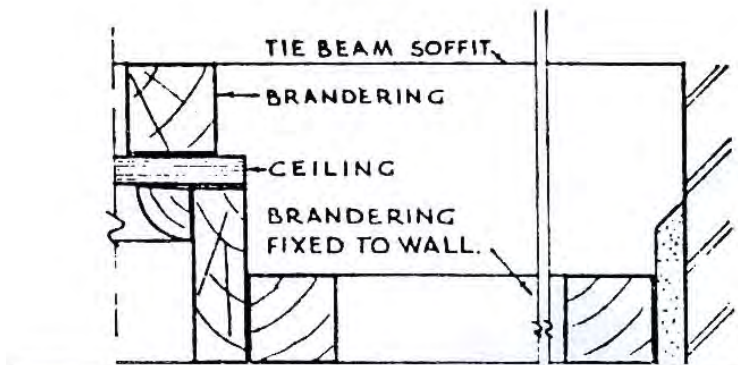

(c)

## 14 VERANDA AND ELEMENTS IN TOUCH WITH THE BUILDING

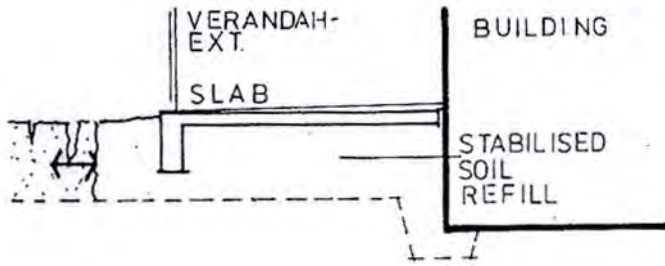

Verandahslabs are often subject to soil movements. They should be separated from the main building by means of flexible joints etc.

(a)

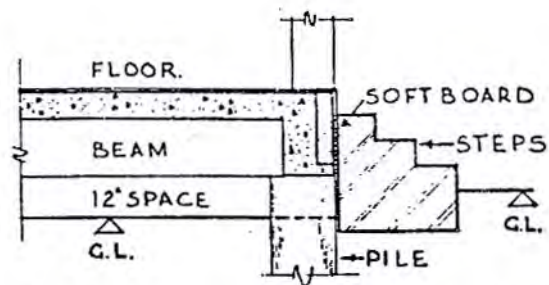

(b) STEPS ADJOINING PILED STRUCTURE.

(c)

# 15 TREATMENT OF SURROUNDINGS

SPECIAL ARRANGEMENTS

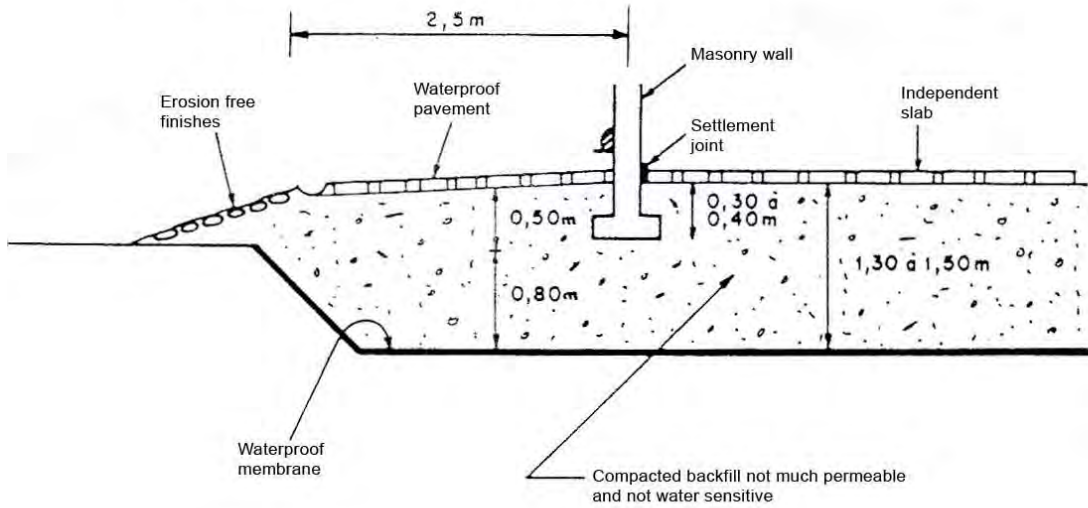

SPECIAL ARRANGEMENTS

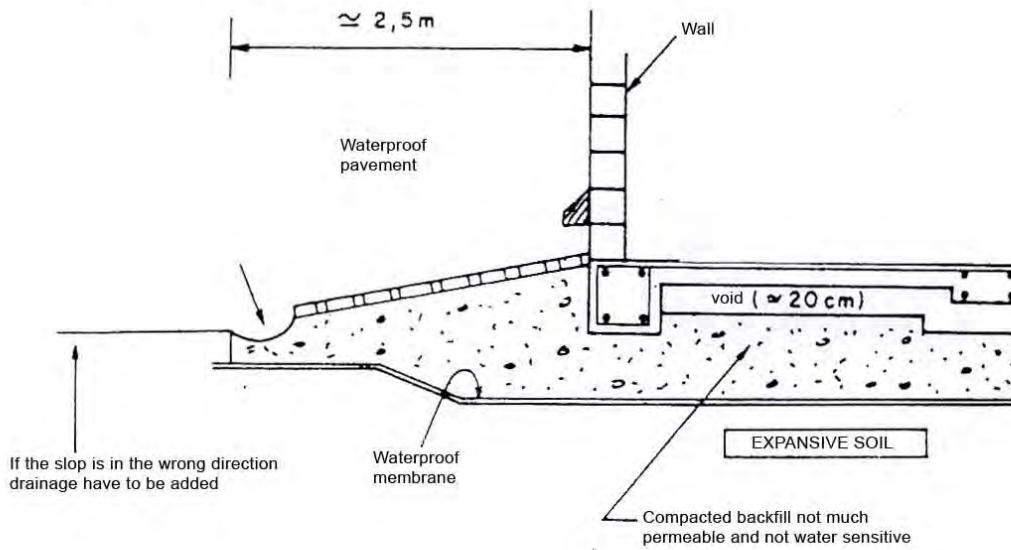

(o)

## BIBLIOGRAPHY

- (a) “Construction and design in remote areas and in black cotton soil in the Sudan”; Report by U. Vogt; UNDP 1980.
- (b) “Foundations on expansive soils”; A.R.A AGIB, National Building Research Station, University of Khartoum (Sudan); 1967
- (c) “Practical procedures for building in expansive soil areas”; J.E Jennings and G.A Evans; Building technology / CSIR; 1962.
- (d) “Foundation option for expansive soils”; J.T Pidgeon; Building technology / CSIR; 1979.
- (e) “The art of building a crack-free house on expansive clay”; A A B Williams; National Building Research Institute of the CSIR; 1984.
- (f) “House on heaving clay in South Africa”; B.W.B Ball; National Building Research Institute of the CSIR; 1985.
- (g) “Expansive soils”; A A B Williams, J.T Pidgeon, P W Day; National Building Research Institute of the CSIR; 1985
- (h) “Foundations for building in the orange free state goldfields”; J.E Jennings; National Building Research Institute of the CSIR; 1950
- (i) “How to avoid cracking in a house to be built on expansive clay soil – a layman’s guide. National Building Research Institute of the CSIR; 1983
- (j) “The design and repair of buildings erected on expansive soils”; V.R Boardman and G.W Donaldson; National Building Research Institute of the CSIR; 1962
- (k) “Guidelines for foundation design of low-rise buildings on expansive clay in Northern Jordan”; T.I Longworth, R Driscoll and I.E.D Katkhuda; 1984
- (l) “Highway and foundations in black cotton soils”; United Nations, economic and social council; 1973
- (m) “Foundations in poor soils including expansive clays”; P.L De; Overseas division, Building Research Establishment, Department of the Environment; 1978
- (n) “Building on expansive soil”; Addis Ababa Project; Igor Kisseleff; 1985.
- (o) “La construction économique sur sols gonflants”; P. Mouroux, P. Margron, J.C. Pinte; BRGM France.
- (p) “Compressed Stabilised Earth Block Manufacture in Sudan”; Doctor E.A Adam; Professor A.R.A Agib; United Nations Educational, Scientific and Cultural Organization. 2001.
- (q) “Mayotte; filière blocs de terre comprimée” ; Gisèle Taxil et Arnaud Misse, SIM / CRATerre ; 1999
- (r) “Earth construction techniques guide”, Maya Pic and Olivier Moles, CRATerre ; Ghana ; 2003