



HAL
open science

Conceptual design studies of unconventional configurations

Michael Iwanizki, Sebastian Wöhler, Benjamin Fröhler, Thomas Zill, Michaël Méheut, Sébastien Defoort, Marco Carini, Julie Gauvrit-Ledogar, Romain Liaboeuf, Arnault Tremolet, et al.

► **To cite this version:**

Michael Iwanizki, Sebastian Wöhler, Benjamin Fröhler, Thomas Zill, Michaël Méheut, et al.. Conceptual design studies of unconventional configurations. 3AF Aerospace Europe Conference 2020, Feb 2020, BORDEAUX, France. hal-02907205

HAL Id: hal-02907205

<https://hal.science/hal-02907205>

Submitted on 27 Jul 2020

HAL is a multi-disciplinary open access archive for the deposit and dissemination of scientific research documents, whether they are published or not. The documents may come from teaching and research institutions in France or abroad, or from public or private research centers.

L'archive ouverte pluridisciplinaire **HAL**, est destinée au dépôt et à la diffusion de documents scientifiques de niveau recherche, publiés ou non, émanant des établissements d'enseignement et de recherche français ou étrangers, des laboratoires publics ou privés.

CONCEPTUAL DESIGN STUDIES OF UNCONVENTIONAL CONFIGURATIONS

M. Iwanizki ⁽¹⁾, S. Wöhler ⁽²⁾, B. Fröhler ⁽²⁾, T. Zill ⁽²⁾, M. Méheut ⁽³⁾, S. Defoort ⁽⁴⁾, M. Carini ⁽³⁾, J. Gauvrit-Ledogar ⁽⁵⁾, R. Liaboeuf ⁽⁴⁾, A. Tremolet ⁽⁵⁾, B. Paluch ⁽⁶⁾, S. Kanellopoulos ⁽³⁾

⁽¹⁾DLR, Lilienthalplatz 7, 38108 Braunschweig (Germany), Email: Michael.Iwanizki@dlr.de

⁽²⁾DLR, Hein-Sass-Weg 22, 21129 Hamburg (Germany), Email: Sebastian.Woehler@dlr.de, Benjamin.Froehler@dlr.de, Thomas.Zill@dlr.de

⁽³⁾ONERA - The French Aerospace Lab - 92190 Meudon (France), Email: Michael.Meheut@onera.fr, Marco.Carini@onera.fr, stylianos.kanellopoulos@onera.fr

⁽⁴⁾ONERA - The French Aerospace Lab - Toulouse (France), Email: Sebastien.Defoort@onera.fr, Romain.Liaboeuf@onera.fr

⁽⁵⁾ONERA - The French Aerospace Lab - Palaiseau (France), Email: Julie.Gauvrit-Ledogar@onera.fr, Arnault.Tremolet@onera.fr

⁽⁶⁾ONERA - The French Aerospace Lab - Lille (France), Email: Bernard.Paluch@onera.fr

KEYWORDS: Blended Wing Body, Forward Swept Wing, Strut Braced Wing, Tailless Aircraft, Joined Wing, 3-Surfaces, Large Fuselage, Conceptual Design, Overall Aircraft Design, Performance Analysis, MYSTIC, RCE, CPACS, MICADO, Clean Sky 2

ABSTRACT

The potential of unconventional configurations to reduce the fuel consumption of future aircraft is investigated in the European Clean Sky 2 (ITD Airframe) ONERA-DLR project "NACOR" (New Aircraft Concepts Research - Call for Core Partners Wave 1). Two design missions are considered: a short/medium range mission (SMR) based on the requirements of an Airbus A320, and a business jet (BJ) mission. In this paper, an overview of the activities considering the conceptual aircraft design phase including initial high fidelity studies is provided.

1. INTRODUCTION

Following the challenging targets defined in the Flightpath 2050 [1], DLR and ONERA investigate several unconventional aircraft configurations that could reduce the environmental impact of the air transportation in future. A stepwise analysis process is applied in order to cover a wide design space on the one hand, and to allow for deep analyses of the most promising concepts on the other.

At the beginning of the process, a large number of configurations is evaluated with simple methods as expert based rankings. The most promising concepts are selected for more detailed analyses in the next step. In each following step methods with higher fidelity are applied and a downselection of concepts is performed. A generic overview of this process is provided in

Fig. 1. This paper is limited to the conceptual design studies that partially include the results of high fidelity analyses and simulations for some of the configurations.

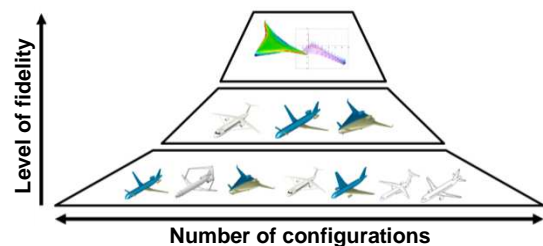

Figure 1: Overview of the evaluation process.

2. OVERVIEW OF CONFIGURATIONS

In this section, a brief overview of the novel configurations discussed in this paper is given. They have been selected based on rough quantitative estimates of the lift-to-drag ratio (L/D) and the operating empty mass (OEM) as a result of an earlier project phase. The assessment work was shared between ONERA and DLR.

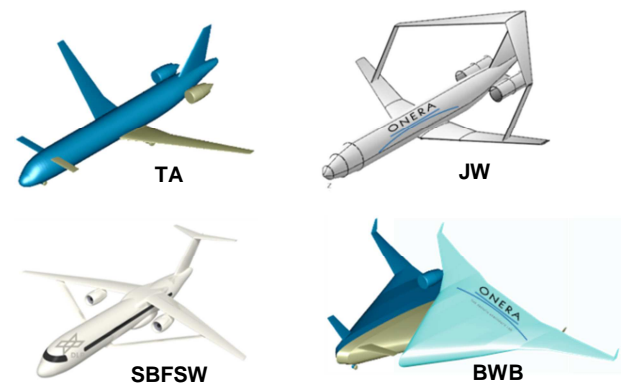

Figure 2: Novel configurations for SMR mission.

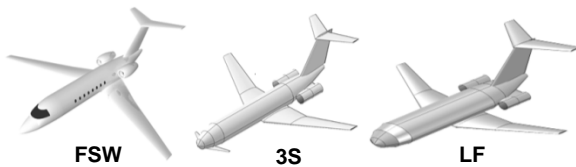

Figure 3: Novel configurations for BJ mission.

For the SMR mission, four concepts are investigated: the “Tailless Aircraft” (TA), the “Joined Wing” (JW), the “Strut Braced Forward Swept Wing” (SBFWS), and the “Blended Wing Body” (BWB), that is referred to also as the “Alternate Blended Wing Body” (aBWB), if it is equipped with a canard. These are shown in Fig. 2. In Fig. 3, the concepts for the business jet mission are depicted: the “Forward Swept Wing” (FSW), the “Three Surface Aircraft” (3-S), and the “Large Fuselage” (LF).

3. DESCRIPTION OF TOOLS

In this section, the tools applied in the scope of this work are described. Both, ONERA and DLR utilize their own tools. But also for different configurations different tools were applied. In order to ensure the comparability of results, the tools were calibrated and validated utilizing identical baseline configurations.

3.1. Aircraft design workflow in RCE

The overall aircraft design workflow embedded in the Remote Component Environment RCE [2] is utilized for the analysis of the TA and the BWB configurations at DLR.

The design workflow covers the range of tools from Level 0 (L0), considering (semi-) empirical methods, over Level 1 (L1), taking into account low level physics based methods, to Level 2 (L2), using high fidelity methods. It also contains a Design of Experiments (DOE) capability and the post processing. The modules implemented are easily exchangeable to adapt the workflow for specific configurations or higher level of fidelity in specific domains, if different methods are needed. To ensure such flexibility the standard data exchange format Common Parametric Aircraft Configuration Scheme (CPACS) [3,4] is utilized to assure a consistent aircraft model throughout all communications between the involved modules. Hence the specific design environment enables a network based design approach also linking tools of the various domains and institutes within the DLR via the xml-based input and output files. For the initial evaluation of the novel TA and BWB configurations solely the low-level part of the workflow (L0-L1) has been adapted and applied.

For the BWB, mass estimation methods were derived and implemented based on previous studies within the European Vela project [5].

3.2. Aircraft design environment MICADO

The aircraft design environment MICADO (Multidisciplinary Integrated Conceptual Aircraft Design and Optimization, which is a licensed product of the ILR of RWTH Aachen University) [6] is used for the design and the analysis of the SBFWS and FSW-BJ configurations at DLR. MICADO consists of loosely coupled modules that represent the major disciplines in the conceptual aircraft design. It utilizes a combination of semi-empirical and low level physics based methods, as e.g. the vortex lattice code LIFTING_LINE of DLR [7]. MICADO also enables to perform automated parameter studies and optimization. The design methodology of MICADO, as provided by Risse in [8], is shown in Fig. 4.

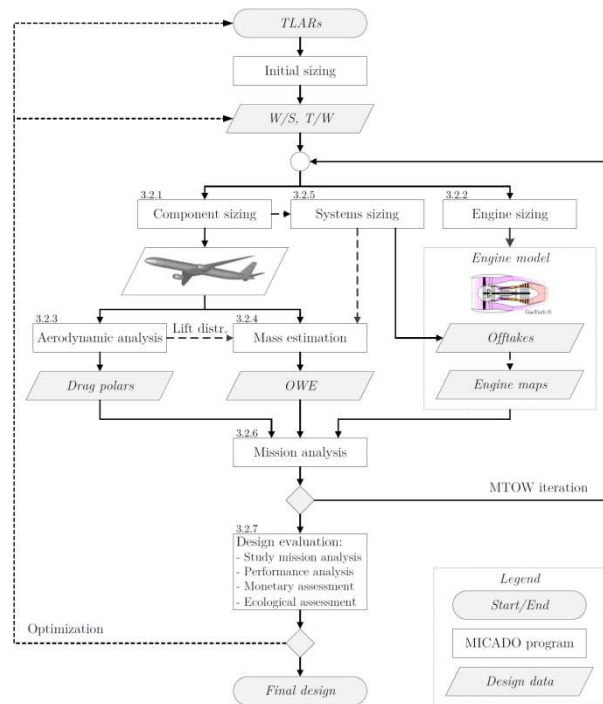

Figure 4: MICADO workflow [8]

For the assessment of unconventional aircraft, additional models for the calculation of masses of unconventional wing configurations from [9] have been introduced. The outcomes from [10] and [11] related to the design and performance of swept wings with natural laminar flow (NLF) have been considered.

3.3. MYSTIC

On ONERA side, to assess the performance of the different concepts for both missions, the

MYSTIC Overall Aircraft Design (OAD) process has been used (Fig. 5). This process was used for all configurations (JW, 3S, LF) except the BWB.

This tool incorporates physical modules for the classical disciplines of Overall Aircraft Design: Propulsion, Aerodynamics, Mass breakdown and balance, Handling qualities, Trajectory and Performance [12].

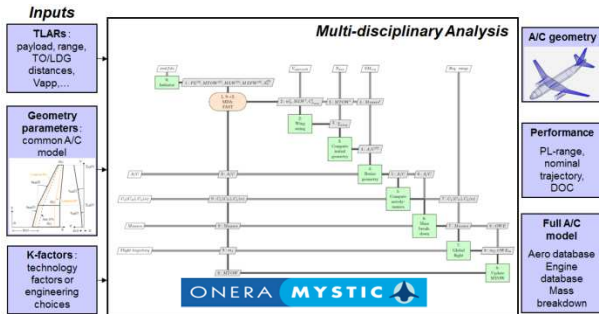

Figure 5: Inputs and outputs of the MYSTIC tool.

Three sizing loops are implemented, allowing the design of an aircraft upon its top level aircraft requirements (TLARs) with iterations on the disciplinary modules (Fig. 6):

- Loop 1: design of HTP and VTP surfaces upon trim and stability HQ criterions at take-off and in cruise, iterating on the Center of Gravity (CG) position,
- Loop 2: iteration on the wing position to ensure a desired static margin, after calculation of aerodynamic center,
- Loop 3: iteration on the maximum take-off weight (updated after OEM and mission fuel calculation) and wing size (to ensure required approach speed and accommodate the mission fuel).

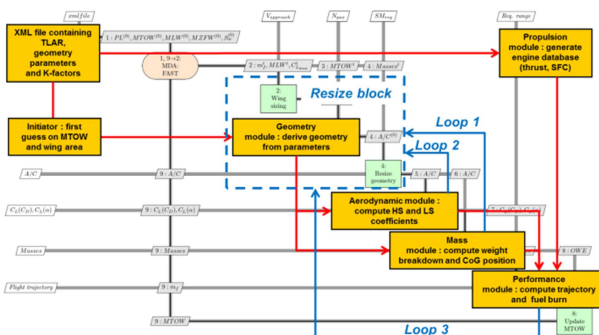

Figure 6: Sizing loops implemented in MYSTIC

The logic of the study is to progressively replace the pre-existing L0 tools in MYSTIC by the higher fidelity modules. They are detailed in [13]. In the present L0 to L2 methods are used depending on the most important disciplinary effects. The

geometrical parameterization is shared among all the modules and enables to generate an OpenVSP CAD model [14] for visualization and disciplinary simulation purposes.

3.4. A dedicated process for BWB - CICA

As a complement to MYSTIC, the evaluation of the BWB configuration on the ONERA side benefitted from a parallel internal effort dedicated to this kind of configuration. The aim of the CICA project is to define a fully integrated process to parameterize, evaluate and size a BWB concept, using relevant disciplinary modules. The process [15] uses similar modules as those described in the previous section, but incorporates specific features relevant for a BWB configuration:

- A cabin sizing module enables to fully describe the seats arrangement into compartments, depending on the sweep angle and payload description. An illustration is given on Fig. 7;
- A dedicated L1 mass module based on mixed empirical and FEM formulations adapted to the structural concept of the BWB provides a good estimate of OEM and CG position;
- A specific L0 aerodynamic module, fine-tuned with CFD results, enables a quick evaluation of the aerodynamic performances on the whole flight domain.

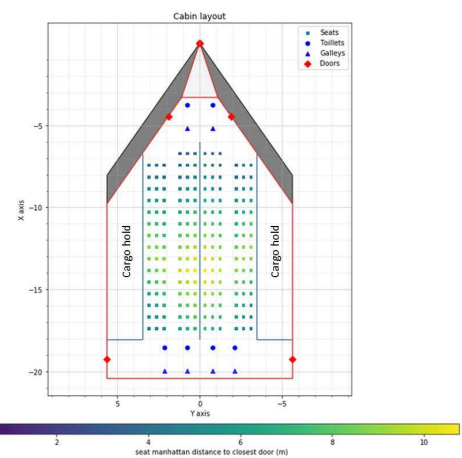

Figure 7: Cabin layout of the CICA process

4. ANALYSES AND RESULTS

In this chapter, the analyses and the results related to the individual configurations are described.

4.1. Business jet configurations

In this section, the activities related to the business jet configurations are summarized. First, the reference configurations are presented. Then, the novel configurations are described.

4.1.1. Reference configuration

The baseline for the business jet mission (LSBJ – Low Speed Business Jet) has been provided by an industry partner. The corresponding design mission is shown in Tab. 1. This baseline has been used by ONERA and DLR for the validation of their tools. For ONERA, disciplinary modules with different fidelity have been used but the comparisons are always achieved with the same level of fidelity for the reference and the unconventional configurations. At DLR, the adapted MICADO workflow has been used, as described before.

Table 1: Design mission for the business jet.

Design range	2900 NM
Mach cruise	0.75
PAX	12
Initial cruise altitude	41,000 ft

4.1.2. Forward swept wing

The forward swept wing (FSW) enables to achieve NLF at high Reynolds numbers [10]. For the evaluation of this technology on a business jet, three FSW variants considering different assumptions regarding the extent of NLF are investigated. Carbon fiber reinforced polymer (CFRP) is used as the material for all forward swept wings. Also, an improved conventional configuration with a backward swept CFRP wing is designed, and an additional configuration with a backward swept (BSW) CFRP wing for NLF is introduced. An overview of all concepts, including the conventional reference BJ-2000, is shown in Fig. 8. For these studies the wing span constraint of 24 m [16] has been applied.

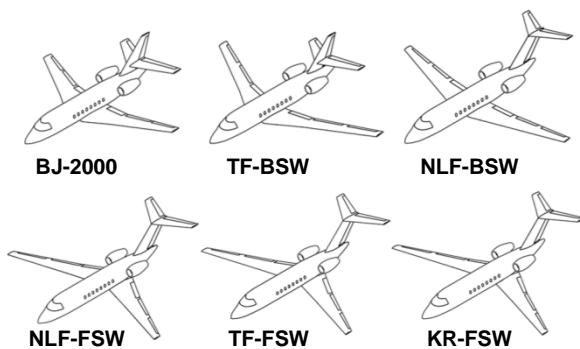

Figure 8: BJ concepts for the evaluation of FSW

For the first FSW variant (NLF-FSW), a permanent NLF up to 50% of the local chord at the upper and lower wing side is assumed. This represents the optimistic case. The second FSW variant (TF-FSW) is designed for the same extent of NLF but carries additional fuel to fulfill the

design mission also without NLF. This represents a more conservative case in terms of operations. The third FSW variant (KR-FSW) is equipped with a Kruger-flap that serves as a high lift and shielding device as in [11]. At the same time, NLF only on the upper wing side is assumed.

Two additional configurations with backward swept wings are considered. The TF-BSW incorporates a high aspect ratio CFRP wing with turbulent airfoils. This represents a conservative aerodynamic design utilizing advanced materials. The NLF-BSW concept is equipped with a backward swept wing and NLF airfoils. The assumed extent of NLF is 50% of the chord at the upper and lower side of the wing as for the NLF-FSW. This configuration represents an optimistic advanced aerodynamic design with a backward swept wing utilizing advanced materials.

The application of the NLF on a backward swept wing for the BJ is only possible due to the small size of the aircraft, the high flight altitude and a comparably low Mach number. These aspects lead to a low Reynolds number thus enabling the NLF at moderate sweep angles according to [18]. Due to the low Mach number of 0.75, the small sweep of the wing does not significantly increase the wave drag. The choice of the leading edge sweep angle of 18° is based on the studies performed by Kruse et al. in [10] and the correlations provided by [17] and [18]. All NLF configurations suffer from the reduced maximum lift performance of airfoils. The negative sweep of the wing in addition reduces the efficiency of the trailing edge high lift devices [19].

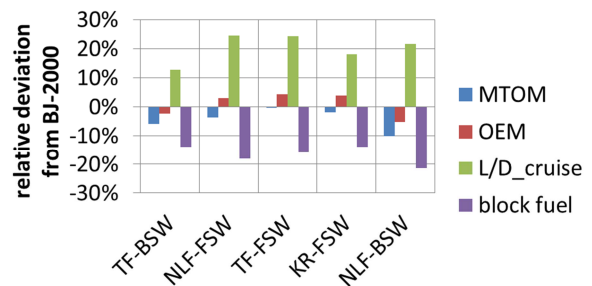

Figure 9: Comparison of BJ configurations

All BJ configurations have been optimized with respect to the wing loading, wing span and thrust-to-weight ratio. In Fig. 9, the final comparison of maximum takeoff mass (MTOM), OEM, L/D-ratio in cruise, and the block fuel mass are summarized. It shows that the TF-BSW configuration without NLF already provides a benefit of 14% compared to the BJ-2000 due to a high aspect ratio CFRP wing. The KR-FSW

configuration shows a similar performance benefit. Here, the mass penalty of the FSW alleviates the reduced viscous drag. The TF-FSW configuration offers a benefit of 16% when operated at NLF conditions. The NLF-FSW configuration, the most optimistic NLF concept, indicates a benefit of 18%. But the NLF-BSW exceeds this value by additional 3%. This advantage is brought by the significantly reduced drag due to NLF combined with the lower mass of the BSW compared to the FSW. As mentioned before, the small size and the comparably low design Mach number are decisive for the application of NLF combined with a BSW at this aircraft.

4.1.3. Three surface aircraft

One of the key design drivers for the 3S configuration is the trade-off between aerodynamics and handling qualities. In order to define the best compromise between these two disciplines, a specific design process has been set-up. For the sizing of the different control surfaces, a dedicated module integrating two optimization loops has been developed and integrated in the MYSTIC OAD process. With the two horizontal control surfaces available on the 3S, an infinite number of configurations satisfying all handling quality constraints can be defined. The two optimization loops aim at defining the most efficient configuration in terms of performance. The first loop targets to optimize both horizontal tailplane (HTP) and canard areas based on a metric defined from the Breguet formula. The second or inner loop aims at minimizing the induced drag in cruise conditions for a given geometry (fixed HTP, canard and wing areas) by adapting the HTP and canard deflections while ensuring trimming. In this study the aerodynamic performance are computed using L1 method for the induced drag (VLM) and semi-empirical formulation for the friction and compressible components.

In order to understand the key design parameters for this configuration, a first parametric study has been performed. The area of the canard and both HTP and canard deflections have been optimized for different wing positions. In this first design step, the HTP area is fixed and approximately equal to 2/3 of the HTP area on the reference configuration. This first step aims at validating the process but also understand the added-value of the canard when moving the wing without changing other design parameters. Fig. 10 shows the optimized configurations defined for five different wing positions (relative positions of the 25% MAC - Mean Aerodynamic Chord - with

respect to the fuselage length). These five values are 52%, 57%, 62%, 67% and 72%. As expected, the more the wing is located downstream, the smaller the canard is. Fig. 11 details the evolution of the wing, HTP and canard areas for the five wing positions (in % of the reference wing area). For all configurations, the wing is slightly larger than on the reference configuration (at least 2%) due to the MTOW increase (Fig. 12). For the most promising configurations, the sum of the HTP and canard areas is slightly lower than the area of the HTP on the reference configuration.

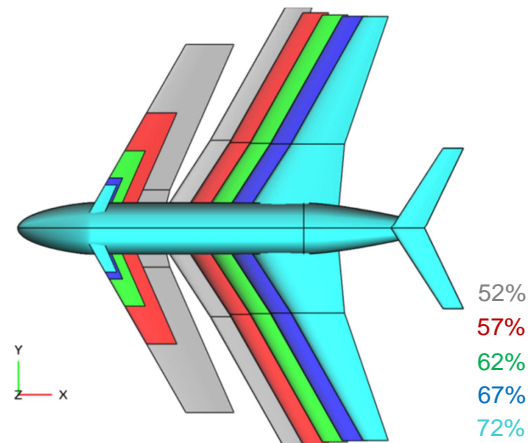

Figure 10: Comparison of 3S BJ configurations (5 wing positions: 52, 57, 62, 67 and 72% of the fuselage length).

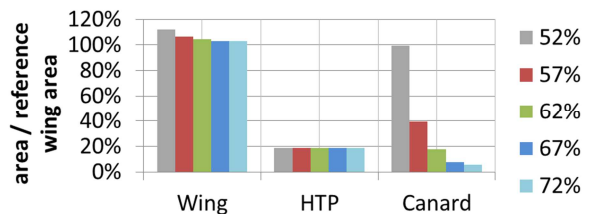

Figure 11: Evolution of the wing, HTP and canard areas for different wing positions (25% MAC).

The performance of the five 3S configurations in terms of MTOM, OEM, maximum L/D and fuel burned are detailed in Fig. 12 (relative deviations compared to the reference).

As expected with a front wing, the performances are poor and the configuration can not benefit from the three lifting surfaces to reduce the drag of the configuration (strong increase of the wetted area and thus of the friction drag). When the main wing is moving back, better compromises can be found. Indeed, the best configuration is when the 25% of the MAC is located at 67% of the fuselage length (blue configuration in Fig. 10). In this case, the area of the canard is reduced leading to a reduced friction drag and the deflection angles of

both HTP and canard are such that the induced drag can be minimized without compressible penalty in transonic conditions. The maximum gain for the maximum L/D ratio is estimated at 9%. These optimistic values would need to be confirmed with higher fidelity tools especially the trade-off between the induced and compressible drag components. In terms of OEM, a small penalty of 2% is observed due to the presence of three lifting surfaces. Overall the MTOM is slightly increased (1%) and this configuration is slightly more efficient in terms of fuel burned than the reference configuration (1.2% of benefits). Moving the wing further back does not enable to further decrease the block fuel. This fuel burned reduction is relatively small compared to the gain achieved on the maximum L/D and the small penalty on the OEM. This is due to the fact that for the 3S configuration the CL corresponding to the maximum L/D increases significantly. Consequently, in cruise the gain in terms of L/D is lower, a factor of 2 is observed compared to the gain on the maximum L/D (between 4 and 5%). This difference explains why the maximum benefit in terms of fuel burned is only around 1.2% for the 67% configuration.

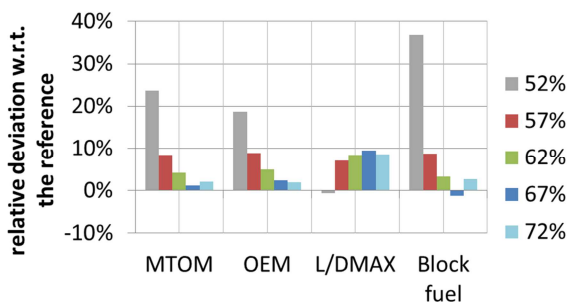

Figure 12: Performance of the 3S BJ configuration for different wing positions (25% MAC).

This first study enables to understand the main design drivers for the 3S configuration. In order to further improve the performance of the configuration additional studies will be performed: optimization of the HTP area; adaptation of the lift coefficient in cruise conditions to really benefit from the strong maximum L/D increase; adaptation of wing twist distributions to further improve the aerodynamic performance.

4.1.4. Large fuselage

For this third configuration, the most important design driver is the evaluation of the mass penalty due to the increase of the fuselage width (at constant length). Two metrics are important for such a business mission: the fuel burned on the whole mission but also per m² available in the cabin. For this purpose a specific mass module

has been developed and integrated in the overall process with dedicated structural layout. The aerodynamic performances have been evaluated using L2 methods (CFD Euler computations) but the impact of the fuselage shape on the pitching moment is assessed using L1 method only (VLM).

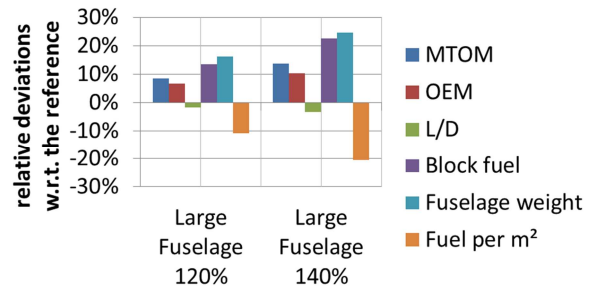

Figure 13: Performance of both LF BJ configurations.

Two configurations with two fuselage widths have been designed to see the trade-off between the different disciplines. The performances of these two configurations are compared to the reference in Fig. 13. Regarding the fuselage weight, as expected a strong penalty is observed, around 15% for the first configuration and 25% for the wider fuselage. This fuselage weight penalty is responsible for an OEM increase respectively by 6 and 10% leading to an increase of the MTOM by 8 and 14%. Moreover, as the wetted area increases with the width of the fuselage the L/D ratio slightly decreases accordingly leading to an aerodynamic penalty of respectively 1.7% and 3.2%. Considering all these penalties, the block fuel increases by 13% and 22% but the fuel burned per m² of floor area decreases significantly (by 11% and 20%) thanks to the strong increase of the cabin area.

4.2. Short / medium range mission

In this section, the configurations for the SMR mission are described and the corresponding results are shown. First, the reference configurations are presented. Then, the novel configurations are discussed in detail.

4.2.1. Reference configuration

The open CERAS CSR-01 database of the RWTH Aachen [20] serves as the common conventional reference configuration. It is utilized for the validation and calibration of tools for ONERA and DLR. On the ONERA side, the ability of the MYSTIC tool to reproduce the results of the CSR-01 upon the same Top Level Aircraft Requirements (TLAR) has been documented in

[15]. On the DLR side, this reference configuration has been successfully recalculated by the both tools, MICADO and the RCE workflow, in the scope of this project.

In order to account for the impact of advanced technologies, an advanced reference, referred to as “EIS2035 reference”, is used by DLR. It utilizes the proposed technologies for the airframe and the engine that are listed in [12] for entry into service in 2035. Furthermore, it was optimized with respect to the wing loading and the thrust-to-weight ratio.

In the following sections, the results obtained by ONERA and DLR for the four configurations are presented and analyzed separately. All these results are compared to the reference configurations presented above, i.e. the CERAS CSR-01 for ONERA (with current technologies), and the EIS2035 reference for DLR (with advanced technologies). The comparison of the novel configurations to the references at the same technology level shows the actual impact of the configurational changes.

4.2.2.Strut braced forward swept wing

The SBFSW concept is intended to enable natural laminar flow (NLF) at the upper part of the main wing. The strut partially compensates the mass penalty of the forward swept wing. Also, its potential contribution to the lift enables a reduction of the area of the main wing. For the wing design, the results from [11] have been used. Therefore, the leading edge sweep of -18° combined with a Krueger-flap as a high lift and shielding device have been chosen. At the trailing edge, the same high lift devices as for the advanced reference have been utilized. The 36 m wing span constraint from [16] is applied for the point designs. In order to evaluate the impact of this constraint, a parameter study has been performed.

A significant disadvantage of the SBFSW configuration is the complex engine integration. Therefore, two variants with different engine arrangements have been considered (Fig. 14): rear fuselage (SBFSW-RE) and wing mounted engines (SBFSW-WE). For the point designs, the optimization of the wing loading and the thrust-to-weight ratio have been performed. Also, an optimization of the lift distribution along with the dimensions of the strut has been conducted. As for the FSW-BJ, the utilization of both, the NLF and the FSW lead to a reduced high lift performance. Maintaining a similar trailing edge high lift system as for the reference configuration,

the wing loading has been reduced in order to meet the take off field length and the approach speed requirements.



Figure 14: Different SBFSW variants

The geometry of the strut strongly depends on the engine location. This is mainly due to the longitudinal stability requirements. An increasing size of the lifting strut reduces the longitudinal stability that causes a backward shift of the whole wing in order to maintain the prescribed static margin. The consequence is an increase in the area of the horizontal stabilizer leading to higher mass and drag. The integration of the engines under the wing reduces this impact mainly due to a balanced mass distribution. But this arrangement also introduces strong geometrical restrictions to the location of the strut-wing junction. It has to be noted that the impact of the wing wake on the engine performance has not been accounted for. Also, the interference drag of the engines mounted between the wing and the strut is not considered.



Figure 15: Comparison of SBFSW concepts

In Fig. 15, the deviations in mass, L/D, and block fuel of the SBFSW configuration from the advanced reference are shown. The benefit of 1% in block fuel consumption for the SBFSW-RE and 3% for the SBFSW-WE concept are identified. The improved L/D ratio due to NLF is the main driver for this advantage. The SBFSW-WE configuration shows also potential mass savings.

The impact of the NLF and interference drag at aircraft level has been evaluated in parameter studies. A strong dependency of the block fuel on both parameters has been found. A study without a wing span constraint showed an additional benefit of about 6% in block fuel consumption for a wing span of 42 m (SBFSW-RE variant).

4.2.3. Tailless aircraft

Due to the challenging design of a tailless aircraft regarding the stability and control aspects, and the high lift performance, two variants of this concept are investigated as shown in Fig. 16. The first concept incorporates a retractable canard and a high aspect ratio wing. The second concept is equipped with a large wing but without any horizontal stabilizers. Both variants are equipped with a vertical tailplane since no other feasible approach to satisfy the stability and controllability requirements could be identified.

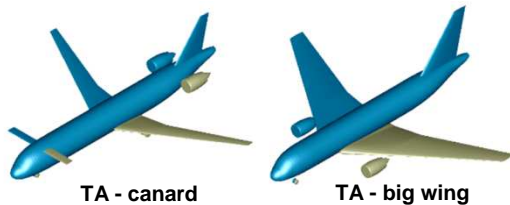

Figure 16: Different tailless aircraft variants

The first TA variant (“canard”) has a retractable canard and rear mounted engines. The canard is extended in the high lift configuration and is retracted in cruise flight. It is sized to counter the flap induced pitching moment. In the retracted position the canard is clinged to the fuselage thus reducing the drag. Reflexed airfoils and the wing twist distribution are adapted to trim the aircraft in cruise condition. Rear mounted engines induce a backward shift of the wing that helps to provide a sufficient lever arm for the canard. The second TA variant (“big wing”) is equipped with a wing sized for take-off and landing without high lift devices. The wing mounted engines are selected to avoid an excessive shift of the CG.

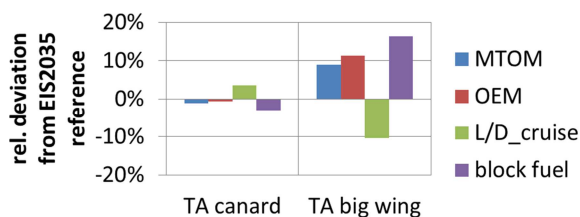

Figure 17: Comparison of tailless configurations

Both TA variants have been optimized in terms of the wing loading and thrust-to-weight ratio. In Fig. 17 the results for both optimized configurations compared to the advanced reference are presented. The “tailless canard” shows a benefit in block fuel consumption of about 4%. One can also observe the improved aerodynamic performance and nearly no deviations in MTOM and OEM. The tailless “big wing” concept requires 16% more block fuel than

the advanced reference. This disadvantage is partially caused by a large wetted area and a small aspect ratio of the wing due to the wing span constraint. Both effects lead to a high deterioration in the L/D-ratio. Also the increased mass of the wing causes a penalty in OEM of more than 10%.

4.2.4. Joined wing

The expected positive impact of the joined wing configuration lies in possible induced drag reduction thanks to the junction of lifting surfaces, and overall weight savings thanks to an increase in wing rigidity. On the other hand, increase of wing areas, potential transonic effects and handling qualities difficulties might counterbalance these positive effects (Fig. 18).

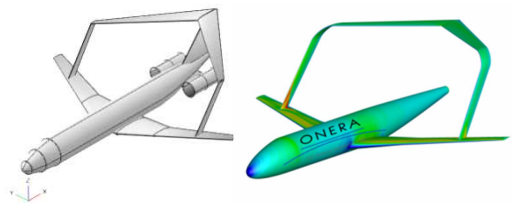

Figure 18: JW configuration at L0 and L2 levels

In order to provide a comprehensive assessment on these effects, a two-step process using the MYSTIC tool was set-up. At first, a literature survey was conducted to extract the most relevant empirical data from previous studies on the JW configuration, and construct parametric L0 models. An aerodynamic module was defined to account for the potential induced drag savings, as a function of the joint position and relative height between the wings. A structural module for the wings arrangement was also extracted from previous FEM studies, depending also on the joint position and the longitudinal span between the wings.

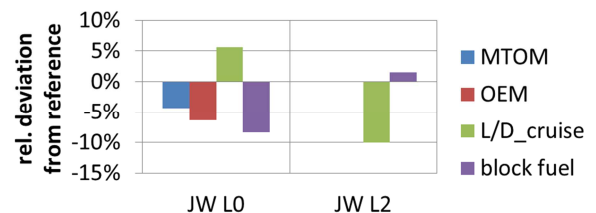

Figure 19: Results of JW configuration

A parametric study was then conducted with respect to aspect ratio, sweep angle, joint position and dihedral angle of the wings, the expected best

parameters were selected, and a L0 sizing loop was performed. This process exhibited very large potential savings (Fig. 19): fuel burn reduced by nearly 10% and MTOM lowered by 4.5%. But as these L0 models seemed rather optimistic, a complementary parametric study with L2 aerodynamics (Euler CANOE toolchain) was conducted and exhibited difficulties to obtain the claimed induced drag savings, especially because of transonic effects at the joint position and a large wetted area. Final results exhibit a 10% decrease in L/D and led to discard this configuration even before refining the mass model that seemed also optimistic.

4.2.5. Blended wing body

The BWB has been investigated by both, ONERA and DLR. In the following sections the corresponding investigations are described.

4.2.5.1. BWB of DLR

The design of the BWB started under the assumption that a canard would improve the overall performance of the concept resulting in a so called "alternate BWB" (aBWB). In the first step, the optimum size of the canard was evaluated. In Fig. 20, the investigated aBWB and the BWB are shown.

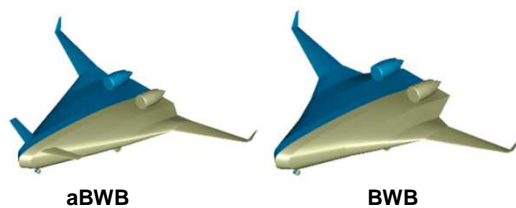

Figure 20: Different (a)BWB variants of DLR

The design of the (a)BWB comprises a single deck configuration with the cargo compartment next to the cabin. The outer shape is defined by a combination of reflexed airfoils at the center body for pitch trim stability and supercritical airfoils at the outer wing in order to generate a near elliptic span wise lift distribution.

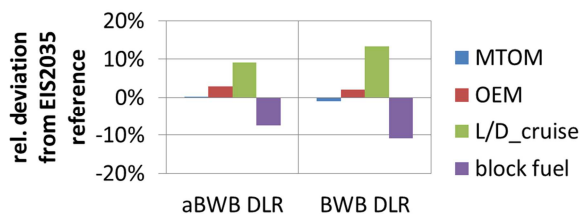

Figure 21: Comparison of DLR's BWB configurations

An optimization of the outer wing for wing loading, thrust to weight ratio and wing span with respect

to block fuel under consideration of the 36 m wing box have been conducted. In Fig. 21, the results for two variants with (aBWB) and without a canard (BWB) are shown. As can be observed, an additional canard indicates no advantage for a transport mission.

In the next step, the sizing methods for the BWB have been improved and the sweep of the outer wing has been optimized with respect to MTOM and block fuel. The leading edge sweep angle of 42.5° has been identified as the most promising to reduce the fuel consumption. The resulting configurations with engines already embedded for BLI is shown in Fig. 22. It has to be noted that the impact of BLI is not considered in these studies.

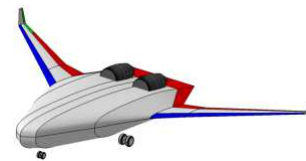

Figure 22: BWB with optimized wing sweep

In Fig. 23, the comparison of the optimized BWB configuration to the advanced reference is shown. Due to its non-circular cabin cross section, the mass estimation of the cabin structure exhibits high uncertainties. Therefore, also a variant with a fuselage mass penalty of 20% is contained in the graph. The BWB point design shows a benefit of 10% in block fuel consumption due to the lower mass and better aerodynamics. Taking into account the mass penalty, still a reduction in block fuel by 7.5%, mainly due to the higher L/D ratio compared to the reference, is achieved.

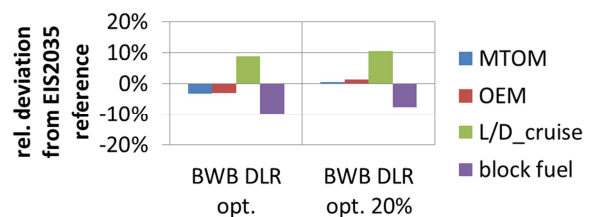

Figure 23: Results of the optimized BWB with and without mass penalty for the fuselage

4.2.5.2. BWB of ONERA

As described in chapter 3, the dedicated CICA process was used to explore the potential of the BWB configuration for SMR missions. The study began by adapting the design choices and models to this smaller BWB, as the process was initially defined for long range missions. The cabin layout was adapted to a 150 passenger arrangement with integration of luggage compartments on the side, the aerodynamic module was used with

higher thickness ratio (t/c) values to accommodate the internal volumes, and a model of the CERAS engine (similar to current VS-2500) was introduced. The structural module using a single shell configuration was used, and a handling quality module enabled to have a clear view on the feasibility of several handling qualities (HQ) constraints (loads on gears on ground, manoeuvre point, trim glide, take-off rotation).

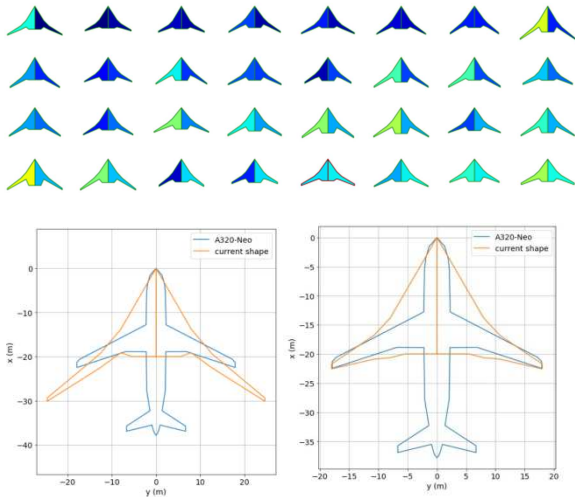

Figure 24: DOE showing fuel burn on the right side and MTOM on the left side (top, blue indicates better configurations), and selected options investigated (bottom, 50m span left and 36m span right)

As the process encompasses more than 40 potential design variables, a sensitivity analysis was conducted to reduce the optimization process to 7-8 main variables related to body and wing sweeps, thicknesses, spans, and top of climb altitude. A design of experiments was then performed to identify the most promising configurations for fuel burn and MTOM reduction, and two solutions representative of the compromise between these objectives were selected (Fig. 24).

Finally, an optimization process using the internal SEGOMOE [21] surrogate-based adaptive optimizer was conducted, with different values of the span constraint. Results (Fig. 25) show that for unlimited span constraint (going up to 50m), a large L/D improvement is possible, which was confirmed with CFD Euler computations (L/D up to 23-24). This translates into a 10% fuel burn saving, and a 3% lower MTOM. However, when limiting the span to 36m, a different compromise is found: the optimizer puts the effort on designing a robust and light structure to maximize OEM savings, with a degraded aerodynamic

performance (L/D less than 18.5-19). This configuration still permits a 3.5% reduction in fuel burn with a 5% lower MTOM.

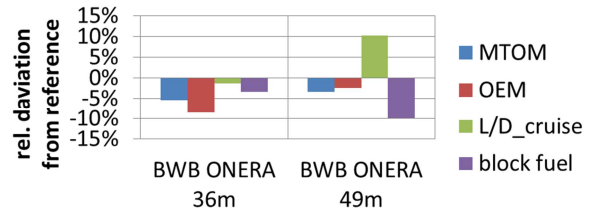

Figure 25: Results of the optimized BWBs

5. COMPARISON OF CONFIGURATIONS

Finally, the comparison of the configurations, considering only the most promising variants of each concept, is depicted in terms of relative deviations from the corresponding references (same assumptions regarding the technology level for the reference and each novel configuration) in Fig. 26 for the BJ mission, and in Fig. 27 for the SMR mission.

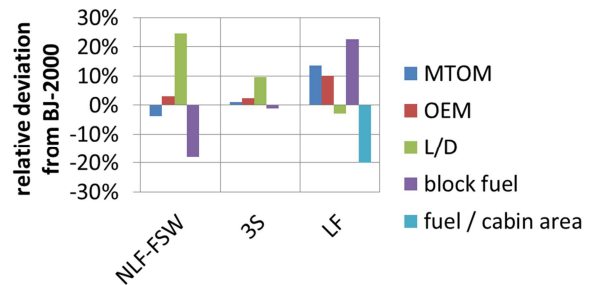

Figure 26: Comparison of novel BJ configurations

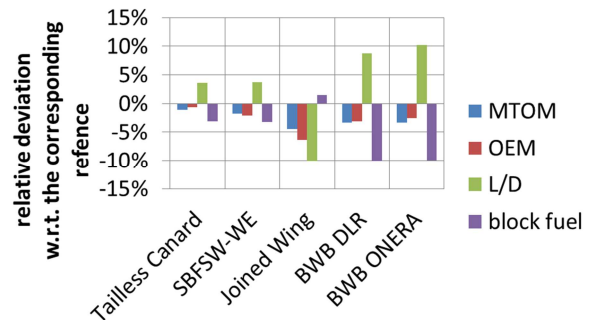

Figure 27: Comparison of novel SMR configurations with the corresponding references

For the BJ mission, one can observe that the NLF technology combined with a CFRP wing offers notable benefits in terms of fuel consumption. For this comparison only the NLF-FSW concept is shown. Nevertheless, it has to be noted that NLF combined with BSW showed even a higher benefit for this design mission. The 3S configuration shows only a minor benefit in terms of block fuel

consumption. The LF configuration does not show any advantages related to MTOM, OEM, L/D or block fuel. But this configuration offers a significantly larger cabin than the other concepts. Therefore, the block fuel per cabin floor area is shown as an additional parameter. The results indicate a benefit of 20%. For other configurations this value is proportional to the deviation in block fuel.

Regarding the SMR mission, the tailless aircraft and the SBFSW concepts show minor benefits in terms of fuel consumption (3%-4%). The joined wing configuration indicates a small increase in block fuel consumption. The BWB concepts are the most promising configurations, both offering a reduction in block fuel consumption of about 10%. Nevertheless, it has to be noted that the BWB of DLR is designed under consideration of the 36 m wing box, while for the BWB of ONERA that is shown in Fig. 27 this constraint is not taken into account. The latter has therefore a wing span of nearly 50 m leading to a higher L/D-ratio, while the BWB of DLR promises a higher reduction in mass.

6. SUMMARY

In this paper, the activities of ONERA and DLR in the scope of the European Clean Sky 2 project NACOR related to the assessment of the potential of unconventional configurations to reduce the fuel consumption of future aircraft are described. Two missions are considered: a short/medium range mission and a business jet mission. An overview of the general evaluation process is given. The configurations considered are shown. The methods applied are described. The analyses and the results for all concepts are presented. A comparison between the novel configurations and the corresponding references is drawn.

The concepts investigated are the joined wing, the strut braced forward swept wing, and the blended wing body for the short/medium range mission. For the business jet mission, the forward swept wing, the three surface aircraft, and the wide fuselage technologies are considered. Conceptual aircraft design methods, partially combined with high fidelity studies, are utilized in the scope of the work. The advanced business jet configurations show a reduction in block fuel of nearly 20% compared to a conventional reference. For the SMR mission, the benefit with respect to block fuel consumption is up to 10%.

7. CONCLUSION AND OUTLOOK

For the business jet mission, one can conclude that in terms of performance the natural laminar flow is a promising technology. Nevertheless, due to the small size of the aircraft and the low design Mach number for the given design mission the utilization of the forward swept wing for this purpose appears not mandatory or beneficial. Especially the mass penalty of the FSW is very disadvantageous. The three-surface configuration shows some potential in terms of fuel burn reduction (1.2%) that could be slightly improved by additional investigations (reduction of HTP area, adaptation of the cruise CL and optimization of the wing twist distributions). Further investigations with higher fidelity tools are also needed to confirm these results and have a more reliable evaluation of the compressibility effects. The wide fuselage does not enable any fuel burn reduction considering the total mission due to important fuselage penalties. But in terms of fuel burned per cabin floor area, a significant reduction can be achieved compared to a classical configuration equipped with a cylindrical fuselage.

For the SMR mission, the tube and wing configurations offer minor or no benefits compared to the advanced reference. The strut braced forward swept wing and the tailless aircraft show a similar result. But the latter configuration suffers from the stability issues in the low speed configuration. The SBFSW shows on the other hand a strong sensitivity with respect to the NLF. The joined wing, at first promising with simplified models, exhibits important transonic effects and large wetted area that prevents from having sufficient L/D performance. The BWB is the most promising concept. But this configuration is especially challenging with respect to the cabin design, mass estimation, and handling qualities. In the next step, the BWB will be further optimized under consideration of high-fidelity methods in order to improve the design, to reduce the uncertainties, and to improve the understanding of this concept.

8. ACKNOWLEDGEMENTS

The project leading to this application has received funding from the Clean Sky 2 Joint Undertaking under the European Union's Horizon 2020 research and innovation program under grant agreement N°CS2-AIR-GAM-2018-2019-01. The authors would like to thank the project partners from Dassault Aviation (Jean Le Gall, Michel Ravachol) and AIRBUS (Lars Joergensen) for their interest in this topic and their guidance.

9. REFERENCES

- 1 European Commission (2011) Flightpath 2050: Europe's Vision for Aviation.
- 2 Seider, D. (2014). Open Source Framework RCE: Integration, Automation, Collaboration. 4th Symposium on Collaboration in Aircraft Design, Toulouse, France
- 3 German Aerospace Center, Institute of System Architectures in Aeronautics (2018) "Common language for aircraft design", Available: <https://www.cpacs.de/>. Retrieved 2019
- 4 Liersch, C.M., Hepperle, M., (2011) "A distributed toolbox for multidisciplinary preliminary aircraft design", CEAS Aeronautical Journal, pp. 57-68
- 5 Hepperle, M. (2005), "The VELA Project", Available: https://www.dlr.de/as/Desktopdefault.aspx?tabid=188/379_read-636/. Retrieved 2019
- 6 Risse, K., Anton, E., Lammering, T., Franz, K., Hoernschemeyer, R. (2012). An Integrated Environment for Preliminary Aircraft Design and Optimization. 53rd AIAA/ASME/ASCE/AHS/ASC Structures, Structural Dynamics and Materials Conference, Honolulu, Hawaii
- 7 Horstmann, K. (1987) "Ein Mehrfach-Traglinienverfahren und seine Verwendung für Entwurf und Nachrechnung nichtplanarer Fluegelanordnungen", DFVLR, Braunschweig, Germany
- 8 Risse, K., (2016) "Preliminary Overall Aircraft Design with Hybrid Laminar Flow Control", Ph.D. dissertation, RWTH Aachen University, see also: Shaker, Aachen, Dec. 2016
- 9 Chiozzotto, G.P. (2017). Initial Weight Estimate of Advanced Transport Aircraft Concepts Considering Aeroelastic Effects. 55th AIAA Aerospace Sciences Meeting, Texas, USA
- 10 Kruse, M., Wunderlich, T., Heinrich, L. (2012) A Conceptual Study of a Transonic NLF Transport Aircraft with Forward Swept Wings. 30th AIAA Applied Aerodynamics Conference, New Orleans, USA
- 11 Seitz A., Hübner A., Risse K. (2019) The DLR TuLam project: design of a short and medium range transport aircraft with forward swept NLF wing, CEAS Aeronautical Journal, pp. 1-11
- 12 Sgueglia, A., Schmollgruber, P., Bartoli, N., Atinault, O., Benard, E., Morlier, J. (2018) . Exploration and Sizing of a Large Passenger Aircraft with Distributed Ducted Electric Fans. 2018 AIAA Aerospace Sciences Meeting, Kissimmee, USA.
- 13 Defoort, S. ,Méheut, M., Paluch, B.,Liaboeuf, R., Murray, R., Mincu, D.-C., David, J.M., (2018), „Conceptual design of disruptive aircraft configurations based on High-Fidelity OAD process”, AIAA Aviation Forum, Atlanta, USA
- 14 www.openvsp.org, retrieved 2019
- 15 Tremolet, A., Gauvrit-Ledogar, J., Brevault, L. , Defoort S., Morel, F., (2019), Multidisciplinary Overall Aircraft Design and Optimisation of Blended Wing Body Configurations, 1 - 4 July 2019, Madrid, Spain
- 16 International Civil Aviation Organization ICAO, (2016), "International Standards and Recommended Practices, Annex 14, Aerodromes, Aerodrome Design and Operations", Montréal, Canada
- 17 Schrauf, G. (2005) Status and Perspectives of Laminar Flow. Aeronautical Journal, vol. 109, No. 1102, pp. 639-644
- 18 Hepperle, M. (2008). MDO of Forward Swept Wings. KATnet II Workshop, Braunschweig, Germany
- 19 Raymer, D., (2006) "Aircraft Design, A Conceptual Approach", 4 ed., American Institute of Aeronautics and Astronautics
- 20 RWTH-Aachen (2017). "CERAS Central Reference Aircraft data System," Available: <https://ceras.ilr.rwth-aachen.de/>. Retrieved 2017
- 21 Bartoli, N., Lefebvre, T., Dubreuil, S., Olivanti, R., Priem, R., Bons, N., Martins, J. R. A. A., Morlier, J., (2019), Adaptive modeling strategy for constrained global optimization with application to aerodynamic wing design. *Aerospace Science and Technology*, 90:85–102,