



**HAL**  
open science

## Physicochemical Properties for the Reaction Systems: Levulinic Acid, Its Esters, and $\gamma$ -Valerolactone

Houda Ariba, Yanjun Wang, Christine Devouge-Boyer, Roumiana Stateva,  
Sébastien Leveneur

► **To cite this version:**

Houda Ariba, Yanjun Wang, Christine Devouge-Boyer, Roumiana Stateva, Sébastien Leveneur. Physicochemical Properties for the Reaction Systems: Levulinic Acid, Its Esters, and  $\gamma$ -Valerolactone. Journal of Chemical and Engineering Data, 2020, 65 (6), pp.3008-3020. 10.1021/acs.jced.9b00965 . hal-02904648

**HAL Id: hal-02904648**

**<https://hal.science/hal-02904648>**

Submitted on 22 Jul 2020

**HAL** is a multi-disciplinary open access archive for the deposit and dissemination of scientific research documents, whether they are published or not. The documents may come from teaching and research institutions in France or abroad, or from public or private research centers.

L'archive ouverte pluridisciplinaire **HAL**, est destinée au dépôt et à la diffusion de documents scientifiques de niveau recherche, publiés ou non, émanant des établissements d'enseignement et de recherche français ou étrangers, des laboratoires publics ou privés.

## Manuscript Details

<b>Manuscript number</b>	JCT_2019_718
<b>Title</b>	Physicochemical properties for the reaction systems: levulinic acid, its esters and $\gamma$ -valerolactone
<b>Article type</b>	Full Length Article

### Abstract

The use of biomass, particularly second generation one, as renewable raw material is crucial to sustain chemical industry. To favor the development of such processes, one needs to make a cost evaluation, which requires knowledge of processes thermodynamics and kinetics. In this paper, different physicochemical property measurements (viscosity, density, refractive index and specific heat capacity) were done for the systems: hydrogenation of levulinic acid or its esters to  $\gamma$ -valerolactone. From these physicochemical measurements, it was possible to extract the ones of the intermediates and perform a thermodynamic model assessment by using Aspen plus. It was found that Hysys Redlich–Kwong–Soave cubic equation of state and Benedict-Webb-Rubin-Starling virial equation state are suitable to describe these chemical systems.

<b>Keywords</b>	Physicochemical properties; thermodynamic model; second generation biomass; levulinic acid; levulinate esters; $\gamma$ -valerolactone
<b>Taxonomy</b>	Thermodynamics, Physical Chemistry, Chemical Reaction Kinetics
<b>Corresponding Author</b>	sebastien levenueur
<b>Corresponding Author's Institution</b>	INSA Rouen
<b>Order of Authors</b>	Houda ARIBA, Yanjun WANG, Christine DEVOUGE, Roumiana Stateva, sebastien levenueur
<b>Suggested reviewers</b>	Tuong-Van Nguyen, Kvetoslav Ruzicka, Brian Elmegaard, Beatriz Giner Parache

## Submission Files Included in this PDF

### File Name [File Type]

Coverletter.doc [Cover Letter]

Highlights.docx [Highlights]

Manuscript\_v3.6.2.docx [Manuscript File]

JCT\_checklist 07 Dec 2017-updated-1.docx [Validation Report]

To view all the submission files, including those not included in the PDF, click on the manuscript title on your EVISE Homepage, then click 'Download zip file'.

## Research Data Related to this Submission

There are no linked research data sets for this submission. The following reason is given:  
Data will be made available on request

Editor

14.09.2019

The journal of chemical thermodynamics

Dear Editor

We are sending you the manuscript

**Physicochemical properties for the reaction systems: levulinic acid, its esters and  $\gamma$ -valerolactone**

Houda ARIBA<sup>1</sup>, Yanjun WANG<sup>1</sup>, Christine DEVOUGE-BOYER<sup>4</sup>, Roumiana STATEVA<sup>3</sup>, Sébastien LEVENEUR<sup>1,2</sup>

<sup>1</sup>Normandie Univ, INSA Rouen, UNIROUEN, LSPC, EA4704, 76000 Rouen, France.

E-mail : [sebastien.leveneur@insa-rouen.fr](mailto:sebastien.leveneur@insa-rouen.fr); fax: +33 2 32 95 66 52.

<sup>2</sup>Laboratory of Industrial Chemistry and Reaction Engineering, Johan Gadolin Process Chemistry Centre, Åbo Akademi University, Biskopsgatan 8, FI-20500 Åbo/Turku, Finland.

<sup>3</sup>Institute of Chemical Engineering, Bulgarian Academy of Sciences, Acad. G. Bontchev str., bl.103, Sofia 1113, Bulgaria.

<sup>4</sup>Normandie Univ, INSA de Rouen, Université de Rouen, CNRS, COBRA (UMR 6014) Avenue de l'Université, Saint-Etienne-du-Rouvray, 76800, France

Keywords: Physicochemical properties, thermodynamic model, second generation biomass, levulinic acid, levulinate esters,  $\gamma$ -valerolactone.

Dr. HDR Sébastien Leveneur  
LSPC-INSA de Rouen  
BP08, Avenue de l'Université  
F-76801 Rouen  
France

Phone: +33 2 32 95 66 54  
Email: [sebastien.leveneur@insa-rouen.fr](mailto:sebastien.leveneur@insa-rouen.fr)  
Fax: +33 2 32 95 66 52

This paper proposes to study the physicochemical properties and thermodynamic of the systems: hydrogenation of levulinic acid and alkyl levulinates to  $\gamma$ -valerolactone by using Ru/C. This reaction is important in industry because these molecules, issued from 2<sup>nd</sup> biomass generation, are considered as platform molecules.

Such information is fundamental for scale-up, cost evaluation or kinetic modeling. There is a lack in the literature concerning these data.

For these reasons, we sincerely hope that the manuscript will be found suitable for Journal of Chemical Thermodynamics.

Sincerely yours

Sébastien Leveueur

Dr. HDR Sébastien Leveueur  
LSPC-INSA de Rouen  
BP08, Avenue de l'Université  
F-76801 Rouen  
France

Phone: +33 2 32 95 66 54  
Email: [sebastien.leveueur@insa-rouen.fr](mailto:sebastien.leveueur@insa-rouen.fr)  
Fax: +33 2 32 95 66 52

## Highlights

- Densities, viscosities, specific heat capacities and refractive indices of levulinic acid, its esters and  $\gamma$ -valerolactone were measured
- Physicochemical properties of the intermediates were evaluated
- Thermodynamic model assessment to represent the evolution of these physicochemical properties.

**Physicochemical properties for the reaction systems: levulinic acid, its esters and  $\gamma$ -valerolactone.**

Houda ARIBA<sup>1</sup>, Yanjun WANG<sup>1</sup>, Christine DEVOUGE-BOYER<sup>4</sup>, Roumiana STATEVA<sup>3</sup>,  
Sébastien LEVENEUR<sup>1,2</sup>

<sup>1</sup>Normandie Univ, INSA Rouen, UNIROUEN, LSPC, EA4704, 76000 Rouen, France.

E-mail : sebastien.leveneur@insa-rouen.fr; fax: +33 2 32 95 66 52.

<sup>2</sup>Laboratory of Industrial Chemistry and Reaction Engineering, Johan Gadolin Process Chemistry Centre, Åbo Akademi University, Biskopsgatan 8, FI-20500 Åbo/Turku, Finland.

<sup>3</sup>Institute of Chemical Engineering, Bulgarian Academy of Sciences, Acad. G. Bontchev str., bl.103, Sofia 1113, Bulgaria.

<sup>4</sup>Normandie Univ, INSA de Rouen, Université de Rouen, CNRS, COBRA (UMR 6014) Avenue de l'Université, Saint-Etienne-du-Rouvray, 76800, France

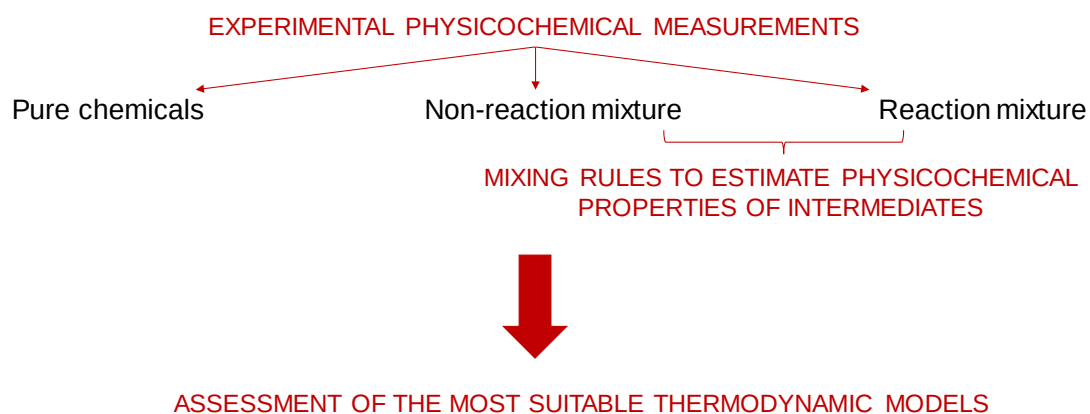
**Abstract:** The use of biomass, particularly second generation one, as renewable raw material is crucial to sustain chemical industry. To favor the development of such processes, one needs to make a cost evaluation, which requires knowledge of processes thermodynamics and kinetics. In this paper, different physicochemical property measurements (viscosity, density, refractive index and specific heat capacity) were done for the systems: hydrogenation of levulinic acid or its esters to  $\gamma$ -valerolactone. From these physicochemical measurements, it was possible to extract the ones of the intermediates and perform a thermodynamic model assessment by using Aspen plus. It was found that Hysys Redlich–Kwong–Soave cubic equation of state and Benedict-Webb-Rubin-Starling virial equation state are suitable to describe these chemical systems.

**Keywords:** Physicochemical properties, thermodynamic model, second generation biomass, levulinic acid, levulinate esters,  $\gamma$ -valerolactone.

## Highlights

- Densities, viscosities, specific heat capacities and refractive indices of levulinic acid, its esters and  $\gamma$ -valerolactone were measured
- Physicochemical properties of the intermediates were evaluated
- Thermodynamic model assessment to represent the evolution of these physicochemical properties.

Graphical abstract:



## 1. Introduction

The use of biomass raw materials for chemical industry can be beneficial from an economic and environmental viewpoint. To make biomass valorization processes possible, one should develop adequate catalysts, design reliable kinetic models and apply thermodynamic models that can predict the physicochemical properties of the reaction mixture under consideration.

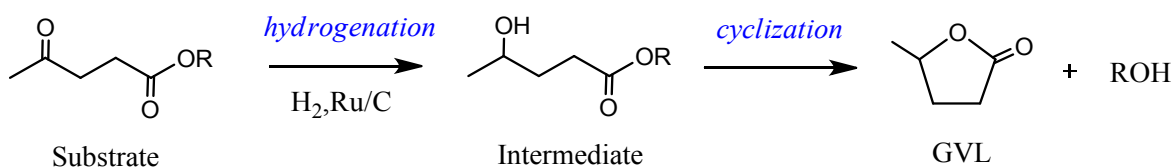
The use of a thermodynamic model is important during energy assessment and cost evaluation of any chemical process [1-2], and as pointed out by Carlson [3] it is not wise to gamble with physical properties for process simulation. Additionally, in general, the models available are originally designed to model the thermodynamics of processes in, what can be called, non-bio areas (e.g. petrochemical processes). However, the simulation and design of a process related to biomass valorization can be considerably more challenging because biomass structure is diverse, much less well defined and difficult to characterize.

Two of the most important parameters characterizing cost evaluation of a biomass process are its CapEx and OpEx. To evaluate those values, one needs to build a process flowsheet applying a process simulator and using data about the process kinetics and thermodynamics.

In the literature till present there are several studies devoted to valorization of biomass from an economical viewpoint [4-14]. For second generation biomass, it was shown that one of the most promising processes is the valorization of levulinic acid to  $\gamma$ -valerolactone applying molecular hydrogen or in-situ produced hydrogen [15-27].

The starting materials for the production of  $\gamma$ -valerolactone (GVL) applying molecular hydrogen can be levulinic acid (LA), methyl levulinate (ML), ethyl levulinate (EL) or butyl levulinate (BL) [28-30]. The reaction mechanism of the process is depicted in Scheme 1.





R: -H, -CH<sub>3</sub>, -CH<sub>2</sub>CH<sub>3</sub>, -CH<sub>2</sub>CH<sub>2</sub>CH<sub>2</sub>CH<sub>3</sub>

**Scheme 1.** Reaction mechanism for the hydrogenation of levulinic acid or its esters to  $\gamma$ -valerolactone.

Knowledge of physicochemical properties evolution with temperature and pressure is essential in chemical engineering for scale-up, energy assessment or cost evaluation. For the hydrogenation of levulinic acid or its esters to GVL, there is a lack of data concerning the evolution of some physicochemical properties such as density, viscosity or specific heat capacity in the literature concerning these molecules [31-33].

The following properties were measured in this study:

- Density, which is important for a correct calculation of reaction volume,
- Viscosity, which plays an important role in mixing and in mass transfer [28],
- Specific heat capacity, which is important in the energy balance,
- Refractive index that can be used for online concentration measurement.

Pokorny *et al.* [31] measured the vapor pressure and specific heat capacity of GVL. Lomba *et al.* [32-33] measured the evolution of density, refractive index, speed of sound, surface tension, dynamic viscosity, static permittivity and vapor pressure for LA, ML, EL and BL. However, these two research groups did neither evaluate the physicochemical data for the intermediates nor recommend a proper thermodynamic model to describe the behavior of these reaction systems.

In view of the above, the goals of this study are to:

- Measure the physicochemical properties of these molecules in pure solution (levulinic acid (LA),  $\gamma$ -valerolactone (GVL), butyl levulinate (BL), ethyl levulinate (EL), methyl levulinate (ML), butanol, ethanol, methanol);

-Measure the physicochemical properties of non-reaction mixture. These non-reaction mixtures are composed of substrates, co-products and GVL (LA+Water+GVL; ML+Methanol+GVL; EL+Ethanol+GVL and BL+Butanol+GVL). The aim of this stage is to verify if the physicochemical properties can be estimated from simple mixing rules.

-Evaluate the physicochemical properties of the intermediates BHP (butyl 4-hydroxypentanoate), EHP (Ethyl 4-hydroxypentanoate), and MHP (Methyl 4-hydroxypentanoate) by using reaction-mixtures. To realize that, experiments for hydrogenation of levulinate esters were performed until the maximum concentration of an intermediate was reached. Then, the physicochemical properties of the solution containing the maximum concentration of the intermediate, named reaction-mixture, were measured. The last step is the evaluation of the pure intermediate by using the simple mixing rules. For LA hydrogenation, the corresponding intermediate HPA (4-hydroxypentanoic acid) is very unstable and it was impossible to evaluate its properties.

-Recommend a thermodynamic model for this studied systems based on the analyses of the agreement between the experimental data measured and the values simulated.

## 2. Experimental section

The standard deviation of the mean was used to evaluate the uncertainty of the measurement

$$S = \sqrt{\frac{\sum_{i=1}^n (x_i - \bar{x})^2}{n-1}} \quad (1)$$

where,  $x_i$  is the experimental value,  $\bar{x}$  is the mean value of these measurements, and n is the number of experimental points. Each measurement was repeated three times.

### 2.1 Materials

Information on the chemicals purchased is given in Table 1. All chemicals were used without any further purification or treatment. The reaction-mixtures containing the intermediates: methyl 4-hydroxypentanoate (MHP) for ML, ethyl 4-hydroxypentanoate (EHP) for EL or butyl 4-hydroxypentanoate (BHP) for BL were prepared under a specific protocol, described in Section 2.2.

**Table 1.** Chemicals used in this study, source and mass fraction purity.

Chemicals	Supplier	Mass fraction
Levulinic acid	Sigma-Aldrich	0.97
$\gamma$ -valerolactone	Sigma-Aldrich	0.99
Methyl levulinate	Sigma-Aldrich	0.98
Ethyl levulinate	Acros Organics	0.98
n-Butyl levulinate	Alfa Aesar	0.98
furfural	Acros Organics	0.99
Ru/C	Alfa Aesar	\
Hydrogen	Linde	0.99999
Methanol	VWR	0.99
Ethanol	VWR	0.99
Butanol	VWR	0.99
Acetone	VWR	0.99

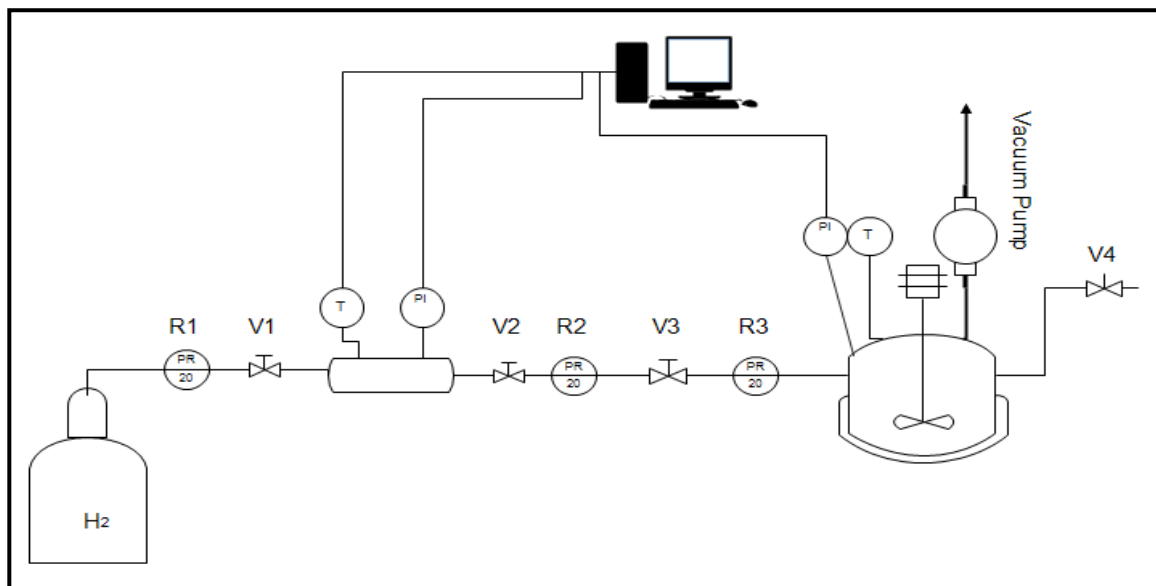
Table 2 shows the composition of the non-reaction mixtures used in this study, namely LA+W+GVL; ML+MeOH+GVL; EL+EtOH+GVL and BL+BuOH+GVL. It should be noted that the reaction compositions displayed are typically used for the production of GVL. Water, methanol, ethanol and butanol are the co-products alongside GVL (Scheme 1).

**Table 2.** Non-reaction mixtures used in this work.

Mixture	Composition
Mix1	10wt.% LA +10wt.% H <sub>2</sub> O+ 80wt.% GVL
Mix2	10wt.% ML +10wt.% MeOH+ 80wt.% GVL
Mix3	10wt.% EL +10wt.% EtOH+ 80wt.% GVL
Mix4	10wt.% BL +10wt.% BuOH+ 80wt.% GVL
Mix5	20wt.% LA +20wt.% H <sub>2</sub> O+ 60wt.% GVL
Mix6	20wt.% ML +20wt.% MeOH+ 60wt.% GVL
Mix7	20wt.% EL +20wt.% EtOH+ 60wt.% GVL
Mix8	20wt.% BL +20wt.% BuOH+ 60wt.% GVL

## 2.2 Preparation of reaction-mixtures containing the intermediates

The experiments were performed in a 300 mL reactor connected to a hydrogen reservoir that is bound to H<sub>2</sub> storage bottle (Fig. 1).



**Fig. 1.** Reactor setup for the production of intermediaries.

The reservoir was filled by hydrogen with gas coming from H<sub>2</sub> storage bottle, regulator R1 and valve V1 were respectively used to control the pressure and the flow-rate. Then, GVL, substrates (ML, EL or BL) and Ru/C catalyst were introduced into the reactor. The mixture was heated to the desired temperature, which was kept constant during the reaction, valve V2 was opened and the pressure was regulated to 20 bar by handling the pressure regulator R2. Then, hydrogen was introduced into the reactor by opening valve V3. Valves V2, V3 and regulator R2 were kept open until the end of the experiment to ensure isobaric conditions. The last step was to fix the agitation speed of the reactor to 1000 rpm. The operating conditions and final composition are summarized in Table 3.

Samples were withdrawn through valve V4. Samples taken during the reaction were filtered, diluted 10 times in acetone using furfural as internal standard, set in vials, then analyzed to identify and quantify the chemical compounds.

To identify the intermediate products (MHP, EHP, BHP) from hydrogenation of ML, EL and BL, GC-MS analysis was used, namely Varian 3900 gas chromatograph coupled with mass spectrometer Varian 2000 and equipped with capillary column (ZB-5ms, 30m × 0.25mm internal diameter × 0.25 μm film thickness). The carrier gas used was helium with a constant flow rate (1.0 mL/ min). The temperature was set at 270 °C for the injector. The temperature program used was 35 °C (3min) - 15 °C/min - 300 °C. The split ratio was 30:1, and the volume injected was 1 μL.

To determine the concentration of the compounds (levulinate esters, intermediate products,  $\alpha$ -valerolactone) in the mixtures, GC-analysis was used, namely Bruker Scion GC436 gas chromatography equipped with flame ionization detector (FID), an autosampler and capillary column (Rxi-5ms, 30m × 0.32mm internal diameter × 0.25 μm film thickness). Carrier gas used was helium with a constant flow rate (1.2 mL/ min). The same temperature program as for the GC-MS was used. The temperature was set at 270 °C for the detector.

**Table 3.** Operating conditions used to produce intermediates.

Substrates	Temperature (°C)	Catalyst amount (dry) g	H <sub>2</sub> Pressure (bar)	Initial conditions			Final conditions		
				GVL mass (g)	Substrate mass (g)	Substrate concentration (mol/L)	Substrate concentration (mol/L)	GVL concentration (mol/L)	Intermediate concentration (mol/L)
ML	140	1.4	20	63.4	62.5	4	0.438	6.484	2.116
EL	140	1.4	20	36.8	82.7	4	0.129	5.57	2.16
BL	140	1.4	20	54.3	69.2	4	0.352	4.702	1.637

### 2.3 Physicochemical measurement and methods

The equipment and methodology applied in this study are analogous to those used previously by our research group and described in details in reference [34].

#### **Density**

DMA 4100 M (Anton Paar, Austria) equipment was used to determine densities with an accuracy of 0.02 °C for the temperature measurement and 0.05 kg.m<sup>-3</sup> for the density measurement. The range of temperature was fixed from (283.15 to 363.15) K for levulinic acid and its esters, while for alcohols, reaction and non-reaction mixtures temperature was fixed between (283.15 and 323.15) K. The lower temperature range was used in order to limit the evaporation and the risk of intermediate ring-closure. Measurements were done three times for each sample and the results were averaged.

#### **Viscosity**

Dynamic viscosities were determined by LOVIS 2000 ME microviscometer (Anton Paar, Austria), the accuracy of viscosity is 0.5 %. As in the density measurements, the range of temperature was fixed from (283.15 to 363.15) K for levulinic acid and their esters. For alcohols, reaction mixtures and non-reaction mixtures temperature was fixed between (283.15 and 323.15) K. A lower temperature range was used for these mixtures to limit the evaporation and the risk of intermediate ring-closure. The measurements were conducted three times for each sample and the results were averaged.

#### **Refractive Index**

Refractive indexes were measured by using Abbemat 300 refractometer (Anton Paar, Austria) with an accuracy of 0.0001 nD. The range of temperature was fixed from (283.15 to 353.15) K for levulinic acid and their esters. For alcohols, reaction mixtures and non-reaction mixtures temperature was fixed between (283.15 and 323.15) K. The measurements were conducted three times for each sample and the results were averaged.

#### **Specific heat capacities**



The specific heat capacities were measured by using a Tian-Calvet calorimeter C80 (Setaram Instrumentation, Caluire, France). The accuracy of the temperature is 0.1 °C, and the accuracy of enthalpy 0.1 %. The range of temperature was fixed from (373.15 to 423.15) K for levulinic acid and its esters; for levulinate esters, alcohols and mixtures the temperature was fixed between (303.15 and 318.15 K). The measurements were conducted three times for each sample and the results were averaged.

### 3. Results and discussion

#### 3.1 Physicochemical measurement of pure solution

The aim of this section is to measure experimentally the values of density, viscosity, specific heat capacity and refractive index of pure solution (LA, ML, EL, BL, GVL, MeOH, EtOH and BuOH) under atmospheric pressure and different temperatures.

##### 3.1.1 Density measurement

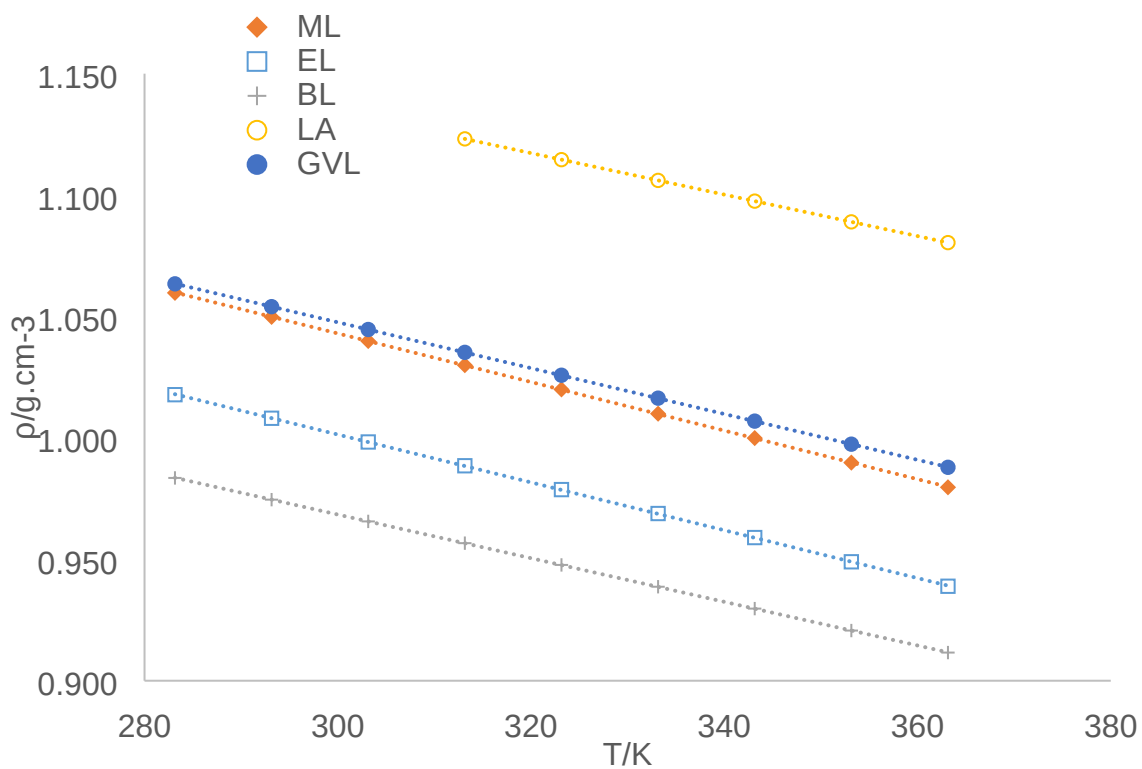
The standard deviation of the mean for each density measurement was found to be lower than 0.73 % showing the high reliability of this measurement. Fig. 2 shows the evolution of LA, ML, EL and BL density with temperature. The linear relationship between density values and temperature can be expressed as

$$\rho = A \times T + B \quad (2)$$

where,  $\rho$  the density ( $\text{g}\cdot\text{cm}^{-3}$ ),  $A$  ( $\text{g}\cdot\text{cm}^{-3}\cdot\text{K}^{-1}$ ) and  $B$  ( $\text{g}\cdot\text{cm}^{-3}$ ) are constants depending on the component used and  $T$  is the temperature (K).

This linear correlation was observed for all pure components with a coefficient of determination ( $R^2$ ) higher than 99.99 %. Table 4 shows the values of constants  $A$  and  $B$  for the pure chemicals. The density of levulinic acid is higher than that of the other chemicals, certainly due to the formation of hydrogen bond.

Our experimental measurement of density was similar to the ones of Lomba *et al.* [32-33] for LA, EL and BL.



**Fig. 2.** Variation of density of the pure compounds *versus* temperature.

**Table 4.** Values of the coefficients A and B for density of pure solution.

	A (g.cm <sup>-3</sup> .K <sup>-1</sup> )	B (g.cm <sup>-3</sup> )	R <sup>2</sup>
Levulinic acid	-0.0009	1.3907	1
Methyl levulinate	-0.001	1.3431	1
Ethyl levulinate	-0.001	1.297	1
n-Butyl levulinate	-0.0009	1.238	1
Gamma valerolactone	-0.0009	1.3308	1
Ethanol	-0.0009	1.0444	0.9999
Methanol	-0.0009	1.07	1
n-Butanol	-0.0008	1.0366	0.9999

### 3.1.2 Dynamic viscosities

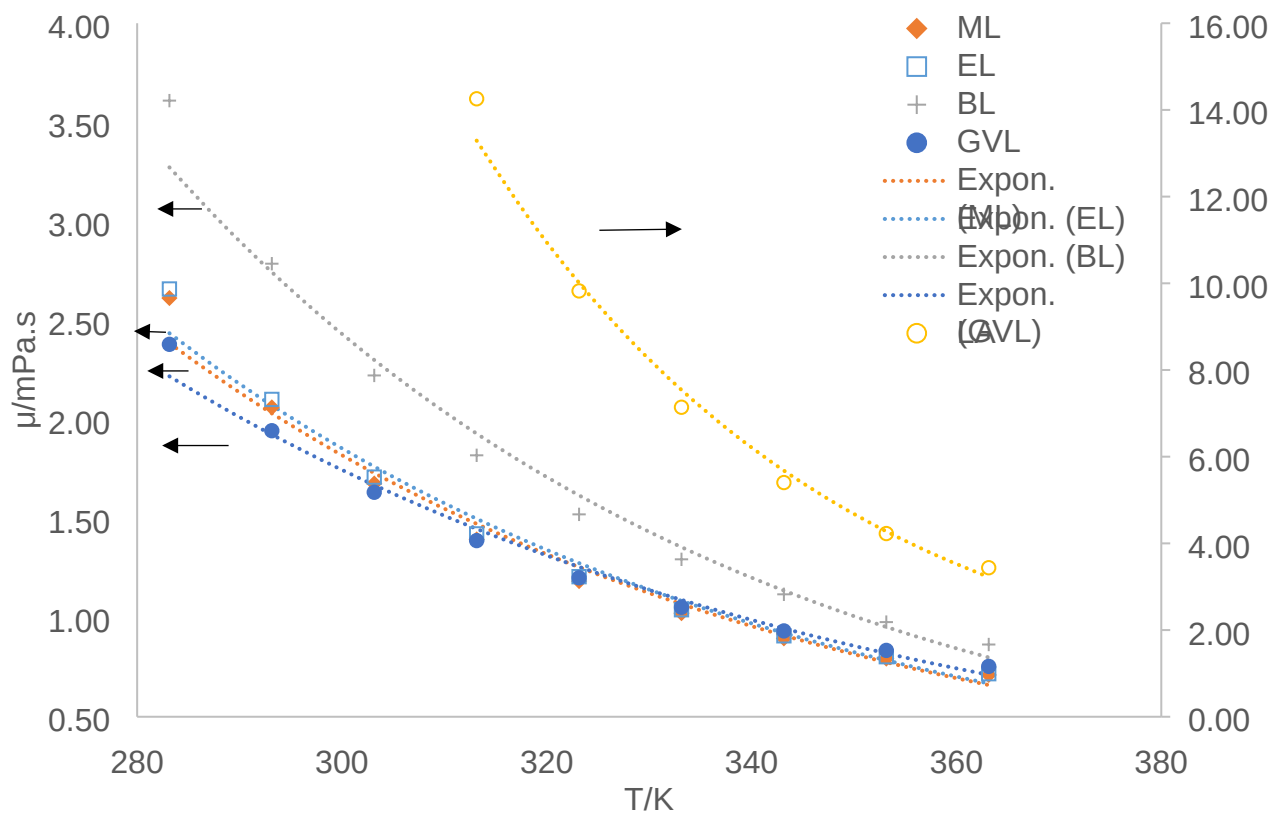
The standard deviation of the mean for dynamic viscosity measurement was less than 1.46 %. The experimental data fit the Arrhenius law (Eq 3).

$$\mu = A' \times \exp\left(\frac{-E}{R \times T}\right) \quad (3)$$

where,  $\mu$  is the dynamic viscosity (mPa.s),  $A'$ (mPa.s) is the pre-exponential constant,  $E$  is the activation energy (J.mol<sup>-1</sup>),  $R$  is the universal gas constant (J.mol<sup>-1</sup>.K<sup>-1</sup>) and  $T$  is the temperature (K). The coefficients of determination were found to be higher than 99.64 %, which confirm the high reliability of this model (Fig. 3).

Viscosity of LA is higher than that of the other compounds, whereas viscosity of GVL is the lowest one in the temperature range (280.15-340.15) K (Fig. 3)

Table 5 shows the coefficients of determination and the values of the constants  $A$  and  $\frac{E}{R}$  for the pure chemicals.



**Fig. 3.** Variation of dynamic viscosity of the pure compounds examined *versus* temperature.

**Table 5.** Values of the coefficients  $A'$  and  $\frac{E}{R}$  for dynamic viscosity of pure components.

	$A'/\text{mPa.s}$	$\frac{E}{R}/\text{K}$	$R^2$
Levulinic acid	0.0004	-3235.2	0.9964
Methyl levulinate	0.0070	-1664.2	0.9971
Ethyl levulinate	0.0069	-1675.5	0.9977
n-Butyl levulinate	0.0055	-1825.8	0.9974
$\gamma$ -valerolactone	0.0129	-1471.2	0.9985
Ethanol	0.0040	-1658.3	1
Methanol	0.0134	-1102.4	0.9996
n-Butanol	0.0011	-2303.3	1

Our experimental measurement of viscosity was similar to the ones of Lomba *et al.* [32-33] for LA, ML, EL and BL.

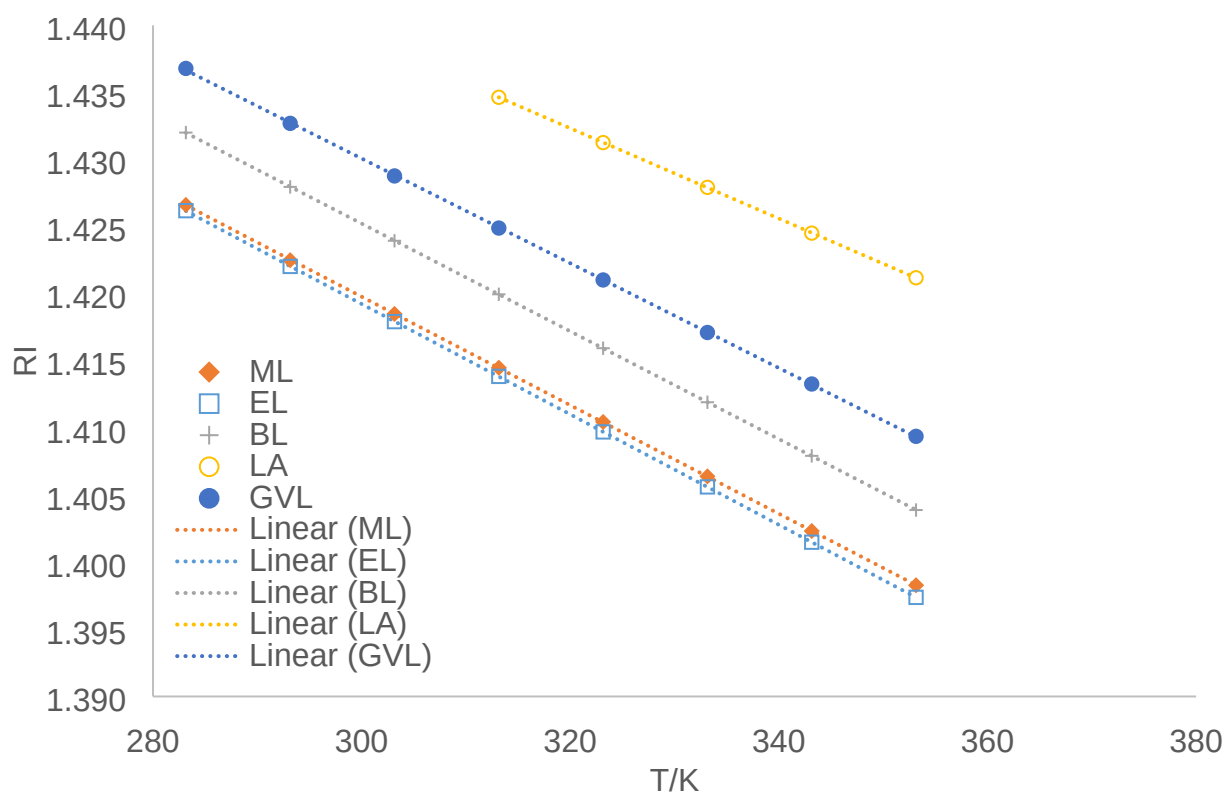
### 3.1.3 Refractive index

The standard deviation of the mean for refractive index measurement was lower than 0.59 %. The experimental data were expressed as a linear relationship between the refractive index and the temperature (Eq 4). This equation fitted the experimental data for all pure components with a coefficient of determination higher than 97.96 %.

$$RI = A'' \times T + B'' \quad (4)$$

where,  $RI$  is the refractive index,  $A''$  ( $K^{-1}$ ) and  $B''$ , are constants depending on the components used and  $T$  is the temperature (K).

Table 6 shows the coefficient of determination and the values of the constants  $A''$  and  $B''$  for the pure chemicals.



**Fig. 4.** Variation of refractive index of the pure compounds versus temperature

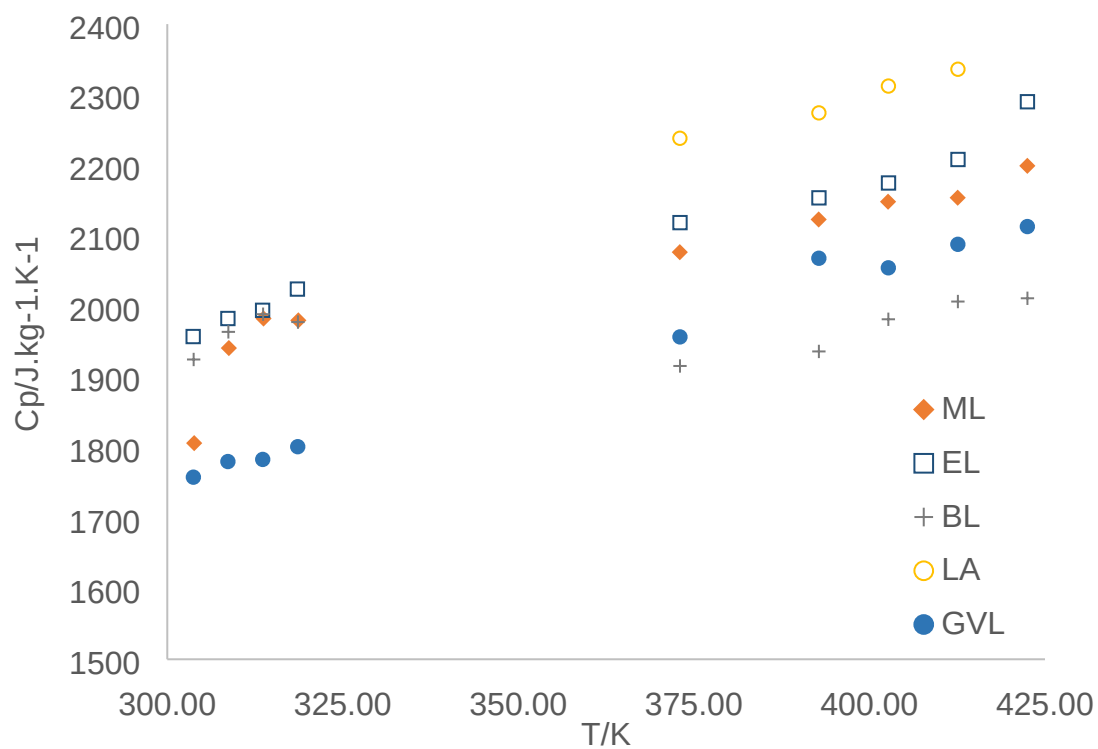
The refractive index of LA is higher than those of the other pure compounds (Fig. 4). One can notice that it is possible to use RI as an analytical online signal to follow the concentrations of GVL and the substrates (LA, ML, EL and BL) during the hydrogenation of LA or its esters to GVL. Our experimental measurement of RI was similar to the ones of Lomba *et al.* [32-33] for LA, ML, EL and BL.

**Table 6.** Values of the coefficients A'' and B'' for refractive indices of pure chemicals

	A''/K <sup>-1</sup>	B''	R <sup>2</sup>
Levulinic acid	-0.0003	1.54	0.9999
Methyl levulinate	-0.0004	1.5411	1
Ethyl levulinate	-0.0004	1.5426	1
n-Butyl levulinate	-0.0004	1.5456	1
Gamma valerolactone	-0.0004	1.5472	0.9999
Ethanol	-0.0004	1.4864	0.9978
Methanol	-0.0004	1.4532	0.9927
n-Butanol	-0.0004	1.5158	1

### 3.1.4 Specific heat capacity

Fig. 5 shows the evolution of the specific heat capacity with temperature.



**Fig. 5.** Evolution of specific heat capacity of the pure compounds with temperature.



The experimental values of specific heat capacity measured in this study were found to be similar to the one of Pokorny *et al.* [32] for GVL. As shown in reference [31], a polynomial equation of third order can be used to express the variation of specific heat capacity with temperature:

$$\frac{\overline{C}_P(T)}{R} = A''' \times \left(\frac{T}{100}\right)^3 + B''' \times \left(\frac{T}{100}\right)^2 + C''' \times \left(\frac{T}{100}\right)^1 + D''' \quad (5)$$

where,  $\overline{C}_P(T)$  is the molar heat capacity at the temperature  $T$ ,  $A'''$ ,  $B'''$ ,  $C'''$  and  $D'''$  are constants depending on the component used and  $T$  is the temperature (K). The values of these coefficients are displayed in Table 7.

**Table 7.** Values of the coefficients  $A'''$ ,  $B'''$ ,  $C'''$  and  $D'''$  for specific heat capacity of pure compounds.

	$A'''/K^{-3}$	$B'''/K^{-2}$	$C'''/K^{-1}$	$D'''$	$R^2$
Levulinic acid	-49.562	588.654	-2324.964	3085.521	1.000
Methyl levulinate	14.518	-161.857	600.850	-709.667	0.953
Ethyl levulinate	9.078	-98.279	356.213	-395.794	0.996
n-Butyl levulinate	0.9601	-10.819	46.148	-27.1	0.9943
$\gamma$ -Valerolactone	-2.191	23.860	-82.345	112.630	0.992
Ethanol	10.423	-109.093	382.745	-434.400	1.00
Methanol	43.501	-399.744	1227.918	-1250.831	1.000
n-Butanol	-728.417	6791.311	-21089.330	21836.497	1.000

### 3.2 Physicochemical measurement of non-reaction mixture

One of the aims of this study is to determine whether simple mixing rules for density, viscosity, specific heat capacity or refractive index can be used with confidence. To evaluate the reliability of these mixing rules, the overall average relative deviation (OARD) is used:

$$OARD = \frac{\sum_{i=1}^n \left| \frac{\theta_i - \hat{\theta}_i}{\theta_i} \right|}{n} \times 100 \quad (6)$$

where,  $\theta_i$  are the experimental values,  $\hat{\theta}_i$  are the simulated values, and  $n$  is the number of experimental points.

#### 3.2.1 Density measurement

It was found that density of a non-reaction mixture can be calculated according to the following mixing rule:

$$\rho_{mix} = \sum_{i=1}^n w_i \times \rho_i \quad (7)$$

where,  $w_i$  is the mass fraction of the species  $i$ ,  $\rho_{mix}$  is the density of mixtures,  $\rho_i$  is the density of the species  $i$ .

The OARD are presented in Table 8. For each density tested the OARD was found to be lower than 1.75 %. Hence, equation (7) is completely reliable and can be used with confidence.

**Table 8.** OARD for density of non-reaction mixtures.

Mixture	OARD(%)
Mix1	0.30
Mix2	1.72
Mix3	0.63
Mix4	0.66
Mix5	0.73
Mix6	1.32
Mix7	1.20
Mix8	1.45

### 3.2.2 Viscosity measurement

The prediction of viscosity values can be done by using the following simple mixing rule:

$$\ln (\mu_{mix}) = \sum_{i=1}^n w_i \times \ln (\mu_i) \quad (8)$$

where,  $w_i$  the mass fraction of the component  $i$ ,  $\mu_{mix}$  is the dynamic viscosity of mixtures and  $\mu_i$  is the dynamic viscosity of the species  $i$ .

Table 9 displays the OARD between experimental and calculated data, obtained applying Eq. (8). Just in one instance (Mixture 7) the OARD is 6.05 %, hence it can be assumed that the experimental data of dynamic viscosity can be reliably predicted, and with a completely acceptable OARD, applying Eq. (8).

**Table 9.** OARD for viscosity of non-reaction mixtures.

Mixture	OARD (%)
Mix1	1.43
Mix2	2.94
Mix3	2.42
Mix4	2.03
Mix5	2.15
Mix6	4.15
Mix7	6.05
Mix8	2.94

### 3.2.3 RI measurement

The prediction of RI was done applying a mixing rule, presented by the following relation:

$$RI_{mix} = \sum_{i=1}^n w_i \times RI_i \quad (9)$$

where,  $w_i$  is the mass fraction of the species  $i$ ,  $RI_{mix}$  is the mixture refractive index and  $RI_i$  is the refractive index of the species  $i$ . The OARD between experimental values and those calculated applying the above equation (Eq. 9) is presented in Table 10. It can be concluded that the experimental data on mixture refractive index can be predicted successfully with an OARD less than 1.02 %.

**Table 10.** OARD for refractive index of non-reaction mixtures.

Mixture	OARD (%)
Mix1	0.31
Mix2	1.02
Mix3	0.05
Mix4	0.01
Mix5	0.63
Mix6	0.92
Mix7	0.26
Mix8	0.08

### 3.2.4 Specific heat capacity

The following mixing rule can be used to predict the experimental values of the specific heat capacity of mixtures.

$$C_{Pmix} = \sum_{i=1}^n w_i \times C_{Pi} \quad (10)$$

where,  $w_i$  is the mass fraction of the species  $i$ ,  $C_{Pmix}$  is the specific heat capacity of mixture and  $C_{Pi}$  is the refractive of the species  $i$ .

Table 11 presents the OARD between experimental values and those obtained by the equation. The OARDs for Mix 5 (levulinic acid) are quite significant, and hence it can be concluded that the simple correlation given by Eq. 10 is not appropriate when the weight percentage of LA is higher than 20 wt. %.

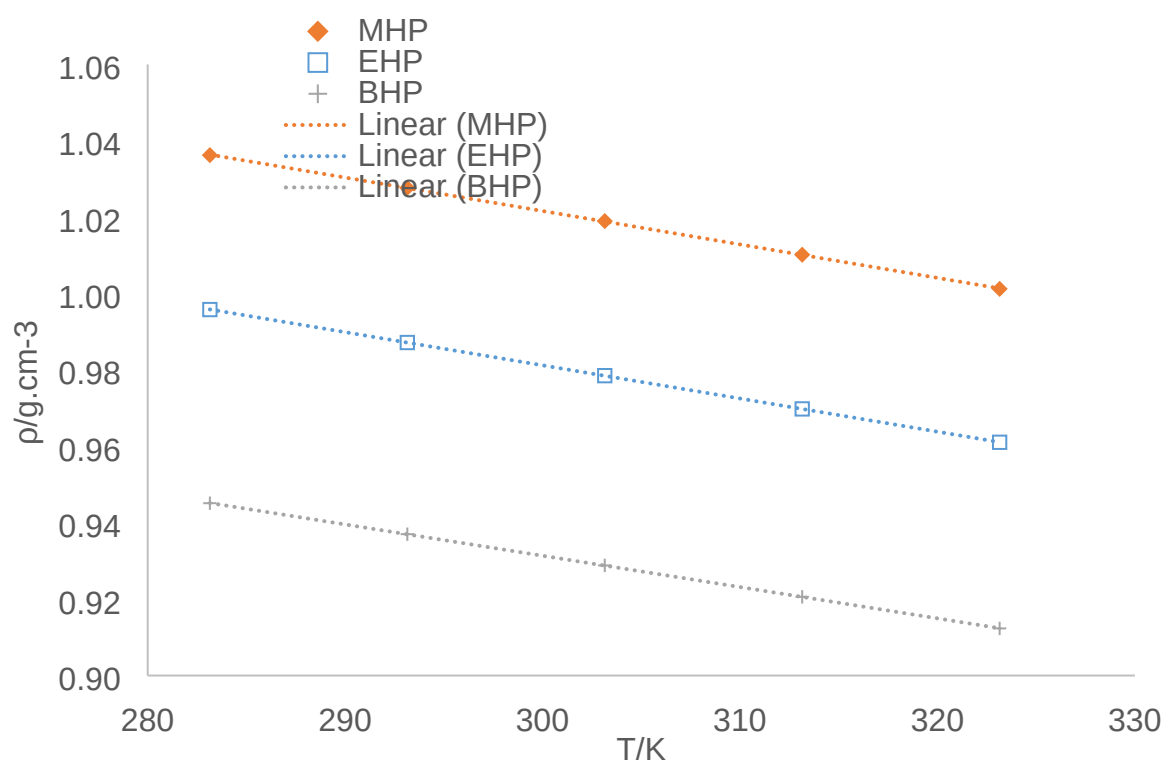
**Table 11.** OARD for specific heat capacity of non-reaction mixtures.

Mixture	OARD (%)
Mix1	1.31
Mix2	6.45
Mix3	1.70
Mix4	1.86
Mix5	7.23
Mix6	3.28
Mix7	1.86
Mix8	2.84

### 3.3 Evaluation of intermediates physicochemical properties

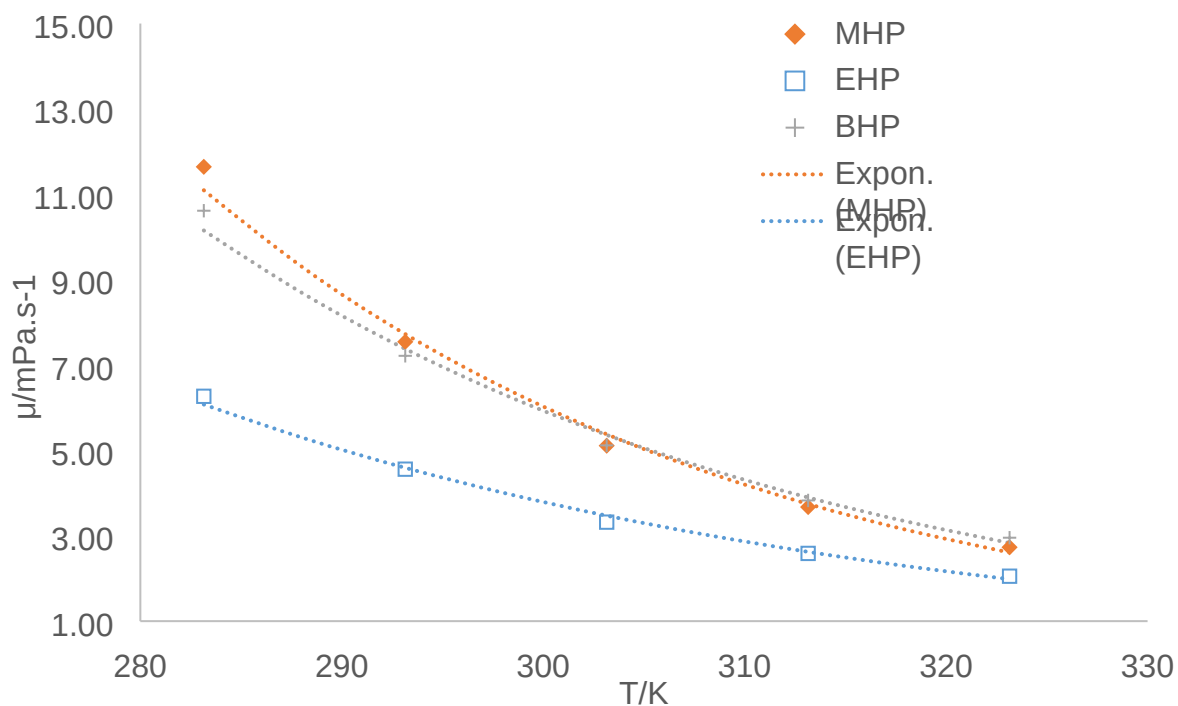
In Section 3.2, it was demonstrated that the simple mixing rules represented by Eqs 7-10 are reliable and can be used with confidence to evaluate the physicochemical properties of the mixtures examined. Therefore, they were applied also to evaluate the physicochemical properties of the intermediates. It should be noted that due to the high instability of the intermediate HPA, it was not possible to evaluate its physicochemical properties.

The results for the viscosity, density, refractive index and specific heat capacity of each of the three intermediates examined, obtained applying the above simple mixing rules are shown in Figs 6-8, respectively. In general, the physicochemical properties of the intermediates are closer to the esters than GVL.

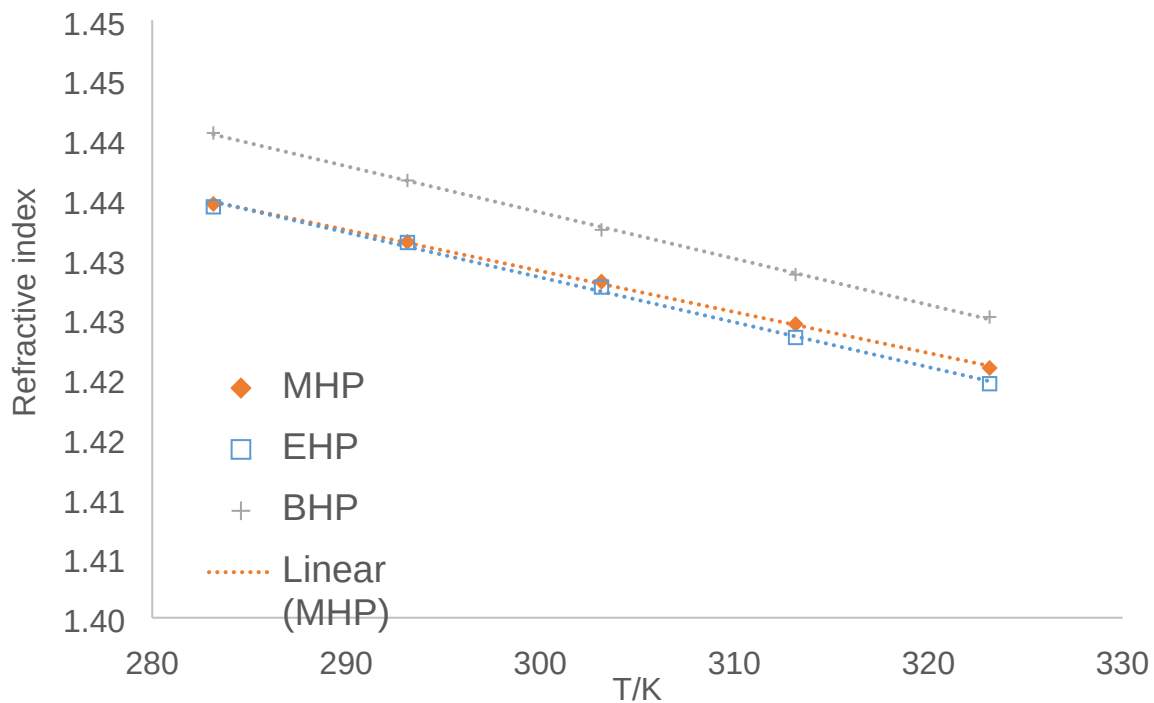


**Fig. 6.** Variation of density of intermediates *versus* temperature.

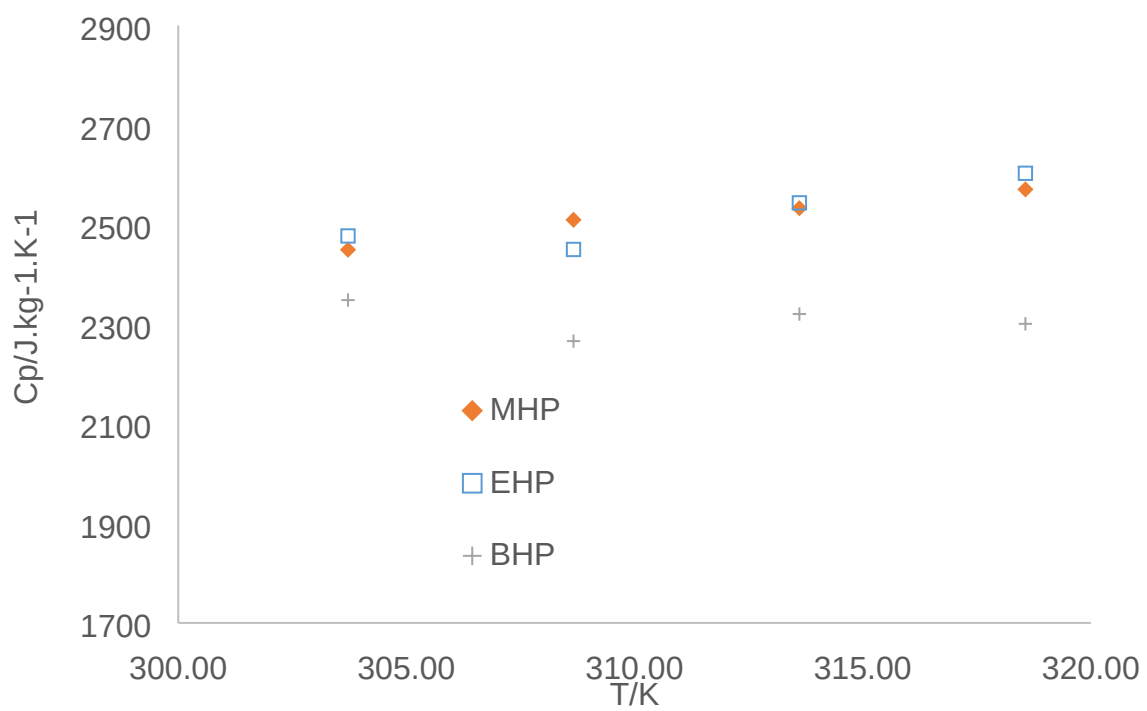




**Fig. 7.** Variation of dynamic viscosity of intermediates *versus* temperature.



**Fig. 8.** Variation of refractive indices of intermediates *versus* temperature.



**Fig. 9.** Variation of specific heat capacity of intermediates *versus* temperature.

### 3.4 Assessment of thermodynamic models

There are two main options to determine which thermodynamic model can be used for a chemical process:

- Follow the recommendation of Carlson [3] without making any experimental measurements;
- Choose a thermodynamic model and re-estimate the binary interaction coefficients by using a physicochemical property, classically the vapor pressure;

In this study, we have chosen a third option. Different thermodynamic models available in the process simulator ASPEN Plus were tested and the simulated values of density, viscosity and specific heat capacity were compared to the experimental values for pure, non-reactive and intermediate solutions. It was found that HYSSRK and BWRS can adequately represent the experimental data. The OARDs calculated were used as a criterion of the models reliability.

#### 3.4.1 Equation of State for both thermodynamic models

Hysys Redlich–Kwong–Soave (HYSSRK) implements the Soave-Redlich-Kwong (SRK) cubic equation of state property package from Aspen HYSYS [35]. It is used for hydrocarbon and high hydrogen pressure systems. The form of the equation of state is:

$$P = \frac{RT}{V-b} - \frac{a}{V(V+b)} \quad (11)$$

where,  $P$  is the pressure,  $V$  is the molar volume,  $R$  is the ideal gas constant,  $a$  is a parameter representing the attraction,  $b$  is a volume-related parameter, expressed as a function of the size of the molecules.

BWRS is a virial equation of state [35] based on the Benedict-Webb-Rubin-Starling equation of state with optional pure-component and binary interaction parameters. It was advocated for the prediction of properties of hydrocarbon mixtures. The form of the equation of state is:

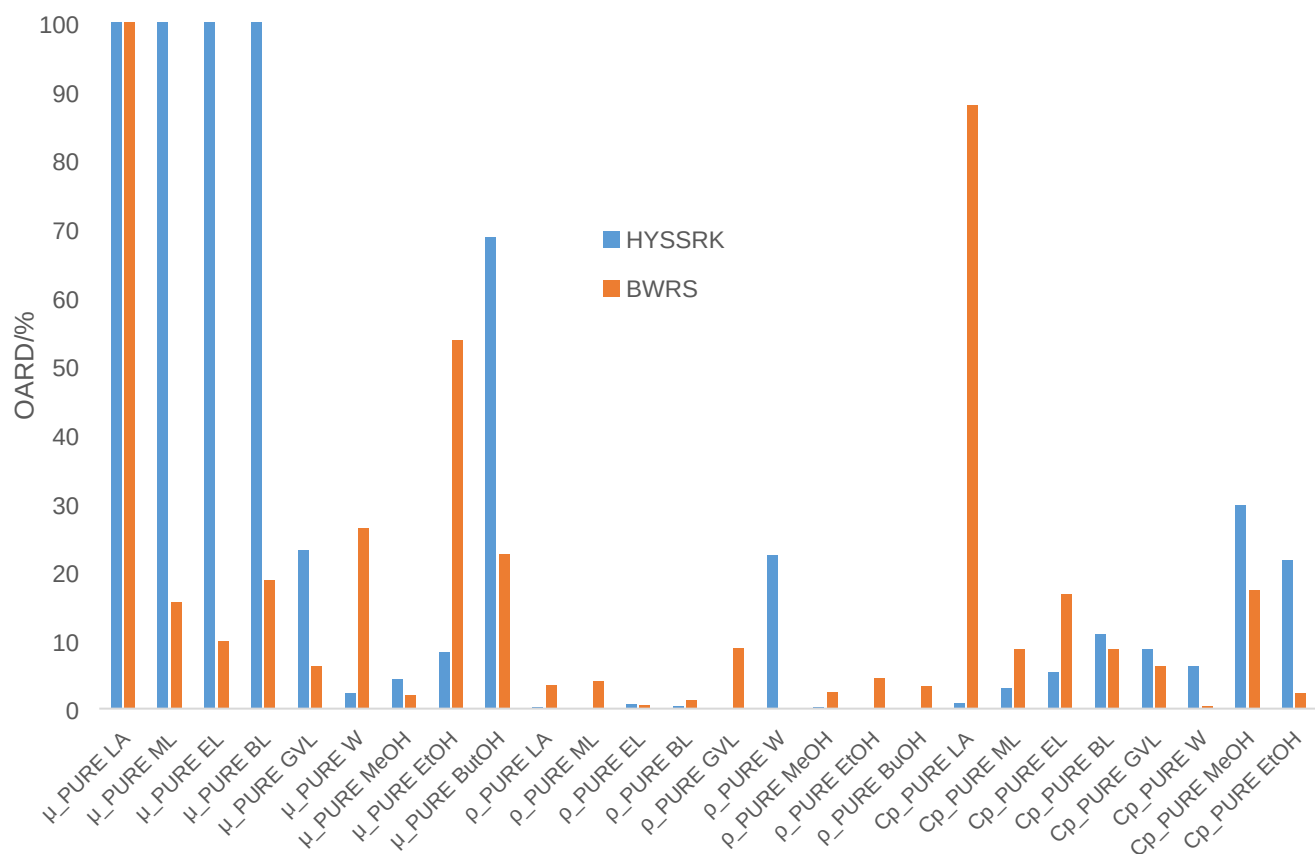
$$P = \rho_m RT + \left( B_0 RT - A_0 - \frac{C_0}{T^2} + \frac{D_0}{T^3} - \frac{E_0}{T^4} \right) \times \rho_m^2 + \left( bRT - a - \frac{d}{T} \right) \times \rho_m^3 + \alpha \left( a + \frac{d}{T} \right) \times \rho_m^6 + \frac{c\rho_m^3}{T^2} \times (1 + \gamma\rho_m^2) \times \exp(-\gamma\rho_m^2) \quad (12)$$

where,  $\rho_m$  is the molar density,  $A_0, B_0, C_0, D_0, E_0, a, b, c, d, \alpha, \gamma$  are constants.

### 3.4.2 Experimental and simulated values.

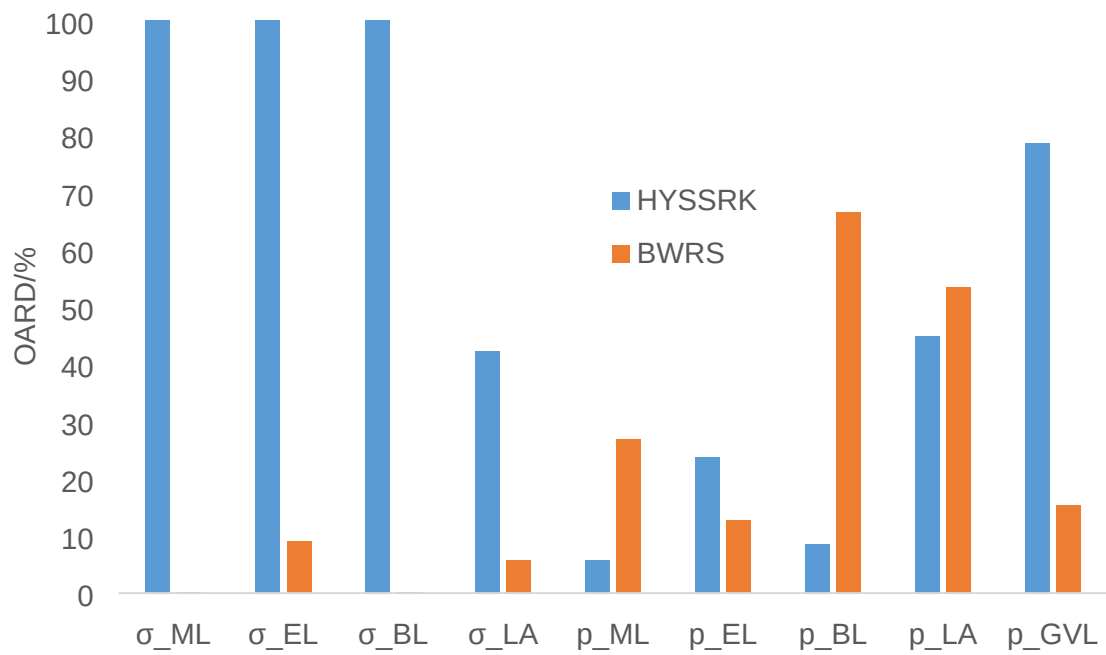
Density, viscosity and specific heat capacity of the three solutions (pure, reaction and non-reaction mixtures) were used to compare the reliability of both thermodynamic models.

Fig. 10 shows the values of OARD for these three physicochemical properties using pure solutions. As demonstrated, both thermodynamic models cannot reliably reproduce the viscosity behavior of levulinic acid, while BWRS fails also for the specific heat capacity of levulinic acid. BWRS can predict the viscosity behavior of ML, EL, BL and GVL in a reasonable way, i.e., with OARDs lower than 20 %. Nevertheless, this thermodynamic model cannot correlate the viscosity values for water and ethanol, but predicts correctly the density of the different compounds at stake. For the specific heat capacity, HYSSRK reproduces correctly the values of this property for the different compounds examined.



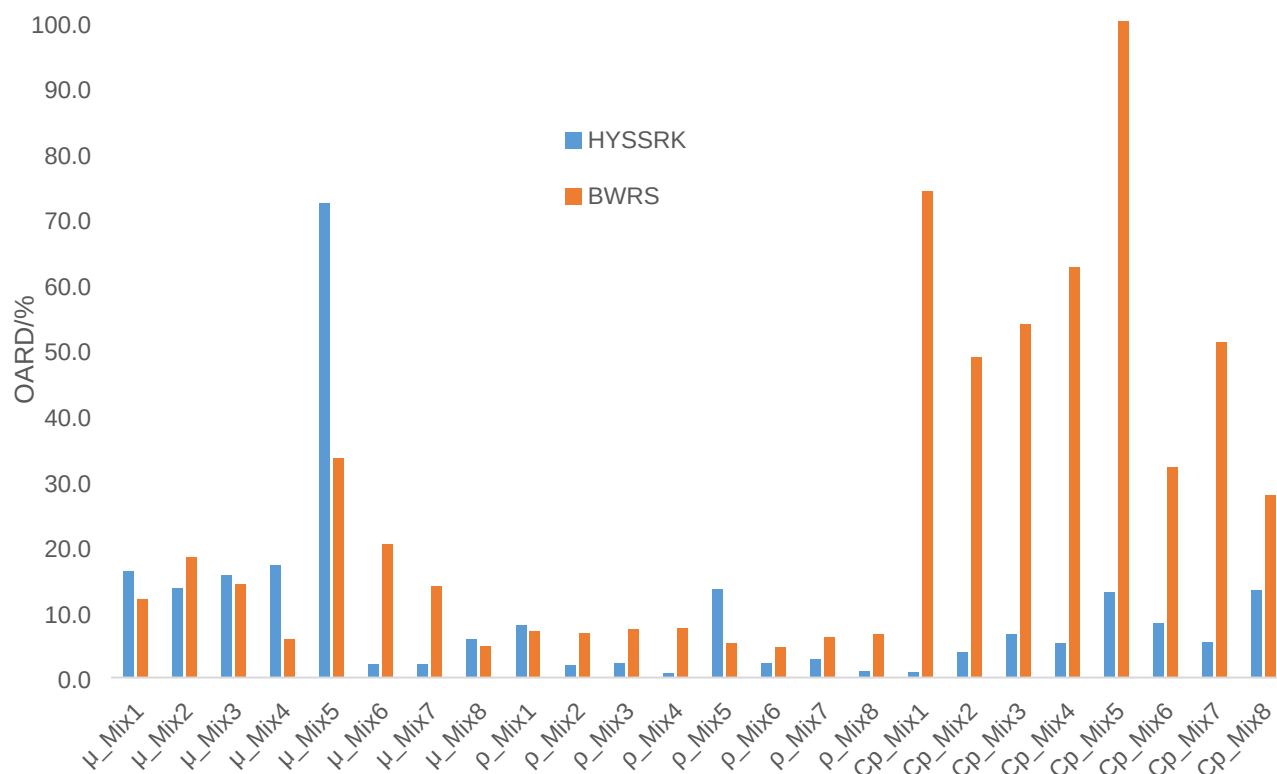
**Fig. 10.** Experimental and simulation comparison for pure solution: viscosity, density and specific heat capacity.

The same work was done by using the data of Pokorný *et al.* [30], Lomba *et al.* [31-32] concerning the vapor pressure and surface tension for LA, ML, EL, BL and GVL. Fig. 11 shows that BWRS predicts correctly the surface tension of LA, ML, EL and BL within the temperature range (278.15-338.15) K, as well as the vapor pressure values of EL and GVL.



**Fig. 11.** Experimental and simulation comparison for pure solution: surface tension and vapor pressure.

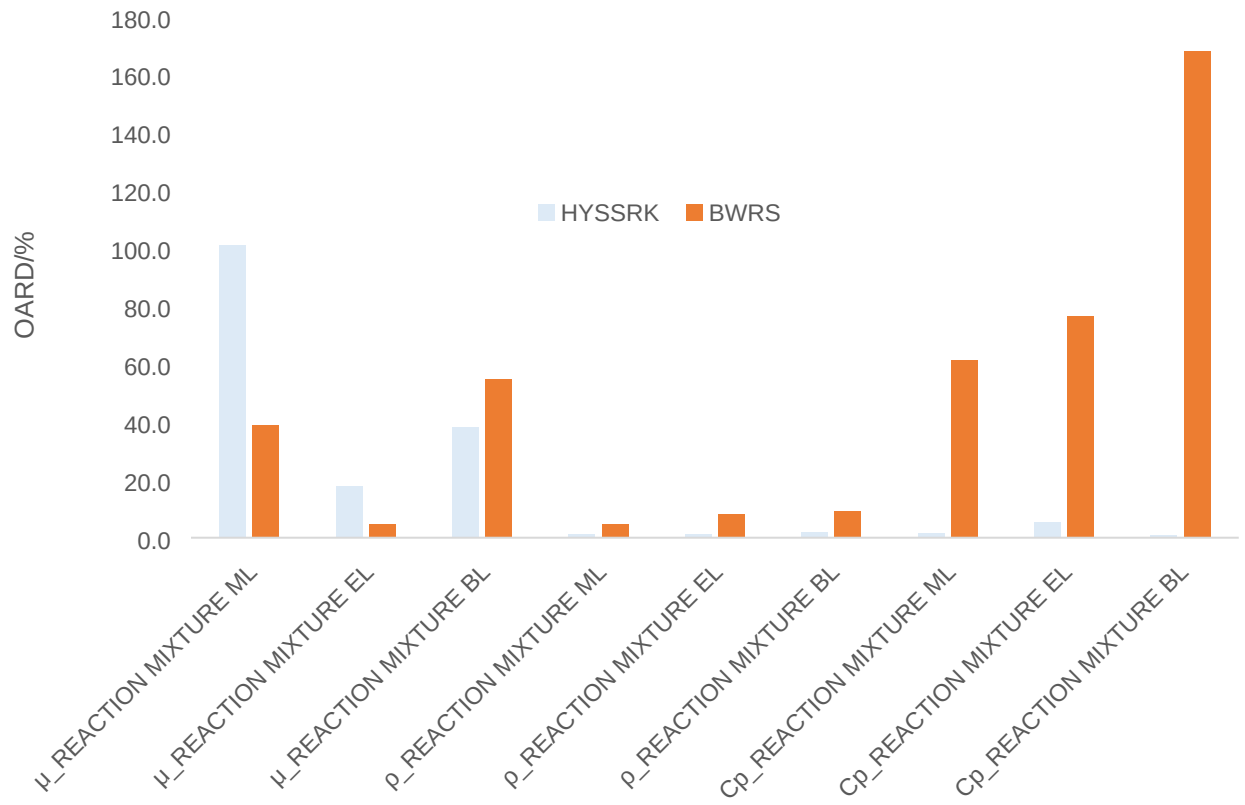
Fig. 12 shows the OARD values obtained for the non-reaction mixtures using both thermodynamic models. As shown the increase of levulinic acid composition (Mix 5) hinders the estimation of its viscosity compared to Mix 1. With the exception of solution Mix 5, both thermodynamic models can fit the experimental data for viscosity and density, while for the specific heat capacity, HYSSRK performs better.



**Fig. 12.** Experimental and simulation comparison for non-reaction mixture.

Fig. 13 shows the evolution of OARD values for reaction-mixtures, i.e., the ones containing the intermediates. As shown, both methods fail to reproduce correctly the viscosity of reaction mixture for ML and BL substrates. For the other physicochemical properties, HYRSS can be used with confidence.





**Fig. 13.** Experimental and simulation comparison for reaction mixture.

#### 4. Conclusions

The physicochemical properties for the system hydrogenation of levulinic acid or its esters to  $\gamma$ -valerolactone were studied. Density, viscosity, specific heat capacity and refractive index of different solutions were measured at different temperatures.

Three types of solutions were used: pure solutions, non-reaction mixtures and reaction mixtures solution. A non-reaction mixture consisted of a substrate (LA, EL, ML or BL), solvent (GVL) and the corresponding co-product (Water, MeOH, EtOH or BuOH). From the physicochemical properties measurements of these solutions, it was found that a simple mixing rule can be applied to predict the values of the physicochemical properties. A reaction-mixture solution was constituted of a substrate, GVL, the corresponding intermediate and co-product. By applying a simple mixing rule on these solutions, it was possible to evaluate the physicochemical properties of the intermediates (MHP, EHP and BHP).

A thermodynamic model assessment was performed by using Aspen Plus. The experimental data from the physicochemical measurements of the three types of solution was used. Different thermodynamic models from Aspen Plus were tested, and it was found that the experimental data can be fitted adequately by two thermodynamic models: BWRS and HYSSRK.

This study can be considered as a first brick in this field. For process simulation, the choice of the correct thermodynamic model can be challenging, essentially for bio-area. Usually, a thermodynamic model is selected, then the model parameters are estimated from the available experimental data.

A continuation of this work is to re-estimate the binary interaction coefficients by considering different properties to have a better fitting between the experimental and simulated data.

## Nomenclature

A	density constant [g.cm <sup>-3</sup> .K <sup>-1</sup> ]
A'	viscosity constant [mPa.s]
A''	refractive index constant [K <sup>-1</sup> ]
A'''	Coefficient for specific heat capacity [K <sup>-3</sup> ]
B	density constant [g.cm <sup>-3</sup> ]
B''	refractive index constant
B'''	Coefficient for specific heat capacity [K <sup>-2</sup> ]
C'''	Coefficient for specific heat capacity [K <sup>-1</sup> ]
C <sub>p</sub>	specific heat capacity [J.kg <sup>-1</sup> .K <sup>-1</sup> ]
$\overline{C_p}$	molar heat capacity [J.mol <sup>-1</sup> .K <sup>-1</sup> ]
D'''	--
E	Activation energy for viscosity [J.mol <sup>-1</sup> ]
OARD	overall average relative deviation
p	vapor pressure
R	gas constant [J.K <sup>-1</sup> .mol <sup>-1</sup> ]
R <sup>2</sup>	coefficient of determination
RI	Refractive index
S	standard deviation of the mean
T	temperature [K]
x <sub>i</sub>	experimental value
$\overline{x}$	mean value of experimental measurement
w <sub>i</sub>	weight percent

## Greek letters

$\mu$	liquid viscosity [mPa.s]
-------	--------------------------

$\sigma$	surface tension [mN.m <sup>-1</sup> ]
$\rho$	mass density [g.cm <sup>-3</sup> ]
$\theta_i$	experimental value
$\hat{\theta}_i$	simulated value

#### Subscripts and superscripts

mix	Non-reaction mixture
-----	----------------------

#### Abbreviations

BL	butyl levulinate
BHP	butyl 4-hydroxypentanoate
EL	ethyl levulinate
EHP	ethyl 4-hydroxypentanoate
HPA	4-hydroxypentanoic acid
LA	levulinic acid
ML	methyl levulinate
MHP	methyl 4-hydroxypentanoate
GVL	$\gamma$ -valerolactone
ROH	co-product of the second reaction (water, methanol, ethanol or butanol)

## **Acknowledgements**

This study has been done in the framework of Task 2: “Green process: 2nd generation of biomass” of AMED project. The authors thank the AMED project. The AMED project has been funded with the support from the European Union with the European Regional Development Fund (ERDF) and from the Regional Council of Normandie. The China Scholarship Council: Cooperation Program with the UTs and INSAs (France) is thanked by the authors.

## References

- [1] D. Sengupta, R. W. Pike, *Chemicals from Biomass: Integrating Bioprocesses into Chemical Production Complexes for Sustainable Development*, 1<sup>st</sup> Edition, CRC Press, 2012.
- [2] M. Vasiliu, K. Guynn, D.A. Dixon, Prediction of the Thermodynamic Properties of Key Products and Intermediates from Biomass, *J. Phys. Chem. C.* 115 (2011) 15686–15702. doi:10.1021/jp204243m.
- [3] E.C. Carlson, Don't Gamble With Physical Properties For Simulations, *CHEMICAL ENGINEERING PROGRESS.* 92 (1996) 35–46.
- [4] A. Wingren, M. Galbe, G. Zacchi, Techno-economic evaluation of producing ethanol from softwood: comparison of SSF and SHF and identification of bottlenecks, *Biotechnol. Prog.* 19 (2003) 1109–1117. doi:10.1021/bp0340180.
- [5] C.N. Hamelinck, A.P.C. Faaij, H. den Uil, H. Boerrigter, Production of FT transportation fuels from biomass; technical options, process analysis and optimisation, and development potential, *Energy.* 29 (2004) 1743–1771. doi:10.1016/j.energy.2004.01.002.
- [6] P. Sassner, M. Galbe, G. Zacchi, Techno-economic evaluation of bioethanol production from three different lignocellulosic materials, *Biomass and Bioenergy.* 32 (2008) 422–430. doi:10.1016/j.biombioe.2007.10.014.
- [7] G. Pokoo-Aikins, A. Heath, R.A. Mentzer, M. Sam Mannan, W.J. Rogers, M.M. El-Halwagi, A multi-criteria approach to screening alternatives for converting sewage sludge to biodiesel, *Journal of Loss Prevention in the Process Industries.* 23 (2010) 412–420. doi:10.1016/j.jlp.2010.01.005.
- [8] A.D. Patel, J.C. Serrano-Ruiz, J.A. Dumesic, R.P. Anex, Techno-economic analysis of 5-nonanone production from levulinic acid, *Chemical Engineering Journal.* 160 (2010) 311–321. doi:10.1016/j.cej.2010.03.034.
- [9] J. He, W. Zhang, Techno-economic evaluation of thermo-chemical biomass-to-ethanol, *Applied Energy.* 88 (2011) 1224–1232. doi:10.1016/j.apenergy.2010.10.022.

- [10] S. Murat Sen, C.A. Henao, D.J. Braden, J.A. Dumesic, C.T. Maravelias, Catalytic conversion of lignocellulosic biomass to fuels: Process development and techno-economic evaluation, *Chemical Engineering Science*. 67 (2012) 57–67. doi:10.1016/j.ces.2011.07.022.
- [11] Y. Zhang, T.R. Brown, G. Hu, R.C. Brown, Comparative techno-economic analysis of biohydrogen production via bio-oil gasification and bio-oil reforming, *Biomass and Bioenergy*. 51 (2013) 99–108. doi:10.1016/j.biombioe.2013.01.013.
- [12] Y. Zhang, T.R. Brown, G. Hu, R.C. Brown, Techno-economic analysis of two bio-oil upgrading pathways, *Chemical Engineering Journal*. 225 (2013) 895–904. doi:10.1016/j.cej.2013.01.030.
- [13] J.A. Quintero, J. Moncada, C.A. Cardona, Techno-economic analysis of bioethanol production from lignocellulosic residues in Colombia: A process simulation approach, *Bioresource Technology*. 139 (2013) 300–307. doi:10.1016/j.biortech.2013.04.048.
- [14] W. Won, A.H. Motagamwala, J.A. Dumesic, C.T. Maravelias, A co-solvent hydrolysis strategy for the production of biofuels: process synthesis and techno-economic analysis, *React. Chem. Eng.* 2 (2017) 397–405. doi:10.1039/C6RE00227G.
- [15] S.N. Derle, P.A. Parikh, Hydrogenation of levulinic acid and  $\gamma$ -valerolactone: steps towards biofuels, *Biomass Conv. Bioref.* 4 (2014) 293–299. doi:10.1007/s13399-013-0111-5.
- [16] A.M. Raspolli Galletti, C. Antonetti, E. Ribechini, M.P. Colombini, N. Nasso, E. Bonari, From giant reed to levulinic acid and gamma-valerolactone: A high yield catalytic route to valeric biofuels, *Applied Energy*. 102 (2013) 157–162. doi:10.1016/j.apenergy.2012.05.061.
- [17] O.A. Abdelrahman, A. Heyden, J.Q. Bond, Analysis of Kinetics and Reaction Pathways in the Aqueous-Phase Hydrogenation of Levulinic Acid To Form  $\gamma$ -Valerolactone over Ru/C, *ACS Catal.* 4 (2014) 1171–1181. doi:10.1021/cs401177p.
- [18] C. Ortiz-Cervantes, J.J. García, Hydrogenation of levulinic acid to  $\gamma$ -valerolactone using ruthenium nanoparticles, *Inorganica Chimica Acta*. 397 (2013) 124–128.

doi:10.1016/j.ica.2012.11.031.

- [19] X. Du, Y. Liu, J. Wang, Y. Cao, K. Fan, Catalytic conversion of biomass-derived levulinic acid into  $\gamma$ -valerolactone using iridium nanoparticles supported on carbon nanotubes, *Chinese Journal of Catalysis*. 34 (2013) 993–1001. doi:10.1016/S1872-2067(11)60522-6.
- [20] C. Delhomme, L.-A. Schaper, M. Zhang-Preße, G. Raudaschl-Sieber, D. Weuster-Botz, F.E. Kühn, Catalytic hydrogenation of levulinic acid in aqueous phase, *Journal of Organometallic Chemistry*. 724 (2013) 297–299. doi:10.1016/j.jorganchem.2012.10.030.
- [21] M. Chalid, A.A. Broekhuis, H.J. Heeres, Experimental and kinetic modeling studies on the biphasic hydrogenation of levulinic acid to  $\gamma$ -valerolactone using a homogeneous water-soluble Ru-(TPPTS) catalyst, *Journal of Molecular Catalysis A: Chemical*. 341 (2011) 14–21. doi:10.1016/j.molcata.2011.04.004.
- [22] K. Yan, A. Chen, Efficient hydrogenation of biomass-derived furfural and levulinic acid on the facilely synthesized noble-metal-free Cu-Cr catalyst, *Energy*. 58 (2013) 357–363. doi:10.1016/j.energy.2013.05.035.
- [23] H. Mehdi, V. Fábos, R. Tuba, A. Bodor, L.T. Mika, I.T. Horváth, Integration of Homogeneous and Heterogeneous Catalytic Processes for a Multi-step Conversion of Biomass: From Sucrose to Levulinic Acid,  $\gamma$ -Valerolactone, 1,4-Pentanediol, 2-Methyl-tetrahydrofuran, and Alkanes, *Top Catal*. 48 (2008) 49–54. doi:10.1007/s11244-008-9047-6.
- [24] L. Deng, J. Li, D.-M. Lai, Y. Fu, Q.-X. Guo, Catalytic Conversion of Biomass-Derived Carbohydrates into  $\gamma$ -Valerolactone without Using an External H<sub>2</sub> Supply, *Angewandte Chemie International Edition*. 48 (2009) 6529–6532. doi:10.1002/anie.200902281.
- [25] H. Heeres, R. Handana, D. Chunai, C.B. Rasrendra, B. Girisuta, H.J. Heeres, Combined dehydration/(transfer)-hydrogenation of C<sub>6</sub>-sugars (D-glucose and D-fructose) to  $\gamma$ -valerolactone using ruthenium catalysts, *Green Chem*. 11 (2009) 1247–1255. doi:10.1039/B904693C.
- [26] Y. Wang, L. Vernières-Hassimi, V. Casson-Moreno, J.-P. Hébert, S. Leveneur, Thermal Risk



- Assessment of Levulinic Acid Hydrogenation to  $\gamma$ -Valerolactone, *Org. Process Res. Dev.* 22 (2018) 1092–1100. doi:10.1021/acs.oprd.8b00122.
- [27] B.T. Huang, S. Leveneur, T. Zamar, J.P. Mikkola, B. Taouk, Towards Production of  $\gamma$ -valerolactone via Hydrogenation of Aqueous Levulinic Acid, *International Journal of Chemical Reactor Engineering*. 13 (2015) 119–127. doi:10.1515/ijcre-2014-0077.
- [28] Y. Wang, M. Cipolletta, L. Vernières-Hassimi, V. Casson-Moreno, S. Leveneur, Application of the concept of Linear Free Energy Relationships to the hydrogenation of levulinic acid and its corresponding esters, *Chemical Engineering Journal*. 374 (2019) 822–831. doi:10.1016/j.cej.2019.05.218.
- [29] A.S. Piskun, H.H. van de Bovenkamp, C.B. Rasrendra, J.G.M. Winkelman, H.J. Heeres, Kinetic modeling of levulinic acid hydrogenation to  $\gamma$ -valerolactone in water using a carbon supported Ru catalyst, *Applied Catalysis A: General*. 525 (2016) 158–167. doi:10.1016/j.apcata.2016.06.033.
- [30] L. Negahdar, M.G. Al-Shaal, F.J. Holzhäuser, R. Palkovits, Kinetic analysis of the catalytic hydrogenation of alkyl levulinates to  $\gamma$ -valerolactone, *Chemical Engineering Science*. 158 (2017) 545–551. doi:10.1016/j.ces.2016.11.007.
- [31] V. Pokorný, V. Štejfa, M. Fulem, C. Červinka, K. Růžička, Vapor Pressures and Thermophysical Properties of Ethylene Carbonate, Propylene Carbonate,  $\gamma$ -Valerolactone, and  $\gamma$ -Butyrolactone, *J. Chem. Eng. Data*. 62 (2017) 4174–4186. doi:10.1021/acs.jced.7b00578.
- [32] L. Lomba, B. Giner, I. Bandrés, C. Lafuente, M.R. Pino, Physicochemical properties of green solvents derived from biomass, *Green Chem*. 13 (2011) 2062–2070. doi:10.1039/C0GC00853B.
- [33] L. Lomba, C. Lafuente, M. García-Mardones, I. Gascón, B. Giner, Thermophysical study of methyl levulinate, *The Journal of Chemical Thermodynamics*. 65 (2013) 34–41. doi:10.1016/j.jct.2013.05.025.
- [34] X. Cai, K. Ait Aissa, L. Estel, S. Leveneur, Investigation of the Physicochemical Properties for

Vegetable Oils and Their Epoxidized and Carbonated Derivatives, *J. Chem. Eng. Data.* 63 (2018) 1524-1533. doi:10.1021/acs.jced.7b01075.

- [35] T.-V. Nguyen, B. Elmegaard, Assessment of thermodynamic models for the design, analysis and optimisation of gas liquefaction systems, *Appl. Energ.* 183 (2016) 43-60. Doi:10.1016/j.apenergy.2016.08.174

## Journal of Chemical Thermodynamics Submission Checklist for Reporting New Experimental Data

### Do you report any experimental results in the submission?

- Yes.** Before your manuscript reporting new experimental results is submitted to the Journal of Chemical Thermodynamics, your submission should be checked for the items listed below. In some cases defined with “☐”, a drop-box gives a choice of options “☐” or “N/A” (option “N/A” should be used if the item is not applicable to the submission content – e.g., “N/A” can be selected for item I.4.G if only pure-compound properties are reported in the manuscript).
- No.** Stop here – the items listed below refer only to reporting experimental data.

### I. GENERAL

#### I.1. Compound description:

- I.1.A.** At least two chemical identifiers are needed for each compound, e.g., IUPAC systematic names, CAS registry numbers, chemical structures.
- N/A **I.1.B.** If stereoisomerism (e.g., Z/E-isomerism, diastereomerism, enantiomerism) is possible, the spatial isomer studied must be specified, or it must be clearly indicated that a mixture of isomers was used.
- N/A **I.1.C.** For a mixture of diastereomers or cis/trans-isomers, the mixture composition must be determined, if any property information is reported. If solid-liquid or solid-vapour equilibrium data are reported for an enantiomeric solid compound, the content of each enantiomer must be given as well.

#### I.2. Sample description:

- I.2.A.** The manuscript needs a sample table, which describes the source of all compounds used, their initial purity (if available), purification methods, and final purity of the samples as used, and analytical methods used for sample characterization. See <http://trc.nist.gov/JournalCoop/JCT/Link1and2.html#Table> for an example of a well-formatted sample table.
- I.2.B.** Purities should be given as fraction, not per cent. If known, the purity basis (mass or mole fraction) should be indicated.
- I.2.C.** All non-commercial compounds synthesized by the authors or others should be properly characterized, i.e., their chemical identity must be demonstrated (e.g., by NMR) and their final purities must be evaluated and reported.
- N/A **I.2.D.** If <sup>1</sup>H-nuclear magnetic resonance spectroscopy (NMR) is used to quantify the purity of a chemical sample, a graphical image of the corresponding NMR spectrum, including chemical shifts and peak integrals, must be provided.
- N/A **I.2.E.** If a compound is hygroscopic, the water content in the studied sample should be determined (e.g., by Karl Fischer titration) and reported.

N/A **I.2.F.** If properties of hydrates (solvates) are reported or compositions are based on their masses, the content of water (solvent) must be checked and reported along with its uncertainty.

### **I.3. Method description:**

□ **I.3.A.** Sufficient experimental details must be provided for each applied experimental method to allow the work to be reproduced by an independent researcher. Options:

**Option 1 – new experimental set-up:** the experimental method must be fully described and validated. The method validation requires measurements for at least one well-studied system, tabulations of the validation results, and comparison with available literature values in a numerical or graphical form.

**Option 2 – existing apparatus:** a summary of the method used must be provided, even if complete details have been published elsewhere. Details that affect the expected uncertainty should always be given. Any modifications to existing methods should also be described. If method validation has been conducted before, the corresponding reference must be provided; otherwise, the methods validation must be done and described according to Option 1.

□□ **I.3.B.** Calibration details must be provided for each apparatus requiring prior calibration. Appropriate widely-accepted recommendations (e.g., by ICTAC or GEFTA for DSC) should be followed.

### **I.4. Reporting new experimental data:**

□ **I.4.A.** All directly measured (primary) property values must be reported (preferably, tabulated) in the manuscript (e.g., not only apparent molar volumes derived from measured densities, but also the experimental density values). Graphical representation, equations, or tables of smoothed values are not sufficient. If the data tables are large, they can be provided as supplementary material.

□ **I.4.B.** The corresponding phase must be specified (e.g., “isobaric heat capacity for liquid cyclohexane”, “enthalpy of solution of crystalline naphthalene in liquid hexane”).

□ **I.4.C.** Numerical values of all state variables (e.g., pressure, temperature, compositions) must be provided together with the measured properties. The authors should consult the Gibbs phase rule for the number of state variables to be reported.

□ **I.4.D.** Units must always be given, never assumed. SI units must be used in the manuscript. If other quantities are mentioned, their equivalent in SI must be given.

□ **I.4.E.** All symbols used in a table must be defined in the table heading/footnote. It is not sufficient to define the symbols in the text only.

N/A **I.4.F.** Whenever applicable, numerical values for all non-state variables must be provided (e.g., frequency for speed-of-sound, electrical-conductivity, relative-permittivity measurements; wavelength for refractive-index and spectrophotometric measurements; shear rate or frequency for steady-rotation or oscillation viscosity measurements, respectively, etc.).

□ **I.4.G.** All compositions must be reported in mole fractions, mass fraction, or molalities. If molarities, normalities, volume fractions, or other volume-based composition are used, they must be duplicated by mole fractions, mass fractions, or molalities. “Loadings” must also be duplicated by mole fractions, mass fractions, or molalities.

- **I.4.H.** Molalities in mixtures containing three or more components require explicit definition of the solvent.
- N/A **I.4.I.** If the concept of mole is applied to intermetallic compounds, co-crystals, eutectic solvents, or other aggregates, the mole formula unit must be defined.
- **I.4.J.** If a portion of the data has been already published by the authors (e.g., pure-component or binary endpoints), the corresponding references must be provided in the data tables to distinguish those from newly measured data.

### **I.5. Uncertainties:**

- **I.5.A.** Uncertainties for all variables and properties (including pressure, temperature, composition) must be given in each data table and for each stand-alone (untabulated) value. In the data tables, they can be specified either in a footnote or, if variable, included in the table as an additional column. See <http://trc.nist.gov/JCT-Support.html> for examples of the acceptable uncertainty representation.
- **I.5.B.** The type of uncertainty must be defined. The uncertainties should be reported as standard uncertainties  $u$  (0.68 level of confidence) or expanded uncertainties  $U$  (0.95 level of confidence). In the case of expanded uncertainties, the level of confidence must be specified. Both absolute ( $u$ ,  $U$ ) and relative ( $u_r$ ,  $U_r$ ) uncertainties are acceptable. See <http://www.bipm.org/en/publications/guides/gum.html> for additional details.
- **I.5.C.** The claimed uncertainties should be justified, e.g., by appropriate measurements of a reference system.
- N/A **I.5.D.** The effect of sample purity and/or calibration on the uncertainties reported should be accounted for.

### **I.6. Literature Comparison:**

- **I.6.A.** The reported experimental data should be compared with available literature data, and deviations should be discussed.
- **I.6.B.** Graphical comparison should be used whenever possible. Deviation plots are preferred.
- N/A **I.6.C.** The comparisons should be also made for sub-systems (i.e., for pure-component endpoints for binary mixtures and binary endpoints for ternary mixtures).

*Note: free online tool ThermoLit (<http://trc.nist.gov/thermolit/>) is available to identify relevant literature sources in the NIST data archive with which to compare new results. ThermoLit is intended to aid researchers and reviewers in determining relevant literature sources for a given experimental measurement. It is not intended to replace the comprehensive literature review required by all journals, because the ThermoLit database is extensive, but not comprehensive.*

## **II. PHASE EQUILIBRIA FOR MIXTURES**

**Do you report any experimental results on solid-liquid and/or liquid-liquid equilibria in mixtures?**

- **Yes.** Proceed.

- **No.** Stop here – the items listed below refer only to reporting experimental data for solid-liquid and/or liquid-liquid equilibria in mixtures.

### **II.1. General:**

- **II.1.A.** The number and type of phases in equilibrium must be clearly defined in a data table.

### **II.2. Solid-liquid equilibrium data:**

- N/A **II.2.A.** If SLE involves various solid forms (e.g., polymorphs, intercomponent compounds, solvates, complexes, crystals of different mixture components, etc.), experimental proof of the identity of the solid phase in equilibrium with the saturated solution is needed (e.g., via x-ray diffraction). The composition of the solid phase (e.g., the number of water molecules in hydrates) should be provided.

- N/A **II.2.B.** If solvent composition may be altered during SLE measurements (e.g., dissolution of hydrates), the contents of all components in the saturated solution should be determined and reported.

### **II.3. Liquid-liquid equilibrium data:**

- N/A **II.3.A.** If LLE tie-lines for a ternary mixture containing two ionic compounds with different ions are studied (e.g., ionic liquid + salt + water), concentrations of all ions in each liquid phase must be determined and reported.