



HAL
open science

Channelopathies of voltage-gated L-type Cav1.3/ α 1D and T-type Cav3.1/ α 1G Ca²⁺ channels in dysfunction of heart automaticity

Angelo Torrente, Pietro Mesirca, Isabelle Bidaud, Matteo E. Mangoni

► To cite this version:

Angelo Torrente, Pietro Mesirca, Isabelle Bidaud, Matteo E. Mangoni. Channelopathies of voltage-gated L-type Cav1.3/ α 1D and T-type Cav3.1/ α 1G Ca²⁺ channels in dysfunction of heart automaticity. *Pflügers Archiv European Journal of Physiology*, 2020, 472 (7), pp.817 - 830. 10.1007/s00424-020-02421-1 . hal-02892374

HAL Id: hal-02892374

<https://hal.science/hal-02892374>

Submitted on 6 Jan 2021

HAL is a multi-disciplinary open access archive for the deposit and dissemination of scientific research documents, whether they are published or not. The documents may come from teaching and research institutions in France or abroad, or from public or private research centers.

L'archive ouverte pluridisciplinaire **HAL**, est destinée au dépôt et à la diffusion de documents scientifiques de niveau recherche, publiés ou non, émanant des établissements d'enseignement et de recherche français ou étrangers, des laboratoires publics ou privés.

Channelopathies of voltage-gated L-type Cav1.3/ α_{1D} and T-type Cav3.1/ α_{1G} Ca²⁺ channels in dysfunction of heart automaticity

*Angelo G. Torrente^{1,2}, *Pietro Mesirca^{1,2}, Isabelle Bidaud^{1,2}, Matteo E. Mangoni^{1,2}

¹Institut de Génomique Fonctionnelle, Univ. Montpellier, CNRS, INSERM, Montpellier, France.

²LabEx Ion Channels Science and Therapeutics (ICST).

Matteo E. Mangoni, PhD

Institut de Génomique Fonctionnelle

CNRS UMR 5203, Inserm U 1191

Université de Montpellier

141, rue de la Cardonille

34094 Montpellier, France

Phone +33 (0)4 34 35 92 46

Fax +33 (0)4 67 54 24 32

Email: matteo.mangoni@igf.cnrs.fr

(*) Contributed equally

Summary

The heart automaticity is a fundamental physiological function in vertebrates. The cardiac impulse is generated in the sinus node by a specialized population of spontaneously active myocytes known as “pacemaker cells”. Failure in generating or conducting spontaneous activity induces dysfunction in cardiac automaticity. Several families of ion channels are involved in the generation and regulation of the heart automaticity. Among those, voltage-gated L-type Cav1.3 ($\alpha 1D$) and T-type Cav3.1 ($\alpha 1G$) Ca^{2+} channels play important roles in the spontaneous activity of pacemaker cells. Ca^{2+} channels channelopathies specifically affecting cardiac automaticity are considered as rare. Recent research on familial disease has identified mutations in the Cav1.3-encoding *CACNA1D* gene that underlie congenital sinus node dysfunction and deafness (OMIM # 614896). In addition, both Cav1.3 and Cav3.1 channels have been identified as pathophysiological targets of sinus node dysfunction and heart block, caused by congenital autoimmune disease of the cardiac conduction system. The discovery of channelopathies linked to Cav1.3 and Cav3.1 channels underscores the importance of Ca^{2+} channels in the generation and regulation of heart’s automaticity.

Keywords: Sinus Node Dysfunction; sinus node; Ca^{2+} channels; Cav1.3; Cav3.1

Introduction

Heart automaticity is a highly complex function. It integrates the pacemaker activity of the sino-atrial node (SAN) with impulse conduction through the atrioventricular node (AVN) and the ventricular conduction system. The structural and ionic mechanisms underlying heart automaticity are intrinsically robust and redundant. However, SAN dysfunction (SND) and heart block constitute a relatively widespread clinical condition in cardiology, especially in the elder population [28]. Several forms of SND and atrioventricular conduction block (heart block) have been described. SND may manifest in the absence of other accompanying such as heart failure, drug intoxication or diabetes and showing genetic legacy. This condition is defined as idiopathic or primary SND. In contrast, acquired forms of SND are generally secondary to other clinical conditions or co-morbidities [34]. Acquired SND forms account for the majority of patients. A substantial amount of research over the last 10 years has helped identify mechanisms of secondary SND (see Monfredi and Boyett for review [58]). Similarly, an increasing number of studies have described new mechanisms underlying primary forms of SND and, more specifically, inheritable forms of SND and heart block. Genetic investigation of SND patients has identified mutation in ion channels responsible for a wide array of familial idiopathic SND. These include mutation in Na^+ channels [10], hyperpolarization-activated channels [2], G-protein-gated K^+ channels [33], as well as L- and T-type voltage-gated Ca^{2+} channels (VGCCs) [26,1].

Adult cardiac myocytes of the SAN and the AVN express three isoforms of VGCCs: T-type Cav3.1, L-type Cav1.3 and Cav1.2 channels [48]. Idiopathic forms of SND and heart block induced by pathogenic mutation of the Cav1.3-encoding gene *CACNA1D* are known [1,43]. Furthermore, autoimmune idiopathic forms of SND due to disruption of Cav1.3 and Cav3.1 channel activity have been described [26] (see Qu et al. [66] for review). In this manuscript, we will review the current knowledge about channelopathies of Cav3.1 and Cav1.3 channels leading to dysfunction of SAN pacemaker activity and atrioventricular conduction. In particular, we will first summarize the general mechanism of cardiac pacemaking, highlighting the functional role of VGCCs. Then, we will review the cardiac phenotype of individuals carrying channelopathies of VGCCs and discuss the mechanisms leading to SND and heart block. Finally, we will discuss the possibility to introduce new therapies against idiopathic SND mediated by loss-of-function of VGCCs.

Current models of SAN automaticity: the “coupled-clock” model of pacemaking

The SAN is a heterogeneous tissue [7,4], composed by pacemaker cells, atrial myocytes [82] and fibroblasts [17]. In addition, the SAN contains also adipocytes, epithelial cells, vascular endothelial cells, macrophages and neurons [44]. Pacemaker cells inside the SAN region are sparse and their mutual electrical coupling is low [76]. This characteristic is due to high expression of low conductance (Cx) 45 and poor expression of intermediate-conductance of Cx43 channels [76,81,8].

The automaticity of pacemaker cells is initiated by diastolic depolarization, a spontaneous depolarization phase of driving the membrane voltage from the end of the repolarization to the threshold of the following action potential upstroke (Figure 1). The diastolic depolarization is regulated in opposite ways by the two branches of the autonomic nervous system. The sympathetic branch increases the slope of the depolarization and the parasympathetic branch decreases it. Catecholamines positively regulate the slope of the diastolic depolarization via the activation of β -

adrenergic receptors (β ARs) and consequent stimulation of cAMP synthesis by adenylate cyclases. Elevation of cAMP concentration positively regulates the activity of several plasmalemmal ion channels and stimulates Ca^{2+} release from ryanodine receptors (RyR_2) of the sarcoplasmic reticulum (SR) [50,36] (Figure 1A, upper halve). In antagonism with adrenergic activation, muscarinic type 2 receptors (M_2Rs) decrease pacemaking by promoting down-regulation of intracellular cAMP and inducing opening of G protein activated K^+ channels (GIRK1/GIRK4) underlying cardiac I_{KACH} [83,55].

Several aspects of pacemaker mechanism are not fully understood. However, a substantial part of the current knowledge on the generation of the diastolic depolarization has been included in the so called “*coupled-clock*” model of pacemaking [36]. The *coupled-clock* model of pacemaking indicates that the generation of diastolic depolarization results from a functional association between the activation of the hyperpolarization-activated “funny” current (I_f) and a phenomenon of local diastolic RyR_2 -dependent Ca^{2+} release, also known as the “ Ca^{2+} clock” [36].

I_f is activated at the end of the repolarization phase of the action potential and supplies inward current throughout the range of the diastolic depolarization [19] (Figure 1B). Adrenergic and cholinergic agonists exert opposite effects on I_f voltage-dependence. Norepinephrine shifts I_f activation curve to more positive voltages, while acetylcholine negatively shifts it. These opposing effects are explained by the direct sensitivity of f-channels to cAMP [21], which increases the probability of channel opening at a given voltage [20]. F-channels are encoded by the hyperpolarization activated cyclic nucleotide gated channel (HCN) family, which comprises four distinct isoforms HCN1-HCN4. The predominant HCN isoform expressed in the SAN and AVN is HCN4, which accounts for 80% of the total HCN mRNAs [71].

The concept of Ca^{2+} clock as a pacemaker mechanism proposes that SAN RyR_2 have high spontaneous open probability. This spontaneous, voltage-independent activity generates pulsatile diastolic Ca^{2+} release. These events of Ca^{2+} release are coupled to diastolic depolarization via activation of the electrogenic $\text{Na}^+/\text{Ca}^{2+}$ exchange mediated by the cardiac type 1 exchanger (NCX1; lower halve of Figure 1A) [36,59]. In the Ca^{2+} clock model of automaticity, intracellular cAMP increases the slope of the diastolic depolarization phase by facilitating and synchronizing spontaneous Ca^{2+} release events to increase NCX1 activity. In the Ca^{2+} clock model of pacemaking, L-type Ca^{2+} channels provide Ca^{2+} influx during the action potential upstroke phase to ensure SR Ca^{2+} load. However, both the Ca^{2+} clock or the *coupled-clock* model of automaticity cannot explain the phenotype of mouse models and of individuals with SND induced by loss-of-function of VGCCs [47,77,1].

Voltage-gated Ca^{2+} channels in the generation of SAN automaticity

Several ion channels including VGCCs contribute to the generation of diastolic depolarization. SAN pacemaker cells express both T- and L-type Ca^{2+} channels. The mRNAs of the T-type isoforms Cav3.1 and Cav3.2 are expressed in the SAN [52]. However, the predominant T-type isoform in the adult SAN is Cav3.1 (see ref.[52] for review). The threshold for activation of the Cav3.1-mediated I_{CaT} is -55 mV however, 10% of the total steady-state Cav3.1-mediated I_{CaT} is available at the maximum diastolic potential [52] (Figure 1B). The relative position of the steady-state activation and inactivation curves for Cav3.1-mediated I_{CaT} does not suggest significant window current component [48]. However, further studies using selective blockade of I_{CaT} will address this potentially important aspect of I_{CaT} in SAN cells.

Despite the low steady-state availability of T-type channels at diastolic voltages, Cav3.1 knockout mice (*Cav3.1^{-/-}*) show moderate SAN rate reduction (-10%) and prolonged atrioventricular (PR) conduction interval [52]. In addition, recent data indicate that Cav3.1-mediated I_{CaT} is positively modulated by β ARs agonists in the SAN [42]. In conclusion, consistent results indicate that T-type Cav3.1 channels contribute to set the SAN firing rate.

Adult ventricular myocytes express the L-type Cav1.2 isoform, which couples excitation to contraction in the working myocardium. In contrast, SAN pacemaker cells co-express two distinct L-type Ca^{2+} channel isoforms, Cav1.3 and Cav1.2 [47,86]. Cav1.3-mediated I_{CaL} is characterized by a more negative threshold for activation than Cav1.2-mediated I_{CaL} (-45 mV for Cav1.3 vs. -25 mV for Cav1.2-mediated I_{CaL} , respectively; Figure 1B) [47]. Thanks to the lower threshold of activation, the L-type Cav1.3 channels play a major role in the generation of the diastolic depolarization [47]. In addition, recent work has showed that Cav1.3 is an obligatory molecular component of the sustained inward Na^+ current (I_{st}) [80]. I_{st} supplies inward current that sums to Cav1.3-mediated I_{CaL} during the diastolic depolarization (Figure 1B). Moreover, Cav1.3 channels stimulate RyR-dependent local Ca^{2+} release, possibly enhancing NCX1 activity during the phase of diastolic depolarization. In summary, SAN cells express 3 distinct voltage-gated Ca^{2+} channel isoforms, whose voltage dependencies of activation span the range of the diastolic depolarization (Cav3.1 and Cav1.3) and the upstroke phase of the action potential (Cav1.3, Cav1.2, see Figure 1B) (see [48] and [56], for review).

Voltage-gated Na^+ channels mediate the TTX-sensitive Na^+ current (I_{NaTTX}), which contribute to pacemaking and intra-nodal conduction in the mouse, rabbit and human SAN [45,3,40,41] (Figure 1B). In the human SAN, the TTX-sensitive Nav1.6 isoform plays an important role in intra-nodal conduction and SND [41]. In the SAN, the “cardiac” Nav1.5 isoform underlies the TTX-resistant I_{Na} . However, the contribution of Nav1.5-mediated I_{Na} may be limited to intra-nodal or nodal-atrial impulse conduction. Consistently with this hypothesis, mice haplo-insufficient for Nav1.5 show atrio-ventricular and intra-ventricular conduction defects, rather than SND [39].

Ion channels of the transient receptor potential channels family (TRP) are expressed in the SAN and involved in pacemaker activity [18,69,29]. TRPC channels mediate store-operated Ca^{2+} entry in pacemaker cells [29]. The channel-kinase TRPM7 isoform contributes to pacemaking by regulating HCN4 expression in the SAN and AVN. In addition, it contributes to Ca^{2+} influx in SAN cells [68]. TRPM4 channels have mixed Na^+/K^+ selectivity and contribute to the basal beating rate of SAN cells [18]. Since these channels are sensitive to intracellular Ca^{2+} , it is possible that RyR2 –dependent Ca^{2+} release positively regulates TRPM4 in SAN cells.

The mouse and rabbit SAN express also Ca^{2+} activated K^+ channels (K_{Ca}) [23]. Three classes of K_{Ca} have been identified: Big [35], Intermediate [24] and Small [14,79] conductance K^+ channels. These channels show differential sensitivity to intracellular Ca^{2+} . Ca^{2+} positively regulates Big K_{Ca} (BK), even if these channels are mainly voltage-dependent [23]. Intermediate and Small K_{Ca} (IK and SK, respectively) are voltage independent and highly sensitive to Ca^{2+} [24,78]. In atrial cardiomyocytes such sensitivity to Ca^{2+} is mediated by the association with calmodulin (CaM) [23]. SK channels coupling with L-type Ca^{2+} channels has been demonstrated also in atrial and atrioventricular myocytes [84,85].

The Sinus Node Dysfunction and Deafness Syndrome: a Cav1.3 channelopathy

Transgenic mice carrying ablation of Cav1.3 have provided significant insights in the importance of these channels in pacemaker activity. To date only one pathogenic mutation of the *CACNA1D* gene underlying SND has been identified: the Sinus Node Dysfunction and Deafness (SANDD OMIM # 614896) syndrome. Together with the Jervell-Lange-Nielsen syndrome caused by mutations in either KCNQ1 [60] (OMIM # 220400) or KCNE1 [22] (OMIM # 612347) channels encoding the I_{Ks} current, SANDD constitutes a syndromic channelopathy, in which deafness is associated with heart arrhythmia. In addition, this channelopathy was the first to provide direct genetic evidence of the importance of Cav1.3 in SAN automaticity in humans [1].

At present, SANDD has been identified in seven consanguineous Pakistani families, all from the Khyber Pakhtunkhwa province [1,43]. The SANDD mutation of *CACNA1D* gene consists in a 3 base pair insertion adding a glycine residue at position 403-404 (p.403-404InsGly) in the alternatively spliced exon 8B. The related sequence in exon 8A does not contain the insertion. Expression of exons 8A and 8B is mutually exclusive.

The 8B exon is preferentially expressed in inner hair cells and in the SAN. Addition of this glycine residue affects the folding of one of the four S6 helices probably forming the inner pore of the 8B isoform of Cav1.3. The glycine residue lies in the cytoplasmic side of the pore [1] (Figure 2A). This region of S6 is highly conserved among VGCCs and is very sensitive functionally. Indeed, missense mutations in this region of the *CACNA1F* (Cav1.4) or *CACNA1C* (Cav1.2) genes cause stationary night blindness [25] and Timothy syndrome [73], respectively. Nevertheless, these mutations induce channel gain-of-function by hyperpolarizing the channel voltage-dependency of activation and/or by slowing the channel inactivation kinetics [12]. Instead, the p.403-404InsGly silences the conductance of mutant Cav1.3 (Cav1.3^{403Gly}).

Non-conducting Cav1.3^{403Gly} channels are targeted to the plasma membrane, but fail to produce functional Ca^{2+} current [1] (Figure 2B). The exact mechanism leading to silencing of the channel's conductance is not fully understood. However, recordings of the voltage-dependence of gating currents of mutant Cav1.3 channels provided some insights into how the mutation affects the channel's gating. Indeed, ON-gating currents show faster time-to-peak in comparison to wild-type counterparts, suggesting that this mutation induces uncoupling between gating charge movement of the S4 segment and channel opening.

This hypothesis is consistent with the observation that the time integral of the gating currents of the mutated channels is smaller than wild-type, while the ON-rise time of gating currents is faster. Accessorily, this observation shows that the glycine residue locates outside the S4 segment, although it can still influence its movement preventing the channel to enter in the open conductive state. Another non-exclusive hypothesis could be that the inserted glycine residue, which lays close to inner side of the channel pore could sterically interfere with the flow of Ca^{2+} ions.

While homozygous 403-404InsGly individuals develop SANDD, heterozygous subjects belonging to the same family are normal. A complete clinical correlative rhythmologic follow-up according to current guidelines [34] could not be performed in these patients. However, the ECG analysis and retrospective history of homozygous individuals carrying mutant Cav1.3^{InsGly} channels is consistent with symptomatic SND. Indeed, SND in homozygous SANDD individuals was manifest as sinus bradycardia at day time (heart rate between 38 and 52 bpm) and severe atrioventricular conduction dysfunction [1]. Sinus bradycardia was particularly prominent at night-

time with resting heart rates below 35 bpm (Figure 3A). Other ECG hallmarks of SND include sinus pauses and SAN exit block. Hallmarks of atrioventricular dysfunction in SANDD individuals range from Mobitz 1, 2nd-degree block to episodes of complete heart block with junctional escape rhythms [1]. Importantly, similar hallmarks of SND and atrioventricular block are present in homozygous Cav1.3 knockout (*Cav1.3^{-/-}*) mice (Figure 3B) [54]. Three of the commonest SND symptoms, dizziness, fatigue and syncope during physical exercise have been also reported in young homozygous SANDD individuals [1,43]. Instead, atrial fibrillation has not been directly reported in SANDD patients. *Cav1.3^{-/-}* mice show inducible atrial fibrillation, probably due to shorter duration of the atrial action potential and to alteration in intracellular Ca²⁺ handling (Figure 3B) [46]. The reasons for this difference between SANDD patients and *Cav1.3^{-/-}* mice are unclear. They may be explained by structural differences between the mouse and the human heart or to a differential functional impact between deletion of *Cav1.3^{-/-}* mice versus silencing of channels' conductance in SANDD patients. Another mutation in *CACNA1D* has been identified in a family carrying p.403-404InsGly and presenting SND (missense mutation p.(A376V)) [43]. This variant is also predicted to be pathogenic, but has not been characterized functionally [43].

The ANK2 syndrome: inheritable depletion of Cav1.3 contributes to SND

Besides SANDD, which is generated by specific mutation in the *CACNA1D* gene, another form of inherited SND has been linked to a change in the functional state of Cav1.3 channels. Ankyrin-B is a cytoskeletal adapter protein encoded by the *ANK2* gene (OMIM # 600919). Ankyrin-B is important for proper membrane localization of multiple ion channels and transporters. Mutations in the *ANK2* gene were initially linked to inheritable forms of ventricular tachycardia and sudden death [57]. Further work on *ANK2* variants has identified French families showing that this gene is also important for the normal functioning of the SAN pacemaker mechanism [38,27]. Indeed, these variants in *ANK2* are linked to arrhythmia syndrome and severe SND requiring pacemaker implantation [38]. Importantly, mice haplo-insufficient for Ankyrin-B (*ANK2^{+/-}*) show severe bradycardia and highly-variable heart rate compared to wild-type littermates [38]. This phenotype is explained by the capability of Ankyrin-B to control membrane localization of critical players of pacemaker activity. Indeed, Ankyrin-B haplo-insufficiency reduces the membrane localization of the NCX, the Na⁺/K⁺ ATPase, IP3 receptors and of Cav1.3 channels [38]. Because the localization of both ion channels and transporters is affected by Ankyrin-B haplo-insufficiency, it is difficult to quantitate the specific contribution of Cav1.3 to SND observed in this mouse model. However, inherited forms of SND linked to *ANK2* loss-of-function constitute further evidence of the importance of Cav1.3 channels in the generation of SAN automaticity in humans.

Congenital heart block: an autoimmune Cav1.3 and Cav3.1 channelopathies

Congenital heart block (CHB, OMIM # 234700) is a autoimmune neonatal *lupus* disease of the cardiac conduction system affecting newborns and infants (see refs.[5,30,66] for review). It has been proposed that CHB belongs to a specific class of channelopathies linked to autoimmune disease [66]. The general incidence of CHB is estimated to about 1 in 11,000 births [11]. CHB carries severe consequences. Indeed, mortality among siblings may score up to 30% during the first three months after birth and over 60% of surviving affected children require lifelong electronic pacemaker implantation [11,5].

Familial recurrence of CHB is high and influences the decision making of having another child [5]. Indeed, the probability of having the disease at the second birth is more than twofold that of the first birth. The disease originates from transplacental transport of maternal autoantibodies that severely affects the heart of the fetus before and after birth, while having milder or no effects on the mother's heart. Maternal autoantibodies target intracellular ribonucleoproteins, as well as membrane receptors and ion channels [5]. The principal hallmark of CHB is atrioventricular block [16], even if sinus bradycardia and SND often accompanies heart block [5]. The severity of heart block is variable ranging from prolongation of the PR interval to 3rd degree block with dissociated rhythm. While 1st and 2nd degree blocks may spontaneously reverse after birth, complete 3rd degree block is irreversible and requires pacemaker implantation. In addition, some CHB children develop heart failure later in life despite the implanted pacemaker [5].

The mechanisms underlying CHB are multiple and complex. However, a substantial amount of studies over the last two decades demonstrate a prominent involvement of both L-type and T-type VGCCs in the development of SND and heart block in CHB infants. Maternal autoantibodies were characterized as being directed against soluble ribonucleoproteins 48kD SSB/La, 52kD SSA/Ro, and 60kD SSA/Ro. Bioinformatics analysis conducted in early studies suggested that the 52 kD SSA/Ro shared significant homology with the α 1-subunit of Cav1.2. In contrast, the homology between Cav1.2 and 60kD SSA/Ro or 48 kD SSB/La ribonucleoproteins are minor [5].

Experimental work *in vivo* has shown that female mice injected with purified autoantibodies from mothers of children with CHB produced a highly-significant number of pups presenting with sinus bradycardia and prolongation of PR interval [9,5]. In addition, female mice immunized with 52kD SSA/Ro gave birth to pups showing 2nd degree atrioventricular block and sinus bradycardia [6]. These same antibodies slowed the beating rate of Langendorff-perfused human fetal hearts and reduced I_{CaL} in ventricular myocytes [6] and in myocytes from Purkinje fibres [65]. More specific investigation of the supraventricular conduction system showed that maternal autoantibodies slowed pacemaker activity of intact rat AVN preparations [5] and induced sinus bradycardia and atrioventricular block [67].

The effects of autoantibodies on I_{CaL} were first explained by inhibition of Cav1.2 channels [65]. Deeper analysis of the effects of maternal antibodies on SAN ionic currents showed significant inhibition of I_{CaL} and I_{CaT} and no significant effect on I_{Kr} and I_f [26]. Consistent with current inhibition, autoantibodies slowed the pacemaker activity of isolated SAN cells [26].

Given the major role of Cav1.3 in determining SAN I_{CaL} , pacemaker activity and atrioventricular conduction, the effects of autoantibodies on Cav1.3-mediated I_{CaL} has been tested in *Xenopus* oocytes [64]. Interestingly, autoantibodies inhibit heterologously expressed Cav1.3-mediated I_{CaL} , while application of Bay K8644 rescues current density [64]. Recently, the binding sites of autoantibodies on the α 1-subunit of Cav1.3 [32] and Cav3.1 [74] channels have been identified. In both channels, the binding site lays in the extracellular loop linking the S5 and S6 domains of α 1-subunit, in close proximity to the channel's pore. The positioning of the binding sites in Cav1.3 and Cav3.1 channels is consistent with the observation that acutely perfused autoantibodies quickly induce inhibition of Cav1.3-mediated I_{CaL} and Cav3.1-mediated I_{CaT} .

The mechanism leading to CHB in the fetal heart may involve a two-stages process. In the first stage, maternal autoantibodies bind to the α 1 subunit inhibiting channel's permeability. In the second chronic and irreversible stage of the disease, VGCCs are internalized in the myocyte [30].

It has also been proposed that chronic exposure to maternal autoantibodies and channels internalization trigger myocyte death and consequent cell loss in the conduction system. This hypothesis is consistent with post-mortem observations in CHB hearts which reported fibrosis and calcification of the SAN and AVN [30]. In addition, heart failure could be a consequence of chronic block and internalization of Cav1.2 channels [30].

It has been shown that overexpression of Cav1.2 in the heart prevent the CHB phenotype of pups born to mice immunized with SSA/Ro or SSB/La antigens [31]. It could thus be inferred that, given that adult cardiomyocytes express higher densities of I_{CaL} , compared to fetal counterparts, they may be protected from cell death processes triggered by the loss of Ca^{2+} currents. These data may also explain, in part, why mothers are protected from CHB despite being exposed to the same circulating autoantibodies as fetuses [30].

Two transgenic mouse models of CHB have been proposed. The first employs *Cav1.3*^{-/-} female mice immunized with SSA/Ro or SSB/La antigens. Pups born to these mice present with sinus bradycardia and high degree atrioventricular blocks, sometimes with several isolated P waves not followed by a QRS complex. In comparison, pups born to immunized wild-type mice, in which Cav1.3 is still expressed, present with less pronounced sinus bradycardia and lower severity atrioventricular dysfunction [31]. The phenotype of pups born to immunized *Cav1.3*^{-/-} mothers is consistent with mice lacking both Cav1.3 and Cav3.1 channels (*Cav1.3*^{-/-}/*Cav3.1*^{-/-}). Indeed, these mice show high-degree atrioventricular block and sinus bradycardia [53]. These results underscore the importance of Cav1.3 and Cav3.1 channels inhibition and down-regulation in the establishment of atrioventricular lesion in CHB.

In conclusion, the physiopathological mechanism of CHB are consistent with the importance of Cav1.3 and Cav3.1 channels in the generation of SAN pacemaking and atrioventricular conduction in both model mammals and in humans.

Mechanistic considerations: how do channelopathies of Cav1.3 or Cav3.1 lead to SND?

In its current formulation, the *coupled clock* model of SAN pacemaking gives the primary roles in the generation of automaticity to activation of f-channels and to diastolic spontaneous RyR₂-dependent Ca^{2+} release. This is often in marked contrast with the observed functional impact of Cav1.3 loss-of-function in heart automaticity of mouse models and humans. Thus, questions arise as to the mechanisms linking Cav1.3 channels to the generation of the diastolic depolarization and about how Cav1.3 loss-of-function prevents normal pacemaking in human SANDD.

Our group has identified three Cav1.3-dependent pathways contributing to diastolic depolarization. First, Cav1.3 channels drive inward Ca^{2+} current in the range of the diastolic depolarization (Figure 4). In this respect, under activation of BARs the recorded threshold for activation of Cav1.3-mediated I_{CaL} lays between -55 mV and -60 mV [47,77]. Second, Cav1.3-mediated I_{CaL} contributes to pacemaking by stimulating and synchronizing diastolic RyR₂-dependent Ca^{2+} release (Figure 5) [77]. Third, Cav1.3 channels are a necessary molecular component of the sustained inward Na^+ current (I_{st}) [80]. Furthermore, selective pharmacologic inhibition of L-type Cav1.3 channels reduces heart rate *in vivo* in *Cav1.2*^{DHP}^{-/-} mice [72,54].

In conclusion, Cav1.3 channels contribute to the generation of the diastolic depolarization by driving inward current at diastolic voltages and by coordinating RyR₂-dependent Ca^{2+} release. Loss of these two downstream pathways may explain the phenotype of SANDD, ANK2 and CHB

patients. Cav1.3 channels thus constitute an ideal functional bridge between changes in membrane voltages and intracellular Ca^{2+} release during pacemaking [77]. In comparison to Cav1.3, T-type Cav3.1 channel steady-state availability is reduced at diastolic voltages. However, work on genetically-modified mice have showed that these channels play a role in SAN activity, atrioventricular conduction and junctional automaticity [52,53,37]. In perspective, recent work has described pathogenic variants of *CACNA1D* (OMIM, # 615474), *CACNA1G* (OMIM#618087) and *CACNA1H* (OMIM # 617027) genes inducing gain of function in Cav1.3 [61,62,75], Cav3.1 [13] and Cav3.2 [70] channels. Gain-of-function is characterized by dramatic slowing of Cav1.3-mediated I_{CaL} or Cav3.1-mediated I_{CaT} inactivation kinetics and negative shift of the current steady-state inactivation curve. These gain-of-function variants are linked to primary aldosteronism [75], early-onset neurodevelopmental defects [13] and autism [62]. It will be very important to pursue the screening for similar variants affecting the function of Cav1.3 or Cav3.1 channels in the cardiac pacemaker tissue, as they could explain primary forms of inappropriate sinus tachycardia.

Rescuing dysfunction of heart automaticity in Cav1.3 and Cav3.1 channelopathies

The pacemaker mechanism is a highly-integrated physiological function. To date, it has not been possible to arrest pacemaking by targeting an individual ion channel isoform. A similar observation stands also for adrenergic or cholinergic regulation of pacemaker activity. We may thus wonder if we could take advantage of the functional redundancy between SAN ion channels to rescue SND. In particular, we should consider that the diastolic depolarization is the result of an equilibrium between inward and outward currents that give rise to a net inward current, which in turn allow membrane depolarization. Cav1.3-mediated I_{CaL} and Cav3.1-mediated I_{CaT} generate inward currents thereby participating in the equilibrium as accelerator of the diastolic depolarization.

Since the heart rate is under the constant action of the autonomic nervous system, one may expect that the parasympathetic input could worsen SND induced by loss-of-function of SAN VGCCs channels. First recordings of heart rhythm in *Cav1.3^{-/-}* mice indicated that pharmacologic inhibition of the anticholinergic nervous system input by atropine negated the difference in heart rate between wild-type and knockout mice [63]. This was the first evidence suggesting that sympatholytic drugs could be effective in rescuing SND following Cav1.3 loss-of-function. In following studies by our group, it was showed that the cardiac I_{KACb} carried by GIRK1/GIRK4 channels acts as a tonic inhibitor of SAN activity [55]. Indeed, genetic ablation of I_{KACb} obtained by cross-breeding *Girk4^{-/-}* with *Cav1.3^{-/-}* mice restored the heart rate and rhythm of double mutant animals in comparison to *Cav1.3^{-/-}* counterparts (Figure 6) [54]. Importantly, the effect of genetic ablation of I_{KACb} could be mimicked by administration to *Cav1.3^{-/-}* mice of tertiapine-Q, a peptide inhibitor of I_{KACb} . This rescuing effect is attributable to restore of the equilibrium between inward and outward currents in the SAN and AVN of *Cav1.3^{-/-}* mice.

Taken together, these results suggest that selective I_{KACb} inhibitors could be effective in managing SND due to channelopathies of Cav1.3 and Cav3.1 [54]. In addition, it has been proposed that bait peptides mimicking the binding region of maternal autoantibodies to the S5-S6 loop of VGCCs could be used to prevent channel inhibition and internalization in CHB patients [32,74]. This interesting approach could be combined with targeting of I_{KACb} in CHB. Both these approaches could be complementary to pacemaker implantation in chronic forms of SND and CHB.

Conclusions and perspectives

L-type Cav1.3 and T-type Cav3.1 Ca^{2+} channels play an important role in the generation of heart automaticity. Since the beginning of the new century [51,49], genetically-modified mice have helped identify the role of ion channels isoforms in pacemaker activity [48]. Importantly a number of these murine lines faithfully recapitulated some forms of inherited SND due to mutation in Cav1.3 channels and autoimmune loss-of-function of Cav3.1 channels. This enabled in depth mechanistic analysis of VGCCs-mediated SND mechanisms and provided precious insights into potential therapeutic strategies.

In perspective, we expect that further research on how Cav1.3 and Cav3.1 channels promote pacemaking will further deepen our knowledge on heart automaticity as a whole. Future exploration of genetic registries of patients with history of SND and associated arrhythmias will help evaluate the real incidence of Cav1.3 and Cav3.1 channelopathies leading to dysfunction in heart automaticity in the general population.

Acknowledgments

The group is a member of the Laboratory of Excellence “*Ion Channel Science and Therapeutics*” supported by a grant from ANR (ANR-11-LABX-0015). Research supported by the *Fondation pour la Recherche Medicale* “*Physiopathologie Cardiovasculaire*” (DPC20171138970, M.E.M.), by the *Agence Nationale de la Recherche* (ANR-15-CE14-0004-01, M.E.M.). We also thank the *Fondation Leducq* (TNE 19CVD03; to Matteo E. Mangoni and Peter J. Mohler) for supporting the “*Fighting Against Sinus Node Dysfunction and Associated Arrhythmias*” (FANTASY) network.

Bibliography

1. Baig SM, Koschak A, Lieb A, Gebhart M, Dafinger C, Nurnberg G, Ali A, Ahmad I, Sinnegger-Brauns MJ, Brandt N, Engel J, Mangoni ME, Farooq M, Khan HU, Nurnberg P, Striessnig J, Bolz HJ (2011) Loss of Ca(v)1.3 (CACNA1D) function in a human channelopathy with bradycardia and congenital deafness. *Nat Neurosci* 14:77-84. doi:nn.2694 [pii] 10.1038/nn.2694
2. Baruscotti M, Bottelli G, Milanesi R, DiFrancesco JC, DiFrancesco D (2010) HCN-related channelopathies. *Pflugers Arch* 460:405-415. doi:10.1007/s00424-010-0810-8
3. Baruscotti M, DiFrancesco D, Robinson RB (1996) A TTX-sensitive inward sodium current contributes to spontaneous activity in newborn rabbit sino-atrial node cells. *J Physiol* 492 (Pt 1):21-30
4. Bleeker WK, Mackaay AJ, Masson-Pevet M, Bouman LN, Becker AE (1980) Functional and morphological organization of the rabbit sinus node. *Circ Res* 46:11-22
5. Boutjdir M (2000) Molecular and ionic basis of congenital complete heart block. *Trends Cardiovasc Med* 10:114-122
6. Boutjdir M, Chen L, Zhang ZH, Tseng CE, DiDonato F, Rashbaum W, Morris A, el-Sherif N, Buyon JP (1997) Arrhythmogenicity of IgG and anti-52-kD SSA/Ro affinity-purified antibodies from mothers of children with congenital heart block. *Circ Res* 80:354-362. doi:10.1161/01.res.80.3.354
7. Boyett MR, Honjo H, Kodama I (2000) The sinoatrial node, a heterogeneous pacemaker structure. *Cardiovasc Res* 47:658-687
8. Boyett MR, Inada S, Yoo S, Li J, Liu J, Tellez J, Greener ID, Honjo H, Billeter R, Lei M, Zhang H, Efimov IR, Dobrzynski H (2006) Connexins in the sinoatrial and atrioventricular nodes. *Adv Cardiol* 42:175-197
9. Brucato A, Cimaz R, Balla E (2000) Prevention of recurrences of corticosteroid-dependent idiopathic pericarditis by colchicine in an adolescent patient. *Pediatr Cardiol* 21:395-396. doi:10.1007/s002460010091 [pii]
10. Butters TD, Aslanidi OV, Inada S, Boyett MR, Hancox JC, Lei M, Zhang H (2010) Mechanistic links between Na⁺ channel (SCN5A) mutations and impaired cardiac pacemaking in sick sinus syndrome. *Circ Res* 107:126-137. doi:10.1161/CIRCRESAHA.110.219949
11. Buyon JP, Hiebert R, Copel J, Craft J, Friedman D, Katholi M, Lee LA, Provost TT, Reichlin M, Rider L, Rupel A, Saleeb S, Weston WL, Skovron ML (1998) Autoimmune-associated congenital heart block: demographics, mortality, morbidity and recurrence rates obtained from a national neonatal lupus registry. *J Am Coll Cardiol* 31:1658-1666. doi:10.1016/s0735-1097(98)00161-2
12. Calorio C, Gavello D, Guarina L, Salio C, Sassoe-Pognetto M, Riganti C, Bianchi FT, Hofer NT, Tuluc P, Obermair GJ, Defilippi P, Balzac F, Turco E, Bett GC, Rasmusson RL, Carbone E

(2019) Impaired chromaffin cell excitability and exocytosis in autistic Timothy syndrome TS2-neo mouse rescued by L-type calcium channel blockers. *J Physiol* 597:1705-1733. doi:10.1113/JP277487

13. Chemin J, Siquier-Pernet K, Nicouleau M, Barcia G, Ahmad A, Medina-Cano D, Hanein S, Altin N, Hubert L, Bole-Feysot C, Fourage C, Nitschke P, Thevenon J, Rio M, Blanc P, Vidal C, Bahi-Buisson N, Desguerre I, Munnich A, Lyonnet S, Boddaert N, Fassi E, Shinawi M, Zimmerman H, Amiel J, Faivre L, Colleaux L, Lory P, Cantagrel V (2018) De novo mutation screening in childhood-onset cerebellar atrophy identifies gain-of-function mutations in the CACNA1G calcium channel gene. *Brain* 141:1998-2013. doi:10.1093/brain/awy145

14. Chen WT, Chen YC, Lu YY, Kao YH, Huang JH, Lin YK, Chen SA, Chen YJ (2013) Apamin modulates electrophysiological characteristics of the pulmonary vein and the Sinoatrial Node. *Eur J Clin Invest* 43:957-963. doi:10.1111/eci.12125

15. Christel CJ, Cardona N, Mesirca P, Herrmann S, Hofmann F, Striessnig J, Ludwig A, Mangoni ME, Lee A (2012) Distinct localization and modulation of Cav1.2 and Cav1.3 L-type Ca²⁺ channels in mouse sinoatrial node. *J Physiol* 590:6327-6342. doi:jphysiol.2012.239954 [pii] 10.1113/jphysiol.2012.239954

16. Crittenden IH, Latta H, Ticinovich DA (1964) Familial Congenital Heart Block. *Am J Dis Child* 108:104-108. doi:10.1001/archpedi.1964.02090010106015

17. De Maziere AM, van Ginneken AC, Wilders R, Jongasma HJ, Bouman LN (1992) Spatial and functional relationship between myocytes and fibroblasts in the rabbit sinoatrial node. *J Mol Cell Cardiol* 24:567-578

18. Demion M, Bois P, Launay P, Guinamard R (2007) TRPM4, a Ca(2+)-activated nonselective cation channel in mouse sino-atrial node cells. *Cardiovasc Res* 73:531-538

19. DiFrancesco D (2010) The role of the funny current in pacemaker activity. *Circ Res* 106:434-446. doi:106/3/434 [pii] 10.1161/CIRCRESAHA.109.208041

20. DiFrancesco D, Mangoni M (1994) Modulation of single hyperpolarization-activated channels (i(f)) by cAMP in the rabbit sino-atrial node. *J Physiol* 474:473-482

21. DiFrancesco D, Tortora P (1991) Direct activation of cardiac pacemaker channels by intracellular cyclic AMP. *Nature* 351:145-147

22. Drici MD, Arrighi I, Chouabe C, Mann JR, Lazdunski M, Romey G, Barhanin J (1998) Involvement of IsK-associated K⁺ channel in heart rate control of repolarization in a murine engineered model of Jervell and Lange-Nielsen syndrome. *Circ Res* 83:95-102. doi:10.1161/01.res.83.1.95

23. Gueguinou M, Chantome A, Fromont G, Bougnoux P, Vandier C, Potier-Cartereau M (2014) KCa and Ca(2+) channels: the complex thought. *Biochim Biophys Acta* 1843:2322-2333. doi:10.1016/j.bbamcr.2014.02.019

24. Haron-Khun S, Weisbrod D, Bueno H, Yadin D, Behar J, Peretz A, Binah O, Hochhauser E, Eldar M, Yaniv Y, Arad M, Attali B (2017) SK4 K(+) channels are therapeutic targets for the treatment of cardiac arrhythmias. *EMBO Mol Med* 9:415-429. doi:10.15252/emmm.201606937

25. Hoda JC, Zaghetto F, Koschak A, Striessnig J (2005) Congenital stationary night blindness type 2 mutations S229P, G369D, L1068P, and W1440X alter channel gating or functional expression of Ca(v)1.4 L-type Ca²⁺ channels. *J Neurosci* 25:252-259. doi:10.1523/JNEUROSCI.3054-04.2005
26. Hu K, Qu Y, Yue Y, Boutjdir M (2004) Functional basis of sinus bradycardia in congenital heart block. *Circ Res* 94:e32-38
27. Hund TJ, Mohler PJ (2008) Ankyrin-based targeting pathway regulates human sinoatrial node automaticity. *Channels (Austin)* 2:404-406. doi:7220 [pii]
28. Jensen PN, Gronroos NN, Chen LY, Folsom AR, deFilippi C, Heckbert SR, Alonso A (2014) Incidence of and risk factors for sick sinus syndrome in the general population. *J Am Coll Cardiol* 64:531-538. doi:S0735-1097(14)02843-5 [pii]
10.1016/j.jacc.2014.03.056
29. Ju YK, Chu Y, Chaulet H, Lai D, Gervasio OL, Graham RM, Cannell MB, Allen DG (2007) Store-operated Ca²⁺ influx and expression of TRPC genes in mouse sinoatrial node. *Circ Res* 100:1605-1614
30. Karnabi E, Boutjdir M (2010) Role of calcium channels in congenital heart block. *Scand J Immunol* 72:226-234. doi:10.1111/j.1365-3083.2010.02439.x
31. Karnabi E, Qu Y, Mancarella S, Boutjdir M (2011) Rescue and worsening of congenital heart block-associated electrocardiographic abnormalities in two transgenic mice. *J Cardiovasc Electrophysiol* 22:922-930. doi:10.1111/j.1540-8167.2011.02032.x
32. Karnabi E, Qu Y, Wadgaonkar R, Mancarella S, Yue Y, Chahine M, Clancy RM, Buyon JP, Boutjdir M (2010) Congenital heart block: identification of autoantibody binding site on the extracellular loop (domain I, S5-S6) of alpha(1D) L-type Ca channel. *J Autoimmun* 34:80-86. doi:10.1016/j.jaut.2009.06.005
33. Kuss J, Stallmeyer B, Goldstein M, Rinne S, Pees C, Zumhagen S, Seebohm G, Decher N, Pott L, Kienitz MC, Schulze-Bahr E (2019) Familial Sinus Node Disease Caused by a Gain of GIRK (G-Protein Activated Inwardly Rectifying K(+) Channel) Channel Function. *Circ Genom Precis Med* 12:e002238. doi:10.1161/CIRCGEN.118.002238
34. Kusumoto FM, Schoenfeld MH, Barrett C, Edgerton JR, Ellenbogen KA, Gold MR, Goldschlager NF, Hamilton RM, Joglar JA, Kim RJ, Lee R, Marine JE, McLeod CJ, Oken KR, Patton KK, Pellegrini CN, Selzman KA, Thompson A, Varosy PD (2018) 2018 ACC/AHA/HRS Guideline on the Evaluation and Management of Patients With Bradycardia and Cardiac Conduction Delay: Executive Summary: A Report of the American College of Cardiology/American Heart Association Task Force on Clinical Practice Guidelines, and the Heart Rhythm Society. *J Am Coll Cardiol*. doi:10.1016/j.jacc.2018.10.043
35. Lai MH, Wu Y, Gao Z, Anderson ME, Dalziel JE, Meredith AL (2014) BK channels regulate sinoatrial node firing rate and cardiac pacing in vivo. *Am J Physiol Heart Circ Physiol* 307:H1327-1338. doi:10.1152/ajpheart.00354.2014
36. Lakatta EG, Maltsev VA, Vinogradova TM (2010) A coupled SYSTEM of intracellular Ca²⁺ clocks and surface membrane voltage clocks controls the timekeeping mechanism of the heart's pacemaker. *Circ Res* 106:659-673. doi:106/4/659 [pii]

10.1161/CIRCRESAHA.109.206078

37. Le Quang K, Benito B, Naud P, Qi XY, Shi YF, Tardif JC, Gillis MA, Dobrev D, Charpentier F, Nattel S (2013) T-type calcium current contributes to escape automaticity and governs the occurrence of lethal arrhythmias after atrioventricular block in mice. *Circ Arrhythm Electrophysiol* 6:799-808. doi:CIRCEP.113.000407 [pii]

10.1161/CIRCEP.113.000407

38. Le Scouarnec S, Bhasin N, Vieyres C, Hund TJ, Cunha SR, Koval O, Marionneau C, Chen B, Wu Y, Demolombe S, Song LS, Le Marec H, Probst V, Schott JJ, Anderson ME, Mohler PJ (2008) Dysfunction in ankyrin-B-dependent ion channel and transporter targeting causes human sinus node disease. *Proc Natl Acad Sci U S A* 105:15617-15622. doi:0805500105 [pii]

10.1073/pnas.0805500105

39. Lei M, Goddard C, Liu J, Leoni AL, Royer A, Fung SS, Xiao G, Ma A, Zhang H, Charpentier F, Vandenberg JI, Colledge WH, Grace AA, Huang CL (2005) Sinus node dysfunction following targeted disruption of the murine cardiac sodium channel gene *Scn5a*. *J Physiol* 567:387-400

40. Lei M, Jones SA, Liu J, Lancaster MK, Fung SS, Dobrzynski H, Camelliti P, Maier SK, Noble D, Boyett MR (2004) Requirement of neuronal- and cardiac-type sodium channels for murine sinoatrial node pacemaking. *J Physiol* 559:835-848

41. Li N, Kalyanasundaram A, Hansen BJ, Artiga EJ, Sharma R, Abudulwahed SH, Helfrich KM, Rozenberg G, Wu PJ, Zakharkin S, Gyorko S, Janssen PM, Whitson BA, Mokadam NA, Biesiadecki BJ, Accornero F, Hummel JD, Mohler PJ, Dobrzynski H, Zhao J, Fedorov VV (2020) Impaired neuronal sodium channels cause intranodal conduction failure and reentrant arrhythmias in human sinoatrial node. *Nat Commun* 11:512. doi:10.1038/s41467-019-14039-8

42. Li Y, Zhang X, Zhang C, Zhang X, Li Y, Qi Z, Szeto C, Tang M, Peng Y, Molkentin JD, Houser SR, Xie M, Chen X (2018) Increasing T-type calcium channel activity by beta-adrenergic stimulation contributes to beta-adrenergic regulation of heart rates. *J Physiol* 596:1137-1151. doi:10.1113/JP274756

43. Liaqat K, Schrauwen I, Raza SI, Lee K, Hussain S, Chakchouk I, Nasir A, Acharya A, Abbe I, Umair M, Ansar M, Ullah I, Shah K, Bamshad MJ, Nickerson DA, Ahmad W, Leal SM (2019) Identification of *CACNA1D* variants associated with sinoatrial node dysfunction and deafness in additional Pakistani families reveals a clinical significance. *J Hum Genet* 64:153-160. doi:10.1038/s10038-018-0542-8

44. Linscheid N, Logantha S, Poulsen PC, Zhang S, Schrolkamp M, Egerod KL, Thompson JJ, Kitmitto A, Galli G, Humphries MJ, Zhang H, Pers TH, Olsen JV, Boyett M, Lundby A (2019) Quantitative proteomics and single-nucleus transcriptomics of the sinus node elucidates the foundation of cardiac pacemaking. *Nat Commun* 10:2889. doi:10.1038/s41467-019-10709-9

45. Maier SK, Westenbroek RE, Yamanushi TT, Dobrzynski H, Boyett MR, Catterall WA, Scheuer T (2003) An unexpected requirement for brain-type sodium channels for control of heart rate in the mouse sinoatrial node. *Proc Natl Acad Sci U S A* 100:3507-3512

46. Mancarella S, Yue Y, Karnabi E, Qu Y, El-Sherif N, Boutjdir M (2008) Impaired Ca²⁺ homeostasis is associated with atrial fibrillation in the alpha1D L-type Ca²⁺ channel KO mouse. *Am J Physiol Heart Circ Physiol* 295:H2017-2024. doi:10.1152/ajpheart.00537.2008

47. Mangoni ME, Couette B, Bourinet E, Platzer J, Reimer D, Striessnig J, Nargeot J (2003) Functional role of L-type Cav1.3 Ca²⁺ channels in cardiac pacemaker activity. *Proc Natl Acad Sci U S A* 100:5543-5548
48. Mangoni ME, Couette B, Marger L, Bourinet E, Striessnig J, Nargeot J (2006) Voltage-dependent calcium channels and cardiac pacemaker activity: From ionic currents to genes. *Prog Biophys Mol Biol* 90:38-63
49. Mangoni ME, Nargeot J (2001) Properties of the hyperpolarization-activated current (I_f) in isolated mouse sino-atrial cells. *Cardiovasc Res* 52:51-64
50. Mangoni ME, Nargeot J (2008) Genesis and regulation of the heart automaticity. *Physiol Rev* 88:919-982
51. Mangoni ME, Striessnig J, Platzer J, Nargeot J. (2001) Pacemaker currents in mouse pacemaker cells. *Circulation* 104:R1047
52. Mangoni ME, Traboulsie A, Leoni AL, Couette B, Marger L, Le Quang K, Kupfer E, Cohen-Solal A, Vilar J, Shin HS, Escande D, Charpentier F, Nargeot J, Lory P (2006) Bradycardia and slowing of the atrioventricular conduction in mice lacking Ca_v3.1/alpha1G T-type calcium channels. *Circ Res* 98:1422-1430
53. Marger L, Mesirca P, Alig J, Torrente A, Dubel S, Engeland B, Kanani S, Fontanaud P, Striessnig J, Shin HS, Isbrandt D, Ehmke H, Nargeot J, Mangoni ME (2011) Functional roles of Ca_v(v)1.3, Ca_v(v)3.1 and HCN channels in automaticity of mouse atrioventricular cells: insights into the atrioventricular pacemaker mechanism. *Channels (Austin)* 5:251-261. doi:15266 [pii]
54. Mesirca P, Bidaud I, Briec F, Evain S, Torrente AG, Le Quang K, Leoni AL, Baudot M, Marger L, Chung You Chong A, Nargeot J, Striessnig J, Wickman K, Charpentier F, Mangoni ME (2016) G protein-gated IK_{ACh} channels as therapeutic targets for treatment of sick sinus syndrome and heart block. *Proc Natl Acad Sci U S A* 113:E932-941. doi:1517181113 [pii]
- 10.1073/pnas.1517181113
55. Mesirca P, Marger L, Toyoda F, Rizzetto R, Audoubert M, Dubel S, Torrente AG, Difrancesco ML, Muller JC, Leoni AL, Couette B, Nargeot J, Clapham DE, Wickman K, Mangoni ME (2013) The G-protein-gated K⁺ channel, IK_{ACh}, is required for regulation of pacemaker activity and recovery of resting heart rate after sympathetic stimulation. *J Gen Physiol* 142:113-126. doi:jgp.201310996 [pii]
- 10.1085/jgp.201310996
56. Mesirca P, Torrente AG, Mangoni ME (2015) Functional role of voltage gated Ca_v(2⁺) channels in heart automaticity. *Front Physiol* 6:19. doi:10.3389/fphys.2015.00019
57. Mohler PJ, Schott JJ, Gramolini AO, Dilly KW, Guatimosim S, duBell WH, Song LS, Haurogne K, Kyndt F, Ali ME, Rogers TB, Lederer WJ, Escande D, Le Marec H, Bennett V (2003) Ankyrin-B mutation causes type 4 long-QT cardiac arrhythmia and sudden cardiac death. *Nature* 421:634-639. doi:10.1038/nature01335
58. Monfredi O, Boyett MR (2015) Sick sinus syndrome and atrial fibrillation in older persons - A view from the sinoatrial nodal myocyte. *J Mol Cell Cardiol*. doi:S0022-2828(15)00040-1 [pii]
- 10.1016/j.yjmcc.2015.02.003

59. Monfredi O, Maltsev VA, Lakatta EG (2013) Modern concepts concerning the origin of the heartbeat. *Physiology (Bethesda)* 28:74-92. doi:28/2/74 [pii]
10.1152/physiol.00054.2012
60. Neyroud N, Tesson F, Denjoy I, Leibovici M, Donger C, Barhanin J, Faure S, Gary F, Coumel P, Petit C, Schwartz K, Guicheney P (1997) A novel mutation in the potassium channel gene KVLQT1 causes the Jervell and Lange-Nielsen cardioauditory syndrome. *Nat Genet* 15:186-189. doi:10.1038/ng0297-186
61. Pinggera A, Lieb A, Benedetti B, Lampert M, Monteleone S, Liedl KR, Tuluc P, Striessnig J (2015) CACNA1D de novo mutations in autism spectrum disorders activate Cav1.3 L-type calcium channels. *Biol Psychiatry* 77:816-822. doi:10.1016/j.biopsych.2014.11.020
62. Pinggera A, Mackenroth L, Rump A, Schallner J, Beleggia F, Wollnik B, Striessnig J (2017) New gain-of-function mutation shows CACNA1D as recurrently mutated gene in autism spectrum disorders and epilepsy. *Hum Mol Genet* 26:2923-2932. doi:10.1093/hmg/ddx175
63. Platzer J, Engel J, Schrott-Fischer A, Stephan K, Bova S, Chen H, Zheng H, Striessnig J (2000) Congenital deafness and sinoatrial node dysfunction in mice lacking class D L-type Ca²⁺ channels. *Cell* 102:89-97
64. Qu Y, Baroudi G, Yue Y, Boutjdir M (2005) Novel molecular mechanism involving alpha1D (Cav1.3) L-type calcium channel in autoimmune-associated sinus bradycardia. *Circulation* 111:3034-3041
65. Qu Y, Xiao GQ, Chen L, Boutjdir M (2001) Autoantibodies from mothers of children with congenital heart block downregulate cardiac L-type Ca channels. *J Mol Cell Cardiol* 33:1153-1163
66. Qu YS, Lazzerini PE, Capecchi PL, Laghi-Pasini F, El Sherif N, Boutjdir M (2019) Autoimmune Calcium Channelopathies and Cardiac Electrical Abnormalities. *Front Cardiovasc Med* 6:54. doi:10.3389/fcvm.2019.00054
67. Restivo M, Kozhevnikov DO, Boutjdir M (2001) Optical mapping of activation patterns in an animal model of congenital heart block. *Am J Physiol Heart Circ Physiol* 280:H1889-1895. doi:10.1152/ajpheart.2001.280.4.H1889
68. Sah R, Mesirca P, Mason X, Gibson W, Bates-Withers C, Van den Boogert M, Chaudhuri D, Pu WT, Mangoni ME, Clapham DE (2013) Timing of myocardial trpm7 deletion during cardiogenesis variably disrupts adult ventricular function, conduction, and repolarization. *Circulation* 128:101-114. doi:CIRCULATIONAHA.112.000768 [pii]
10.1161/CIRCULATIONAHA.112.000768
69. Sah R, Mesirca P, Van den Boogert M, Rosen J, Mably J, Mangoni ME, Clapham DE (2013) Ion channel-kinase TRPM7 is required for maintaining cardiac automaticity. *Proc Natl Acad Sci U S A* 110:E3037-3046. doi:1311865110 [pii]
10.1073/pnas.1311865110
70. Scholl UI, Stolting G, Nelson-Williams C, Vichot AA, Choi M, Loring E, Prasad ML, Goh G, Carling T, Juhlin CC, Quack I, Rump LC, Thiel A, Lande M, Frazier BG, Rasoulpour M, Bowlin DL, Sethna CB, Trachtman H, Fahlke C, Lifton RP (2015) Recurrent gain of function mutation

in calcium channel CACNA1H causes early-onset hypertension with primary aldosteronism. *Elife* 4:e06315. doi:10.7554/eLife.06315

71. Shi W, Wymore R, Yu H, Wu J, Wymore RT, Pan Z, Robinson RB, Dixon JE, McKinnon D, Cohen IS (1999) Distribution and prevalence of hyperpolarization-activated cation channel (HCN) mRNA expression in cardiac tissues. *Circ Res* 85:e1-6

72. Sinnegger-Brauns MJ, Hetzenauer A, Huber IG, Renstrom E, Wietzorrek G, Berjukov S, Cavalli M, Walter D, Koschak A, Waldschutz R, Hering S, Bova S, Rorsman P, Pongs O, Singewald N, Striessnig JJ (2004) Isoform-specific regulation of mood behavior and pancreatic beta cell and cardiovascular function by L-type Ca²⁺ channels. *J Clin Invest* 113:1430-1439

73. Splawski I, Timothy KW, Sharpe LM, Decher N, Kumar P, Bloise R, Napolitano C, Schwartz PJ, Joseph RM, Condouris K, Tager-Flusberg H, Priori SG, Sanguinetti MC, Keating MT (2004) Ca(V)_{1.2} calcium channel dysfunction causes a multisystem disorder including arrhythmia and autism. *Cell* 119:19-31

74. Strandberg LS, Cui X, Rath A, Liu J, Silverman ED, Liu X, Siragam V, Ackerley C, Su BB, Yan JY, Capecci M, Biavati L, Accorroni A, Yuen W, Quattrone F, Lung K, Jaeggi ET, Backx PH, Deber CM, Hamilton RM (2013) Congenital heart block maternal sera autoantibodies target an extracellular epitope on the alpha1G T-type calcium channel in human fetal hearts. *PLoS One* 8:e72668. doi:10.1371/journal.pone.0072668

75. Tan GC, Negro G, Pinggera A, Tizen Laim NMS, Mohamed Rose I, Ceral J, Ryska A, Chin LK, Kamaruddin NA, Mohd Mokhtar N, AR AJ, Sukor N, Solar M, Striessnig J, Brown MJ, Azizan EA (2017) Aldosterone-Producing Adenomas: Histopathology-Genotype Correlation and Identification of a Novel CACNA1D Mutation. *Hypertension* 70:129-136. doi:10.1161/HYPERTENSIONAHA.117.09057

76. ten Velde I, de Jonge B, Verheijck EE, van Kempen MJ, Analbers L, Gros D, Jongsma HJ (1995) Spatial distribution of connexin43, the major cardiac gap junction protein, visualizes the cellular network for impulse propagation from sinoatrial node to atrium. *Circ Res* 76:802-811

77. Torrente AG, Mesirca P, Neco P, Rizzetto R, Dubel S, Barrere C, Sinnegger-Brauns M, Striessnig J, Richard S, Nargeot J, Gomez AM, Mangoni ME (2016) L-type Cav1.3 channels regulate ryanodine receptor-dependent Ca²⁺ release during sino-atrial node pacemaker activity. *Cardiovasc Res* 109:451-461. doi:cvw006 [pii]

10.1093/cvr/cvw006

78. Torrente AG, Zhang R, Wang H, Zaini A, Kim B, Yue X, Philipson KD, Goldhaber JI (2017) Contribution of small conductance K(+) channels to sinoatrial node pacemaker activity: insights from atrial-specific Na(+) /Ca(2+) exchange knockout mice. *J Physiol* 595:3847-3865. doi:10.1113/JP274249

79. Torrente AG, Zhang R, Wang H, Zaini A, Kim B, Yue X, Philipson KD, Goldhaber JI (2017) Contribution of small conductance K⁺ channels to sinoatrial node pacemaker activity: insights from atrial-specific Na⁺ /Ca²⁺ exchange knockout mice. *J Physiol*. doi:10.1113/JP274249

80. Toyoda F, Mesirca P, Dubel S, Ding WG, Striessnig J, Mangoni ME, Matsuura H (2017) CaV1.3 L-type Ca²⁺ channel contributes to the heartbeat by generating a dihydropyridine-sensitive persistent Na⁺ current. *Sci Rep* 7:7869. doi:10.1038/s41598-017-08191-8

10.1038/s41598-017-08191-8 [pii]

81. Verheijck EE, van Kempen MJ, Veereschild M, Lurvink J, Jongasma HJ, Bouman LN (2001) Electrophysiological features of the mouse sinoatrial node in relation to connexin distribution. *Cardiovasc Res* 52:40-50

82. Verheijck EE, Wessels A, van Ginneken AC, Bourier J, Markman MW, Vermeulen JL, de Bakker JM, Lamers WH, Opthof T, Bouman LN (1998) Distribution of atrial and nodal cells within the rabbit sinoatrial node: models of sinoatrial transition. *Circulation* 97:1623-1631

83. Wickman K, Nemeč J, Gendler SJ, Clapham DE (1998) Abnormal heart rate regulation in GIRK4 knockout mice. *Neuron* 20:103-114

84. Zhang Q, Timofeyev V, Lu L, Li N, Singapuri A, Long MK, Bond CT, Adelman JP, Chiamvimonvat N (2008) Functional roles of a Ca²⁺-activated K⁺ channel in atrioventricular nodes. *Circ Res* 102:465-471. doi:CIRCRESAHA.107.161778 [pii]

10.1161/CIRCRESAHA.107.161778

85. Zhang XD, Coulibaly ZA, Chen WC, Ledford HA, Lee JH, Sirish P, Dai G, Jian Z, Chuang F, Brust-Mascher I, Yamoah EN, Chen-Izu Y, Izu LT, Chiamvimonvat N (2018) Coupling of SK channels, L-type Ca(2+) channels, and ryanodine receptors in cardiomyocytes. *Sci Rep* 8:4670. doi:10.1038/s41598-018-22843-3

86. Zhang Z, Xu Y, Song H, Rodriguez J, Tuteja D, Namkung Y, Shin HS, Chiamvimonvat N (2002) Functional Roles of Ca(v)1.3 (alpha(1D)) calcium channel in sinoatrial nodes: insight gained using gene-targeted null mutant mice. *Circ Res* 90:981-987.

Figure 1. Summary representation of SAN pacemaker activity. (A) Schematic drawing of a mouse SAN pacemaker cell showing the principal membrane receptors and ion channels together with RyR₂, the SR calcium pump SERCA and the Na⁺/Ca²⁺ exchanger (NCX1). Two of the most important protein kinases involved in regulation of pacemaker activity by the autonomic nervous system, the PKA and CaMKII, are shown. (B) Simulated transmembrane voltage during a spontaneous action potential (AP) generated by a computational model of mouse SAN pacemaking [15]. The other panels show calculated ionic currents during the AP. The following ionic currents are shown: funny current (I_f), (mediated by HCN family members), Cav1.3- and Cav1.2-mediated I_{CaL} , sustained inward Na⁺ current I_{st} , Ca_v3.1-mediated I_{CaT} , fast TTX-sensitive Na⁺ current (I_{Na}) (mediated by Na_v1.1), and delayed rectifier K⁺ current (mediated by the cardiac *ERG1* gene). The current scale of I_{CaL} , I_{st} and I_{CaT} have been expanded to show the predicted current flow in the diastolic depolarization (DD). Note activation of Cav1.3-mediated I_{CaL} and I_{st} at diastolic voltages. The simulation shows the sum of Cav1.3-mediated I_{CaL} and I_{st} because these two currents share Cav1.3 as a common molecular determinant [80].

Figure 2. The SANDD p.403-404InsGly mutation silences heterologously expressed Cav1.3-mediated I_{CaL} . (A) General transmembrane topology of the $\alpha 1$ subunit of VGCCs. The approximate position of the insertion mutation p.403-404InsGly is indicated by the red dot. (B) Current-to-voltage relationships of Ba²⁺ currents for wild-type containing regular exon 8B (black) or mutant 8B_m variant (gray) channels, and mock-transfected controls (triangles) tsA cells. From ref. [1]: Baig et al. (2011) *Loss of Cav1.3 (CACNA1D) function in a human channelopathy with bradycardia and congenital deafness*. Nat Neurosci 14:77-84.

Figure 3. SND and atrioventricular dysfunctions of SANDD patients are recapitulated in *Cav1.3*^{-/-} mice. (A). Sample ECG recordings from an unaffected family member (a) and three individuals who are homozygous for the *CACNA1D* mutation (b–d). In b and c, asterisks mark P waves that precede QRS complexes; arrows indicate waveforms that suggest P waves coinciding with T waves. Numbers indicate heart rate (bpm) calculated from the corresponding beat-to-beat RR interval. From ref. [1]: Baig et al. (2011) *Loss of Cav1.3 (CACNA1D) function in a human channelopathy with bradycardia and congenital deafness*. Nat Neurosci 14:77-84. (B). Original ECG recordings from a wild-type (a) and *Cav1.3*^{-/-} (b) mouse. Asterisks represent conducted P waves as in (A), while (#) symbols mark non conducted atrial depolarisations. Arrow indicate P waves falling in correspondence of T waves. These ECG hallmarks in mice are predominantly generated by I_{KACb} activation (see Figure 6).

Figure 4. Sample recordings of I_{Ca} aligned with line scan imaging of intracellular Ca²⁺ ([Ca²⁺]_i) release in single SAN cells. (A) Sample of mouse SAN cell AP applied as voltage command. The right panels show close-up view of the diastolic AP phase. (B) Sample traces of the corresponding net I_{Ca} in wild-type (WT) and *Cav1.3*^{-/-} SAN cells before and after perfusion of Nifedipine (Nife, 3 μ M). The right panels show the diastolic Ca²⁺ influx in faster time scale. Note the strong decrease of I_{Ca} in recordings from *Cav1.3*^{-/-} cells, due to ablation of diastolic Cav1.3-mediated I_{CaL} . (C) Time-integral of [Ca²⁺]_i fluorescence corresponding to the line scans below. Note the presence of an ascending ramp phase of [Ca²⁺]_i release in the wild-type cell. The ramp is generated by local Ca²⁺ release (LCR) preceding cell-wide [Ca²⁺]_i transients. (D) 2D line-scan of

wild-type and *Cav1.3*^{-/-} SAN cells. Line-scan insets: 3D reconstruction of diastolic [Ca²⁺]_i release. a.u.=arbitrary units. White arrows indicate late diastolic LCRs. From ref. [77]: Torrente et al. (2016) *L-type Cav1.3 channels regulate ryanodine receptor-dependent Ca²⁺ release during sino-atrial node pacemaker activity*. Cardiovasc Res 109:451-461.

Figure 5. Cav1.3-mediated synchronization of LCRs under β -adrenergic stimulation of pacemaking. (A) and (B): Line-scans (upper panel) and corresponding time-integrals (bottom panels) of fluorescence before (Contr) and after perfusion of the β -adrenergic agonist isoproterenol (ISO 10 nM) in single SAN cells of wild-type and *Cav1.3*^{-/-} mice. Note the ramp slope before and after β -adrenergic stimulation of wild-type cells (short lines in red and gray indicated ramps of wild-type and *Cav1.3*^{-/-} mice. (C) and (D): Cav1.3-mediated synchronization of LCRs events measured as the correlation between ramp amplitude (defined as the ratio between the fluorescence at the end and at the beginning of the ramp) and ramp length (interval between the beginning and the end of the ramp) in wild-type and *Cav1.3*^{-/-} cells. The straight line show linear regression of data. Pearson's coefficient calculation indicates significant correlation between ramp amplitude and length following ISO in wild-type cells but not in *Cav1.3*^{-/-} cells. From: ref. [77]: Torrente et al. (2016) *L-type Cav1.3 channels regulate ryanodine receptor-dependent Ca²⁺ release during sino-atrial node pacemaker activity*. Cardiovasc Res 109:451-461.

Figure 6. Rescuing SND and atrioventricular dysfunction by I_{KACH} targeting. (A). This schematic representation depicts the balance between inward and outward currents determining the SAN diastolic depolarization and heart rhythm. In each panel, a sample of SAN spontaneous action potentials (Top), ion channels contributing to the diastolic depolarization (Middle), and sample of ECG recordings (Bottom) are shown. Green channels represents I_{KACH} , red channel represents Cav1.3-mediated I_{CaL} ($I_{Cav1.3}$), and the light-blue circles shows the idealized sum of other inward currents involved in automaticity (e.g. NCX1, I_f , I_{CaT} , TRPM4...). Adapted from reference (35), with permission by Whiley and Son. From: ref. [54] Mesirca et al. (2016) *G protein-gated I_{KACH} channels as therapeutic targets for treatment of sick sinus syndrome and heart block*. Proc Natl Acad Sci U S A 113:E932-941.

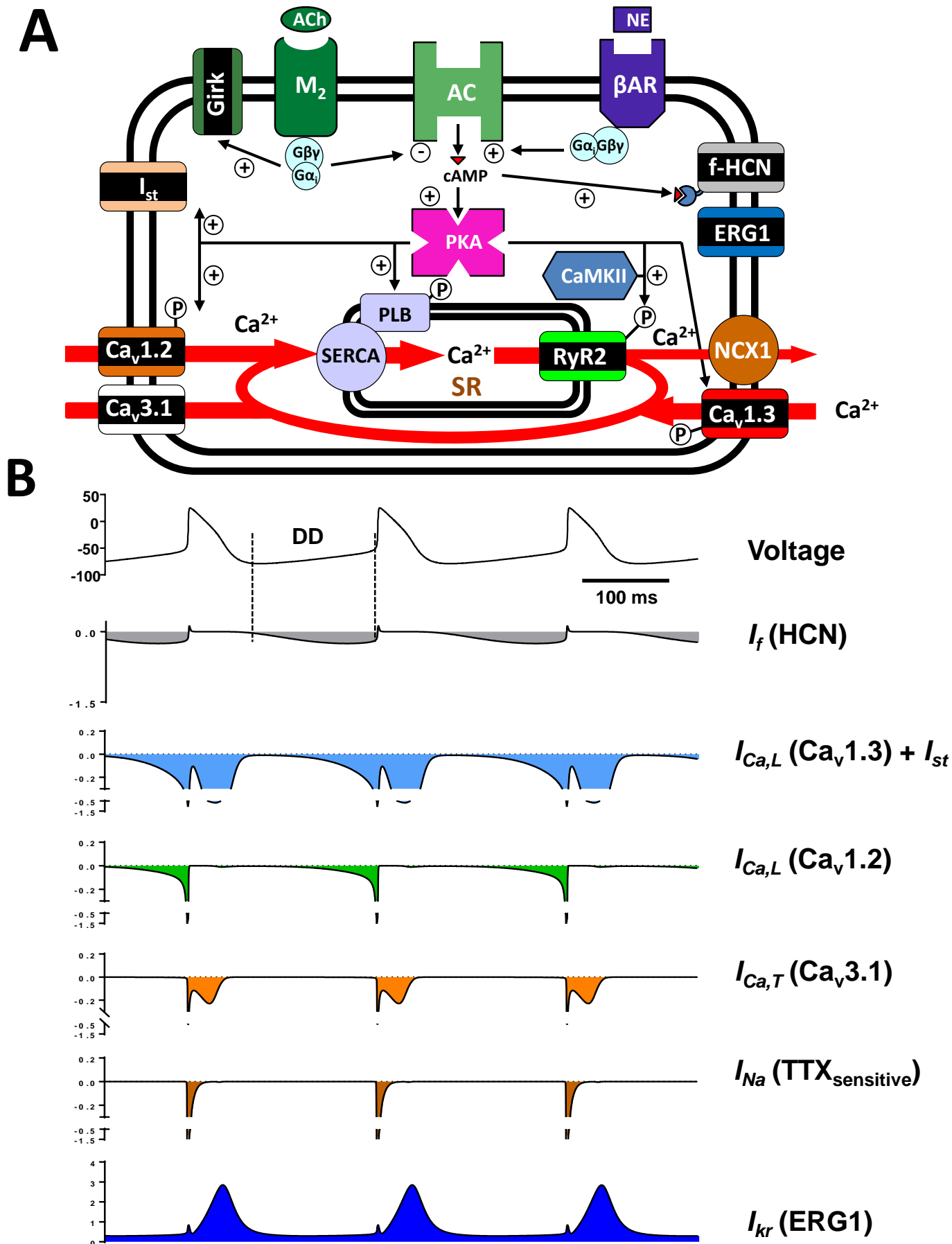
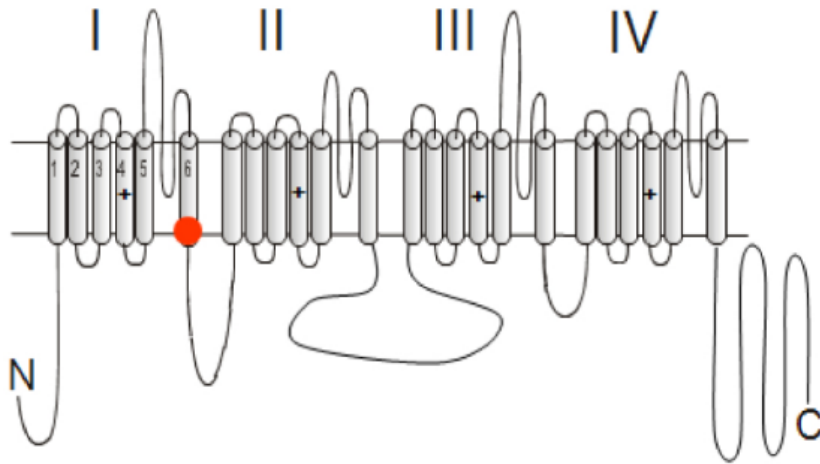


Figure 1

A

Ca_v1.3



B

Ca_v1.3 –mediated *I*_{CaL}

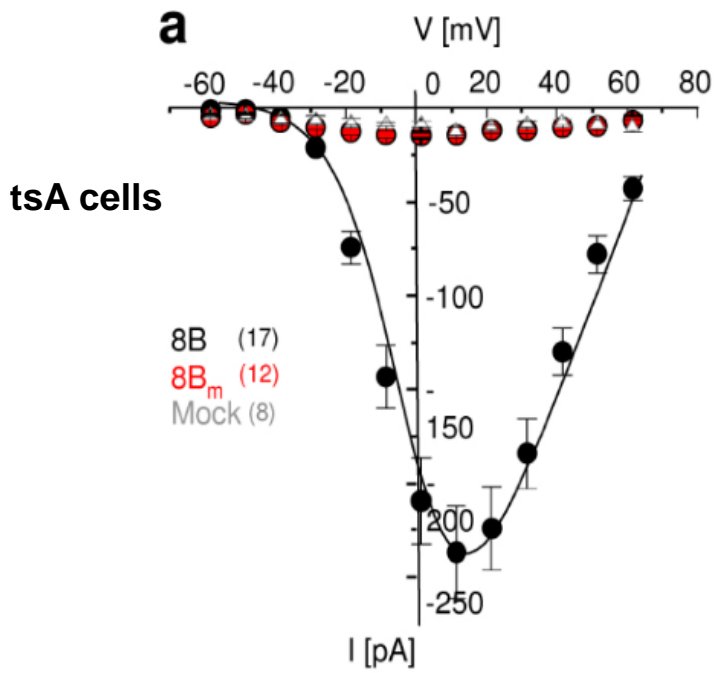


Figure 2

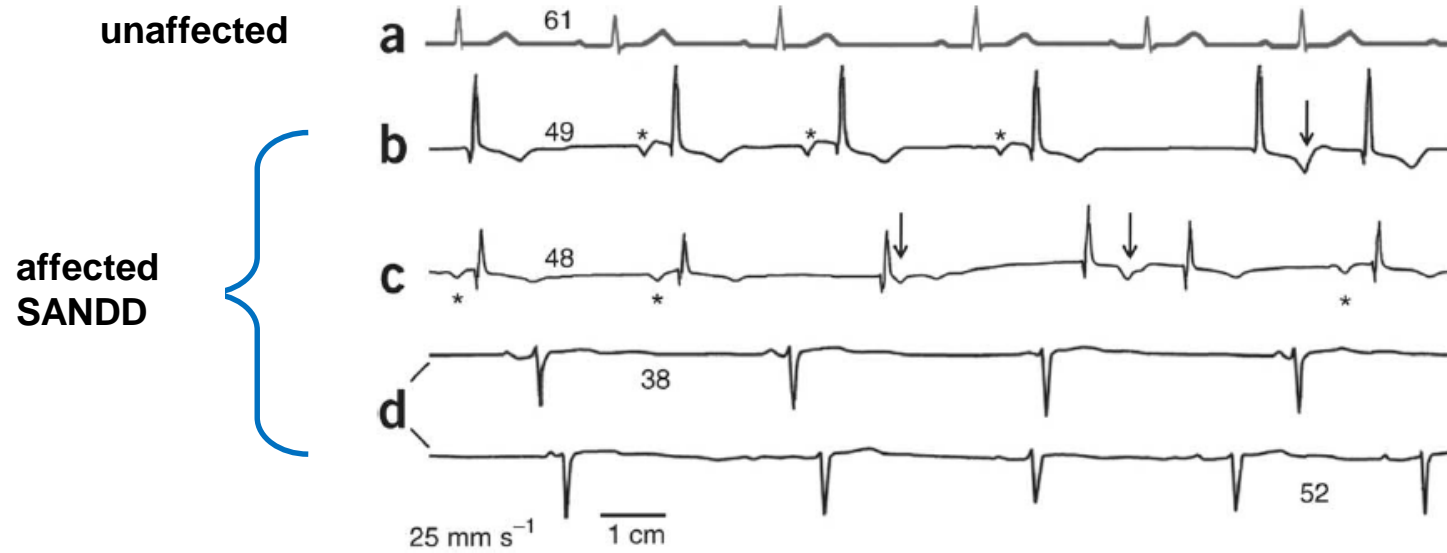
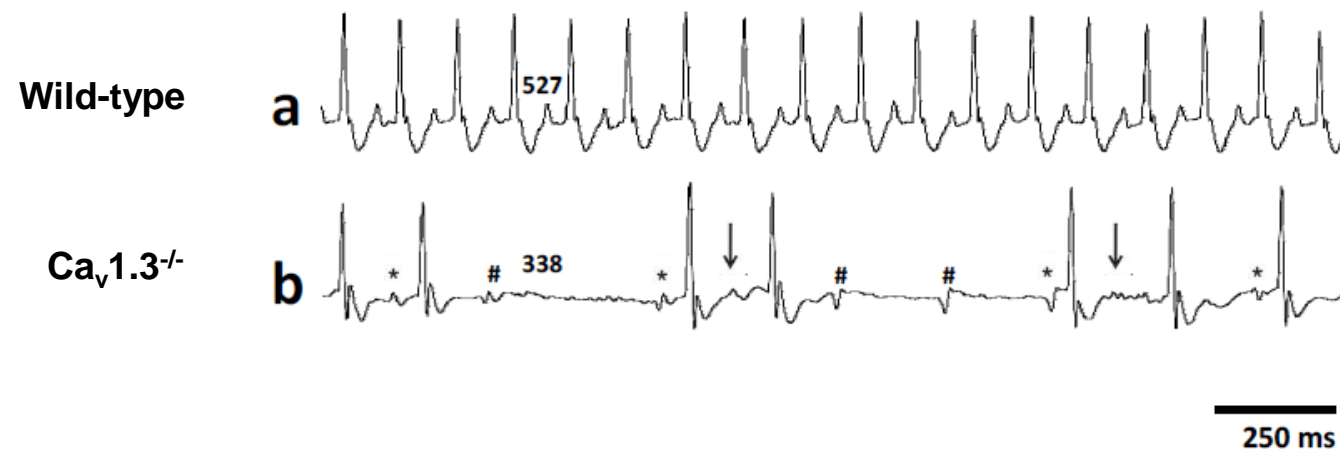
A**B**

Figure 3

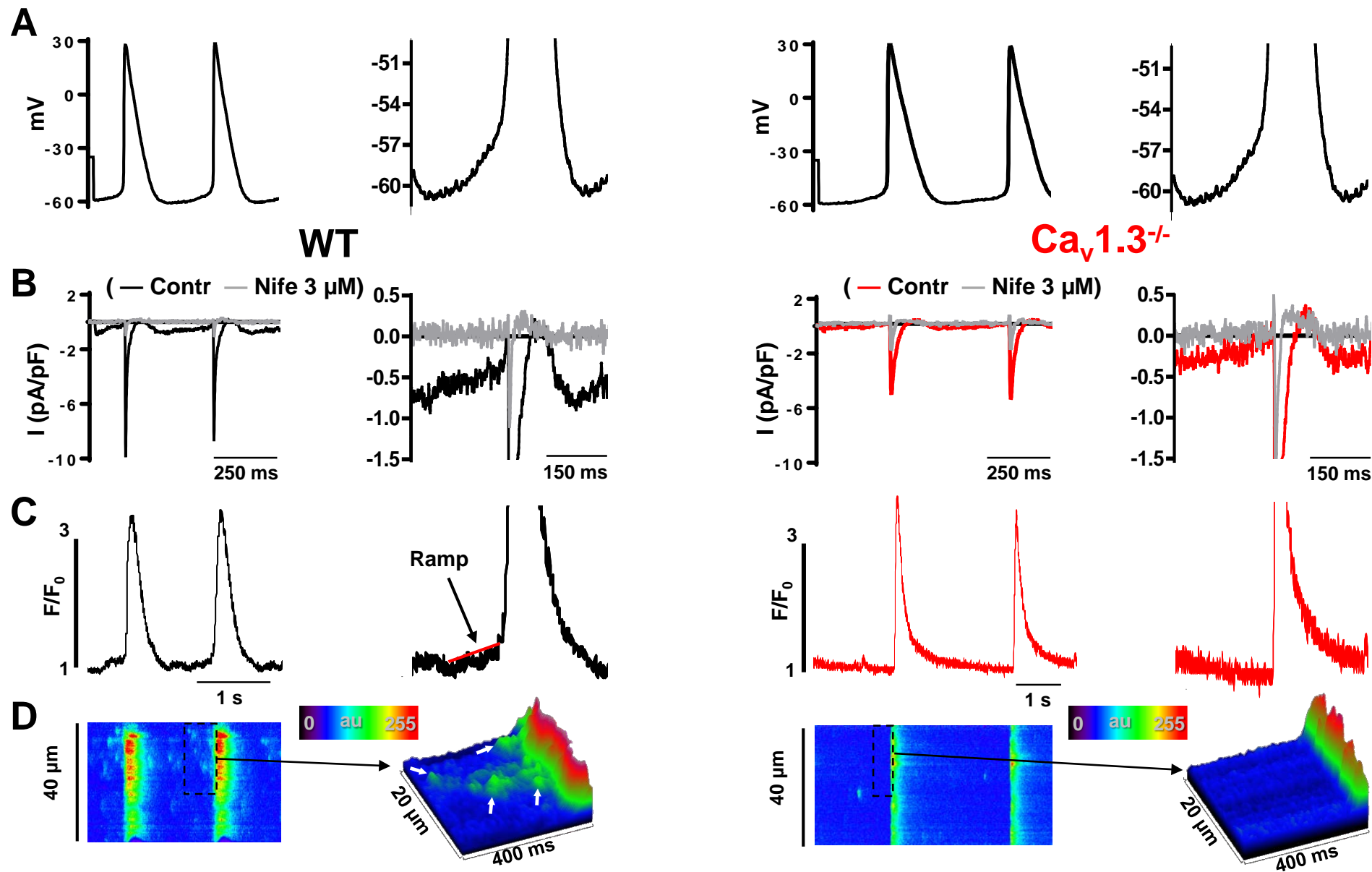


Figure 4

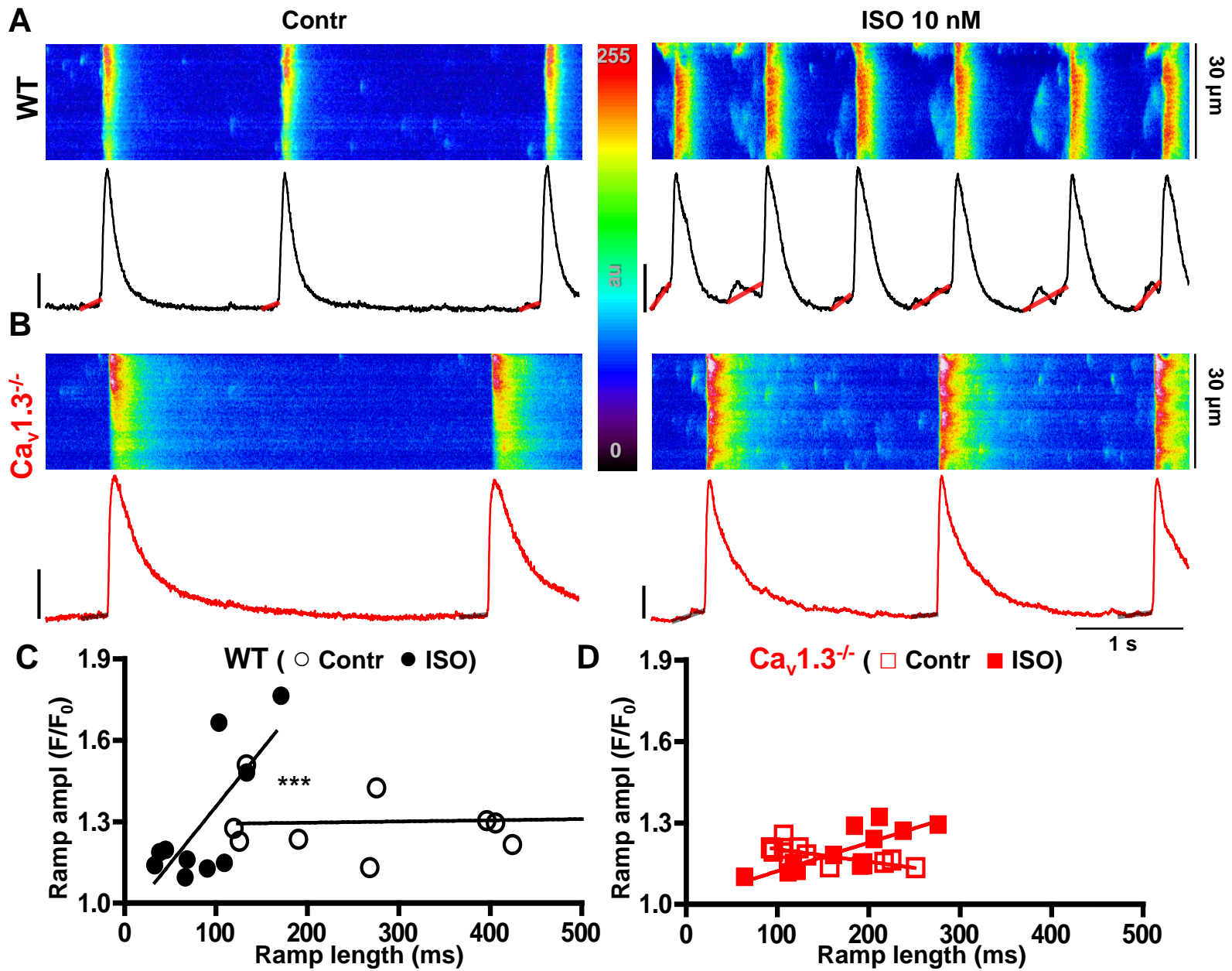


Figure 5

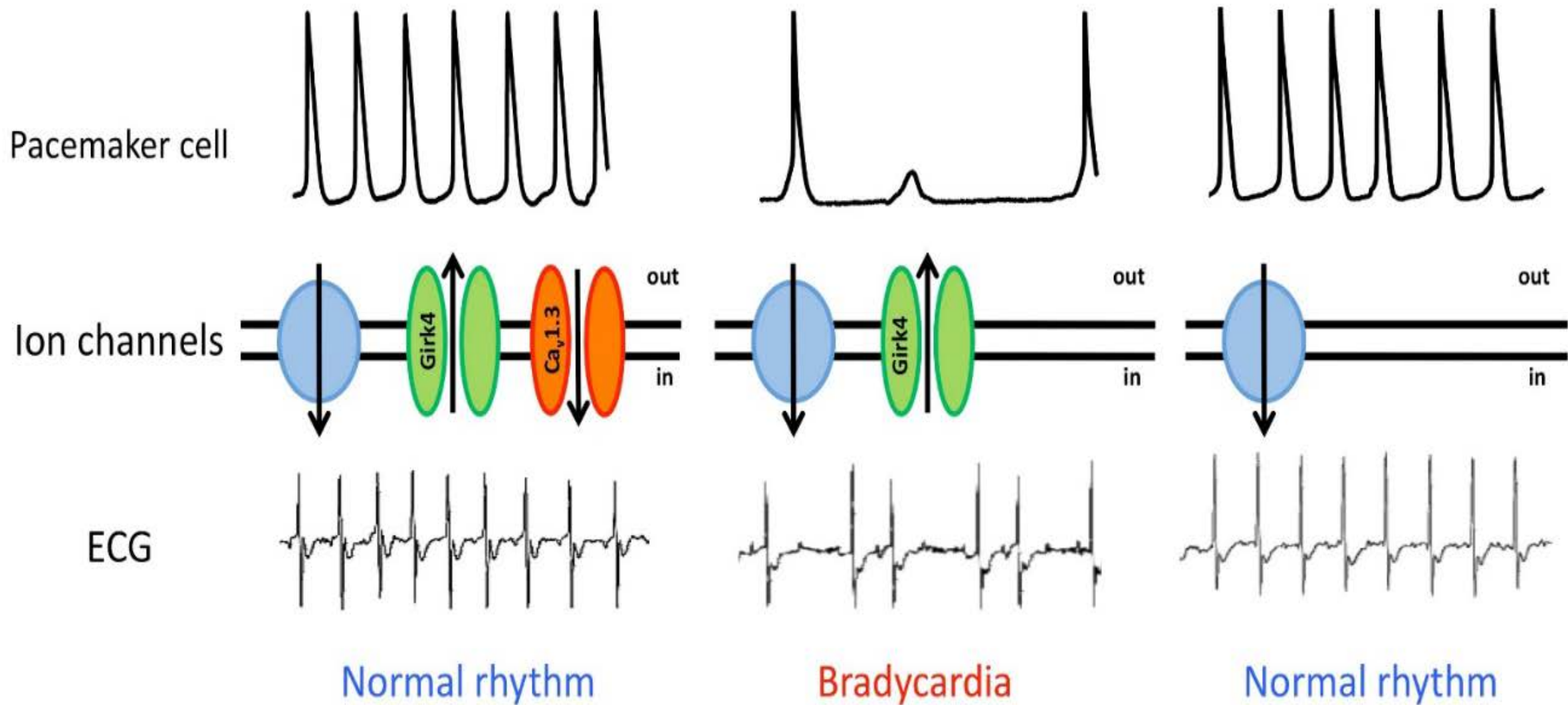


Figure 6