



HAL
open science

Structure-based semantics of argumentation frameworks with higher-order attacks and supports

Claudette Cayrol, Jorge Fandinno, Luis Fariñas del Cerro, Marie-Christine
Lagasquie-Schiex

► **To cite this version:**

Claudette Cayrol, Jorge Fandinno, Luis Fariñas del Cerro, Marie-Christine Lagasquie-Schiex. Structure-based semantics of argumentation frameworks with higher-order attacks and supports. [Research Report] IRIT-2018-05, IRIT - Institut de recherche en informatique de Toulouse. 2018. hal-02884147

HAL Id: hal-02884147

<https://hal.science/hal-02884147>

Submitted on 29 Jun 2020

HAL is a multi-disciplinary open access archive for the deposit and dissemination of scientific research documents, whether they are published or not. The documents may come from teaching and research institutions in France or abroad, or from public or private research centers.

L'archive ouverte pluridisciplinaire **HAL**, est destinée au dépôt et à la diffusion de documents scientifiques de niveau recherche, publiés ou non, émanant des établissements d'enseignement et de recherche français ou étrangers, des laboratoires publics ou privés.

Structure-based semantics of argumentation frameworks with higher-order attacks and supports

Claudette Cayrol,
Jorge Fandinno*,
Luis Fariñas del Cerro,
M-Christine Lagasquie-Schiex

Université de Toulouse, IRIT,
118 route de Narbonne, 31062 Toulouse, France
{ccayrol, jorge.fandinno, luis, lagasq}@irit.fr

Tech. Report
IRIT/RR- -2018- -05- -FR

*The second author is funded by the Centre International de Mathématiques et d'Informatique de Toulouse (CIMI) through contract ANR-11-LABEX-0040-CIMI within the program ANR-11-IDEX-0002-02.

Abstract

In this paper, we propose a generalisation of Dung's abstract argumentation framework that allows representing higher-order attacks and supports, that is attacks or supports whose targets are other attacks or supports. We follow the necessary interpretation of the support, based on the intuition that the acceptance of an argument requires the acceptance of each supporter. We propose semantics accounting for acceptability of arguments and validity of interactions, where the standard notion of extension is replaced by a triple of a set of arguments, a set of attacks and a set of supports. Our framework is a conservative generalisation of Argumentation Frameworks with Necessities (AFN). When supports are ignored, Argumentation Frameworks with Recursive Attacks are recovered.

Contents

1	Introduction	1
2	Background	2
3	Handling higher-order necessary supports	5
4	Related works	10
5	Conclusion	12
A	Examples	14
A.1	Examples used in Comma paper	15
A.2	Some other examples	21
B	Proofs	46

1 Introduction

Abstract argumentation frameworks have greatly eased the modelling and study of argumentation. Whereas Dung’s framework [11] only accounts for an attack relation between arguments, two natural generalisations have been developed in order to allow positive interactions (usually expressed by a support relation) and higher-order interactions (attacks or supports that target other attacks or supports). Here is an example in the legal field, borrowed from [1], that illustrates both generalisations (this example corresponds to a dynamic process of exchange of pieces of information, each one being considered as an “argument”).

Ex. 1 *The prosecutor says that the defendant has intention to kill the victim (argument b). A witness says that she saw the defendant throwing a sharp knife towards the victim (argument a). Argument a can be considered as a support for argument b. The lawyer argues back that the defendant was in a habit of throwing the knife at his wife’s foot once drunk. This latter argument (argument c) is better considered attacking the support from a to b, than arguments a or b themselves. Now the prosecutor’s argumentation seems no longer sufficient for proving the intention to kill.*

Different interpretations for the notion of support were proposed: deductive support [3], evidential support [15], necessary support [14], that are compared in [7, 8]. Recent works have focused on the necessary interpretation, for instance in Argumentation Frameworks with Necessities (AFN) [13], and in [9, 10, 4]. In [16], correspondences are provided between a framework with evidential support and an AFN. In evidential argumentation standard arguments need to be supported by special (called prima-facie) arguments in order to be considered as acceptable. So arguments need to be able to trace back to prima-facie arguments. With the necessary interpretation of support as in AFN, arguments need to be able to trace back to arguments that require no support in order to be considered as acceptable.

It is worth to note that [7, 16, 13] do not allow the representation of higher-order interactions. In contrast, higher-order interactions (attacks as well as supports) have been considered in [9, 10, 4], with different ways for defining acceptability semantics: a translation into a standard Dung’s AF [9], meta-argumentation techniques [4], a direct characterization of extension-based acceptability semantics [10].

Very recently, a new framework has been proposed that allows representing higher-order attacks and higher-order evidential supports [6]. In this framework, called Recursive Evidence-Based Argumentation Framework (REBAF), the semantics handle both acceptability of arguments and validity of interactions (attacks or supports), and account for the fact that acceptability of arguments may depend on the validity of interactions and vice-versa. As a consequence, the standard notion of extension is replaced by a triple of a set of arguments, a set of attacks and a set of supports, called “structure”.

In this paper, our purpose is to propose a Recursive Argumentation Framework with Necessities (RAFN) with semantics accounting for acceptability of arguments and validity of interactions, in the case of higher-order attacks and higher-order necessary supports. Moreover, we are interested in a conservative generalisation of AFN. Taking advantage of the correspondences that have been established between evidential and necessary support in [16], our methodology and definitions draw on the REBAF of [6].

The paper is organized as follows: Section 2 gives some background about necessary

support and about the REBAF; the definition and semantics for the RAFN are proposed in Section 3; in Section 4 we prove a one-to-one correspondence with AFN in the case of first-order interactions, and we give a comparison with recent work about recursive attacks and supports [10]; and we conclude in Section 5. Proofs are given in Appendix B.

2 Background

We next review some basic background about the works the paper is based on: an abstract argumentation framework handling first-order necessary supports (AFN), and a recent approach dealing with higher-order attacks and evidential supports (REBAF).

First-order necessary support (AFN). Binary necessary support was initially introduced in [14], then discussed in [9, 10, 4] in a more general context (particularly with higher-order interactions). Let a and b be two arguments, “ a necessarily supports b ” means that the acceptance of a is necessary to get the acceptance of b , or equivalently that the acceptance of b implies the acceptance of a . Necessary support has been extended to express the fact that a given argument requires at least one element among a set of arguments. In [13], an Argumentation Framework with Necessities (AFN) is defined as follows:

Def. 1 (AFN [13]) *An Argumentation Framework with Necessities (AFN) is a tuple $\langle \mathbf{A}, \mathbf{R}, \mathbf{N} \rangle$, where \mathbf{A} is a finite and non-empty set of arguments, $\mathbf{R} \subseteq \mathbf{A} \times \mathbf{A}$ represents the attack relation and $\mathbf{N} \subseteq (2^{\mathbf{A}} \setminus \emptyset) \times \mathbf{A}$ represents the necessity relation.*

For $E \subseteq \mathbf{A}$, ENb reads “ E is a necessary support for b ”, which means that if no argument of E is accepted then b cannot be accepted, or equivalently that the acceptance of b requires the acceptance of *at least one element* of E . Moreover, in AFN semantics, acyclicity of the support relation is required among accepted arguments. Intuitively, in a given extension, support for each argument is provided by at least one of its necessary arguments and there is no risk of a deadlock due to necessity cycles. These requirements have been formalized in [13] and can be reformulated as follows:

Def. 2 (Semantics in AFN) *Given AFN = $\langle \mathbf{A}, \mathbf{R}, \mathbf{N} \rangle$ and $T \subseteq \mathbf{A}$.*

- T is support-closed iff for each $a \in T$, if ENa , then $E \cap T \neq \emptyset$.
- Assume that T is support-closed. $a \in T$ is support-cycle-free in T iff $\forall E \subseteq \mathbf{A}$ such that ENa , there is $b \in E \cap T$ such that b is support-cycle-free in $T \setminus \{a\}$.
- T is coherent iff T is support-closed and every $a \in T$ is support-cycle-free in T .
- $a \in \mathbf{A}$ is deactivated by T iff $\forall C \subseteq \mathbf{A}$ coherent subset containing a , TRC (i.e. there is $x \in T$ and $c \in C$ such that $x\mathbf{R}c$).
- $a \in \mathbf{A}$ is acceptable w.r.t. T iff (i) $T \cup \{a\}$ is coherent and (ii) $\forall b \in \mathbf{A}$ such that $b\mathbf{R}a$, b is deactivated by T .
- T is admissible iff T is conflict-free, coherent, and every a in T is acceptable w.r.t. T .

- T is a complete extension iff T is admissible and $\forall a \in \mathbf{A}$, if a is acceptable w.r.t. T , then $a \in T$.
- T is a preferred extension iff T is a \subseteq -maximal complete extension.
- T is a stable extension iff T is complete and $\forall a \in \mathbf{A}$, $a \in \mathbf{A} \setminus T$ iff a is deactivated by T .
- T is a grounded extension iff T is a \subseteq -minimal complete extension.

Ex. 2 Consider the framework representing an attack from a to b and no necessary support. The unique extension under complete, preferred, stable and grounded semantics is $\{a\}$. Indeed, the AFN framework is a conservative generalisation of Dung's framework.

Ex. 3 Consider the framework representing a necessary support from $\{a\}$ to b and no attack. $\{a\}$ and $\{a\}$ are admissible sets. However, due to the necessary support, an admissible set containing b must also contain a . So, $\{b\}$ is not admissible, and the unique complete extension is $\{a, b\}$.

Ex. 4 Consider the framework representing a cycle of necessary supports between a and b , and no attack. This cycle is represented by $\{a\}\mathbf{N}b$ and $\{b\}\mathbf{N}a$. There is no non-empty admissible set. Indeed, there is no way to trace back with a chain of supports from a (resp. b) to arguments that require no support.

Ex. 5 Consider the framework representing k necessary supports to a : $a \in \mathbf{A}$, X_1, \dots, X_k are non-empty subsets of \mathbf{A} such that $X_i\mathbf{N}a$, $i = 1 \dots k$. Let E be an admissible set containing a . Then $\forall i = 1 \dots k$, at least one argument of X_i must belong to E .

Recursive Evidence-Based Argumentation Frameworks (REBAF). Recently introduced in [6], the REBAF allows representing higher-order attacks and higher-order supports. It is a generalisation of the Evidence-Based Argumentation Framework (EBAF) [16]. In these frameworks, the “evidential” understanding of the support relation allows to distinguish between two different kinds of arguments: *prima-facie* and *standard arguments*. *Prima-facie* arguments are justified whenever they are not defeated. On the other hand, *standard arguments* are not assumed to be justified and must inherit support from *prima-facie* arguments through a chain of supports. In the REBAF, the semantics handle both acceptability of arguments and validity of interactions (attacks or supports), and account for the fact that acceptability of arguments may depend on the validity of interactions and vice-versa. As a consequence, the standard notion of extension is replaced by a triple of a set of arguments, a set of attacks and a set of supports, called “structure”. We briefly recall the main definitions.

Def. 3 (Recursive EBAF and structure) A Recursive Evidence-Based Argumentation Framework (REBAF) is a sextuple $\langle \mathbf{A}, \mathbf{R}, \mathbf{S}, s, t, \mathbf{P} \rangle$, where \mathbf{A} , \mathbf{R} and \mathbf{S} are three pairwise disjoint sets respectively representing arguments, attacks and supports names, and where $\mathbf{P} \subseteq \mathbf{A} \cup \mathbf{R} \cup \mathbf{S}$ is a set representing the *prima-facie* elements that do not need to be supported.¹ Functions $s : (\mathbf{R} \cup \mathbf{S}) \rightarrow 2^{\mathbf{A}}$ and $t : (\mathbf{R} \cup \mathbf{S}) \rightarrow (\mathbf{A} \cup \mathbf{R} \cup \mathbf{S})$ respectively map

¹Note that the set \mathbf{P} may contain several *prima-facie* elements (arguments, attacks and supports) without any constraint (they can be attacked or supported).

each attack and support to its source and its target.

A structure of $\langle \mathbf{A}, \mathbf{R}, \mathbf{S}, s, t, \mathbf{P} \rangle$ is a triple $U = (T, \Gamma, \Delta)$ with $T \subseteq \mathbf{A}$, $\Gamma \subseteq \mathbf{R}$ and $\Delta \subseteq \mathbf{S}$.

A REBAF can be graphically represented: a support named α (with $s(\alpha) = \{a\}$ and $t(\alpha) = c$) being the target of an attack β with $s(\beta) = \{b\}$ is represented by:

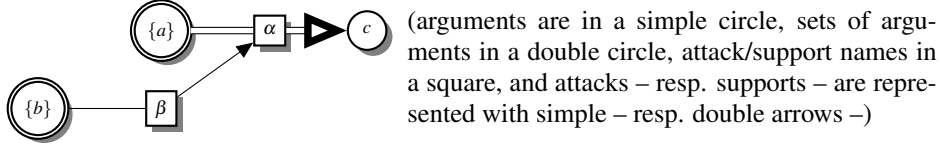

The notion of structure allows characterizing which arguments are regarded as “acceptable” and which attacks and supports are regarded as “valid” with respect to a given framework. It is the basis of defining the semantics for recursive frameworks. Intuitively, the set T represents the set of “acceptable” arguments w.r.t. the structure U , while Γ and Δ respectively represent the set of “valid attacks” and “valid supports” w.r.t. U . For the rest of this section, we consider a REBAF $\langle \mathbf{A}, \mathbf{R}, \mathbf{S}, s, t, \mathbf{P} \rangle$ and a structure U of this REBAF. An element x (argument, attack or support) is defeated w.r.t. U iff there is a “valid attack” w.r.t. U that targets x and whose source is “acceptable” w.r.t. U . As for the notion of *supported elements* w.r.t. a structure, the *prima-facie* elements of a REBAF are supported w.r.t. any structure. Then, a standard element is supported if there exists a chain of supported supports, leading to it, which is rooted in *prima-facie* arguments. Formally, the set of defeated (resp. supported) elements is defined as follows:

Def. 4 ([6]) $Def_X(U) = \{x \in X / \exists \alpha \in \Gamma, s(\alpha) \subseteq T \text{ and } t(\alpha) = x\}$ with $X \in \{\mathbf{A}, \mathbf{R}, \mathbf{S}\}$. Let U_{-x} denote $(T \setminus \{x\}, \Gamma \setminus \{x\}, \Delta \setminus \{x\})$. $Supp(U) = \mathbf{P} \cup \{t(\alpha) / \exists \alpha \in (\Delta \cap Supp(U_{-t(\alpha)})) \text{ with } s(\alpha) \subseteq (T \cap Supp(U_{-t(\alpha)}))\}$.

Drawing on the notions of defeated elements and supported elements, the *supportable* elements can be defined. An element is supportable if there exists some non-defeated support with all its source elements non-defeated and regarded as supportable. Formally, an element x is supportable w.r.t. U iff x is supported w.r.t. $U' = (Def_{\mathbf{A}}(U), \mathbf{R}, Def_{\mathbf{S}}(U))$.² Elements that are defeated or unsupported cannot be accepted. $UnAcc(U) = Def(U) \cup \overline{Supp(U')}$ denotes the set of *unacceptable* elements w.r.t. U . Moreover, an attack $\alpha \in \mathbf{R}$ is *unactivable*³ iff either it is unacceptable or some element in its source is unacceptable. $UnAct(U) = \{\alpha \in \mathbf{R} / \alpha \in UnAcc(U) \text{ or } s(\alpha) \cap UnAcc(U) \neq \emptyset\}$.

Ex. 6 Consider the framework $\langle \mathbf{A}, \mathbf{R}, \mathbf{S}, s, t, \mathbf{P} \rangle$ where $\mathbf{A} = \{a, b, c, d\}$, $\mathbf{R} = \{\beta, \delta\}$, $\mathbf{S} = \{\alpha\}$ and $\mathbf{P} = \{a, c, \alpha, \beta\}$ corresponding to the graph depicted in the following figure (*prima-facie* elements are represented with dashed lines; as the source of each interaction is a singleton, it can be represented by an argument):

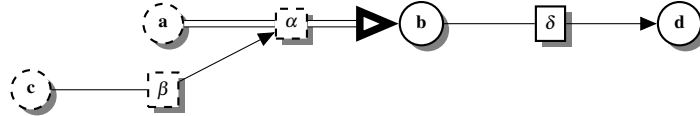

²Let U be a structure, $X \in \{\mathbf{A}, \mathbf{R}, \mathbf{S}\}$ and $f_X(U)$ a subset of X . $\overline{f_X(U)}$ denotes the set $X \setminus f_X(U)$. Moreover, $f(U)$ is short for $f_{\mathbf{A}}(U) \cup f_{\mathbf{R}}(U) \cup f_{\mathbf{S}}(U)$. And as usual, $\overline{f(U)}$ denotes $\mathbf{A} \cup \mathbf{R} \cup \mathbf{S} \setminus f(U)$.

³ Intuitively, such an attack cannot be “activated” in order to defeat the element that it is targeting.

Let U be the structure $(T = \{a, c\}, \Gamma = \{\beta\}, \Delta = \{\alpha\})$. $Supp(U) = \{a, b, c, \beta\}$. Note that a , c and β are supported because they are prima-facie elements. Let us prove that $b \in Supp(U)$: $b = t(\alpha)$ with $\alpha \in \Delta$ and $s(\alpha) = \{a\} \subseteq T$. As α and a both belong to \mathbf{P} , $s(\alpha)$ and α both belong to $Supp(U \setminus \{b\})$. However, b is unsupportable w.r.t. U since α is defeated by β . As a consequence, the attack δ is unactivable w.r.t. U .

Finally, an element is acceptable w.r.t. U iff it is supported w.r.t. U and, in addition, every attack against it is unactivable w.r.t. U , because either some argument in its source or itself has been regarded as unacceptable w.r.t. U .

Def. 5 (Acceptability [6]) Let $x \in \mathbf{A} \cup \mathbf{R} \cup \mathbf{S}$. x is acceptable w.r.t. U iff (i) $x \in Supp(U)$ and (ii) for each attack $\alpha \in \mathbf{R}$ with $t(\alpha) = x$, $\alpha \in UnAct(U)$. $Acc(U)$ denotes the set of all elements that are acceptable w.r.t. U .

Semantics are defined as follows:

Def. 6 (Semantics in REBAF [6]) A structure $U = (T, \Gamma, \Delta)$ is said:

1. self-supporting iff $(T \cup \Gamma \cup \Delta) \subseteq Supp(U)$,
2. conflict-free iff $T \cap Def_{\mathbf{A}}(U) = \emptyset$, $\Gamma \cap Def_{\mathbf{R}}(U) = \emptyset$ and $\Delta \cap Def_{\mathbf{S}}(U) = \emptyset$,
3. admissible iff it is conflict-free and $(T \cup \Gamma \cup \Delta) \subseteq Acc(U)$,
4. complete iff it is conflict-free and $(T \cup \Gamma \cup \Delta) = Acc(U)$,
5. preferred iff it is a \subseteq -maximal⁴ admissible structure,
6. stable iff $(T \cup \Gamma \cup \Delta) = \overline{UnAcc(U)}$.

3 Handling higher-order necessary supports

Our purpose is to propose a framework that allows representing higher-order attacks and higher-order necessary supports, using similar definitions as those at work in the REBAF. First, we provide a definition of a “recursive AFN”. Then we show that, in presence of higher-order interactions, the translation from an AFN to an EBAF proposed in [16] cannot be extended. That leads us to provide direct definitions for the semantics of recursive AFNs.

Def. 7 (Recursive AFN) A Recursive Argumentation Framework with Necessities (RAFN) is a tuple $\langle \mathbf{A}, \mathbf{R}, \mathbf{N}, s, t \rangle$, where \mathbf{A} , \mathbf{R} and \mathbf{N} are three pairwise disjoint sets respectively representing arguments, attacks and supports names, s is a function from $\mathbf{R} \cup \mathbf{N}$ to $(2^{\mathbf{A}} \setminus \emptyset)$ mapping each interaction to its source,⁵ and t is a function from $\mathbf{R} \cup \mathbf{N}$ to $(\mathbf{A} \cup \mathbf{R} \cup \mathbf{N})$ mapping each interaction to its target. It is assumed that $\forall \alpha \in \mathbf{R}, s(\alpha)$ is a singleton.

A structure of $\langle \mathbf{A}, \mathbf{R}, \mathbf{N}, s, t \rangle$ is a triple $U = (T, \Gamma, \Delta)$ with $T \subseteq \mathbf{A}$, $\Gamma \subseteq \mathbf{R}$ and $\Delta \subseteq \mathbf{N}$.

⁴For any pair of structures $U = (T, \Gamma, \Delta)$ and $U' = (T', \Gamma', \Delta')$, $U \subseteq U'$ means that $(T \cup \Gamma \cup \Delta) \subseteq (T' \cup \Gamma' \cup \Delta')$.

⁵In contrast with ASAF (see [10]), the source of a support in a RAFN is a set of arguments.

Turning a recursive AFN into a recursive EBAF? In the particular case of first-order interactions, a one-to-one correspondence between a REBAF and a finite EBAF has been proved, by considering only one prima-facie argument denoted by η [6]. Besides, correspondences have been provided between an AFN and an EBAF, that preserve the semantics [16] using the following definition (the basic idea is that unsupported arguments in an AFN correspond to arguments supported by the special argument η in an EBAF, or equivalently to prima-facie arguments in a REBAF):

Def. 8 (From AFN to EBAF [16]) Let $\langle \mathbf{A}, \mathbf{R}, \mathbf{N} \rangle$ be an AFN. The corresponding EBAF $\langle \mathbf{A}', \mathbf{R}', \mathbf{S} \rangle$ is defined by (η serves as a representation of the prima-facie elements):

- $\mathbf{A}' = \mathbf{A} \cup \{\eta\}$ and for $(a, b) \in \mathbf{R}$, put $(\{a\}, b)$ in \mathbf{R}' .
- Let $a \in \mathbf{A}$ and $X = \{X_1, \dots, X_k\}$ be the collection of all sets X_i such that $X_i \mathbf{N} a$. If X is empty, add $(\{\eta\}, a)$ to \mathbf{S} . Otherwise, for all $X' \in (X_1 \times \dots \times X_k)$ add (X'_i, a) to \mathbf{S} , where X'_i denotes the set of all elements in X' .

This construction can be illustrated by the following example:

Ex. 7

Let $AFN = \langle \{a, b, c\}, \emptyset, \{(\{b\}, a), (\{c\}, a)\} \rangle$. Following Def. 8, we obtain an EBAF with a support β from the set $\{b, c\}$ to a :

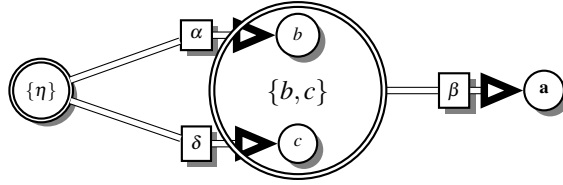

It has been proved in [16] that $T \subseteq \mathbf{A}$ is a σ -extension of an AFN iff $T \cup \{\eta\}$ is a σ -extension of the associated EBAF, for $\sigma \in \{admissible, preferred, complete, stable\}$.

A natural idea would be to generalize the construction proposed in Def. 8. However, in that construction, it is worth to notice that if an argument a receives several supports in an AFN (let α_i denote the support $X_i \mathbf{N} a$), new supports β_j to a are created in the corresponding EBAF (see Ex. 7). Assume now that one of the supports α_i is attacked, it is impossible to know which one of the new supports should be attacked. This point is illustrated on Ex. 8.

Ex. 8 Let $RAFN = \langle \{a, b, c, d\}, \{\alpha_3\}, \{\alpha_1, \alpha_2\}, s, t \rangle$ with $s(\alpha_1) = \{b\}, s(\alpha_2) = \{c\}, s(\alpha_3) = \{d\}, t(\alpha_1) = t(\alpha_2) = a, t(\alpha_3) = \alpha_1$ (it is obtained from the AFN given in Ex. 7 by naming the supports and adding an attack to one of the supports).

Creating a support β from the set $\{b, c\}$ to a would not enable to take into account the fact that α_1 is attacked. In particular it would not be sound to create an attack from d to β .

Moreover, in the higher-order framework and even in the particular case when each element (argument, attack or support) receives at most one support, whose source is reduced to one argument (case of binary supports), the different understanding of evidential and necessary supports implies that the construction proposed in Def. 8 cannot be extended. This point is illustrated on the two following examples.

Ex. 9 Consider the RAFN framework $\langle \mathbf{A}, \mathbf{R}, \mathbf{N}, s, t, \rangle$ where $\mathbf{A} = \{a, b, c\}$, $\mathbf{R} = \{\beta\}$ and $\mathbf{N} = \{\alpha\}$, with $s(\alpha) = \{a\}$, $s(\beta) = \{c\}$, $t(\alpha) = b$ and $t(\beta) = \alpha$. Generalizing Def. 8 would produce the corresponding REBAF $\langle \mathbf{A}, \mathbf{R}, \mathbf{N}, s, t, \mathbf{P} \rangle$ with $\mathbf{P} = \{a, c, \alpha, \beta\}$ (indeed, following the understanding of necessary support, each element that is not supported can be considered as *prima-facie*). Let $U = (\{a, c\}, \{\beta\}, \emptyset)$. As shown in [6], with the REBAF semantics, b has no support w.r.t. U as $\alpha \notin U$, so b cannot be accepted. In contrast, considering necessary supports, we should be able to say that b is supported w.r.t. U : As $\alpha \notin U$, there is no necessary support to be considered for ensuring the acceptance of b .

Ex. 10 Consider now RAFN' obtained from RAFN given in Ex. 9 by replacing the attack β from c to α with a support δ from c to α . Let $U = (\{a\}, \emptyset, \{\alpha, \delta\})$. With the REBAF semantics, b has no support w.r.t. U , since α has no support from U (as $c \notin U$). In contrast, considering necessary supports, as $c \notin U$, α cannot be valid, so there is no necessary support to be considered for ensuring the acceptance of b , so we should be able to say that b is supported w.r.t. U .

Semantics of a recursive AFN. Even if a direct translation from RAFN to a REBAF is not possible, the analogy between *prima-facie* arguments in REBAF and non-supported arguments in RAFN suggests to draw on the REBAF approach. So we next provide direct definitions for the semantics of recursive AFNs, based on the notion of structure, in a similar way as for a REBAF.

Let us consider a RAFN $\langle \mathbf{A}, \mathbf{R}, \mathbf{N}, s, t \rangle$ and a structure U of this RAFN. We keep the definition for an element being defeated recalled in Section 2 (which can be simplified as $\forall \alpha \in \mathbf{R}, s(\alpha)$ is a singleton). In contrast, a difference appears with the notion of *supported elements*: elements (arguments, attacks, supports) which receive no necessary support do not require any support, so they are supported w.r.t. any structure. That corresponds to the set \mathbf{P} in Def. 9 below. Moreover, in an AFN, for $E \subseteq \mathbf{A}$, ENx means that the acceptance of x requires the acceptance of *at least one* element of E . Then, an element x is supported w.r.t. U if for *each* support α (which can be regarded as supported), the source of α contains *at least one* argument of U that can be regarded as supported. Formally, we have:

Def. 9 Given a structure $U = (T, \Gamma, \Delta)$

- $Def_X(U) = \{x \in X / \exists \alpha \in \Gamma, s(\alpha) \in T \text{ and } t(\alpha) = x\}$ with $X \in \{\mathbf{A}, \mathbf{R}, \mathbf{N}\}$.
- Let $\mathbf{P} = \{x \in \mathbf{A} \cup \mathbf{R} \cup \mathbf{N} / \text{there is no } \alpha \in \mathbf{N} \text{ with } t(\alpha) = x\}$. $Supp(U) = \mathbf{P} \cup \{x / \forall \alpha \in \Delta \text{ such that } t(\alpha) = x, \text{ if } \alpha \in Supp(U_{-x}) \text{ then } s(\alpha) \cap (T \cap Supp(U_{-x})) \neq \emptyset\}$.
- U is self-supporting iff $(T \cup \Gamma \cup \Delta) \subseteq Supp(U)$.

Pursuing the analogy with REBAF, an element of a RAFN is considered as being still supportable as long as for *each* non-defeated support, *there exists at least one* argument in its source, which is non-defeated and regarded as supportable. Formally, an element x is supportable w.r.t. U iff x is supported w.r.t. $U' = (Def_{\mathbf{A}}(U), \mathbf{R}, Def_{\mathbf{N}}(U))$. Drawing on these new notions of supported (resp. unsupported) element, we keep the definitions used in a REBAF for unacceptable elements and unactivable attacks. Namely, elements that are defeated or that are unsupported are said to be *unacceptable* (they cannot be

accepted). Then an attack $\alpha \in \mathbf{R}$ is *unactivable* (such an attack cannot be “activated” in order to defeat the element that it is targeting) iff either it is unacceptable or its source is unacceptable. Finally we keep the definition for acceptability used in a REBAF.

Def. 10 Given a structure $U = (T, \Gamma, \Delta)$, let $U' = (\overline{Def_{\mathbf{A}}(U)}, \mathbf{R}, \overline{Def_{\mathbf{N}}(U)})$.

- $UnSupp(U) = \overline{Supp(U')}$.
- $UnAcc(U) = Def(U) \cup UnSupp(U)$ denotes the set of unacceptable elements w.r.t. U .
- $UnAct(U) = \{\alpha \in \mathbf{R} / \alpha \in UnAcc(U) \text{ or } s(\alpha) \subseteq UnAcc(U)\}$ denotes the set of unactivable attacks w.r.t. U .
- $x \in \mathbf{A} \cup \mathbf{R} \cup \mathbf{N}$ is acceptable w.r.t. U iff $x \in Supp(U)$ and for each $\alpha \in \mathbf{R}$ with $t(\alpha) = x$, $\alpha \in UnAct(U)$. $Acc(U)$ denotes the set of all elements that are acceptable w.r.t. U .

The two following examples illustrate the previous definitions.

Ex. 11 Consider the framework $RAF_N = \langle \{a, x, y, z, t\}, \{\beta\}, \{\alpha_1, \alpha_2, \alpha_3\}, s, t \rangle$ with $s(\alpha_1) = \{a\}$, $s(\alpha_2) = \{z\}$, $s(\alpha_3) = \{t\}$, $s(\beta) = \{y\}$, $t(\alpha_1) = x$, $t(\alpha_2) = y$, $t(\alpha_3) = y$, $t(\beta) = x$. Let $U = (\{a\}, \{\beta\}, \{\alpha_1, \alpha_2, \alpha_3\})$. $U' = (\mathbf{A}, \mathbf{R}, \mathbf{N})$. $x \in Supp(U)$. However, $x \notin Acc(U)$ as it is the target of the attack β , $s(\beta) = \{y\}$ and $y \notin UnAcc(U)$. Indeed y is not attacked and $y \in Supp(U')$ since α_2 and α_3 belong to \mathbf{P} and z and t do not belong to $Def_{\mathbf{A}}(U)$.

Ex. 12 Consider the RAFN obtained by adding an attack γ from a to z in the RAFN of Ex. 11 and the new structure $U = (\{a\}, \{\beta, \gamma\}, \{\alpha_1, \alpha_2, \alpha_3\})$. With this new structure, we have $z \in Def_{\mathbf{A}}(U)$. So $y \notin Supp(U')$ and therefore x becomes acceptable w.r.t. U .

Note that the Fundamental Lemma cannot be generalized. Indeed, the function $Supp$ is not monotonic as shown by the following examples.

- Let us consider Ex. 3 modified as follows: $RAF_N = \langle \{a, b, c\}, \emptyset, \{\alpha, \delta\}, s, t \rangle$ with $s(\alpha) = \{a\}$, $s(\delta) = \{c\}$, $t(\alpha) = b$, $t(\delta) = \alpha$. Let $U = (\{b\}, \emptyset, \{\alpha, \delta\})$. $b \in Supp(U)$ since $c \notin T$ and so α is not supported. However, $b \notin Supp(U \cup \{c\})$ since $a \notin T$.
- As a second example consider RAFN obtained from AFN of Ex. 7 just by naming supports: $s(\alpha_1) = \{b\}$, $s(\alpha_2) = \{c\}$, $t(\alpha_1) = t(\alpha_2) = a$. Let $U = (\{b\}, \emptyset, \{\alpha_1\})$. $a \in Supp(U)$ and $U \cup \{a\}$ is self-supporting. Moreover U is admissible and a and α_2 both belong to $Acc(U)$. However, $a \notin Supp(U \cup \{\alpha_2\})$. So $a \notin Acc(U \cup \{\alpha_2\})$.

As a consequence, semantics are defined as follows:⁶

Def. 11 (Semantics in RAFN) A structure $U = (T, \Gamma, \Delta)$ is said:

1. conflict-free iff $T \cap Def_{\mathbf{A}}(U) = \emptyset$, $\Gamma \cap Def_{\mathbf{R}}(U) = \emptyset$ and $\Delta \cap Def_{\mathbf{N}}(U) = \emptyset$,

⁶As there is no Fundamental Lemma, preferred and stable extensions are assumed to be complete sets.

2. admissible iff it is conflict-free and $(T \cup \Gamma \cup \Delta) \subseteq \text{Acc}(U)$,
3. complete iff it is conflict-free and $(T \cup \Gamma \cup \Delta) = \text{Acc}(U)$,
4. preferred iff it is a \subseteq -maximal complete structure,
5. stable iff it is complete and $\overline{(T \cup \Gamma \cup \Delta)} = \text{UnAcc}(U)$,
6. grounded iff it is a \subseteq -minimal complete structure.

Note that an admissible structure is also self-supporting.

Ex. 8 (cont'd) Consider the case of two supports α_1 (from b to a) and α_2 (from c to a), α_1 being the target of the attack α_3 from d . We have $\mathbf{P} = \{b, c, d, \alpha_1, \alpha_2, \alpha_3\}$. Let us study different structures:

- Let $U_1 = (T_1, \Gamma_1, \Delta_1)$ with $T_1 = \{a, b, c, d\}$, $\Gamma_1 = \emptyset$, $\Delta_1 = \{\alpha_1, \alpha_2\}$. U_1 is conflict-free (as $\alpha_3 \notin \Gamma_1$) and self-supporting. $b, c, d, \alpha_1, \alpha_2$ belong to $\text{Supp}(U_1)$ (as $\mathbf{P} \subseteq \text{Supp}(U_1)$). And $a \in \text{Supp}(U_1)$ since $\alpha_1, \alpha_2, s(\alpha_1), s(\alpha_2)$ belong to \mathbf{P} hence to $\text{Supp}(U_{1-a})$. However, $\alpha_1 \notin \text{Acc}(U_1)$. Indeed $\alpha_3 \notin \text{Unact}(U_1)$ as α_3 and $s(\alpha_3)$ both belong to \mathbf{P} and to $\text{Def}(U_1)$. So U_1 is not admissible.
- Let $U_2 = (T_2, \Gamma_2, \Delta_2)$ with $T_2 = \{a, c, d\}$, $\Gamma_2 = \{\alpha_3\}$, $\Delta_2 = \{\alpha_2\}$. U_2 is conflict-free (as $\alpha_1 \notin \Gamma_2$) and self-supporting. As c, d, α_2, α_3 belong to \mathbf{P} , we just have to prove that $a \in \text{Supp}(U_2)$. As α_2 is the unique support in Δ_2 targeting a , due to Def. 9, we just have to prove that if $\alpha_2 \in \text{Supp}(U_{2-a})$, then $c \in T_2 \cap \text{Supp}(U_{2-a})$. That is true since $c \in (T_2 \cap \mathbf{P})$. U_2 is admissible since U_2 is self-supporting and no element of U_2 is attacked. It is worth to note that in the structure U_2 , a is accepted without b being accepted. This is due to the fact that the necessary support α_1 is defeated by U_2 hence unacceptable w.r.t. U_2 . So, α_1 does not have to be considered as a necessary support for a .
- $U_3 = (\{a, b, c, d\}, \{\alpha_3\}, \{\alpha_2\})$ is the unique preferred structure.

Ex. 13 Consider the framework $\text{RAF}N = (\{a, b, c, d, e\}, \{\alpha_3\}, \{\alpha_1, \alpha_2\}, s, t)$ with $s(\alpha_1) = \{b, c\}$, $s(\alpha_2) = \{d\}$, $s(\alpha_3) = \{e\}$, $t(\alpha_1) = t(\alpha_2) = a$, $t(\alpha_3) = b$. We have $\mathbf{P} = \{b, c, d, e, \alpha_1, \alpha_2, \alpha_3\}$. Let us study different structures:

- $U_1 = (\{a, b, d, e\}, \emptyset, \{\alpha_1, \alpha_2\})$. U_1 is conflict-free (as $\alpha_3 \notin \Gamma_1$) and self-supporting. As $b, d, e, \alpha_1, \alpha_2$ belong to \mathbf{P} , we just have to prove that $a \in \text{Supp}(U_1)$. Due to Def. 9, we have to consider α_1 and α_2 , the supports in Δ_1 that target a . As both of them belong to \mathbf{P} , we have to consider their source. $s(\alpha_2) = \{d\} \subseteq \mathbf{P} \cap T_1$, and $s(\alpha_1)$ contains b that is an element of $T_1 \cap \mathbf{P}$. So $a \in \text{Supp}(U_1)$. However, $b \notin \text{Acc}(U_1)$. Indeed $\alpha_3 \notin \text{Unact}(U_1)$ as α_3 and $s(\alpha_3)$ both belong to \mathbf{P} and to $\text{Def}(U_1)$. So U_1 is not admissible.
- $U_2 = (\{a, c, d, e\}, \emptyset, \{\alpha_1, \alpha_2\})$. U_2 is conflict-free. It is also self-supporting (it can be proved as for U_1 replacing b by c) and no element of U_2 is attacked. So U_2 is admissible.

- $U_3 = (\{a, c, d, e\}, \{\alpha_3\}, \{\alpha_1, \alpha_2\})$ is the unique preferred structure. Note that U_3 follows the intuition behind Def. 9, that at least one element in the source of the support α_1 has to be accepted (here c) in order to accept the target (here a).

Ex. 4 (cont'd) Consider the RAFN corresponding to the AFN (α_1 and α_2 being the names of the supports). $U = (\emptyset, \emptyset, \{\alpha_1, \alpha_2\})$ is the unique stable structure. So differently from Dung's approach, it can be the case that an element is not in the stable structure even if it is not defeated by it (it is left out because it is unsupported by the structure).

4 Related works

First, we consider the particular case of RAFN without support, then we compare our framework with AFN and ASAF.

RAFN without support. In that case we get exactly the definitions of the Recursive Argumentation Framework (RAF) of [5]. Besides, [5] provided correspondences between RAF-structures and AFRA-extensions of [2]. The RAFN without support also corresponds to the REBAF without support (in the particular case of binary attacks). Moreover, a RAFN with only first-order attacks and without support is a RAF with only first-order attacks. That case has been proved to be a conservative generalisation of Dung's framework in [5].

Relation with AFN. We show that the RAFN is a conservative generalisation of the AFN. Given an AFN, we give a translation into a RAFN, and prove a one-to-one correspondence between complete (resp. preferred, stable, grounded) extensions of the AFN and complete (resp. preferred, stable, grounded) structures of the corresponding RAFN. Let us start by giving the RAFN corresponding to a given AFN. We just have to name the interactions.

Def. 12 Given $AFN = \langle \mathbf{A}, \mathbf{R}, \mathbf{N} \rangle$, the corresponding RAFN is $\langle \mathbf{A}, \mathbf{R}', \mathbf{N}', s', t' \rangle$, where \mathbf{R}' and \mathbf{N}' are two disjoint sets with the same cardinality as \mathbf{R} and \mathbf{N} respectively, and s' and t' map each interaction to their corresponding source and target, that is:

- for $(a, b) \in \mathbf{R}$, and α the associated name in \mathbf{R}' , we have $s'(\alpha) = \{a\}$ and $t'(\alpha) = b$.
- for $(X, b) \in \mathbf{N}$, and β the associated name in \mathbf{N}' , we have $s'(\beta) = X$ and $t'(\beta) = b$.

Following Def. 9, $\mathbf{P}' = \{x \in \mathbf{A} / \text{there is no } \alpha \in \mathbf{N}' \text{ with } t'(\alpha) = x\} \cup \mathbf{R}' \cup \mathbf{N}'$. Note that in an AFN, each attack (resp. support) can be considered as “valid”, as it is neither attacked nor supported. Hence, in the corresponding RAFN, such an interaction must be acceptable w.r.t. any structure. Accordingly, given a set $T \subseteq \mathbf{A}$, by $U_T = (T, \mathbf{R}', \mathbf{N}')$ we denote its corresponding structure. Given $AFN = \langle \mathbf{A}, \mathbf{R}, \mathbf{N} \rangle$, and its corresponding $RAFN = \langle \mathbf{A}, \mathbf{R}', \mathbf{N}', s', t' \rangle$, the semantics of $RAFN$ are given by Def. 11 and rely upon Def. 9. Given $T \subseteq \mathbf{A}$, $U = (T, \mathbf{R}', \mathbf{N}')$, and $x \in \mathbf{A}$, the structure U_{-x} is equal to $(T \setminus \{x\}, \mathbf{R}', \mathbf{N}')$ and exactly corresponds to the structure $U_{T \setminus \{x\}}$. Then $Supp(U_T) = \mathbf{P}' \cup \{x \in \mathbf{A} / \forall \alpha \in \mathbf{N}' \text{ such that } t'(\alpha) = x, s'(\alpha) \cap (T \cap Supp(U_{T \setminus \{x\}})) \neq \emptyset\}$ (as each support belongs to \mathbf{P}'). Then the following propositions hold.

Prop. 1 Let $T \subseteq \mathbf{A}$.

1. Let $a \in T$. If T is support-closed in AFN, then $a \in \text{Supp}(U_T)$ iff a is support-cycle-free in T . Moreover U_T is self-supporting in RAFN iff T is coherent in AFN.
2. Let $a \in \mathbf{A}$. If a is acceptable w.r.t. T in AFN, then a is acceptable w.r.t. U_T in RAFN. If T is self-supporting and a is acceptable w.r.t. U_T in RAFN, then a is acceptable w.r.t. T in AFN.

Prop. 2 Let $T \subseteq \mathbf{A}$. T is an admissible (resp. complete, preferred, stable, grounded) extension of AFN iff U_T is an admissible (resp. complete, preferred, stable, grounded) structure of the corresponding RAFN.

Relation with ASAF. We next compare the RAFN semantics with ASAF semantics [10]. We consider particular cases of RAFN, as ASAF excludes cycles of necessary supports, and assumes that interactions are binary ones (the source of an attack or a support is a unique argument). The common idea is that the extensions may not only include arguments but also attacks and supports. However, several differences can be outlined. First, in ASAF, attacks and supports are combined to obtain extended (direct or indirect) defeats. Conflict-freeness for a set of elements (arguments, attacks, supports) is defined w.r.t. these extended defeats. So the conflict-freeness requirement takes support into account. In contrast, in RAFN, the notions of support and attack are dealt with separately (see Def. 9). As for acceptability, in ASAF, an element is acceptable w.r.t. a set of elements whenever it can be defended against each defeat. So, in the particular case when there is no attack, each argument would be acceptable w.r.t. any set. In contrast, Def. 10 explicitly requires a support.

Ex. 3 (cont'd) The corresponding RAFN of AFN is $\langle \{a, b\}, \emptyset, \{\alpha\}, s, t \rangle$ with $s(\alpha) = \{a\}$, $t(\alpha) = b$. With ASAF semantics, the set $\{b, \alpha\}$ is admissible, whereas the structure $(\{b\}, \emptyset, \{\alpha\})$ is not admissible in RAFN.

Another difference was already pointed in [5], where correspondences have been provided between a RAF and an ASAF without support. Indeed, in an ASAF, an attack is not acceptable whenever its source is not acceptable (Prop. 2 in [10]).

Ex. 12 (cont'd) With RAFN semantics, β is not attacked and not supported so β must belong to each complete structure. With ASAF semantics, if β is acceptable w.r.t. a set E , then y must be also acceptable w.r.t. E . If E is a complete extension, E contains a , γ and α_2 . As y is defeated by γ given α_2 it cannot be the case that y is acceptable w.r.t. E . So β cannot belong to any complete extension.

So, following the work of [5], we define the following mappings:

- Let $\langle \mathbf{A}, \mathbf{R}, \mathbf{N}, s, t \rangle$ be a RAFN. Given a structure $U = (T, \Gamma, \Delta)$, by $E_U = T \cup \{\alpha \in \Gamma \text{ such that } s(\alpha) \subseteq T\} \cup \Delta$, we denote the corresponding ASAF extension.
- Let $\langle \mathbf{A}, \mathbf{R}, \mathbf{N} \rangle$ be an ASAF. Given $E \subseteq (\mathbf{A} \cup \Gamma \cup \mathbf{N})$ an ASAF extension, by $U_E = (T_E, \Gamma_E, \Delta_E)$, we denote the corresponding RAFN structure, where $T_E = \mathbf{A} \cap E$, $\Gamma_E = (\mathbf{R} \cap E) \cup \{\alpha \in (\mathbf{R} \cap \text{Acc}(U'_E)) \text{ such that } s(\alpha) \not\subseteq E\}$ with U'_E denoting the structure $(T_E, \mathbf{R} \cap E, \mathbf{N} \cap E)$ and $\Delta_E = (\mathbf{N} \cap E) \cup (\mathbf{N} \cap \text{Acc}(U'_E))$.

Our intuition is that, despite the differences between conflict-free and acceptability requirements, the above mappings will enable to achieve correspondences between ASAF and RAFN for the complete (and also grounded and preferred) semantics.

Ex. 12 (cont'd) Consider the unique complete structure $U = (\{a, x, t\}, \{\beta, \gamma\}, \{\alpha_1, \alpha_2, \alpha_3\})$. The corresponding ASAF extension is $E_U = \{a, x, t, \gamma, \alpha_1, \alpha_2, \alpha_3\}$. It can be checked that it is an ASAF complete extension. Conversely, let $E = \{a, x, t, \gamma, \alpha_1, \alpha_2, \alpha_3\}$. We have $U'_E = (\{a, x, t\}, \{\gamma\}, \{\alpha_1, \alpha_2, \alpha_3\})$. Obviously, $\beta \in \text{Acc}(U'_E)$ as β is neither attacked nor supported. So β can be added to Γ_E and $U_E = U$.

5 Conclusion

We have proposed an abstract framework that deals with higher-order interactions, using two types of interaction: attacks and necessary supports. That framework generalises both abstract frameworks with necessities (AFN, see [14, 13]) and recursive abstract frameworks (RAF, see [5]), and so is called RAFN. We have defined semantics accounting for acceptability of arguments and also validity of interactions. As a source of inspiration, we have used the approach presented in [6] that does a similar work for REBAF, another framework dealing with higher-order interactions using evidential supports in place of necessary ones. In the literature, there exist few works handling higher-order attacks and necessary supports, except the ASAF framework [9, 10]. However, ASAF excludes cycles of support and is restricted to binary interactions. Our framework is a conservative generalisation of AFN and RAF, and we are able to outline the differences with ASAF semantics proposed in [10]. In this work, we have defined structure-based semantics in a similar way as done in [6] for evidential support. That paves the way for studying a more general framework capable of taking into account both necessary supports and evidential supports. We aim to address that issue as future work. We also plan to connect RAFN to Logic Programming, following existing works relating Dung's framework to logic programs and ASP (for instance [12]).

References

- [1] R. Arisaka and K. Satoh. Voluntary manslaughter? a case study with meta-argumentation with supports. In *Proc. of JSAI-isAI 2016. LNCS, vol 10247*, pages 241–252, 2017.
- [2] P. Baroni, F. Cerutti, M. Giacomin, and G. Guida. AFRA: Argumentation framework with recursive attacks. *Intl. Journal of Approximate Reasoning*, 52:19–37, 2011.
- [3] G. Boella, D. M. Gabbay, L. van der Torre, and S. Villata. Support in abstract argumentation. In *Proc. of COMMA*, pages 111–122, 2010.
- [4] C. Cayrol, A. Cohen, and M-C. Lagasque-Schiex. Towards a new framework for recursive interactions in abstract bipolar argumentation. In *Proc. of COMMA*, pages 191–198, 2016.

- [5] C. Cayrol, J. Fandinno, L. Fariñas del Cerro, and M.-C. Lagasquie-Schiex. Valid attacks in argumentation frameworks with recursive attacks. In *Proc. of Commonsense Reasoning*, volume 2052. CEUR Workshop Proceedings, 2017.
- [6] C. Cayrol, J. Fandinno, L. Fariñas del Cerro, and M.-C. Lagasquie-Schiex. Argumentation frameworks with recursive attacks and evidence-based support. In *Proc. of FoIKS*, volume LNCS 10833, pages 150–169. Springer-Verlag, 2018.
- [7] C. Cayrol and M.-C. Lagasquie-Schiex. Bipolarity in argumentation graphs: towards a better understanding. *Intl. J. of Approximate Reasoning*, 54(7):876–899, 2013.
- [8] A. Cohen, S. Gottifredi, A. J. García, and G. R. Simari. A survey of different approaches to support in argumentation systems. *The Knowledge Engineering Review*, 29:513–550, 2014.
- [9] A. Cohen, S. Gottifredi, A. J. García, and G. R. Simari. An approach to abstract argumentation with recursive attack and support. *J. Applied Logic*, 13(4):509–533, 2015.
- [10] A. Cohen, S. Gottifredi, A. J. García, and G. R. Simari. On the acceptability semantics of argumentation frameworks with recursive attack and support. In *Proc. of COMMA*, pages 231–242, 2016.
- [11] P. M. Dung. On the acceptability of arguments and its fundamental role in nonmonotonic reasoning, logic programming and n-person games. *Artificial Intelligence*, 77:321–357, 1995.
- [12] U. Egly, S. A. Gaggl, and S. Woltran. Answer-set programming encodings for argumentation frameworks. *Argument & Computation*, 1(2):147–177, 2010.
- [13] F. Nouioua. AFs with necessities: further semantics and labelling characterization. In *Proc. of SUM*, pages 120–133, 2013.
- [14] F. Nouioua and V. Risch. Argumentation frameworks with necessities. In *Proc. of SUM*, pages 163–176, 2011.
- [15] N. Oren and T. J. Norman. Semantics for evidence-based argumentation. In *Proc. of COMMA*, pages 276–284, 2008.
- [16] S. Polberg and N. Oren. Revisiting support in abstract argumentation systems. In *Proc. of COMMA*, pages 369–376, 2014.

A Examples

Note that for each example, we give at least two results:

- one corresponding to our approach using Def. 10,
- the last one corresponding to the approach for the ASAF given in [10].

Then, according to the architecture of the framework, we also give Dung's extensions, RAF extensions and AFN extensions.

The following examples illustrate some differences between our approach and that of [10]:

- either because of cycles in the argumentation framework: Examples 4, 32,
- or because some supports have a set as a source: Examples 13, 31, 33,
- or because of the definition of defeats in the ASAF: Examples 12, 14, from 20 to 25, from 27 to 29.

Note that, following Prop. 2, there is a one to one correspondence between AFN and our approach when the argumentation framework does not contain higher-order interactions.

Similarly, following Sect. 4, there is a one to one correspondence:

- between RAF and our approach when the argumentation framework does not contain supports, and
- between Dung's semantics and our approach when the argumentation framework does not contain supports and contains only first-order attacks.

So our approach is conservative, since the RAFNs are extensions of the AFNs and the RAFs.

Moreover, there are some correspondences between ASAF and our approach.

A.1 Examples used in Comma paper

Ex. 2 (cont'd) Consider the RAFN framework corresponding to the graph depicted in Figure 1.

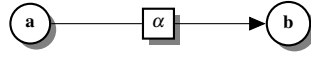

Figure 1

Some interesting structures in our approach corresponding to the notion of acceptability given in Def. 10:

<i>complete</i>	$(\{a\}, \{\alpha\}, \{\})$
<i>preferred</i>	$(\{a\}, \{\alpha\}, \{\})$
<i>stable</i>	$(\{a\}, \{\alpha\}, \{\})$
<i>grounded</i>	$(\{a\}, \{\alpha\}, \{\})$

Some interesting extensions using [10]:

<i>complete</i>	$\{a, \alpha\}$
<i>preferred</i>	$\{a, \alpha\}$
<i>stable</i>	$\{a, \alpha\}$
<i>grounded</i>	$\{a, \alpha\}$

There is a one to one correspondence between our approach and [10].

Moreover, since this example is also a classical AF, if we consider Dung's semantics, the resulting extensions are:

<i>complete</i>	$\{a\}$
<i>preferred</i>	$\{a\}$
<i>stable</i>	$\{a\}$
<i>grounded</i>	$\{a\}$

This example is also an AFN. In this case, the resulting extensions are:

<i>complete</i>	$\{a\}$
<i>preferred</i>	$\{a\}$
<i>stable</i>	$\{a\}$
<i>grounded</i>	$\{a\}$

This example is also a RAF. In this case, the resulting structures are:

<i>complete</i>	$(\{a\}, \{\alpha\})$
<i>preferred</i>	$(\{a\}, \{\alpha\})$
<i>stable</i>	$(\{a\}, \{\alpha\})$
<i>grounded</i>	$(\{a\}, \{\alpha\})$

Ex. 3 (cont'd) Consider the RAFN framework corresponding to the graph depicted in Figure 2.

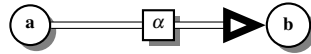

Figure 2

Some interesting structures in our approach corresponding to the notion of acceptability given in Def. 10:

<i>complete</i>	$(\{a, b\}, \{\}, \{\alpha\})$
<i>preferred</i>	$(\{a, b\}, \{\}, \{\alpha\})$
<i>stable</i>	$(\{a, b\}, \{\}, \{\alpha\})$
<i>grounded</i>	$(\{a, b\}, \{\}, \{\alpha\})$

Some interesting extensions using [10]:

<i>complete</i>	$\{a, b, \alpha\}$
<i>preferred</i>	$\{a, b, \alpha\}$
<i>stable</i>	$\{a, b, \alpha\}$
<i>grounded</i>	$\{a, b, \alpha\}$

There is a one to one correspondence between our approach and [10].

This example is also an AFN. In this case, the resulting extensions are:

<i>complete</i>	$\{a, b\}$
<i>preferred</i>	$\{a, b\}$
<i>stable</i>	$\{a, b\}$
<i>grounded</i>	$\{a, b\}$

Ex. 4 (cont'd) Consider the framework represented in Figure 3.

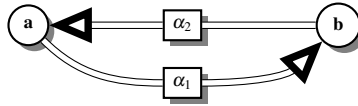

Figure 3

Some interesting structures in our approach corresponding to the notion of acceptability given in Def. 10:

<i>complete</i>	$(\{\}, \{\}, \{\alpha_1, \alpha_2\})$
<i>preferred</i>	$(\{\}, \{\}, \{\alpha_1, \alpha_2\})$
<i>stable</i>	$(\{\}, \{\}, \{\alpha_1, \alpha_2\})$
<i>grounded</i>	$(\{\}, \{\}, \{\alpha_1, \alpha_2\})$

Due to the existence of a cycle of supports, definitions given in [10] cannot be applied.

This example is also an AFN. In this case, the resulting extensions are:

<i>complete</i>	$\{\}$
<i>preferred</i>	$\{\}$
<i>stable</i>	$\{\}$
<i>grounded</i>	$\{\}$

Ex. 11 (cont'd) Consider the framework depicted in Figure 4.

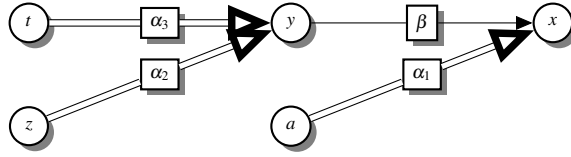

Figure 4

Some interesting structures in our approach corresponding to the notion of acceptability given in Def. 10:

<i>complete</i>	$(\{a, y, z, t\}, \{\beta\}, \{\alpha_1, \alpha_2, \alpha_3\})$
<i>preferred</i>	$(\{a, y, z, t\}, \{\beta\}, \{\alpha_1, \alpha_2, \alpha_3\})$
<i>stable</i>	$(\{a, y, z, t\}, \{\beta\}, \{\alpha_1, \alpha_2, \alpha_3\})$
<i>grounded</i>	$(\{a, y, z, t\}, \{\beta\}, \{\alpha_1, \alpha_2, \alpha_3\})$

Some interesting extensions using [10]:

<i>complete</i>	$\{a, y, z, t, \beta, \alpha_1, \alpha_2, \alpha_3\}$
<i>preferred</i>	$\{a, y, z, t, \beta, \alpha_1, \alpha_2, \alpha_3\}$
<i>stable</i>	$\{a, y, z, t, \beta, \alpha_1, \alpha_2, \alpha_3\}$
<i>grounded</i>	$\{a, y, z, t, \beta, \alpha_1, \alpha_2, \alpha_3\}$

There is a one to one correspondence between our approach and [10].

This example is also an AFN. In this case, the resulting extensions are:

<i>complete</i>	$\{a, y, z, t\}$
<i>preferred</i>	$\{a, y, z, t\}$
<i>stable</i>	$\{a, y, z, t\}$
<i>grounded</i>	$\{a, y, z, t\}$

Ex. 12 (cont'd) Consider the RAFN obtained by adding an attack γ from a to z in the RAFN given in Ex. 11 (see figure 5).

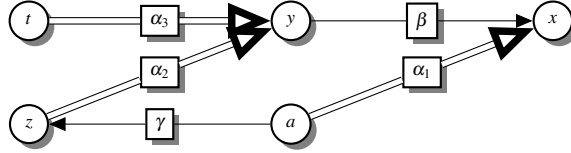

Figure 5

Some interesting structures in our approach corresponding to the notion of acceptability given in Def. 10:

<i>complete</i>	$(\{a, x, t\}, \{\beta, \gamma\}, \{\alpha_1, \alpha_2, \alpha_3\})$
<i>preferred</i>	$(\{a, x, t\}, \{\beta, \gamma\}, \{\alpha_1, \alpha_2, \alpha_3\})$
<i>stable</i>	$(\{a, x, t\}, \{\beta, \gamma\}, \{\alpha_1, \alpha_2, \alpha_3\})$
<i>grounded</i>	$(\{a, x, t\}, \{\beta, \gamma\}, \{\alpha_1, \alpha_2, \alpha_3\})$

Some interesting extensions using [10]:

<i>complete</i>	$(\{a, x, t, \gamma, \alpha_1, \alpha_2, \alpha_3\})$
<i>preferred</i>	$(\{a, x, t, \gamma, \alpha_1, \alpha_2, \alpha_3\})$
<i>stable</i>	$(\{a, x, t, \gamma, \alpha_1, \alpha_2, \alpha_3\})$
<i>grounded</i>	$(\{a, x, t, \gamma, \alpha_1, \alpha_2, \alpha_3\})$

There is no one to one correspondence between our approach and [10] (particularly since β does not belong to the extensions defined for the ASAF).

This example is also an AFN. In this case, the resulting extensions are:

<i>complete</i>	$\{a, x, t\}$
<i>preferred</i>	$\{a, x, t\}$
<i>stable</i>	$\{a, x, t\}$
<i>grounded</i>	$\{a, x, t\}$

Ex. 13 (cont'd) Consider the framework RAF_N_2 depicted in Figure 6.

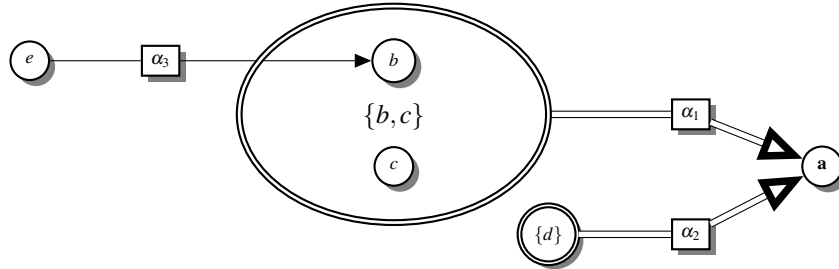

Figure 6

Some interesting structures in our approach corresponding to the notion of acceptability given in Def. 10:

<i>complete</i>	$(\{a, c, d, e\}, \{\alpha_3\}, \{\alpha_1, \alpha_2\})$
<i>preferred</i>	$(\{a, c, d, e\}, \{\alpha_3\}, \{\alpha_1, \alpha_2\})$
<i>stable</i>	$(\{a, c, d, e\}, \{\alpha_3\}, \{\alpha_1, \alpha_2\})$
<i>grounded</i>	$(\{a, c, d, e\}, \{\alpha_3\}, \{\alpha_1, \alpha_2\})$

Due to the fact that a source of a support is a set, definitions given in [10] cannot be applied.

This example is also an AFN. In this case, the resulting extensions are:

<i>complete</i>	$\{a, c, d, e\}$
<i>preferred</i>	$\{a, c, d, e\}$
<i>stable</i>	$\{a, c, d, e\}$
<i>grounded</i>	$\{a, c, d, e\}$

A.2 Some other examples

Ex. 7 (cont'd) Let $AFN = \langle \{a, b, c\}, \emptyset, \{(\{b\}, a), (\{c\}, a)\} \rangle$ and RAF_N be the recursive AFN obtained from AFN just by naming the supports (see Figure 7).

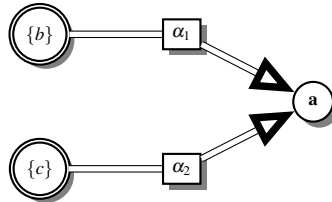

Figure 7

Some interesting structures in our approach corresponding to the notion of acceptability given in Def. 10:

<i>complete</i>	$(\{a, b, c\}, \{\}, \{\alpha_1, \alpha_2\})$
<i>preferred</i>	$(\{a, b, c\}, \{\}, \{\alpha_1, \alpha_2\})$
<i>stable</i>	$(\{a, b, c\}, \{\}, \{\alpha_1, \alpha_2\})$
<i>grounded</i>	$(\{a, b, c\}, \{\}, \{\alpha_1, \alpha_2\})$

Some interesting extensions using [10]:

<i>complete</i>	$\{a, b, c, \alpha_1, \alpha_2\}$
<i>preferred</i>	$\{a, b, c, \alpha_1, \alpha_2\}$
<i>stable</i>	$\{a, b, c, \alpha_1, \alpha_2\}$
<i>grounded</i>	$\{a, b, c, \alpha_1, \alpha_2\}$

There is a one to one correspondence between our approach and [10].

This example is also an AFN. In this case, the resulting extensions are:

<i>complete</i>	$\{a, b, c\}$
<i>preferred</i>	$\{a, b, c\}$
<i>stable</i>	$\{a, b, c\}$
<i>grounded</i>	$\{a, b, c\}$

Ex. 8 (cont'd) Consider RAF_N' obtained from RAF_N given in Ex. 7 by adding an attack from an argument d to α_1 (see Figure 8).

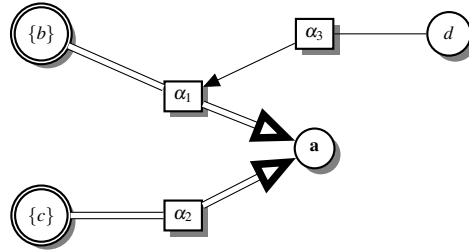

Figure 8

Some interesting structures in our approach corresponding to the notion of acceptability given in Def. 10:

<i>complete</i>	$(\{a, b, c, d\}, \{\alpha_3\}, \{\alpha_2\})$
<i>preferred</i>	$(\{a, b, c, d\}, \{\alpha_3\}, \{\alpha_2\})$
<i>stable</i>	$(\{a, b, c, d\}, \{\alpha_3\}, \{\alpha_2\})$
<i>grounded</i>	$(\{a, b, c, d\}, \{\alpha_3\}, \{\alpha_2\})$

Some interesting extensions using [10]:

<i>complete</i>	$\{a, b, c, d, \alpha_3, \alpha_2\}$
<i>preferred</i>	$\{a, b, c, d, \alpha_3, \alpha_2\}$
<i>stable</i>	$\{a, b, c, d, \alpha_3, \alpha_2\}$
<i>grounded</i>	$\{a, b, c, d, \alpha_3, \alpha_2\}$

There is a one to one correspondence between our approach and [10].

Ex. 9 (cont'd) Consider the RAFN framework corresponding to the graph depicted in Figure 9.

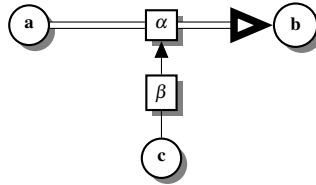

Figure 9

Some interesting structures in our approach corresponding to the notion of acceptability given in Def. 10:

<i>complete</i>	$(\{a, b, c\}, \{\beta\}, \{\})$
<i>preferred</i>	$(\{a, b, c\}, \{\beta\}, \{\})$
<i>stable</i>	$(\{a, b, c\}, \{\beta\}, \{\})$
<i>grounded</i>	$(\{a, b, c\}, \{\beta\}, \{\})$

Some interesting extensions using [10]:

<i>complete</i>	$\{a, b, c, \beta\}$
<i>preferred</i>	$\{a, b, c, \beta\}$
<i>stable</i>	$\{a, b, c, \beta\}$
<i>grounded</i>	$\{a, b, c, \beta\}$

There is a one to one correspondence between our approach and [10].

Ex. 10 (cont'd) Consider the RAFN framework corresponding to the graph depicted in Figure 10.

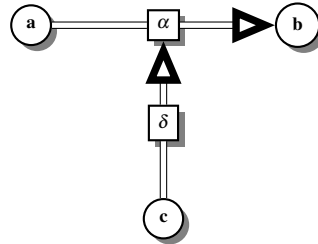

Figure 10

Some interesting structures in our approach corresponding to the notion of acceptability given in Def. 10:

<i>complete</i>	$(\{a, b, c\}, \{\}, \{\alpha, \delta\})$
<i>preferred</i>	$(\{a, b, c\}, \{\}, \{\alpha, \delta\})$
<i>stable</i>	$(\{a, b, c\}, \{\}, \{\alpha, \delta\})$
<i>grounded</i>	$(\{a, b, c\}, \{\}, \{\alpha, \delta\})$

Some interesting extensions using [10]:

<i>complete</i>	$\{a, b, c, \alpha, \delta\}$
<i>preferred</i>	$\{a, b, c, \alpha, \delta\}$
<i>stable</i>	$\{a, b, c, \alpha, \delta\}$
<i>grounded</i>	$\{a, b, c, \alpha, \delta\}$

There is a one to one correspondence between our approach and [10].

Ex. 14 Consider the RAFN framework corresponding to the graph depicted in Figure 11.

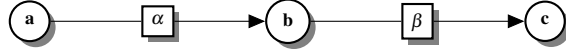

Figure 11

Some interesting structures in our approach corresponding to the notion of acceptability given in Def. 10:

<i>complete</i>	$(\{a, c\}, \{\alpha, \beta\}, \{\})$
<i>preferred</i>	$(\{a, c\}, \{\alpha, \beta\}, \{\})$
<i>stable</i>	$(\{a, c\}, \{\alpha, \beta\}, \{\})$
<i>grounded</i>	$(\{a, c\}, \{\alpha, \beta\}, \{\})$

Some interesting extensions using [10]:

<i>complete</i>	$\{a, c, \alpha\}$
<i>preferred</i>	$\{a, c, \alpha\}$
<i>stable</i>	$\{a, c, \alpha\}$
<i>grounded</i>	$\{a, c, \alpha\}$

There is no one to one correspondence between our approach and [10] (since β does not belong to the extensions given in [10]).

Moreover, since this example is also a classical AF, if we consider Dung's semantics, the resulting extensions are:

<i>complete</i>	$\{a, c\}$
<i>preferred</i>	$\{a, c\}$
<i>stable</i>	$\{a, c\}$
<i>grounded</i>	$\{a, c\}$

This example is also an AFN. In this case, the resulting extensions are:

<i>complete</i>	$\{a, c\}$
<i>preferred</i>	$\{a, c\}$
<i>stable</i>	$\{a, c\}$
<i>grounded</i>	$\{a, c\}$

This example is also a RAF. In this case, the resulting structures are:

<i>complete</i>	$(\{a, c\}, \{\alpha, \beta\})$
<i>preferred</i>	$(\{a, c\}, \{\alpha, \beta\})$
<i>stable</i>	$(\{a, c\}, \{\alpha, \beta\})$
<i>grounded</i>	$(\{a, c\}, \{\alpha, \beta\})$

Ex. 15 Consider the RAFN framework corresponding to the graph depicted in Figure 12.

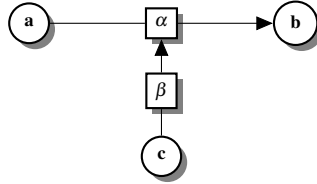

Figure 12

Some interesting structures in our approach corresponding to the notion of acceptability given in Def. 10:

<i>complete</i>	$(\{a, b, c\}, \{\beta\}, \{\})$
<i>preferred</i>	$(\{a, b, c\}, \{\beta\}, \{\})$
<i>stable</i>	$(\{a, b, c\}, \{\beta\}, \{\})$
<i>grounded</i>	$(\{a, b, c\}, \{\beta\}, \{\})$

Some interesting extensions using [10]:

<i>complete</i>	$\{a, b, c, \beta\}$
<i>preferred</i>	$\{a, b, c, \beta\}$
<i>stable</i>	$\{a, b, c, \beta\}$
<i>grounded</i>	$\{a, b, c, \beta\}$

There is a one to one correspondence between our approach and [10].

This example is also a RAF. In this case, the resulting structures are:

<i>complete</i>	$(\{a, b, c\}, \{\beta\})$
<i>preferred</i>	$(\{a, b, c\}, \{\beta\})$
<i>stable</i>	$(\{a, b, c\}, \{\beta\})$
<i>grounded</i>	$(\{a, b, c\}, \{\beta\})$

Ex. 16 Consider the RAFN framework corresponding to the graph depicted in Figure 13.

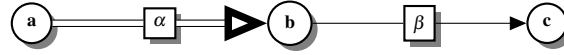

Figure 13

Some interesting structures in our approach corresponding to the notion of acceptability given in Def. 10:

<i>complete</i>	$(\{a, b\}, \{\beta\}, \{\alpha\})$
<i>preferred</i>	$(\{a, b\}, \{\beta\}, \{\alpha\})$
<i>stable</i>	$(\{a, b\}, \{\beta\}, \{\alpha\})$
<i>grounded</i>	$(\{a, b\}, \{\beta\}, \{\alpha\})$

Some interesting extensions using [10]:

<i>complete</i>	$\{a, b, \beta, \alpha\}$
<i>preferred</i>	$\{a, b, \beta, \alpha\}$
<i>stable</i>	$\{a, b, \beta, \alpha\}$
<i>grounded</i>	$\{a, b, \beta, \alpha\}$

There is a one to one correspondence between our approach and [10].

This example is also an AFN. In this case, the resulting extensions are:

<i>complete</i>	$\{a, b\}$
<i>preferred</i>	$\{a, b\}$
<i>stable</i>	$\{a, b\}$
<i>grounded</i>	$\{a, b\}$

Ex. 17 Consider the RAFN framework corresponding to the graph depicted in Figure 14.

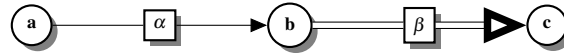

Figure 14

Some interesting structures in our approach corresponding to the notion of acceptability given in Def. 10:

<i>complete</i>	$(\{a\}, \{\alpha\}, \{\beta\})$
<i>preferred</i>	$(\{a\}, \{\alpha\}, \{\beta\})$
<i>stable</i>	$(\{a\}, \{\alpha\}, \{\beta\})$
<i>grounded</i>	$(\{a\}, \{\alpha\}, \{\beta\})$

Some interesting extensions using [10]:

<i>complete</i>	$\{a, \alpha, \beta\}$
<i>preferred</i>	$\{a, \alpha, \beta\}$
<i>stable</i>	$\{a, \alpha, \beta\}$
<i>grounded</i>	$\{a, \alpha, \beta\}$

There is no one to one correspondence between our approach and [10].

This example is also an AFN. In this case, the resulting extensions are:

<i>complete</i>	$\{a\}$
<i>preferred</i>	$\{a\}$
<i>stable</i>	$\{a\}$
<i>grounded</i>	$\{a\}$

Ex. 18 Consider the RAFN framework corresponding to the graph depicted in Figure 15.

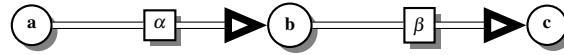

Figure 15

Some interesting structures in our approach corresponding to the notion of acceptability given in Def. 10:

<i>complete</i>	$(\{a, b, c\}, \{\}, \{\alpha, \beta\})$
<i>preferred</i>	$(\{a, b, c\}, \{\}, \{\alpha, \beta\})$
<i>stable</i>	$(\{a, b, c\}, \{\}, \{\alpha, \beta\})$
<i>grounded</i>	$(\{a, b, c\}, \{\}, \{\alpha, \beta\})$

Some interesting extensions using [10]:

<i>complete</i>	$\{a, b, c, \alpha, \beta\}$
<i>preferred</i>	$\{a, b, c, \alpha, \beta\}$
<i>stable</i>	$\{a, b, c, \alpha, \beta\}$
<i>grounded</i>	$\{a, b, c, \alpha, \beta\}$

There is a one to one correspondence between our approach and [10].

This example is also an AFN. In this case, the resulting extensions are:

<i>complete</i>	$\{a, b, c\}$
<i>preferred</i>	$\{a, b, c\}$
<i>stable</i>	$\{a, b, c\}$
<i>grounded</i>	$\{a, b, c\}$

Ex. 19 Consider the RAFN framework corresponding to the graph depicted in Figure 16.

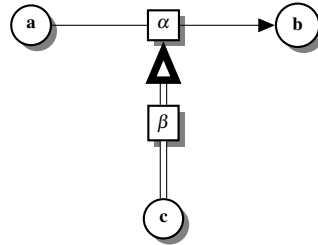

Figure 16

Some interesting structures in our approach corresponding to the notion of acceptability given in Def. 10:

<i>complete</i>	$(\{a, c\}, \{\alpha\}, \{\beta\})$
<i>preferred</i>	$(\{a, c\}, \{\alpha\}, \{\beta\})$
<i>stable</i>	$(\{a, c\}, \{\alpha\}, \{\beta\})$
<i>grounded</i>	$(\{a, c\}, \{\alpha\}, \{\beta\})$

Some interesting extensions using [10]:

<i>complete</i>	$\{a, c, \alpha, \beta\}$
<i>preferred</i>	$\{a, c, \alpha, \beta\}$
<i>stable</i>	$\{a, c, \alpha, \beta\}$
<i>grounded</i>	$\{a, c, \alpha, \beta\}$

There is a one to one correspondence between our approach and [10].

Ex. 20 Consider the RAFN framework corresponding to the graph depicted in Figure 17.

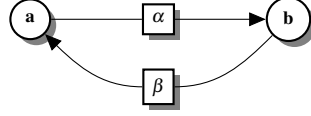

Figure 17

Some interesting structures in our approach corresponding to the notion of acceptability given in Def. 10:

<i>complete</i>	$(\{\}, \{\alpha, \beta\}, \{\}), (\{a\}, \{\alpha, \beta\}, \{\}), (\{b\}, \{\alpha, \beta\}, \{\})$
<i>preferred</i>	$(\{a\}, \{\alpha, \beta\}, \{\}), (\{b\}, \{\alpha, \beta\}, \{\})$
<i>stable</i>	$(\{a\}, \{\alpha, \beta\}, \{\}), (\{b\}, \{\alpha, \beta\}, \{\})$
<i>grounded</i>	$(\{\}, \{\alpha, \beta\}, \{\})$

Some interesting extensions using [10]:

<i>complete</i>	$\{\}, \{a, \alpha\}, \{b, \beta\}$
<i>preferred</i>	$\{a, \alpha\}, \{b, \beta\}$
<i>stable</i>	$\{a, \alpha\}, \{b, \beta\}$
<i>grounded</i>	$\{\}$

There is no one to one correspondence between our approach and [10]. Indeed, with the approach proposed by [10], α and β cannot be accepted together.

Moreover, since this example is also a classical AF, if we consider Dung's semantics, the resulting extensions are:

<i>complete</i>	$\{\}, \{a\}, \{b\}$
<i>preferred</i>	$\{a\}, \{b\}$
<i>stable</i>	$\{a\}, \{b\}$
<i>grounded</i>	$\{\}$

This example is also an AFN. In this case, the resulting extensions are:

<i>complete</i>	$\{\}, \{a\}, \{b\}$
<i>preferred</i>	$\{a\}, \{b\}$
<i>stable</i>	$\{a\}, \{b\}$
<i>grounded</i>	$\{\}$

This example is also a RAF. In this case, the resulting structures are:

<i>complete</i>	$(\{\}, \{\alpha, \beta\}), (\{a\}, \{\alpha, \beta\}), (\{a\}, \{\alpha, \beta\})$
<i>preferred</i>	$(\{a\}, \{\alpha, \beta\}), (\{b\}, \{\alpha, \beta\})$
<i>stable</i>	$(\{a\}, \{\alpha, \beta\}), (\{b\}, \{\alpha, \beta\})$
<i>grounded</i>	$(\{\}, \{\alpha, \beta\})$

Ex. 21 Consider the RAFN framework corresponding to the graph depicted in Figure 18.

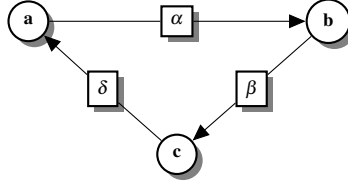

Figure 18

Some interesting structures in our approach corresponding to the notion of acceptability given in Def. 10:

<i>complete</i>	$(\{\}, \{\alpha, \beta, \delta\}, \{\})$
<i>preferred</i>	$(\{\}, \{\alpha, \beta, \delta\}, \{\})$
<i>stable</i>	<i>no stable</i>
<i>grounded</i>	$(\{\}, \{\alpha, \beta, \delta\}, \{\})$

Some interesting extensions using [10]:

<i>complete</i>	$\{\}$
<i>preferred</i>	$\{\}$
<i>stable</i>	<i>no stable</i>
<i>grounded</i>	$\{\}$

There is no one to one correspondence between our approach and [10]. Indeed, with the approach proposed by [10], α , β and δ cannot be accepted together.

Moreover, since this example is also a classical AF, if we consider Dung's semantics, the resulting extensions are:

<i>complete</i>	$\{\}$
<i>preferred</i>	$\{\}$
<i>stable</i>	<i>no stable</i>
<i>grounded</i>	$\{\}$

This example is also an AFN. In this case, the resulting extensions are:

<i>complete</i>	$\{\}$
<i>preferred</i>	$\{\}$
<i>stable</i>	<i>no stable</i>
<i>grounded</i>	$\{\}$

This example is also a RAF. In this case, the resulting structures are:

<i>complete</i>	$(\{\}, \{\alpha, \beta, \delta\})$
<i>preferred</i>	$(\{\}, \{\alpha, \beta, \delta\})$
<i>stable</i>	<i>no stable</i>
<i>grounded</i>	$(\{\}, \{\alpha, \beta, \delta\})$

Ex. 22 Consider the RAFN framework corresponding to the graph depicted in Figure 19.

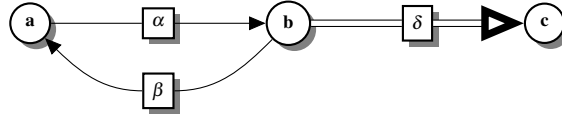

Figure 19

Some interesting structures in our approach corresponding to the notion of acceptability given in Def. 10:

<i>complete</i>	$(\{\}, \{\alpha, \beta\}, \{\delta\}), (\{a\}, \{\alpha, \beta\}, \{\delta\}), (\{b, c\}, \{\alpha, \beta\}, \{\delta\})$
<i>preferred</i>	$(\{a\}, \{\alpha, \beta\}, \{\delta\}), (\{b, c\}, \{\alpha, \beta\}, \{\delta\})$
<i>stable</i>	$(\{a\}, \{\alpha, \beta\}, \{\delta\}), (\{b, c\}, \{\alpha, \beta\}, \{\delta\})$
<i>grounded</i>	$(\{\}, \{\alpha, \beta\}, \{\delta\})$

Some interesting extensions using [10]:

<i>complete</i>	$\{\delta\}, \{a, \alpha, \delta\}, \{b, c, \beta, \delta\}$
<i>preferred</i>	$\{a, \alpha, \delta\}, \{b, c, \beta, \delta\}$
<i>stable</i>	$\{a, \alpha, \delta\}, \{b, c, \beta, \delta\}$
<i>grounded</i>	$\{\delta\}$

There is no one to one correspondence between our approach and [10]. Indeed, with the approach proposed by [10], α and β cannot be accepted together.

This example is also an AFN. In this case, the resulting extensions are:

<i>complete</i>	$\{\}, \{a\}, \{b, c\}$
<i>preferred</i>	$\{a\}, \{b, c\}$
<i>stable</i>	$\{a\}, \{b, c\}$
<i>grounded</i>	$\{\}$

Ex. 23 Consider the RAFN framework corresponding to the graph depicted in Figure 20.

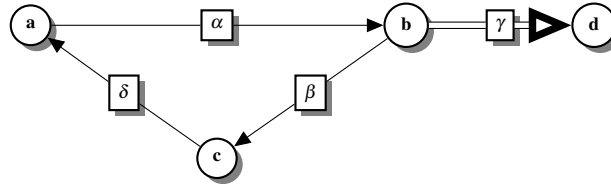

Figure 20

Some interesting structures in our approach corresponding to the notion of acceptability given in Def. 10:

<i>complete</i>	$(\{\}, \{\alpha, \beta, \delta\}, \{\gamma\})$
<i>preferred</i>	$(\{\}, \{\alpha, \beta, \delta\}, \{\gamma\})$
<i>stable</i>	no stable
<i>grounded</i>	$(\{\}, \{\alpha, \beta, \delta\}, \{\gamma\})$

Some interesting extensions using [10]:

<i>complete</i>	$\{\gamma\}$
<i>preferred</i>	$\{\gamma\}$
<i>stable</i>	no stable
<i>grounded</i>	$\{\gamma\}$

There is no one to one correspondence between our approach and [10]. Indeed, with the approach proposed by [10], α , β and δ cannot be accepted together.

This example is also an AFN. In this case, the resulting extensions are:

<i>complete</i>	$\{\}$
<i>preferred</i>	$\{\}$
<i>stable</i>	no stable
<i>grounded</i>	$\{\}$

Ex. 24 Consider the RAFN framework corresponding to the graph depicted in Figure 21.

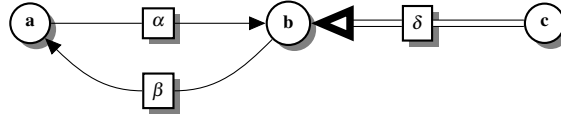

Figure 21

Some interesting structures in our approach corresponding to the notion of acceptability given in Def. 10:

<i>complete</i>	$(\{c\}, \{\alpha, \beta\}, \{\delta\}), (\{a, c\}, \{\alpha, \beta\}, \{\delta\}), (\{b, c\}, \{\alpha, \beta\}, \{\delta\})$
<i>preferred</i>	$(\{a, c\}, \{\alpha, \beta\}, \{\delta\}), (\{b, c\}, \{\alpha, \beta\}, \{\delta\})$
<i>stable</i>	$(\{a, c\}, \{\alpha, \beta\}, \{\delta\}), (\{b, c\}, \{\alpha, \beta\}, \{\delta\})$
<i>grounded</i>	$(\{c\}, \{\alpha, \beta\}, \{\delta\})$

Some interesting extensions using [10]:

<i>complete</i>	$\{c, \delta\}, \{a, c, \alpha, \delta\}, \{b, c, \beta, \delta\}$
<i>preferred</i>	$\{a, c, \alpha, \delta\}, \{b, c, \beta, \delta\}$
<i>stable</i>	$\{a, c, \alpha, \delta\}, \{b, c, \beta, \delta\}$
<i>grounded</i>	$\{c, \delta\}$

There is no one to one correspondence between our approach and [10]. Indeed, with the approach proposed by [10], α and β cannot be accepted together.

This example is also an AFN. In this case, the resulting extensions are:

<i>complete</i>	$\{c\}, \{a, c\}, \{b, c\}$
<i>preferred</i>	$\{a, c\}, \{b, c\}$
<i>stable</i>	$\{a, c\}, \{b, c\}$
<i>grounded</i>	$\{c\}$

Ex. 25 Consider the RAFN framework corresponding to the graph depicted in Figure 22.

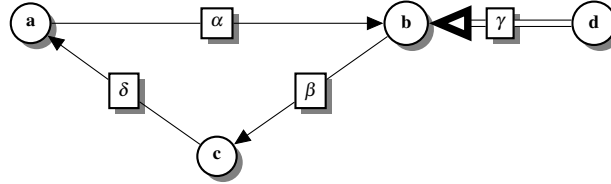

Figure 22

Some interesting structures in our approach corresponding to the notion of acceptability given in Def. 10:

<i>complete</i>	$(\{d\}, \{\alpha, \beta, \delta\}, \{\gamma\})$
<i>preferred</i>	$(\{d\}, \{\alpha, \beta, \delta\}, \{\gamma\})$
<i>stable</i>	<i>no stable</i>
<i>grounded</i>	$(\{d\}, \{\alpha, \beta, \delta\}, \{\gamma\})$

Some interesting extensions using [10]:

<i>complete</i>	$\{d, \gamma\}$
<i>preferred</i>	$\{d, \gamma\}$
<i>stable</i>	<i>no stable</i>
<i>grounded</i>	$\{d, \gamma\}$

There is no one to one correspondence between our approach and [10]. Indeed, with the approach proposed by [10], α , β and δ cannot be accepted together.

This example is also an AFN. In this case, the resulting extensions are:

<i>complete</i>	$\{d\}$
<i>preferred</i>	$\{d\}$
<i>stable</i>	<i>no stable</i>
<i>grounded</i>	$\{d\}$

Ex. 26 Consider the RAFN framework corresponding to the graph depicted in Figure 23.

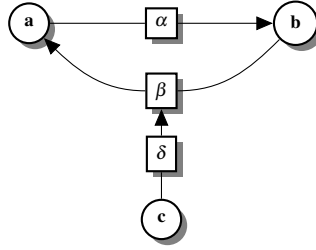

Figure 23

Some interesting structures in our approach corresponding to the notion of acceptability given in Def. 10:

<i>complete</i>	$(\{a, c\}, \{\delta, \alpha\}, \{\})$
<i>preferred</i>	$(\{a, c\}, \{\delta, \alpha\}, \{\})$
<i>stable</i>	$(\{a, c\}, \{\delta, \alpha\}, \{\})$
<i>grounded</i>	$(\{a, c\}, \{\delta, \alpha\}, \{\})$

Some interesting extensions using [10]:

<i>complete</i>	$\{a, c, \delta, \alpha\}$
<i>preferred</i>	$\{a, c, \delta, \alpha\}$
<i>stable</i>	$\{a, c, \delta, \alpha\}$
<i>grounded</i>	$\{a, c, \delta, \alpha\}$

There is a one to one correspondence between our approach and [10].

This example is also a RAF. In this case, the resulting structures are:

<i>complete</i>	$(\{a, c\}, \{\delta, \alpha\})$
<i>preferred</i>	$(\{a, c\}, \{\delta, \alpha\})$
<i>stable</i>	$(\{a, c\}, \{\delta, \alpha\})$
<i>grounded</i>	$(\{a, c\}, \{\delta, \alpha\})$

Ex. 27 Consider the RAFN framework corresponding to the graph depicted in Figure 24.

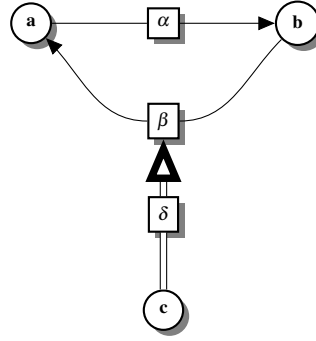

Figure 24

Some interesting structures in our approach corresponding to the notion of acceptability given in Def. 10:

complete	$(\{c\}, \{\alpha, \beta\}, \{\delta\}), (\{a, c\}, \{\alpha, \beta\}, \{\delta\}), (\{b, c\}, \{\alpha, \beta\}, \{\delta\})$
preferred	$(\{a, c\}, \{\alpha, \beta\}, \{\delta\}), (\{b, c\}, \{\alpha, \beta\}, \{\delta\})$
stable	$(\{a, c\}, \{\alpha, \beta\}, \{\delta\}), (\{b, c\}, \{\alpha, \beta\}, \{\delta\})$
grounded	$(\{c\}, \{\alpha, \beta\}, \{\delta\})$

Some interesting extensions using [10]:

complete	$\{c, \delta\}, \{a, c, \alpha, \delta\}, \{b, c, \beta, \delta\}$
preferred	$\{a, c, \alpha, \delta\}, \{b, c, \beta, \delta\}$
stable	$\{a, c, \alpha, \delta\}, \{b, c, \beta, \delta\}$
grounded	$\{c, \delta\}$

There is no one to one correspondence between our approach and [10]. Indeed, with the approach proposed by [10], α and β cannot be accepted together.

Ex. 28 Consider the RAFN framework corresponding to the graph depicted in Figure 25.

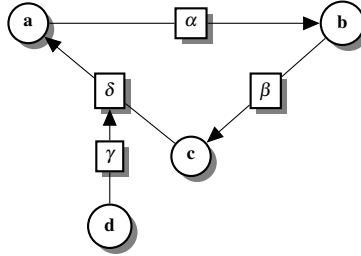

Figure 25

Some interesting structures in our approach corresponding to the notion of acceptability given in Def. 10:

complete	$(\{a, c, d\}, \{\alpha, \beta, \gamma\}, \{\})$
preferred	$(\{a, c, d\}, \{\alpha, \beta, \gamma\}, \{\})$
stable	$(\{a, c, d\}, \{\alpha, \beta, \gamma\}, \{\})$
grounded	$(\{a, c, d\}, \{\alpha, \beta, \gamma\}, \{\})$

Some interesting extensions using [10]:

complete	$\{a, c, d, \alpha, \gamma\}$
preferred	$\{a, c, d, \alpha, \gamma\}$
stable	$\{a, c, d, \alpha, \gamma\}$
grounded	$\{a, c, d, \alpha, \gamma\}$

There is no one to one correspondence between our approach and [10]. Indeed, with the approach proposed by [10], α , β and δ cannot be accepted together.

This example is also a RAF. In this case, the resulting structures are:

complete	$(\{a, c, d\}, \{\alpha, \beta, \gamma\})$
preferred	$(\{a, c, d\}, \{\alpha, \beta, \gamma\})$
stable	$(\{a, c, d\}, \{\alpha, \beta, \gamma\})$
grounded	$(\{a, c, d\}, \{\alpha, \beta, \gamma\})$

Ex. 29 Consider the RAFN framework corresponding to the graph depicted in Figure 26.

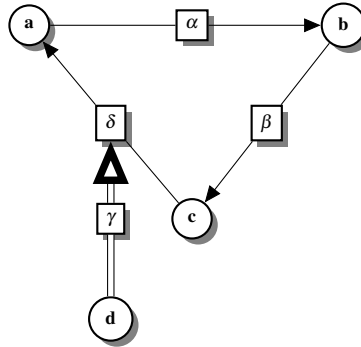

Figure 26

Some interesting structures in our approach corresponding to the notion of acceptability given in Def. 10:

<i>complete</i>	$(\{d\}, \{\alpha, \beta, \delta\}, \{\gamma\})$
<i>preferred</i>	$(\{d\}, \{\alpha, \beta, \delta\}, \{\gamma\})$
<i>stable</i>	<i>no stable</i>
<i>grounded</i>	$(\{d\}, \{\alpha, \beta, \delta\}, \{\gamma\})$

Some interesting extensions using [10]:

<i>complete</i>	$\{d, \gamma\}$
<i>preferred</i>	$\{d, \gamma\}$
<i>stable</i>	<i>no stable</i>
<i>grounded</i>	$\{d, \gamma\}$

There is no one to one correspondence between our approach and [10]. Indeed, with the approach proposed by [10], α , β and δ cannot be accepted together.

Ex. 30 Consider the RAFN framework corresponding to the graph depicted in Figure 27.

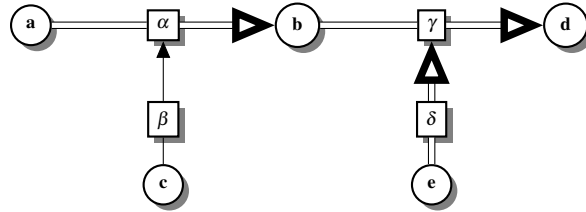

Figure 27

Some interesting structures in our approach corresponding to the notion of acceptability given in Def. 10:

<i>complete</i>	$(\{a, b, c, d, e\}, \{\beta\}, \{\gamma, \delta\})$
<i>preferred</i>	$(\{a, b, c, d, e\}, \{\beta\}, \{\gamma, \delta\})$
<i>stable</i>	$(\{a, b, c, d, e\}, \{\beta\}, \{\gamma, \delta\})$
<i>grounded</i>	$(\{a, b, c, d, e\}, \{\beta\}, \{\gamma, \delta\})$

Some interesting extensions using [10]:

<i>complete</i>	$\{a, b, c, d, e, \beta, \gamma, \delta\}$
<i>preferred</i>	$\{a, b, c, d, e, \beta, \gamma, \delta\}$
<i>stable</i>	$\{a, b, c, d, e, \beta, \gamma, \delta\}$
<i>grounded</i>	$\{a, b, c, d, e, \beta, \gamma, \delta\}$

There is a one to one correspondence between our approach and [10].

Ex. 31 Consider the RAFN depicted in Figure 28.

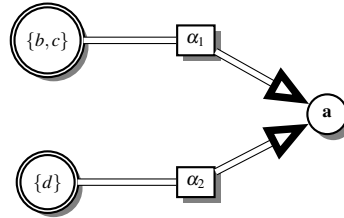

Figure 28

Some interesting structures in our approach corresponding to the notion of acceptability given in Def. 10:

<i>complete</i>	$(\{a, b, c, d\}, \{\}, \{\alpha_1, \alpha_2\})$
<i>preferred</i>	$(\{a, b, c, d\}, \{\}, \{\alpha_1, \alpha_2\})$
<i>stable</i>	$(\{a, b, c, d\}, \{\}, \{\alpha_1, \alpha_2\})$
<i>grounded</i>	$(\{a, b, c, d\}, \{\}, \{\alpha_1, \alpha_2\})$

Due to the fact that a source of a support is a set, definitions given in [10] cannot be applied.

This example is also an AFN. In this case, the resulting extensions are:

<i>complete</i>	$\{a, b, c, d\}$
<i>preferred</i>	$\{a, b, c, d\}$
<i>stable</i>	$\{a, b, c, d\}$
<i>grounded</i>	$\{a, b, c, d\}$

Ex. 32 Consider the framework RAFN depicted in Figure 29.

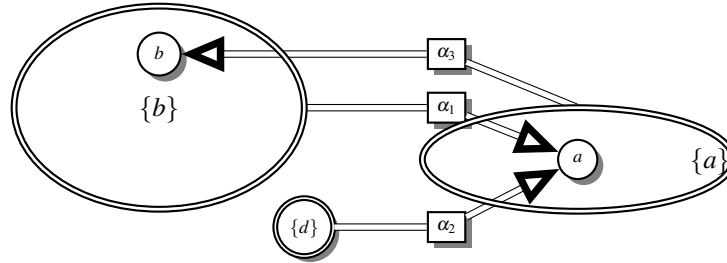

Figure 29

Some interesting structures in our approach corresponding to the notion of acceptability given in Def. 10:

<i>complete</i>	$(\{d\}, \{\}, \{\alpha_1, \alpha_2, \alpha_3\})$
<i>preferred</i>	$(\{d\}, \{\}, \{\alpha_1, \alpha_2, \alpha_3\})$
<i>stable</i>	$(\{d\}, \{\}, \{\alpha_1, \alpha_2, \alpha_3\})$
<i>grounded</i>	$(\{d\}, \{\}, \{\alpha_1, \alpha_2, \alpha_3\})$

Due to the existence of a cycle of supports, definitions given in [10] cannot be applied.

This example is also an AFN. In this case, the resulting extensions are:

<i>complete</i>	$\{d\}$
<i>preferred</i>	$\{d\}$
<i>stable</i>	$\{d\}$
<i>grounded</i>	$\{d\}$

Ex. 33 Consider now the framework RAF_N' depicted in Figure 30.

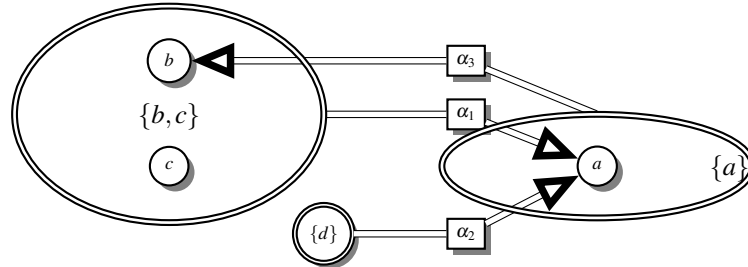

Figure 30

Some interesting structures in our approach corresponding to the notion of acceptability given in Def. 10:

<i>complete</i>	$(\{a, b, c, d\}, \{\}, \{\alpha_1, \alpha_2, \alpha_3\})$
<i>preferred</i>	$(\{a, b, c, d\}, \{\}, \{\alpha_1, \alpha_2, \alpha_3\})$
<i>stable</i>	$(\{a, b, c, d\}, \{\}, \{\alpha_1, \alpha_2, \alpha_3\})$
<i>grounded</i>	$(\{a, b, c, d\}, \{\}, \{\alpha_1, \alpha_2, \alpha_3\})$

Due to the fact that a source of a support is a set, definitions given in [10] cannot be applied.

This example is also an AFN. In this case, the resulting extensions are:

<i>complete</i>	$\{a, b, c, d\}$
<i>preferred</i>	$\{a, b, c, d\}$
<i>stable</i>	$\{a, b, c, d\}$
<i>grounded</i>	$\{a, b, c, d\}$

Ex. 34 Consider the framework depicted in Figure 31.

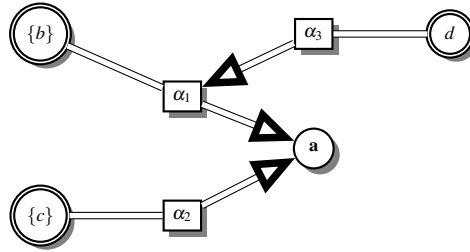

Figure 31

Some interesting structures in our approach corresponding to the notion of acceptability given in Def. 10:

<i>complete</i>	$(\{a, b, c, d\}, \{\}, \{\alpha_1, \alpha_2, \alpha_3\})$
<i>preferred</i>	$(\{a, b, c, d\}, \{\}, \{\alpha_1, \alpha_2, \alpha_3\})$
<i>stable</i>	$(\{a, b, c, d\}, \{\}, \{\alpha_1, \alpha_2, \alpha_3\})$
<i>grounded</i>	$(\{a, b, c, d\}, \{\}, \{\alpha_1, \alpha_2, \alpha_3\})$

Some interesting extensions using [10]:

<i>complete</i>	$\{a, b, c, d, \alpha_1, \alpha_2, \alpha_3\}$
<i>preferred</i>	$\{a, b, c, d, \alpha_1, \alpha_2, \alpha_3\}$
<i>stable</i>	$\{a, b, c, d, \alpha_1, \alpha_2, \alpha_3\}$
<i>grounded</i>	$\{a, b, c, d, \alpha_1, \alpha_2, \alpha_3\}$

There is a one to one correspondence between our approach and [10].

B Proofs

Lemma 1 *Let $T_1 \subseteq T_2 \subseteq \mathbf{A}$. $Supp(U_{T_1}) \subseteq Supp(U_{T_2})$*

Proof: Let $T \subseteq \mathbf{A}$. $Supp(U_T) = \mathbf{P}' \cup \{x \in \mathbf{A} / \forall \alpha \in \mathbf{N}' \text{ such that } t'(\alpha) = x, s'(\alpha) \cap (T \cap Supp(U_{T \setminus \{x\}})) \neq \emptyset\}$. If $T_1 \subseteq T_2 \subseteq \mathbf{A}$, we have $T_1 \setminus \{x\} \subseteq T_2 \setminus \{x\} \subseteq \mathbf{A}$. So the proof just follows by induction. \square

Lemma 2 *Given AFN and its corresponding RAFN, given $T \subseteq \mathbf{A}$, T is conflict-free in AFN iff U_T is a conflict-free structure in RAFN.*

Proof: Note that $Def_{\mathbf{R}'}(U_T) = Def_{\mathbf{N}'}(U_T) = \emptyset$, as interactions target only arguments in RAFN. It follows that U_T is a conflict-free structure in RAFN iff $T \cap Def_{\mathbf{A}}(U_T) = \emptyset$, which is equivalent to T being conflict-free in AFN, due to the definition of RAFN. \square

Lemma 3 *Given AFN and its corresponding RAFN, let $T \subseteq \mathbf{A}$ and $x \in \mathbf{A}$. If $x \in Supp(U_T)$, $\forall \alpha \in \mathbf{N}'$ such that $t'(\alpha) = x$, $\exists y \in (s'(\alpha) \cap T \setminus \{x\} \cap Supp(U_{T \setminus \{x\}}))$.*

Proof:
Let $x \in Supp(U_T)$. $\forall \alpha \in \mathbf{N}'$ such that $t'(\alpha) = x$, $\exists y \in (s'(\alpha) \cap T \cap Supp(U_{T \setminus \{x\}}))$. Assume that for some α_0 with $t'(\alpha_0) = x$ we have $(s'(\alpha_0) \cap T \cap Supp(U_{T \setminus \{x\}})) = \{x\}$ (1). Then $x \in T$ and $x \in Supp(U_{T \setminus \{x\}})$. So, as $t'(\alpha_0) = x$, $\exists z \in (s'(\alpha_0) \cap T \setminus \{x\} \cap Supp(U_{T \setminus \{x\}}))$. We have $z \neq x$ and $z \in (s'(\alpha_0) \cap T \cap Supp(U_{T \setminus \{x\}}))$, which is in contradiction with the assumption (1). \square

Lemma 4 *Given AFN and its corresponding RAFN, let $T \subseteq \mathbf{A}$ and $x \in \mathbf{A}$. If $x \in T$ and $x \in Supp(U_T)$, then $\exists C \subseteq T$ such that $x \in C$ and C is coherent in AFN.*

Proof: Let $x \in Supp(U_T)$. Either $x \in \mathbf{P}'$ or x is supported. In the first case, let $C = \{x\}$. Obviously, C is coherent and $C \subseteq T$, as $x \in T$.
Let us consider the case when x is supported. Let $\alpha_1, \dots, \alpha_k$ be the supports of x . For each i , there is $y_i \in (s'(\alpha_i) \cap T \cap Supp(U_{T \setminus \{x\}}))$, and from Lemma 3, it can be assumed that $y_i \in T \setminus \{x\}$. Let $S_1(x) = \{y_1, \dots, y_k\}$. We have $S_1(x) \subseteq (T \setminus \{x\} \cap Supp(U_{T \setminus \{x\}}))$. We consider $C_1 = \{x\} \cup S_1(x)$.

- If $S_1(x) \subseteq \mathbf{P}'$, it is easy to see that C_1 is support-closed and every $a \in C_1$ is support-cycle-free in C_1 . So C_1 is coherent.
- In the other case, for each $y \in S_1(x)$ such that $y \notin \mathbf{P}'$, as $y \in Supp(U_{T \setminus \{x\}})$, as done for x , we can build a set of arguments $S(y) \subseteq (T \setminus \{x, y\} \cap Supp(U_{T \setminus \{x, y\}}))$. We add all these sets $S(y)$ to C_1 .
- This construction is iterated and will end as T is reduced at each step (T then $T \setminus \{x\}$ then $T \setminus \{x, y\}$, ...).

\square

Lemma 5 *Given AFN and its corresponding RAFN, let $T \subseteq \mathbf{A}$ and $x \in \mathbf{A}$.*

1. *If $x \in UnSupp(U_T)$ then x is deactivated by T in AFN.*
2. *If x is deactivated by T in AFN and $x \in \overline{Def_{\mathbf{A}}(U_T)}$ then $x \in UnSupp(U_T)$.*

Proof:

By definition, $UnSupp(U_T) = \overline{Supp(U'_T)}$ where $U'_T = (\overline{Def_{\mathbf{A}}(U_T)}, \mathbf{R}', \overline{Def'_{\mathbf{N}}(U_T)})$. As noted before, $Def'_{\mathbf{N}}(U_T) = \emptyset$. So, $U'_T = (\overline{Def_{\mathbf{A}}(U_T)}, \mathbf{R}', \mathbf{N}') = U'_T$ where T' denotes $\overline{Def_{\mathbf{A}}(U_T)}$. Note that T' contains the arguments that are not attacked by T .

1. We assume that $x \in UnSupp(U_T)$. By definition, $x \notin Supp(U'_T)$ (1). Assume that x is not deactivated by T in AFN . There exists $C \subseteq \mathbf{A}$ coherent subset containing x , such that T attacks no argument of C . It follows that $C \subseteq T'$. As C is coherent in AFN , due to Prop 1, we have that U_C is self-supporting. So, $C \subseteq Supp(U_C)$. Moreover, due to Lemma 1, we have $Supp(U_C) \subseteq Supp(U'_T)$. By transitivity, we obtain $C \subseteq Supp(U'_T)$. As C contains x , we conclude that $x \in Supp(U'_T)$ which is in contradiction with the assumption (1).
2. We assume that x is deactivated by T in AFN and $x \in \overline{Def_{\mathbf{A}}(U_T)} = T'$. Assume that $x \notin UnSupp(U_T)$. Then $x \in Supp(U'_T)$. From Lemma 4, $\exists C \subseteq T'$ such that $x \in C$ and C is coherent in AFN . So C is a coherent set containing x such that T attacks no argument of C . That is in contradiction with x being deactivated by T .

□

Proof of Prop. 1: Let $T \subseteq \mathbf{A}$.

1.
 - Let $a \in T$. Let us assume that T is support-closed in AFN . By definition, a is support-cycle-free in T iff $\forall E \subseteq \mathbf{A}$ such that ENa , there is $b \in E \cap T$ such that b is support-cycle-free in $T \setminus \{a\}$. $a \in Supp(U_T)$ means $\forall \alpha \in \mathbf{N}'$ such that $t'(\alpha) = x$, $s'(\alpha) \cap (T \cap Supp(U_{T \setminus \{x\}})) \neq \emptyset$ or equivalently, $\forall \alpha \in \mathbf{N}'$ such that $t'(\alpha) = x$, there is $b \in s'(\alpha) \cap T$ such that $b \in Supp(U_{T \setminus \{x\}})$. So the proof just follows by induction.
 - Assume that U_T is self-supporting. Then $T \subseteq Supp(U_T)$. It follows that T is support-closed in AFN . Then, due to the first part of the proof, every $a \in T$ is support-cycle-free in T . As T is support-closed, it follows that T is coherent. Conversely, assume that T is coherent, so that every $a \in T$ is support-cycle-free in T . From the first part of the proof, it follows that $T \subseteq Supp(U_T)$. As \mathbf{R}' and \mathbf{N}' are included in \mathbf{P}' , it follows that U_T is self-supporting.
2. Let $a \in \mathbf{A}$.
 - a is acceptable w.r.t. T in AFN means that $T \cup \{a\}$ is coherent and $\forall b \in \mathbf{A}$ such that bRa , b is deactivated by T . If $T \cup \{a\}$ is coherent, from Prop 1.1 and Lemma 3, it is easy to prove that $a \in Supp(U_T)$ (i). Let $\alpha \in \mathbf{R}'$ with $t'(\alpha) = a$. By definition of $RAFN$, there is $b \in \mathbf{A}$ such that $s'(\alpha) = \{b\}$ and bRa . As a is acceptable w.r.t. T in AFN , b is deactivated by T . Due to Lemma 5, it follows that either $b \in Def_{\mathbf{A}}(U_T)$ or $b \in UnSupp(U_T)$, or equivalently either $s'(\alpha) \subseteq Def_{\mathbf{A}}(U_T)$ or $s'(\alpha) \subseteq UnSupp(U_T)$. In both cases, $\alpha \in UnAct(U_T)$ (ii). So we have proved that a is acceptable w.r.t. U_T in $RAFN$.
 - Let us assume that T is self-supporting. a is acceptable w.r.t. U_T in $RAFN$ means that $a \in Supp(U_T)$ and for each attack $\alpha \in \mathbf{R}'$ with $t'(\alpha) = a$, $\alpha \in UnAct(U)$. As attacks are neither attacked nor supported in $RAFN$, $\alpha \in UnAct(U)$ means $s'(\alpha) \subseteq UnAcc(U_T) = (Def_{\mathbf{A}}(U_T) \cup UnSupp(U_T))$. As T is self-supporting, and $a \in Supp(U_T)$, due to Lemma 1, it is easy to prove that $T \cup \{a\}$ is also self-supporting and from Prop 1.1 it follows that $T \cup \{a\}$ is coherent

(i).

Let $b \in \mathbf{A}$ such that $b\mathbf{R}a$. By definition of *RAF*N, there is $\alpha \in \mathbf{R}'$ such that $s'(\alpha) = \{b\}$ and $t'(\alpha) = a$. As a is acceptable w.r.t. U_T in *RAF*N, we have that $b \in \text{UnAcc}(U_T) = (\text{Def}_{\mathbf{A}}(U_T) \cup \text{UnSupp}(U_T))$. We have two cases:

- If $b \in \text{UnSupp}(U_T)$, from Lemma 5, we conclude that b is deactivated by T in *AF*N.
- If $b \in \text{Def}_{\mathbf{A}}(U_T)$, there is $c \in T$ such that $c\mathbf{R}b$ in *AF*N. This is a particular case when b is deactivated by T . Indeed, if T attacks b , T attacks any coherent set containing b .

In both cases, b is deactivated by T (ii).

So we have proved that a is acceptable w.r.t. T in *AF*N.

□

Proof of Prop. 2: Let $T \subseteq \mathbf{A}$.

1. *Admissible semantics*

- Assume that T is an admissible extension of *AF*N. By definition, T is conflict-free, coherent, and each argument of T is acceptable w.r.t. T . From Lemma 2, U_T is a conflict-free structure of *RAF*N. From Prop 1, each argument of T is acceptable w.r.t. U_T in *RAF*N. It is also the case for the other elements of the structure, as they are neither attacked nor supported. So, U_T is an admissible structure in *RAF*N.
- Assume that U_T is an admissible structure in *RAF*N. By definition, U_T is conflict-free and each argument of U_T is acceptable w.r.t. U_T in *RAF*N. From Lemma 2, T is a conflict-free in *AF*N. As U_T is an admissible structure, it is self-supporting, so from Prop 1, we have that T is coherent. Lastly, from Prop 1, we have that each argument of T is acceptable w.r.t. T . So T is an admissible extension of *AF*N.

2. *Complete semantics*

The result follows from the definitions and Prop 1.

3. *Preferred semantics*

In *RAF*N, U_T is a preferred structure iff it is a \subseteq -maximal complete structure. In *AF*N, T is a preferred extension iff T is a \subseteq -maximal complete extension.

Assume that U_T is a preferred structure. Then, from the second item of Prop. 2, T is complete. If T is not \subseteq -maximal complete, there is T' \subseteq -maximal complete extension strictly containing T . Then, we know that $U_{T'}$ is complete and obviously $U_{T'}$ strictly contains U_T . That is in contradiction with U_T being preferred. So T is a preferred extension.

Conversely, assume that T is a preferred structure in *AF*N. Then, from the second item of Prop. 2, U_T is complete. If U_T is not \subseteq -maximal complete, there is a complete structure U' that strictly contains U_T . As U_T has the form $(T, \mathbf{R}', \mathbf{N}')$, it follows that U' has the form $(T', \mathbf{R}', \mathbf{N}')$ with T' strictly containing T . As U' is complete, we have that T' is complete, which is in contradiction with T being preferred. So U_T is a preferred structure.

4. *Stable semantics*

In *AF*N, T is a stable extension iff T is complete and $\forall a \in \mathbf{A}, a \in \mathbf{A} \setminus T$ iff a is deactivated by T . In *RAF*N, U_T is a stable structure iff U_T is complete and $\overline{(T \cup \mathbf{R}' \cup \mathbf{N}')} = \text{UnAcc}(U_T)$. From the second item of Prop. 2, we know that T is complete in *AF*N iff U_T is a complete structure of *RAF*N. Moreover, $\text{UnAcc}(U_T) = (\text{Def}_{\mathbf{A}}(U_T) \cup \text{UnSupp}(U_T))$ so $\text{UnAcc}(U_T) \subseteq \mathbf{A}$ (indeed, as each interaction belongs to \mathbf{P}' , $\text{UnSupp}(U_T) \cap (\mathbf{R}' \cup \mathbf{N}') = \emptyset$). And as said above in the proof of Prop 1, each argument in $\text{Def}_{\mathbf{A}}(U_T)$ is deactivated by T , so from Lemma 5, we have that $x \in \text{UnAcc}(U_T)$ iff x is deactivated by T . It follows that $\forall a \in \mathbf{A}, (a \in \mathbf{A} \setminus T \text{ iff } a \text{ is deactivated by } T)$ is equivalent to $(a \in \overline{(T \cup \mathbf{R}' \cup \mathbf{N}')} \text{ iff } a \in \text{UnAcc}(U_T))$, in other words, T is a stable extension of *AF*N iff U_T is a stable structure in *RAF*N.

5. *Grounded semantics*

In *AFN*, T is a grounded extension iff T is a \subseteq -minimal complete extension. In *RAFN*, U_T is a grounded structure iff U_T is a \subseteq -minimal complete structure.

Assume that T is a grounded extension. From the second item of Prop. 2, we know that U_T is complete. If U_T is not a \subseteq -minimal complete structure, there is a complete structure $U' = (T', \Gamma', \Delta')$ such that $T' \cup \Gamma' \cup \Delta'$ is strictly included in $T \cup \mathbf{R}' \cup \mathbf{N}'$. As U' is complete, we have $U' = \text{Acc}(U')$. As $(\mathbf{R}' \cup \mathbf{N}') \subseteq \mathbf{P}'$, and as no interaction is attacked, we have $(\mathbf{R}' \cup \mathbf{N}') \subseteq \text{Acc}(U')$, so $(\mathbf{R}' \cup \mathbf{N}') \subseteq U'$. Hence $U' = U_{T'}$ where $T' \subset T$. As U' is complete, we know that T' is complete in *AFN*. So we have T' a complete extension of *AFN* strictly included in T \subseteq -minimal complete extension. There is a contradiction. So, we have proved that U_T is a grounded structure.

Conversely, assume that U_T is a grounded structure. From the second item of Prop. 2, we know that T is a complete extension. If T is not a \subseteq -minimal complete extension, there is a complete extension T' such that $T' \subset T$. As T' is complete we have that $U_{T'}$ is a complete structure. Obviously we have $U_{T'} \subset U_T$, which is in contradiction with U_T being a \subseteq -minimal complete structure. So we have proved that T is a grounded extension.

□