



HAL
open science

Ambient Light Contribution as a Reference for Motion Artefacts Reduction in Photoplethysmography

Nicolas de Pinho Ferreira, Claudine Gehin, Bertrand Massot

► **To cite this version:**

Nicolas de Pinho Ferreira, Claudine Gehin, Bertrand Massot. Ambient Light Contribution as a Reference for Motion Artefacts Reduction in Photoplethysmography. 13th International Conference on Biomedical Electronics and Devices, Feb 2020, Valletta, Malta. pp.23-32, 10.5220/0008878800230032 . hal-02882018

HAL Id: hal-02882018



<https://hal.science/hal-02882018>

Submitted on 26 Jun 2020

HAL is a multi-disciplinary open access archive for the deposit and dissemination of scientific research documents, whether they are published or not. The documents may come from teaching and research institutions in France or abroad, or from public or private research centers.

L'archive ouverte pluridisciplinaire **HAL**, est destinée au dépôt et à la diffusion de documents scientifiques de niveau recherche, publiés ou non, émanant des établissements d'enseignement et de recherche français ou étrangers, des laboratoires publics ou privés.

Ambient light contribution as a reference for motion artefacts reduction in photoplethysmography

Nicolas DE PINHO FERREIRA¹^a, Claudine GEHIN¹^b and Bertrand MASSOT¹^c

¹*INL, CNRS UMR5270, INSA Lyon, Univ. Lyon, Villeurbanne, France
nicolas.de-pinho-ferreira@insa-lyon.fr*

Keywords: heart rate, photoplethysmography, motion artefacts, ambient light, adaptive filtering.

Abstract: Measuring the heart rate from a convenient location such as the wrist is commonly achieved using photoplethysmography. As a consequence, this method is widely used on commercial wearable devices. Unfortunately, it also highly suffers from motion artefacts superimposed into the cardiac frequency band which generally lead to incorrect heart rate estimation. In this paper we propose a new approach that uses the ambient light contribution as a reference for motion artefacts reduction. Contrarily to accelerometer-based techniques, the proposed method does not require any additional hardware. Moreover, it is especially efficient for reduction of micro-motions that can't be addressed using conventionally used accelerometry. Using the ambient light signal as a reference in association with adaptive filtering has demonstrated promising results for the reduction of artefacts during both periodic and random motion events.

1 INTRODUCTION

The most commonly used technique for heart rate (HR) measurement with wearable devices is the photoplethysmography (PPG). This non-invasive and low-cost technique enables measurement from convenient locations such as wrist, finger or earlobe. Basically, a photoplethysmographic measurement system is comprised of two opto-electronic elements, a photoemitter, usually a light-emitting diode (LED), and a photodetector, usually a photodiode (PD). As measurement front ends are readily available off-the-shelf in tiny integrated circuits, it can be integrated in small form factor devices and thus, used for ambulatory measurements.

The measurement principle of PPG is based on the detection of volume change (plethysmography) caused by cardiac activity. In this particular configuration, changes are evaluated by an optical technique. In regard to cardiac activity, during diastole, blood is ejected through the aortic valve in the circulatory system which causes a local increase of volume in elastic arteries, muscular arteries and arterioles. When this volume increases, the local absorption coefficient is augmented and consequently the

variation can be measured, according to the Beer-Lambert Law (Hu et al., 2013). Depending on the relative position between the LED and the PD, a photoplethysmographic acquisition system can be used in reflection-mode or transmission-mode. When both optical elements are placed on the same surface and applied onto the measurement site (for example, upon the wrist), this is called reflection-mode. On the contrary, in the transmission-mode, optical elements are placed from either side of the measurement site (for example, across the finger).

When using photoplethysmography for heart rate acquisition, motion artefacts are one of the main issues to be addressed, particularly in ambulatory conditions. As long as the user stays still and thus no motion is induced at the measurement site, photoplethysmographic signal frequency is representative of cardiac activity and heart rate (Jan et al., 2019). However when the user starts a physical activity such as walking, running or any other activity that can imply motion on the measurement site, this will induce unwanted noise on the PPG signal. Unfortunately, this noise has a spectral content which overlaps with cardiac band and thus, can't be removed using conventional linear filtering techniques.

A common way of addressing this issue is to use an auxiliary reference signal that contains correlated information on motions that occur on the measurement site. This reference signal can then be used with

^a <https://orcid.org/0000-0001-8462-6008>

^b <https://orcid.org/0000-0002-5399-119X>

^c <https://orcid.org/0000-0001-8489-888X>

a signal processing technique such as adaptive filtering. In the literature, accelerometry is a commonly used reference signal as it contains motion-correlated information (Lee et al., 2010). Other proposed techniques use dual wavelength PPG, where one channel is used as reference (Zhang et al., 2019). In conventional PPG acquisition systems, ambient light is removed from PPG signal as it represents a noise source and could lead to wrong physiological parameters evaluation. In this work, we attempted to use the contribution of this ambient light received directly by the PPG sensor, as a reference signal for adaptive filtering.

The paper is organised as follow : in section 2, hardware developed for ambient light acquisition by PPG sensor is described. Then in section 3, signals acquired and their content are analysed; the high degree of correlation obtained during motion artefacts events is discussed. After demonstrating the interest of ambient light for motion artefacts reduction, we propose a signal processing toolchain developed with MATLAB (The MathWorks, Massachusetts, US) in section 4. This toolchain is used for addressing both periodic and random motion artefacts.

2 MEASUREMENT SETUP

2.1 Hardware

Photoplethysmographic acquisitions were made using a MAX86140EVSYS (Maxim Integrated, California, US) evaluation kit and a custom designed optical board. The original microcontroller board from the evaluation kit and the custom designed optical board were both linked with a flexible cable, allowing for convenient placement of optical elements. PPG acquisition relies on a MAX86141 (Maxim Integrated, California, US) Analog Front End (AFE) in association with SFH 2201 wide-band photo-diodes and LT P4SG-V1AB-36 528 nm LEDs. During all measurements, the system was battery powered for a maximum freedom of movement. The overall architecture of the system is presented on Fig. 1.

In addition to classic PPG measurements, the optical board featured a 3-axis accelerometer whose data were simultaneously recorded. Acquired measurements can be directly stored in an embedded flash memory or sent wirelessly in real-time via a Bluetooth radio-frequency communication. All recordings presented in this paper were made on the left wrist, and the optical board was placed on the bottom side of the wrist while the microcontroller board was on the upper side.

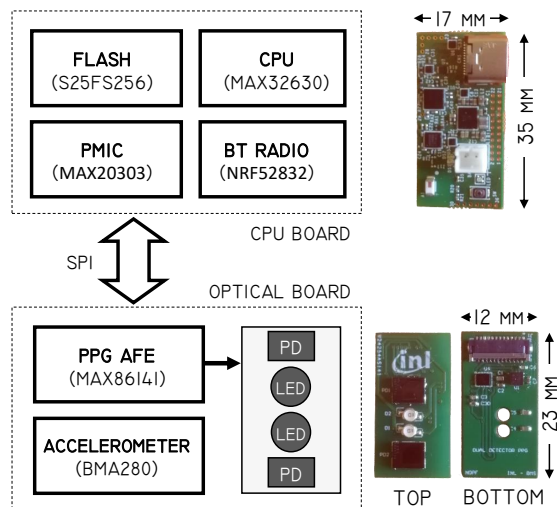

Figure 1: Acquisition system architecture.

2.2 Ambient light

When normally used, the MAX86141 PPG AFE automatically removes the ambient light contribution on acquired samples. The acquisition timings of the circuit are represented on Fig. 2. As a first step, both LEDs are driven on, and after a short settling time, a sample from the photodiode is acquired and integrated during the time T_{INT} . Then, LEDs are turned off and a new sample representative of the ambient light is acquired from the photodiode. This process is repeated periodically every T_{SAMP} . The value stored during the ambient exposure phase is then used to remove contribution of ambient light. Depending on the analog front end used, different Ambient Light Cancellation (ALC) strategies exist. For example, the stored value can be used to drive an analog circuitry that will sink current corresponding to ambient exposure. Ideally, in this configuration, the digitized value is free of ambient light contribution. This method has the advantage of preventing saturation of transimpedance amplifier and analog-to-digital converters. In a digital approach, the measured ambient sample value can be subtracted from the LED exposure sample.

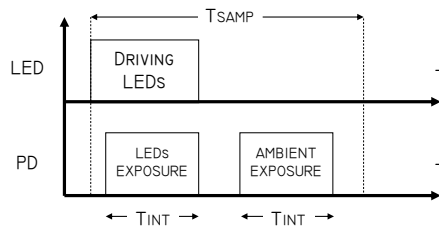

Figure 2: PPG AFE Acquisition Timing.

While internal ambient light cancellation is enabled, the PPG AFE can be configured to retrieve the ambient light value measured. For this purpose, the PPG front end configuration was modified and both ambient light and PPG exposure were recorded. This technique does not require any additional hardware from a conventional PPG setup. However, as the MAX86141 can be used with two photo-diodes, this feature could be used in our case to increase robustness of developed motion artefact reduction technique as discussed in section 3.

3 ACQUIRED SIGNALS

3.1 First approach

In a first approach, both ambient and PPG signals were recorded while doing multiple, periodic and wide amplitude motions such as arm shaking; as well as lower amplitude movements such as hand waving and opening/closing. Plots on Fig. 3 are unprocessed data coming from the evaluation kit. Only signal normalisation has been applied on PPG and ambient light recordings. For all measurements presented in this paper, internal ALC system of MAX86141 was enabled.

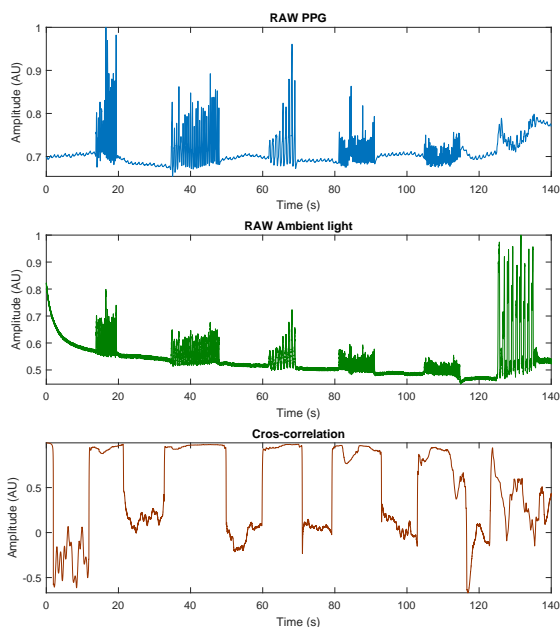

Figure 3: PPG and ambient recording during motion events.

A clear matching between PPG and ambient light recordings during motion events can be observed. Additionally, windowed cross-correlation bears out

the visual similarity between both waveforms during motion events. The window size is 512 points, which represents a duration of 4 seconds, for a 128 Hz sampling frequency.

This high degree of similarity can be explained as follows: when motion occurs, the relative distance between user’s skin and optical elements is modified, which implies a variation of the ambient light amount received by the photo-detector. As the induced motion is periodic, the fine variation in amount of light received follows a periodic pattern.

However, as shown on Fig. 3, ambient light can also contain noise. Even if no motion occurs, the ambient light signal is still comprised of a low amplitude high frequency noise. This noise can come from sources such as fluorescent light, flickering or fast ambient variation and should also be removed before signal processing.

In addition, when wide amplitude motion occurs (like arm shaking at the end of this dataset), cross-correlation does not show an agreement as high as during smaller amplitude motions. In this particular situation, the amount of ambient light measured onto the photodiode does not only represent a contact modification between optical elements and wrist, but is also representative of real ambient light variations.

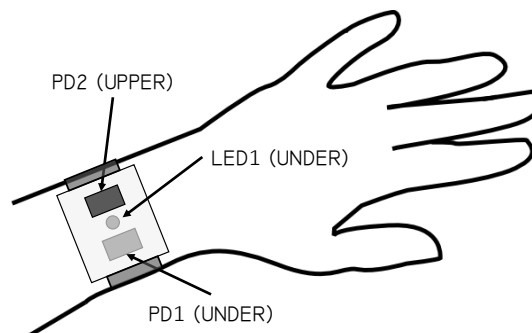

Figure 4: Possible concept for handling wide MA.

A possible approach to overcome this issue would be to use an auxiliary photodiode, mounted on the upper side of the device (PD2) as described on Fig. 4. This would allow to remove the *real* ambient contribution detected by the first photodiode (PD1). Another approach would be to choose dynamically between ambient or accelerometry signals as a reference for motion artefact reduction depending on the type of movements detected using the accelerometer.

3.2 Micro-motions

For specific events such as micro-motions, the ambient light signal features a clear periodic component,

contrarily to conventionally used accelerometry. As it can be seen on Fig. 5, small hand motions (fingers waving in that case) cause significant noise on PPG signal. Meanwhile, in this configuration, the wrist is standing still and an accelerometer is not able to detect this motion onto the measurement site, as the acceleration recorded along all the three axes does not show any clear periodic component.

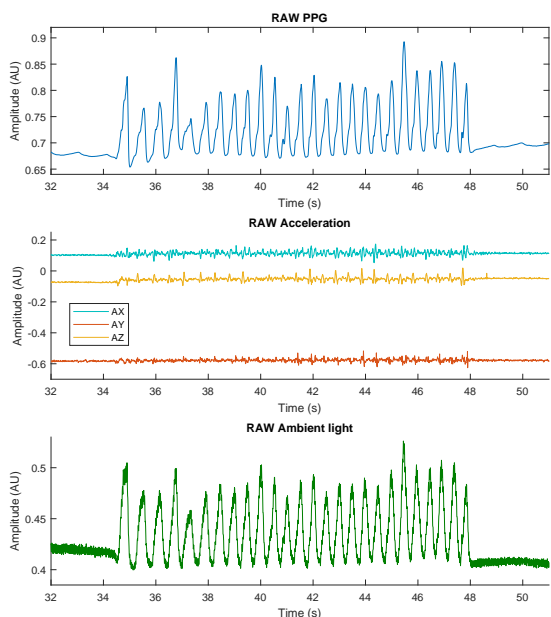

Figure 5: PPG, accelerometry and ambient light

On the particular signal window represented on Fig. 5, the highest cross-correlation coefficient was obtained between PPG recording and ambient light (A_L) with a value of 0.9641, rather than with the acceleration magnitude (A_N) which led to a value of 0.2687 (the highest cross-correlation value was found along the x-axis : $A_X = 0.1801$, $A_Y = -0.2029$, $A_Z = -0.0700$).

3.3 Analysis

To identify what type of motion is most likely to be removed by ambient light or by any another reference signal, we used cross correlation and mutual information as indicators of similarity (Tautan et al., 2015). For this purpose, we used MATLAB (The MathWorks, Massachusetts, US) in addition with a specific toolbox for mutual information computation (Brown et al., 2012). Preliminary results for this in-vivo experiment were obtained from six healthy voluntary subjects (2 female, 4 male) whose written consent was obtained. The age of the participants was 36 years old \pm 11. Subjects were told to successively perform each type of motion during 10 s each, sepa-

rated with 10 s of rest. The following situations were considered :

1. Hand / fist opening and closing
2. Finger tapping on table
3. Moving forearm from elbow up and down
4. Moving forearm from elbow right and left
5. Moving fingers in a waving fashion
6. Motionless, in a resting situation

The cross-correlation coefficient values obtained between PPG recording and reference signals for each situation listed are shown on Fig. 6. The results for mutual information are shown on Fig. 7.

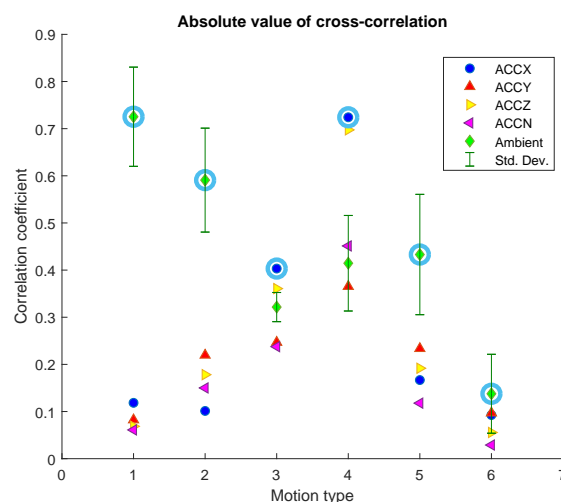

Figure 6: Cross correlation between PPG and references.

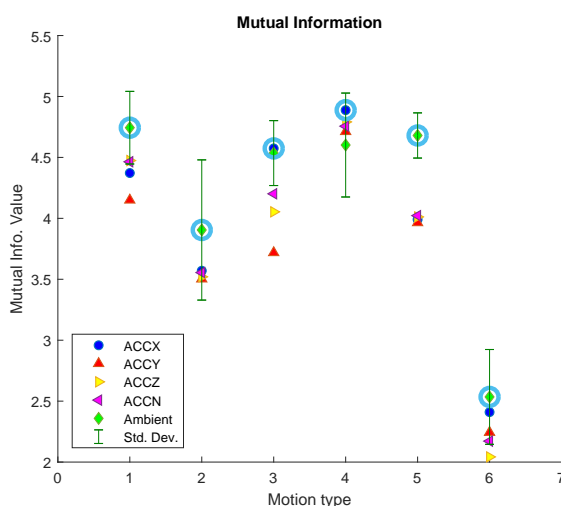

Figure 7: Mutual Information between PPG and references.

In most situations, ambient light (AL) reference signal features the highest degree of correlation and

mutual information. Moreover, ambient light provides far better results for MA reduction during situations where micro-motions occur which can not be detected using the accelerometer. On the other hand, when wide amplitude motions occur, the accelerometer signals contain a clear periodic component whereas ambient light reference suffers from real exposure modifications. In this configuration, the ambient light reference does not only contain motion-correlated information but also *real* ambient light correlated information. As a consequence, this situation could reduce the performances of an adaptive filter if using ambient light information only. In case of a combination of micro-motions described previously, which is a much more realistic situation than stationary and periodic motions, ambient light still indicates a higher degree of correlation and mutual information than accelerometry. For signal processing in section 4, we will focus on micro-motions that feature a high degree of correlation and that can't be addressed using conventional accelerometry.

Another parameter that influences degree of correlation and mutual information between ambient and PPG is time delay. As a function of the considered motion, a time delay exists between the moment where motion artefact occurs on the reference signal and the resulting alteration of PPG signals (Gibbs and Asada, 2005). However for evaluation of correlation and mutual information, there was no additional time delay introduced.

4 SIGNAL PROCESSING

4.1 Requirements

In order to extract physiological parameters such as Heart Rate (HR) or Peripheral Oxygen Saturation (SPO_2) from PPG signals whose integrity is compromised by motion artefacts, several signal processing techniques were proposed in prior art. These techniques can be classified as follows :

- Time domain methods, which use Least Mean Square (LMS) (Ram et al., 2012) or Recursive Least Squares (RLS) adaptive filters;
- Frequency domain methods, such as Spectral Subtraction (SS) (Islam et al., 2019);
- Hybrid methods that feature a time-frequency approach such as Ensemble Empirical Mode Decomposition (EEMD) and adaptive filtering (Khan et al., 2016).

Contrary to multi-spectral techniques, the proposed reference signal in this work (ambient light)

does not contain any cardiac component. Consequently, it does not require any high computing cost algorithm such as Continuous Wavelet Transform (CWT) spectrum subtraction (Zhang et al., 2019). In this section, we demonstrate the ability of ambient light to reduce motion artefacts using both frequency and time domain methods.

4.2 Frequency domain

In a first approach, the spectral content of both ambient light and PPG recording during motion events are analysed. All signals are band-pass filtered from 0.5 to 10 Hz using a 4th order FIR, to remove high frequency noise present on ambient signal. On the PPG signal, this removes the DC component and limits contribution of noise outside of cardiac frequency range. Once the signal is filtered, Discrete Fourier Transform (DFT) is computed to obtain the power spectrum as shown on Fig. 8.

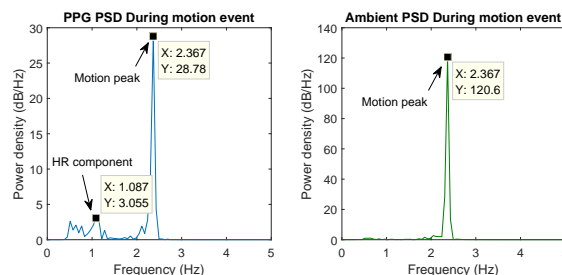

Figure 8: PPG and ambient spectral content during motion.

Although PPG spectrum contains HR related information with a small peak around 1.087 Hz (65 BPM), most of the power is located on the 2.367 Hz peak, corresponding to the elicited motion artefact (MA). A high power peak at same frequency is shown on ambient light spectrum. If we consider motion artefacts superimposed onto PPG spectrum as an additive noise and a stationary process, we can use Spectral Subtraction (Vaseghi, 2001). As a proof of concept, both power spectrum were normalised and ambient contribution subtracted from PPG.

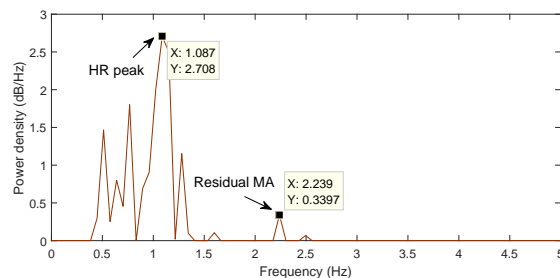

Figure 9: Resulting spectral subtraction.

This approach led to the power spectrum shown on Fig. 9. The cardiac component peak is now clearly visible. By applying an Inverse Discrete Fourier Transform (IDFT), resulting time domain waveform can be evaluated, see Fig. 10.

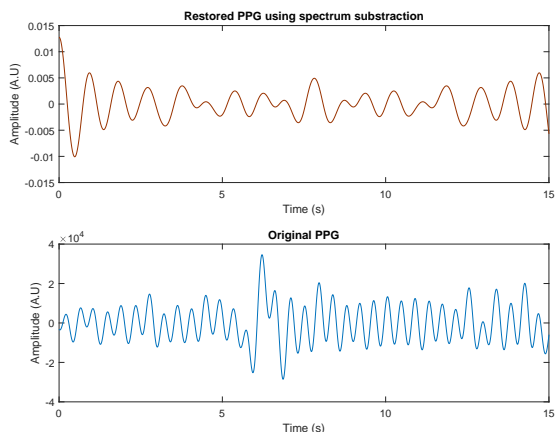

Figure 10: Time-domain PPG before and after spectral subtraction.

Although this technique has a relative low computing-cost, it requires a stationary noise over the considered window. In this particular case, window was hand-selected, but in practice this might not be suitable for online noise cancellation.

4.3 Adaptive filtering

A possible signal processing approach for motion artefact reduction is the use of adaptive filtering, whose principle is represented on Fig. 11.

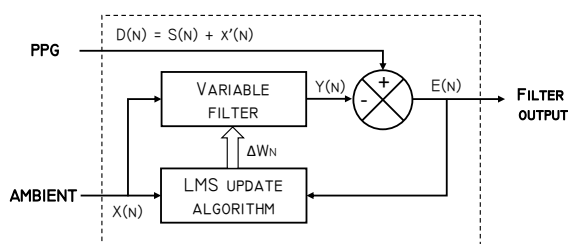

Figure 11: LMS Adaptive filter content.

This type of filter is widely used for noise reduction when an additional noise reference correlated with the original signal that has to be de-noised is available. It is based on a stochastic gradient descent: the general idea is to design an ideal filter whose coefficients are iteratively computed using an optimisation algorithm. The Least Mean Squares (LMS) algorithm applied here uses a reference input, $X(n)$, as an

additional information source on noise contained in $D(n)$. For efficient coefficient optimisation and thus filtering, signal $D(n)$ has to be correlated with noise contained in $X(n)$. As discussed in section 3.3, the ambient light signal features a high degree of correlation with PPG during MA events. Consequently, a simple and low computing-cost LMS adaptive filter should be able to produce an error output $E(n)$ with reduced motion artefacts.

To verify this statement, a signal processing chain which implements all the required steps has been developed in MATLAB (The MathWorks, Massachusetts, US). The architecture is described on Fig. 12.

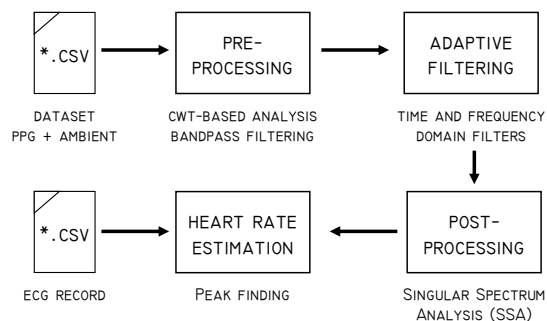

Figure 12: Signal processing toolchain architecture.

Ambient light and PPG recordings extracted from the wrist-worn device are directly imported in MATLAB. As a pre-processing step, both PPG and ambient are band-pass filtered from 0.5 to 10 Hz using 4th order FIR in order to remove noise outside of the cardiac band, thus ensuring that both reference and PPG share the same spectral limits. In this same step and for signal analysis in time-frequency domain, a continuous wavelet transform (CWT) is used to analyse the spectrogram. This CWT technique features a higher resolution in both domain in comparison with Short Time Fourier Transform (STFT). Next, during the adaptive filtering step, a time-domain LMS filter is used for motion artefact reduction. Finally, filtered signal is post-processed using Singular Spectrum Analysis (SSA) to remove residual discontinuities. The filtered output spectral content is also analysed using CWT and compared with the previous spectrogram obtained during pre-processing. Heart rate estimation is performed in time domain method by finding peaks on the SSA-denoised PPG signal. For validation purpose, a simultaneous electrocardiogram (ECG) recording is used as the gold standard method.

4.3.1 Periodic motion

The first dataset used for evaluating the performance of the adaptive the LMS filter is a 80 s recording comprised of periodic hand motion (opening and closing). Apart from motion events, the PPG spectrogram on Fig. 13 features a clear cardiac component with a 2nd harmonic corresponding to the dicrotic notch. When no motion is induced, the spectrogram maximum energy, plotted in red, follows the resting HR of user of 69.36 BPM.

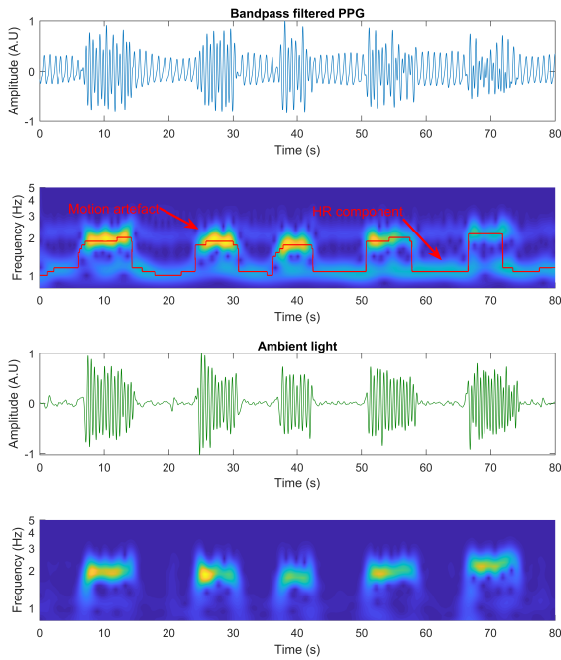

Figure 13: Pre-processed PPG and ambient signals.

During motion artefacts (MA) events, the maximum spectrogram energy is located at the frequency of the artefact (1.87 Hz). Although the cardiac component is no longer dominant, it can however still be detectable on the spectrogram. Performing heart rate evaluation on this simple band-pass filtered PPG signal would lead to incorrect estimation. The spectrogram obtained by CWT confirms that ambient light features a clear matching with PPG in frequency domain during motion artefacts.

The output obtained from the adaptive filter is shown on Fig. 14. Despite its simplicity (in comparison with others structures such as X-LMS, RLS or variable step-size LMS), this filter is able to reject motion artefact. On this dataset, a filter comprised of $L = 32$ taps is used. Step size parameter $\mu = 0.006$ that controls convergence speed and stability is manually tuned for best trade-off between convergence and filter response. Smaller values of μ tend to reduce

convergence speed while larger values lead to important misadjustment.

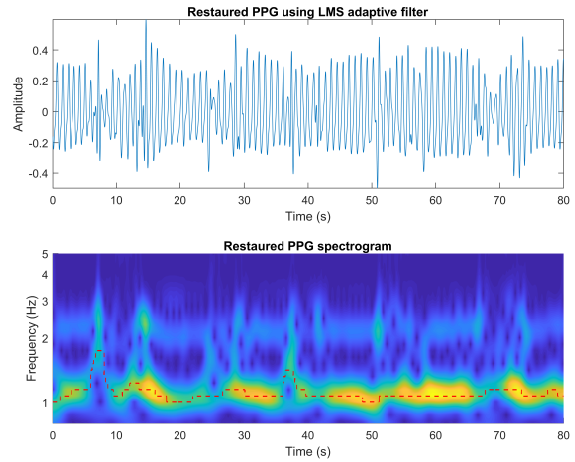

Figure 14: Restored PPG recording using LMS filter.

The maximum spectrogram energy, plotted in dashed lines on Fig. 14 is representative of PPG signal fundamental frequency. However, using this information directly for estimating heart rate could lead to incorrect estimations. In order to reduce discontinuities and high frequency noise locally present on the filtered PPG waveform, Singular Spectrum Analysis (SSA) is used. The aim of this method is to decompose the signal into principal components, each of these extracted time series representing a trend of the original signal : oscillatory mode, noise or periodic pattern (Golyandina et al., 2001). The decomposition is operated in MATLAB : a covariance matrix is computed using Toeplitz approach, and once eigenvalues and eigenvectors are extracted from the covariance matrix, principal components (PC) are obtained by performing matrix product between embedded timeseries (windowed version of PPG signal) and eigenvectors. The de-noised version of PPG is obtained by re-summing the two first PCs only, and the result of this operation is shown on Fig. 15 with a simultaneous ECG recording plotted altogether.

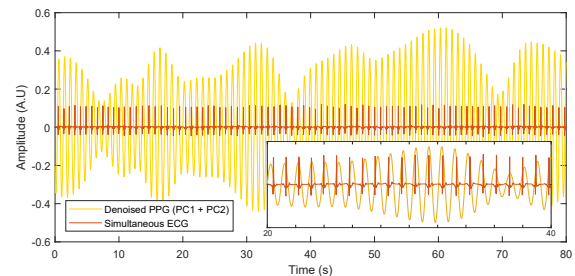

Figure 15: De-noised PPG and simultaneous ECG record.

An instantaneous heart rate detection is performed

on this waveform using a peak-finding method (a zero-crossing detection method could also be used for this purpose), and the time difference between successive peaks is then calculated. This method is particularly efficient on denoised PPG signal as its amplitude remains relatively constant with time. On the contrary, operating this peak detection directly onto the LMS adaptive filter output could have been more complex as it should have used a time-varying threshold for maintaining a correct detection.

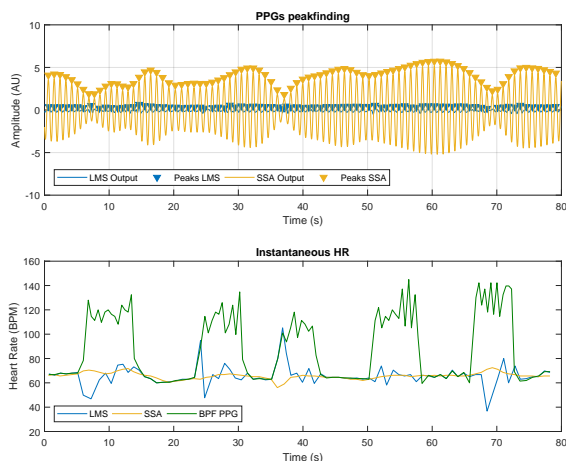

Figure 16: Instantaneous heart rate evaluation.

Instantaneous HR for bandpass filtered PPG, LMS filter output and SSA denoised PPG are plotted on Fig. 16. As expected, the denoised PPG shows a slowly time-varying heart rate devoid of fast transients which are still present on the adaptive filter output. However, as SSA acts as a smoother in case of missing pulses on the LMS processed PPG, it could potentially act as a low-pass filter and thus compromise the evaluation of instantaneous HR. In this situation, the calculation of parameters such as Heart Rate Variability (HRV), which is a relevant indicator for assessing cardiovascular system state, could be erroneous. In order to evaluate the performances of the proposed processing toolchain, the instantaneous heart rate has also been extracted from a simultaneous ECG (Fig. 17).

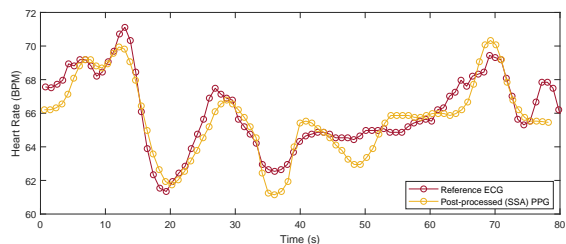

Figure 17: Comparison with simultaneous ECG recording.

Instantaneous ground truth heart rate was extracted from ECG using a simple peak detection to detect the R-waves. Over this particular dataset, this method didn't show any significant difference with Pan and Tompkins detection method. Then, inter-beats intervals from both processed PPG and ECG were uniformly re-sampled. As discussed in prior art, pulse rate variability (PRV) of PPG is representative of HRV in resting conditions (Gil et al., 2010). However, in ambulatory conditions where motion occurs, correlation between PPG PRV and ECG beat-to-beat intervals is reduced and depends on measurement site (Maeda et al., 2011). Consequently, ground truth HR and estimated HR from processed PPG are compared in an 'average level', instead of pure beat-to-beat cycle. Both tachograms were smoothed using a moving average filter over 4 points. Even during motion events, heart rate follows the trend of ECG reference, making ambient light and associated processing technique a suitable candidate for assessing HR and derived indicators in an ambulatory use. The associated Bland Altman diagram and scatter plot between gold standard ECG and processed PPG shows good performance and the limits of agreement are +1.4 / -2.0 BPM. On this particular dataset, Pearson's coefficient is $R = 0.85$.

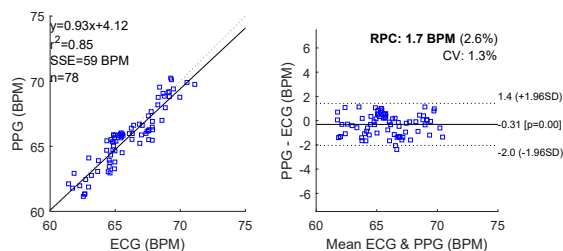

Figure 18: Bland Altman diagram between ECG and PPG.

4.3.2 Random motions

Rather than periodic movements, a more realistic situation of motion artefacts can be evaluated by inducing micro-motions occurring in a random fashion during keyboard typing. In this situation, even if the wrist is standing quite still, typing will cause fingers tendons to move, thus resulting in a modification of the optical contact and superimposition of motion artefacts.

However, in this situation, the considered noise is no longer a stationary process and cannot be modelled by a Gaussian distribution law, which is a fundamental hypothesis for the use of adaptive filters (Belge and Miller, 2000). To overcome this limitation, a variant of Recursive Least Squares (RLS) algorithm, known as generalised sliding windows RLS (Sayed,

2003), was applied. Other methods such as exponentially weighted RLS (W-RLS) are also suitable for this purpose. The main drawback of RLS adaptive algorithms is their higher computational cost compared with LMS which can affect autonomy of the system if used in a wearable device. A sliding window RLS adaptive filter was thus implemented in MATLAB, in place of the previously used LMS filter. Except from that, the signal processing toolchain remains unchanged. The considered dataset is comprised of PPG signal together with a simultaneous ECG recording over 120 s while keyboard typing (see fig. 19).

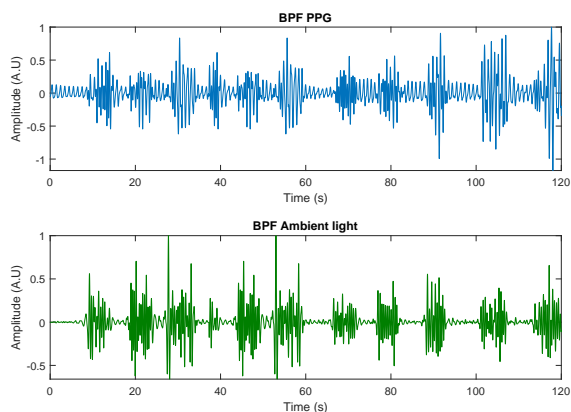

Figure 19: PPG and ambient light while typing.

The RMS adaptive filter used had a length of 4 weights and the sliding window size was 8 s. These parameters were chosen empirically to obtain the best possible results in terms of artefacts rejection. The spectrogram was used for this purpose as a direct visual indicator. The output of the adaptive filter was then smoothed using SSA as previously described, and peak detection was used for evaluating heart rate. The resulting signal in both time and frequency domain is shown on Fig. 20.

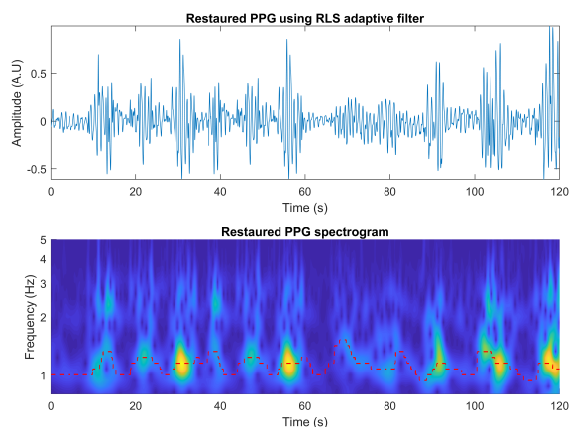

Figure 20: Sliding window RLS adaptive filter output.

Following the SSA denoising process, the instantaneous heart rate is estimated from time domain using peak finding. As previously described in section 4.3.1, ground truth heart rate (ECG) and PPG are uniformly re-sampled. Then, a moving average filter over 4 points is applied and the obtained HR is compared to the simultaneous ECG (see Fig. 21). Over this 120 s dataset, a Bland-Altman analysis shows a limit of agreement of 6.1 / -7.5 BPM with a bias of -0.7 BPM.

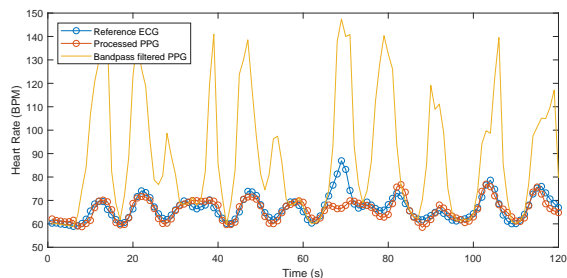

Figure 21: Heart rate during keyboard typing.

Time sections where motion artefacts are contaminating PPG can be localised using heart rate computed from band-pass filtered PPG. This makes clear illustration of continuous motion happening while keyboard typing. Regarding this result, even if the measured limit of agreement is higher, it must be kept in mind that the considered motion artefacts are no longer the consequence of a periodic activity, making signal processing more complex.

5 CONCLUSIONS

In this paper, we suggested the use of ambient light as a reference for the reduction of motion artefacts in PPG signals measured on the wrist. The relevance of this signal as a reference has been demonstrated on various motions types. Micro-motions, that could not be addressed previously using conventional accelerometry, are efficiently reduced using the ambient light reference. The signal processing toolchain has shown a promising ability to correct both periodic and random motions when compared to a simultaneous heart rate directly derived from the ECG. The proposed method is especially suitable for implementation in an embedded device as it does not require any additional hardware. Moreover, the ambient light reference can be used with low computational cost adaptive filters such as LMS.

Further investigation should be conducted on the existing time delay between reference and PPG as it could influence efficiency of motion artefacts rejection.

tion. Future work will be focused on the implementation of the proposed method in an autonomous wearable device with embedded signal processing capability. Although the proposed method is especially efficient for micro-motions, accelerometry remains useful in case of strong physical activity. A decision strategy for choosing optimal reference between ambient light and accelerometry will also be developed.

REFERENCES

- Belge, M. and Miller, E. (2000). A sliding window RLS-like adaptive algorithm for filtering alpha-stable noise. *IEEE Signal Processing Letters*, 7(4):86–89.
- Brown, G., Pocock, A., Zhao, M.-J., and Lujan, M. (2012). Conditional Likelihood Maximisation: A Unifying Framework for Information Theoretic Feature Selection. *The Journal of Machine Learning Research*, Volume 13, 3/1/2012:Pages 27–66.
- Gibbs, P. and Asada, H. (2005). Reducing motion artifact in wearable biosensors using mems accelerometers for active noise cancellation. In *Proceedings of the 2005, American Control Conference, 2005.*, pages 1581–1586, Portland, OR, USA. IEEE.
- Gil, E., Orini, M., Bailn, R., Vergara, J. M., Mainardi, L., and Laguna, P. (2010). Photoplethysmography pulse rate variability as a surrogate measurement of heart rate variability during non-stationary conditions. *Physiological Measurement*, 31(9):1271–1290.
- Golyandina, N., Nekrutkin, V. V., and Zhiglavski, A. A. (2001). *Analysis of time series structure: SSA and related techniques*. Number 90 in Monographs on statistics and applied probability. Chapman & Hall/CRC, Boca Raton, Fla.
- Hu, S., Azorin-Peris, V., and Zheng, J. (2013). Opto-Physiological Modeling Applied to Photoplethysmographic Cardiovascular Assessment. *Journal of Healthcare Engineering*, 4(4):505–528.
- Islam, M. T., Ahmed, S. T., Shahnaz, C., and Fattah, S. A. (2019). SPECMAR: Fast Heart Rate Estimation from PPG Signal using a Modified Spectral Subtraction Scheme with Composite Motion Artifacts Reference Generation. *Medical & Biological Engineering & Computing*, 57(3):689–702. arXiv: 1810.06196.
- Jan, H.-Y., Chen, M.-F., Fu, T.-C., Lin, W.-C., Tsai, C.-L., and Lin, K.-P. (2019). Evaluation of Coherence Between ECG and PPG Derived Parameters on Heart Rate Variability and Respiration in Healthy Volunteers With/Without Controlled Breathing. *Journal of Medical and Biological Engineering*.
- Khan, E., Al Hossain, F., Uddin, S. Z., Alam, S. K., and Hasan, M. K. (2016). A Robust Heart Rate Monitoring Scheme Using Photoplethysmographic Signals Corrupted by Intense Motion Artifacts. *IEEE Transactions on Biomedical Engineering*, 63(3):550–562.
- Lee, B., Han, J., Baek, H. J., Shin, J. H., Park, K. S., and Yi, W. J. (2010). Improved elimination of motion artifacts from a photoplethysmographic signal using a Kalman smoother with simultaneous accelerometry. *Physiological Measurement*, 31(12):1585–1603.
- Maeda, Y., Sekine, M., and Tamura, T. (2011). Relationship Between Measurement Site and Motion Artifacts in Wearable Reflected Photoplethysmography. *Journal of Medical Systems*, 35(5):969–976.
- Ram, M. R., Madhav, K. V., Krishna, E. H., Komalla, N. R., and Reddy, K. A. (2012). A Novel Approach for Motion Artifact Reduction in PPG Signals Based on AS-LMS Adaptive Filter. *IEEE Transactions on Instrumentation and Measurement*, 61(5):1445–1457.
- Sayed, A. H. (2003). *Fundamentals of adaptive filtering*. IEEE Press Wiley-Interscience, New York. OCLC: ocm52287219.
- Tautan, A.-M., Young, A., Wentink, E., and Wieringa, F. (2015). Characterization and reduction of motion artifacts in photoplethysmographic signals from a wrist-worn device. In *2015 37th Annual International Conference of the IEEE Engineering in Medicine and Biology Society (EMBC)*, pages 6146–6149, Milan. IEEE.
- Vaseghi, S. V. (2001). *Advanced digital signal processing and noise reduction*. Wiley, Chichester. OCLC: 937216619.
- Zhang, Y., Song, S., Vullings, R., Biswas, D., Simes-Capela, N., van Helleputte, N., van Hoof, C., and Groenendaal, W. (2019). Motion Artifact Reduction for Wrist-Worn Photoplethysmograph Sensors Based on Different Wavelengths. *Sensors*, 19(3):673.