



**HAL**  
open science

## Intuitionistic linear temporal logics

Philippe Balbiani, Joseph Boudou, Martin Dieguez, David Fernández Duque

► **To cite this version:**

Philippe Balbiani, Joseph Boudou, Martin Dieguez, David Fernández Duque. Intuitionistic linear temporal logics. *ACM Transactions on Computational Logic*, 2019, 21 (2), pp.0. 10.1145/3365833 . hal-02881840

**HAL Id: hal-02881840**

**<https://hal.science/hal-02881840>**

Submitted on 26 Jun 2020

**HAL** is a multi-disciplinary open access archive for the deposit and dissemination of scientific research documents, whether they are published or not. The documents may come from teaching and research institutions in France or abroad, or from public or private research centers.

L'archive ouverte pluridisciplinaire **HAL**, est destinée au dépôt et à la diffusion de documents scientifiques de niveau recherche, publiés ou non, émanant des établissements d'enseignement et de recherche français ou étrangers, des laboratoires publics ou privés.



## Open Archive Toulouse Archive Ouverte

OATAO is an open access repository that collects the work of Toulouse researchers and makes it freely available over the web where possible

This is an author's version published in: <https://oatao.univ-toulouse.fr/26276>

### Official URL :

<https://doi.org/10.1145/3365833>

#### **To cite this version:**

Balbiani, Philippe and Boudou, Joseph and Diéguez, Martín and Fernández Duque, David *Intuitionistic linear temporal logics*. (2019) ACM Transactions on Computational Logic, 21 (2). ISSN 1529-3785

Any correspondence concerning this service should be sent to the repository administrator: [tech-oatao@listes-diff.inp-toulouse.fr](mailto:tech-oatao@listes-diff.inp-toulouse.fr)

# Intuitionistic Linear Temporal Logics

Philippe Balbiani. <sup>\*</sup>1, Joseph Boudou. <sup>†</sup>1, Martín Diéguez <sup>‡</sup>2, and  
David Fernández-Duque <sup>§</sup>3

<sup>1</sup>IRIT, Toulouse University. Toulouse, France

<sup>2</sup>CERV, ENIB,LAB-STICC. Brest, France

<sup>3</sup>Department of Mathematics, Ghent University. Gent, Belgium

## Abstract

We consider intuitionistic variants of linear temporal logic with ‘next’, ‘until’ and ‘release’ based on *expanding posets*: partial orders equipped with an order-preserving transition function. This class of structures gives rise to a logic which we denote  $\text{ITL}^e$ , and by imposing additional constraints we obtain the logics  $\text{ITL}^p$  of *persistent posets* and  $\text{ITL}^{\text{ht}}$  of *here-and-there temporal logic*, both of which have been considered in the literature. We prove that  $\text{ITL}^e$  has the effective finite model property and hence is decidable, while  $\text{ITL}^p$  does not have the finite model property. We also introduce notions of bounded bisimulations for these logics and use them to show that the ‘until’ and ‘release’ operators are not definable in terms of each other, even over the class of persistent posets.

## 1 Introduction

Intuitionistic logic [9, 35] and its modal extensions [16, 41, 44] play a crucial role in computer science and artificial intelligence and *Intuitionistic Temporal Logics* have not been an exception. The study of these logics can be a challenging enterprise [44] and, in particular, there is a huge gap that must be filled regarding combinations of intuitionistic and linear-time temporal logic [42]. This is especially pressing given several potential applications of intuitionistic temporal logics that have been proposed by several authors.

The first involves the Curry-Howard correspondence [24], which identifies intuitionistic proofs with the  $\lambda$ -terms of functional programming. Several extensions of the  $\lambda$ -calculus with operators from *Linear Time Temporal Logic* [42]

---

<sup>\*</sup>philippe.balbani@irit.fr

<sup>†</sup>joseph.boudou@irit.fr

<sup>‡</sup>martin.dieguez@enib.fr

<sup>§</sup>david.fernandezduque@ugent.be

(LTL) have been proposed in order to introduce new features to functional languages: Davies [10, 11] has suggested adding a ‘next’ ( $\circ$ ) operator to intuitionistic logic in order to define the type system  $\lambda^\circ$ , which allows extending functional languages with *staged computation*<sup>1</sup> [15]. Davies and Pfenning [12] proposed the functional language Mini-ML $^\square$  which is supported by intuitionistic S4 and allows capturing complex forms of staged computation as well as runtime code generation. Yuse and Igarashi later extended  $\lambda^\circ$  to  $\lambda^\square$  [45] by incorporating the ‘henceforth’ operator ( $\square$ ), useful for modelling persistent code that can be executed at any subsequent state.

Alternately, intuitionistic temporal logics have been proposed as a tool for modelling semantically-given processes. Maier [33] observed that an intuitionistic temporal logic with ‘henceforth’ and ‘eventually’ ( $\diamond$ ) could be used for reasoning about safety and liveness conditions in possibly-terminating reactive systems, and Fernández-Duque [18] has suggested that a logic with ‘eventually’ can be used to provide a decidable framework in which to reason about topological dynamics. In the areas of nonmonotonic reasoning, knowledge representation (KR), and artificial intelligence, intuitionistic and intermediate logics have played an important role within the successful answer set programming (ASP) [7] paradigm for practical KR, leading to several extensions of modal ASP [8] that are supported by intuitionistic-based modal logics like *temporal here and there* [3].

There have been some notable steps towards understanding intuitionistic temporal logics:

- Davies’ intuitionistic temporal logic with  $\circ$  [10] was provided Kripke semantics and a complete deductive system by Kojima and Igarashi [27].
- Logics with  $\circ, \square$  were axiomatized by Kamide and Wansing [25], where  $\square$  was interpreted over bounded time.
- Balbiani and Diéguez [3] axiomatized the Here and There [22] variant of LTL with  $\circ, \diamond, \square$ .
- Davoren [13] introduced topological semantics for temporal logics and Fernández-Duque [18] proved the decidability of a logic with  $\circ, \diamond$  and a universal modality based on topological semantics.

Nevertheless, many questions have remained open, especially regarding conservative extensions of intuitionistic logic with all of the tenses  $\circ, \diamond, \square$ , or even the more expressive ‘until’  $\text{U}$  and ‘release’  $\text{R}$ .

With the exception of [13, 18], semantics for intuitionistic LTL use frames of the form  $(W, \leq, S)$ , where  $\leq$  is a partial order used to interpret the intuitionistic implication and  $S$  is a binary relation used to interpret temporal operators. Since we are interested in linear time, we will restrict our attention to the case where  $S$  is a function. Thus, for example,  $\circ p$  is true at some world  $w \in W$  whenever  $p$  is true at  $S(w)$ . Note, however, that  $S$  cannot be an arbitrary

---

<sup>1</sup>*Staged computation* is a technique that allows dividing the computation in order to exploit the early availability of some arguments.

function. Intuitionistic semantics have the feature that, for any formula  $\varphi$  and worlds  $w \preceq v \in W$ , if  $\varphi$  is true at  $w$  then it must also be true at  $v$ ; that is, truth is *monotone* (with respect to  $\preceq$ ). If we want this property to be preserved by formulas involving  $\circ$ , we need for  $\preceq$  and  $S$  to satisfy certain confluence properties. In the literature, one generally considers frames satisfying

1.  $w \preceq v$  implies  $S(w) \preceq S(v)$  (*forward confluence*, or simply *confluence*), and
2. if  $u \succeq S(w)$ , there is  $v \succeq w$  such that  $S(v) = u$  (*backward confluence*)

(see Figure 1). We will call frames satisfying these conditions *persistent frames* (see Sec. 3), mainly due to the fact that they are closely related to (persistent) products of modal logics [30]. Persistent frames for intuitionistic LTL are closely related to the frames of the modal logic  $\text{LTL} \times \text{S4}$ , which is non-axiomatizable. For this reason, it may not be surprising that it is unknown whether the intuitionistic temporal logic of persistent frames, which we denote  $\text{ITL}^{\text{P}}$ , is decidable.

However, as we will see in Proposition 1, only forward confluence is needed for truth of all formulas to be monotone, even in the presence of  $\diamond$ ,  $\square$  or even  $\text{U}$  and  $\text{R}$ . The frames satisfying this condition are, instead, related to *expanding* products of modal logics [20], which are often decidable even when the corresponding product is non-axiomatizable. This suggests that dropping the backwards confluence could also lead to a more manageable intuitionistic temporal logic. We denote the resulting logic by  $\text{ITL}^{\text{e}}$  and, as we will prove in this paper, it enjoys a crucial advantage over  $\text{ITL}^{\text{P}}$ :  $\text{ITL}^{\text{e}}$  has the effective finite model property (hence it is decidable), but  $\text{ITL}^{\text{P}}$  does not. In fact, to the best of our knowledge,  $\text{ITL}^{\text{e}}$  is the first known decidable intuitionistic temporal logic that

1. is conservative over propositional intuitionistic logic,
2. includes (or can define) the three tenses  $\circ$ ,  $\text{U}$ ,  $\text{R}$ , and
3. is interpreted over infinite time.

Intuitively,  $\text{ITL}^{\text{P}}$  is a logic of invertible processes, while  $\text{ITL}^{\text{e}}$  reasons about non-invertible ones. The latter is closely related to  $\text{ITL}^{\text{c}}$ , an intuitionistic temporal logic for continuous dynamic topological systems [18]. In contrast, the logic  $\text{ITL}^{\text{e}}$  is based on relational, rather than topological, semantics, which has the advantage of admitting a natural ‘henceforth’ operator (although topological variants can be defined [6]). The current work extends previous results regarding a variant of  $\text{ITL}^{\text{e}}$  with  $\diamond$  and  $\square$ , rather than  $\text{U}$  and  $\text{R}$  [5].

Note that  $\diamond\varphi \equiv \neg\square\neg\varphi$  is not valid intuitionistically and hence  $\diamond$  cannot be defined in terms of  $\square$  using the standard equivalence. The same situation holds for the ‘until’ operator: while the language with  $\circ$  and  $\text{U}$  is equally expressive to classical monadic first-order logic with  $\leq$  over  $\mathbb{N}$  [19],  $\text{U}$  admits a first-order definable intuitionistic dual,  $\text{R}$  (‘release’), which cannot be defined in terms of  $\text{U}$  using the classical definition.

However, this is not enough to conclude that  $\text{R}$  cannot be defined in a different way in terms of  $\text{U}$ . Thus we will consider the question of *definability*: which

of the modal operators can be defined in terms of the others? As is well-known,  $\diamond\varphi \equiv \top \mathbf{U} \varphi$  and  $\square\varphi \equiv \perp \mathbf{R} \varphi$ ; these equivalences remain valid in the intuitionistic setting. Nevertheless, we will show that  $\square$  cannot be defined in terms of  $\mathbf{U}$ , and  $\diamond$  cannot be defined in terms of  $\mathbf{R}$ ; in order to prove this, we will develop a theory of bisimulations on  $\text{ITL}^e$  models.

## Layout

The paper is organised as follows: in Section 2 we present the syntax and the semantics in terms of dynamic posets and also study the validity of some of the classical axioms in our setting. In Section 3 we present the concepts of stratified and expanding frames and also show that satisfiability and validity on arbitrary models is equivalent to satisfiability and validity on expanding models. In Section 4 we consider two smaller classes of models, persistent and here-and-there models, and we compare their logics to  $\text{ITL}^e$ .

The Finite Model Property of  $\text{ITL}^e$  is studied along sections 5 and 6. In the former we introduce the concepts of labelled structures and quasimodels as well as several related concepts such as immersions, condensations, and normalised quasimodels. Those definitions are used in Section 6 to prove the finite model property of  $\text{ITL}^e$ .

In Section 7 we define the concept of bounded bisimulations in intuitionistic modal setting and use them to study the interdefinability of the  $\text{ITL}^e$  modalities in Section 8. We finish the paper with conclusions and future work.

## 2 Syntax and semantics

We will work in sublanguages of the language  $\mathbf{L}$  given by the following grammar:

$$\varphi, \psi := p \mid \perp \mid (\varphi \wedge \psi) \mid (\varphi \vee \psi) \mid (\varphi \rightarrow \psi) \mid (\circ\varphi) \mid (\diamond\varphi) \mid (\square\varphi) \mid (\varphi \mathbf{U} \psi) \mid (\varphi \mathbf{R} \psi)$$

where  $p$  is an element of a countable set of propositional variables  $\mathbb{P}$ . Henceforth we adhere to the standard conventions for omission of parentheses. All sublanguages we will consider include all Boolean operators and  $\circ$ , hence we denote them by displaying the additional connectives as a subscript: for example,  $\mathbf{L}_{\diamond\square}$  denotes the  $\mathbf{U}$ -free,  $\mathbf{R}$ -free fragment. As an exception to this general convention,  $\mathbf{L}_{\circ}$  denotes the fragment without  $\diamond, \square, \mathbf{U}$  or  $\mathbf{R}$ .

Given any formula  $\varphi$ , we define the *length* of  $\varphi$  (in symbols,  $|\varphi|$ ) recursively as follows:

- $|p| = |\perp| = 0$ ;
- $|\phi \odot \psi| = 1 + |\phi| + |\psi|$ , with  $\odot \in \{\vee, \wedge, \rightarrow, \mathbf{R}, \mathbf{U}\}$ ;
- $|\odot\psi| = 1 + |\psi|$ , with  $\odot \in \{\neg, \circ, \square, \diamond\}$ .

Broadly speaking, the length of a formula  $\varphi$  corresponds to the number of connectives appearing in  $\varphi$ .

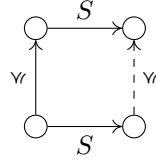

(a) Forward confluence

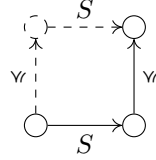

(b) Backward confluence

Figure 1: On a dynamic poset the above diagrams can always be completed if  $S$  is forward or backward confluent, respectively. Posets with both properties are *persistent*.

## 2.1 Dynamic posets

Formulas of  $L$  are interpreted over dynamic posets. A *dynamic poset* is a tuple  $D = (W, \leq, S)$ , where  $W$  is a non-empty set of states,  $\leq$  is a partial order, and  $S$  is a function from  $W$  to  $W$  satisfying the *forward confluence* condition that for all  $w, v \in W$ , if  $w \leq v$  then  $S(w) \leq S(v)$ . An *intuitionistic dynamic model*, or simply *model*, is a tuple  $\mathfrak{M} = (W, \leq, S, V)$  consisting of a dynamic poset equipped with a valuation function  $V : W \rightarrow \wp(\mathbb{P})$  that is *monotone* in the sense that for all  $w, v \in W$ , if  $w \leq v$  then  $V(w) \subseteq V(v)$ . In the standard way, we define  $S^0(w) = w$  and, for all  $k \geq 0$ ,  $S^{k+1}(w) = S(S^k(w))$ . Then we define the satisfaction relation  $\models$  inductively by:

1.  $\mathfrak{M}, w \models p$  iff  $p \in V(w)$ ;
2.  $\mathfrak{M}, w \not\models \perp$ ;
3.  $\mathfrak{M}, w \models \varphi \wedge \psi$  iff  $\mathfrak{M}, w \models \varphi$  and  $\mathfrak{M}, w \models \psi$ ;
4.  $\mathfrak{M}, w \models \varphi \vee \psi$  iff  $\mathfrak{M}, w \models \varphi$  or  $\mathfrak{M}, w \models \psi$ ;
5.  $\mathfrak{M}, w \models \circ\varphi$  iff  $\mathfrak{M}, S(w) \models \varphi$ ;
6.  $\mathfrak{M}, w \models \varphi \rightarrow \psi$  iff  $\forall v \geq w$ , if  $\mathfrak{M}, v \models \varphi$ , then  $\mathfrak{M}, v \models \psi$ ;
7.  $\mathfrak{M}, w \models \diamond\varphi$  iff there exists  $k \geq 0$  such that  $\mathfrak{M}, S^k(w) \models \varphi$ ;
8.  $\mathfrak{M}, w \models \square\varphi$  iff for all  $k \geq 0$  we have that  $\mathfrak{M}, S^k(w) \models \varphi$ ;
9.  $\mathfrak{M}, w \models \varphi \cup \psi$  iff there exists  $k \geq 0$  such that  $\mathfrak{M}, S^k(w) \models \psi$  and  $\forall i \in [0, k)$ ,  $\mathfrak{M}, S^i(w) \models \varphi$ ;
10.  $\mathfrak{M}, w \models \varphi \mathcal{R} \psi$  iff for all  $k \geq 0$ , either  $\mathfrak{M}, S^k(w) \models \psi$  or  $\exists i \in [0, k)$  such that  $\mathfrak{M}, S^i(w) \models \varphi$ .

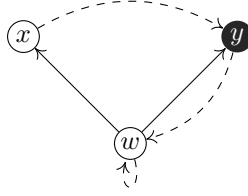

Figure 2: Example of an  $\text{ITL}^e$  model  $\mathfrak{M} = (W, \leq, S, V)$ , where  $\leq$  is the reflexive and transitive closure of the relation indicated by the solid arrows,  $S$  is the relation indicated by the dashed arrows, and a black dot indicates that the variable  $p$  is true, so that we only have  $p \in V(y)$ . Then, the reader may verify that  $\mathfrak{M}, x \models \text{Op}$  but  $\mathfrak{M}, x \not\models p$ , while  $\mathfrak{M}, y \models p$  but  $\mathfrak{M}, y \not\models \text{Op}$ . From this it follows that  $\mathfrak{M}, w \not\models (\text{Op} \rightarrow p) \vee (p \rightarrow \text{Op})$ .

See Figure 2 for illustration of the ‘ $\models$ ’ relation. Given a model  $\mathfrak{M} = (W, \leq, S, V)$  and  $w \in W$ , we write  $\Sigma_{\mathfrak{M}}(w)$  for the set  $\{\psi \in \Sigma \mid \mathfrak{M}, w \models \psi\}$ ; the subscript ‘ $\mathfrak{M}$ ’ is omitted when it is clear from the context.

A formula  $\varphi$  is *satisfiable over a class  $\Omega$  of models* if there is a model  $\mathfrak{M} \in \Omega$  and a world  $w$  so that  $\mathfrak{M}, w \models \varphi$ , and *valid over  $\Omega$*  if, for every world  $w$  of every model  $\mathfrak{M} \in \Omega$  we have that  $\mathfrak{M}, w \models \varphi$ . Satisfiability (resp. validity) over the class of all intuitionistic dynamic models is called *satisfiability* (resp. *validity*) for the *expanding domain intuitionistic temporal logic*  $\text{ITL}^e$ . We will justify this terminology in the next section. First, we remark that dynamic posets impose the minimal conditions on  $S$  and  $\leq$  in order to preserve the monotonicity of truth of formulas, in the sense that if  $\mathfrak{M}, w \models \varphi$  and  $w \leq v$  then  $\mathfrak{M}, v \models \varphi$ . Below, we will use the notation  $\llbracket \varphi \rrbracket = \{w \in W \mid \mathfrak{M}, w \models \varphi\}$ .

**Proposition 1.** *Let  $\mathfrak{D} = (W, \leq, S)$ , where  $(W, \leq)$  is a poset and  $S: W \rightarrow W$  is any function. Then, the following are equivalent:*

1.  *$S$  is forward confluent;*
2. *for every valuation  $V$  on  $\mathfrak{D}$  and every formula  $\varphi$ , truth of  $\varphi$  is monotone with respect to  $\leq$ .*

*Proof.* That (1) implies (2) follows by a standard structural induction on  $\varphi$ . The case where  $\varphi \in \mathbb{P}$  follows from the condition on  $V$  and most inductive steps are routine. Consider the case where  $\varphi = \psi \cup \theta$ , and suppose that  $w \leq v$  and  $w \in \llbracket \varphi \rrbracket$ . Then there exists  $k \in \mathbb{N}$  such that  $\mathfrak{M}, S^k(w) \models \theta$  and for all  $i \in [0, k)$ ,  $\mathfrak{M}, S^i(w) \models \psi$ . Since  $S$  is confluent, an easy induction shows that, for all  $i \in [0, k]$ ,  $S^i(w) \leq S^i(v)$ . Therefore, from the induction hypothesis we obtain that  $\mathfrak{M}, S^k(v) \models \theta$  and for all  $i \in [0, k)$ ,  $\mathfrak{M}, S^i(v) \models \psi$ . Other cases are either similar or easier.

Now we prove that (2) implies (1) by contrapositive. Suppose that  $(W, \leq, S)$  is not forward-confluent, so that there are  $w \leq v$  such that  $S(w) \not\leq S(v)$ . Choose  $p \in \mathbb{P}$  and define  $V(u) = \{p\}$  if  $S(w) \leq u$ ,  $V(u) = \emptyset$  otherwise. It follows from



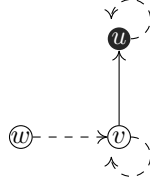

Figure 3: A dynamic intuitionistic model. As in the previous figure, solid arrows represent the intuitionistic order  $\leq$ , dashed arrows the successor relation  $S$ , the black point satisfies the atom  $p$  and no point satisfies any other atom. Note that  $S$  is forward, but not backward, confluent. The world  $w$  satisfies  $\neg \circ p \wedge \neg \circ \neg p$ .

the transitivity of  $\leq$  that  $V$  is monotone. However,  $p \notin V(S(v))$ , from which it follows that  $(D, V), w \models \circ p$  but  $(D, V), v \not\models \circ p$ .  $\square$

Observe that satisfiability in propositional intuitionistic logic is equivalent to satisfiability in classical propositional logic. This is because, if  $\varphi$  is classically satisfiable, it is trivially intuitionistically satisfiable in a one-world model; conversely, if  $\varphi$  is intuitionistically satisfiable, it is satisfiable in a finite model, hence in a maximal world of that finite model, and the generated submodel of a maximal world is a classical model. Thus it may be surprising that the same is not the case for intuitionistic temporal logic:

**Proposition 2.** *Any formula  $\varphi$  of the temporal language that is classically satisfiable is satisfiable in a dynamic poset. However, there is a formula satisfiable on a dynamic poset that is not classically satisfiable.*

*Proof.* If  $\varphi$  is satisfied on a classical LTL model  $\mathfrak{M}$ , then we may regard  $\mathfrak{M}$  as an intuitionistic model by letting  $\leq$  be the identity. On the other hand, consider the formula  $\neg \circ p \wedge \neg \circ \neg p$  (recall that  $\neg\theta$  is a shorthand for  $\theta \rightarrow \perp$ ). Classically, this formula is equivalent to  $\neg \circ p \wedge \circ p$ , and hence unsatisfiable. Define a model  $\mathfrak{M} = (W, \leq, S, V)$ , where  $W = \{w, v, u\}$ ,  $x \leq y$  if  $x = y$  or  $x = v, y = u$ ,  $S(w) = v$  and  $S(x) = x$  otherwise,  $V(u) = \{p\}$  and  $V(v) = V(w) = \emptyset$  (see Figure 3). Then, one can check that  $\mathfrak{M}, w \models \neg \circ p \wedge \neg \circ \neg p$ .  $\square$

Hence the decidability of the intuitionistic satisfiability problem is not a corollary of the classical case. In Section 6, we will prove that both the satisfiability and the validity problems are decidable. We will prove this by showing that  $\text{ITL}^e$  has the effective finite model property: recall that a logic  $\Lambda$  has the *effective finite model property* for a class of models  $\Omega$  if there is a computable function  $f: \mathbb{N} \rightarrow \mathbb{N}$  such that given a formula  $\varphi$ , we have that  $\varphi$  is satisfiable (falsifiable) on  $\Omega$  if and only if there is  $\mathfrak{M} \in \Omega$  such that  $\varphi$  is satisfied (falsified) on  $\mathfrak{M}$  and whose domain has at most  $f(|\varphi|)$  elements.

## 2.2 Some valid and non-valid ITL<sup>e</sup> formulas

In this section we present some examples of valid formulas that will be useful throughout the text. We begin by focusing on formulas of  $L_{\diamond\Box}$ .

**Proposition 3.** *The following formulas are ITL<sup>e</sup>-valid:*

- |  |  |
|--|--|
| 1. $\Box\perp \leftrightarrow \perp$   | 4. $\Box(\varphi \rightarrow \psi) \rightarrow (\Box\varphi \rightarrow \Box\psi)$ |
| 2. $\Box(\varphi \wedge \psi) \leftrightarrow (\Box\varphi \wedge \Box\psi)$ | 5. $\Box\Box\varphi \leftrightarrow \Box\Box\varphi$                               |
| 3. $\Box(\varphi \vee \psi) \leftrightarrow (\Box\varphi \vee \Box\psi)$     | 6. $\Box\Box\varphi \leftrightarrow \Box\Box\varphi$                               |

*Proof.* We prove that 4 holds and leave other items to the reader. Let  $\mathfrak{M} = (W, \leq, S, V)$  be any dynamic model and  $w \in W$  be such that  $\mathfrak{M}, w \models \Box(\varphi \rightarrow \psi)$ . Let  $v \geq w$  be such that  $\mathfrak{M}, v \models \Box\varphi$ . Then,  $\mathfrak{M}, S(v) \models \varphi$ . But  $S(w) \leq S(v)$  and  $\mathfrak{M}, S(w) \models \varphi \rightarrow \psi$ , so that  $\mathfrak{M}, S(w) \models \psi$  and  $\mathfrak{M}, v \models \Box\psi$ . Since  $v \geq w$  was arbitrary,  $\mathfrak{M}, w \models \Box\varphi \rightarrow \Box\psi$ .  $\square$

Note that, unlike the other items, 4 is not a biconditional, and indeed the converse is not valid over the class of all dynamic posets (see Proposition 6). Next we show that  $\Box\varphi$  (resp.  $\Box\varphi$ ) can be defined in terms of  $\Box$  (resp.  $\Box$ ) and the LTL axioms involving  $\Box$  and  $\Box$  are also valid in our setting:

**Proposition 4.** *The following formulas are ITL<sup>e</sup>-valid:*

- |   |  |
|---|--|
| 1. $(\varphi \Box \psi) \leftrightarrow \psi \vee (\varphi \wedge \Box(\varphi \Box \psi))$ | 6. $\Box\varphi \leftrightarrow (\perp \Box \varphi)$                                  |
| 2. $(\varphi \Box \psi) \leftrightarrow \psi \wedge (\varphi \vee \Box(\varphi \Box \psi))$ | 7. $\Box(\varphi \Box \psi) \leftrightarrow (\Box\varphi) \Box(\Box\psi)$              |
| 3. $(\varphi \Box \psi) \rightarrow \Box\psi$   | 8. $\Box(\varphi \Box \psi) \leftrightarrow (\Box\varphi) \Box(\Box\psi)$              |
| 4. $\Box\psi \rightarrow (\varphi \Box \psi)$   | 9. $\varphi \Box \psi \leftrightarrow (\psi \Box(\varphi \vee \psi)) \wedge \Box\psi$  |
| 5. $\Box\varphi \leftrightarrow (\top \Box \varphi)$  | 10. $\varphi \Box \psi \leftrightarrow (\psi \Box(\varphi \wedge \psi)) \vee \Box\psi$ |

*Proof.* We consider some cases below. For (1), from left to right, let us assume that  $\mathfrak{M}, w \models \varphi \Box \psi$ . Therefore there exists  $k \geq 0$  s.t.  $\mathfrak{M}, S^k(w) \models \psi$  and for all  $j$  satisfying  $0 \leq j < k$ ,  $\mathfrak{M}, S^j(w) \models \varphi$ . If  $k = 0$  then  $\mathfrak{M}, w \models \psi$  while, if  $k > 0$  it follows that  $\mathfrak{M}, w \models \varphi$  and  $\mathfrak{M}, S(w) \models \varphi \Box \psi$ . Therefore  $\mathfrak{M}, w \models \psi \vee (\varphi \wedge \Box(\varphi \Box \psi))$ . From right to left, if  $\mathfrak{M}, w \models \psi$  then  $\mathfrak{M}, w \models \varphi \Box \psi$  by definition (with  $k = 0$ ). If  $\mathfrak{M}, w \models \varphi \wedge \Box(\varphi \Box \psi)$  then  $\mathfrak{M}, w \models \varphi$  and  $\mathfrak{M}, S(w) \models \varphi \Box \psi$  so, due to the semantics, we conclude that  $\mathfrak{M}, w \models \varphi \Box \psi$  (with some  $k \geq 1$ ). In any case,  $\mathfrak{M}, w \models \varphi \Box \psi$ .

For (2), we work by contrapositive. From right to left, let us assume that  $\mathfrak{M}, w \not\models \varphi \Box \psi$ . Therefore there exists  $k \geq 0$  s.t.  $\mathfrak{M}, S^k(w) \not\models \psi$  and for all  $j$  satisfying  $0 \leq j < k$ ,  $\mathfrak{M}, S^j(w) \not\models \varphi$ . If  $k = 0$  then  $\mathfrak{M}, w \not\models \psi$  while, if  $k > 0$  it follows that  $\mathfrak{M}, w \not\models \varphi$  and  $\mathfrak{M}, S(w) \not\models \varphi \Box \psi$ . In any case,  $\mathfrak{M}, w \not\models \psi \wedge (\varphi \vee \Box(\varphi \Box \psi))$ . From left to right, if  $\mathfrak{M}, w \not\models \psi$  then  $\mathfrak{M}, w \not\models \varphi \Box \psi$  by definition. If  $\mathfrak{M}, w \not\models \varphi \vee \Box(\varphi \Box \psi)$  then  $\mathfrak{M}, w \not\models \varphi$  and  $\mathfrak{M}, S(w) \not\models \varphi \Box \psi$  so, due to the semantics of  $\Box$ , we conclude that  $\mathfrak{M}, w \not\models \varphi \Box \psi$ . In any case,  $\mathfrak{M}, w \not\models \varphi \Box \psi$ .

The remaining items are left to the reader.  $\square$

With these equivalences in mind, we can simplify the syntax of the full language  $L$ .

**Proposition 5.** *The languages  $L_{\diamond R}$  and  $L_{\square U}$  are expressively equivalent to  $L$  over the class of dynamic posets.*

*Proof.* From the validities  $\square\varphi \leftrightarrow \perp R\varphi$  and  $\varphi U\psi \leftrightarrow (\psi R(\varphi \vee \psi)) \wedge \diamond\psi$  we see that any  $\varphi \in L$  is equivalent to some  $\varphi' \in L_{\diamond R}$ . Similarly, from  $\diamond\varphi \leftrightarrow \top U\varphi$  and  $\varphi R\psi \leftrightarrow (\psi U(\varphi \wedge \psi)) \vee \square\psi$  we see that  $L_{\square U}$  is expressively equivalent to  $L$ .  $\square$

Nevertheless, we will later show that both  $L_U$  and  $L_R$  are strictly less expressive than the full language, in contrast to the classical case.

### 3 The expanding model property

As mentioned in the introduction, the logic  $ITL^e$  is closely related to *expanding products* of modal logics [20]. In this subsection, we introduce stratified and expanding frames, and show that satisfiability and validity on arbitrary models is equivalent to satisfiability and validity on expanding models. To do this, it is convenient to represent posets using acyclic graphs.

**Definition 1.** *A directed acyclic graph is a tuple  $(W, \uparrow)$ , where  $W$  is a set of vertices and  $\uparrow \subseteq W \times W$  is a set of edges whose reflexive, transitive closure  $\uparrow^*$  is antisymmetric. We will tacitly identify  $(W, \uparrow)$  with the poset  $(W, \uparrow^*)$ . A path from  $w_1$  to  $w_2$  is a finite sequence  $v_0 \dots v_n \in W$  such that  $v_0 = w_1$ ,  $v_n = w_2$  and for all  $k < n$ ,  $v_k \uparrow v_{k+1}$ . A tree is an acyclic graph  $(W, \uparrow)$  with an element  $r \in W$ , called the root, such that for all  $w \in W$  there is a unique path from  $r$  to  $w$ . A poset  $(W, \leq)$  is also a tree if there is a relation  $\uparrow$  on  $W \times W$  such that  $(W, \uparrow)$  is a tree and  $\leq = \uparrow^*$ .*

Below, if  $R \subseteq A \times A$  is a binary relation and  $X \subseteq A$ ,  $R \downarrow_X$  denotes the restriction of  $R$  to  $X$ . Similarly if  $f: A \rightarrow B$  then  $f \downarrow_X$  denotes the restriction of  $f$  to the domain  $X$ .

**Definition 2.** *A model  $\mathfrak{M} = (W, \leq, S, V)$  is stratified if there is a partition  $\{W_n\}_{n < \omega}$  of  $W$  such that*

1. *each  $W_n$  is closed under  $\leq$ ,*
2. *for all  $n$ ,  $(W_n, \leq \downarrow_{W_n})$  is a tree, and*
3. *if  $w \in W_n$  then  $S(w) \in W_{n+1}$ .*

*If  $\mathfrak{M}$  is stratified, we write  $\leq_n, S_n$ , and  $V_n$  instead of  $\leq \downarrow_{W_n}, S \downarrow_{W_n}$ , and  $V \downarrow_{W_n}$ . We then define  $\mathfrak{M}_n = (W_n, \leq_n, V_n)$ . If moreover we have that  $S(w) \leq S(v)$  implies  $w \leq v$ , then we say that  $\mathfrak{M}$  is an expanding model. We define stratified and expanding posets similarly, ignoring the clauses for  $V$ .*

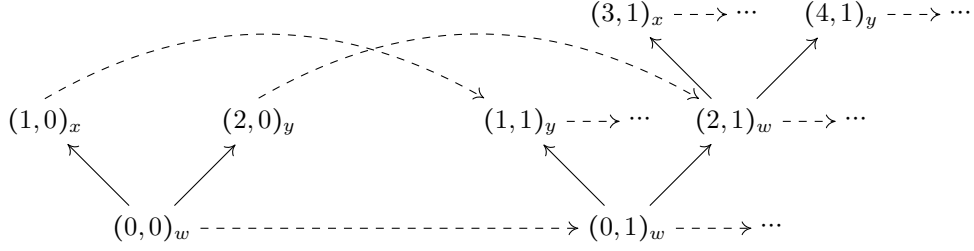

Figure 4: The strata  $W_0^e$ ,  $W_1^e$  of the stratified model obtained from the model defined in Figure 2. The subindices indicate the value of  $h = \bigcup_{k \in \mathbb{N}} h_k$ .

Below if  $\Sigma \subseteq \Delta \subseteq \mathbf{L}$  we write  $\Sigma \in \Delta$  to indicate that  $\Sigma$  is finite and closed under subformulas. In view of Proposition 5, in this section we may restrict our attention to  $\mathbf{L}_{\square \cup}$ . Given  $\Sigma \in \mathbf{L}_{\square \cup}$ , a model  $\mathfrak{M} = (W, \leq, S, V)$ , and a state  $w \in W$ , we will construct a stratified model  $\mathfrak{M}^e = (W^e, \leq^e, S^e, V^e)$  such that for the root  $w^e$  of  $W_0^e$ ,  $\Sigma(w^e) = \Sigma(w)$ .

**Definition 3.** Let  $\Sigma \in \mathbf{L}_{\square \cup}$  and  $\mathfrak{M} = (W, \leq, S, V)$  be a model. We first define the set  $D = \mathbb{N} \times \mathbb{N} \times \wp(\Sigma)$  of possible defects, and fix an enumeration  $((x_k, y_k, H_k))_{k \in \mathbb{N}}$  of  $D$ ; since  $\Sigma$  is finite and not empty, we assume that  $D$  is enumerated such that for each  $k > 0$ ,  $x_k \leq k$ . Then, for each  $k \in \mathbb{N}$ , we construct inductively a tuple  $(U_k, \uparrow_k, h_k)$  where  $U_k \subseteq \mathbb{N} \times \mathbb{N}$ ,  $\uparrow_k \subseteq U_k \times U_k$  and  $h_k : U_k \rightarrow W$ . The model  $\mathfrak{M}^e$  is defined from these tuples and the whole construction proceeds as follows:

**Base case.** Let  $U_0 = \{0\} \times \mathbb{N}$ ,  $\uparrow_0 = \emptyset$  and  $h_0$  be such that for all  $(0, y) \in U_0$ ,  $h_0(0, y) = S^y(w)$ .

**Inductive case.** Let  $k \geq 0$  and suppose that  $(U_k, \uparrow_k, h_k)$  has already been constructed. Let  $(x, y, H) = (x_k, y_k, H_k)$ . If (D1)  $(x, y) \in U_k$  and (D2) there is  $v = v_k \in W$  such that  $h_k(x, y) \leq v$  and  $\Sigma(v) = H$ , then we construct  $(U_{k+1}, \uparrow_{k+1}, h_{k+1})$  such that:

$$\begin{aligned} U_{k+1} &= U_k \cup \{(k+1, a) \mid y \leq a \in \mathbb{N}\} \\ \uparrow_{k+1} &= \uparrow_k \cup \{((x, a), (k+1, a)) \mid y \leq a \in \mathbb{N}\} \\ h_{k+1} &= h_k \cup \{((k+1, a), S^{d-y}(v)) \mid y \leq d \in \mathbb{N}\} \end{aligned}$$

Otherwise  $(U_{k+1}, \uparrow_{k+1}, h_{k+1}) = (U_k, \uparrow_k, h_k)$ .

**Final step.** Let  $h = \bigcup_{k \in \mathbb{N}} h_k$ . We construct  $\mathfrak{M}^e = (W^e, \leq^e, S^e, V^e)$  such that  $W^e = \bigcup_{k \in \mathbb{N}} U_k$ ,  $\leq^e = (\uparrow^e)^*$ , where  $\uparrow^e = \bigcup_{k \in \mathbb{N}} \uparrow_k$ ,  $S^e(a, b) = (a, b+1)$ , and  $V^e(x, y) = V(h(x, y))$ .

See Figure 4 for an illustration of the construction. We wish to prove that the structure  $\mathfrak{M}^e$  is a stratified model. To do this, we first establish some basic

properties of the finite stages of the construction. We begin with some simple observations.

**Lemma 1.** *If  $\Sigma \in \mathbf{L}_{\square\cup}$ ,  $\mathfrak{M} = (W, \leq, S, V)$  is any model,  $k \in \mathbb{N}$ , and  $(U_k)_{k \in \mathbb{N}}$  is as in Definition 3, then*

1.  $(a, b) \in U_k$  implies that  $a \leq k$ ,
2. if  $n \in \mathbb{N}$  then  $(S^e)^n(a, b) = (a, b + n) \in U_k$ , and
3.  $h_k: U_k \rightarrow W$  is a function and satisfies  $h_k \circ S^e = S \circ h_k$ .

*Proof.* These claims are proven by a straightforward induction on  $k$ . Assume that all claims hold for  $i < k$ . If  $(a, b) \in U_k$  then either  $a = k$ , or  $k > 0$  and  $(a, b) \in U_{k-1}$ . In the former case we trivially have  $a = k \leq k$  and in the latter  $a \leq k - 1$  by the induction hypothesis, establishing (1). For (2), if  $(a, b) \in U_{k-1}$  then the claim follows easily from the induction hypothesis. Otherwise,  $a = k$ . Then, from  $y \leq b \leq b + n'$  we see that  $(a, b + n') \in U_k$  for all  $n'$ , so that from the definition of  $S^e$  we obtain  $(S^e)^n(a, b) = (a, b + n) \in U_k$ .

Meanwhile  $h_k(a, b)$  is uniquely defined by either  $h_k(a, b) = S^{b-y}(v)$  if  $a = k$ , or  $h_{k-1}(a, b) = h_k(a, b)$  if  $k > 0$  and  $(a, b) \in U_{k-1}$  (so that  $a < k$ ). From this we see that  $h_k(S^e(a, b)) = h_k(a, b + 1) = S^{b+1-y}(v) = S(S^{b-y}(v)) = S(h_k(a, b))$ , obtaining (3).  $\square$

With this, we establish some properties of  $\uparrow_k^e$ .

**Lemma 2.** *Let  $\Sigma \in \mathbf{L}_{\square\cup}$ ,  $\mathfrak{M} = (W, \leq, S, V)$  be any model,  $k \in \mathbb{N}$ , and  $(U_k)_{k \in \mathbb{N}}$  be defined as in Definition 3. Suppose that  $(a, b) \uparrow_k (c, d)$ . Then,*

1.  $(a, b), (c, d) \in U_k$ ,
2.  $a < c$  and  $b = d$ ,
3. if  $(a', b') \uparrow_k (c, d)$  then  $(a, b) = (a', b')$ ,
4.  $(a, b + 1) \uparrow_k (c, d + 1)$ ,
5. if  $(c, d - 1) \in U_k$  then  $(a, b - 1) \in U_k$  and  $(a, b - 1) \uparrow_k (c, d - 1)$ , and
6.  $h_k(a, b) \leq h_k(c, d)$ .

*Proof.* We proceed by induction on  $k$ . The base case,  $k = 0$ , is proved by using the fact that  $\uparrow_0 = \emptyset$ , so the antecedent is always false. For the inductive step, let us assume that the lemma holds for all  $0 \leq i \leq k$  and we will prove the lemma for  $k + 1$ . To do so, let us take  $(a, b), (c, d) \in \mathbb{N} \times \mathbb{N}$  satisfying  $(a, b) \uparrow_{k+1} (c, d)$ . If  $(a, b) \uparrow_k (c, d)$ , the induction hypothesis immediately yields all desired properties.

Otherwise, conditions (D1) and (D2) hold, so that  $(x, y) := (x_k, y_k) \in U_k$  satisfies  $a = x$ ,  $c = k + 1$ ,  $b \geq y$  and  $b = d$ . Since  $y \leq b$  we see using Lemma 1.2 that  $(a, b) \in U_k \subseteq U_{k+1}$  and since also  $d \geq y$  we have that  $(c, d) \in U_{k+1}$  by the definition of  $U_{k+1}$ , establishing (1). Moreover  $a \in U_k$  so that  $a \leq k$ , hence  $a \leq k \leq k + 1 = c$ , so

$a < c$ , and by definition of  $\uparrow_{k+1}$  we must have  $b = d$ , establishing (2). Since  $b < b+1$  we have that  $(a, b+1), (c, d+1) \in U_{k+1}$  and  $(a, b+1) \uparrow_{k+1} (k+1, b+1) = (c, d+1)$  also by definition of  $\uparrow_{k+1}$ , thus (4) holds. If  $(c, d-1) \in U_{k+1}$  then  $y < d = b$  so that  $(a, b-1) \in U_k$ , and moreover  $(a, b-1) \uparrow_{k+1} (c, d-1)$  by definition, hence (5).

Finally, recall that  $h_k(x, y) \leq v := v_k$ . Since  $h_{k+1}(a, b) = h_{k+1}(x, d) = S^{d-y}(h_k(x, y))$  and  $h_{k+1}(c, d) = h_{k+1}(k+1, d) = S^{d-y}(v)$ , by the confluence condition for  $\mathfrak{M}$  and a straightforward secondary induction on  $d$ ,  $h_{k+1}(x, d) \leq h_{k+1}(c, d)$ , establishing (6).  $\square$

With this we may begin proving some properties of the model  $\mathfrak{M}^e = (W^e, \leq^e, S^e, V^e)$ . We start by considering the function  $h$ .

**Lemma 3.** *Let  $\Sigma \in \mathbb{L}_{\square\cup}$  and  $\mathfrak{M} = (W, \leq, S, V)$  be any model. Then  $h: W^e \rightarrow W$  is a function and  $S \circ h = h \circ S^e$ .*

*Proof.* By Lemma 1.3,  $h_k: U_k \rightarrow W$  is a function for all  $k$ , and since  $W^e = \bigcup_{k \in \mathbb{N}} U_k$  and  $h = \bigcup_{k \in \mathbb{N}} h_k$  with the union being increasing, we have that  $h: W^e \rightarrow W$ . Then we have that  $S \circ h = S \circ \bigcup_{k \in \mathbb{N}} h_k = \bigcup_{k \in \mathbb{N}} (S \circ h_k) = \bigcup_{k \in \mathbb{N}} (h_k \circ S^e) = (\bigcup_{k \in \mathbb{N}} h_k) \circ S^e = h \circ S^e$ .  $\square$

**Lemma 4.** *Let  $\Sigma \in \mathbb{L}_{\square\cup}$  and  $\mathfrak{M} = (W, \leq, S, V)$  be any model. Then whenever  $(x, y) \leq^e (x', y')$ ,*

1.  $x \leq x'$  and  $y = y'$ ,
2.  $S^e(x, y) \leq^e S^e(x', y')$ ,
3. if  $(x, y) = S^e(w, v)$  and  $(x', y') = S^e(w', v')$  then  $(w, v) \leq^e (w', v')$ , and
4.  $h(x, y) \leq h(x', y')$ .

*Proof.* If  $(x, y) \leq^e (x', y')$ , then  $(x, y)(\uparrow^e)^*(x', y')$ . Let  $n$  in  $\mathbb{N}$  and  $(x_0, y_0), \dots, (x_n, y_n)$  in  $W^e$  be such that  $(x_0, y_0) = (x, y)$ ,  $(x_n, y_n) = (x', y')$  and for all nonnegative integers  $i < n$ ,  $(x_i, y_i) \uparrow^e (x_{i+1}, y_{i+1})$ . Thus, for all nonnegative integers  $i < n$ , let  $k_i$  in  $\mathbb{N}$  be such that  $(x_i, y_i) \uparrow_{k_i} (x_{i+1}, y_{i+1})$ .

To see that (1) holds, note that by Lemma 2.2, for all  $i < n$ ,  $x_i < x_{i+1}$  and  $y_i = y_{i+1}$ . Since  $(x_0, y_0) = (x, y)$  and  $(x_n, y_n) = (x', y')$ , therefore  $x \leq x'$  and  $y = y'$ . For (2), by Lemma 2.4 we have that for all nonnegative integers  $i < n$ ,  $(x_i, y_i + 1) \uparrow_{k_i} (x_{i+1}, y_{i+1} + 1)$ , so that the sequence  $((x_i, y_i + 1))_{i < n}$  witnesses that  $S^e(x, y) = (x, y + 1) \leq^e (x', y' + 1) = S^e(x', y')$ . That (3) holds follows from similar considerations using Lemma 2.5.

To establish (4), we consider the following two cases. If  $n = 0$ , then  $(x, y) = (x', y')$ . Thus  $h(x, y) \leq h(x', y')$  since  $\leq$  is reflexive. Otherwise,  $n \geq 1$ . Hence, by Lemma 2.6, for all nonnegative integers  $i < n$ ,  $(x_i, y_i + 1) \uparrow_{k_i} (x_{i+1}, y_{i+1} + 1)$  for all  $i < n$ , so that also  $h(x_i, y_i) \leq h(x_{i+1}, y_{i+1})$ , hence by transitivity  $h(x, y) \leq h(x', y')$ .  $\square$

Finally, we show that  $\uparrow^e$  is suitable for producing a stratified model.

**Lemma 5.** *Let  $\Sigma \in \mathsf{L}_{\square\cup}$ ,  $\mathfrak{M} = (W, \leq, S, V)$  be any model,  $k \in \mathbb{N}$  and  $U_k, \uparrow_k$  be as in Definition 3. Then, the graph  $(W^e, \uparrow^e)$  is acyclic and if  $(0, b), (a, b) \in W^e$  there exists a unique path from  $(0, b)$  to  $(a, b)$ .*

*Proof.* That  $(W^e, \uparrow^e)$  is acyclic is an immediate consequence of Lemma 2.2. The second claim follows by induction on  $a$ . Suppose that  $(a, b) \in W^e$ . If  $a = 0$  then once again by Lemma 2.2  $(0, b)$  has no predecessors and hence the singleton  $((0, b))$  is the unique path leading from  $(0, b)$  to  $(a, b)$ . Otherwise observe that if  $(c, d) \uparrow^e (a, b)$  and  $(c', d') \uparrow^e (a, b)$  then  $(c, d), (c', d') \uparrow_k (a, b)$  for some  $k$ , hence by Lemma 2.3  $(c, d) = (c', d')$  and by Lemma 2.2,  $d = b$ . Thus by induction hypothesis there is a unique path  $((a_i, b_i))_{i < n}$  from  $(0, b)$  to  $(c, d)$ , which means that the only path from  $(0, b)$  to  $(a, b)$  is  $((a_i, b_i))_{i \leq n}$  with  $(a_n, b_n) = (a, b)$ .  $\square$

With this we are ready to show that  $\mathfrak{M}^e$  is expanding and satisfies (falsifies) the same formulae as  $(\mathfrak{M}, w)$ .

**Lemma 6.** *Given  $\Sigma \in \mathsf{L}_{\square\cup}$  and a model  $\mathfrak{M}$ ,  $\mathfrak{M}^e$  is an expanding model.*

*Proof.* First we check that  $\mathfrak{M}^e$  is a model. It is easy to see using Lemma 4.1 that  $\leq^e$  is antisymmetric, hence a partial order since it is already a transitive, reflexive closure. For the monotonicity condition, suppose that  $(x, y) \leq^e (x', y')$ . By Lemma 4.4,  $h(x, y) \leq h(x', y')$  and by the monotonicity condition for  $\mathfrak{M}$ ,  $V^e(x, y) = V(h(x, y)) \subseteq V(h(x', y')) = V^e(x', y')$ . Confluence of  $S^e$  follows from Lemma 4.2. Therefore,  $\mathfrak{M}^e$  is a model.

To prove that  $\mathfrak{M}^e$  is stratified, define  $W_n^e = \{(x, y) \in W^e \mid y = n\}$  for all  $n \in \mathbb{N}$ . Condition 3 of Def. 2 trivially holds, condition 1 comes directly from Lemma 4.1, and condition 2 from Lemma 5. Moreover,  $\mathfrak{M}^e$  is expanding by Lemma 4.3.  $\square$

**Lemma 7.** *Let  $\Sigma \in \mathsf{L}_{\square\cup}$  and  $\mathfrak{M} = (W, \leq, S, V)$  be any model. For any state  $(x, y) \in W^e$  and any  $\psi \in \Sigma$ ,  $\mathfrak{M}^e, (x, y) \models \psi$  if and only if  $\mathfrak{M}, h(x, y) \models \psi$ .*

*Proof.* The proof is by induction on the size  $|\psi|$  of the formula. The cases for propositional variables, falsum, conjunctions and disjunctions are straightforward. For the temporal modalities, recall that for all  $(x, y) \in W^e$  and all  $n \in \mathbb{N}$ ,  $(S^e)^n(x, y) = (x, y + n) \in W^e$ , so that by Lemma 3,  $h(x, y + n) = S^n(h(x, y))$ , which allows us to easily apply the induction hypothesis.

Finally, for implication, suppose first that  $\mathfrak{M}^e, (x, y) \not\models \psi_1 \rightarrow \psi_2$ . Then there is  $(x', y')$  such that  $(x, y) \leq^e (x', y')$ ,  $\mathfrak{M}^e, (x', y') \models \psi_1$  and  $\mathfrak{M}^e, (x', y') \not\models \psi_2$ . By Lemma 4.4,  $h(x, y) \leq h(x', y')$  and by induction hypothesis,  $\mathfrak{M}, h(x', y') \models \psi_1$  and  $\mathfrak{M}, h(x', y') \not\models \psi_2$ . Therefore,  $\mathfrak{M}, h(x, y) \not\models \psi_1 \rightarrow \psi_2$ . For the other direction suppose that  $\mathfrak{M}, h(x, y) \not\models \psi_1 \rightarrow \psi_2$ . Hence, There is  $v' \in W$  such that  $h(x, y) \leq v'$ ,  $\mathfrak{M}, v' \models \psi_1$  and  $\mathfrak{M}, v' \not\models \psi_2$ . Let  $k$  be such that  $(x_k, y_k, H_k) = (x, y, \Sigma(v'))$ ; then,  $v'$  witnesses that (D2) holds, and since  $x \leq k$ , condition (D1) holds too. Hence, there is  $(x', y') \in W^e$  such that  $\Sigma(h(x', y')) = \Sigma(v')$  and  $(x, y) \uparrow^e (x', y')$ , which implies that  $(x, y) \leq^e (x', y')$ . By induction hypothesis,  $\mathfrak{M}^e, (x', y') \models \psi_1$  and  $\mathfrak{M}^e, (x', y') \not\models \psi_2$ , hence  $\mathfrak{M}^e, (x, y) \not\models \psi_1 \rightarrow \psi_2$ .  $\square$

In conclusion, we obtain the following:

**Theorem 1.** *A formula  $\varphi$  is satisfiable (resp. falsifiable) on an intuitionistic dynamic model if and only if it is satisfiable (resp. falsifiable) on an expanding model.*

## 4 Special classes of frames

As we have seen in Proposition 1, the class of dynamic posets is the widest class of posets equipped with a function that satisfy truth monotonicity under the classical interpretation of the temporal modalities. However, in the literature one often considers smaller classes of frames. In this section we will discuss persistent and here-and-there models, and compare their logics to  $\text{ITL}^e$ .

### 4.1 Persistent frames

Expanding models were introduced as a weakening of product models, and thus it is natural to also consider a variant of  $\text{ITL}^e$  interpreted over ‘standard’ product models, or over the somewhat wider class of persistent models.

**Definition 4.** *Let  $(W, \leq)$  be a poset. If  $S:W \rightarrow W$  is such that, whenever  $v \geq S(w)$ , there is  $u \geq w$  such that  $v = S(u)$ , we say that  $S$  is backward confluent. If  $S$  is both forward and backward confluent, we say that it is persistent. A tuple  $(W, \leq, S)$  where  $S$  is persistent is a persistent intuitionistic temporal frame, and the set of valid formulas over the class of persistent intuitionistic temporal frames is denoted  $\text{ITL}^p$ , or persistent domain  $\text{ITL}$ .*

See Figure 1 for an illustration of backwards confluence. The name ‘persistent’ comes from the fact that Theorem 1 can be modified to obtain a stratified model  $\mathfrak{M}$  where  $S':W'_k \rightarrow W'_{k+1}$  is an isomorphism, i.e. whose domains are persistent with respect to  $S'$ , although we will not elaborate on this issue here. Next we remark that  $\text{ITL}^e \not\subseteq \text{ITL}^p$ , given the following claim proven in [6].

**Proposition 6.** *The formula  $(\circ\varphi \rightarrow \circ\psi) \rightarrow \circ(\varphi \rightarrow \psi)$  is not  $\text{ITL}^e$ -valid. However it is  $\text{ITL}^p$ -valid.*

Over the class of persistent models this property will allow us to ‘push down’ all occurrences of  $\circ$  to the propositional level. Say that a formula  $\varphi$  is in  $\circ$ -normal form if all occurrences of  $\circ$  are of the form  $\circ^i p$ , with  $p$  a propositional variable.

**Theorem 2.** *Given  $\varphi \in \mathbb{L}$ , there exists  $\tilde{\varphi}$  in  $\circ$ -normal form such that  $\varphi \leftrightarrow \tilde{\varphi}$  is valid over the class of persistent models.*

*Proof.* The claim can be proven by structural induction using the validities in Propositions 3, 6 and 4.  $\square$

We remark that the only reason that this argument does not apply to arbitrary  $\text{ITL}^e$  models is the fact that  $(\circ\varphi \rightarrow \circ\psi) \rightarrow \circ(\varphi \rightarrow \psi)$  is not valid in



general (Proposition 6). Next we show that the finite model property fails over the class of persistent models, using the following formula.

**Lemma 8.** *The formula  $\varphi = \neg\neg\Diamond\Box p \rightarrow \Diamond\neg\neg\Box p$  is not valid over the class of persistent models.*

*Proof.* Consider the model  $M = (W, \leq, S, V)$ , where  $W = \mathbb{Z} \cup \{r\}$  with  $r$  a fresh world not in  $\mathbb{Z}$ ,  $w \leq v$  if and only if  $w = r$  or  $w = v$ ,  $S(r) = r$  and  $S(n) = n + 1$  for  $n \in \mathbb{Z}$ , and  $\llbracket p \rrbracket = [0, \infty)$ . It is readily seen that  $M$  is a persistent model, that  $\mathfrak{M}, r \models \neg\neg\Diamond\Box p$  (since every world above  $r$  satisfies  $\Diamond\Box p$ ), yet  $\mathfrak{M}, r \not\models \Diamond\neg\neg\Box p$ , since there is no  $n$  such that  $\mathfrak{M}, S^n(r) \models \neg\neg\Box p$ . It follows that  $\mathfrak{M}, r \not\models \varphi$ , and hence  $\varphi$  is not valid, as claimed.  $\square$

**Lemma 9.** *The formula  $\varphi$  (from Lemma 8) is valid over the class of finite, persistent models.*

*Proof.* Let  $\mathfrak{M} = (W, \leq, S, V)$  be a finite, persistent model, and assume that  $\mathfrak{M}, w \models \neg\neg\Diamond\Box p$ . Let  $v_1, \dots, v_n$  enumerate the maximal elements of  $\{v \in W \mid w \leq v\}$ . For each  $i \leq n$ , let  $k_i$  be large enough so that  $\mathfrak{M}, S^{k_i}(v_i) \models \Box p$ , and let  $k = \max k_i$ . We claim that  $\mathfrak{M}, S^k(w) \models \neg\neg\Box p$ , which concludes the proof. Let  $u \geq S^k(w)$  be any leaf. Then, there is  $v' \geq w$  such that  $u = S^k(v')$  (since compositions of persistent functions are persistent). Choosing a leaf  $v \geq v'$ , we obtain by forward confluence of  $S^k$  that  $S^k(v) = u$  (as  $u$  is already a leaf). But, since  $k \geq k_i$ , we obtain  $\mathfrak{M}, u \models \Box p$ . Since  $u$  was arbitrary we easily obtain  $\mathfrak{M}, w \models \Diamond\neg\neg\Box p$ , as desired.  $\square$

The following is then immediate from Lemmas 8 and 9:

**Theorem 3.** *ITL<sup>P</sup> does not have the finite model property.*

Thus our decidability proof for ITL<sup>e</sup>, which proceeds by first establishing an effective finite model property, will not carry over to ITL<sup>P</sup>. Whether ITL<sup>P</sup> is decidable remains open.

## 4.2 Temporal here-and-there models

An even smaller class of models which, nevertheless, has many applications is that of temporal here-and-there models [8, 3]. Some of the results we will present here apply to this class, so it will be instructive to review it. The logic of here-and-there is the maximal logic strictly between classical and intuitionistic propositional logic, given by a frame  $\{0, 1\}$  with  $0 \leq 1$ . This logic is axiomatized by adding to intuitionistic propositional logic the axiom  $p \vee (p \rightarrow q) \vee \neg q$ .

A temporal here-and-there frame is a persistent frame that is ‘locally’ based on this frame. To be precise:

**Definition 5.** *A temporal here-and-there frame is a persistent frame  $(W, \leq, S)$  such that  $W = T \times \{0, 1\}$  for some set  $T$ , and there is a function  $f: T \rightarrow T$  such that for all  $t, s \in T$  and  $i, j \in \{0, 1\}$ ,  $(t, i) \leq (s, j)$  if and only if  $t = s$  and  $i \leq j$  and  $S(t, i) = (f(t), i)$ .*

The prototypical example is the frame  $(W, \leq, S)$ , where  $W = \mathbb{N} \times \{0, 1\}$ ,  $(i, j) \leq (i', j')$  if  $i = i'$  and  $j \leq j'$ , and  $S(i, j) = (i + 1, j)$ . Note, however, that our definition allows for other examples (see Figure 8). We will denote the resulting logic by  $\text{ITL}^{\text{ht}}$ . In its propositional flavour, here-and-there logic plays a crucial role in the definition of Equilibrium Logic [39, 40], a well-known characterisation of Stable Model [21] and Answer Set [37, 34] semantics for logic programs. Modal extensions of this aforementioned superintuitionistic logic made it possible to extend those existent logic programming paradigms with new constructs, allowing their use in different scenarios where describing and reasoning with temporal [8] or epistemic [17] data is necessary. A combination of propositional here-and-there with LTL was axiomatized by Balbiani and Diéguez [3], who also show that  $\Box$  cannot be defined in terms of  $\Diamond$ , a result we will strengthen here to show that  $\Box$  cannot be defined even in terms of  $\cup$ . It is also claimed in [3] that  $\Diamond$  is not definable in terms of  $\Box$  over the class of here-and-there models, but as we will see in Proposition 11, this claim is incorrect.

## 5 Combinatorics of intuitionistic models

In this section we introduce some combinatorial tools we will need in order to prove that  $\text{ITL}^e$  has the effective finite model property, and hence is decidable. We begin by discussing labelled structures, which allow for a graph-theoretic approach to intuitionistic models.

### 5.1 Labelled structures and quasimodels

**Definition 6.** *Given a set  $\Lambda$  whose elements we call ‘labels’ and a set  $W$ , a  $\Lambda$ -labelling function on  $W$  is any function  $\lambda: W \rightarrow \Lambda$ . A structure  $S = (W, R, \lambda)$  where  $W$  is a set,  $R \subseteq W \times W$  and  $\lambda$  is a labelling function on  $W$  is a  $\Lambda$ -labelled structure, where ‘structure’ may be replaced with ‘poset’, ‘directed graph’, etc.*

A useful measure of the complexity of a labelled poset or graph is given by its level:

**Definition 7.** *Given a labelled poset  $\mathfrak{A} = (W, \leq, \lambda)$  and an element  $w \in W$ , an increasing chain from  $w$  of length  $n$  is a sequence  $v_1 \dots v_n$  of elements of  $W$  such that  $v_1 = w$  and  $\forall i < n, v_i < v_{i+1}$ , where  $u < u'$  is shorthand for  $u \leq u'$  and  $u' \not\leq u$ . The chain  $v_1 \dots v_n$  is proper if it moreover satisfies  $\forall i < n, \lambda(v_i) \neq \lambda(v_{i+1})$ . The depth  $\text{dpt}(w) \in \mathbb{N} \cup \{\omega\}$  of  $w$  is defined such that  $\text{dpt}(w) = m$  if  $m$  is the maximal length of all the increasing chains from  $w$  and  $\text{dpt}(w) = \omega$  if there is no such maximum. Similarly, the level  $\text{lev}(w) \in \mathbb{N} \cup \{\omega\}$  of  $w$  is defined such that  $\text{lev}(w) = m$  if  $m$  is the maximal length of all the proper increasing chains from  $w$  and  $\text{lev}(w) = \omega$  if there is no such maximum. The level  $\text{lev}(\mathfrak{A})$  of  $\mathfrak{A}$  is the maximal level of all of its elements.*

The notions of depth and level are extended to any acyclic directed graph  $(W, \uparrow, \lambda)$  by taking the respective values on  $(W, \uparrow^*, \lambda)$ .

An important class of labelled posets comes from intuitionistic models. Below, recall that  $\Sigma_{\mathfrak{M}}(w) = \{\psi \in \Sigma \mid \mathfrak{M}, w \models \psi\}$ , and we may omit the subindex ‘ $\mathfrak{M}$ ’.

**Definition 8.** *Given an intuitionistic Kripke model  $\mathfrak{M} = (W, \leq, V)$ , we denote the labelled poset  $(W, \leq, \Sigma_{\mathfrak{M}})$  by  $\mathfrak{M}^\Sigma$ . Conversely, given a labelled poset  $\mathfrak{A} = (W, \leq, \lambda)$  over  $\wp(\Sigma)$  such that if  $w \leq v$  then  $\lambda(w) \subseteq \lambda(v)$ , the valuation  $V_\lambda$  is defined such that  $V_\lambda(w) = \{p \in \mathbb{P} \mid p \in \lambda(w)\}$  for all  $w \in W$ , and denote the resulting model by  $\mathfrak{A}^{\text{mod}}$ .*

If  $\mathfrak{M} = (W, \leq, V)$  is a model, it can easily be checked that for all  $w, v \in W$ , if  $w \leq v$  then  $\Sigma(w) \subseteq \Sigma(v)$ . Note that not every  $\wp(\Sigma)$ -labelled poset is of the form  $\mathfrak{M}^\Sigma$ , as it has to satisfy additional conditions according to the semantics. In particular, we are interested in labelled posets that respect the intuitionistic implication:

**Definition 9.** *Let  $\Sigma \in \mathbb{L}_{\square\cup}$  and  $\mathfrak{A} = (W, \leq, \lambda)$  be a  $\wp(\Sigma)$ -labelled poset. We say that  $\mathfrak{A}$  is a  $\Sigma$ -quasimodel if  $\lambda$  is monotone in the sense that  $w \leq v$  implies that  $\lambda(w) \subseteq \lambda(v)$ , and whenever  $\varphi \rightarrow \psi \in \Sigma$  and  $w \in W$ , we have that  $\varphi \rightarrow \psi \in \lambda(w)$  if and only if, for all  $v$  such that  $w \leq v$ , if  $\varphi \in \lambda(v)$  then  $\psi \in \lambda(v)$ .*

*If further  $(W, \leq)$  is a tree, we say that  $\mathfrak{A}$  is tree-like.*

## 5.2 Simulations, immersions and condensations

As is well-known, truth in intuitionistic models is preserved by bisimulation, and thus this is usually the appropriate notion of equivalence between different models. However, it will also be convenient to consider a weaker notion, which we call *bimersion*.

**Definition 10.** *Given two labelled posets  $\mathfrak{A} = (W_{\mathfrak{A}}, \leq_{\mathfrak{A}}, \lambda_{\mathfrak{A}})$  and  $\mathfrak{B} = (W_{\mathfrak{B}}, \leq_{\mathfrak{B}}, \lambda_{\mathfrak{B}})$  and a relation  $R \subseteq W_{\mathfrak{A}} \times W_{\mathfrak{B}}$ , we write*

$$\begin{aligned} \text{dom}(R) &= \{w \in W_{\mathfrak{A}} \mid \exists v \in W_{\mathfrak{B}} (w, v) \in R\} \\ \text{rng}(R) &= \{v \in W_{\mathfrak{B}} \mid \exists w \in W_{\mathfrak{A}} (w, v) \in R\}. \end{aligned}$$

*A relation  $\sigma \subseteq W_{\mathfrak{A}} \times W_{\mathfrak{B}}$  is a simulation from  $\mathfrak{A}$  to  $\mathfrak{B}$  if  $\text{dom}(\sigma) = W_{\mathfrak{A}}$  and whenever  $w \sigma v$ , it follows that  $\lambda_{\mathfrak{A}}(w) = \lambda_{\mathfrak{B}}(v)$ , and if  $w \leq_{\mathfrak{A}} w'$  then there is  $v'$  so that  $v \leq_{\mathfrak{B}} v'$  and  $w' \sigma v'$ .*

*A simulation is called a (partial) immersion if it is a (partial) function. If an immersion  $\sigma: W_{\mathfrak{A}} \rightarrow W_{\mathfrak{B}}$  exists, we write  $\mathfrak{A} \triangleleft \mathfrak{B}$ . If, moreover, there is an immersion  $\tau: W_{\mathfrak{B}} \rightarrow W_{\mathfrak{A}}$ , we say that they are bimersive, write  $\mathfrak{A} \triangleleft \mathfrak{B}$ , and call the pair  $(\sigma, \tau)$  a bimersion. A condensation from  $\mathfrak{A}$  to  $\mathfrak{B}$  is a bimersion  $(\rho, \iota)$  so that  $\rho: W_{\mathfrak{A}} \rightarrow W_{\mathfrak{B}}$ ,  $\iota: W_{\mathfrak{B}} \rightarrow W_{\mathfrak{A}}$ ,  $\rho$  is surjective, and  $\rho \iota$  is the identity on  $W_{\mathfrak{B}}$ . If such a condensation exists we write  $\mathfrak{B} \ll \mathfrak{A}$ . Observe that  $\mathfrak{B} \ll \mathfrak{A}$  implies that  $\mathfrak{B} \triangleleft \mathfrak{A}$ .*

*If  $\mathfrak{M}, \mathfrak{N}$  are models and  $\Sigma \in \mathbb{L}_{\square\cup}$ , we write  $\mathfrak{M} \triangleleft_{\Sigma} \mathfrak{N}$  if  $\mathfrak{M}^\Sigma \triangleleft \mathfrak{N}^\Sigma$ , and define  $\triangleleft_{\Sigma}, \ll_{\Sigma}$  similarly. We may also write e.g.  $\mathfrak{A} \ll \mathfrak{M}$  if  $\mathfrak{A}$  is  $\wp(\Sigma)$ -labelled and  $\mathfrak{A} \ll \mathfrak{M}^\Sigma$ .*

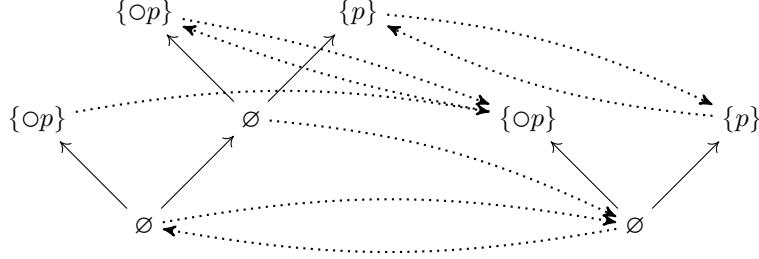

Figure 5: A condensation from the labelled frame on the left to the labelled frame on the right. Dotted arrows indicate the condensation:  $\rho$  for arrows from left to right and  $\iota$  for arrows from right to left.

See Figure 5 for an example of a condensation. Note that the relation  $\hat{=}$  is an equivalence relation. In this text, simulations will *always* be between posets. In the case that  $\mathfrak{A}$  or  $\mathfrak{B}$  is an acyclic directed graph, a simulation between  $\mathfrak{A}$  and  $\mathfrak{B}$  will be one between their respective transitive, reflexive closures. It will typically be convenient to work with immersions rather than simulations: however, as the next lemma shows, not much generality is lost by this restriction.

**Lemma 10.** *Let  $\mathfrak{A} = (W_{\mathfrak{A}}, \leq_{\mathfrak{A}}, \lambda_{\mathfrak{A}})$  and  $\mathfrak{B} = (W_{\mathfrak{B}}, \leq_{\mathfrak{B}}, \lambda_{\mathfrak{B}})$  be labelled posets. If a simulation  $\sigma \subseteq W_{\mathfrak{A}} \times W_{\mathfrak{B}}$  exists,  $W_{\mathfrak{A}}$  is a finite tree, and  $w \sigma w'$ , then there is a partial immersion  $\sigma': W_{\mathfrak{A}} \rightarrow W_{\mathfrak{B}}$  such that  $w \in \text{dom}(\sigma')$  and  $w' = \sigma'(w)$ .*

*Proof.* By a straightforward induction on the depth of  $w \in W_{\mathfrak{A}}$  we show that if  $w \sigma w'$  then there is a partial immersion  $\sigma_w$  with  $w \in \text{dom}(\sigma_w)$ , whose domain is the subtree generated by  $w$ , and such that  $\sigma_w(w) = w'$ . Let  $D$  be set of daughters of  $w$ , and for each  $v \in D$ , choose  $v'$  so that  $v \sigma v'$  and  $w' \leq_{\mathfrak{B}} v'$ . By the induction hypothesis, there is a partial immersion  $\sigma'_v$  with  $v \in \text{dom}(\sigma'_v)$ . Then, one readily checks that  $\{(w, w')\} \cup \bigcup_{v \in D} \sigma'_v$  is also an immersion, as needed.  $\square$

Condensations are useful for producing (small) quasimodels out of models.

**Proposition 7.** *Given an intuitionistic model  $\mathfrak{M} = (W_{\mathfrak{M}}, \leq_{\mathfrak{M}}, V_{\mathfrak{M}})$ , a set  $\Sigma \in \mathbb{L}_{\square, \cup}$ , and a  $\wp(\Sigma)$ -labelled poset  $\mathfrak{A} = (W_{\mathfrak{A}}, \leq_{\mathfrak{A}}, \lambda_{\mathfrak{A}})$  over  $\Sigma$ , if  $\mathfrak{A} \ll \mathfrak{M}$ , then  $\mathfrak{A}$  is a quasimodel.*

*Proof.* Let  $(\rho, \iota)$  be a condensation from  $\mathfrak{M}^{\Sigma}$  to  $\mathfrak{A}$ . If  $w \leq_{\mathfrak{A}} v$ , then  $\iota(w) \leq_{\mathfrak{M}} \iota(v)$ , so that  $\lambda_{\mathfrak{A}}(w) = \Sigma(\iota(w)) \subseteq \Sigma(\iota(v)) = \lambda_{\mathfrak{A}}(v)$ . Next, suppose that  $\varphi \rightarrow \psi \in \lambda_{\mathfrak{A}}(w)$ , and consider  $v$  such that  $w \leq_{\mathfrak{A}} v$ . Then,  $\mathfrak{M}, \iota(w) \models \varphi \rightarrow \psi$ . Since  $\iota$  is an immersion,  $\iota(w) \leq_{\mathfrak{M}} \iota(v)$ , hence if  $\mathfrak{M}, \iota(v) \models \varphi$ , then also  $\mathfrak{M}, \iota(v) \models \psi$ . Thus if  $\varphi \in \lambda_{\mathfrak{A}}(v)$ , it follows that  $\psi \in \lambda_{\mathfrak{A}}(v)$ . Finally, suppose that  $\varphi \rightarrow \psi \in \Sigma \setminus \lambda_{\mathfrak{A}}(w)$ . Then,  $\mathfrak{M}, \iota(w) \not\models \varphi \rightarrow \psi$ , so that there is  $v \in W_{\mathfrak{M}}$  such that  $\iota(w) \leq_{\mathfrak{M}} v$ ,  $\mathfrak{M}, v \models \varphi$  and  $\mathfrak{M}, v \not\models \psi$ . It follows that  $\varphi \in \lambda_{\mathfrak{A}}(\rho(v))$  and  $\psi \notin \lambda_{\mathfrak{A}}(\rho(v))$ , and since  $\rho$  is an immersion we also have that  $w = \rho(\iota(w)) \leq_{\mathfrak{A}} \rho(v)$ , as needed.  $\square$

### 5.3 Normalized labelled trees

In order to count the number of different labelled trees up to bimerision, we construct, for any set  $\Lambda$  of labels and any  $k \geq 1$ , the labelled directed acyclic graph  $\mathfrak{G}_k^\Lambda = (W_k^\Lambda, \uparrow_k^\Lambda, \lambda_k^\Lambda)$  by induction on  $k$  as follows.

**Base case.** For  $k = 1$ , let  $\mathfrak{G}_1^\Lambda = (W_1^\Lambda, \uparrow_1^\Lambda, \lambda_1^\Lambda)$  with  $W_1^\Lambda = \Lambda$ ,  $\uparrow_1^\Lambda = \emptyset$ , and  $\lambda_1^\Lambda(w) = w$  for all  $w \in W_1^\Lambda$ .

**Inductive case.** Suppose that  $\mathfrak{G}_k^\Lambda = (W_k^\Lambda, \uparrow_k^\Lambda, \lambda_k^\Lambda)$  has already been defined. Let us write  $X \sqcup Y$  for the disjoint union of  $X$  and  $Y$ . The graph  $\mathfrak{G}_{k+1}^\Lambda = (W_{k+1}^\Lambda, \uparrow_{k+1}^\Lambda, \lambda_{k+1}^\Lambda)$  is constructed such that:

$$\begin{aligned} W_{k+1}^\Lambda &= W_k^\Lambda \sqcup \tilde{W}_{k+1}^\Lambda, \text{ where } \tilde{W}_{k+1}^\Lambda = \Lambda \times \wp(W_k^\Lambda) \\ \uparrow_{k+1}^\Lambda &= \uparrow_k^\Lambda \cup \{((\ell, C), y) \in \tilde{W}_{k+1}^\Lambda \times W_k^\Lambda \mid y \in C\} \\ \lambda_{k+1}^\Lambda(w) &= \begin{cases} \lambda_k^\Lambda(w) & \text{if } w \in W_k^\Lambda \\ \ell & \text{if } w = (\ell, C) \in \tilde{W}_{k+1}^\Lambda \end{cases} \end{aligned}$$

Note that  $\mathfrak{G}_k^\Lambda = (W_k^\Lambda, \uparrow_k^\Lambda, \lambda_k^\Lambda)$  is typically not a tree, but we may unravel it to obtain one.

**Definition 11.** Given a labelled directed graph  $\mathfrak{G} = (W, \uparrow, \lambda)$  and  $w \in W$ , the unravelling of  $\mathfrak{G}$  from  $w$  is the labelled tree  $\text{ur}_w(\mathfrak{G}) = (\text{ur}_w(W), \text{ur}_w(\uparrow), \text{ur}_w(\lambda))$  such that  $\text{ur}_w(W)$  is the set of all the paths in  $\mathfrak{G}$  starting on  $w$ ,  $\xi \text{ur}_w(\uparrow) \zeta$  if and only if there is  $v \in W$  such that  $\zeta = \xi v$ , and  $\text{ur}_w(\lambda)(v_0 \dots v_n) = \lambda(v_n)$ .

**Proposition 8.** For any rooted labelled tree  $\mathfrak{T}$  over a set  $\Lambda$  of labels, if the level of  $\mathfrak{T}$  is finite then there is a condensation from  $\mathfrak{T}$  to  $\text{ur}_y(\mathfrak{G}_{\text{lev}(\mathfrak{T})}^\Lambda)$  for some  $y \in W_{\text{lev}(\mathfrak{T})}^\Lambda$ .

*Proof.* Let  $\mathfrak{T} = (W_{\mathfrak{T}}, \uparrow_{\mathfrak{T}}, \lambda_{\mathfrak{T}})$  be a labelled tree with root  $r$ . We write  $<_{\mathfrak{T}}$  for the transitive closure of  $\uparrow_{\mathfrak{T}}$  and  $\leq_{\mathfrak{T}}$  for the reflexive closure of  $<_{\mathfrak{T}}$ . The proof is by induction on the level  $n = \text{lev}(\mathfrak{T})$  of  $\mathfrak{T}$ . For  $n = 1$ , observe that this means that  $\lambda_{\mathfrak{T}}(w) = \lambda(r)$  for all  $w \in W_{\mathfrak{T}}$ . Let  $\rho = W_{\mathfrak{T}} \times \{\lambda_{\mathfrak{T}}(r)\}$  and  $\iota = \{(\lambda_{\mathfrak{T}}(r), r)\}$ . It can easily be checked that  $(\rho, \iota)$  is a condensation.<sup>2</sup> For  $n > 1$ , suppose the property holds for all rooted labelled trees  $\mathfrak{T}'$  such that  $\text{lev}(\mathfrak{T}') < n$ . Define the following sets:

$$\begin{aligned} N &= \{w \in W_{\mathfrak{T}} \mid \lambda_{\mathfrak{T}}(w) \neq \lambda_{\mathfrak{T}}(r) \text{ and for all } v < w, \lambda_{\mathfrak{T}}(v) = \lambda_{\mathfrak{T}}(r)\} \\ M &= \{w \in W \mid \text{for all } v \leq w, \lambda_{\mathfrak{T}}(v) = \lambda_{\mathfrak{T}}(r)\} \end{aligned}$$

Note that if  $w \in N$  then  $\text{lev}(w) < \text{lev}(r)$ , and therefore  $\text{lev}(w) < n$ ; hence by induction, there is a condensation  $(\rho'_w, \iota'_w)$  from the subgraph of  $\mathfrak{T}$  generated by  $w$  to  $\text{ur}_{y_w}(\mathfrak{G}_{n-1}^\Lambda)$  for some  $y_w \in W_{n-1}^\Lambda$ .

<sup>2</sup>Recall that as per our convention, this means that  $(\rho, \iota)$  is a condensation between the respective transitive closures.

Define  $s = (\lambda(r), \{y_w \mid w \in N\}) \in W_n^\Lambda$  and consider the unravelling  $\mathfrak{U} = (W_{\mathfrak{U}}, \uparrow_{\mathfrak{U}}, \lambda_{\mathfrak{U}})$  of  $\mathfrak{G}_n^\Lambda$  from  $s$ . Note that  $\text{ur}_{y_w}(\mathfrak{G}_{n-1}^\Lambda)$  embeds into  $\mathfrak{U}$  via the map  $\xi \mapsto s\xi$ , and with this we define  $\rho_w: W_{\mathfrak{T}} \rightarrow W_{\mathfrak{U}}$  by  $\rho_w = s\rho'_w$ , and similarly define  $\iota_w: W_{\mathfrak{U}} \rightarrow W_{\mathfrak{T}}$  by  $\iota_w(s\xi) = \iota'_w(\xi)$  (i.e.,  $\iota_w$  first removes the first element of a string and then applies  $\iota'_w$ ).

We then define

$$\begin{aligned} \rho &= (M \times \{s\}) \cup \bigcup_{w \in N} \rho_w, \\ \tilde{\iota} &= \{(s, r)\} \cup \bigcup_{w \in N} \iota_w. \end{aligned}$$

Then, it can readily be checked that  $\rho$  is an immersion from  $\mathfrak{T}$  to  $\mathfrak{U}$ ,  $\tilde{\iota}$  is a simulation from  $\mathfrak{U}$  to  $\mathfrak{T}$  and  $\tilde{\iota} \subseteq \rho^{-1}$ . Using Lemma 10, we can then choose an immersion  $\iota \subseteq \tilde{\iota}$ , so that  $(\rho, \iota)$  is a condensation from  $\mathfrak{T}$  to  $\mathfrak{U}$ .  $\square$

Finally, given  $n, k \in \mathbb{N}$  let us recursively define natural numbers  $E_k^n$  and  $Q_k^n$  by:

$$E_k^n = \begin{cases} 0 & \text{if } k = 0 \\ E_{k-1}^n + n2^{E_{k-1}^n} & \text{otherwise} \end{cases} \quad Q_k^n = \begin{cases} 0 & \text{if } k = 0 \\ 1 + E_{k-1}^n Q_{k-1}^n & \text{otherwise} \end{cases}$$

The following lemma can be proven by a straightforward induction, left to the reader.

**Lemma 11.** *For any finite set  $\Lambda$  with cardinality  $n$  and all  $k \in \mathbb{N}$ , 1. the size of  $\mathfrak{G}_k^\Lambda$  is bounded by  $E_k^n$ , and 2. the size of any unravelling of  $\mathfrak{G}_k^\Lambda$  is bounded by  $Q_k^n$ .*

From this and Proposition 8, we obtain the following:

**Theorem 4.** *1. Given a set of labels  $\Lambda$  and a  $\Lambda$ -labelled tree  $\mathfrak{T}$  of level  $k < \omega$ , there is a  $\Lambda$ -labelled tree  $\mathfrak{T}'$  bounded by  $Q_k^{|\Lambda|}$  such that  $\mathfrak{T}' \cong \mathfrak{T}$ . We call  $\mathfrak{T}'$  the normalized  $\Lambda$ -labelled tree for  $\mathfrak{T}$ .*

*2. Given a sequence of  $\Lambda$ -labelled trees  $\mathfrak{T}_1, \dots, \mathfrak{T}_n$  of level  $k < \omega$  with  $n > E_k^{|\Lambda|}$ , there are indexes  $i < j \leq n$  such that  $\mathfrak{T}_i \cong \mathfrak{T}_j$ .*

*Proof.* In view of Proposition 8, we may take  $\mathfrak{T}$  to be a suitable unravelling of  $\mathfrak{G}_k^\Lambda$ , establishing the first claim. For the second, by Lemma 11,  $\mathfrak{G}_k^\Lambda$  has size at most  $E_k^{|\Lambda|}$ . Since the unravellings of any graph are determined by their starting point, there must be  $i < j \leq n$  with  $\mathfrak{T}_i$  and  $\mathfrak{T}_j$  bimersive to the same unravelling of  $\mathfrak{G}_k^\Lambda$ , from which it follows that  $\mathfrak{T}_i$  and  $\mathfrak{T}_j$  are bimersive.  $\square$

The second item may be viewed as a finitary variant of Kruskal's theorem for labelled trees [28]. When applied to quasimodels, we obtain the following:

**Proposition 9.** *Let  $\Sigma \in \mathbb{L}_{\square \cup}$  with  $|\Sigma| = s < \omega$ .*

1. Given a tree-like  $\Sigma$ -quasimodel  $\mathfrak{T}$ , there is a tree-like  $\Sigma$ -quasimodel  $\mathfrak{T}' \triangleq_{\Sigma} \mathfrak{T}$  bounded by  $Q_{s+1}^{2^s}$ . We call  $\mathfrak{T}'$  the normalized  $\Sigma$ -quasimodel for  $\mathfrak{T}$ .
2. Given a sequence of tree-like  $\Sigma$ -quasimodels  $\mathfrak{T}_1, \dots, \mathfrak{T}_n$  with  $n > E_{s+1}^{2^s}$ , there are indexes  $i < j \leq n$  such that  $\mathfrak{T}_i \triangleq \mathfrak{T}_j$ .

*Proof.* Immediate from Proposition 7 and Theorem 4 using the fact that any  $\Sigma$ -quasimodel has level at most  $s + 1$ .  $\square$

Finally, we obtain an analogous result for pointed structures.

**Definition 12.** A pointed labelled poset is a structure  $(W, \leq, \lambda, w)$  consisting of a labelled tree with a designated world  $w \in W$ . Given a labelled poset  $\mathfrak{A} = (W_{\mathfrak{A}}, \leq_{\mathfrak{A}}, \lambda_{\mathfrak{A}})$  and  $w \in W_{\mathfrak{A}}$ , we denote by  $\mathfrak{A}^w$  the pointed labelled poset given by  $\mathfrak{A}^w = (W_{\mathfrak{A}}, \leq_{\mathfrak{A}}, \lambda_{\mathfrak{A}}, w)$ . A pointed simulation between pointed labelled posets  $\mathfrak{A} = (W_{\mathfrak{A}}, \leq_{\mathfrak{A}}, \lambda_{\mathfrak{A}}, w_{\mathfrak{A}})$  and  $\mathfrak{B} = (W_{\mathfrak{B}}, \leq_{\mathfrak{B}}, \lambda_{\mathfrak{B}}, w_{\mathfrak{B}})$  is a simulation  $\sigma \subseteq W_{\mathfrak{A}} \times W_{\mathfrak{B}}$  such that if  $w \sigma v$ , then  $w = w_{\mathfrak{A}}$  if and only if  $v = w_{\mathfrak{B}}$ . The notions of pointed immersion, pointed condensation, etc. are defined analogously to Definition 10.

**Lemma 12.** If  $\Lambda$  has  $n$  elements, any pointed  $\Lambda$ -labelled poset of level at most  $k$  condenses to a labelled pointed tree bounded by  $Q_{k+2}^{2n}$ , and there are at most  $E_{k+2}^{2n}$  bimerision classes.

*Proof.* We may view a pointed labelled poset  $\mathfrak{A} = (W, \leq, \lambda, w)$  as a (non-pointed) labelled poset as follows. Let  $\Lambda' = \Lambda \times \{0, 1\}$ . Then, set  $\lambda'(v) = (\lambda(v), 0)$  if  $v \neq w$ ,  $\lambda'(w) = (\lambda(w), 1)$ . Note that if  $\mathfrak{A}$  had level  $k$  according to  $\lambda$  it may now have level  $k + 2$  according to  $\lambda'$ , since if  $u < w < v$  we may have that  $\lambda(u) = \lambda(w) = \lambda(v)$  yet  $\lambda'(u) \neq \lambda'(w)$  and  $\lambda'(w) \neq \lambda'(v)$ . By Proposition 8,  $\mathfrak{A}$  condenses to a generated tree  $\mathfrak{T}$  of  $\mathfrak{G}_{k+2}^{\Lambda'}$  by some condensation  $(\rho, \iota)$ . Let  $w' = \rho(w)$ , and consider  $\mathfrak{T}$  as a pointed structure with distinguished point  $w'$ . Given that  $\rho$  is a surjective, label-preserving function,  $w, w'$  are the only points whose label has second component 1, and therefore  $(\rho, \iota)$  must be a pointed condensation, as claimed.  $\square$

With this we may give an analogue of Proposition 9 tailored for pointed quasimodels. Its proof is essentially the same.

**Proposition 10.** Let  $\Sigma \in \mathbf{L}_{\square \cup}$  with  $|\Sigma| = s$ .

1. Given a tree-like pointed  $\Sigma$ -quasimodel  $\mathfrak{T}$  and a formula  $\varphi$ , there is a tree-like pointed  $\Sigma$ -quasimodel  $\mathfrak{T}' \triangleq \mathfrak{T}$  bounded by  $Q_{s+3}^{2^{s+1}}$ . We call  $\mathfrak{T}'$  the normalized pointed  $\Sigma$ -quasimodel for  $\mathfrak{T}$ .
2. Given a sequence of tree-like pointed  $\Sigma$ -quasimodels  $\mathfrak{T}_1, \dots, \mathfrak{T}_n$  with  $n > E_{s+3}^{2^{s+1}}$ , there are indexes  $i < j \leq n$  such that  $\mathfrak{T}_i \triangleq \mathfrak{T}_j$ .

With these tools at hand, we are ready to prove that  $\text{ITL}^e$  has the effective finite model property, and hence is decidable.

## 6 The Finite Model Property

In view of Proposition 5, in order to show that validity over  $L$  is decidable, it suffices to prove that validity is decidable over  $L_{\square\cup}$ . Thus in this section we will restrict our attention to this sub-language. We will use the notions of *eventuality* and *fulfilment*, defined below (see also Figure 6).

**Definition 13.** *Given a model  $\mathfrak{M}$ , an eventuality in  $\mathfrak{M}$  is a pair  $(w, \varphi)$ , where  $w \in W$  and  $\varphi$  is a formula such that either  $\varphi = \square\psi$  for some formula  $\psi$  and  $\mathfrak{M}, w \not\models \varphi$ , or  $\varphi = \psi \cup \chi$  for some formulas  $\psi$  and  $\chi$  and  $\mathfrak{M}, w \models \varphi$ . The fulfilment of an eventuality  $(w, \varphi)$  is the finite sequence  $v_0 \dots v_n$  of states of the model such that*

1. for all  $k \leq n$ ,  $v_k = S^k(w)$ ,
2. if  $\varphi = \square\psi$  then
  - (a)  $\mathfrak{M}, v_n \not\models \psi$  (the end condition for  $\varphi$ ) and
  - (b) for all  $k < n$ ,  $\mathfrak{M}, v_k \models \psi$  (the progressive condition for  $\varphi$ ), and
3. if  $\varphi = \psi \cup \chi$  then
  - (a)  $\mathfrak{M}, v_n \models \chi$  (the end condition for  $\varphi$ ) and
  - (b) for all  $k < n$ ,  $\mathfrak{M}, v_k \models \psi$  and  $\mathfrak{M}, v_k \not\models \chi$  (the progressive condition for  $\varphi$ ).

We call  $n$  the fulfilment time of  $(w, \varphi)$ . Given a set of formulas  $\Sigma$ , the fulfilment time of  $w$  with respect to  $\Sigma$  is the supremum of all fulfilment times of any eventuality  $(w, \varphi)$  with  $\varphi \in \Sigma$ , and if  $U$  is a set of worlds or eventualities, the fulfilment time of  $U$  with respect to  $\Sigma$  is the supremum of all fulfilment times with respect to  $\Sigma$  of all elements of  $U$ .

The idea is to replace an arbitrary stratified model  $\mathfrak{M}$  by a related model  $\mathfrak{M}'$  where all eventualities of  $\mathfrak{M}'_0$  are realized in effective time. From such a model  $\mathfrak{M}'$  we can then extract an effectively bounded finite model  $\mathfrak{M}^{a \leftarrow b}$ . The model  $\mathfrak{M}'$  is a ‘good’ model, defined as follows.

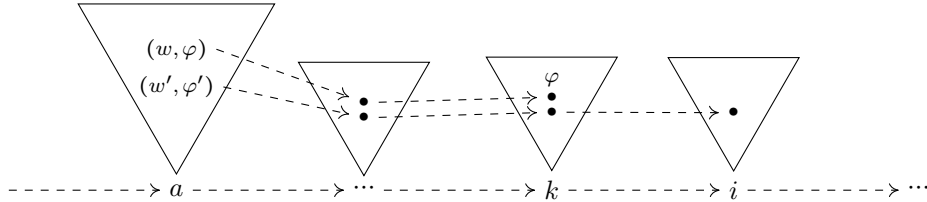

Figure 6: The stratum  $\mathfrak{M}_a$  and two of its eventualities. The fulfilment of  $(w, \varphi)$  is displayed, as well as the initial portion of the fulfilment of  $(w', \varphi')$ .



**Definition 14.** Let  $\Sigma \in \mathbf{L}_{\square\cup}$ ,  $s = |\Sigma|$  and  $a, b$  be natural numbers. An expanding model  $\mathfrak{M}$  is good (with parameters  $a, b$ , relative to  $\Sigma$ ) if

1.  $a < b \leq 2E_{n+1}^{2^{n+1}} + Q_{n+1}^{2^n} E_{n+3}^{2^{n+1}}$ ,
2.  $\mathfrak{M}_a \hat{=}_{\Sigma} \mathfrak{M}_b$ ,
3.  $W_a$  has fulfillment time less than  $b - a$ , and
4. for all  $c < b$ ,  $\mathfrak{M}_c$  is bounded by  $Q_{s+3}^{2^{s+1}}$ .

The bound (1) will naturally arise throughout our construction, but the only relevance is that it is computable. We construct  $\mathfrak{M}'$  as a speedup of  $\mathfrak{M}$ , in a sense that we make precise next.

**Definition 15.** Let  $\Sigma \in \mathbf{L}_{\square\cup}$ ,  $\mathfrak{M}, \mathfrak{N}$  be stratified models, and  $a \leq b' \leq b$  be natural numbers. We say that  $\mathfrak{N}$  is a speedup of  $\mathfrak{M}$  from  $a$  taking  $b$  to  $b'$  if for all  $i \leq a$   $\mathfrak{N}_i = \mathfrak{M}_i$  and for all  $i \geq b'$   $\mathfrak{N}_i = \mathfrak{M}_{i+b-b'}$ . We say that  $\mathfrak{N}$  is a strict speedup of  $\mathfrak{M}$  if  $b' < b$ . We may omit mention of the parameters if we wish to leave them unspecified, e.g.  $\mathfrak{N}$  is a speedup of  $\mathfrak{M}$  from  $a$  if there exist  $b, b'$  such that  $\mathfrak{N}$  is a speedup of  $\mathfrak{M}$  from  $a$  taking  $b$  to  $b'$ .

Then, the following speedups are defined for any stratified model  $\mathfrak{M} = (W, \leq, S, V)$  and any finite, non-empty set of formulas  $\Sigma$  closed under subformulas. In each case, if  $\mathfrak{M} = (W, \leq, S, V)$  is a stratified model, we will produce another stratified model  $\mathfrak{M}' = (W', \leq', S', V')$  and a map  $\pi: W' \rightarrow W$  such that  $\Sigma_{\mathfrak{M}}(\pi(w)) = \Sigma_{\mathfrak{M}'}(w)$  for all  $w \in W'$ . Below, recall that  $\mathfrak{M}_k = (W_k, \leq_k, S_k, V_k)$  denotes the  $k^{\text{th}}$  stratum of  $\mathfrak{M}$ .

- (SU1) Replace  $\mathfrak{M}_k$  with a copy of the normalized  $\Sigma$ -quasimodel of  $\mathfrak{M}_k$ , where  $k \geq 0$ . Let  $\mathfrak{T} = (W_{\mathfrak{T}}, \uparrow_{\mathfrak{T}}, \lambda_{\mathfrak{T}})$  be a copy of the normalized labelled tree of  $\mathfrak{M}_k^{\Sigma}$  such that  $W_{\mathfrak{T}} \cap W = \emptyset$ , and  $(\rho, \iota)$  the condensation from  $\mathfrak{M}_k^{\Sigma}$  to  $\mathfrak{T}$ . The result of the transformation is the tuple  $(W', \leq', S', V')$  such that  $W' = (W \setminus W_k) \cup W_{\mathfrak{T}}$ ,  $\leq' = \leq \downarrow_{W \setminus W_k} \cup (\uparrow_{\mathfrak{T}})^*$ ,

$$S'(w) = \begin{cases} \rho(S(w)) & \text{if } w \in W_{k-1} \\ S(\iota(w)) & \text{if } w \in W_{\mathfrak{T}} \\ S(w) & \text{otherwise} \end{cases} \quad V'(w) = \begin{cases} \lambda_{\mathfrak{T}}(w) \cap \mathbb{P} & \text{if } w \in W_{\mathfrak{T}} \\ V(w) & \text{otherwise} \end{cases}$$

The map  $\pi$  is the identity on  $W'_i = W_i$  for  $i \neq k$ , and  $\pi(w) = \iota(w)$  for  $w \in W_{\mathfrak{T}}$ .

- (SU2) Replace  $(\mathfrak{M}_k, w)$  with a copy of its normalized, pointed  $\Sigma$ -quasimodel, where  $k \geq 0$  and  $w \in W_k$ . The transformation is similar to the previous one except that  $(\mathfrak{M}_k, w)$  is regarded as a pointed structure with distinguished point  $w$ .

- (SU3) Replace  $\mathfrak{M}_\ell$  with  $\mathfrak{M}_k$ , where  $k < \ell$  and there is an immersion  $\sigma: W_k \rightarrow W_\ell$  (seen as  $\wp(\Sigma)$ -labelled trees). The result of the transformation is the tuple  $(W', \leq', S', V')$  such that  $W' = W \setminus \bigcup_{k < m \leq \ell} W_m$ ,  $\leq' = \leq \downarrow_{W'}$ ,

$$S'(w) = \begin{cases} S(\sigma(w)) & \text{if } S(w) \in W_k \\ S(w) & \text{otherwise} \end{cases}$$

and  $V' = V \downarrow_{W'}$ .

The map  $\pi$  is the identity on  $W'_i = W_i$  for  $i < k$ , on  $W'_i = W_{i+\ell-k}$  for  $i > k$ , and  $\pi(w) = \sigma(w)$  for all  $w \in W'_k$ .

- (SU4) Replace  $(\mathfrak{M}_\ell, w_\ell)$  with  $(\mathfrak{M}_k, w_k)$ , where  $k < \ell$ ,  $w_k \in W_k$ ,  $w_\ell \in W_\ell$  and there is an immersion  $\sigma: W_k \rightarrow W_\ell$  such that  $\sigma(w_k) = w_\ell$ . The transformation is defined as the previous one.

**Lemma 13.** *Let  $a < k < \ell \leq b$  be natural numbers and suppose that  $\mathfrak{M}$  is such that one of the transformations (SU1)-(SU4) applies. Then, the result  $\mathfrak{M}'$  is a speedup of  $\mathfrak{M}$  between  $a$  and  $b$  such that  $\Sigma_{\mathfrak{M}}(\pi(w)) = \Sigma_{\mathfrak{M}'}(w)$  for any  $w \in W'$ . In the cases (SU3) and (SU4), the speedup is strict.*

*Proof.* The proof that  $\mathfrak{M}' = (W', \leq', S', V')$  is a speedup of  $\mathfrak{M} = (W, \leq, S, V)$  consists of checking that Definition 15 applies and is left to the reader. We prove by structural induction on  $\varphi$  that for all transformations, all  $w \in W'$  and all  $\varphi \in \Sigma$ ,  $\mathfrak{M}', w \models \varphi$  iff  $\mathfrak{M}, \pi(w) \models \varphi$ .

We only detail the case for  $\varphi = \circ\psi$  in the sub-case when  $\mathfrak{M}_k$  is replaced with a copy of the normalized  $\Sigma$ -quasimodel  $\mathfrak{T}$  of  $\mathfrak{M}_k$  and  $w \in W'_{k-1}$ . Suppose that  $w \in W'_{k-1}$  and  $\mathfrak{M}, \pi(w) \models \circ\psi$ . Then  $\psi \in \Sigma_{\mathfrak{M}}(S\pi(w))$ . Since  $S'(w) = \rho S\pi(w)$ ,  $\pi S'(w) = \iota S'(w)$  and  $(\rho, \iota)$  is a condensation,  $\Sigma_{\mathfrak{M}}(S\pi(w)) = \lambda_{\mathfrak{T}}(S'(w)) = \Sigma_{\mathfrak{M}}(\pi S'(w))$ . In particular  $\psi \in \Sigma_{\mathfrak{M}}(\pi S'(w))$ , so that  $\mathfrak{M}, \pi S'(w) \models \psi$ . By induction hypothesis,  $\mathfrak{M}', S'(w) \models \psi$ . Hence  $\mathfrak{M}', w \models \circ\psi$ . The other direction is similar.

The remaining two sub-cases for  $\varphi = \circ\psi$  are when  $w \in W'_k$  and when  $w \notin W'_{k-1} \cup W'_k$ , both of which are treated similarly. The cases for the other temporal modalities also follow from similar considerations (see also the proof of Lemma 20). The cases for the implication are similar to those in the proof of Proposition 7, and the remaining cases are straightforward. We leave the details to the reader.  $\square$

The purpose of the transformations (SU2) and (SU4) is to preserve fulfillments of formulas. We make this precise in the next lemma.

**Lemma 14.** *Let  $\Sigma \in \mathbb{L}_{\square\cup}$ ,  $\mathfrak{M} = \mathfrak{M} = (W, \leq, S, V)$  be a stratified model,  $a, k \in \mathbb{N}$  with  $k > 0$ , and  $w \in W_a$ . Suppose that  $\varphi \in \Sigma$  is such that  $(w, \varphi)$  is an eventuality of  $\mathfrak{M}$  with fulfillment  $w = w_0, \dots, w_n$ .*

1. *If  $k \leq n$  and  $\mathfrak{M}'$  is obtained by replacing  $(\mathfrak{M}_{a+k}, w_k)$  by  $(\mathfrak{T}, v)$ , then  $(w, \varphi)$  is an eventuality of  $\mathfrak{M}'$  and the fulfillment of  $(w, \varphi)$  is  $v_0, \dots, v_n$  with  $v_k = v$  and otherwise  $v_i = w_i$ .*

2. If  $k < \ell \leq n$  and  $\mathfrak{M}'$  is obtained by replacing  $(\mathfrak{M}_{a+\ell}, w_\ell)$  by  $(\mathfrak{M}_{a+k}, w_k)$ , then  $(w, \varphi)$  is an eventuality of  $\mathfrak{M}'$  and the fulfillment of  $(w, \varphi)$  is  $w_0, \dots, w_k, w_{\ell+1}, \dots, w_n$ .

The proof is straightforward and left to the reader. In the next few lemmas we show that models can always be sped up so that fulfillment times are effectively bounded.

**Lemma 15.** Fix  $\Sigma \in \mathbb{L}_{\square U}$  with  $s = |\Sigma|$  and let  $\mathfrak{M}$  be any stratified model and  $a < b$  be natural numbers. Then there is a speedup of  $\mathfrak{M}'$  of  $\mathfrak{M}$  from  $a$  taking  $b$  to some  $b' \leq a + E_{s+1}^{2^s}$ , and such that  $\mathfrak{M}'_i$  is bounded by  $Q_{s+1}^{2^s}$  for all  $i \in (a, b')$ .

*Proof.* Let  $b'$  be minimal such that some model  $\mathfrak{N}$  is a speedup of  $\mathfrak{M}$  from  $a$  taking  $b$  to  $b'$ . We claim that  $b' \leq a + E_{s+1}^{2^s}$ ; for otherwise, by Theorem 4.2 there are natural numbers  $i, j$  with  $a < i < j \leq b'$  such that  $\mathfrak{N}_i \triangleq_\Sigma \mathfrak{N}_j$ , and hence we can apply a transformation (SU3) to obtain some speedup  $\mathfrak{N}'$  of  $\mathfrak{N}$  from  $a$  taking  $b'$  to some  $b'' < b'$ ; but then clearly  $\mathfrak{N}'$  is also a speedup of  $\mathfrak{M}$  from  $a$  taking  $b$  to  $b''$  and  $b'' < b'$ , a contradiction.

Thus  $b' \leq a + E_{s+1}^{2^s}$ , and finally we obtain  $\mathfrak{M}'$  by replacing each  $\mathfrak{N}_x$  with  $x \in (a, b')$  by its normalized  $\Sigma$ -quasimodel, which by Proposition 9 is bounded by  $Q_{s+1}^{2^s}$ .  $\square$

**Lemma 16.** Fix a finite set  $\Sigma \in \mathbb{L}_{\square U}$  with  $s = |\Sigma|$  and let  $\mathfrak{M} = (W, \leq, S, V)$  be any stratified model,  $a \in \mathbb{N}$ , and  $U \subseteq W_a \times \Sigma$  be a finite set of eventualities. Then there is a speedup  $\mathfrak{N}$  of  $\mathfrak{M}$  from  $a$  such that the fulfillment time  $\ell$  of  $U$  in  $\mathfrak{N}$  satisfies

1.  $\ell \leq |U|E_{s+3}^{2^{s+1}}$ , and
2. for all  $x \in [1, \ell - a]$ ,  $\mathfrak{N}_{a+x}$  is bounded by  $Q_{s+3}^{2^{s+1}}$ .

*Proof.* By induction on  $|U|$ . The claim is vacuously true if  $U = \emptyset$ . Otherwise, let  $n + 1 = |U|$  and  $(w, \varphi) \in U$  and assume inductively that a speedup  $\mathfrak{M}'$  of  $\mathfrak{M}$  from  $a$  is given so that the fulfillment time of  $U \setminus \{(w, \varphi)\}$  in  $\mathfrak{M}'$  is  $\ell \leq nE_{s+3}^{2^{s+1}}$  and for all  $x < \ell - a$ ,  $\mathfrak{N}_{a+1+x}$  is bounded by  $Q_{s+3}^{2^{s+1}}$ .

Let  $\mathfrak{N}$  be a speedup of  $\mathfrak{M}'$  from  $a + \ell$  chosen so that the fulfillment time  $r$  of  $(w, \varphi)$  in  $\mathfrak{N}$  is least among all such speedups. We claim that  $r \leq (n + 1)E_{s+3}^{2^{s+1}}$ . If not, let  $w_0, \dots, w_r$  be the fulfillment path for  $(w, \varphi)$ , and for  $x \in [1, r - \ell]$  let  $\mathfrak{N}_{\ell+x}^+$  be the pointed submodel  $(\mathfrak{N}_{\ell+x}, w_{\ell+x})$ . Note that  $r - \ell > E_{s+3}^{2^{s+1}}$ , so that by Proposition 10 there are  $x, y \in \mathbb{N}$  such that  $0 < x < y \leq r - \ell$  and  $\mathfrak{N}_{\ell+x}^+ \triangleq_\Sigma \mathfrak{N}_{\ell+y}^+$ . Thus we can apply a transformation (SU4) and replace  $\mathfrak{N}_{\ell+y}^+$  by  $\mathfrak{N}_{\ell+x}^+$  to obtain a speedup  $\mathfrak{N}'$  of  $\mathfrak{N}$ . By Lemma 14, the fulfillment of  $(w, \varphi)$  in  $\mathfrak{N}'$  is  $w_0, \dots, w_{\ell+x}, w_{\ell+y+1}, \dots, w_r$ , so that  $(w, \varphi)$  has fulfillment time  $r - (y - x)$ , contradicting the minimality of  $r$ .

Finally we define  $\mathfrak{N}'$  by replacing each  $(\mathfrak{N}_{\ell+x}, w_{\ell+x})$  with  $x \in [0, r - \ell]$  by its pointed, normalized  $\Sigma$ -quasimodel, which in view of Proposition 10 has size at most  $Q_{s+3}^{2^{s+1}}$  and by Lemma 14 preserves the fulfillment time of  $(w, \varphi)$ , as needed.  $\square$

In the next lemmas we construct a good model in three phases, each time obtaining more of the properties required by Definition 14. Below, if  $\Sigma \in \mathbb{L}_{\square\cup}$  and  $\mathfrak{M} = (W, \leq, S, V)$  is a stratified model and  $a \in \mathbb{N}$ , we say that  $\mathfrak{M}_a$  *occurs infinitely often (with respect to  $\Sigma$ )* if there are infinitely many values of  $i$  such that  $\mathfrak{M}_a \hat{=}_{\Sigma} \mathfrak{M}_i$ .

**Lemma 17.** *Let  $\Sigma \in \mathbb{L}_{\square\cup}$  and  $s = |\Sigma|$  and  $\varphi \in \Sigma$ . Then  $\varphi$  is satisfiable (falsifiable) over the class of expanding posets if and only if  $\varphi$  is satisfied (falsified) in an expanding model  $\mathfrak{M}$  for which there exists  $a \leq E_{s+1}^{2^s}$  such that*

1.  $\mathfrak{M}_a$  occurs infinitely often and
2. for all  $i \leq a$  the size of  $\mathfrak{M}_i$  is bounded by  $Q_{s+1}^{2^s}$ .

*Proof.* Suppose that  $\varphi$  is satisfiable (falsifiable). Then, by Theorem 1,  $\varphi$  is satisfied (falsified) on  $\mathfrak{N}_0$  for some stratified model  $\mathfrak{N}$ . By Proposition 9 there are finitely many  $\hat{=}_{\Sigma}$  equivalence classes, and hence there is some  $a'$  such that  $\mathfrak{N}_{a'}$  occurs infinitely often.

By Lemma 15 there is a speedup  $\mathfrak{M}'$  of  $\mathfrak{N}$  from 0 taking  $a'$  to some  $a \leq E_{s+1}^{2^s}$  and such that the size of  $\mathfrak{M}'_i$  is bounded by  $Q_{s+1}^{2^s}$  for all  $i \in (0, a)$ . It is then easy to see that  $\mathfrak{M}'_a$  occurs infinitely often in  $\mathfrak{M}'$ . Finally we define  $\mathfrak{M}$  by replacing  $\mathfrak{M}'_0$  and  $\mathfrak{M}'_a$  by their normalized  $\wp(\Sigma)$ -labelled trees, which by Proposition 9 have size at most  $Q_{s+1}^{2^s}$ .  $\square$

**Lemma 18.** *Let  $\Sigma \in \mathbb{L}_{\square\cup}$  with  $s = |\Sigma|$  and  $\varphi \in \Sigma$ . Then  $\varphi$  is satisfiable (falsifiable) over the class of dynamic posets if and only if  $\varphi$  is satisfied (falsified) in a stratified model  $\mathfrak{M}$  for which there exists  $a \leq E_{s+1}^{2^s}$  such that*

1.  $\mathfrak{M}_a$  occurs infinitely often,
2.  $W_a$  has fulfilment time  $r \leq sQ_{s+1}^{2^s}E_{s+3}^{2^{s+1}}$ , and
3. for all  $i \leq a + r$ ,  $\mathfrak{M}_i$  is bounded by  $Q_{s+3}^{2^{s+1}}$ .

*Proof.* In view of Lemma 17, we may assume that  $\varphi$  is satisfied (falsified) on  $\mathfrak{N}_0$  for some expanding model  $\mathfrak{N} = (W, \leq, S, V)$  satisfying the first condition and such that for all  $i \leq a$  the size of  $\mathfrak{M}_i$  is bounded by  $Q_{s+1}^{2^s}$ . Let  $U \subseteq W_a \times \Sigma$  be the set of all eventualities of  $\mathfrak{N}_a$ ; by Lemma 16 there is a speedup  $\mathfrak{M}'$  of  $\mathfrak{N}$  from  $a$  such that the realization time of  $\mathfrak{M}'_a$  is bounded by  $|U|E_{s+3}^{2^{s+1}}$  and such that  $\mathfrak{M}'_{a+1+i}$  is bounded by  $Q_{s+3}^{2^{s+1}}$  for all  $i < r$ . Clearly  $|U| \leq s|W_a| \leq sQ_{s+1}^{2^s}$ , giving us the second condition. Since for  $i \leq a$  we have that  $\mathfrak{M}_i$  is bounded by  $Q_{s+1}^{2^s} \leq Q_{s+3}^{2^{s+1}}$ , we obtain the third condition.  $\square$

Finally we are able to show that satisfiability and validity can be restricted to good models.

**Lemma 19.** *Let  $\Sigma \in \mathbb{L}_{\square\cup}$  with  $s = |\Sigma|$  and  $\varphi \in \Sigma$ . Then  $\varphi$  is satisfiable (falsifiable) over the class of expanding posets if and only if  $\varphi$  is satisfied (falsified) in a good model.*

*Proof.* We may begin with a model  $\mathfrak{M} = (W, \leq, S, V)$  satisfying all conditions of Lemma 18, where  $\mathfrak{N}_a$  occurs infinitely often and  $r$  is the realization time of  $W_a$ . Since  $\mathfrak{N}_a$  occurs infinitely often, we may choose  $b' > a + r$  such that  $\mathfrak{N}_a \triangleq_{\Sigma} \mathfrak{N}_{b'}$ . Then, by Lemma 15 there is a speedup  $\mathfrak{M}$  of  $\mathfrak{N}$  from  $a + r$  taking  $b'$  to some  $b \leq a + r + E_{s+1}^{2^{s+1}}$  and such that  $\mathfrak{M}_i$  is bounded by  $Q_{s+1}^{2^{s+1}}$  (and hence by  $Q_{s+3}^{2^{s+1}}$ ) for all  $i \in (a + r, b)$ . The model  $\mathfrak{M}$  then has all desired properties.  $\square$

**Definition 16.** Let  $\mathfrak{M}$  be an expanding model such that there is an immersion  $\sigma: W_b \rightarrow W_a$ . Then we define a new pointed model  $\mathfrak{M}^{a \leftarrow b} = (W^{a \leftarrow b}, \leq^{a \leftarrow b}, S^{a \leftarrow b}, V^{a \leftarrow b}, w_0^{a \leftarrow b})$  by setting  $W^{a \leftarrow b} = \bigcup_{0 \leq m < b} W_m$ ,  $\leq^{a \leftarrow b} = \leq \downarrow_{W^{a \leftarrow b}}$ ,

$$S^{a \leftarrow b}(w) = \begin{cases} \sigma(S(w)) & \text{if } w \in W_{b-1} \\ S(w) & \text{otherwise} \end{cases}$$

$V^{a \leftarrow b} = V \downarrow_{W^{a \leftarrow b}}$ , and  $w_0^{a \leftarrow b}$  to be the root of  $W_0$  (note that  $w_0^{a \leftarrow b} \in W^{a \leftarrow b}$ ).

The idea is to apply the operation  $\cdot^{a \leftarrow b}$  to good models, in which case the end result is a well-behaved finite model as described in the next lemma and Figure 7.

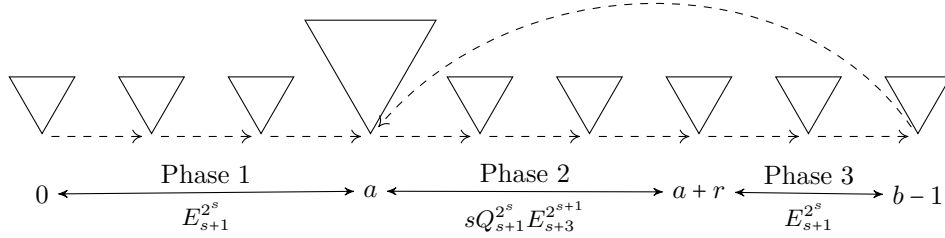

Figure 7: An illustration of the three phases of  $\mathfrak{M}^{a \leftarrow b}$  built from a good model. Below each phase we indicate the maximum number of strata, used for the computations in the proof of Lemma 21.

**Lemma 20.** If  $\mathfrak{M} = (W, \leq, S, V)$  is a good model with parameters  $a, b$  then  $\mathfrak{M}^{a \leftarrow b}$  is a model and  $\Sigma_{\mathfrak{M}^{a \leftarrow b}}(w) = \Sigma_{\mathfrak{M}}(w)$  for all  $w \in W^{a \leftarrow b}$ .

*Proof.* The proof that  $\mathfrak{M}^{a \leftarrow b} = (W^{a \leftarrow b}, \leq^{a \leftarrow b}, S^{a \leftarrow b}, V^{a \leftarrow b})$  is a model is straightforward and left to the reader. We prove by structural induction on  $\varphi$  that for all  $w \in W^{a \leftarrow b}$  and all  $\varphi \in \Sigma$ ,  $\mathfrak{M}^{a \leftarrow b}, w \models \varphi$  iff  $\mathfrak{M}, w \models \varphi$ . The cases for propositional variables and the Boolean connectives are straightforward. The case for the ‘next’ temporal modality is similar to that in the proof of Lemma 13.

For the ‘henceforth’ and ‘until’ temporal modalities, suppose first that  $(w, \varphi)$  is an eventuality in  $\mathfrak{M}$  and  $w \in W^{a \leftarrow b}$ . Let  $w_0 \dots w_n$  be the fulfilment of  $(w, \varphi)$  in  $\mathfrak{M}$ . If  $w_n \in W^{a \leftarrow b}$  then we can apply the induction hypothesis to see that each  $w_i$  for  $i \leq n$  satisfies the progressive and the end conditions for  $(w, \varphi)$  in  $\mathfrak{M}^{a \leftarrow b}$ :

if  $\varphi = \theta \cup \psi$  then  $\mathfrak{M}, w_n \models \psi$  and for all  $i < n$   $\mathfrak{M}, w_i \models \theta$  and  $\mathfrak{M}, w_i \not\models \psi$ , which by induction on formula length yields  $\mathfrak{M}^{a \leftarrow b}, w_n \models \psi$  and for all  $i < n$   $\mathfrak{M}^{a \leftarrow b}, w_i \models \theta$ . The case for  $\varphi = \square \psi$  is similar.

Otherwise, there is a least  $k \leq n$  such that  $w_k \in W_b$ . Therefore,  $(w_k, \varphi)$  is an eventuality in  $\mathfrak{M}$  and so is  $(\sigma(w_k), \varphi)$  since  $\sigma$  is an immersion. Since  $\mathfrak{M}$  is good, the length of the fulfilment of any eventuality  $(v, \varphi)$  such that  $v \in W_a$  is bounded by  $b - a$ . Thus by the previous case (where  $w_n \in W^{a \leftarrow b}$ ),  $(\sigma(w_k), \varphi)$  is an eventuality in  $\mathfrak{M}^{a \leftarrow b}$ . Let  $v_0, \dots, v_\ell$  be its fulfilment. Then it is not hard to see using the induction hypothesis that  $w_0, \dots, w_{k-1}, v_0, \dots, v_\ell$  is the fulfilment of  $(w, \varphi)$  in  $\mathfrak{M}^{a \leftarrow b}$ , witnessing that  $\mathfrak{M}^{a \leftarrow b}, w \models \varphi$ .

Conversely, suppose now that  $(w, \varphi)$  is an eventuality in  $\mathfrak{M}^{a \leftarrow b}$  and let  $w_0 \dots w_n$  be its fulfilment. For each  $k \leq n$  let  $m_k$  be such that  $w_k \in W_{m_k}$ . The proof is by a subinduction on  $n$ . For the base case we directly apply the induction hypothesis to  $w = w_n$ . If  $n > 0$  then first note that by the main induction hypothesis on  $\varphi$ , the sequence  $w_0 \dots w_n$  satisfies the progressive condition for  $(w, \varphi)$  on  $\mathfrak{M}$ .

Now consider two cases. If  $m_0 < b - 1$  then  $m_1 < b$ . The sub-induction hypothesis tells us that  $(w_1, \varphi)$  is an eventuality of  $\mathfrak{M}$ , and since  $\mathfrak{M}, w_0$  satisfies the progressive condition for  $(w, \varphi)$  it follows that  $(w, \varphi)$  is an eventuality of  $\mathfrak{M}$ .

Otherwise  $m_0 = b - 1$ , so that  $m_1 = a$ . The sub-induction hypothesis tells us that  $(w_1, \varphi)$  is an eventuality of  $\mathfrak{M}$ . Since  $w_1 = S^{a \leftarrow b}(w_0) = \sigma S(w_0)$  and  $\sigma$  is an immersion,  $(S(w_0), \varphi)$  is an eventuality in  $\mathfrak{M}$ . Therefore,  $(w, \varphi)$  is an eventuality in  $\mathfrak{M}$ .  $\square$

**Lemma 21.** *If  $\mathfrak{M}$  is a good model with parameters  $a, b$  and  $s = |\Sigma|$  then  $\mathfrak{M}^{a \leftarrow b}$  is bounded by*

$$B(s) := Q_{s+3}^{2^{s+1}} \left( 2E_{s+1}^{2^s} + sQ_{s+1}^{2^s} E_{s+3}^{2^{s+1}} \right)$$

*Proof.* This is immediate from the definition of  $W^{a \leftarrow b}$  and the bounds on good models (see Definition 14).  $\square$

We have proven the following effective finite model property for  $L_{\square \cup}$ ; however, since  $L$  maps effectively into  $L_{\square \cup}$ , this result applies to the full language.

**Theorem 5.** *There exists a computable function  $B$  such that for any formula  $\varphi \in L$ , if  $\varphi$  is satisfiable (resp. unsatisfiable) then  $\varphi$  is satisfiable (resp. falsifiable) in a model  $\mathfrak{M} = (W, \preceq, S, V)$  such that  $|W| \leq B(|\varphi|)$ .*

As a corollary, we get the decidability of  $ITL^e$ .

**Corollary 1.** *The satisfiability and validity problems for  $ITL^e$  are decidable.*

## 7 Bounded bisimulations for U and R

In this section we adapt the classical definition of bounded bisimulations for modal logic [4] to our case. To do so we combine the ordinary definition of bounded bisimulations with the work of [38] on bisimulations for propositional intuitionistic logic, which includes extra conditions involving the partial order  $\leq$ . In our setting, we combine both approaches in order to define bisimulation for a language involving  $\rightarrow$ ,  $\circ$ ,  $\mathbf{U}$  and  $\mathbf{R}$ , where the latter are adapted from bisimulations for a language with *until* and *since* [26] presented by Kurtonina and de Rijke [29]. Since all languages we consider contain Booleans and  $\circ$ , it is convenient to begin with a ‘basic’ notion of bisimulation for this language.

**Definition 17.** *Given  $n > 0$  and two  $\text{ITL}^e$  models  $\mathfrak{M}_1$  and  $\mathfrak{M}_2$ , a sequence of binary relations  $Z_n \subseteq \dots \subseteq Z_0 \subseteq W_1 \times W_2$  is said to be a bounded  $\circ$ -bisimulation if for all  $(w_1, w_2) \in W_1 \times W_2$  and for all  $0 \leq i < n$ , the following conditions are satisfied:*

**ATOMS.** *If  $w_1 Z_i w_2$  then for all propositional variables  $p$ ,  $\mathfrak{M}_1, w_1 \models p$  iff  $\mathfrak{M}_2, w_2 \models p$ .*

**FORTH  $\rightarrow$ .** *If  $w_1 Z_{i+1} w_2$  then for all  $v_1 \in W_1$ , if  $v_1 \succcurlyeq w_1$ , there exists  $v_2 \in W_2$  such that  $v_2 \succcurlyeq w_2$  and  $v_1 Z_i v_2$ .*

**BACK  $\rightarrow$ .** *If  $w_1 Z_{i+1} w_2$  then for all  $v_2 \in W_2$  if  $v_2 \succcurlyeq w_2$  then there exists  $v_1 \in W_1$  such that  $v_1 \succcurlyeq w_1$  and  $v_1 Z_i v_2$ .*

**FORTH  $\circ$ .** *if  $w_1 Z_{i+1} w_2$  then  $S(w_1) Z_i S(w_2)$ .*

Note that there is not ‘back’ clause for  $\circ$ ; this is simply because  $S$  is a function, so its ‘forth’ and ‘back’ clauses are identical. Bounded  $\circ$ -bisimulations are useful because they preserve the truth of relatively small  $L_\circ$ -formulas.

**Lemma 22.** *Given two  $\text{ITL}^e$  models  $\mathfrak{M}_1$  and  $\mathfrak{M}_2$  and a bounded  $\circ$ -bisimulation  $Z_n \subseteq \dots \subseteq Z_0$  between them, for all  $i \leq n$  and  $(w_1, w_2) \in W_1 \times W_2$ , if  $w_1 Z_i w_2$  then for all  $\varphi \in L_\circ$  satisfying<sup>3</sup>  $|\varphi| \leq i$ ,  $\mathfrak{M}_1, w_1 \models \varphi$  iff  $\mathfrak{M}_2, w_2 \models \varphi$ .*

*Proof.* We proceed by induction on  $i$ . Let  $0 \leq i \leq n$  be such that for all  $j < i$  the lemma holds. Let  $w_1 \in W_1$  and  $w_2 \in W_2$  be such that  $w_1 Z_i w_2$  and let us consider  $\varphi \in L_\circ$  such that  $|\varphi| \leq i$ . The cases where  $\varphi$  is an atom or of the forms  $\theta \wedge \psi$ ,  $\theta \vee \psi$  are as in the classical case and we omit them. Thus we focus on the following:

**CASE  $\varphi = \theta \rightarrow \psi$ .** We proceed by contrapositive to prove the left-to-right implication. Note that in this case we must have  $i > 0$ .

Assume that  $\mathfrak{M}_2, w_2 \not\models \theta \rightarrow \psi$ . Therefore there exists  $v_2 \in W_2$  such that  $v_2 \succcurlyeq w_2$ ,  $\mathfrak{M}_2, v_2 \models \theta$ , and  $\mathfrak{M}_2, v_2 \not\models \psi$ . By the **BACK  $\rightarrow$**  condition, it follows that there exists  $v_1 \in W_1$  such that  $v_1 \succcurlyeq w_1$  and  $v_1 Z_{i-1} v_2$ . Since  $|\theta|, |\psi| < i$ , by the induction hypothesis, it follows that  $\mathfrak{M}_1, v_1 \models \theta$  and  $\mathfrak{M}_1, v_1 \not\models \psi$ . Consequently,

<sup>3</sup>Although not optimal, we use the length of the formula in this lemma to simplify its proof. More precise measures like counting the number of modalities and implications could be equally used.

$\mathfrak{M}_1, w_1 \not\models \theta \rightarrow \psi$ . The converse direction is proved in a similar way but using FORTH  $\rightarrow$ .

CASE  $\varphi = \circ\psi$ . Once again we have that  $i > 0$ . Assume that  $\mathfrak{M}_1, w_1 \models \circ\psi$ , so that  $\mathfrak{M}_1, S(w_1) \models \psi$ . By FORTH  $\circ$ ,  $S_1(w_1) Z_{i-1} S_2(w_2)$ . Moreover,  $|\psi| \leq i - 1$ , so that by the induction hypothesis,  $\mathfrak{M}_2, S(w_2) \models \psi$ , and  $\mathfrak{M}_2, w_2 \models \circ\psi$ . The right-to-left direction is analogous.  $\square$

We will use bounded  $\circ$ -bisimulations as a basis to define bounded bisimulations for more powerful languages. The bisimulations we define below preserve formulas containing the ‘until’ operator.

**Definition 18.** *Given  $n \in \mathbb{N}$  and two  $\text{ITL}^e$  models  $\mathfrak{M}_1$  and  $\mathfrak{M}_2$ , a bounded  $\circ$ -bisimulation  $Z_n \subseteq \dots \subseteq Z_0 \subseteq W_1 \times W_2$  is said to be a bounded  $\cup$ -bisimulation iff for all  $(w_1, w_2) \in W_1 \times W_2$  and  $0 \leq i < n$  such that  $w_1 Z_{i+1} w_2$ :*

FORTH  $\cup$ . *For all  $k_1 \geq 0$  there exist  $k_2 \geq 0$  and  $(v_1, v_2) \in W_1 \times W_2$  such that*

1.  $S^{k_2}(w_2) \succcurlyeq v_2$ ,  $v_1 \succcurlyeq S^{k_1}(w_1)$  and  $v_1 Z_i v_2$ , and
2. for all  $j_2 \in [0, k_2)$  there exist  $j_1 \in [0, k_1)$  and  $(u_1, u_2) \in W_1 \times W_2$  such that  $u_1 \succcurlyeq S^{j_1}(w_1)$ ,  $S^{j_2}(w_2) \succcurlyeq u_2$  and  $u_1 Z_i u_2$ .

BACK  $\cup$ . *For all  $k_2 \geq 0$  there exist  $k_1 \geq 0$  and  $(v_1, v_2) \in W_1 \times W_2$  such that*

1.  $S^{k_1}(w_1) \succcurlyeq v_1$ ,  $v_2 \succcurlyeq S^{k_2}(w_2)$  and  $v_1 Z_i v_2$ , and
2. for all  $j_1 \in [0, k_1)$  there exist  $j_2 \in [0, k_2)$  and  $(u_1, u_2) \in W_1 \times W_2$  such that  $u_2 \succcurlyeq S^{j_2}(w_2)$ ,  $S^{j_1}(w_1) \succcurlyeq u_1$  and  $u_1 Z_i u_2$ .

As was the case before, the following lemma states that two bounded  $\cup$ -bisimilar models agree on small-enough  $L_\cup$  formulas.

**Lemma 23.** *Given two  $\text{ITL}^e$  models  $\mathfrak{M}_1$  and  $\mathfrak{M}_2$  and a bounded  $\cup$ -bisimulation  $Z_n \subseteq \dots \subseteq Z_0$  between them, for all  $m \leq n$  and  $(w_1, w_2) \in W_1 \times W_2$ , if  $w_1 Z_m w_2$  then for all  $\varphi \in L_\cup$  such that  $|\varphi| \leq m$ ,  $\mathfrak{M}_1, w_1 \models \varphi$  iff  $\mathfrak{M}_2, w_2 \models \varphi$ .*

*Proof.* Once again, proceed by induction on  $n$ . Let  $m \leq n$  be such that for all  $k < m$  the lemma holds. Let  $w_1 \in W_1$  and  $w_2 \in W_2$  be such that  $w_1 Z_m w_2$  and let us consider  $\varphi \in L_\cup$  such that  $|\varphi| \leq m$ . We only consider the new case, where  $\varphi = \theta \cup \psi$ . From left to right, assume that  $\mathfrak{M}_1, w_1 \models \theta \cup \psi$ . Then, there exists  $i_1 \geq 0$  such that  $\mathfrak{M}_1, S^{i_1}(w_1) \models \psi$  and for all  $j_1$  satisfying  $0 \leq j_1 < i_1$ ,  $\mathfrak{M}_1, S^{j_1}(w_1) \models \theta$ . By FORTH  $\cup$ , there exist  $i_2 \geq 0$  and  $(v_1, v_2) \in W_1 \times W_2$  such that 1.  $S^{i_2}(w_2) \succcurlyeq v_2$ ,  $v_1 \succcurlyeq S^{i_1}(w_1)$  and  $v_1 Z_{m-1} v_2$ ; 2. for all  $j_2$  satisfying  $0 \leq j_2 < i_2$  there exist  $j_1 \in [0, i_1)$  and  $(u_1, u_2) \in W_1 \times W_2$  s. t.  $u_1 \succcurlyeq S^{j_1}(w_1)$ ,  $S^{j_2}(w_2) \succcurlyeq u_2$  and  $u_1 Z_{m-1} u_2$ .

Since  $v_1 \succcurlyeq S^{i_1}(w_1)$  and  $\mathfrak{M}_1, S^{i_1}(w_1) \models \psi$ , by  $\preceq$ -monotonicity we see that  $\mathfrak{M}_1, v_1 \models \psi$ . Since  $|\psi| \leq m - 1$ , it follows from the induction hypothesis that  $\mathfrak{M}_2, v_2 \models \psi$ , and by  $\preceq$ -monotonicity,  $\mathfrak{M}_2, S^{i_2}(w_2) \models \psi$ .

Now take any  $j_2$  satisfying  $0 \leq j_2 < i_2$ . Using (2), the fact that  $|\theta| \leq m - 1$ , and the induction hypothesis, we may reason as above to conclude that  $\mathfrak{M}_2, S^{j_2}(w_2) \models \theta$  so  $\mathfrak{M}_2, w_2 \models \theta \cup \psi$ . The right-to-left direction is symmetric (but uses BACK  $\cup$ ).  $\square$



Finally, we define bounded bisimulations for ‘release’. The idea is similar as that for the ‘until’ operator.

**Definition 19.** A bounded  $\circ$ -bisimulation  $Z_n \subseteq \dots \subseteq Z_0 \subseteq W_1 \times W_2$  is said to be a bounded  $\mathbf{R}$ -bisimulation if for all  $(w_1, w_2) \in W_1 \times W_2$  and  $0 \leq i < n$  such that  $w_1 Z_{i+1} w_2$ :

FORTH  $\mathbf{R}$ . For all  $k_2 \geq 0$  there exist  $k_1 \geq 0$  and  $(v_1, v_2) \in W_1 \times W_2$  such that

1.  $S^{k_2}(w_2) \succcurlyeq v_2$ ,  $v_1 \succcurlyeq S^{k_1}(w_1)$  and  $v_1 Z_i v_2$ , and
2. for all  $j_1$  satisfying  $0 \leq j_1 < k_1$  there exist  $j_2$  such that  $0 \leq j_2 < k_2$  and  $(u_1, u_2) \in W_1 \times W_2$  s. t.  $u_1 \succcurlyeq S^{j_1}(w_1)$ ,  $S^{j_2}(w_2) \succcurlyeq u_2$  and  $u_1 Z_i u_2$ .

BACK  $\mathbf{R}$ . For all  $k_1 \geq 0$  there exist  $k_2 \geq 0$  and  $(v_1, v_2) \in W_1 \times W_2$  such that

1.  $S^{k_1}(w_1) \succcurlyeq v_1$ ,  $v_2 \succcurlyeq S^{k_2}(w_2)$  and  $v_1 Z_i v_2$ , and
2. for all  $j_2$  satisfying  $0 \leq j_2 < k_2$  there exist  $j_1$  such that  $0 \leq j_1 < k_1$  and  $(u_1, u_2) \in W_1 \times W_2$  s. t.  $u_2 \succcurlyeq S^{j_2}(w_2)$ ,  $S^{j_1}(w_1) \succcurlyeq u_1$  and  $u_1 Z_i u_2$ .

Once again, we obtain a corresponding bisimulation lemma for  $\mathbf{L}_R$ .

**Lemma 24.** Given two  $\text{ITL}^e$  models  $\mathfrak{M}_1$  and  $\mathfrak{M}_2$  and a bounded  $\mathbf{R}$ -bisimulation  $Z_n \subseteq \dots \subseteq Z_0$  between them, for all  $m \leq n$  and  $(w_1, w_2) \in W_1 \times W_2$ , if  $w_1 Z_m w_2$  then for all  $\varphi \in \mathbf{L}_U$  such that  $|\varphi| \leq m$ ,  $\mathfrak{M}_1, w_1 \models \varphi$  iff  $\mathfrak{M}_2, w_2 \models \varphi$ .

*Proof.* As before, we proceed by induction on  $n$ ; the critical case where  $\varphi = \theta \mathbf{R} \psi$  follows by reasoning similar to that of Lemma 23. Details are left to the reader.  $\square$

## 8 Definability and undefinability of modal operators

In this section, we explore the question of when the basic connectives can or cannot be defined in terms of each other. It is known that, classically,  $\diamond$  and  $\square$  are interdefinable, as are  $\mathbf{U}$  and  $\mathbf{R}$ ; we will see that this is not the case intuitionistically. On the other hand,  $\mathbf{U}$  (and hence  $\mathbf{R}$ ) is not definable in terms of  $\diamond, \square$  in the classical setting [26], and this result immediately carries over to the intuitionistic setting, as the class of classical LTL models can be seen as the subclass of that of dynamic posets by letting the partial order be the identity.

It is worth noting that interdefinability of modal operators can vary within intermediate logics. For example,  $\wedge, \vee$  and  $\rightarrow$  are basic connectives in propositional intuitionistic logic, but in the intermediate logic of here-and-there [22],  $\wedge$  is a basic operator [1, 3] as is  $\rightarrow$  [1] while  $\vee$  is definable in terms of  $\rightarrow$  and  $\wedge$  [32]. In first-order here-and-there [31], the quantifier  $\exists$  is definable in terms of  $\forall$  and  $\rightarrow$  [36]. In the modal case, Simpson [44] shows that modal operators are not interdefinable in the intuitionistic modal logic  $\mathbf{IK}$  and Balbiani and Diéguez [3]

proved that  $\Box$  is not definable in terms of  $\Diamond$  in the linear time temporal extension of here-and-there. This last proof is adapted here to show that  $\Box$  not definable in terms of  $\mathbf{U}$  in  $\text{ITL}^{\text{ht}}$  either. Note, however, that here we correct the claim of [3] stating that  $\Diamond$  is not here-and-there definable in terms of  $\Box$ , although we do show that  $\Diamond$  is not definable in terms of  $\mathbf{R}$  over the class of persistent models.

Let us begin by studying the definability of  $\Box$  in terms of  $\circ$  and  $\mathbf{U}$ . Recall that  $\mathbf{L}$  denotes the full language of intuitionistic temporal logic. If  $\mathbf{L}' \subseteq \mathbf{L}$ ,  $\varphi \in \mathbf{L}$  and  $\Omega$  is a class of models, we say that  $\varphi$  is  $\mathbf{L}'$ -definable over  $\Omega$  if there is  $\varphi' \in \mathbf{L}'$  such that  $\Omega \models \varphi \leftrightarrow \varphi'$ . Thus for example  $\Diamond p$  is  $\mathbf{L}_{\mathbf{U}}$ -definable; however, as we will see,  $\Box p$  is not.

We will show this by exhibiting models that are  $n$ - $\mathbf{U}$ -bisimilar for arbitrarily large  $n$ . To construct these models, it will be convenient to introduce some ad-hoc notation for cyclic groups. Recall that if  $a, b \in \mathbb{Z}$  we write  $a \mid b$  if there is  $k \in \mathbb{Z}$  such that  $b = ak$ , and  $a \equiv b \pmod{n}$  if  $n \mid (a - b)$ . Given  $n > 0$ , we will denote the cyclic group with  $n$  elements by  $\mathbb{Z}/(n)$ . We will identify it with the set  $\{1, \dots, n\}$ , and define  $[i]_n$  to be the unique  $j \in [1, n]$  such that  $i \equiv j \pmod{n}$ . Note that addition in  $\mathbb{Z}/(n)$  is given by  $[x + y]_n$ . With this, we are ready to show that  $\Box$  is not definable in terms of  $\mathbf{U}$ .

**Theorem 6.** *The formula  $\Box p$  is not  $\mathbf{L}_{\mathbf{U}}$ -definable, even over the class of finite here-and-there models.*

*Proof.* For  $n > 0$  consider a model  $\mathfrak{M}_n^{\Box} = (W, \leq, S, V)$  with  $W = (\mathbb{Z}/(n+2)) \times \{0, 1\}$ ,  $(i, j) \leq (i', j')$  if  $i = i'$  and  $j \leq j'$ ,  $S(i, j) = ([i+1]_{n+2}, j)$ , and  $V(n+2, 0) = \emptyset$ , otherwise  $V(i, j) = \{p\}$ . Clearly  $\mathfrak{M}_n^{\Box}$  is a here-and-there model. For  $m \leq n$ , let  $\sim_m$  be the least equivalence relation such that  $(i, j) \sim_m (i', j')$  whenever

$$\max\{i(1-j), i'(1-j')\} \leq n - m + 1$$

(see Figure 8). Then, it can easily be checked that  $\mathfrak{M}_n^{\Box}, (1, 0) \not\models \Box p$ ,  $\mathfrak{M}, (1, 1) \models \Box p$ , and  $(1, 0) \sim_m (1, 1)$ .

It remains to check that  $(\sim_m)_{m \leq n}$  is a bounded  $\mathbf{U}$ -bisimulation. The atoms,  $\rightarrow$  and  $\circ$  clauses are easily verified, so we focus on those for  $\mathbf{U}$ . Since  $\sim_m$  is symmetric, we only check FORTH  $\mathbf{U}$ . Suppose that  $(i_1, j_1) \sim_m (i_2, j_2)$ , and fix  $k_1 \geq 0$ . Let  $i' = [i_1 + k_1]_{n+2}$  and note that  $S^{k_1}(i_1, j_1) = (i', j_1)$ . Then, we can see that  $k_2 = 0$ ,  $v_1 = (i', 1)$  and  $v_2 = (i_2, j_2)$  witness that FORTH  $\mathbf{U}$  holds, where the intermediate condition for  $j_2 \in [0, k_2]$  holds vacuously since  $[0, k_2] = \emptyset$ .

By letting  $n = |\varphi|$ , we see using Lemma 23 that that no  $\mathbf{L}_{\mathbf{U}}$ -formula  $\varphi$  can be equivalent to  $\Box p$ .  $\square$

As a consequence:

**Corollary 2.** *The formula  $q \mathbf{R} p$  is not definable in terms of  $\circ$  and  $\mathbf{U}$ , even over the class of finite here-and-there models.*

*Proof.* If we could define  $q \mathbf{R} p$ , then we could also define  $\Box p \equiv \perp \mathbf{R} p$ .  $\square$

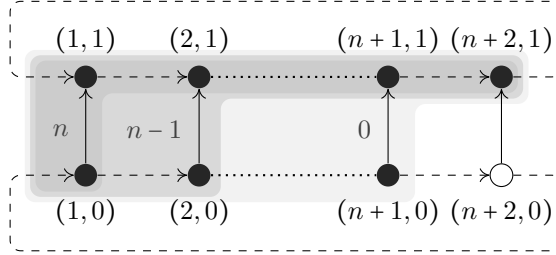

Figure 8: The here-and-there model  $\mathfrak{M}_n^\square$ . Black dots satisfy the atom  $p$ , white dots do not; all other atoms are false everywhere. Solid lines indicate  $\leq$  and dashed lines indicate  $S$ . The  $\sim_m$ -equivalence classes are shown as grey regions.

The situation is a bit different for  $\diamond$ , at least over the class of here-and-there models.

**Proposition 11.** *Over the class of here-and-there models,  $\diamond$  is  $L_\square$ -definable. To be precise, define formulas*

$$\begin{aligned}\alpha &= \square(p \rightarrow \square(p \vee \neg p)) \\ \beta &= \square(\square(p \vee \neg p) \rightarrow p \vee \neg p \vee \square\neg p) \\ \gamma &= \square(p \vee \neg p) \wedge \neg\square\neg p \\ \varphi &= (\alpha \wedge \beta) \rightarrow \gamma.\end{aligned}$$

Then,  $\diamond p$  is here-and-there equivalent to  $\varphi$ .

*Proof.* Let  $\mathfrak{M} = (T \times \{0, 1\}, \leq, S, V)$  be a here-and-there model with  $S(t, i) = (f(t), i)$  (see Section 4.2). First assume that  $x = (x_1, x_2)$  is such that  $\mathfrak{M}, x \models \diamond p$ . To check that  $\mathfrak{M}, x \models \varphi$ , let  $x' \geq x$ , and consider the following cases.

CASE  $\mathfrak{M}, x' \models \square(p \vee \neg p)$ . In this case, it is easy to see that we also have  $\mathfrak{M}, x' \models \neg\square\neg p$  given that  $\mathfrak{M}, x \models \diamond p$ , so  $\mathfrak{M}, x' \models \gamma$ .

CASE  $\mathfrak{M}, x' \not\models \square(p \vee \neg p)$ . Using the assumption that  $\mathfrak{M}, x \models \diamond p$ , choose  $k$  such that  $\mathfrak{M}, S^k(x) \models p$  and consider two sub-cases.

1. Suppose there is  $k' > k$  such that  $\mathfrak{M}, S^{k'}(x) \not\models p \vee \neg p$ . Then, it follows that

$$\mathfrak{M}, S^k(x') \not\models p \rightarrow \square(p \vee \neg p)$$

and hence  $\mathfrak{M}, x' \not\models \square(p \rightarrow \square(p \vee \neg p)) = \alpha$ .

2. If there is not such  $k'$ , then there must be a maximal  $k' < k$  such that  $\mathfrak{M}, S^{k'}(x') \not\models p \vee \neg p$  (otherwise, we would be in CASE  $\mathfrak{M}, x' \models \square(p \vee \neg p)$ ). Since  $k'$  is maximal,

$$\mathfrak{M}, S^{k'}(x') \models \square(p \vee \neg p),$$

and since  $k' < k$  and  $\mathfrak{M}, S^k(x') \not\models \neg p$ , we have that  $\mathfrak{M}, S^{k'}(x') \not\models \Box \neg p$ . It follows that

$$\mathfrak{M}, S^{k'}(x') \not\models \Box(p \vee \neg p) \rightarrow p \vee \neg p \vee \Box \neg p,$$

and therefore

$$\mathfrak{M}, x' \not\models \Box(\Box(p \vee \neg p) \rightarrow p \vee \neg p \vee \Box \neg p) = \beta.$$

Since  $x' \geq x$  was arbitrary,  $\mathfrak{M}, x \models (\alpha \wedge \beta) \rightarrow \gamma = \varphi$ .

Note that the above direction does not use any properties of here-and-there models, and works over arbitrary expanding models. However, we need these properties for the other implication. Suppose that  $\mathfrak{M}, x \models \varphi$ . If  $\mathfrak{M}, x \models \Box(p \vee \neg p) \wedge \neg \Box \neg p = \gamma$ , then it is readily verified that  $(\mathfrak{M}, x) \models \Diamond p$ . Otherwise,

$$\mathfrak{M}, x \not\models \alpha \wedge \beta.$$

If  $\mathfrak{M}, x \not\models \alpha = \Box(p \rightarrow \Box(p \vee \neg p))$ , then there is  $k$  such that

$$\mathfrak{M}, S^k(x) \not\models p \rightarrow \Box(p \vee \neg p).$$

Since  $S^k(x) = (f^k(x_1), x_2)$  and  $\mathfrak{M}, (f^k(x_1), 1) \models \Box(p \vee \neg p)$ , this is only possible if  $x_2 = 0$  and  $\mathfrak{M}, S^k(x) \models p$ , so that  $(\mathfrak{M}, x) \models \Diamond p$ . Similarly, if

$$\mathfrak{M}, x \not\models \beta = \Box(\Box(p \vee \neg p) \rightarrow p \vee \neg p \vee \Box \neg p),$$

then there is  $k$  such that  $\mathfrak{M}, S^k(x) \not\models \Box(p \vee \neg p) \rightarrow p \vee \neg p \vee \Box \neg p$ . Once again using the fact that  $S^k(x) = (f^k(x_1), x_2)$ , this is only possible if  $x_2 = 0$ ,  $\mathfrak{M}, S^k(x) \models \Box(p \vee \neg p)$  and  $\mathfrak{M}, S^k(x) \not\models \Box \neg p$ . But from this it easily can be seen that there is  $k' > k$  with  $\mathfrak{M}, S^{k'}(x) \models p$ , hence  $(\mathfrak{M}, x) \models \Diamond p$ .  $\square$

**Corollary 3.** *Over the class of here-and-there models,  $p \cup q$  is  $\mathbb{L}_R$ -definable.*

*Proof.* Since  $\Box \varphi$  is definable by  $\Box \varphi \equiv \perp R \varphi$  and  $\Diamond p$  is definable by Proposition 11,  $p \cup q$  is definable by  $p \cup q \equiv (q R(p \vee q)) \wedge \Diamond p$  (Proposition 4.9).  $\square$

Our goal next is to show that the modality  $\Diamond$  cannot be defined in terms of  $R$  over the class of persistent models. For this, we will use a model construction based on the last exponent of a number  $m > 0$  in base 2, which we denote by  $\ell(m)$ ; for example,  $6 = 2^2 + 2^1$ , so  $\ell(6) = 1$ . Before we continue, let us establish some basic properties of the function  $\ell$ . The following lemma is easily verified, and we present it without proof.

**Lemma 25.** *Let  $a, b$  be positive integers.*

1. *If  $\ell(a) < \ell(b)$  then  $\ell(a+b) = \ell(a)$  and if  $\ell(a) = \ell(b)$  then  $\ell(a+b) \geq \ell(a) + 1$ .*
2.  *$\ell(ab) = \ell(a) + \ell(b)$ .*
3. *If  $1 \leq a \leq 2^b$  then  $\ell(a) \leq b$ , and  $\ell(a) = b$  if and only if  $a = 2^b$ .*

From these properties we obtain the following useful equality.

**Lemma 26.** *Let  $m \geq 1$ ,  $a \geq 0$  and  $k \in [1, 2^m)$ . Then,  $\ell(a2^m + k) = \ell(k)$ .*

*Proof.* If  $a = 0$ , the claim is obvious. Otherwise, note that since  $k < 2^m$ , we have that  $\ell(k) \leq m - 1$ . Then  $\ell(a2^m) = \ell(a) + m \geq m$ , so that  $\ell(a2^m + k) = \min\{\ell(a2^m), \ell(k)\} = \ell(k)$ .  $\square$

With this we are ready to define the models  $\mathfrak{M}_n^\diamond$ .

**Definition 20.** *Let  $n \geq 0$  and fix a ‘designated’ variable  $p$ . We define a model  $\mathfrak{M}_n^\diamond = (W, \leq, S, V)$ , where*

1.  $W = \mathbb{Z}/(2^n) \times [0, n]$ ,
2.  $(i, j) \leq (i', j')$  if  $i = i'$  and  $j \leq j'$ ,
3.  $S(i, j) = ([i + 1]_{2^n}, j)$ , and
4.  $V(i, j) = \{p\}$  if and only if  $j > n - \ell(i)$ ,  $V(i, j) = \emptyset$  otherwise.

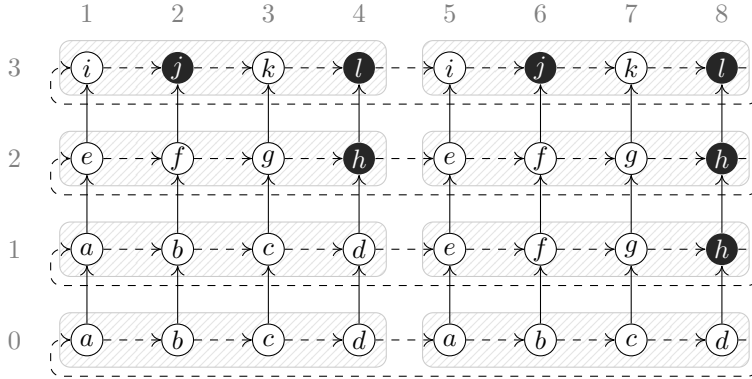

Figure 9: The model  $\mathfrak{M}_3^\diamond$ . Black states satisfy the atom  $p$  while the other states do not. All other atoms are false everywhere. Solid arrows indicate  $\leq$  and dashed arrows indicate  $S$ . Letters correspond to the equivalence classes w.r.t.  $\sim_2$ , i.e., if two states  $w, x$  are represented by the same letter then  $w \sim_2 x$ . The hashed regions correspond to 2-blocks.

See Figure 9 for an illustration of  $\mathfrak{M}_3^\diamond$ . The key properties of the model  $\mathfrak{M}_n^\diamond$  are that  $(1, 0)$  and  $(1, 1)$  are  $(n - 1)$ -R-bisimilar, yet they disagree on the truth of  $\diamond p$ . Let us begin by proving the latter.

**Lemma 27.** *Given  $n \geq 0$ ,  $\mathfrak{M}_n^\diamond, (1, 0) \not\models \diamond p$  and  $\mathfrak{M}_n^\diamond, (1, 1) \models \diamond p$ .*

*Proof.* Let  $\mathfrak{M}_n^\diamond = (W, \leq, S, V)$ . Note that  $\mathfrak{M}_n^\diamond, (1, 1) \models \diamond p$  since  $(2^n, 1) = S^{2^n}(1, 0)$  and  $1 > n - \ell(2^n)$ , so that  $\mathfrak{M}_n^\diamond, (2^n, 1) \models p$ . On the other hand, if  $(i, j) = S^k(1, 0)$  then  $j = 0$  and  $i \in [1, 2^n]$ , so that by Lemma 25.3  $\ell(i) \leq n$  and

$0 \leq n - \ell(i)$ . Hence  $\mathfrak{M}_n^\diamond, S^k(1,0) \not\equiv p$ , and since  $k$  was arbitrary,  $\mathfrak{M}_n^\diamond, (1,0) \not\equiv \diamond p$ .  $\square$

Next we will define a family of binary relations  $(\sim_m)_{m < n}$  on  $\mathfrak{M}_n^\diamond$  which will be used to show that  $(1,0)$  and  $(1,1)$  are  $n$ - $\mathcal{R}$ -bisimilar. These relations are defined using the notion of *congruent blocks*.

**Definition 21.** Let  $n \geq 0$  and  $\mathfrak{M}_n^\diamond = (W, \leq, S, V)$ . Given  $m \in [0, n]$ , say that an  $m$ -block is a set of the form

$$B_m(a, b) := [(a-1)2^m + 1, a2^m] \times \{b\},$$

where  $a \in \mathbb{Z}/(2^{n-m})$  and  $0 \leq b \leq n$ ; we say that  $b$  is the height of  $B_m(a, b)$ . Two blocks  $B_m(a, b)$  and  $B_m(a', b')$  are congruent if for all  $i \in [1, 2^m]$ ,  $p \in V((a-1)2^m + i, b)$  if and only if  $p \in V((a'-1)2^m + i, b')$ . Then, if  $x = (x_1, x_2)$  and  $y = (y_1, y_2)$ , define  $x \sim_m y$  if and only if  $x_1 \equiv y_1 \pmod{2^m}$  and  $x, y$  belong to congruent  $m$ -blocks.

It will be convenient to classify the different  $m$ -blocks. We say that  $B = B_m(a, b)$  is *initial* if  $V(x) = \emptyset$  for all  $x \in B$ , *terminal* if  $V(a2^m, b) = \{p\}$  and  $V(x) = \emptyset$  for any other  $x \in B$ , and *regular* otherwise. A point  $x = (x_1, x_2)$  is *m-initial*, *m-terminal* or *m-regular* if it belongs to an  $m$ -block of the respective kind. The classification of an  $m$ -block can be deduced from its height.

**Lemma 28.** Let  $n \geq 0$  and  $m \in [1, n]$ . Let  $B = B_m(a, b)$  be an  $m$ -block in  $\mathfrak{M}_n^\diamond$  of height  $b$ . Then:

1.  $B$  is initial if and only if  $b \leq n - m - \ell(a)$ ;
2.  $B$  is terminal if and only if  $b \in (n - m - \ell(a), n - m + 1]$ , and
3.  $B$  is regular if and only if  $b > n - m + 1$ .

*Proof.* Let  $B = B_m(a, b)$  be any block. First observe that  $\ell(a2^m) = \ell(a) + m \geq m$ , so that  $p \in V(a2^m, b)$  if and only if  $b > n - \ell(a) - m$ ; it follows that if  $B$  is initial then  $b \leq n - \ell(a) - m$ .

Next we show that if  $b \leq n - m + 1$ , then for  $k \in [1, 2^m]$ ,  $p \notin V((a-1)2^m + k, b')$ . Since by Lemma 26  $\ell((a-1)2^m + k) = \ell(k) < m$ , we see that  $b \leq n - \ell((a-1)2^m + k)$ , and thus  $p \notin V((a-1)2^m + k, b)$ , as claimed.

But then if  $b \leq n - \ell(a) - m$  we have that  $V(a2^m, b) = \emptyset$  as well, so that  $B$  is initial if and only if  $b \leq n - \ell(a) - m$ , while if  $b \in (n - m - \ell(a), n - m + 1]$  it is neither initial nor regular, hence it is terminal.

It remains to check that if  $b > n - m + 1$ , then  $B$  is regular. But then as  $m \geq 1$  we have that  $x = ((a-1)2^m + 2^{m-1}, b) \in B$  and since  $\ell((a-1)2^m + 2^{m-1}) = m - 1$ , we see that  $b > n - \ell((a-1)2^m + 2^{m-1})$  and  $x \in B \cap V(p)$ , so that  $B$  is regular.  $\square$

**Lemma 29.** Let  $n \geq 0$  and  $\mathfrak{M}_n^\diamond = (W, \leq, S, V)$ . Then, if  $x \in W$  is  $m$ -initial, there is  $y \geq x$  which is  $m$ -terminal.

*Proof.* Let  $x = (i, b)$  and  $a$  be such that  $x \in B = B_m(a, b)$ . Since  $x$  is  $m$ -initial, by Lemma 28.1 we have that  $b < n - m + 1$ . Hence if we set  $b' = n - m + 1$  and  $B' = B_m(a, b')$ , we see by Lemma 28.2 that  $B'$  is terminal, and as  $b \leq b'$  that  $y = (i, b') \succ x$ , as needed.  $\square$

**Lemma 30.** *Let  $n \geq 0$  and  $m \in [0, n]$ . If  $B$  and  $B'$  are regular  $m$ -blocks then  $B$  and  $B'$  are congruent if and only if they have the same height.*

*Proof.* Suppose that  $B = B_m(a, b)$  and  $B' = B_m(a', b')$  are regular, so that by Lemma 28.3,  $b, b' > n - m + 1$ . If  $b = b'$  and  $k \in [1, 2^m)$  then by Lemma 26,

$$\ell((a-1)2^m + k) = \ell(k) = \ell((a'-1)2^m + k),$$

so that  $p \in V((a-1)2^m + k, b)$  if and only if  $p \in V((a'-1)2^m + k, b)$ . Since  $b > n - m + 1$  and  $\ell(c2^m) = \ell(c) + m > m$  for  $c \in \{a, a'\}$ , we see that  $b > n - \ell(a2^m)$  and also  $b > n - \ell(a'2^m)$ , so that  $p \in V(a2^m, b) \cap V(a'2^m, b')$ . We conclude that for all  $k \in [0, 2^m]$ ,  $p \in ((a-1)2^m + k, b)$  if and only if  $p \in ((a'-1)2^m + k, b)$ , i.e.  $B$  and  $B'$  are congruent.

If instead  $b \neq b'$ , assume without loss of generality that  $b < b'$ . Since  $b > n - m + 1$  we have that  $k := 2^{n-b} \in [1, 2^m)$ . But then  $b \leq n - (n - b) = n - \ell((a-1)2^m + k)$ , while  $b' > n - (n - b) = n - \ell((a'-1)2^m + k)$ . We conclude that  $p \notin ((a-1)2^m + k, b)$  while  $p \in V((a'-1)2^m + k, b')$ , hence  $B$  and  $B'$  are not congruent.  $\square$

In order to prove that  $(\sim_m)_{m < n}$  is indeed a graded  $\mathbb{R}$ -bisimulation we will need to consider some basic transformations on blocks. Namely, we define the *successor* of  $B_m(a, b)$  to be  $B_m([a+1]_{2^{n-m}}, b)$ , and if  $m = m' + 1$ , then we say that  $B_{m'}(2a-2, b)$  is the *first half* of  $B$ , and  $B_{m'}(2a-1, b)$  is the *second half* of  $B$ .

**Lemma 31.** *If  $B$  and  $B'$  are congruent  $m$ -blocks, then:*

1. *the first halves of  $B$  and  $B'$  are congruent,*
2. *the second halves of  $B$  and  $B'$  are congruent, and*
3. *the successors of the second halves of  $B$  and  $B'$  are congruent.*

*Proof.* The first two items follow directly from the definition of congruence. For the third item, the congruence of the successors of the second halves of  $B$  and  $B'$  is shown by a case-by-case analysis: if  $B$  and  $B'$  are regular, then the successors of the second halves are either both terminal or both regular with the same height. If  $B, B'$  are not regular, then said successors are both initial.  $\square$

**Proposition 12.** *The relations  $(\sim_m)_{m < n}$  form a graded  $\mathbb{R}$ -bisimulation on  $\mathfrak{M}_n^\diamond$ .*

*Proof.* Note that  $\sim_m$  is symmetric, so we only check the ‘forth’ clauses. Below, assume that  $x = (x_1, x_2)$ ,  $y = (y_1, y_2)$  and  $x \sim_m y$ .

ATOMS: From  $x_1 \equiv y_1 \pmod{2^m}$  and the fact that  $x, y$  belong to congruent  $m$ -blocks, we obtain that  $p \in V(x)$  if and only if  $p \in V(y)$ .

FORTH  $\leq$ : Let  $x' = (x_1, b) \geq x$ . If  $x, y$  are  $(m+1)$ -regular, it follows from Lemma 30 that  $x_2 = y_2$ . Thus  $y' := (y_1, b) \geq y$ , and it is not hard to see using Lemma 28.3 that  $x', y'$  are both  $m$ -regular, so that  $x' \sim_m y'$  by Lemma 30. If  $x'$  is  $m$ -initial, then it follows that  $y$  is  $m$ -initial and we take  $y' = y$ . If  $x'$  is  $m$ -terminal, then either  $y$  is  $m$ -terminal and we take  $y' = y$ , or  $y$  is  $m$ -initial so that by Lemma 29 there is some  $m$ -terminal  $y' \geq y$ ; in either case we have that  $x' \sim_m y'$ .

FORTH  $\circ$ : If  $x, y$  belong to the  $(m+1)$ -blocks  $B, B'$ , then  $S(x), S(y)$  either both belong to first halves of  $B, B'$ , to their second halves, or to the successors of their second halves. In any case, it follows from Lemma 31 that they belong to congruent  $m$ -blocks, and since addition preserves congruence modulo  $2^m$  we obtain  $S(x) \sim_m S(y)$ .

FORTH R: Suppose that  $x, y$  belong to the  $(m+1)$ -blocks  $B, B'$ . Let  $x' = S^r(x)$  and note that  $s' = ([x_1 + r]_{2^n}, x_2)$ . If  $x'$  belongs to the same  $(m+1)$ -block as  $x$ , take  $y' = (y_1 + r, y_2)$ . Then, it is readily verified that, for each  $t \leq r$ ,  $(x_1 + t, x_2) \sim_m (y_1 + t, y_2)$ .

Otherwise, let  $r'$  be the least such that  $y' := ([y_1 + r']_{2^n}, y_2)$  is *not* on the same  $(m+1)$ -block as  $y$  and  $y_1 + 2^n r' \equiv [x_1 + r]_{2^n} \pmod{2^m}$ . Clearly  $r' \leq r$ , and thus as before we have that for each  $t < r'$ ,  $([x_1 + t]_{2^n}, x_2) \sim_m ([y_1 + t]_{2^n}, y_2)$ ; this is seen by noting that  $[x_1 + t]_{2^n} \equiv [y_1 + t]_{2^n} \pmod{2^m}$ , and  $([x_1 + t]_{2^n}, x_2), ([y_1 + t]_{2^n}, y_2)$  are both either on the first halves of  $B$  and  $B'$ , or both on the second halves, or both on the successor of the second half; the minimality of  $r'$  guarantees that no other case is possible.

If  $x'$  is  $m$ -regular then  $x$  must be  $(m+1)$ -regular, from which it is easy to see that  $x, x', y, y'$  all share the same height and hence  $y' \sim_m x'$ . Otherwise,  $y'$  is  $m$ -initial. If  $x'$  is  $m$ -initial define  $y'' = y'$ , and if  $x'$  is  $m$ -terminal, choose  $y'' \geq y'$  which is  $m$ -terminal. In either case,  $y'' \sim_m x'$ , as needed.  $\square$

**Theorem 7.** *The formula  $\diamond p$  is not  $L_R$ -definable over the class of persistent models.*

*Proof.* Let  $\varphi \in L_R$ , let  $n = |\varphi|$  and consider the model  $\mathfrak{M}_{n+1}^\diamond$ . By Lemma 27,  $\mathfrak{M}_{n+1}^\diamond(1, 0) \not\models \diamond p$  and  $\mathfrak{M}_{n+1}^\diamond(1, 1) \models \diamond p$ . However, by Lemma 28.1,  $B_n(1, 0)$  and  $B_n(1, 1)$  are both initial, hence  $(1, 0) \sim_n (1, 1)$ . By Lemma 24,  $\mathfrak{M}_{n+1}^\diamond(1, 0) \models \varphi$  if and only if  $\mathfrak{M}_{n+1}^\diamond(1, 1) \models \varphi$ . It follows that  $\varphi$  is not equivalent to  $\diamond p$  over the class of persistent models.  $\square$

## 9 Conclusions

We have studied  $ITL^e$ , an intuitionistic analogue of LTL based on expanding domain models from modal logic and first introduced in [5]. In the literature, intuitionistic modal logic is typically interpreted over persistent models, but as



we have shown this interpretation has the technical disadvantage of not enjoying the finite model property. Of course, this fact alone does not imply that  $\text{ITL}^P$  is undecidable, and whether the latter is true remains an open problem. This should not be surprising, as decidability for intuitionistic modal logics with a transitive modal accessibility relation is notoriously difficult to prove [44], having resisted proof techniques that have been successfully applied to other intuitionistic modal logics, such as those in e.g. [2]. Meanwhile, our semantics are natural in the sense that we impose the minimal conditions on  $S$  so that all truth values are monotone under  $\leq$ , and a wider class of models is convenient as they can more easily be tailored for specific applications. Furthermore, we have presented the notions of bounded bisimulations and shown that, as happens in other modal intuitionistic logics or modal intermediate logics, modal operators are not interdefinable.

This work and [5] represent the first attempts to study  $\text{ITL}^e$ . Needless to say, many open questions remain. We know that  $\text{ITL}^e$  is decidable, but the proposed decision procedure is non-elementary. However, there seems to be little reason to assume that this is optimal, raising the following question:

**Question 1.** *Are the satisfiability and validity problems for  $\text{ITL}^e$  elementary?*

Meanwhile, we saw in Theorems 5 and 3 that  $\text{ITL}^e$  has the effective finite model property, while  $\text{ITL}^P$  does not have the finite model property at all. However, it may yet be that  $\text{ITL}^P$  is decidable despite this.

**Question 2.** *Is  $\text{ITL}^P$  decidable?*

Regarding expressive completeness, it is known that  $\text{LTL}$  is expressively complete [26, 43, 19, 23]:  $\text{L}_U$  is expressively equivalent to monadic first-order logic equipped with a linear order and ‘next’ relation [19]. Persistent models can be viewed as models of first-order intuitionistic logic, and hence we can ask the same question of  $\text{ITL}^P$ .

**Question 3.** *Is  $\text{L}_{\Box U}$  equally expressive to monadic first-order logic over the class of persistent models?*

Finally, a sound and complete axiomatization for  $\text{ITL}^e$  remains to be found. In [14] we axiomatize the  $\Box$ -free fragment of  $\text{ITL}^e$  and we discuss possible axioms for the full language in [6], but treating languages with  $\Box$  seems to be a much more difficult problem.

**Question 4.** *Do  $\text{ITL}^e$  or  $\text{ITL}^P$  enjoy natural axiomatizations?*

## References

- [1] F. Aguado, P. Cabalar, D. Pearce, G. Pérez, and C. Vidal. A denotational semantics for equilibrium logic. *Theory and Practice of Logic Programming*, 15(4-5):620–634, 2015.

- [2] N. Alechina and D. Shkatov. A general method for proving decidability of intuitionistic modal logics. *Journal of Applied Logic*, 4(3):219–230, 2006.
- [3] P. Balbiani and M. Diéguez. Temporal here and there. In *15th European Conference on Logics in Artificial Intelligence (JELIA)*, pages 81–96, Larnaca, Cyprus, 2016. Springer.
- [4] P. Blackburn, M. de Rijke, and Y. Venema. *Modal Logic*. Cambridge University Press, Cambridge, UK, 2001.
- [5] J. Boudou, M. Diéguez, and D. Fernández-Duque. A decidable intuitionistic temporal logic. In *26th EACSL Annual Conference on Computer Science Logic (CSL)*, pages 14:1–14:17, Stockholm, Sweden, 2017. Schloss Dagstuhl - Leibniz-Zentrum fuer Informatik.
- [6] J. Boudou, M. Diéguez, D. Fernández-Duque, and F. Romero. Axiomatic systems and topological semantics for intuitionistic temporal logic. In *Logics in Artificial Intelligence - 16th European Conference, JELIA 2019, Rende, Italy, May 7-11, 2019, Proceedings*, pages 763–777, Rende, Italy, 2019. Springer International Publishing.
- [7] G. Brewka, T. Eiter, and M. Truszczyński. Answer set programming at a glance. *Communications of the ACM*, 54(12):92–103, 2011.
- [8] P. Cabalar and G. Pérez. Temporal Equilibrium Logic: A First Approach. In *Proc. of the 11<sup>th</sup> International Conference on Computer Aided Systems Theory (EUROCAST’07)*, page 241248, Las Palmas de Gran Canaria, Spain, 2007. Springer Berlin Heidelberg.
- [9] D. van Dalen. Intuitionistic logic. In *Handbook of Philosophical Logic*, volume 166, pages 225–339. Springer Netherlands, Dordrecht, 1986.
- [10] R. Davies. A temporal-logic approach to binding-time analysis. In *11th Annual IEEE Symposium on Logic in Computer Science (LICS)*, pages 184–195, Washington, DC, USA, 1996. IEEE Computer Society.
- [11] R. Davies. A temporal logic approach to binding-time analysis. *Journal of the ACM*, 64:1–45, 2017.
- [12] R. Davies and F. Pfenning. A modal analysis of staged computation. *J. ACM*, 48(3):555–604, 2001.
- [13] J. Davoren. On intuitionistic modal and tense logics and their classical companion logics: Topological semantics and bisimulations. *Annals of Pure and Applied Logic*, 161(3):349–367, 2009.
- [14] M. Diéguez and D. Fernández-Duque. An intuitionistic axiomatization of ‘eventually’. In *Advances in Modal Logic*, pages 199–218, Bern, Switzerland, 2018. College Publications.

- [15] A.P. Ershov. On the partial computation principle. *Inf. Process. Lett.*, 6(2):38–41, 1977.
- [16] W. Ewald. Intuitionistic tense and modal logic. *The Journal of Symbolic Logic*, 51(1):166–179, 1986.
- [17] L. Fariñas del Cerro, A. Herzig, and E. Iraz Su. Epistemic equilibrium logic. In *IJCAI’15*, pages 2964–2970, Buenos Aires, Argentina, 2015. AAAI Press.
- [18] D. Fernández-Duque. The intuitionistic temporal logic of dynamical systems. *Logical Methods in Computer Science*, 14(3):1–35, 2018.
- [19] D. Gabbay, A. Pnueli, S. Shelah, and J. Stavi. On the Temporal Analysis of Fairness. In *7th ACM SIGPLAN-SIGACT Symposium on Principles of Programming Languages (POPL)*, pages 163–173, New York, NY, USA, 1980. ACM.
- [20] D. Gabelaia, A. Kurucz, F. Wolter, and M. Zakharyashev. Non-primitive recursive decidability of products of modal logics with expanding domains. *Annals of Pure and Applied Logic*, 142(1-3):245–268, 2006.
- [21] M. Gelfond and V. Lifschitz. The Stable Model Semantics For Logic Programming. In *Proc. of the 5<sup>th</sup> International Conference on Logic Programming (ICLP’88)*, page 10701080, Seattle, Washington, USA, 1988. MIT Press.
- [22] A. Heyting. *Die formalen Regeln der intuitionistischen Logik*. Sitzungsberichte der Preussischen Akademie der Wissenschaften. Physikalisch-mathematische Klasse. Deutsche Akademie der Wissenschaften zu Berlin, Mathematisch-Naturwissenschaftliche Klasse, Berlin, Germany, 1930.
- [23] I. Hodkinson. Expressive completeness of until and since over dedekind complete linear time. *Modal logic and process algebra*, 53:171–185, 1995.
- [24] W.A. Howard. The formulas-as-types notion of construction. In J. P. Seldin and J. R. Hindley, editors, *To H. B. Curry: Essays on Combinatory Logic, Lambda Calculus, and Formalism*, pages 479–490. Academic Press, Boston, MA, 1980.
- [25] N. Kamide and H. Wansing. Combining linear-time temporal logic with constructiveness and paraconsistency. *Journal of Applied Logic*, 8(1):33–61, 2010.
- [26] H. Kamp. *Tense Logic and the Theory of Linear Order*. PhD thesis, University of California, Los Angeles, California, USA, 1968.
- [27] K. Kojima and A. Igarashi. Constructive linear-time temporal logic: Proof systems and Kripke semantics. *Information and Computation*, 209(12):1491–1503, 2011.

- [28] J.B. Kruskal. Well-quasi-ordering, the tree theorem, and Vazsonyi’s conjecture. *Transactions of the American Mathematical Society*, 95(2):210–225, 1960.
- [29] N. Kurtonina and M. de Rijke. Bisimulations for temporal logic. *Journal of Logic, Language and Information*, 6(4):403–425, 1997.
- [30] A. Kurucz, F. Wolter, M. Zakharyashev, and Dov M. Gabbay. *Many-Dimensional Modal Logics: Theory and Applications, Volume 148 (Studies in Logic and the Foundations of Mathematics)*. North Holland, Amsterdam, Netherlands, 1 edition, 2003.
- [31] V. Lifschitz, D. Pearce, and A. Valverde. A Characterization of Strong Equivalence for Logic Programs with Variables. In *9th International Conference on Logic Programming and Nonmonotonic Reasoning (LPNMR)*, pages 188–200, Berlin, Heidelberg, 2007. Springer.
- [32] J. Lukasiewicz. Die logik und das grundlagenproblem. *Les Entretiens de Zürich sur les Fondaments et la Méthode des Sciences Mathématiques*, 12(6-9):82–100, 1938.
- [33] P. Maier. Intuitionistic LTL and a new characterization of safety and liveness. In Jerzy Marcinkowski and Andrzej Tarlecki, editors, *Computer Science Logic: 18th International Workshop, CSL 2004, 13th Annual Conference of the EACSL, Karpacz, Poland, September 20-24, 2004. Proceedings*, pages 295–309, Berlin, Heidelberg, 2004. Springer Berlin Heidelberg.
- [34] V. Marek and M. Truszczyński. *Stable models and an alternative logic programming paradigm*, pages 169–181. Springer-Verlag, Berlin, Heidelberg, 1999.
- [35] G. Mints. *A Short Introduction to Intuitionistic Logic*. University Series in Mathematics. Kluwer Academic Publishers, Norwell, MA, USA, 2000.
- [36] G. Mints. Cut-free formulations for a quantified logic of here and there. *Annals of Pure and Applied Logic*, 162(3):237–242, 2010.
- [37] I. Niemelä. Logic Programs with Stable Model Semantics as a Constraint Programming Paradigm. *Annals of Mathematics and Artificial Intelligence*, 25(3-4):241–273, 1999.
- [38] A. Patterson. Bisimulation and propositional intuitionistic logic. In *8th International Conference on Concurrency Theory (CONCUR)*, pages 347–360, Berlin, Heidelberg, 1997. Springer.
- [39] D. Pearce. A New Logical Characterisation of Stable Models and Answer Sets. In *Proc. of Non-Monotonic Extensions of Logic Programming (NMELP’96)*, pages 57–70, Bad Honnef, Germany, 1996. Springer.

- [40] D. Pearce. Equilibrium Logic. *Annals of Mathematics and Artificial Intelligence*, 47(1-2):3–41, 2006.
- [41] G. Plotkin and C. Stirling. A framework for intuitionistic modal logics: Extended abstract. In *1st Conference on Theoretical Aspects of Reasoning About Knowledge (TARK)*, pages 399–406, San Francisco, CA, USA, 1986. Morgan Kaufmann Publishers Inc.
- [42] A. Pnueli. The temporal logic of programs. In *18th IEEE Symposium on the Foundations of Computer Science*, pages 46–57, Washington, DC, USA, 1977. IEEE Computer Society.
- [43] A. Rabinovich. A Proof of Kamp’s Theorem. *Logical Methods in Computer Science*, 10(1), 2014.
- [44] A. Simpson. *The proof theory and semantics of intuitionistic modal logic*. PhD thesis, University of Edinburgh, United Kingdom, 1994.
- [45] Y. Yuse and A. Igarashi. A modal type system for multi-level generating extensions with persistent code. In *Proceedings of the 8th ACM SIGPLAN International Conference on Principles and Practice of Declarative Programming, PPDP ’06*, pages 201–212, New York, NY, USA, 2006. ACM.