



HAL
open science

Micro-cantilever testing on the short-term creep behaviour of cement paste at micro-scale

Yidong Gan, Matthieu Vandamme, Hongzhi Zhang, Yu Chen, Erik Schlangen,
Klaas van Breugel, Branko Avija

► **To cite this version:**

Yidong Gan, Matthieu Vandamme, Hongzhi Zhang, Yu Chen, Erik Schlangen, et al.. Micro-cantilever testing on the short-term creep behaviour of cement paste at micro-scale. *Cement and Concrete Research*, 2020, 134, p106105. 10.1016/j.cemconres.2020.106105 . hal-02877486

HAL Id: hal-02877486

<https://hal.science/hal-02877486v1>

Submitted on 22 Jun 2020

HAL is a multi-disciplinary open access archive for the deposit and dissemination of scientific research documents, whether they are published or not. The documents may come from teaching and research institutions in France or abroad, or from public or private research centers.

L'archive ouverte pluridisciplinaire **HAL**, est destinée au dépôt et à la diffusion de documents scientifiques de niveau recherche, publiés ou non, émanant des établissements d'enseignement et de recherche français ou étrangers, des laboratoires publics ou privés.

1 **Micro-cantilever testing on the short-term creep behaviour of** 2 **cement paste at micro-scale**

3 Yidong Gan ^a, Matthieu Vandamme ^b, Hongzhi Zhang ^{c,*}, Yu Chen ^a, Erik Schlangen ^a, Klaas van
4 Breugel ^a and Branko Šavija ^a.

5 ^a Microlab, Faculty of Civil Engineering and Geosciences, Delft University of Technology, Delft 2628, CN, The Netherlands

6 ^b Laboratoire Navier, UMR 8205, CNRS, École des Ponts ParisTech, IFSTTAR, Université Paris-Est, Champs-sur-Marne,
7 France

8 ^c School of Qilu Transportation, Shandong University, 250002, Jinan, PR China

9 y.gan@tudelft.nl; matthieu.vandamme@enpc.fr; Y.Chen-6@tudelft.nl; Erik.Schlangen@tudelft.nl;
10 K.vanBreugel@tudelft.nl; B.Savija@tudelft.nl;

11 * Corresponding author: hzzhang@mail.sdu.edu.cn

12 **Abstract**

13 This study proposes an experimental method for studying the short-term creep behaviour of
14 cement paste at micro-scale. The micro-bending tests on miniaturized cantilever beams were
15 used to characterize the viscoelastic properties of cement paste. The effects of w/b ratio, the type
16 of binder and the stress level on the microscopic creep behaviour were investigated. It is found
17 that the short-term creep of cement paste at microscale can be satisfactorily described by a
18 power-law function. A linear viscoelastic behaviour has been observed in different cementitious
19 systems at the microscale with the stress level up to 67.9%. When compared with the creep
20 results in microindentation tests and conventional macroscopic tests, the obtained creep
21 compliance function in this study is found to be both qualitatively and quantitatively
22 representative of the macroscopic results. This experimental study underlines the importance of
23 microstructural effect on the creep behaviours of cementitious materials at microscale.

24 **Keywords:** cement paste, creep, miniaturized cantilever beam, nanoindenter

251. **Introduction**

26 Ageing of infrastructure is considered to be a huge financial burden for modern industrialised
27 societies [1]. One of the common ageing phenomena for concrete structures is creep [2]. Even
28 though extensive research efforts has been devoted to it [3–7], this complicated phenomenon is
29 still not fully understood. A comprehensive review of creep studies on cementitious materials
30 indicates that despite the numerous influencing factors [8–13], the multiple time and length
31 scales involved in the creep process further exacerbate the complexity [14–16].

32 In view of the duration of creep test, there are usually short-term creep tests ranging from several
33 minutes to months [17–20] and long-term creep tests lasting from several months to years

34 [5,8,16]. In these tests, at least two distinct creep kinetics have been identified, i.e. the power-law
35 creep and the logarithmic creep [5,14,20–23]. It is often argued that the short-term and long-term
36 creep may be governed by different mechanisms [3,16,24]. For the short-term creep, the creep
37 behaviour is thought to be associated with the water movement and redistribution [24], whilst for
38 the long-term creep, the underlying creep mechanism is debatable and various theories have been
39 proposed [2,3,7,12,13,24,25]. Nevertheless, many researchers believe that the rearrangement of
40 calcium–silicate–hydrate (C-S-H), e.g. sliding and compaction, plays a dominant role in the
41 long-term creep [2,3,12,26]. Note that none of these theories alone can explain all the
42 experimental observations and it appears that several of the proposed physical processes could
43 occur simultaneously [3,24,27]. Admittedly, both short-term and long-term creep tests are
44 essential to the integrated understanding and prediction of creep behaviour [14].

45 Concrete is a multiscale heterogeneous composite and the creep phenomenon can be observed at
46 different length scales, i.e. from the hydrate to concrete [2,14,20]. In the context of multiscale
47 modelling [19,28], the experimental techniques intended to characterize the viscoelastic
48 properties of elemental constituents at every scale should be well developed. While most studies
49 focus on the macroscopic creep tests of cement paste and concrete [6,8,29–32], there are some
50 studies conducted on the characterization of the viscoelastic properties at nano and micro-scale
51 using the indentation technique [14,20,33–35]. Vandamme and Ulm [2,20] performed
52 nanoindentation creep tests directly on the C-S-H structures, which is usually recognized as the
53 main creeping phase in cementitious materials [12,26], and they suggested a qualitative analogy
54 with the creep of soils. Wei et al [21] also investigated the creep behaviour of cement paste
55 across the nanometre to micrometre scale by using the indentation technique. These minutes-
56 long indentation creep tests enable a rapid quantitative assessment of the long-term creep
57 properties of cementitious materials [14,20]. However, a major limitation of this technique is that
58 such indentation tests do not provide the access to characterize the short-term creep behaviour
59 [14,17,22]. Vandamme [27] suggested that this is because of the high magnitude of stresses
60 below the indenter tip. Therefore, in order to gain a complete description of creep behaviour at
61 small scale, the complementary test methods capable of evaluating the microscopic short-term
62 creep behaviour are needed. This can be achieved by small-scale testing of miniature specimens,
63 which has already been used in the determination of mechanical properties [36–43]. In literature,
64 there are mainly two techniques for generating small-scale samples, i.e. the Focused Ion Beam

65 technology (FIB) and the micro dicing method. Note that the investigated length scale is
66 different for these two methods. For the FIB technique, the length of the generated micro-beam
67 is around 20 μm . Consequently, each micro-beam comprises a single component of cement
68 paste, namely the inner and outer hydration products and portlandite (CH) [41]. However, for the
69 micro dicing method adopted in this study, the fabricated beams are relatively larger with the
70 size of 300 μm \times 300 μm \times 1650 μm . The fabricated beam is thus composed of clinker (ranging
71 from 0 μm to 150 μm), hydration products (mainly consisting of CH and inner and outer
72 products with size roughly smaller than 100 μm) and pores of various sizes. The prepared
73 miniaturized specimens are then loaded using the nanoindenter to investigate their mechanical
74 response. By applying constant loading on these small-scale specimens, it is also possible to
75 assess their creep properties.

76 The main objective of this work is to explore the short-term viscoelastic properties of cement
77 paste at micro-scale by means of micro-bending tests on miniaturized cantilever beams. The
78 proposed test method was first validated using glass beams, which are expected to be made of a
79 homogenous and isotropic material. Then the results in creep tests were carefully interpreted
80 considering the possible additional deformation mechanisms existing in current test method.
81 Several parameters, such as the w/c ratio, stress level and the addition of ground granulated blast
82 furnace slag (GGBFS) were examined in this study. Finally, the obtained results in this study
83 were compared with the results of indentation tests and macroscopic creep tests.

84 **2. Materials and methods**

85 **2.1. Materials and experimental procedure**

86 2.1.1 Materials

87 In this study, the materials used were standard grade CEM I 42.5 N Portland cement, GGBFS
88 and deionized water. Two series of paste specimens were prepared. The first one is the pure OPC
89 paste with water/cement ratios of 0.3, 0.4, and 0.5. For the second series, the cement paste was
90 blended with GGBFS with the replacement level of 70% by mass. In the blended cement paste
91 w/b ratios of 0.3 and 0.4 were used. The fresh paste was first cast in plastic cylindrical moulds
92 with 24 mm diameter and 39 mm height. Afterwards, the paste was rotated at a speed of 2.5 rpm
93 at room temperature (26 $^{\circ}\text{C}$) for 24 h to mitigate the influence of bleeding. All specimens were
94 cured in sealed conditions at room temperature for 28 days. At the end of the curing period, the
95 hardened cement paste was demoulded and then cut into slices with a thickness of 3 mm. Before

96 further grinding, the samples were kept in isopropanol to stop the hydration process. For the
97 detailed description of arresting hydration using the solvent exchange method, the reader is
98 referred to [36].

99 2.1.2 Preparation of micro-cantilever beams

100 Micro-cantilever beams (MCB) were prepared using a precision micro-dicing machine
101 (MicroAce Series 3 Dicing Saw), which is generally applied to cut semiconductor wafers. Prior
102 to the preparation of cantilever beams, the slices of cement paste were first ground to obtain two
103 smooth and parallel surfaces. In the grinding process, two grinding discs of 135 μm and 35 μm
104 were used in sequence. After reaching the designed thickness of 2.15 mm, the micro-dicing
105 machine was used to apply two perpendicular cutting directions and the same cutting space on
106 the samples. In this way, multiple rows of cantilever beams, including at least 30 beams, with a
107 square cross section of 300 $\mu\text{m} \times 300 \mu\text{m}$ were generated. The cutting depth, i.e. the cantilevered
108 length, was approximately 1.65 mm \pm 0.01 mm. The cutting process is schematically shown in
109 Figure 1. Some of the prepared beams were then examined by using an environmental scanning
110 electron microscope (ESEM). An overall accuracy for the cross-sectional dimensions of $\pm 2 \mu\text{m}$
111 can be reached with the fabrication process (Figure 2). Precautions were also taken to minimize
112 carbonation of the samples before testing by storing the beams in an isopropanol solution. As the
113 drying histories of beams may significantly affect their creep behaviour [6], all samples were
114 prepared according to the same procedure and exposed to the same relative humidity (RH)
115 during the tests. The porosity of miniaturized sample made of OPC has been examined using the
116 X-ray computed tomography (XCT) in the author's previous work [44]. The porosity for OPC
117 with different w/c ratios (0.3, 0.4 and 0.5) was found to be 8.44%, 11.84% and 17.5%,
118 respectively. For blended cement paste with slag, similar specimens using CEM III/B were also
119 examined by XCT [45]. The porosity for different w/b ratios (0.3, 0.4 and 0.5) was found to be
120 5.73%, 7.89% and 9.79%, respectively. However, it should be noted that due to the limitation of
121 image resolution in XCT (2 μm /voxel in this case), pores smaller than 2 μm cannot be detected
122 and are mixed within the segmented solid phases. Therefore, the porosity measured by XCT is
123 much lower compared to porosity measured by the mercury intrusion porosimetry (MIP) [46],
124 For instance, the MIP results of OPC with the w/c ratios of 0.3, 0.4 and 0.5 are 17%, 23% and
125 31%, respectively.

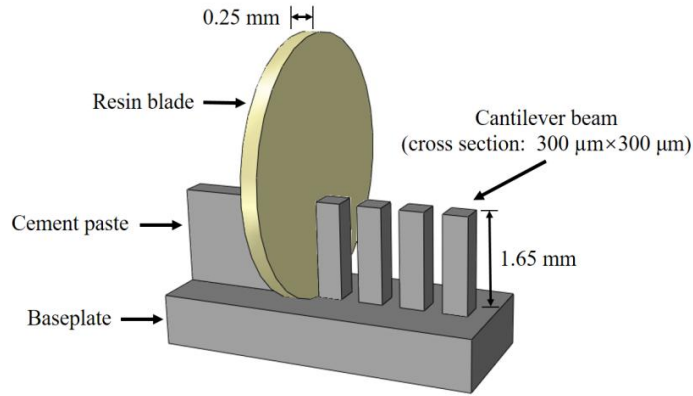

126

127

Figure 1: Schematic diagram of sample preparation.

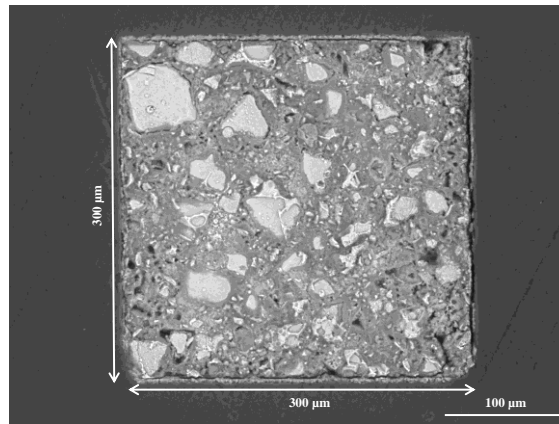

128

129

Figure 2: ESEM image of the cross-sections of cantilever beam.

130 2.2 Micro-cantilever bending test

131 2.2.1 Mechanical properties

132 A KLA Nano indenter G200 was used to conduct bending tests on the MCBs. The baseplate of
 133 beams was first attached on a flat metal surface using cyanoacrylate adhesive. A cylindrical
 134 wedge indenter tip (Figure 3) with a length of 200 μm was used to apply vertical line loads at the
 135 free end of the beams. Before testing, the angle and center of the tip are always calibrated by
 136 probing into the aluminium. Afterwards, the angle of MCB is carefully adjusted under the in-situ
 137 microscope in the nanoindenter to ensure that the line load is applied perpendicularly to the
 138 length direction of beam. The loading procedure for characterization of the mechanical
 139 properties is displacement controlled and the loading rate is 50 nm/s. All tests were conducted in
 140 a well-insulated chamber preventing any significant change of temperature and RH during the
 141 test. The average measured temperature and RH during the tests were 27.2 ± 0.7 °C and $31.0\% \pm$
 142 1.3% , respectively. The experimental set-up is schematically shown in Figure 4. For each

143 material composition, 30 cantilever beams were monotonically loaded to failure. The load-
 144 displacement curves were recorded and used to determine the elastic modulus and flexural
 145 strength. A typical load-displacement curve for the static test is shown in Figure 5. It can be seen
 146 that the displacement of the beams linearly increases with the load till failure occurs. The
 147 maximum load was used to calculate the flexural strength according to Equation (1).

$$f_t = \frac{F_{\max}dh}{2I} \quad (1)$$

148 where d is the measured distance between the load point and the fracture point, h is the side
 149 length of the square cross-section, and $I=h^4/12$ is the moment of inertia. The linear portion of the
 150 load-displacement curve was used to determine the elastic modulus according to Equation (2):

$$E = \frac{kL^3}{3I} \quad (2)$$

151 where L is the length of the cantilever beam, which equals the distance between the load point
 152 and the fixed end; k is the slope measured from the linear region of the load-displacement curve.

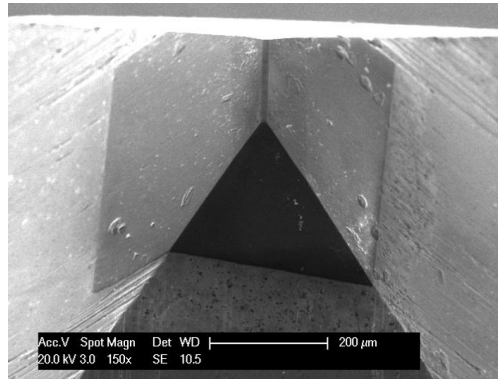

153

Figure 3: ESEM micrograph of the diamond cylindrical wedge tip.

154

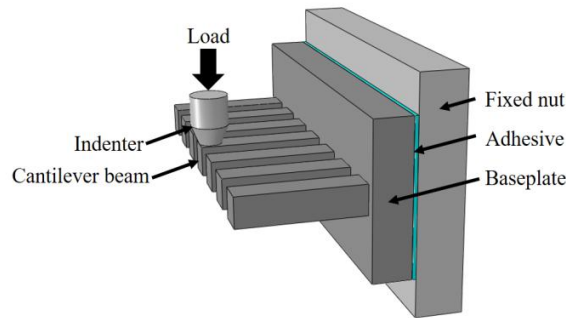

155

Figure 4: Schematic diagram of test set-up.

156

157 Since the nanoindenter records the displacement of the tip head instead of directly measuring the
 158 beam deflection, the measured total displacement may also contain the additional deformation

159 during the loading stage, such as the penetration depth of the indenter tip and the deformation of
 160 the baseplate and the adhesive layer. Therefore, the measured displacement should be calibrated
 161 considering the additional deformation, otherwise the calculated elastic modulus will be
 162 underestimated [47]. By using the finite element modelling method, the effects of the baseplate
 163 and the adhesive layer on the total deformation can be quantified [39]. The simulation results
 164 indicate that 14% and 0.5% of the measured displacement is caused by the deformation of the
 165 baseplate and the adhesive layer, respectively. These additional displacements will be excluded
 166 in the determination of the elastic modulus. Moreover, as pointed out by many researchers
 167 [17,31], the actual elastic modulus will always be underestimated as the displacements measured
 168 in the loading phase are not only elastic but also include some viscoelastic deformation.
 169 Nevertheless, as long as the loading rate is fast enough, the creep deformation during the loading
 170 stage can be neglected with respect to the considerably larger elastic deformation [17]. For the
 171 sake of simplicity, the plastic deformation during the loading stage, e.g. the indentation depth, is
 172 also not considered in the determination of elastic modulus.

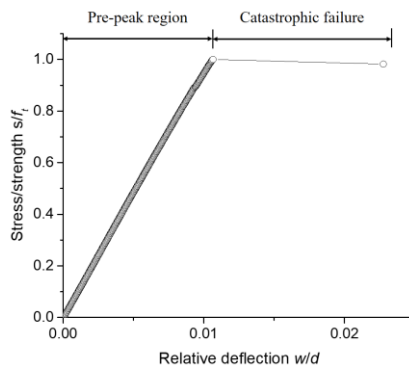

173
 174 Figure 5: Typical load-displacement curves of static tests

175 2.2.2 Short-term creep behaviour

176 In creep tests, a loading protocol consisting of three stages was used to acquire sufficient
 177 information for the analysis of creep phenomenon. Firstly, the MCBs were loaded in a fully
 178 elastic regime, i.e. 30% of the strength, to determine the apparent elastic modulus using the
 179 Equation (2). Afterwards, the beams were subjected to a constant load to assess the viscoelastic
 180 responses of MCBs. Before the creep test, the samples were kept in the chamber for temperature
 181 equalization until the thermal drift rate is below 0.05nm/s. The load was then increased to the
 182 predefined value at a constant rate of 2 mN/s and held for 800 seconds, see Figure 6. Note that
 183 the thermal drift after the creep test was also measured but not considered in this study, as the

184 measured drift may be affected by the creep recovery [48]. In addition, tests with three different
185 stress levels (from 12.5% to 67.9%) were also performed to check whether the cementitious
186 material at this scale behaves in a linear viscoelastic manner. An example of a displacement-time
187 curve is shown in Figure 7. After the constant loading tests, the tested beams were statically
188 loaded to failure in order to assess the residual flexural strength. At least 15 samples were tested
189 for each material composition and test series. All the creep tests were performed in the well-
190 insulated chamber with continuously recorded RH and temperature at 30 s intervals.

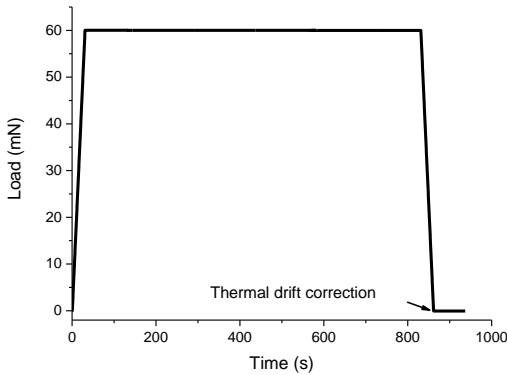

191
192 Figure 6: Loading history of creep tests for w/c 0.3 OPC under the load level of 60mN.

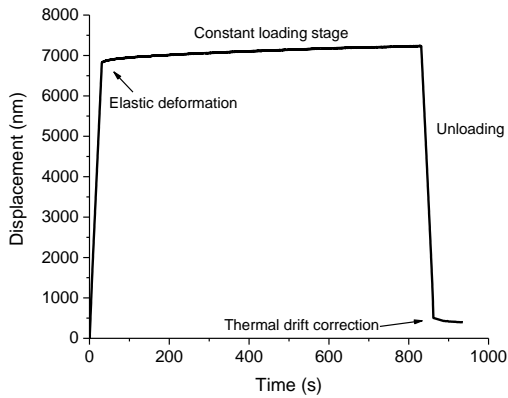

193
194 Figure 7: Typical displacement-time curve for creep test

195 Since the deformation mechanisms of cementitious material under constant loading are very
196 complex, the experimental data should be carefully interpreted. In particular, it is known that
197 moisture exchange occurs between the concrete and the environment under drying condition,
198 leading to drying shrinkage and drying creep [11]. Therefore, special precaution of the hydraulic
199 equilibrium was taken in this study by continuously monitoring the weight loss of the companion
200 sample during the creep tests. It is found that due to the extremely thin cross-section with the

201 volume to surface ratio of only 0.07 mm, the MCBs quickly equilibrated to the ambient RH prior
 202 to the tests. It is well known that the size of specimen indicated by the volume to surface ratio
 203 considerably affects the drying process [49]. Moreover, based on the weight measurements of the
 204 companion MCBs, it is found that there is almost no weight loss during the short-term creep
 205 tests. As a negligible change of temperature and relative humidity is also expected, the thermal
 206 strain, drying shrinkage and drying creep during the creep tests can be ignored [11,19,50].
 207 Moreover, in consideration of the test duration and age of samples (28 days) used in this study,
 208 the autogenous shrinkage caused by hydration can also be neglected [29]. Therefore, the basic
 209 creep compliance $J(t, t_0)$ can be written as:

$$J(t, t_0) = \frac{\varepsilon_{el} + \varepsilon_{bc}(t, t_0)}{\sigma} \quad (3)$$

210 where ε_{el} is the instantaneous strain at the end of loading phase, which is assumed to be identical
 211 with the elastic strain in this study; $\varepsilon_{bc}(t, t_0)$ is the specific basic creep strain at time t , t_0 is the
 212 time at the beginning of constant loading; σ is the maximum stress at the fixed end of the beam.
 213 For the flexural creep tests, it is assumed that cross-sections of beams remain plane under the
 214 applied stress levels. This is based on the observations of previous static tests, where the
 215 deflection of beams linearly increases with the load up to failure, see Figure 5. Therefore, the
 216 compressive and tensile creep strains are assumed to develop equally with a linear distribution
 217 along the height of beams. This has also been experimentally identified in macroscopic flexural
 218 creep tests on concrete beams loaded at 50% of the strength [32]. According to the classical
 219 beam theory and Hooke's law, the elastic strain at the top or bottom surface of a beam can be
 220 calculated as:

$$\varepsilon_{el} = \frac{3\delta_{el}h}{2L^2} \quad (4)$$

221 where δ_{el} is the measured displacement at the end of loading phase. By defining the creep
 222 coefficient $\varphi(t, t_0)$ as the ratio of basic creep strain to the initial elastic strain, its value can be
 223 determined by the measured deflection $\delta(t)$ as follows [29,51]:

$$\varphi(t, t_0) = \frac{\varepsilon_{bc}(t, t_0)}{\varepsilon_{el}} = \frac{\delta(t) - \delta_{el}}{\delta_{el}} \quad (5)$$

224 Afterwards, the specific basic creep compliance $C(t, t_0)$ can be calculated as:

$$C(t, t_0) = \frac{\varphi(t, t_0)\varepsilon_{el}}{\sigma} \quad (6)$$

225 Generally, the effect of self-weight of cement paste should be considered when calculating the

226 creep compliance [29,51]. However, in our study the self-weight of MCB only accounts for
227 0.002% of the load-induced moment at the fixed end of beam, thus the stress generated by self-
228 weight of the beam is not considered in this study. In addition, it is assumed that the measured
229 time-dependent deflection is affected by the baseplate in a similar way as the elastic deformation,
230 i.e. 14% of total deformation (see Section 2.2.1). This is also taken into consideration in the
231 calculation of creep strain.

232 **2.3 Validation of test method**

233 In order to examine the validity of the proposed test method to characterize the creep behaviour
234 of cement paste, a comparative study was conducted, in which the MCBs made of commercial
235 objective glass with identical geometrical size ($1650 \mu\text{m} \times 300 \mu\text{m} \times 300 \mu\text{m}$) were fabricated
236 using the same preparation procedure described in section 2.1.2. Generally, the glass is expected
237 to exhibit no creep at room temperature [52]. Hence, any measured time-dependent deformation
238 for glass tests should be attributed to the inherent drift of the equipment or test set-up. The
239 typical curves of change in displacement with respect to the holding time for both the cement
240 paste and glass beams are compared in Figure 8. It is shown that the measured time-dependent
241 deformation for glass beams is very small compared to that of the cement paste beams. Also,
242 MCBs with higher w/c ratio exhibit higher creep displacement. This certifies that the test method
243 is able to evaluate the viscoelastic behaviour of materials. To quantify the intrinsic drift, five
244 glass beams were used as references and tested under the same constant load for each test series.
245 For instance, the average intrinsic drift rate of the glass beams, which includes any drift of the
246 apparatus and creep of the adhesive layer in particular, under the highest load (60 mN) was
247 $0.0789 \text{ nm/s} \pm 0.0066 \text{ nm/s}$ with a CoV of 8.4%. The total drift over an 800 s period was 63.12
248 $\text{ nm} \pm 5.28 \text{ nm}$, which is around 6% - 13% of the deflection of cement paste beams. Hereby, for
249 all the creep tests on cement paste, the measured creep displacements were adjusted to account
250 for the intrinsic drift rate according to the following equation:

$$\delta_c(t) = \gamma[\delta_m(t) - \delta_d(t)] \quad (7)$$

251 where $\delta_c(t)$, $\delta_m(t)$ and $\delta_d(t)$ are the corrected creep displacement, measured creep displacement
252 and drift displacement, respectively; γ is the coefficient accounting for the effects of the
253 baseplate, which is 0.86 in this study.

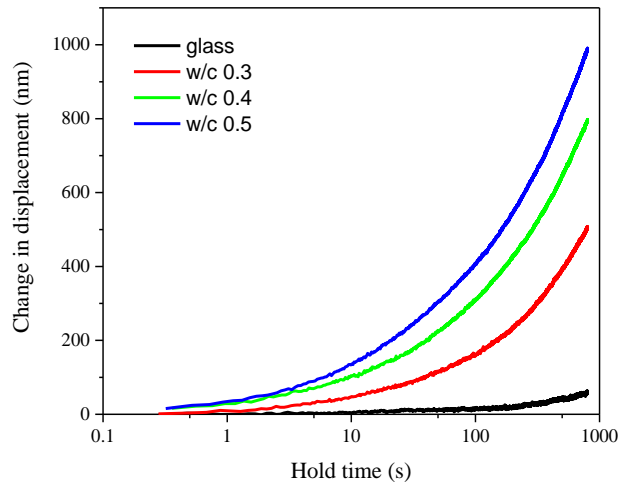

Figure 8: Comparison of the change in displacement for glass and cement paste beams

254
255
256 In addition, the possible time dependent penetration depth of the indenter during the constant
257 loading was also investigated. However, it seems difficult to distinguish the penetration depth
258 from the total displacement due to the heterogeneity of indented material and the specific
259 boundary conditions used in this study. Here, we performed a series of tests to indirectly
260 examine the development of indentation depth under the constant load. The analysis rests on the
261 hypothesis that the indentation depth, if it is at the same order of magnitude with beam
262 deflection, should randomly vary with the loading locations because of the different local
263 microstructures. Therefore, for each MCB, 10 parallel positions with an identical space (i.e. 30
264 μm) near the free end of beam were selected as the loading points. To minimize the effect of
265 shear deformation, longer beams, i.e. 1800 μm , were used. A trapezoidal load history with a
266 maximum load of 20 mN and a holding period of 20 s were applied on each loading point. The
267 applied stress level was around 20% of strength to ensure the individual tests staying within the
268 elastic limit. In this way, the change of displacements during the constant loading were obtained
269 for each loading point. Afterwards, the changes of displacements with respect to the loading
270 distance were fitted by a power law function passing through the origin, see Figure 9. It is found
271 that for each MCB the fitted line for measured changes of displacements at different loading
272 points has a determination coefficient of 0.92. This small variation implies that the indentation
273 creep displacement does exist but is insignificant compared to the total creep displacement. It
274 proves that the obtained creep deformation mainly originates from the beam deflection and the
275 penetration depth is, therefore, neglected in this study.

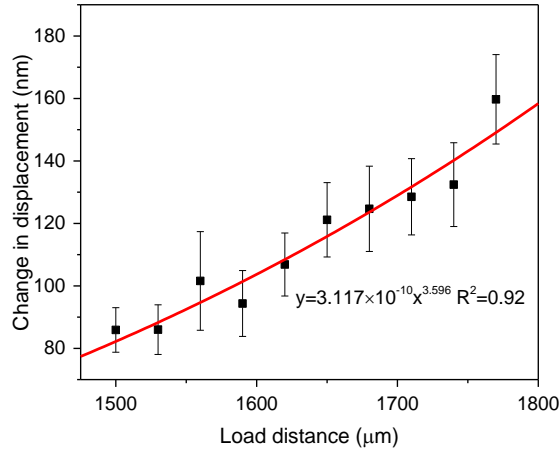

Figure 9: The variation of change in displacement with different loading distance

276
277

278 3. Results

279 3.1 Mechanical properties

280 For the monotonic loading tests, the flexural strength and static elastic modulus were obtained
 281 and shown in Table 1. The presented results are the average of 30 duplicate samples. The
 282 obtained mechanical properties are in good agreement with the results presented in literature
 283 [36,39]. For different w/b ratios, samples with higher w/b ratio exhibit lower strength and elastic
 284 modulus. The scatter of results, indicated by the coefficient of variation (CoV), increases with
 285 the w/b ratio. For the same w/b ratio, the mechanical properties of samples blended with GGBFS
 286 were slightly lower than the OPC samples at 28 days. Since the rate of hydration of blast-furnace
 287 slag mixed with water is initially lower than that of Portland cement, the blended cement paste
 288 containing blast-furnace slag shows lower strength at early age but similar or greater strength at
 289 later ages [53,54].

290 Table 1: The mechanical properties measured from the static tests

Material	w/b ratio	Static elastic modulus (GPa)	Flexural strength (MPa)
100% OPC	0.3	19.54 ± 1.49 (7.6%)	28.03 ± 2.67 (9.5%)
	0.4	16.19 ± 1.93 (11.9%)	23.32 ± 2.76 (11.8%)
	0.5	10.82 ± 2.51 (23.1%)	16.94 ± 3.73 (22.1%)
30% OPC + 70% GGBFS	0.3	17.01 ± 1.14 (6.7%)	25.43 ± 1.81 (7.1%)
	0.4	14.14 ± 1.57 (11.1%)	21.76 ± 3.01 (13.8%)
	0.5	8.99 ± 1.42 (15.8%)	14.25 ± 3.14 (22.1%)

291 **3.2 Specific basic creep compliance**

292 The specific basic creep compliance at 800 s for different w/b ratios and type of binders are
 293 shown in Figure 10. It can be seen that samples with higher w/b ratio exhibit larger basic creep
 294 compliance. The dependence of the creep behaviour on the w/c ratio is well known. Either the
 295 water content or the porosity of samples is believed to be the main reason for this [37,55–57].
 296 For a given w/b ratio, the basic creep compliance of samples blended with 70% slag is higher
 297 than the pure cement paste in this study. This is mostly related to the development of
 298 microstructure as also reflected by the mechanical properties. However, it should be noted that in
 299 the long-term, the addition of GGBFS may lead to similar or less basic creep due to the ongoing
 300 hydration [54].

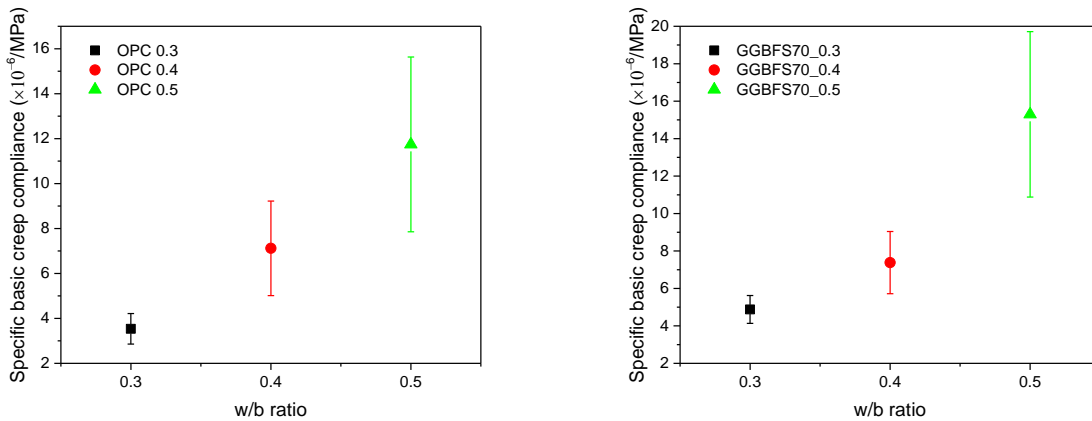

301
 302 Figure 10: The specific basic creep compliance measured at 800 s.

303 Figure 11 shows the evolution of specific creep compliance with respect to time for OPC beams
 304 with three w/c ratios. Note that the hold time in the plots refers to the time elapsed under the
 305 constant loading. When plotted in log-log scale, the curves of specific creep compliance are
 306 almost linear in spite of the small fluctuation in the first few seconds. This representation of the
 307 results indicates that the development of creep compliance during the time period tested (800s)
 308 can be fitted by a power-law creep function [6,17,19]:

$$C(t, t_0) = \alpha \left(\frac{t - t_0}{t_1} \right)^\beta \quad (8)$$

309 where t_0 is the age of the sample when the load reached the constant value; $t - t_0$ is the time
 310 elapsed under constant loading; t_1 is the time unit, i.e. 1 s. The α and β are fitting parameters,
 311 where α corresponds to the specific basic creep compliance at 1 second. For each case, the power
 312 function parameters were determined with a correlation coefficient greater than 0.99. Note that

313 the creep deformation during the loading stage is not considered in the creep function. The
 314 calculated apparent elastic modulus and two fitting parameters α and β for all test series are
 315 summarized in Table 2. It can be seen that the calculated apparent elastic modulus based on the
 316 loading slope of curves were almost identical with the static elastic modulus, as the two similar
 317 loading rates were used. The variability of apparent elastic modulus, in terms of CoV, are also
 318 consistent with the static elastic modulus for different w/b ratios and compositions. In addition,
 319 the parameter α as well as its standard deviation were found to increase with increasing w/b ratio.
 320 On the contrary, the exponent β varies a little and appears to be independent of w/b ratios and
 321 type of binder. This has also been reported in macroscopic tests [6,17,19] on cement paste.
 322 Moreover, when compared with the apparent elastic modulus for the same material composition,
 323 the variabilities of creep tests are larger.

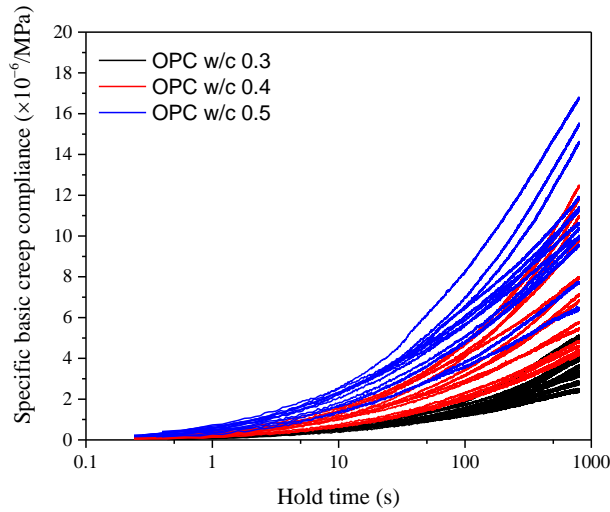

324
 325 Figure 11: The specific basic creep compliance with respect to the logarithmic time

326 Table 2: Apparent elastic modulus and fitting parameters α and β in Eq.(8)

Material	w/b	E_{apparent} (GPa)	α	β	Average R^2
100% OPC	0.3	19.64 ± 1.20 (6.1%)	0.23 ± 0.03 (13.6%)	0.39 ± 0.04 (10.7%)	0.9970
	0.4	15.49 ± 1.49 (9.6%)	0.51 ± 0.07 (15.0%)	0.39 ± 0.04 (10.8%)	0.9971
	0.5	10.20 ± 2.51 (21.4%)	1.19 ± 0.29 (24.6%)	0.36 ± 0.02 (5.2%)	0.9935
30% OPC + 70% GGBFS	0.3	18.75 ± 1.66 (8.8%)	0.31 ± 0.04 (13.2%)	0.39 ± 0.02 (5.4%)	0.9987
	0.4	15.03 ± 1.67 (11.2%)	0.55 ± 0.08 (15.4%)	0.38 ± 0.03 (7.8%)	0.9964
	0.5	9.22 ± 1.50 (16.2%)	1.24 ± 0.23 (18.5%)	0.39 ± 0.05 (14.4%)	0.9987

327 The rate of specific basic creep compliance with respect to time is shown in Figure 12. The
 328 decreasing trend with a slope around 0.61-0.64 is found in all creep tests. Zhang et al. [14]

329 compared the rate of creep compliance between the macroscopic compressive tests and the
330 microindentation tests on cement paste at the early stage of creep tests. It has been reported
331 [5,14] that for 0.38 w/c cement paste the slopes of creep compliance rate curves in macroscopic
332 tests and microindentation tests were 0.51 and 0.99, respectively. It seems that the obtained creep
333 compliance rate in this study is closer to the results of macroscopic tests.

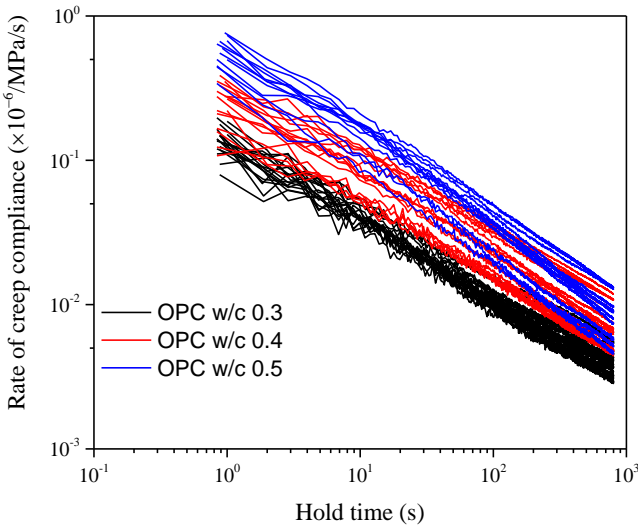

334
335 Figure 12: The creep rate of cement pastes with different w/c ratios

336 Figure 13 illustrates the effect of stress level on the measured ultimate creep strain at 800s for
337 w/b 0.4 OPC and blended paste. A linear relationship was found between the ultimate creep
338 strain and the stress level (from 12.5% to 67.9%). This indicates a linear viscoelastic
339 characteristic of cement paste at this length scale, which further proves that the developments of
340 microcracking and indentation depth during the constant loading are insignificant in current tests.
341 To the best knowledge of the authors, the linear viscoelasticity of cement paste has never been
342 examined microscopically. This examination cannot be accomplished by indentation tests
343 because the magnitude of the stresses below the indenter is independent of the applied maximal
344 load due to the self-similarity of the indenter [20]. For flexural creep tests at larger scale, several
345 studies [29,30,32,58] have confirmed that concrete beams with w/c from 0.3 to 0.5 exhibit linear
346 creep under the stress level below 40% - 50% of strength.

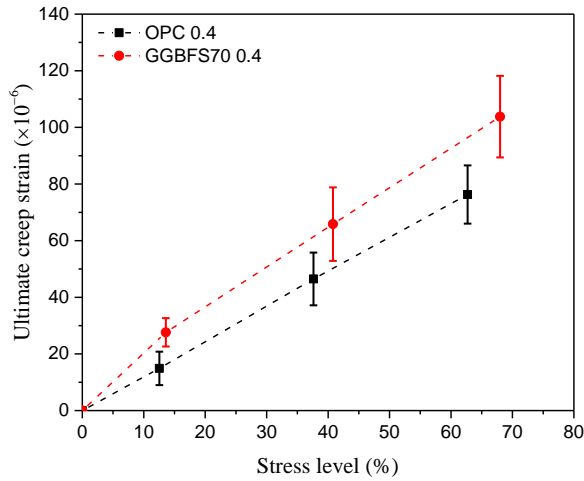

347 Figure 13: The effect of stress level on ultimate creep strain at 800 s for two paste series with w/b of 0.4.
 348

349 4. Discussion

350 4.1 On the variability of test results.

351 At the micro-scale, multiple solid phases and varying amounts of gel pores ($<0.01 \mu\text{m}$), capillary
 352 pores ($0.01 \mu\text{m}-10 \mu\text{m}$) and air voids ($>10 \mu\text{m}$) are recognised in the hardened cement paste.
 353 Hence, the variability in the measured data essentially arises from the selected small sampling
 354 volumes of this highly heterogeneous material. Nevertheless, it is still necessary to analyse the
 355 additional sources of variability of results, which also helps to gain a better understanding of the
 356 material behaviour at this scale. It is not surprising to see that the mechanical properties decrease
 357 with the increase of w/c ratio mainly because of the increasing capillary porosity [37,55–57].
 358 However, it is also found that the variation of both elastic modulus and flexural strength, in terms
 359 of CoV, increases with the w/c ratio. Similar observations have also been reported in other types
 360 of small-scale tests [36,39,42]. This is probably attributed to the pore size distributions for
 361 different w/c ratios. It should be noted that due to the small sampling volume ($300 \mu\text{m} \times 300 \mu\text{m}$
 362 $\times 1650 \mu\text{m}$) used in this study, the effect of capillary pores ($0.1 \mu\text{m}-10 \mu\text{m}$) on the mechanical
 363 properties of MCBs becomes more evident. According to the MIP test results from [46,57,59],
 364 the mean pore radius increases with the w/c ratio. It means that the largest size of the capillary
 365 pores would be larger for higher w/c ratio, whereas the smallest gel pores remain almost the
 366 same. Consequently, the dispersion range of the pore size for higher w/c ratio would be wider.
 367 Therefore, the higher w/c ratio may result in a wider range of capillary porosity and hence a

368 larger variability of mechanical properties. This explanation also holds for the blended cement
369 paste with GGBFS at the age of 28 days [60].

370 For the same material composition, the mean value and CoV of the apparent elastic modulus
371 measured prior to the creep tests are almost consistent with that of static elastic modulus.
372 However, there is a larger variation found in the results of creep tests, e.g. the ultimate creep
373 compliance at 800 s (Figure 10) and the fitting parameter α (Table 2). This seems reasonable as
374 there are different mechanisms involved in the elastic deformation and creep deformation of
375 cement paste. It is well known that the elastic modulus mainly depends on the porosity of
376 material [61], while the creep mechanism of cement paste is much more complicated and
377 depends on many factors. For the short term creep mechanism, several researchers [9,62]
378 suggested that the creep deformation may be due to a stress-induced redistribution of capillary
379 water within the pore structure of cement paste. However, it should be noted that the state of
380 water in cement paste considerably depends on the relative humidity [63,64]. In consideration of
381 the RH (31%) used in this study, the pore walls of the pore system, i.e. the surfaces of the
382 colloidal hydration products, are covered with one single mono-molecular layer of water [63].
383 Thus, the gel water instead of capillary water should play a dominant role in the creep process.
384 According to several proposed creep mechanisms in literature [12,13,25], the creep of cement
385 paste is largely affected by the movement and distribution of the gel water. In this context, it
386 seems plausible that factors affecting the distribution and transport of moisture, such as the
387 connectivity of pore structure, may lead to a larger variation of creep results.

388 **4.2 The power law function of creep**

389 The fact that the evolution of creep compliance can be expressed by a power function, at least for
390 the short term creep tests, has been observed in numerous macroscopic experiments for both
391 cement paste [6,17–19] and concrete [8,31,65]. A common finding of these short-term tests is
392 that the power-law exponent β is less sensitive to the compositions compared to the fitting
393 parameter α . For the cement paste, the range of variation for the exponent β reported in the
394 literature is very small, with most values falling between 0.20 and 0.40, which is very close to
395 the results in the current study, i.e. 0.36-0.39. More interestingly, a range of values between 0.30
396 and 0.45 has also been observed in concrete samples [31,65]. Moreover, Königsberger [28]
397 demonstrated, by using the downscaling homogenization method, that the hydrates at smaller

398 scale also exhibit a single power-law function with a creep exponent being surprisingly close to
399 the results tested in different cement pastes.

400 On the contrary, the parameter α , which corresponds to the creep compliance at unit time, is
401 found to be largely affected by the compositions of cement paste, degree of hydration and
402 moisture content [6,17–19]. It is also demonstrated by the multiscale studies of cementitious
403 materials that the constituents and microstructures significantly influence the macroscopic
404 viscoelastic behaviour [3,28,31,66,67]. At nanometre scale, Vandamme [2,20] stated that the
405 creep behaviour of the hydrated phases is largely determined by the packing density of C-S-H
406 particles. At the micro-scale, the cement paste is composed of the intrinsically viscoelastic C-S-
407 H gel particles, porosity and non-creeping inclusions, such as other hydration products and
408 unhydrated clinker. The macroscopic creep behaviour of cement paste is, therefore, determined
409 by the interactions among all these constituents. In particular, the porosity and non-creeping
410 inclusions influence the creep mainly by altering the internal stress field and moisture
411 distribution [19,28,67]. From this point of view, the apparent elastic modulus and residual
412 strength, which also depend on the porosity and volume fractions of inclusions, may be helpful
413 to interpret the creep results. Therefore, the relationships between the mechanical properties and
414 the inverse of parameter α in this study are plotted in Figure 14 (a) and (b). The inverse of α also
415 refers to the so-called creep modulus [17,20]. It can be seen that the inverse of α increases with
416 the increasing mechanical properties following a power-law function. Moreover, the scaling
417 relations are found to be independent of the w/c ratio and the addition of slag. These
418 observations are similar to the results in nanoindentation tests [2,20], in which the scaling
419 relations between the creep modulus and indentation properties are found to be independent of
420 the w/c, the heat treatment, or the addition of silica fumes or filler. Moreover, the calculated
421 contact creep modulus of C-S-H in nanoindentation tests is a power function of the indentation
422 modulus and linearly related to the indentation hardness [20]. These unique relationships imply
423 that there seems a common contributor that controls the overall elastic, plastic and viscoelastic
424 deformation at the investigated length scale, such as the gel or capillary porosity [2,20]. The
425 underlying microstructural effect on the creep behaviour could be properly demonstrated using
426 numerical approaches at different scales [15,19,67].

427
428

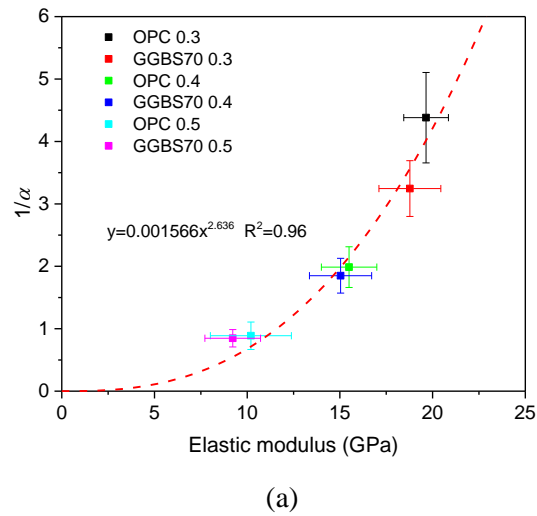

429
430

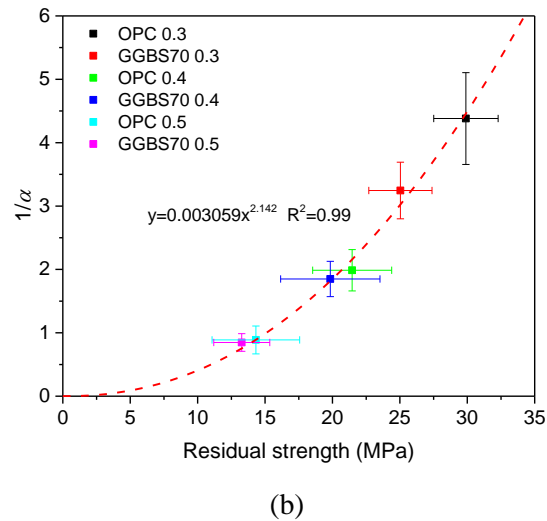

431
432

Figure 14: The relationship between the inverse of α and (a) the elastic modulus, and (b) the residual flexural strength

433 4.3 The comparisons with microindentation and macroscopic tests

434 In several experimental studies [29,30,32,51,58], it has been found that for the short-term creep,
435 the specific basic creep compliance measured in flexural creep tests could be compared directly
436 with the results in compressive creep tests, as they have similar order of magnitude during the
437 first few days. Here, the creep functions obtained in MCB bending tests, microindentation tests
438 [14,22] and macroscopic compressive tests [5,6,19] with similar material compositions and
439 loading age are directly compared and plotted in Figure 15. Even though the probed area in
440 microindentation tests [14,22] is almost at the same length scale with MCBs, a large quantitative
441 discrepancy is found in the measured specific basic creep compliance, see Figure 15(a). For

442 instance, the specific creep compliance of microindentation tests at 1000 s are almost two orders
 443 of magnitude higher than the results in MCB bending tests. Moreover, there is also a significant
 444 qualitative difference between these two tests. In microindentation tests, the obtained creep
 445 functions follow a short initial transition phase and a subsequent logarithmic creep. However, in
 446 this study, the power-law creep instead of logarithmic creep was observed.

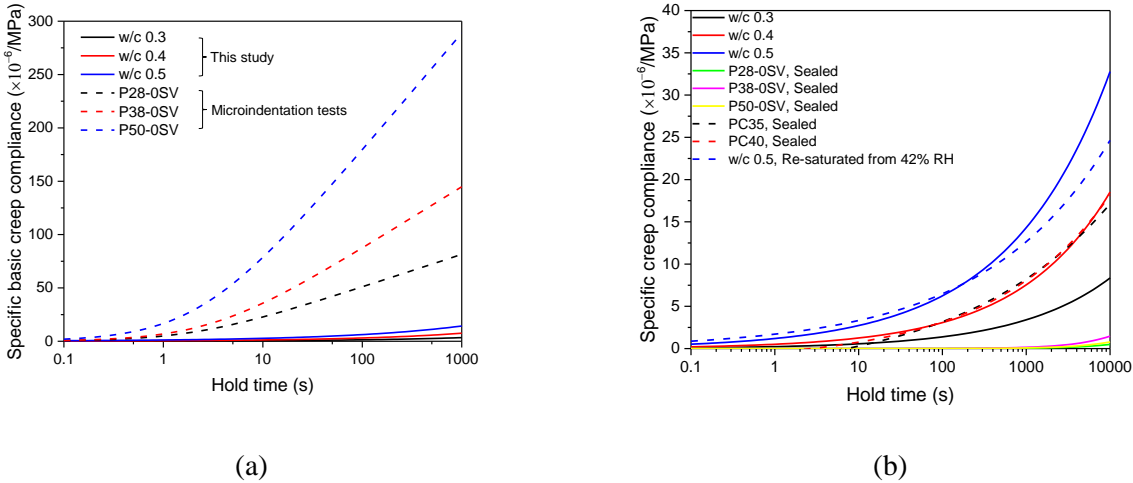

447 Figure 15: The comparison with (a) microindentation tests [14] and (b) macroscopic tests [6,14,19]. The
 448 numbers after the ‘P’ or ‘PC’ represent the w/c ratio.

449 This phenomenological feature of creep, i.e. the logarithmically evolved creep function, is
 450 believed to be associated with the long-term creep mechanism [9,20,68]. It can be captured in
 451 indentation test after only several seconds [14,20,35], while it costs days or even months for
 452 macroscopic cement paste [14] or concrete samples [23,68] to reach the logarithmic creep.
 453 Vandamme [20,69] suggests that the fact that the logarithmic creep can be captured in such a
 454 short time is probably because of the high magnitude of applied stresses in indentation tests,
 455 where the stress below the indenter is on the order of a few hundred MPa to around 1GPa [69].
 456 This is much higher than the generally applied stress in macroscopic tests and is assumed to
 457 significantly decrease the activation energies of the local microscopic relaxation sites, thus
 458 decreasing the characteristic time for long-term creep [69]. In this context, the creep function
 459 measured in this study should be more comparable with the macroscopic tests due to the
 460 equivalent applied stresses, i.e. 10 -30 MPa. As can be seen in Figure 15(b), the creep functions
 461 obtained in this study are very close to the most macroscopic results in literature despite the
 462 results in [14]. Note that a logarithmic function was used in [14], which appears to poorly fit the
 463 very initial part of specific basic creep compliance [17]. Therefore, the experimental data in

464 terms of specific basic creep compliance at 0.1 day (i.e. 8640 s) were directly compared and
 465 displayed in Figure 16. The observed consistency of the results confirms that the measured creep
 466 compliance in MCB bending tests are more representative for macroscopic tests regardless of the
 467 length scale. This is promising, as the creep behaviour of cementitious materials can be readily
 468 characterized by using the small-scale tests. Moreover, as suggested by [14,17], since the
 469 complete creep function is composed of initial short-term creep, described by a power-law
 470 function, and subsequent long-term creep, described by a logarithmic creep function, it might be
 471 possible to perform the small scale tests proposed in this study together with the indentation tests
 472 in [14,20] to fully characterize the creep function of cement paste at microscale.

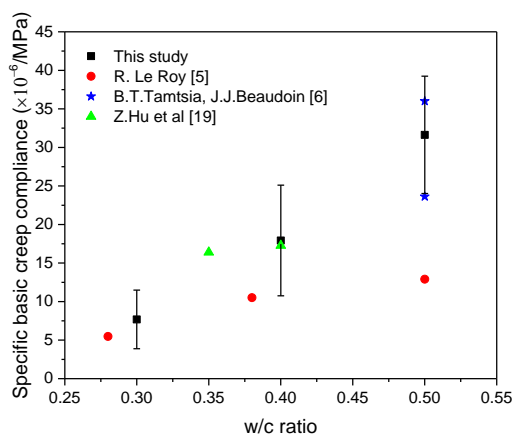

473
 474 Figure 16: The comparison with the specific basic creep compliance in macroscopic tests at 0.1 day.

475 4.4 Limitations and perspectives

476 Some limitations of the current method should be pointed out. Since the miniaturized
 477 samples are inevitably exposed to the ambient conditions during the tests, carbonation must have
 478 occurred at the surface layer of beams [70]. This is considered extremely important, especially
 479 with regard to the thin cross-sections adopted in this study, as substantial carbonation can
 480 significantly affect the deformations and microstructures of cement paste [71]. Note that the
 481 effect of carbonation may be more apparent in blended cement paste [71]. It is also expected that
 482 the short test duration and low RH used in this study may limit the effect of carbonation in the
 483 creep process, but the role of carbonation probably becomes more significant in the long-term
 484 creep tests. Another concern of the presented test method is that damage induced by shrinkage
 485 has been introduced in the samples before the tests, which may further increase uncertainties of
 486 the tests results [6]. The samples with different w/b ratios even exposed to the same RH may

487 accumulate different levels of damage during the drying process. Therefore, more efforts are
488 needed to quantify the effects of both carbonation and initial damage on the creep behaviour.
489 With regard to the sources of uncertainty, some of them may also originate from the imperfect
490 contact between the indenter tip and sample. In addition, it should be mentioned that, for the
491 short-term creep tests in this study, the effect of thermal drift is reduced to some extent by
492 performing a stabilization period prior to the creep test. However, for the long-term tests, the
493 effect of thermal drift may largely affect the results and there is no guarantee that the thermal
494 drift will remain constant during the long-term test. Therefore, the application of indentation
495 instruments may be limited for performing long-term measurements owing to the thermal drift.
496 Nevertheless, the current test method offers distinct advantages for characterizing the short-term
497 creep at microscale and provides experimental data for validation and calibration of multiscale
498 modelling approaches [28,36,72]. It is recommended, therefore, that future work should focus on
499 the combination of numerical and experimental investigations of the creep behaviour of
500 cementitious materials at different scales.

501 **Conclusions**

502 In this paper, minutes long micro-bending tests on miniaturized cantilever beams were used to
503 characterize the short-term creep behaviour of cement paste with different w/c ratios and types of
504 binder. The following conclusions can be drawn from the presented experimental studies:

- 505 • The proposed test method fills the experimental gap in characterizing the microscopic short-
506 term creep properties and also provides valuable insight into the creep behaviour of
507 cementitious materials at microscale.
- 508 • Even though it is well known that the creep intrinsically originates from the C-S-H
509 nanostructure, the good correlation between the mechanical properties and creep compliance
510 rate found in this study suggests that microstructural features may largely impact the creep
511 behaviour of cement paste at micro-scale.
- 512 • By comparing with the microindentation tests and conventional macroscopic compressive
513 creep tests on cement paste, it is shown that the micro-scale bending tests are both
514 qualitatively and quantitatively representative of macroscopic tests. The differences of
515 obtained creep between indentation tests and the current tests are assumed to be related to
516 the different applied stress levels, but further supporting evidence is still needed.

517 • The evolution of short-term specific basic creep compliance of cement paste with different
518 compositions can be captured appropriately by a power-law function with a constant
519 exponent. This is in line with findings in macroscopic tests. It is suggested that by
520 combining the short-term creep function obtained in this study with the long-term creep
521 function captured in microindentation tests, a complete non-ageing creep function at
522 microscale can be obtained.

523 Acknowledgements

524 Yidong Gan, Hongzhi Zhang and Yu Chen would like to acknowledge the funding supported by
525 China Scholarship Council under grant number 201706130140, 201506120067 and
526 201807720005, respectively. Mr. Arjan Thijssen is also gratefully acknowledged for his help
527 with the ESEM experiments.

528 Reference

- 529 [1] K. van Breugel, D. Koleva, T. van Beek, The ageing of materials and structures: Towards scientific
530 solutions for the ageing of our assets, 2017. doi:10.1007/978-3-319-70194-3.
- 531 [2] M. Vandamme, F.J. Ulm, Nanogranular origin of concrete creep, *Proc. Natl. Acad. Sci. U. S. A.* 106 (2009)
532 10552–10557. doi:10.1073/pnas.0901033106.
- 533 [3] H. Ye, Creep Mechanisms of Calcium–Silicate–Hydrate: An Overview of Recent Advances and Challenges,
534 *Int. J. Concr. Struct. Mater.* 9 (2015) 453–462. doi:10.1007/s40069-015-0114-7.
- 535 [4] Z.R. Bažant, G.H. Li, Comprehensive database on concrete creep and shrinkage, *ACI Mater. J.* 105 (2008)
536 635–637.
- 537 [5] R. Le Roy, Déformations instantanées et différées des bétons à hautes performances, (PhD Thesis) Ec. Natl.
538 Des Ponts Chaussées. (1996).
- 539 [6] B.T. Tamtsia, J.J. Beaudoin, Basic creep of hardened cement paste. A re-examination of the role of water,
540 *Cem. Concr. Res.* 30 (2000) 1465–1475. doi:10.1016/S0008-8846(00)00279-9.
- 541 [7] P. Klug, F. Wittmann, Activation energy of creep of hardened cement paste, *Matériaux Constr.* 2 (1969) 11–
542 16. doi:10.1007/BF02473650.
- 543 [8] P. Rossi, J.L. Tailhan, F. Le Maou, Creep strain versus residual strain of a concrete loaded under various
544 levels of compressive stress, *Cem. Concr. Res.* 51 (2013) 32–37. doi:10.1016/j.cemconres.2013.04.005.
- 545 [9] F.H. Wittmann, Shrinkage and Creep of Concrete: Mechanisms as Described on Different Structural Levels,
546 *Syst. Concr. Sci. Technol. through Multi-Scale Model.* (2015).
- 547 [10] Z.P. Bazant, M.H. Hubler, Theory of cyclic creep of concrete based on Paris law for fatigue growth of
548 subcritical microcracks, *J. Mech. Phys. Solids.* 63 (2014) 187–200. doi:10.1016/j.jmps.2013.09.010.
- 549 [11] G. Pickett, The Effect of Change in Moisture-Content on the Creep of Concrete Under a Sustained Load, *ACI*
550 *J. Proc.* 38 (1942) 333–357. doi:10.14359/8607.
- 551 [12] Z.P. Bažant, A.B. Hauggaard, S. Baweja, F.J. Ulm, Microprestress-solidification theory for concrete creep.
552 I: Aging and drying effects, *J. Eng. Mech.* 123 (1997) 1188–1194. doi:10.1061/(ASCE)0733-
553 9399(1997)123:11(1188).
- 554 [13] T.C. Powers, The thermodynamics of volume change and creep, *Matériaux Constr.* 1 (1968) 487–507.
555 doi:10.1007/BF02473638.
- 556 [14] Q. Zhang, R. Le Roy, M. Vandamme, B. Zuber, Long-term creep properties of cementitious materials:
557 Comparing microindentation testing with macroscopic uniaxial compressive testing, *Cem. Concr. Res.* 58
558 (2014) 89–98. doi:10.1016/j.cemconres.2014.01.004.
- 559 [15] Q.H. Do, S. Bishnoi, K.L. Scrivener, Microstructural Modeling of Early-Age Creep in Hydrating Cement
560 Paste, (2016). doi:10.1061/(ASCE)EM.1943-7889.0001144.
- 561 [16] O. Bernard, F.J. Ulm, J.T. Germaine, Volume and deviator creep of calcium-leached cement-based
562 materials, *Cem. Concr. Res.* 33 (2003) 1127–1136. doi:10.1016/S0008-8846(03)00021-8.

- 563 [17] M. Irfan-Ul-Hassan, B. Pichler, R. Reihnsner, C. Hellmich, Elastic and creep properties of young cement
564 paste, as determined from hourly repeated minute-long quasi-static tests, *Cem. Concr. Res.* 82 (2016) 36–49.
565 doi:10.1016/j.cemconres.2015.11.007.
- 566 [18] B.T. Tamtsia, J.J. Beaudoin, J. Marchand, The early age short-term creep of hardening cement paste : load-
567 induced hydration effects, 26 (2004) 481–489. doi:10.1016/S0958-9465(03)00079-9.
- 568 [19] Z. Hu, A. Hilaire, J. Ston, M. Wyrzykowski, P. Lura, K. Scrivener, Intrinsic viscoelasticity of C-S-H
569 assessed from basic creep of cement pastes, *Cem. Concr. Res.* 121 (2019) 11–20.
570 doi:10.1016/j.cemconres.2019.04.003.
- 571 [20] M. Vandamme, F.J. Ulm, Nanoindentation investigation of creep properties of calcium silicate hydrates,
572 *Cem. Concr. Res.* 52 (2013) 38–52. doi:10.1016/j.cemconres.2013.05.006.
- 573 [21] Y. Wei, S. Liang, X. Gao, Indentation creep of cementitious materials: Experimental investigation from
574 nano to micro length scales, *Constr. Build. Mater.* 143 (2017) 222–233.
575 doi:10.1016/j.conbuildmat.2017.03.126.
- 576 [22] Q. ZHANG, Creep properties of cementitious materials: effect of water and microstructure. An approach by
577 microindentation, (2014).
- 578 [23] Z.P. Bažant, M.H. Hubler, Q. Yu, Pervasiveness of excessive segmental bridge deflections: Wake-up call for
579 creep, *ACI Struct. J.* 108 (2011) 766–774.
- 580 [24] F.H. Wittmann, Creep and shrinkage mechanisms, *Creep Shrinkage Concr. Struct.* (1982) 129–161.
- 581 [25] W. Ruetz, A hypothesis for the creep of hardened cement paste and the influence of simultaneous shrinkage,
582 *Proc. Struct. Concr. Its Behav. under Load.* (1968) 365–387.
- 583 [26] H.M. Jennings, Colloid model of C-S-H and implications to the problem of creep and shrinkage, *Mater.*
584 *Struct. Constr.* 37 (2004) 59–70.
- 585 [27] M. Vandamme, M. Vandamme, Two models based on local microscopic relaxations to explain long-term
586 basic creep of concrete Subject Areas : Author for correspondence :, (2018).
- 587 [28] M. Königsberger, M. Irfan-ul-Hassan, B. Pichler, C. Hellmich, Downscaling based identification of
588 nonaging power-law creep of cement hydrates, *J. Eng. Mech.* 142 (2016) 1–11.
589 doi:10.1061/(ASCE)EM.1943-7889.0001169.
- 590 [29] Y. Wei, D. Ph, M. Asce, Z. Wu, J. Huang, S. Liang, Comparison of Compressive , Tensile , and Flexural
591 Creep of Early-Age Concretes under Sealed and Drying Conditions, 30 (2018) 1–13.
592 doi:10.1061/(ASCE)MT.1943-5533.0002495.
- 593 [30] S. Liang, Y. Wei, Methodology of obtaining intrinsic creep property of concrete by flexural deflection test,
594 *Cem. Concr. Compos.* 97 (2019) 288–299. doi:10.1016/j.cemconcomp.2019.01.003.
- 595 [31] L. Su, Y. feng Wang, S. qi Mei, P. fei Li, Experimental investigation on the fundamental behavior of
596 concrete creep, *Constr. Build. Mater.* 152 (2017) 250–258. doi:10.1016/j.conbuildmat.2017.06.162.
- 597 [32] N. Ranaivomanana, S. Multon, A. Turatsinze, Basic creep of concrete under compression , tension and
598 bending, *Constr. Build. Mater.* 38 (2013) 173–180. doi:10.1016/j.conbuildmat.2012.08.024.
- 599 [33] C. Pichler, R. Lackner, Identification of Logarithmic-Type Creep of Calcium-Silicate-Hydrates by Means of
600 Nanoindentation, (2009) 17–25.
- 601 [34] J. Němeček, Creep effects in nanoindentation of hydrated phases of cement pastes, *Mater. Charact.* 60
602 (2009) 1028–1034. doi:10.1016/j.matchar.2009.04.008.
- 603 [35] C.A. Jones, Z.C. Grasley, Short-term creep of cement paste during nanoindentation, *Cem. Concr. Compos.*
604 33 (2011) 12–18. doi:10.1016/j.cemconcomp.2010.09.016.
- 605 [36] H. Zhang, B. Šavija, S.C. Figueiredo, E. Schlangen, Experimentally validated multi-scale modelling scheme
606 of deformation and fracture of cement paste, *Cem. Concr. Res.* 102 (2017) 175–186.
607 doi:10.1016/j.cemconres.2017.09.011.
- 608 [37] H. Zhang, B. Šavija, E. Schlangen, Combined experimental and numerical study on micro-cube indentation
609 splitting test of cement paste, *Eng. Fract. Mech.* 199 (2018) 773–786.
610 doi:10.1016/j.engfracmech.2018.04.018.
- 611 [38] H. Zhang, Y. Gan, Y. Xu, S. Zhang, E. Schlangen, B. Šavija, Experimentally informed fracture modelling of
612 interfacial transition zone at micro-scale, *Cem. Concr. Compos.* 104 (2019) 103383.
613 doi:10.1016/j.cemconcomp.2019.103383.
- 614 [39] Y. Gan, H. Zhang, B. Šavija, E. Schlangen, K. van Breugel, Static and Fatigue Tests on Cementitious
615 Cantilever Beams Using Nanoindenter, *Micromachines* . 9 (2018). doi:10.3390/mi9120630.
- 616 [40] H. Zhang, B. Šavija, Y. Xu, E. Schlangen, Size effect on splitting strength of hardened cement paste:
617 Experimental and numerical study, *Cem. Concr. Compos.* 94 (2018) 264–276.
618 doi:10.1016/j.cemconcomp.2018.09.018.

- 619 [41] J. Němeček, V. Králík, V. Šmilauer, L. Polívka, A. Jäger, Tensile strength of hydrated cement paste phases
620 assessed by micro-bending tests and nanoindentation, *Cem. Concr. Compos.* 73 (2016) 164–173.
621 doi:10.1016/j.cemconcomp.2016.07.010.
- 622 [42] H. Zhang, B. Šavija, S.C. Figueiredo, M. Lukovic, E. Schlangen, Microscale testing and modelling of
623 cement paste as basis for multi-scale modelling, *Materials (Basel)*. 9 (2016). doi:10.3390/ma9110907.
- 624 [43] H. Zhang, Y. Xu, Y. Gan, Z. Chang, E. Schlangen, B. Šavija, Combined experimental and numerical study
625 of uniaxial compression failure of hardened cement paste at micrometre length scale, *Cem. Concr. Res.* 126
626 (2019). doi:10.1016/j.cemconres.2019.105925.
- 627 [44] H. Zhang, B. Šavija, E. Schlangen, Towards understanding stochastic fracture performance of cement paste
628 at micro length scale based on numerical simulation, *Constr. Build. Mater.* 183 (2018) 189–201.
629 doi:10.1016/j.conbuildmat.2018.06.167.
- 630 [45] B. Šavija, H. Zhang, E. Schlangen, Micromechanical testing and modelling of blast furnace slag cement
631 pastes, *Constr. Build. Mater.* 239 (2020). doi:10.1016/j.conbuildmat.2019.117841.
- 632 [46] R.A. Cook, K.C. Hover, Mercury porosimetry of hardened cement pastes, 29 (1999) 933–943.
- 633 [47] L.S. Stephens, K.W. Kelly, S. Simhadri, A.B. McCandless, E.I. Meletis, Mechanical property evaluation and
634 failure analysis of cantilevered LIGA nickel microposts, *J. Microelectromechanical Syst.* 10 (2001) 347–
635 359. doi:10.1109/84.946780.
- 636 [48] M. Gan, V. Tomar, Role of length scale and temperature in indentation induced creep behavior of polymer
637 derived Si-C-O ceramics, *Mater. Sci. Eng. A.* 527 (2010) 7615–7623. doi:10.1016/j.msea.2010.08.016.
- 638 [49] J.A. Almudaiheem, W. Hansen, Effect of Specimen Size and Shape on Drying Shrinkage of Concrete., *ACI*
639 *Mater. J.* 84 (1987) 130–135.
- 640 [50] W. HANSEN, Drying Shrinkage Mechanisms in Portland Cement Paste, *J. Am. Ceram. Soc.* 70 (1987) 323–
641 328. doi:10.1111/j.1151-2916.1987.tb05002.x.
- 642 [51] C.H. Un, J.G. Sanjayan, R.S. Nicolas, J.S.J. Van Deventer, Mini-Beam Test for Assessing the Creep Trend
643 of Paste, Mortar, and Concrete, *CONCREEP 2015 Mech. Phys. Creep, Shrinkage, Durab. Concr. Concr.*
644 *Struct. - Proc. 10th Int. Conf. Mech. Phys. Creep, Shrinkage, Durab. Concr. Concr. Struct.* (2015) 1350–
645 1359. doi:10.1061/9780784479346.160.
- 646 [52] W. Cooke, P. Howell, Viscoelastic behaviour of glass and “fictive temperature,” *Math. Ind.* 372 (1998) 22.
647 <http://www.maths-in-industry.org/miis/372/>.
- 648 [53] G. Men, V. Bonavetti, E.F. Irassar, Strength development of ternary blended cement with limestone filler
649 and blast-furnace slag, 25 (2003) 61–67.
- 650 [54] E. Özbay, M. Erdemir, H.I. Durmuş, Utilization and efficiency of ground granulated blast furnace slag on
651 concrete properties - A review, *Constr. Build. Mater.* 105 (2016) 423–434.
652 doi:10.1016/j.conbuildmat.2015.12.153.
- 653 [55] R. Kumar, B. Bhattacharjee, Porosity, pore size distribution and in situ strength of concrete, *Cem. Concr.*
654 *Res.* 33 (2003) 155–164. doi:10.1016/S0008-8846(02)00942-0.
- 655 [56] I. Odler, M. Rößler, Investigations on the relationship between porosity, structure and strength of hydrated
656 Portland cement pastes. II. Effect of pore structure and of degree of hydration, *Cem. Concr. Res.* 15 (1985)
657 401–410. doi:10.1016/0008-8846(85)90113-9.
- 658 [57] G. Ye, Experimental study and numerical simulation of the development of the microstructure and
659 permeability of cementitious materials, 2003.
- 660 [58] N. Ranaivomanana, S. Multon, A. Turatsinze, Tensile, compressive and flexural basic creep of concrete at
661 different stress levels, *Cem. Concr. Res.* 52 (2013) 1–10. doi:10.1016/j.cemconres.2013.05.001.
- 662 [59] B. Kondraivendhan, B. Bhattacharjee, Effect of Age and Water-Cement Ratio on Size and Dispersion of
663 Pores in Ordinary Portland Cement Paste, (2011).
- 664 [60] N. De Belie, J. Kratky, S. Van Vlierberghe, Influence of pozzolans and slag on the microstructure of
665 partially carbonated cement paste by means of water vapour and nitrogen sorption experiments and BET
666 calculations, *Cem. Concr. Res.* 40 (2010) 1723–1733. doi:10.1016/j.cemconres.2010.08.014.
- 667 [61] D.P.H. HASSELMAN, Relation Between Effects of Porosity on Strength and on Young’s Modulus of
668 Elasticity of Polycrystalline Materials, *J. Am. Ceram. Soc.* 46 (1963) 564–565. doi:10.1111/j.1151-
669 2916.1963.tb14615.x.
- 670 [62] E.J. SELLEVOLD, C.W. RICHARDS, Short-Time Creep Transition for Hardened Cement Paste, *J. Am.*
671 *Ceram. Soc.* 55 (1972) 284–289. doi:10.1111/j.1151-2916.1972.tb11285.x.
- 672 [63] K. Van Breugel, Simulation of hydration and formation of structure in hardening cement-based materials.,
673 (1993).
- 674 [64] J.J. Thomas, S.A. FitzGerald, D.A. Neumann, R.A. Livingston, State of Water in Hydrating Tricalcium

- 675 Silicate and Portland Cement Pastes as Measured by Quasi-Elastic Neutron Scattering, *J. Am. Ceram. Soc.*
676 84 (2004) 1811–1816. doi:10.1111/j.1151-2916.2001.tb00919.x.
- 677 [65] F.H. Wittmann, J. Lukas, The Application of Rate Theory to Time-Dependent Deformation of Concrete,
678 *Mag. Concr. Res.* 26 (1974) 191–197. doi:10.1680/mac.1974.26.89.191.
- 679 [66] M. Irfan-ul-hassan, M. Königsberger, R. Reihnsner, C. Hellmich, M. Asce, B. Pichler, A.M. Asce, How
680 Water-Aggregate Interactions Affect Concrete Creep: Multiscale Analysis, 7 (2017) 1–16.
681 doi:10.1061/(ASCE)NM.2153-5477.0000135.
- 682 [67] A.B. Giorla, C.F. Dunant, Microstructural effects in the simulation of creep of concrete, *Cem. Concr. Res.*
683 105 (2018) 44–53. doi:10.1016/j.cemconres.2017.12.001.
- 684 [68] J.M. Torrenti, R. Le Roy, Analysis of some basic creep tests on concrete and their implications for
685 modeling, *Struct. Concr.* 19 (2018) 483–488. doi:10.1002/suco.201600197.
- 686 [69] M. Vandamme, Two models based on local microscopic relaxations to explain long-term basic creep of
687 concrete Subject Areas : Author for correspondence :, (2018).
- 688 [70] V. Rostami, Y. Shao, A.J. Boyd, Z. He, Microstructure of cement paste subject to early carbonation curing,
689 *Cem. Concr. Res.* 42 (2012) 186–193. doi:10.1016/j.cemconres.2011.09.010.
- 690 [71] B. Šavija, M. Luković, Carbonation of cement paste: Understanding, challenges, and opportunities, *Constr.*
691 *Build. Mater.* 117 (2016) 285–301. doi:10.1016/j.conbuildmat.2016.04.138.
- 692 [72] S. Scheiner, C. Hellmich, A.M. Asce, Continuum Microviscoelasticity Model for Aging Basic Creep of
693 Early-Age Concrete, 135 (2009).
- 694