



**HAL**  
open science

# Engineering of Membrane Gas Separation Processes: State of The Art and Prospects

Christophe Castel, Roda Bounaceur, Eric Favre

► **To cite this version:**

Christophe Castel, Roda Bounaceur, Eric Favre. Engineering of Membrane Gas Separation Processes: State of The Art and Prospects. Journal of Membrane Science and Research, 2020, 10.22079/JMSR.2020.123897.1363 . hal-02873050

**HAL Id: hal-02873050**

**<https://hal.science/hal-02873050v1>**

Submitted on 18 Jun 2020

**HAL** is a multi-disciplinary open access archive for the deposit and dissemination of scientific research documents, whether they are published or not. The documents may come from teaching and research institutions in France or abroad, or from public or private research centers.

L'archive ouverte pluridisciplinaire **HAL**, est destinée au dépôt et à la diffusion de documents scientifiques de niveau recherche, publiés ou non, émanant des établissements d'enseignement et de recherche français ou étrangers, des laboratoires publics ou privés.



Review Paper

## Engineering of Membrane Gas Separation Processes: State of The Art and Prospects

Christophe Castel, Roda Bounaceur, Eric Favre \*

LRGP-CNRS Université de Lorraine, 1 rue Grandville, 54001 Nancy, FRANCE

## Article info

Received 2020-04-01  
 Revised 2020-05-29  
 Accepted 2020-06-02  
 Available online 2020-06-02

## Keywords

Membrane  
 Gas  
 Separations  
 Engineering  
 Process  
 Simulation

## Highlights

- Historical overview of membrane gas separations
- PSE methodology is analyzed
- Process synthesis methods are reviewed
- Future challenges are discussed

## Graphical abstract

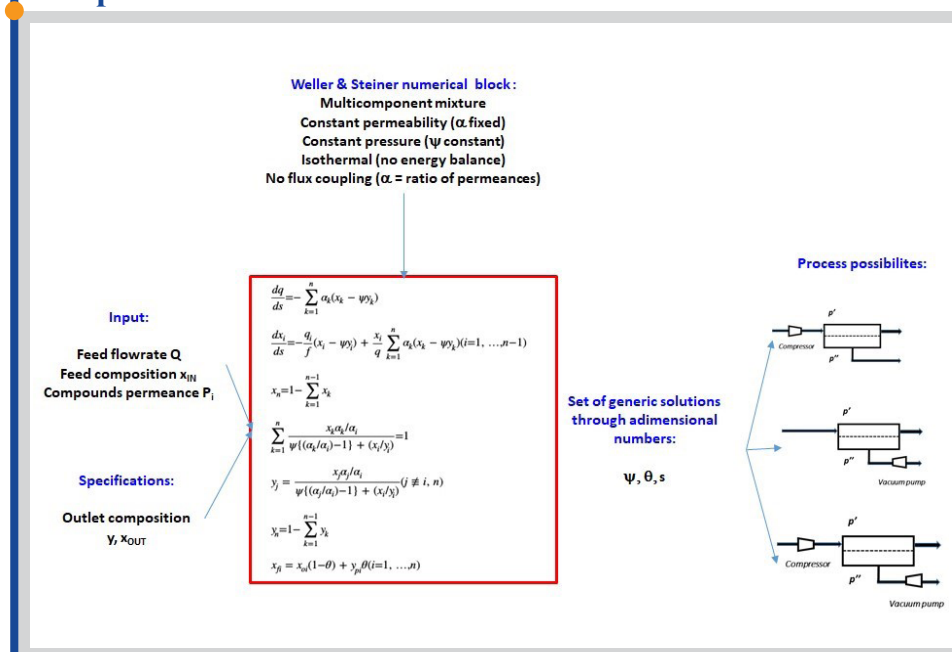

## Abstract

Membrane processes are today one of the key technologies for industrial gas separations and show growing interest for future use in sustainable production systems. Besides materials development, dedicated engineering methods are of major importance for the rigorous and most efficient design of membrane units and systems. Starting from approaches based on simplified hypotheses developed in the 50's, modelling and simulation tools for membrane gas separations have gradually evolved, up to modern process synthesis softwares and programs. In this paper, an overview of major industrial applications and associated simulation approaches of membrane gas separations is first proposed. In a second step, the current possibilities and limitations of Process Systems Engineering (PSE) softwares is detailed. The necessity to take into account specificities such as variable permeability, pressure drop effects and/or non-isothermal conditions is discussed. Perspectives offered by recent process synthesis methods are finally analysed, with an emphasis on challenges such as multicomponent, multi-membrane, multi-operation processes (such as hybrid processes). The role of membrane gas separation engineering methods and new opportunities for future applications are discussed.

© 2020 MPRL. All rights reserved.

## Contents

1. Introduction: an historical overview of materials and engineering methods for of membrane gas separations.....	1
2. Membrane gas separations: state of the art and engineering approaches.....	1
2.1. Membranes, modules and industrial applications.....	1
2.2. From membrane materials to process: overall framework.....	1
2.3. Engineering methods: Weller & Steiner.....	1

\* Corresponding author: Eric.Favre@univ-lorraine.fr (E. Favre)

2.4. Engineering methods: from computer programs to PSE.....	1
2.5. Engineering methods: Module design.....	1
2.6. Engineering methods: Process synthesis.....	1
3. Conclusion & perspectives.....	1
References.....	1

## 1. Introduction: an historical overview of materials and engineering methods for of membrane gas separations

The concept of membrane gas separations can be dated back 1866, when Thomas Graham suggested in a visionary paper the use of polymers (natural rubber at that time) to separate gas mixtures [1]. Graham indeed had observed the differences in the rate of collapse of a rubber balloon when filled by different pure gases. He simultaneously proposed to extend the solution-diffusion model, previously proposed by von Vroblewski for the interpretation of gas bubbles collapse rate [2], to explain mass transfer mechanism in natural rubber. It is noticeable that this early explanation remains today the cornerstone of mass transfer models in dense polymers, both for liquids and gases [3].

It took however a very long time for the idea of Graham to become reality. A first large scale, very special application of membranes for gas separations effectively took place during World War II. The target, namely uranium isotopes enrichment for nuclear application, the context and the final engineering solution are very specific [4]. The achievement of isotope separation by microporous inorganic materials is often presented has a landmark of the chemical engineering discipline [5]; from the membrane science point of view, both the material, separation mechanism and process are unique. Gas diffusion through Knudsen mechanism into inorganic materials has not been performed for industrial applications since that time. Moreover, a membrane process based on more than 1000 stages (up to 1400 for military applications) is still unique today. This development, part of Manhattan project, played however a key role in the development of engineering methods for membrane processes. A large part of the engineering concepts used for the design of membrane separations today (such as membrane selectivity, stage cut, pressure ratio, module staging, etc.) is detailed in the reports and studies performed at that time [6].

Apart from the very peculiar uranium enrichment application exposed above, the beginning of the new age of membrane gas separations started in the 50's with strong research efforts in academic institutions. Barrer and van Amerongen, among others, systematically investigated mass transfer mechanisms and separation performances of inorganic and polymeric materials at lab scale [7]. From the engineering point of view, the basis of a rigorous design methodology was proposed by Weller and Steiner in 1950 in a seminal paper [8]. Nevertheless, a major bottleneck was soon identified to block the application of membranes in industry: a very thin active layer (typically less than 1  $\mu\text{m}$ ) was absolutely necessary in order to achieve a significant productivity of the process. The solution to this material challenge was incidentally found by Loeb and Sourirajan in 1961, for water desalination by reverse osmosis [9]. The technique was later extended by Dupont researchers for thin skin membrane materials and hollow fibers or spiral wound reverse osmosis module design. This pioneering work opened the way to industrial module production and the first large scale application of polymeric membrane gas separations is usually attributed to Permea in 1979 with the recovery of hydrogen from purges in a Monsanto ammonia production plant [10]. Coming back to Graham vision in 1866, it can thus be stated that it took around hundred years to translate the idea into a real industrial application. The successful Permea operation unlocked the gradual deployment of membrane gas separations in industry. Some six decades after, membranes are one of the key technologies for gas separations, in competition or in association to other technologies such as cryogeny, absorption and adsorption [11].

The objective of this paper is to discuss and analyse the evolution and the role of engineering methods and tools in the diffusion of membrane gas separations to solve industrial problems. More specifically, the possibilities and limitations of modelling and simulation programs and softwares will be critically exposed. The different aspects that have to be taken into account for the prediction of the separation performances of a membrane process: membrane mass transfer mechanisms, hydrodynamics, energy balance, systems design and/or optimization will be critically discussed. Starting from the baseline approach developed by Weller & Steiner in 1950, the gradual changes and improvements of engineering methods will be reviewed. A series of current and future challenges will finally be tentatively proposed.

Compared to the research efforts and developments of membrane materials, membrane gas engineering may look of minor interest, with proven and mature methods developed for a long time. It is the objective of this short critical review to show that engineering methods are of drastic importance for

membrane development and currently still show breakthrough advances.

## 2. Membrane gas separations: state of the art and engineering approaches

### 2.1. Membranes, modules and industrial applications

It has been stated above that membrane gas separations have shown a strong deployment into numerous industrial sectors, starting from the first Permea/Monsanto industrial application in 1979. Today, the market of membrane gas separations is estimated to be over 1 billion \$ per year, with an annual growth rate around 8-10% these years [12]. Interestingly, the market is expected to greatly increase in the future. Membrane processes indeed show decisive arguments in a sustainable production framework:

- No chemicals are needed to achieve the separation, which is based on a strict physical process. Consequently, there is no waste generation (such as, for instance, due to chemicals degradation)
- The separation process is continuous and the process energy efficiency can be high (providing however that the membrane process is used at the right place for the right role [13])
- Membrane processes are of great interest for process intensification purposes, compared to traditional techniques (such as absorption)
- The start and stop operation of a membrane gas unit is fast and easy. This offers a large flexibility for production purposes or for on demand operation
- Finally, process scale up is very simple because it is by essence modular that is based on numbering. Changes in production capacity are thus easily achievable compared to scaled operations such as cryogeny or absorption for instance. An increase or decrease of the number of operating membrane modules can be applied in order to fit the target production level.

Besides the favourable process characteristics and industrial environment exposed above, the current state of the art of membrane gas processes shows however several limitations for an extended use:

- The number of commercially available membrane materials is very limited (typically less than 10 types of polymeric membranes, compared to the thousands of materials investigated at lab scale)
- The number of equipment suppliers is very limited (typically less than 10)
- Most of the commercially available membranes have been developed years ago (even if significant performance improvements have been operated on the few commercial membrane types and grades in the meanwhile)
- Commercially available membrane materials are almost exclusively based on dense polymers, which make use of a physical mechanism for separation purposes. Inorganic membranes (such as zeolites or palladium) or chemically reacting membrane materials (such as liquid membranes or Fixed Site Reaction Membranes) are almost unused
- The market is limited to a few applications (typically less than 5 categories)

It is obvious that the previous items are likely to generate a limitation to a more massive deployment and selection of membrane processes in industry. Table 1 summarizes the main current membrane materials and applications. The specificities of the materials, modules and the associated process context will be taken into account in the next paragraph in order to better evaluate the needs and impact of engineering methods.

### 2.2. From membrane materials to process: overall framework

The possibility to use or design a membrane material is the obvious starting point of any membrane gas separation project. There is however a long way from a (new) membrane material to a real industrial process. The difficulties and pitfalls linked to the industrial production of a membrane, starting from a given polymer thick film, have been lucidly explained by Baker [12] and will not be further detailed here. In parallel to materials

design, there is a strong need to answer the key question of the interest of a given material for a target application. This step has to be performed as soon as possible, in order to clearly estimate the potential interest of a new material, before starting a long and costly membrane development project. In order to address the key question of the interest of a membrane material for an application, a sound and liable engineering methodology is of crucial importance and is detailed hereafter.

Figure 1 summarizes a simplified succession of steps that go from membrane material performances to process design and selection. Starting from the specifications of the target application (mixture composition, flowrate, separation performances), membrane performances have first to be defined, though a set of representative permeance data (#1 in Figure 1). This step is critical, because the data available in open literature almost systematically correspond to pure gas permeability, obtained on thick self-standing materials. It is of primary importance to use effective permeance data, corresponding to real mixtures separated by a thin film (usually composite) membrane material. When such data are not available, estimates of effective permeability data have to be used. A classical approach consists to use a pure gas permeability data (P) from literature and assume a given active layer thickness (z) in order to get a compound permeance value ( $P = P/z$ ), the only membrane variable needed for each compound. This strategy may generate significant errors on performance predictions.

When permeance data and operating conditions are defined, process simulations can be performed (step III). This step clearly requires adequate engineering methods, which have evolved through the years and will be detailed hereafter. It is essential at this stage to apply simulations with a carefully balanced strategy, combining precise enough calculations, together with minimal complexity and taking into account the availability of key data. This point will be illustrated in the next section. The process design step usually generates a set of solutions that fits the specifications; it is then necessary to sort the possible configurations so that the most interesting solution is identified. This step, noted IV in Figure 1, requires a technico-economic approach and shows again a difficulty due to unknowns such as membrane cost, pre-treatment operations and /or membrane lifetime. Finally, the cost of the best membrane process has to be compared to competing technologies in the final process selection step (step V). It is important to note at this point that there is globally a lack of robust and liable process comparison studies, such as illustrated in step V of Figure 1. Several reasons contribute to this matter of fact: realistic cost functions for a given process are often confidential and technico-economic studies are usually limited to one process, due to the different interests and practice among scientific communities (for instance adsorption process community journals and congresses are globally separate from membrane community).

On Figure 1, the place and role of engineering methods can be hopefully better understood. Schematically, engineering methods and tools are

expected to offer two main functions:

- i) Achieve rigorous process simulations (step II and III), in order to generate realistic and representative performance data. This is a typical process modelling and simulation task.
- ii) Identify the best solution, based on a techno-economical study (step IV). This corresponds to a classical optimization problem.

The different methods and tools developed in order to achieve the above function i) and/or ii) are developed below.

### 2.3. Engineering methods: Weller & Steiner

The first engineering approach dedicated to membrane gas separations modelling and design (step II and III in Figure 1) has been proposed by Weller and Steiner in 1950 [8]. This approach still remains of major interest because it fits phenomena of a physical separation process, such as dense polymeric membranes (Table 1). Moreover, it can often quickly offer a realistic evaluation of the separation performances of a given membrane module in a great number of cases. The engineering method is based on a set of six hypotheses:

- i) Binary mixture condition, which largely simplifies the analysis through a single membrane selectivity data ( $\alpha = P_1/P_2$ )
- ii) Ideal gas phase conditions
- iii) Isothermal conditions (no energy balance required)
- iv) Constant pressure into each compartment (leading to a constant pressure ratio  $\Psi$ )
- v) Negligible boundary layer resistance (i.e. the membrane material corresponds to the only mass transfer resistance)
- vi) Constant permeance for each compound (no dependence upon pressure,  $P_1$  and  $P_2$  are assumed to be constant)

The only conditions that then remains to be defined corresponds to fluid flow characteristics, in order to express the differential mass balances. Perfectly mixed or plug-flow conditions lead to 5 different possibilities, which will impact the separation performances of a membrane module. From a practical point of view, a perfectly mixed module (retentate and permeate side) shows the lowest separation performances and can be computed through a simple analytical solution for a binary mixture. The best performances are obtained by counter-current plug flow and require a numerical resolution of a set of algebro-differential equations. For practical purposes, cross plug flow or counter current flow are most often used for simulations, because they are close to the real performances of industrial modules [11].

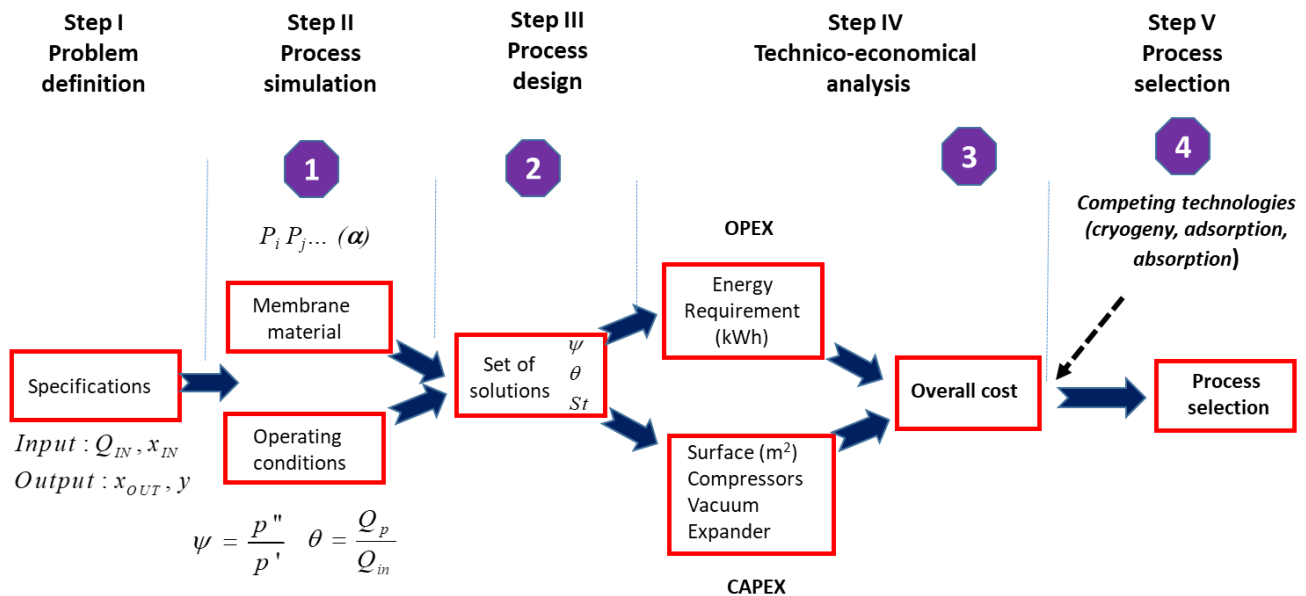
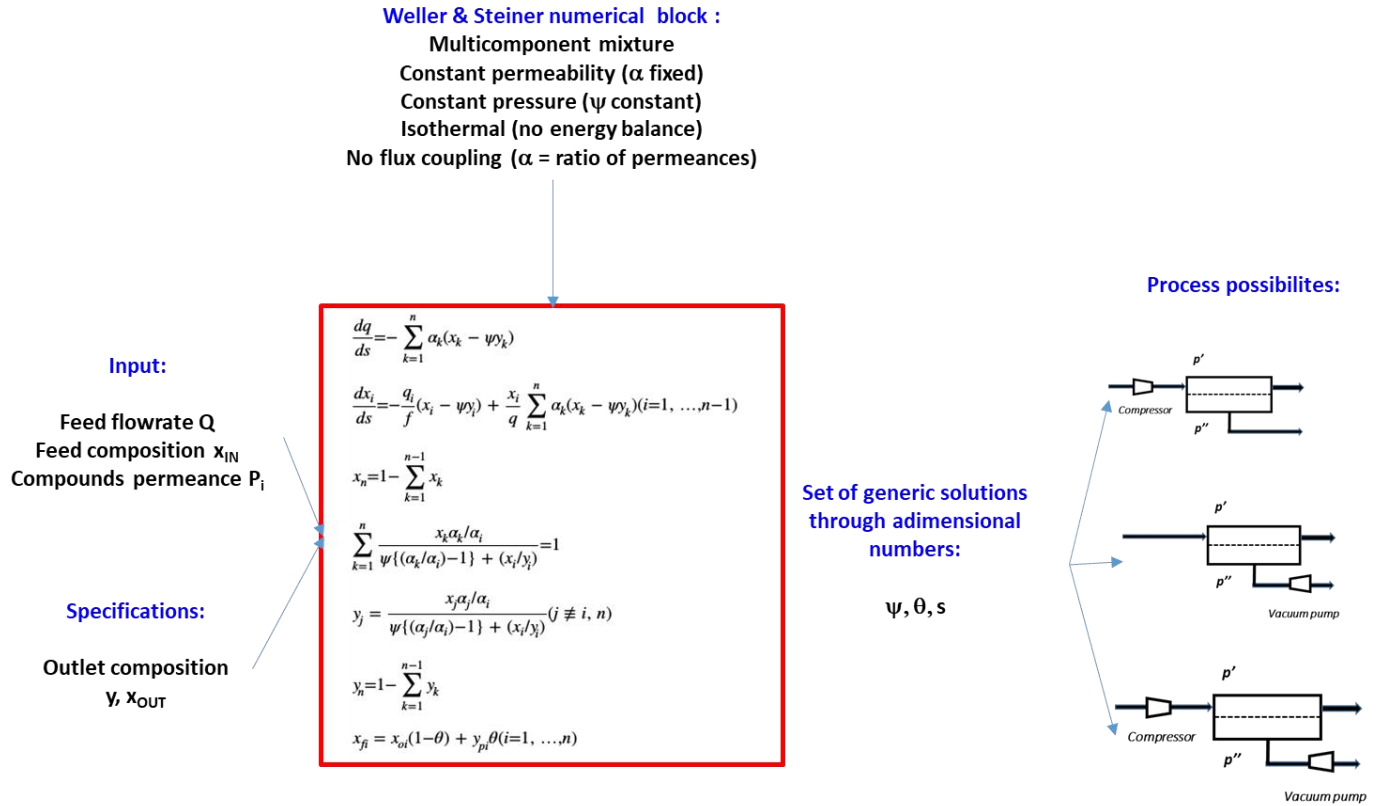

Fig. 1. Simplified representation of a process analysis for membrane gas separations, starting from materials performances (#1) to process selection (#4) (from [14], adapted). Numbers indicate potential bottlenecks; 1. Availability of membrane permeance data ( $P_1, P_2, \dots$ ); 2. Rigorous and efficient simulation method; 3. Knowledge on membrane cost and lifetime; 4. Knowledge on cost functions for competing technologies. Q stands for feed flowrate,  $x_{IN}$  and  $x_{OUT}$  for inlet and outlet mole fraction, y for permeate mole fraction,  $p''$  for permeate pressure,  $p'$  for retentate pressure.  $\Psi$  is called the pressure ratio,  $\theta$  the module stage cut and  $S_T$  the dimensionless surface area.



**Fig. 2.** Illustrative example of a membrane process simulation study based on Weller & Steiner method for a one stage process. Input data (including compounds effective permeance) and specifications are first designed. A set of solutions is obtained through triplets of pressure ratio ( $\Psi$ ), module stage cut ( $\theta$ ) and dimensionless area ( $S$ ). Each solution set can be translated into different process configurations based on feed compression and/or permeate vacuum pumping. The final portfolio of process possibilities usually covers a broad range of energy requirement (maximal for feed compression solutions) and membrane surface area (maximal for vacuum pumping solutions).

A very interesting feature of the Weller & Steiner approach is that the system is completely governed by four dimensionless numbers (material selectivity  $\alpha$ , pressure ratio  $\Psi$ , module stage cut  $\theta$ , dimensionless surface area  $S$ ) enabling generic process solutions to be obtained. The typical engineering resolution framework is shown on Figure 2. The number of variables to be defined is minimal because module geometry is not required in the resolution; permeance data, feed composition and operating conditions (pressure ratio, stage cut) are sufficient for the outlet compositions and flowrates to be determined (Figure 1). As a consequence the Weller & Steiner baseline simulation framework is often considered as the unavoidable simulation approach in a first step (pre-design study). It can often help to take a go / no go decision in an early process selection analysis.

Despite its interest because of its simplicity and rapidity, the Weller-Steiner method has often to be extended and refined when the membrane option seems a potential solution to the problem. It is indeed limited to a one stage process, without recycling loops and makes use of simple hypotheses, as explained above. A more detailed engineering strategy has then often to be applied in a second step.

**2.4. Engineering methods: from computer programs to PSE**

Because each of the Weller & Steiner hypotheses can effectively be reconsidered depending on the system characteristics, numerous studies have later explored more sophisticated engineering approaches, mostly though advances in numerical methods and computer performances. A detailed analysis of the different models and programs is beyond the scope of this paper. A series of key references is proposed for each hypothesis in Table 2. It can be seen that the improvements of computer performances enable today membrane gas separation processes to be precisely simulated and designed into complex process systems.

It has to be stressed however, that the choice of the most effective simulation approach remains a key question; the problem of a balanced complexity vs liability strategy is very important. For example, a membrane separation simulation based on Weller & Steiner approach with 3 compounds (ternary feed mixture) requires only three effective permeance data. Simply taking a variable permeability model, without coupling fluxes, will typically require 15 variables to be defined (such as through dual mode model, with 3

sorption parameters and 2 diffusion coefficients per compound). Moreover, a tailor made computer program, taking into account membrane boundary conditions is then required for a rigorous computation [27]. A flux expression with separate permeability and driving force (i.e. partial pressure difference) is often still used, for sake of simplicity [23]. It is unfortunately no longer valid [11]. Moreover, the problem cannot be treated through a dimensionless area ( $S$ ) but a real membrane surface area ( $A$ ) has to be defined to run the simulation. There is thus a huge gap in terms of computational approach and problem definition (i.e. input variables) just when one hypothesis is modified. No in between situation exists. The difficulty still increases when non isothermal conditions are taken into account. In that case, module geometry has to be defined, Arrhenius type coefficients are needed for each compound and heat transfer data have to be detailed. All in all, the ternary mixture example can grow up to more than 35 variables to be defined when a variable permeability and non-isothermal situation is taken into account.

**Table 1**

Main current membrane gas separation applications with corresponding material, module and approximate number of operating units (from [10], [11], [12], [47], [48]). Membrane selectivity ( $\alpha$ ) is a key material performance indicator and corresponds to the ratio of permeance  $P$  (or permeability  $P$ ) of the two compounds.

Application	Membrane material	Selectivity ( $\alpha$ )	Module	Number of units
O <sub>2</sub> /N <sub>2</sub>	Polyimide, poly(phenyleneoxide)	4-6	Hollow fiber	> 100 000
H <sub>2</sub> /N <sub>2</sub>	Polysulfone, polyimide	~ 100	Hollow fiber	~ 500
CO <sub>2</sub> /CH <sub>4</sub>	Cellulose acetate, polyimide	15-40	Spiral or Hollow fiber	~ 500
VOC/N <sub>2</sub>	Silicone rubber	10-30	Spiral	~ 2500
H <sub>2</sub> O/Air	Polyimide, polysulfone	>200	Capillary-Bore side feed	> 10 000



**Table 2**  
Weller & Steiner hypotheses and examples of modifications achieved in different studies.

Hypothesis	Modification	Comment	Reference
<b>Binary mixture</b>	Multicomponent	Extension of Weller & Steiner approach to n permeants.	[15-19]
<b>Ideal gas phase</b>	Non ideal gas phase	Easy to implement through thermodynamic models.	[20-21]
<b>Constant pressure</b>	Pressure drop conditions	Can be taken into account through empirical condition or rigorous pressure drop calculation	[20-21]
<b>Isothermal conditions</b>	Non isothermal conditions	Requires energy balance computation and membrane thermal conductivity data	[22-24]
<b>No gas phase mass transfer resistance</b>	Concentration polarization in gas phase	Usually non necessary, except very selective ( $\alpha > 100$ ) and very permeable (permeance > 1000 GPU) membranes	[25-26]
<b>Constant permeance</b>	Variable permeability	Rarely taken into account. Can be implemented through empirical expressions or rigorous boundary conditions at membrane interface	[23,27]
<b>No flux coupling</b>	Explicit equation linking permeant fluxes	Clearly the most complex condition. Almost unexplored. Few attempts with empirical relationships between permeant fluxes.	[28]

2.5. Engineering methods: Module design

Simple 1D simulations are almost systematically used for process engineering purposes. As a consequence, module geometry and characteristics are not taken into account and an overall membrane surface area is obtained when operating conditions and specifications are fixed (Figure 3). This strategy is interesting in terms of simplicity (no need to detail module geometry as input data) and computing time. Nevertheless, the impact of module characteristics can be of importance in some cases:

- i) Pressure drop impact can be important, especially when energy requirement needs to be precisely evaluated. Post combustion carbon capture is a typical example where energy efficiency is a key issue, which requires minimal pressure drop modules [52]. Pressure drop has to be either experimentally determined (e.g. though field test on pilot scale module [51]) or predicted. Because pressure drop necessarily depends on friction losses, fluid channel geometry, gas properties and fluid velocity

have to be detailed. Computational Fluid Dynamics (CFD) simulations are of major interest for that purpose [54]. High pressure (i.e., retentate side) pressure drop often dominating, but permeate side effects are also significant, especially when sweep operation is applied [55]. Moreover, pressure drop effects can induce unwanted condensation effects when water or low boiling compounds are present [50].

- ii) Besides pressure drop, mass transfer resistance aspects, which are often negligible in gas permeation operation, may also become important. Again, 1D Process Systems Engineering simulations do not include polarization aspects. With the development of highly selective and highly permeable materials, concentration polarization can be an issue [53-54]. Again, CFD can be used in order to estimate boundary layer effects and help to design module, such as high performance spacers for spiral wound modules for instance.
- iii) Thermal effects also depend on module geometry and require channel dimensions for simulation purposes.

It is important to note that, even though hollow fiber modules remain often considered as the most efficient geometry for gas separation applications [9,10], spiral wound modules and flat geometries are still proposed by different equipment suppliers [52,56]. It can be considered that robust and mature module design methods have been developed by suppliers through decades of improvements. Nevertheless, the continuous development of new membrane types (including chemically reactive) and new production technologies (such as 3D printing) may lead to novel module designs [58,59]. From a process simulation and design perspective, linking module simulation through advanced tools (such as CFD) with PSE codes is challenging, but the situation is expected to quickly evolve in the near future.

2.6. Engineering methods: Process synthesis

Besides PSE methods offering powerful process simulation and optimization possibilities, a radically different approach, classically called process synthesis, has been proposed for a long time [33-35]. The objective is here to let a computer program to systematically explore all possible process configurations and range of operating conditions through a combinatorial screening strategy, so that the optimal process structure and associated conditions is finally obtained. The major difference to classical PSE methods is that no flowsheet is needed to perform simulations (which corresponds to the first step of PSE methods, usually performed by a process engineer based on heuristics); a blank sheet is the starting point here and the different flowsheets are automatically generated by the computer program. Interestingly, membrane gas separations offer an ideal playground for these methods and the number of publications in this domain is rapidly growing [37-40]. Membrane gas separations effectively require a limited number of stages (classically less than 3), which largely limits the computing effort. Additionally, membrane module modelling is rather easy to implement, because there is no mass transfer resistance in the gas phase (the system performances simply depend on the ratio of contact time and transfer time, included into the stage cut value).

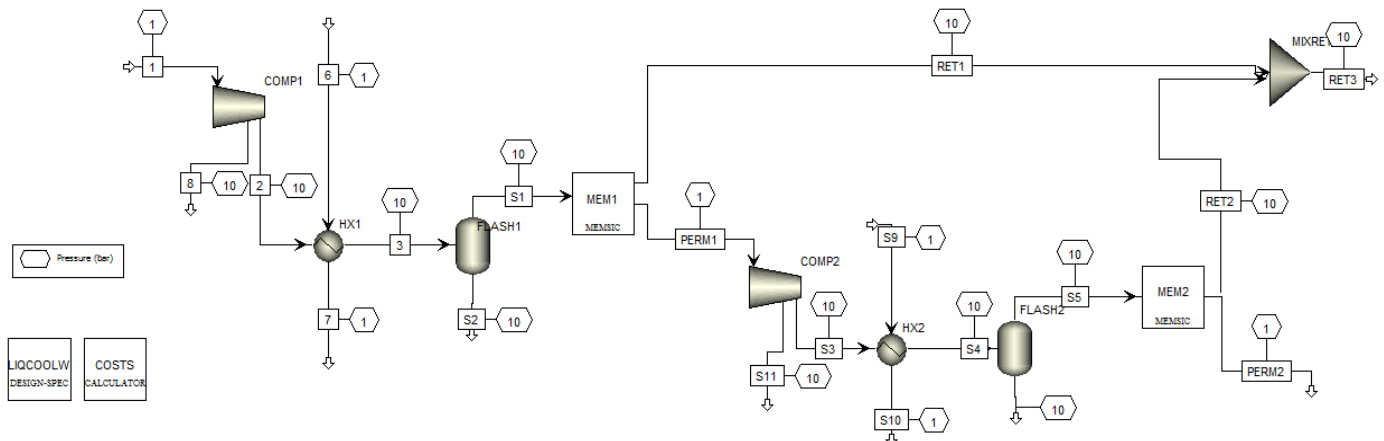

**Fig. 3.** Sketch of a two stage membrane (MEM1 and MEM2) separation process in a Process Systems Engineering (PSE) environment. The complete system, including compressors, vacuum pumps, expanders, heat exchangers, valves and recycling loops can be simulated under steady state conditions. Hybrid processes (e.g. membrane unit and distillation or absorption columns) can also be treated.

Different process synthesis studies dedicated to membrane gas separations have been recently published by research teams. The field is quickly changing and it is expected that exhaustive programs, taking into account all necessary degrees of freedom in the optimization algorithm, soon will be available. Several limitations can be indeed noticed in the existing approaches such as approximate module numerical resolution, limited optimization algorithm, incomplete module connection possibilities, limited range of pressure ratio, no vacuum option, and single membrane for each stage [39-40]. Significant progress towards these different limitations have been recently achieved (Figure 4).

In summary, the evolution of membrane engineering methods sketched above can be condensed into four major periods, shown in Table 3. It can be seen that new possibilities and methods are proposed roughly every decade, since the beginning of industrial membrane gas separations. It is expected that the recently developed process synthesis programs strongly modify the strategies and methods for membrane gas separations in the near future.

### 3. Conclusion & perspectives

The application of engineering methods to membrane gas separations started a long time ago. Basic methods were first developed for uranium enrichment in the 40's, followed by the generic Weller & Steiner method in the 50's. The trend today is to make use of modern methods, up to artificial intelligence tools. Beyond Process Systems Engineering toolboxes, which still offer relevant and efficient possibilities for design purposes, Process synthesis methods are expected to quickly expand. These approaches indeed open new possibilities such as optimal process structures for multistage membrane and hybrid processes, including multi-membrane processes (the latter case being almost unexplored today). They also offer a very large gain in terms of rapidity, because they close the bridge between materials performances and optimal process structure and cost (i.e. they offer a straightforward link between steps I and step IV on Figure 1). Process synthesis methods will also be of great use for materials scientists, in order to better understand the complex relationship between membrane and process performances. More

specifically, it is now possible to quickly evaluate the potential interest of the numerous breakthrough results reported for different gas separation mixtures thanks to materials such as Polymers of Intrinsic Porosity (PIM's), Thermally Rearranged Polymers (TRP's), Carbon Molecular Sieves (CMS), Metal Organic Frameworks (MOF's), Graphene, zeolites, etc. [41-44]. The current state of the art in membrane gas separation design thanks to process synthesis methods is sketched on Figure 5a. Generally speaking, a single feed mixture (often binary) is taken into account with a simple objective function (target compound purity and recovery). Monomembrane systems with most often only compressors and recycling loops are used; vacuum pumping is rarely included in the process options. Moreover, module simulation makes use of a simple 1D approach.

Numerous challenges remain to be addressed, such as the use of more sophisticated module simulation models in Process Synthesis (the Weller & Steiner framework is systematically used), the development of simulation boxes for chemically reactive membranes, the extension of connection possibilities to sweeping operation, the resolution of complex architectures (such as 2D cascades) with multicomponent, multi-objective and multi-membrane systems. Finally, the very large increase in connection possibilities with hybrid systems such as distillation / membrane processes cannot be exhaustively treated today and requires further efforts. The overall framework corresponding to this set of future optimization methodologies is shown on Figure 5b.

More generally, advanced simulation tools in the field of molecular mechanisms (e.g. molecular dynamics methods applied to membrane processes), transport phenomena (e.g. Computational Fluid Dynamics methods applied to module design, including fluid flow, energy balance and complex mass transfer simulations) and process engineering are on the way to offer a multiscale portfolio to researchers and engineers. These advanced tools should help to keep the very important link between materials and processes [11,45], in order to better evaluate the best role of high performances materials, in particular for breakthrough developments [46]. The development of engineering methods for membrane gas separations is thus far to be completed but it is expected to strongly evolve in the near future.

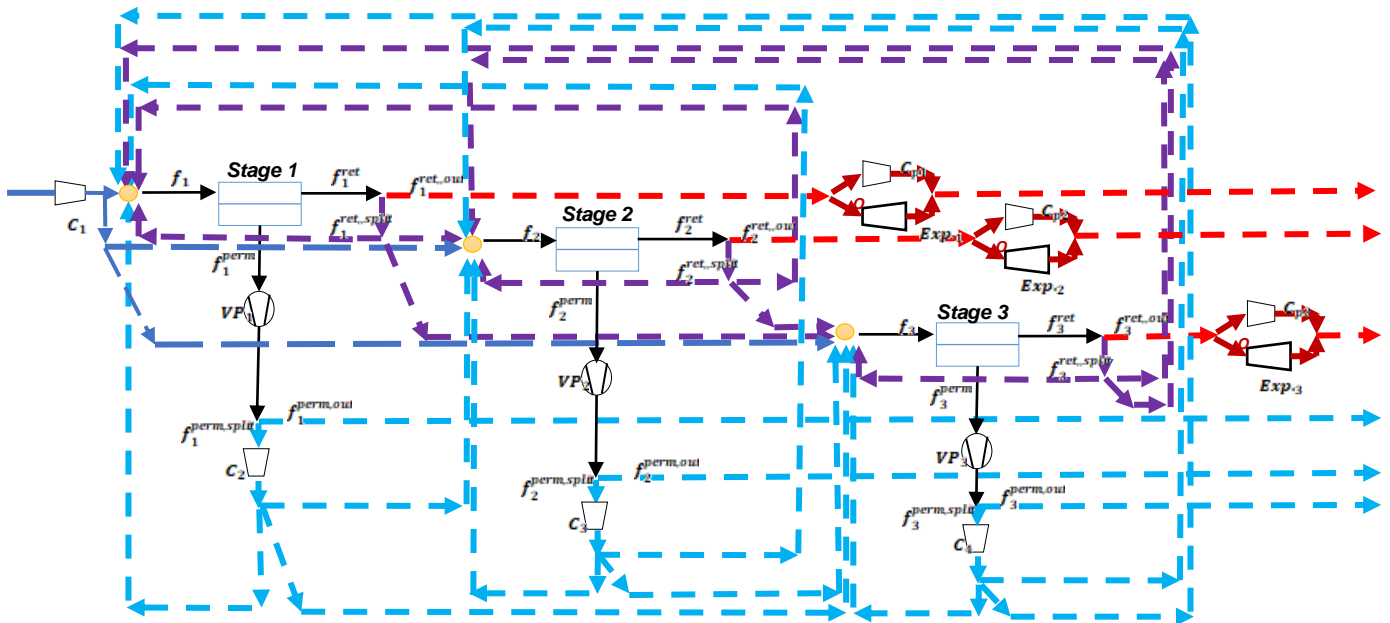
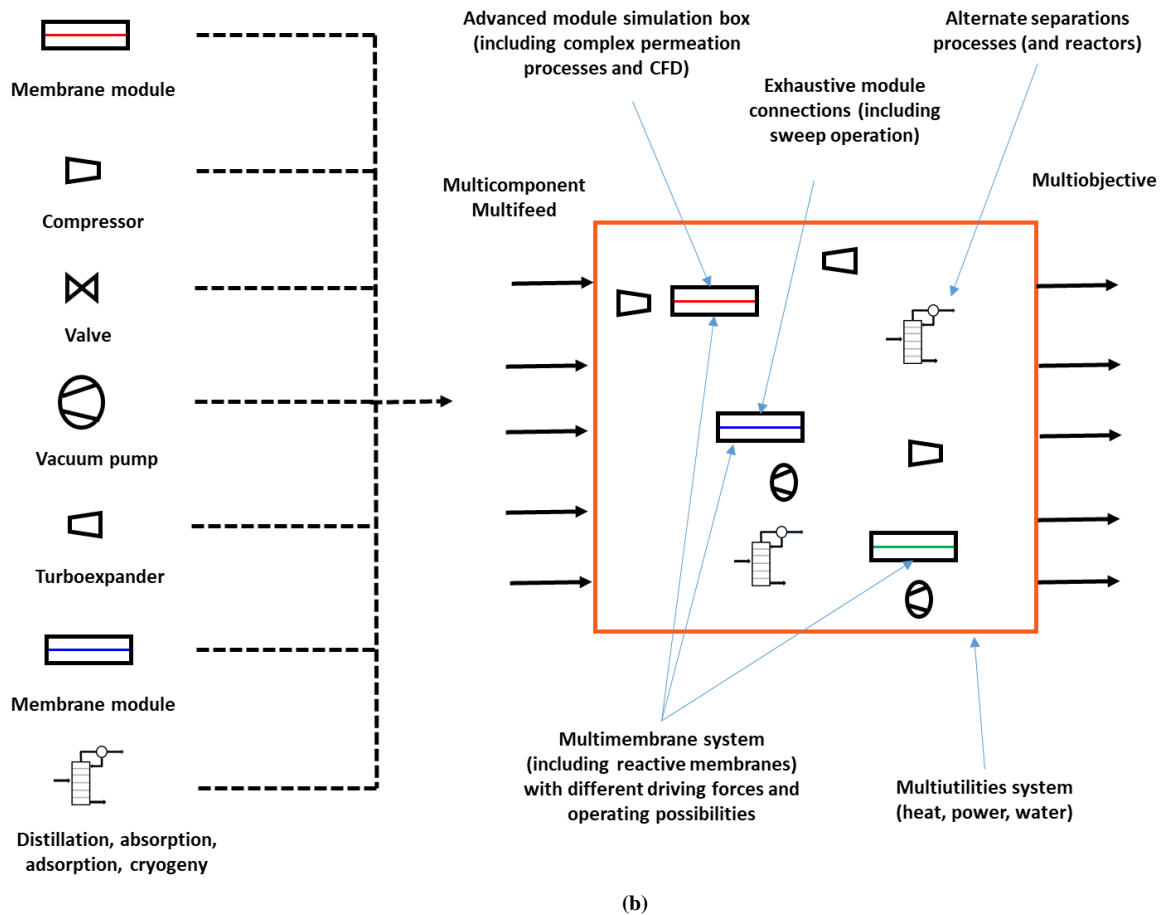
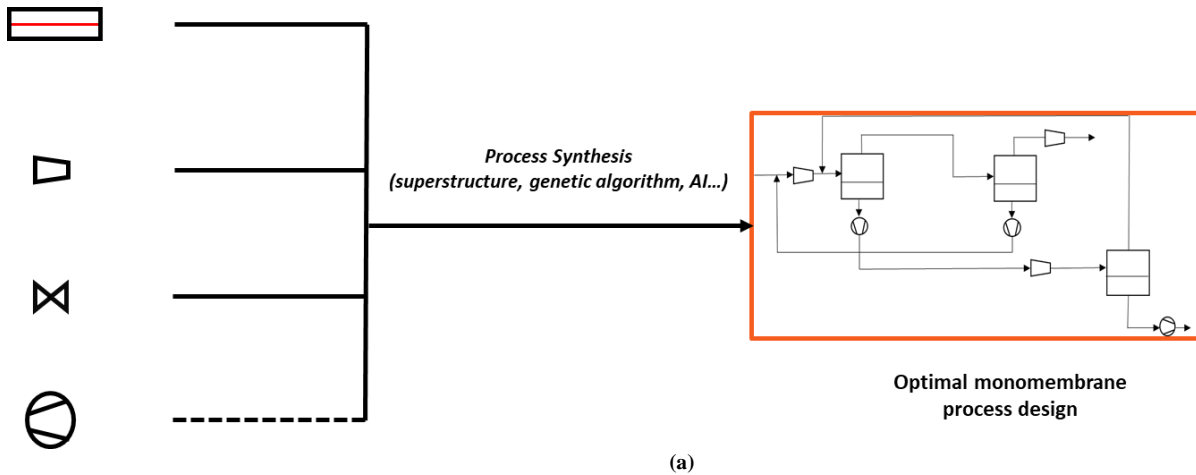

Fig. 4. An example of process synthesis flowsheet for a 3 stages membrane gas separation process (from [40], adapted). All connection possibilities, including self-recycling loops are taken into account. Compressors, vacuum pumps and expanders are included in the search of the optimal configuration. The optimal process is obtained from the minimization of the objective function, i.e., the overall cost).

**Table 3**  
Overview of the different ages of membrane gas separations simulation and optimization methods.

Starting decade	Method	Objective	Reference
1950	Simplified analytical approach	Single membrane separation box, binary feed mixture	[8]
1970	Standalone computer programs	Towards more realistic membrane units (pressure drop, recycling loops, multistage units...)	[15-20]
1980	Process System Engineering (PSE) softwares	Simulation of the overall system, including unit operations (heat exchangers, distillation columns...)	[29-32]
2000	Process Synthesis	Automated design of the optimal process configuration	[36-40]



**Fig. 5.** Simplified illustration of current state of the art in membrane gas separations systems design (a) and future challenges to be addressed in order to extend the methodology to complex hybrid systems (b).



## List of symbols

A	Effective membrane surface [m <sup>2</sup> ]
P	Pressure [Pa]
P	Permeability coefficient (Barrer or mol.m <sup>-1</sup> .s <sup>-1</sup> .Pa <sup>-1</sup> [SI])
P	Permeance (mol.s <sup>-1</sup> .Pa <sup>-1</sup> [SI])
Q	flow rate (mol.s <sup>-1</sup> )
R	perfect gas constant (8.314 J.mol <sup>-1</sup> .K <sup>-1</sup> )
S	Dimensionless surface area (-)
T	Temperature [K]
x	Feed or retentate mole fraction [--]
y	Permeate mole fraction [--]
z	Membrane active layer thickness [m]
α	Selectivity [-]
Ψ	Pressure ratio [-]
θ	Stage cut [-]

## Subscripts

i	Component
IN	Relative to inlet
OUT	Relative to outlet

## References

- [1] T. Graham, On the absorption and dialytic separation of gases by colloid septa, *Philosophical Magazine*, 32 (1866) 401-420.
- [2] S. von Wroblewski, Über die Abhängigkeit der Konstante der Verbreitung der Gase in der Flüssigkeit von der Zähigkeit derselben, *Wied. Annln. Phys.*, 8 (1879) 29.
- [3] J. G. Wijmans and R. W. Baker, The solution-diffusion model: a review, *J. Membr. Sci.*, 107 (1995) 1–21.
- [4] K. Cohen, *Theory of isotope separation*, Mc Graw Hill, New York, 1951
- [5] Separation & purification: critical needs and opportunities. Washington, D.C.: National Academy Press: Board on Chemical Sciences and Technology, Washington, 1987
- [6] Membrane separation of isotopes, in Hwang S.T. and Kammermeyer, K., *Membranes in Separations*, Wiley & Sons, New York, 1975
- [7] R.M. Barrer, *Diffusion in and through solids*, Cambridge University Press, Cambridge, 1951
- [8] S. Weller and W. A. Steiner, Separation of Gases by Fractional Permeation through Membranes, *J. Appl. Phys.*, 21 (1950) 279–283.
- [9] R. W. Baker, *Membrane technology and applications.*, J. Wiley: Chichester, New York, 2004.
- [10] W. J. Koros, G. K. Fleming, Membrane-based gas separation, *J. Membr. Sci.*, 83 (1993) 1–80.
- [11] E. Favre, Polymeric membranes for gas separation. *Comprehensive Membrane Science and Technology*, E. Drioli & L. Giorno Eds, Volume II, pp155-212, Elsevier, New York, 2017 (ISBN 978-0-08-093250-7)
- [12] R. W. Baker, B. T. Low, *Gas Separation Membrane Materials: A Perspective*, *Macromolecules*, 47 (2014) 6999–7013.
- [13] C. Castel, E. Favre, Membrane separations and energy efficiency, *Journal of Membrane Science*, 548 (2018) 345-35
- [14] C. Castel, L. Wang, J.P. Corriou, E. Favre, Steady vs unsteady membrane gas separation processes, *Chemical Engineering Science*, 183 (2018) 136-147
- [15] S. A. Stern, W. P. Walawend, Analysis of membrane separation parameters, *Sep. Sci.*, 4 (1969) 129.
- [16] C. T. Blaisdell, K. Kammermeyer, Counter-current and co-current gas separation, *Chem. Eng. Sci.*, 28 (1973) 1249–1255.
- [17] C. Y. Pan, H. W. Habgood, An analysis of the single-stage gaseous permeation process, *Ind. Eng. Chem. Fundam.*, 4 (1974) 323–331.
- [18] C.-Y. Pan, H. W. Habgood, Gas separation by permeation part I. Calculation methods and parametric analysis, *Can. J. Chem. Eng.*, 56 (1978) 197–209.
- [19] S. P. Kaldis, G. C. Kapantaidakis, G. P. Sakellariopoulos, Simulation of multicomponent gas separation in a hollow fiber membrane by orthogonal collocation—hydrogen recovery from refinery gases, *J. Membr. Sci.*, 173 (2000) 61–7.
- [20] M. J. Thundiyil, W. J. Koros, Mathematical modeling of gas separation permeators - for radial crossflow, countercurrent, and cocurrent hollow fiber membrane modules, *J. Membr. Sci.*, 36 (1997) 114–134.
- [21] M. Scholz, T. Harlacher, T. Melin, M. Wessling, Modeling Gas Permeation by Linking Nonideal Effects, *Ind. Eng. Chem. Res.*, 52 (2013) 1079–1088.
- [22] D. T. Coker, T. Allen, B. D. Freeman, G. K. Fleming, Nonisothermal model for gas separation hollow-fiber membranes, *AIChE J.*, 45 (1999) 1451–1468.
- [23] F. Ahmad, K. K. Lau, A. M. Shariff, Y. Fong Yeong, Temperature and pressure dependence of membrane permeance and its effect on process economics of hollow fiber gas separation system, *J. Membr. Sci.*, 430 (2013) 44–55.
- [24] H. Gorissen, Temperature changes involved in membrane gas separations, *Chem. Eng. Process. Process Intensif.*, 22 (1987) 63–67.
- [25] X. Feng, R. Y. Huang, Concentration polarization in pervaporation separation processes, *J. Membr. Sci.*, 92 (1994) 201–208.
- [26] A. Alpers, B. Keil, O. Lüdtke, K. Ohlrogge, Organic Vapor Separation: Process Design with Regards to High-Flux Membranes and the Dependence on Real Gas Behavior at High Pressure Applications, *Ind. Eng. Chem. Res.*, 38 (1999) 3754–3760.
- [27] R. Bounaceur, E. Berger, M. Pfister, A. A. Ramirez Santos, E. Favre, Rigorous variable permeability modelling and process simulation for the design of polymeric membrane gas separation units: MEMSIC simulation tool, *J. Membr. Sci.*, 523, (2017) 77–91.
- [28] C. Servel, D. Roizard, E., Favre, D. Horbez, Improved energy efficiency of a hybrid pervaporation/distillation process for acetic acid production: Identification of target membrane performances by simulation, *Industrial and Engineering Chemistry Research*, 53 (2014) 7768-7779.
- [29] R. Rautenbach, W. Dahm, Gas Permeation - Module Design and Arrangement, *Chem. Eng. Process. Process Intensif.*, 21 (1987) 141–150.
- [30] R. A. Davis, Simple Gas Permeation and Pervaporation Membrane Unit Operation Models for Process Simulators, *Chem. Eng. Technol.*, 25 (2002) 717–722.
- [31] M. H. Murad Chowdhury, X. Feng, P. Douglas, E. Croiset, A New Numerical Approach for a Detailed Multicomponent Gas Separation Membrane Model and AspenPlus Simulation, *Chem. Eng. Technol.*, 28 (2005) 773–782.
- [32] F. Ahmad, K. K. Lau, A. M. Shariff, G. Murshid, Process simulation and optimal design of membrane separation system for CO<sub>2</sub> capture from natural gas, *Comput. Chem. Eng.*, 36 (2012) 119–128.
- [33] M.M. El-Halwagi, V. Manousiouthakis, Synthesis of mass exchange networks, *AIChE Journal*, 35 (1989) 1233-1244
- [34] D.F. Rudd, G.J. Powers, J.J. Siirola, *Process Synthesis*. Prentice Hall, Englewood Cliffs, NJ, 1973
- [35] R.W. Thompson, C.J. King, Systematic synthesis of separation schemes, *AIChE J.*, 18 (1972) 941-948.
- [36] L. Biegler, I. Grossmann, A. Westerberg, *Systematic methods for chemical process design*, Prentice Hall, Englewood Cliffs, NJ 1997.
- [37] C.A. Floudas, Separation synthesis of multicomponent feed streams into multicomponent product streams, *AIChE Journal*, 33 (1987) 540-550
- [38] M. Scholz, M. Alders, T. Lohaus, M. Wessling, Structural optimization of membrane-based biogas upgrading processes, *J. Membr. Sci.*, 474 (2015) 1–10.
- [39] M. Bozorg, B., Addis, V., Piccialli, A., Ramirez-Santos, C., Castel, I., Pinnau, E., Favre, Polymeric membrane materials for nitrogen production from air: A process synthesis study, *Chemical Engineering Science*, 207 (2019) 1196-1213.
- [40] A. Ramirez-Santos, M., Bozorg, B., Addis, V., Piccialli, C., Castel, E., Favre, Optimization of multistage membrane gas separation processes. Example of application to CO<sub>2</sub> capture from blast furnace gas, *Journal of Membrane Science*, 566 (2018) 346-366.
- [41] A.K. Geim, Graphene: Status and prospects, *Science*, 324 (2009) 1530–1534
- [42] D. Jiang, V.R. Cooper, S. Dai, Porous graphene as the ultimate membrane for gas separation *Nano Lett.*, 9 (2009), 4019–4024
- [43] A.I. Skoulidas, D.M. Ackerman, J.K. Johnson, D.S. Sholl, Rapid transport of gases in carbon nanotubes, *Phys. Rev. Lett.*, 89 (2002) 185901
- [44] J. Gascon, F. Kapteijn Metal-organic framework membranes – high potential, bright future? *Angew. Chem. Int. Ed.*, 49 (2010) 1530–1532
- [45] S. Matson, Separation of gases with synthetic membranes, *Chemical Engineering Science* 38 (1983) 503-524.
- [46] D.S.Sholl, R.P. Lively, Seven chemical separations to change the world, *Nature*, 532 (2016) 435-437.
- [47] M. Galizia, W. Seok Chi, Z. P. Smith, T. C. Merkel, R. W. Baker, B. D. Freeman, Polymers and Mixed Matrix Membranes for Gas and Vapor Separation: A Review and Prospective Opportunities, *Macromolecules*, 50 (2017), 7809-7843 DOI: 10.1021/acs.macromol.7b01718
- [48] A.F. Ismail, K.C. Kulbe, T. Matsuura, *Gas separation membranes*, 1<sup>st</sup> edition, Springer, New York, 2015 DOI 10.1007/978-3-319-01095-3
- [49] J.G. Wijmans, P. Hao, Influence of the porous support on diffusion in composite membranes, *Journal of Membrane Science*, 474 (2015) 78-85 <http://dx.doi.org/10.1016/j.memsci.2015.07.047>
- [50] S. P. Lim, Xiaoyao Tan, K. Li, Gas/vapour separation using membranes: Effect of pressure drop in lumen of hollow fibers, *Chemical Engineering Science*, 55 (2000) 2641-2652
- [51] C.A. Scholes, A. Qader, G.W. Stevens, S.E. Kentish, Membrane pilot plant trials of CO<sub>2</sub> separation from flue gas, *Greenh. Gas Sci. Technol.* 5 (2015) 229–237.
- [52] L.S. White, X. Wei, S. Pande, T. Wu, T.C. Merkel, Extended flue gas trials with a membrane-based pilot plant at a one-ton-per-day carbon capture rate, *J. Membr. Sci.* 496 (2015) 48–57.
- [53] A. Caravella, G. Barbieri, E. Drioli, Concentration polarization analysis in self supported Pd-based membranes, *Sep. Purif. Technol.* 66 (2009) 613–624.
- [54] H. Takaba, S. Nakao, Computational fluid dynamics study on concentration polarization in H<sub>2</sub>/CO separation membranes, *J. Membr. Sci.* 249 (2005) 83–88.
- [55] H. Lin, S.M. Thompson, A.S. Martin, J.G. Wijmans, K.D. Amo, K.A. Lokhandwala, B.T. Low, T.C. Merkel, Dehydration of natural gas using membranes. Part II: sweep/ countercurrent design and field test, *J. Membr. Sci.* 432 (2013) 106–114.
- [56] T. Brinkmann, C. Naderipour, J. Pohlmann, J. Wind, T. Wolff, E. Esche, D. Muller, G. Wozny, B. Hoting, Pilot scale investigations of the removal of carbon dioxide

- from hydrocarbon gas streams using poly(ethylene oxide) – poly(butylene terephthalate) Polyactive™ thin film composite membranes, *J. Membr. Sci.* 489 (2015) 237–247.
- [57] M. Sandru, T.J. Kim, W. Capala, M. Huijbers, M.B. Hägg, Pilot scale testing of polymeric membranes for CO<sub>2</sub> capture from coal fired power plants, *Energy Procedia* 37 (2013) 6473–6480.
- [58] Suzana P. Nunes, P. Zeynep Culfaz-Emecen, Guy Z. Ramon, Tymen Visser, Geert Henk Koops, Wanqin Jin, Mathias Ulbricht, Thinking the future of membranes: Perspectives for advanced and new membrane materials and manufacturing processes, *Journal of Membrane Science*, 598 (2020) 117761
- [59] A.V.D. Pluijm, N. Miyagishima, E.V.D. Burg, Y. Itami, Spiral wound gas separation membrane modules, U.S. Patent 2016/0256827 A1, 2016.