



HAL
open science

Hydrogen storage: the different technologies, the challenges and the stakes

David Chapelle, Anne Maynadier, Ludovic Bebon, Frédéric Thiebaud

► To cite this version:

David Chapelle, Anne Maynadier, Ludovic Bebon, Frédéric Thiebaud. Hydrogen storage: the different technologies, the challenges and the stakes. International Symposium on Sustainable Hydrogen, Nov 2019, Alger, Algeria. hal-02868026

HAL Id: hal-02868026

<https://hal.science/hal-02868026v1>

Submitted on 15 Jun 2020

HAL is a multi-disciplinary open access archive for the deposit and dissemination of scientific research documents, whether they are published or not. The documents may come from teaching and research institutions in France or abroad, or from public or private research centers.

L'archive ouverte pluridisciplinaire **HAL**, est destinée au dépôt et à la diffusion de documents scientifiques de niveau recherche, publiés ou non, émanant des établissements d'enseignement et de recherche français ou étrangers, des laboratoires publics ou privés.

Hydrogen storage: different technologies, challenges and stakes. Focus on TiFe hydrides

David Chapelle^{1,2}[0000-0002-2705-9809], Anne Maynadier^{1,2}[0000-0001-6419-3284], Ludovic Bebon^{1,2}[0000-0003-2931-0881], Frédéric Thiébaud^{1,2}

¹ Bourgogne Franche-Comté University, FEMTO ST Institute, Department of Applied Mechanics, 24 rue de l'Épitaphe, 25000 Besançon, France

² Federation for Fuel Cell Research FCLAB (FR CNRS 3539)
david.chapelle@univ-fcomte.fr

Abstract. The share of renewable energies in the energy mix is gradually increasing. This transition brings many challenges in the management of electricity grids, especially because of the fluctuating and intermittent nature of renewable energies. Therefore, hydrogen represents one of the keystones for the sustainable exploitation of our energy resources. Hydrogen allows storing in the long term not consumed but available electricity, and hydrogen is a 'fuel' for mobile, nomadic and remote site applications.

Once produced and awaiting consumption, the hydrogen must be stored in optimal conditions of safety and efficiency with regard to the application and its location. The most mature solution to date is the storage under the compressed form, which consists in keeping the hydrogen gas in a container at increasing pressures in order to increase the energy density; cryogenic storage is now well controlled but generally reserved for very specific applications for reasons inherent to the technology and because of significant costs; and finally the so-called 'solid storage', to which the scientific community has been showing a marked interest for several decades in the hope of identifying a lasting solution likely to replace advantageously other solutions.

In this paper, these storage media are introduced by evoking their technological characteristics and their fields of application often justified by inherent limitations of the technology. We will also discuss the challenges still posed by these storage solutions today by linking them with the research work carried out in the Department of Applied Mechanics in FEMTO ST Institute.

Keywords: Hydrogen storage, LH₂, CGH₂, solid storage, metal hydride.

1 Introduction

For decades, one can read the emergency to act against the climate change, to reduce drastically our greenhouse gas emission and at the same time to develop a sustainable management of our energy resources. Undoubtedly, even if it has taken too much time, the energy transition is occurring in many countries and the part of renewable energy in the energy mix is getting greater and greater month after month. One say, it

cannot happen overnight, all the more this new energetic balance comes with new challenges, especially regarding the management of electricity grids. By nature, renewable energies have fluctuating and intermittent features but are also desynchronized between production and consumption. Without any consideration on technological or cost issues, the previous situation being established, hydrogen carrier comes as a really promising candidate so as to create synergies between renewable energies and hydrogen production and use. Hydrogen allows storing in the long term not consumed but available electricity, and hydrogen is a 'fuel' for mobile, nomadic and remote site applications. In the first case, hydrogen can regulate and stabilize our electricity distribution networks at different scales; in the second case, it should progressively replace petroleum products. The recent report ([1]) of IRENA (International Renewable Energy Agency) from September 2019, prepared for the 2nd Hydrogen Energy Ministerial Meeting in Tokyo, gives a clear, synthetic but complete overview of the topic and establishes the analysis of potential pathways to a hydrogen-enabled clean energy future. It emphasizes "Clean hydrogen is enjoying unprecedented political and business momentum, with the number of policies and projects around the world expanding rapidly". As an illustration (Fig. 1), "the cost of renewable power generation has fallen dramatically in recent years".

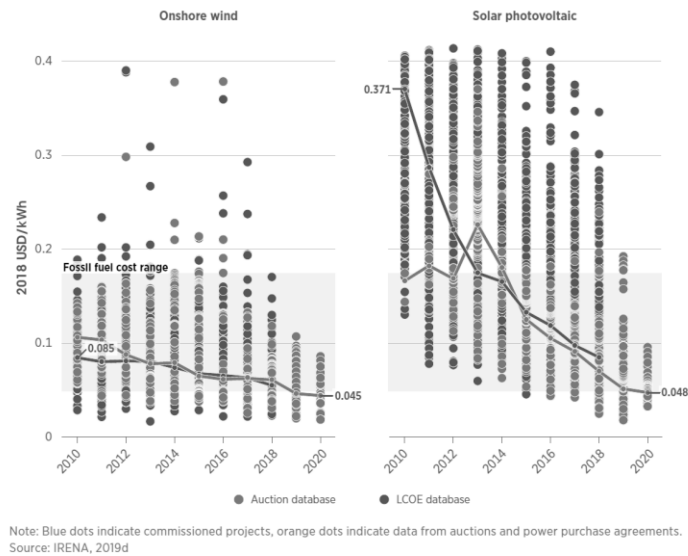

Fig. 1. Global cost trends for onshore wind and solar PV [1].

Among all challenges, the hydrogen must be stored safely and efficiently with regard to the application and its location. We list three major media to store hydrogen: the most mature solution to date is the storage under the compressed form, which consists in keeping the hydrogen gas in a container at increasing pressures in order to increase the energy density; cryogenic storage is now well controlled but generally reserved for very specific applications for reasons inherent to the technology and because of

significant costs; and finally we identify a third media, the so-called 'solid storage', to which the scientific community has been showing a marked interest for several decades in the hope of identifying a lasting solution likely to replace other solutions, if not advantageously, at least by greatly reducing constraints for the end user.

Here we discuss these storage media by evoking their technological characteristics and their fields of application often justified by inherent limitations of the technology. We will also discuss the challenges still posed by these storage solutions by linking them with the research activities with a specific focus on hydrogen solid storage.

2 Hydrogen storage media

Among the various ways to store hydrogen, we decide to pay attention on the three major solutions. Nowadays, they are the more mature from both a technological and cost point of view. They are used for decades in various domains of activities.

Because of its high volumetric storage density, the cryogenics or liquid hydrogen (LH2) has been considered even for automotive implementation till years 2010. Due to the low required operating temperature, around 20K, the tank has to be designed in order to diminish all the more heat exchanges. As illustrated in Fig. 2, even if well established the architecture of a LH2 tank is undoubtedly the more complex among all hydrogen storage solutions. It includes some heat exchanger limiting such as an efficient multi-layer vacuum super insulator (40 layers of metal foil); safety devices such as safety valve to vent hydrogen gas and prevent gas pressure increase. Due to unavoidable heat loss, an amount of hydrogen gas is rejected to environment, this is called boil-off. To complete previous drawbacks, energy balance for LH2 tank is clearly unfavorable because 30% of the stored chemical energy is required to liquefy hydrogen.

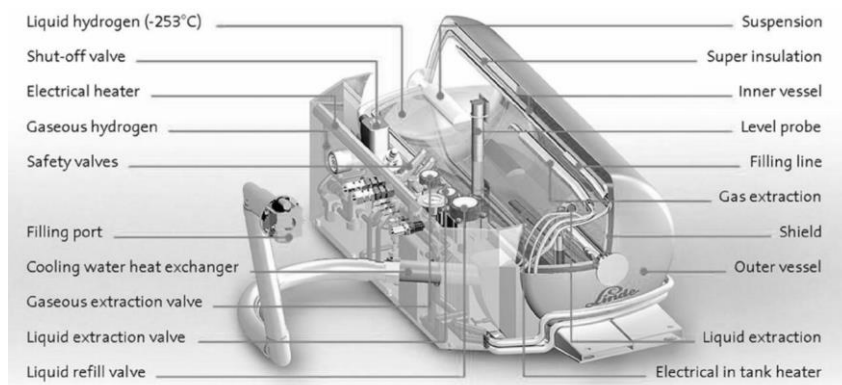

Fig. 2. Schematic architecture of a Liquid Hydrogen (LH2) tank including all devices to ensure its control and monitoring [2].

In comparison, pressurized hydrogen gas consumes less of this stored chemical energy to be produced: one say 15% for a 700bar hydrogen compressed gas (CGH2) and

12% for a 350bar CGH2. This matter of fact is enough to justify the CGH2 technology is the most suitable for many applications involving hydrogen energy. Moreover the manufacturing process that is the filament winding process is perfectly mastered and machine abilities are fully developed to design any geometry with high accuracy of fiber positioning and the production time also decreases. Fig. 3 shows a commercial CGH2 tank manufactured by the Korean ILJIN. These products are implemented in fuel cell vehicles.



Fig. 3. CGH2 tank produced by Korean manufacturer ILJIN [3].

As mentioned above, the mechanical reinforcement of a CGH2 tank is obtained by the filament winding process. The technological state of art leads to manufacture Type IV (type I is a full metal tank) CGH2 tanks because this technology has proven to be the unique allowing to store for long term hydrogen and to withstand multiple emptying and refilling cycles. The reinforcement is here deposited on a polymeric liner including metallic heads so as to mount fittings. Gravimetric density of 5 to 6 weight percent may be reached with this technology, considering tank and fittings. Some tricky challenges remain considering the use of such tanks. Among them, we have to note the evolution of temperature during filling, the collapse of the liner during emptying of hydrogen all the more kinetics is high etc. Some issues are coming from field experience: one expect refilling time to be short but it leads to a potentially critical increase of temperature, involving to ensure a refreshing of gas before filling; due to decrease of pressure, we observe a peeling off between the liner and the composite part, obviously detrimental for safety reason. Undoubtedly, the CGH2 tank is the most mature solution considering technology, cost, emptying and refilling kinetics, nevertheless works are now concentrating on the global efficiency, ease of use and safety.

Solid hydrogen storage in metals allows reaching the higher volumetric density because mean distance between hydrogen atoms is then the lowest (see Fig. 4). Expectedly, due to storage medium the gravimetric density is also the lowest if the three different media are compared. However, solid storage has undoubtedly some strong advantages among which it is worth notice the opportunity to choose the working pressure and temperature according the application (see Fig. 5). That means low pressure, between 1 and 10bar, and temperature, between 10 and 80°C, are commonly attainable what is particularly attractive for safety reason and public acceptance.

Moreover, the chemical reaction between hydrogen and metals is exothermic or endothermic during absorption or desorption respectively. The amount of heat is sufficiently high to be managed at all times and necessarily during desorption if a sufficient hydrogen flow (for fueling a fuel cell, for example) is required.

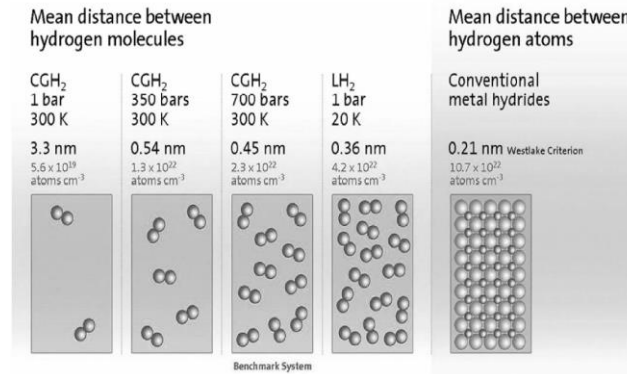

Fig. 4. Hydrogen density according the storage medium [4] [5].

As a synthetic consequence of above comments, one say the hydrogen storage medium is application dependent. High technological application may use LH2 solution, when hydrogen for mobility, more precisely for automotive, require pressurized gas, and solid hydrogen is more suitable for stationary applications, eventually for nomad application.

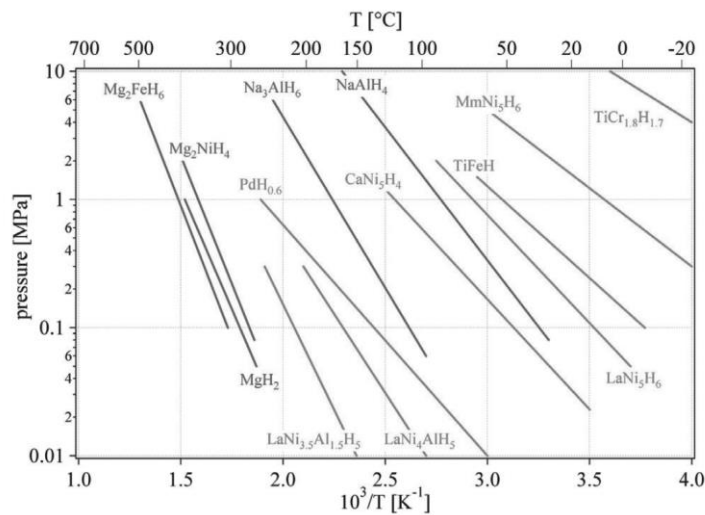

Fig. 5. Van't Hoff plots of some hydrides [6]. Slope relates to the enthalpy of formation.

3 TiFe and its hydrides

Here we pay attention on solid storage solution, more precisely on Titanium-Iron alloys which are very good candidate to replace well-known Lanthanum-Nickel system. The TiFe system has the main advantages to offer a solid solution at lower cost and more easily available and recyclable in Europe. Fig. 6 represents the phase stability domains of the binary alloy Ti-Fe as a function of temperature and Ti composition. Two intermetallic compounds exist: FeTi which is of cubic structure similar to that of CsCl and Fe₂Ti of structure C14 similar to the structure of MgZn₂. Fe₂Ti does not absorb hydrogen, but absorption becomes possible for compounds that are richer in Ti than TiFe₂ according J. J. Reilly *et al* [7].

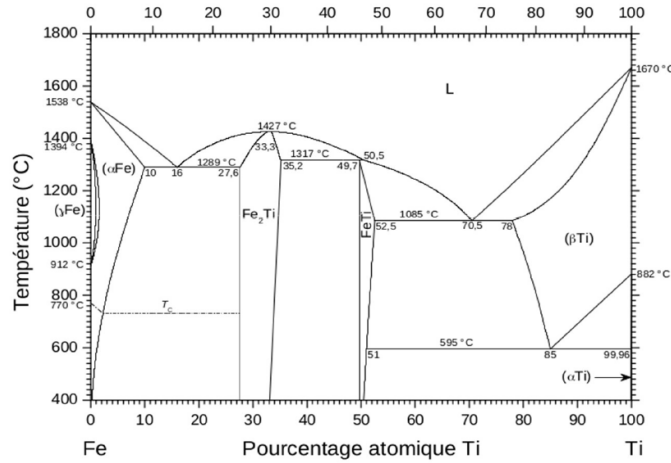

Fig. 6. Phase diagram of TiFe. Phase stability domains according Ti atomic percentage [8].

These authors studied the Fe-Ti-H system and in particular the reaction between the TiFe compound and the hydrogen resulting in the formation of two hydrides TiFeH₁ and TiFeH₂. Isothermal curves (Pressure-Composition-Isotherm, PCI) give the hydrogen equilibrium pressure as a function of the amount of hydrogen absorbed by the material at a defined temperature. Fig. 3a shows PCI curve at 40°C of TiFe compound from [7] and Fig. 3b represents PCI curves obtained on TiFeMn_{0.1} at 8, 22 and 45°C with our own equipment.

As previously mentioned, when designing a vessel to welcome hydrides, one has to consider heat exchange to manage the inlet or outlet flow, but also kinetics of reaction [12] [13]. Another challenging issue regarding hydride is the decrepitation phenomenon that occurs after repeated absorption/desorption cycles. The particle size of the pristine powder bed decreases while the number of cycles increases. This is of first interest for the designer because distribution inside the vessel consequently evolves leading to high level of stress on the tank wall and a potential failure [9] [10].

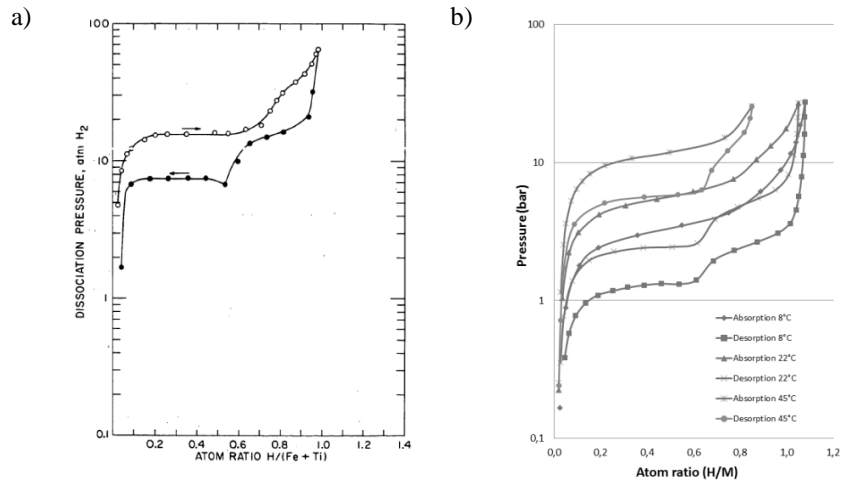

Fig. 7. Pressure-Composition-Isotherm curves of TiFe alloys; a) Hysteresis in the TiFe-H system at 40°C according [7], b) TiFeMn alloy characterized at 8, 22 and 45°C on our bench test.

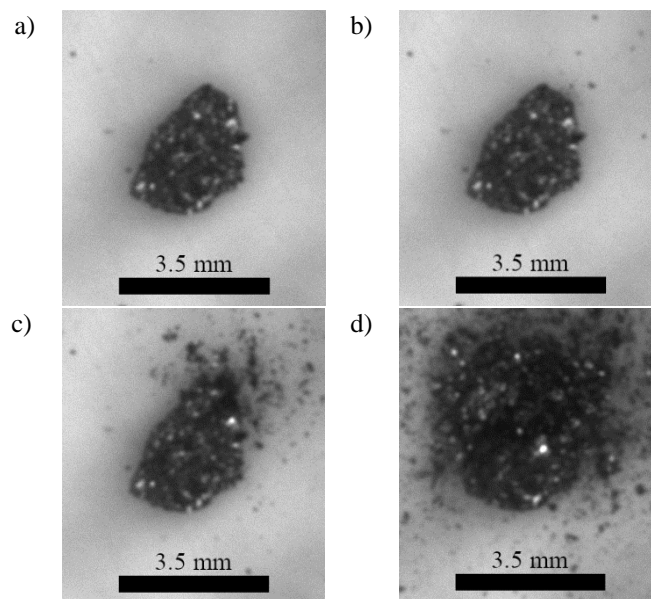

Fig. 8. Focus on a 2mm LaNi₅ particle size during absorption at different time: a) initial, b) after 2h, c) 4h and d) 6h.

To investigate the phenomenon, we develop specific observation bench test with hydrogen reactor and CCD camera to visualize the way particle sizes diminish during absorption. Fig. 8 illustrates the decrepitation of a 2mm diameter particle of LaNi₅ when submitted to 30bar hydrogen pressure. The LaNi₅ is here chosen because the phenomenon has clearly a higher dynamics with more visible effect on a shorter time.

In parallel, we carry out X-ray tomography analysis of TiFeMn particles at successive time to evidence the effect of hydrogen on the morphology (see Fig. 9). This reveals a fracture network appears due to the hydride phase transformation. The integrity of the TiFeMn particle is maintained when the fracture network is widely spread what is directly correlated to mechanical properties of the alloy, more precisely resilience. This response seems really different of the response of LaNi₅ alloy (see Fig. 8) for which energetic expulsion of very small particles is observed.

These observations, briefly introduced here, feed our reflections and our modeling to predict the behavior of the single particle but also the particle in the powder bed. The Different Element Modeling is peculiarly convenient for such mechanical issue, and we presently develop routines for YADE [11] to simulate the particle response depending on mechanical parameters.

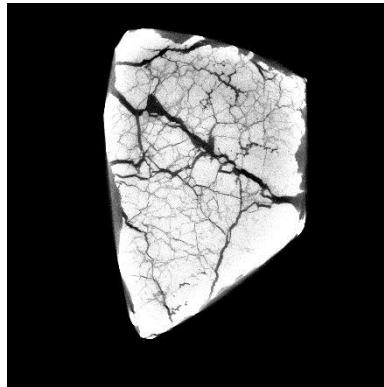

Fig. 9. X-ray tomography of a TiFeMn particle after a 20 hours exposure to hydrogen.

4 Conclusion

In a world where renewable energies have to become the rule, hydrogen benefits a high potential in order to store electricity under gas form for long term and thus answers main drawbacks of these energies, that are their intermittence and fluctuating nature. We introduced the three main hydrogen storage media: liquid hydrogen LH₂, pressurized hydrogen CGH₂ and solid storage solutions. Considering the state of art, these solutions are rather mature, even if at different stages. The disadvantages but also the domains of application were recalled. As an illustration, a focus was made on the research activities at the Department of Applied Mechanics in Besançon that is the decrepitation phenomenon of metal hydride occurring while the material is submitted to repeated hydrogen cycles. We aim at increasing knowledge and at modeling the decrepitation in order to develop methodologies and tools to be used when designing solid storage tank.

References

1. IRENA, 2019. Hydrogen: a renewable energy perspective ; https://www.irena.org/-/media/Files/IRENA/Agency/Publication/2019/Sep/IRENA_Hydrogen_2019.pdf.
2. The Linde Group, Wiesbaden.
3. ILJIN Group, Seoul.
4. Eberle, U., Arnold, G., von Helmolt, R.: Hydrogen storage in metal–hydrogen systems and their derivatives. *J. Power Sources* 154(2), 456–460 (2006).
5. Eberle, U., Arnold, G., von Helmolt, R.: Fuel cell vehicles: Status 2007, *Journal of Power Sources* 165(2), 833–843 (2007).
6. Zuttel, A.: Materials for hydrogen storage, *materialstoday* 6(9), 24–33 (2003).
7. Reilly, J.J., Wiswall, Jr.R.H.: Formation and properties of iron titanium hydride, *Inorg. Chem.* 13, 218–222 (1974).
8. Okamoto, H.: *Phase Diagrams for Binary Alloys*. 2nd edn. ASM International, Ohio (2000).
9. Nasako, K., Ito, Y., Hiro, N., Osumi, M.: Stress on a reaction vessel by the swelling of a hydrogen absorbing alloy, *Journal of Alloys and Compounds* 264, 271–276 (1998).
10. Qin, F.: Pulverization, expansion of $\text{La}_{0.6}\text{Y}_{0.4}\text{Ni}_{4.8}\text{Mn}_{0.2}$ during hydrogen absorption–desorption cycles and their influences in thin-wall reactors, *International Journal of Hydrogen Energy* 33, 709–717, (2008).
11. Šmilauer, V. et al. (2015), *Yade Documentation* 2nd ed. The Yade Project, doi: 10.5281/zenodo.34073. <http://yade-dem.org/doc/>.
12. Zeaiter, A., Chapelle, D., Cuevas, F., Maynadier, A., Latroche, M.: Milling effect on the microstructural and hydrogenation properties of $\text{TiFe}_{0.9}\text{Mn}_{0.1}$ alloy, *Powder technology* 339, 903–910 (2018).
13. Lexcellent, C., Gay, G., Chapelle, D.: Thermomechanics of a metal hydride-based hydrogen tank, *Continuum Mechanics and Thermodynamics* 27, 379–397 (2015).