



HAL
open science

Optimization Of LNA's First Stage To Reduce Overall Noise Figure in Multi-Stage LNAs

Masoumeh Sabzi, Mahmoud Kamarei, Tchanguiz Razban, Yann Mahé

► **To cite this version:**

Masoumeh Sabzi, Mahmoud Kamarei, Tchanguiz Razban, Yann Mahé. Optimization Of LNA's First Stage To Reduce Overall Noise Figure in Multi-Stage LNAs. *AEÜ - International Journal of Electronics and Communications / Archiv für Elektronik und Übertragungstechnik*, 2020, 123, pp.153300. 10.1016/j.aeue.2020.153300 . hal-02746891

HAL Id: hal-02746891

<https://hal.science/hal-02746891v1>

Submitted on 18 Jul 2022

HAL is a multi-disciplinary open access archive for the deposit and dissemination of scientific research documents, whether they are published or not. The documents may come from teaching and research institutions in France or abroad, or from public or private research centers.

L'archive ouverte pluridisciplinaire **HAL**, est destinée au dépôt et à la diffusion de documents scientifiques de niveau recherche, publiés ou non, émanant des établissements d'enseignement et de recherche français ou étrangers, des laboratoires publics ou privés.



Distributed under a Creative Commons Attribution - NonCommercial 4.0 International License

Optimization Of LNA's First Stage To Reduce Overall Noise Figure in Multi-Stage LNAs

M. Sabzi^{a,b}, M. Kamarei^a, T. Razban^b, Y. Mahe^b

^aUniversity of Tehran, Tehran, Iran

^bIETR, UMR CNRS 6164, University of Nantes, Nantes, France

Abstract

An analytical approach for designing the first stage in multi-stage low noise amplifiers (LNAs) is presented. This paper discusses the first stage optimization for minimizing the overall Noise Figure (NF) with consideration of following stage's noise. This approach focuses on source impedance optimization of first stage while considering its NF, gain and the effect of the following stage's NF simultaneously. The proposed approach calculates the first stage's design parameters to have minimum overall NF in a multi stage LNA while the conventional approach suggests optimum source impedance to achieve minimum NF in first stage. In this paper, it is proved that constant overall-NF contours in Smith chart are different from traditional NF circles and Γ_{opt} for best noise performance changes in multi stage LNAs with different NF in adjacent stages. These contours and the optimum source impedance are depicted for specific LNA and compared with its constant NF circles and Γ_{opt} . For checking the feasibility of proposed approach and also validation of theoretical and simulation results a discrete LNA in 4-5 GHz using ATF13136 transistor is made. Results show that considering the subsequent circuit's noise in LNA's first stage design reduces overall-NF while improves its gain and input matching.

Keywords: Low noise Amplifier (LNA), Noise figure (NF), Optimization, First stage, Multi-stage.

1. Introduction

A low noise amplifier (LNA) is typically the first block in receivers and due to the weakness of the signal received prior to signal processing, it has to be amplified. To maintain the signal integrity, the added noise should be as low as possible. Thus, two main characteristics of any LNA are its gain and noise figure (NF). The challenging issue in designing LNA is to achieve maximum possible gain with specific power consumption and area on the chip while its NF is minimized.

To minimize NF and return loss as well as maximizing gain in the desired bandwidth different methods in LNA design have been established [1]. Different topologies and approaches to design high frequency LNAs with low NF and input return loss, high gain and high linearity have been already developed. A widely used approach is common gate (CG) amplifier which provides input matching over wide-band frequency range but has a relatively high NF. Using feedback and feed forward networks in this topology is also proposed to enhance the performance of CG stage but extra parasitic elements limit the frequency range of the LNA [2]-[3]. Noise cancellation technique is also considered as an approach for performance improvement technique of CG stage, but it suffers from increment in power consumption of the circuit [4]-[6].

The resistive shunt feedback topology is another approach to design wide-band LNAs. This approach tries to achieve wide-band matching by placing a feedback resistor through a common source amplifier. While this approach shows acceptable range of the input matching, it suffers from high NF and degraded gain [7]-[10].

Another common topology in LNAs at RF and microwave

frequencies is inductively degenerated common source (IDCS) due to the capability of simultaneously impedance and noise matching (SNIM) for achieving minimum possible NF along with maximum gain [11]-[21]. In this topology, an inductor is placed at the source terminal of the CS stage to achieve simultaneously noise and impedance matching condition by setting the optimum source impedance for minimum NF equal to the conjugate of the input impedance [11]-[12], [16].

With this method, narrow band numerical solution for a single stage LNA by use of source inductive degeneration and gate inductor is obtained [13]-[17], [19]-[20].

Simultaneously noise and impedance matching by use of a feedback network with calculation of correlation matrix is also presented in [21].

At RF and microwave frequencies, to meet the required gain specification, normally more than one stage is needed. While analytical solution for design method of a single stage LNA is previously presented [19], optimization for a multi-stage LNAs and specially its first stage has not been investigated thoroughly yet. In the modern wireless communication systems, the second stage becomes very noisy while the first stage might have limited gain for low power consumption. Therefore optimizing the first stage of LNA according to the noise effect of adjacent stages can be considered as an effective design method.

Conventional methods in different topologies and approaches for LNA design with optimized NF consist of specifying the number of stages to achieve the required gain in the desired bandwidth and designing each stage based on constant-noise factor (F), constant-available gain (G_{av}) and constant-input re-

turn loss (RL_{in}) circles in the source reflection coefficient plane (Γ_s plane) with considering the trade-off between these constraints to meet the required specifications. In most cases the first stage is designed with lowest possible NF according the well-known Friis' formula [23]. Different methods for multi stage design with focus on the input and output matching are previously presented. Using noise measure parameter for designing multi stage LNAs to obtain perfect matching in input and output sections is investigated in [24]. This methodology relies on the use of the noise measure (NM) first defined by Haus and Adler [25], [26], as a design parameter able to simultaneously account for the device noise [27], [28], [29] and gain performance. This method presents an optimization that finds appropriate Γ_s in which NM factor ($NM = \frac{F-1}{1-(1/G)}$) minimizes. In this method noise factor and gain of an LNA are considered simultaneously to achieve both low NF and high gain. While NM factor optimization, optimizes gain and NF for best performance simultaneously, it does not consider the effect of following stage's noise in change of optimum noise impedance. Constant mismatch circles in designing input and output matching circuits are also investigated in [29] to obtain a suitable simultaneous match at both ports in a low-noise design in multi stage LNAs by analyzing the role of the output termination when the source termination is fixed, in order to obtain the suitable noise condition or to comply with other requirements. While the above- mentioned approaches in different topologies and methods, tried to provide an optimal point in the design of LNA, they did not thoroughly investigate the effect of change in optimum source impedance in multi stage LNAs due to the effect of adjacent stages. Setting the first stage for minimum NF can lead to reduction of gain which can strengthen the effect of following stage's noise and degrades overall-NF [30]. The variation of overall-NF can be negligible or considerable depending on sensitivity and topology of the first stage as well as following stage's NF.

In this paper, design method of first stage in multi-stage LNAs with consideration of the effect of following stage's noise, is discussed. In spite of conventional method which emphasize minimizing NF of first stage regardless to gain reduction from maximum available gain, this approach optimizes overall-NF considering first stage's gain and NF simultaneously as well as the effect of following stage's noise.

This paper is arranged in two main parts. In the first section, analytical calculation of overall NF of an amplifier using S-parameters is presented. In this section, the contours of overall-NF of a multi-stage LNA are depicted in Γ_s Smith-chart. In the second section, two different circuits have been designed in discrete version using ATF13136 transistor. The circuits are designed according to two different versions which are conventional method and the proposed one. Simulation results confirm the performance improvement of proposed optimization method. The proposed circuit has been fabricated and measurement approve the simulation results.

2. Noise Analysis

The noise factor of an LNA, as a two-port circuit, is function its F_{min} (minimum noise factor of LNA), Γ_{opt} (optimum source admittance) and R_n (the noise resistance that shows the dependency of F to difference of Γ_s and Γ_{opt}) [21].

$$F = F_{min} + \frac{4R_n Y_0}{|1 + \Gamma_{opt}|^2} \frac{|\Gamma_{opt} - \Gamma_s|^2}{1 - |\Gamma_s|^2} \quad (1)$$

Conventional methodology for LNA design is to set source reflection coefficient equal to its Γ_{opt} to achieve minimum possible NF. At RF and microwave frequencies, because of transistor's gain roll-off, to achieve the desired gain, multi-stage LNA is often required. In these cases, the design procedure is much more complicated due to following stage's noise factor and the effect of first stage's gain on overall-NF. To find optimized value for first stage's source admittance to achieve minimum overall-NF, gain and NF of first stage should be considered as well as following stage's noise. According to Friis's law, for a multi-stage LNA, overall noise factor can be calculated using (2),

$$F = F_1 + \frac{F_2 - 1}{G_1} + \frac{F_3 - 1}{G_1 G_2} + \dots \quad (2)$$

According to (2) noise factor is strongly dependent on the first stage's noise factor as well as its gain. Overall optimization includes determination of source admittance of each stage in such a way that leads to overall-NF minimization. That means that the NF and the gain of each stage should be optimized simultaneously. One of the known methods is to draw NF and gain circles in Γ_s -plane and use the graphical method to find where two appropriate circle of NF and gain meet in the Γ_s plane. NF circles can be represented with center of C_N and radius of R_N .

$$\begin{aligned} C_N &= \frac{\Gamma_{opt}}{N + 1} \\ R_N &= \frac{\sqrt{N(N + 1 - |\Gamma_{opt}|^2)}}{N + 1} \\ N &= \frac{F - F_{min}}{4R_n Y_0} |1 + \Gamma_{opt}|^2 \end{aligned} \quad (3)$$

The transducer gain can be calculated by (4) using its S-parameters [2].

$$G_T = \frac{|S_{21}|^2 (1 - |\Gamma_s|^2) (1 - |\Gamma_L|^2)}{|1 - S_{22}\Gamma_L|^2 (1 - \Gamma_{in}\Gamma_s)^2} \quad (4)$$

where Γ_L of the first stage is calculated by (5) considering its input impedance to be fully matched ($\Gamma_{in1} = \Gamma_{s1}^*$). The assumption is that the load is chosen in such a way that input impedance is matched.

$$\Gamma_L = \frac{\Gamma_s^* - S_{11}}{\Gamma_s^* S_{22} - \Delta} \quad (5)$$

Source fully matched gain circles is calculated through (6). The center and radius are C_G and R_G respectively.

$$\begin{aligned}
C_G &= \frac{S_{22}\Delta^* - S_{11}^*}{(|S_{22}|^2 - 1)(M + 1)} \\
R_G &= \frac{\sqrt{M^2 + (|S_{12}|^2|S_{21}|^2(1 + \frac{1}{M}) - |S_{22}\Delta^* - S_{11}^*|^2 + 1)M}}{(M + 1)(|S_{22}|^2 - 1)} \\
M &= G|S_{12}|^2.
\end{aligned}$$

where $\Delta = S_{11}S_{22} - S_{21}S_{12}$.

Considering the fact that the optimization goal is to calculate the Γ_s in which that the overall NF minimizes, and also the condition in which the gain is calculated (input impedance matching according to (5)) we can obtain simultaneously noise and impedance matching in this design procedure. The overall noise factor is evaluated according to (7). It should be mentioned that, it is considered that the effect of following stages are shown in the form of a "second stage". It is assumed that it is designed regardless of first stage's behavior and its NF is independent from first stage.

$$\begin{aligned}
F &= F_{\min} + K_1 \frac{|\Gamma_{opt} - \Gamma_s|^2}{1 - |\Gamma_s|^2} \\
&+ K_2 \frac{(1 - |\Gamma_s|^2)}{\left(\left| \Gamma_s - \frac{S_{22}\Delta^* - S_{11}^*}{(|S_{22}|^2 - 1)} \right|^2 - \frac{|S_{12}|^2|S_{21}|^2}{(|S_{22}|^2 - 1)^2} \right)} \\
&= F_{\min} + K_1 \frac{|\Gamma_{opt} - \Gamma_s|^2}{1 - |\Gamma_s|^2} + K_2 \frac{(1 - |\Gamma_s|^2)}{(|\Gamma_s - \Gamma_x|^2 - X^2)}
\end{aligned} \tag{7}$$

where K_1 and K_2 are defined by (9).

$$\begin{aligned}
K_1 &= \frac{4R_n Y_0}{|1 + \Gamma_{opt}|^2} \\
K_2 &= (F_2 - 1)|S_{12}|^2
\end{aligned} \tag{9}$$

To find an approximate answer for optimum overall NF, the contribution of first stage and effect of following stage's noise can be considered individually. Assuming $F = N$ while $N = F_{\min} + N_i + M$ where $F_1 = F_{\min} + N_i$ is the noise contribution of first stage and $F_2 = M$ is for the second stage, They can also be represented as:

$$N_i = K_1 \frac{|\Gamma_{opt} - \Gamma_s|^2}{1 - |\Gamma_s|^2} \tag{10}$$

$$M = K_2 \frac{(1 - |\Gamma_s|^2)}{(|\Gamma_s - \Gamma_x|^2 - X^2)} = N - F_{\min} - N_i \tag{11}$$

Therefore,

$$\begin{aligned}
&\left| \Gamma_s - \frac{K_1}{(K_1 + N_i)} \Gamma_{opt} \right|^2 - \frac{K_1^2 |\Gamma_{opt}|^2 + N_i K_1 + N_i^2}{(K_1 + N_i)^2} = 0 \\
&\left| \Gamma_s - \frac{M}{(M + K_2)} \Gamma_x \right|^2 - \frac{K_2^2 + M K_2 (1 - |\Gamma_x|^2)}{(M + K_2)^2} = 0.
\end{aligned} \tag{6}$$

By choosing approximately appropriate N_i and M the overall noise factor locus is where these two circles meet.

$$\begin{aligned}
&\frac{\left| \frac{K_1}{(K_1 + N_i)} \Gamma_{opt} \right|^2}{(K_1 + N_i)} - \frac{M}{(M + K_2)} |\Gamma_x| = \\
&\frac{\sqrt{K_1^2 |\Gamma_{opt}|^2 + N_i K_1 + N_i^2}}{(K_1 + N_i)} + \frac{\sqrt{K_2^2 + M K_2 (1 - |\Gamma_x|^2)}}{(M + K_2)} = 0.
\end{aligned} \tag{13}$$

For calculation of exact optimum Γ_s , the derivative of overall NF with respect to Γ_s is needed.

$$\begin{aligned}
F &= F_{\min} + N_i + M \\
\frac{\partial F}{\partial \Gamma_s} &= \frac{\partial N_i}{\partial \Gamma_s} + \frac{\partial M}{\partial \Gamma_s} = 0 \\
\frac{\partial N_i}{\partial \Gamma_s} &= -\frac{\partial M}{\partial \Gamma_s}
\end{aligned} \tag{14}$$

The exact magnitude of $\Gamma_{s, opt, new}$ (optimum source reflection coefficient of first stage) is calculated by the solution of (15). While analytical solution for the equations is time consuming, a MATLAB optimization code is generated for finding optimum noise impedance of first stage with consideration of following stage's NF. In this method the overall NF is minimized with consideration of first stage's S-parameters, Γ_{opt} , R_n and also following stage's NF while the load impedance is calculated in the way that input impedance is fully matched using (6). In this code, the stability is also checked and the search for $\Gamma_{s, opt, new}$ in Γ_s -plane is only done in stable areas. To have a better perspective of proposed optimization method in table I, with use of MATLAB numerical calculations, magnitude of the $\Gamma_{s, opt, new1}$ (optimum source reflection coefficient of first stage using proposed approach) and $\Gamma_{L, opt, new1}$ (optimum load reflection coefficient of first stage using proposed approach) in some scattering and noise parameters with different NF of second stage is calculated. This table shows that the proposed design method suggests that according to first stage's Scattering and noise parameters along with second stage's NF, the optimum magnitude for Γ_s and Γ_L of first stage changes for best performance of noise and gain.

Using MATLAB, the NF contours for a single stage LNA and overall-NF contours for a multi-stage LNA with 3-dB NF for the following stage are drawn and depicted in Fig. 1. These contours show that considering following stage's noise leads to location of Γ_{opt} (which minimizes overall-NF) slides and

$$\frac{(1 - |\Gamma_s|^2)^2 \left[(2|\Gamma_s||\Gamma_s - \Gamma_X|^2 (|\Gamma_s| - |\Gamma_s - \Gamma_X|) + 2|\Gamma_s|X^2 - 2|\Gamma_s - \Gamma_X|) \right]}{(|\Gamma_s - \Gamma_X|^2 - X^2)^2 [2|\Gamma_{opt} - \Gamma_s| (1 - |\Gamma_s| (|\Gamma_{opt} - \Gamma_s| - |\Gamma_s|))]} = \frac{K_1}{K_2} \quad (15)$$

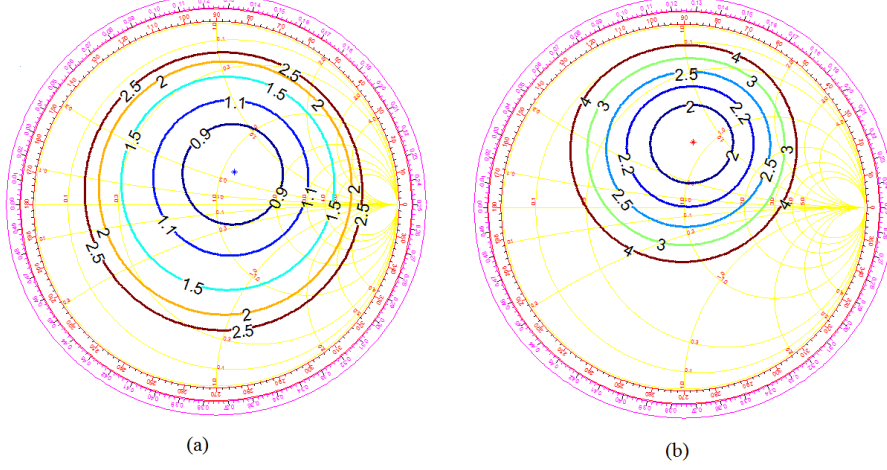

Figure 1: (a) NF contours, (b) overall-NF contours

Table 1: Change of Γ_{opt} in Multistage LNAs

S_{11_1}	S_{12_1}	S_{21_1}	S_{22_1}	NF_{min1}	Γ_{opt1}	R_{n1}	NF_2	$\Gamma_{optnew1}$	$\Gamma_{Loptnew1}$	$MAG(dB)$
0.54∠174	0.31∠139	1.65∠143	0.45∠-105	1.22	0.30∠-177	2.85	2	0.40∠-159	0.30∠105	6.59
0.54∠174	0.31∠139	1.65∠143	0.45∠-105	1.22	0.30∠-177	2.85	10	0.61∠-148	0.45∠155	6.59
0.67∠105	0.35∠103	2.85∠160	.77∠-47	1.23	0.40∠-132	10.3	2	0.39∠-130	0.30∠3.8	10.8
0.67∠105	0.35∠103	2.85∠160	.77∠-47	1.23	0.40∠-132	25	2	0.40∠-131	0.30∠2.6	10.8
0.67∠105	0.35∠103	2.85∠160	.77∠-47	1.23	0.40∠-132	25	10	0.38∠-128	0.29∠6.3	10.8

changes the design procedure for multi stage LNAs. To have a better insight for effect of second stage's NF in overall NF, simulation results in terms of Overall NF depending on NF of the second stage is presented in Fig. 2. It can be seen that using proposed method leads to better overall NF. In low NF cases the improvement is marginal while in high NF second stages the overall NF decrement can be considerable.

3. Circuit Design

To validate the theoretical results and check the feasibility of proposed method and also its comparison to the traditional approach, two different LNAs with conventional and proposed approach have been designed using ADS. These LNAs made with two stages with the same second stage. This stage has relatively high NF to emphasize the effect of the change in Γ_{opt}

and the first stage is optimized according to the proposed and the conventional approaches, in first and second LNA respectively. The design methodology consists of five steps:

- 1- Finding the S-parameters of the transistor in specified biasing and frequency.
- 2- Calculating the Γ_s according to (15).
- 3- Calculating the Γ_L using (5).
- 4- Designing input and output matching according to calculated magnitude in center frequency.
- 5- Fine-tuning the elements for better performance considering the layout effect.

While realizing in IC mode is not available, discrete circuit is chosen to validate the theoretical approach. Transistor ATF13136 as a high performance gallium arsenide Schottky-barrier-gate field effect transistor with $f_T = 40GHz$ is chosen. Its premium NF makes it appropriate for use in LNA's first stage

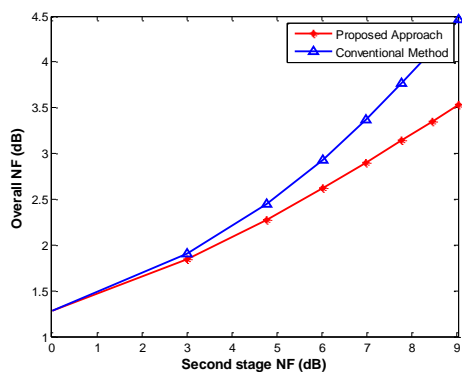

Figure 2: Effect of second stage's NF in overall NF

in 2-16 GHz frequency range.

The first circuit is designed in a way that in the first stage $\Gamma_{source} = \Gamma_{opt}$ where Γ_{opt} is the optimum impedance in which minimum NF of first stage is achievable. The second circuit is designed in such a way that $\Gamma_{source} = \Gamma_{opt-overall}$ in which $\Gamma_{opt-overall}$ is the optimum impedance for overall NF of the LNA.

The difference between Γ_{opt1} and $\Gamma_{opt-overall}$ is calculated using the MATLAB code developed for numerical solution of new optimization method which uses first stage's S-parameter, Γ_{opt} , NF_{min} , R_n as well as second stage's NF.

S-parameters of transistor is obtained in accordance with its biasing point using the data sheet provided by the manufacturer company. The $V_{ds} = 2.5V$ and $I_{ds} = 20mA$ was chosen according to data sheet for best NF performance. As shown in Fig. 3. for both first and second stage common source stage are used. The transistor is biased using self-biasing resistor and its noise has been eliminated at the operating frequency by a parallel capacitor. For DC feed a quarter wavelength transmission line with micro-strip radial stub is used and optimized at the frequency of 4 GHz and the optimized matching circuits of each design are realized using micro-strip lines. It should be mentioned that Both conventional and proposed LNAs have same schematic with different magnitudes of elements.

The second stage LNA is designed with rather high NF of 7dB for emphasizing the effect of proposed optimization method. The magnitude of elements for both designs are gathered in table II.

The performance comparison is done according to momentum simulation in ADS and LNA with better performance (proposed approach) is fabricated in order to show feasibility of theoretical calculations. Simulation results show the improvement of performance of proposed approach in comparison to conventional design method. Fig. 4-5 shows S-parameters and NF of both LNAs. The simulation results show despite slight increment in first stage's NF, the overall NF decreases due to better gain. The PCB of proposed first stage and second stage were made on the substrate with $\epsilon_r = 2.55$, $t_\delta = .0022$ and thickness of 1.35mm.

Pictures of these LNAs are represented in Fig. 6.

Table 2: Elements of designed LNAs

Proposed first stage	Conventional first stage	Second stage
$L_{11} = 8.7mm$	$L_{21} = 10mm$	$L_{21} = 17mm$
$L_{12} = 8mm$	$L_{22} = 11.1mm$	$R_1 = 35ohm$
$L_{13} = 10.8mm$	$L_{23} = 15.2mm$	$L_{23} = 11.5mm$
$L_{14} = 3.8mm$	$L_{24} = 18.9mm$	$L_{24} = 18mm$

Measurement results confirm the performance of designed LNA and shows that the proposed approach achieves NF of 4.5 dB and Gain of 8 dB. The difference between simulated results and measured data happens because of process variation of transistors and also the effect of SMA connector's non ideality and losses caused by soldering effect.

The data sheet states that the pinch-off voltage can vary from -4 V to -0.5 V and the saturated drain current I_{DSS} also vary from 40 to 90 mA. The process variation in transistors changes their biasing point and respectively their S-parameter and this change affects the obtained gain and also NF.

The non ideality of connector and soldering effect in input and output port leads to increment in NF and change of input and output impedance matching and also it affects the connection of first and second stage which changes the frequency response of designed LNA. The non ideality of soldering changes the frequency response of the circuit due to the added parasitic inductors and resistors in some sensitive nodes like transistor bases. These effects lead to the increase in NF and decrease in gain and also the change of frequency response. It should be mentioned that even with measurement effects the NF of LNA designed with the conventional method is higher than the LNA designed with proposed method.

The S-parameters of each stage individually are measured and depicted in Fig. 7.

4. Conclusion

In this paper, a new methodology for optimization of first stage of multistage LNA is presented. This method has investigated the effect of following stage's noise in optimization of Γ_s of LNA. Analytical calculations prove that overall-NF contours are different from constant NF circles in Γ_s Smith-chart and Γ_{opt} changes while considering following stage's noise. This method can be used for optimization of gain and NF simultaneously. The analytical solution shows consideration of overall LNA in optimization of gain and NF, leads to improvement of its performance. The results of EM-simulation of LNA's layout is represented for both conventional and proposed method. This result shows the feasibility of proposed design approach. Also comparing this method with conventionally used approach shows that with slight degradation in first stage's NF, its gain can be improved in way that overall-NF decreases.

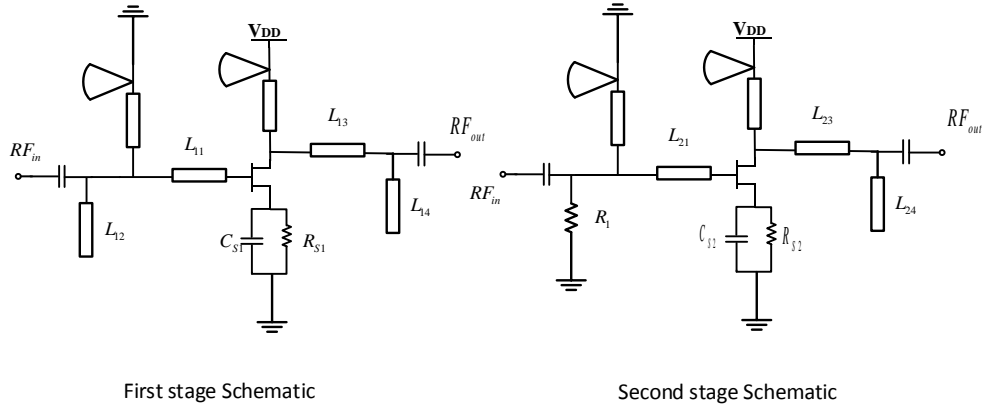

Figure 3: Schematic of designed LNAs

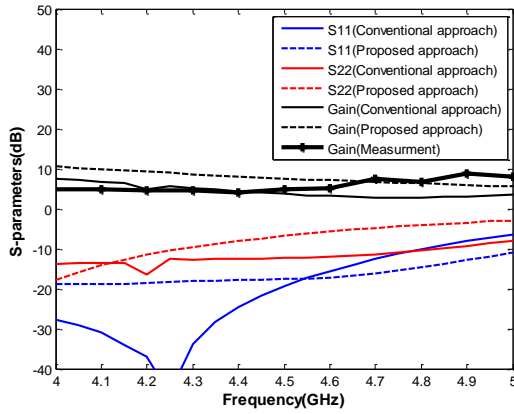

Figure 4: S-parameter comparison of two LNAs

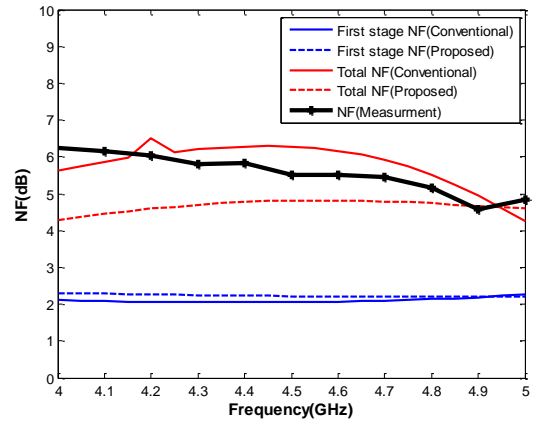

Figure 5: Overall NF and first stage NF comparison of two LNAs

To prove the theoretical and simulation results a discrete multi stage LNA has been designed with ATF13136 transistor and the results confirm the proposed method's performance improvement in comparison to conventional design method. The designed LNA with proposed method shows lower NF and higher gain with ADS momentum simulation in comparison to conventional method because it have better input matching optimization.

5. References

- [1] B. Razavi, "RF Microelectronics", Prentice Hall, (1998).
- [2] W. Sanghyun, K. Woonyun, and J. Laskar, "A 3.6 mW differential common-gate CMOS LNA with positive-negative feedback", *IEEE Int. Solid-State Circuits Conf. Dig. Tech. Paper (ISSCC)* (2009), 218-219
- [3] J. Kim, S. Hoyos, and J. Silva-Martinez, "Wideband common-gate CMOS LNA employing dual negative feedback with simultaneous noise, gain, and bandwidth optimization", *IEEE Trans. Microw. Theory Techn.* 58 (2010), 2340-2351
- [4] S. Blaakmeer, E. Klumperink, D. Leenaerts, and B. Nauta, "Wideband balun-LNA with simultaneous output balanc-

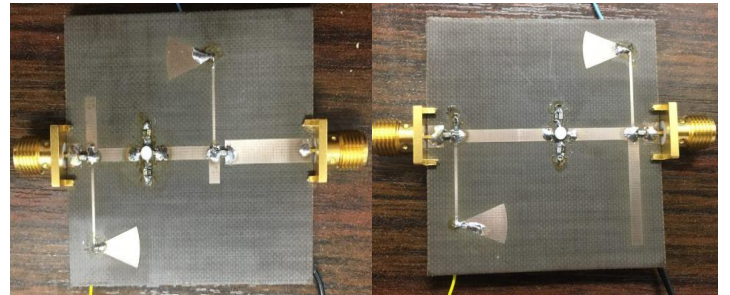

Figure 6: PCB of designed LNAs: Proposed first stage and Second stage

- ing, noise-canceling and distortion-canceling", *IEEE J. Solid-State Circuits* 43 (2008), 1341-1350
- [5] J. Jussila and P. Sivonen, "A 1.2-V highly linear balanced noise-cancelling LNA in 0.13- μ m CMOS", *IEEE J. Solid-State Circuits* 43 (2008), 579-587.
- [6] K. H. Chen and S.-I. Liu, "Inductorless wideband CMOS low-noise amplifiers using noise-canceling technique", *IEEE Trans. Circuits Syst. I, Reg. Papers* 59 (2012), 305-314
- [7] A. Meamar, C. C. Boon, K. S. Yeo, and A. V. Do, "A wideband low power low-noise amplifier in CMOS tech-

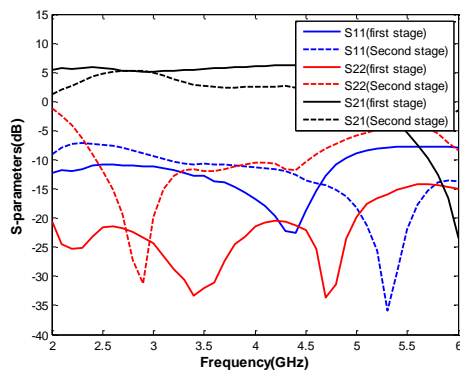

Figure 7: Measurement S-parameters of each stage

nology”, *IEEE Trans. Circuits Syst. I, Reg. Papers* 57 (2010), 773-782

[8] C. W. Kim, M.S. Kang, P. T. Anh, H.T. Kim, and S.G. Lee, ”An ultra wideband CMOS low noise amplifier for 3-5 GHz UWB system”, *IEEE J. Solid-State Circuits* 40 (2005), 544-547

[9] J. H. Zhan and S. Taylor, ”A 5 GHz resistive-feedback CMOS LNA for low-cost multi-standard applications”, *IEEE Int. Solid-State Circuits Conf. Dig. Tech. Paper (ISSCC)* (2006), 721-730

[10] B. G. Perumana, J.-H. C. Zhan, S. S. Taylor, B. R. Carlton, J. Laskar, ”Resistive-feedback CMOS low-noise amplifiers for multiband applications”, *IEEE Trans. Microw. Theory Techn.* 56 (2008), 1218-1225

[11] B. A. Abelan, M. Seelmann-Eggebert, D. Bruch, A. Leuther, H. Massler, B. Baldischweiler, M. Schlechtweg, J. D. Gallego-Puyol, I. Lopez-Fernandez, C. Diez-Gonzalez, I. Malo-Gomez, E. Villa, E. Artal, ”412 and 2534 GHz cryogenic mHEMT MMIC low-noise amplifiers”, *IEEE Trans. Microw. Theory Techn.* 60 (2012), 4080-4088

[12] M. Sabzi, A. Medi, ”Analysis and design of multi-stage wideband LNA using simultaneously noise and impedance matching method”, *Microelectronics Journal* 86 (2019), 97-104

[13] M. Daoud, R. Aloulou, H. Mnif, M. Ghorbel, ”Inductive degeneration low noise amplifier for IR-UWB receiver for biomedical implant”, *2015 27th International Conference on Microelectronics (ICM)* (2015), 95-98

[14] L. Belostotski, J. W. Haslett, ”Noise figure optimization of inductively degenerated CMOS LNAs with integrated gate inductors”, *IEEE Trans. Circuits Syst.* 53 (2006), 1409-1422

[15] S. Bhaumik, D. Kettle, ”Broadband X-band low noise amplifier based on 70 nm GaAs metamorphic high electron mobility transistor technology for deep space and satellite communication networks and oscillation issues”, *IET Microw. Antennas Propag.* 4 (2010), 1208-1215

[16] D. Shaeffer, T. Lee, ”A 1.5 V 1.5 GHz CMOS low noise amplifier”, *J. Solid-State Circuits* 32 (1997), 745-759

[17] M. Heins et al., ”X-band GaAs mHEMT LNAs with 0.5 dB noise figure”, *2004 IEEE MTT-S IMS 1* (2004), 149-152

[18] C. Feng, X. P. Yu, Z. H. Lu, W. M. Lim, W. Q. Sui, ”3-10 GHz self-biased resistive-feedback LNA with inductive source degeneration”, *IEEE Electron. Lett.* 49 (2013), 387-388

[19] W. Ciccognani, E. Limiti, P. Longhi, M. Renvoise, ”MMIC LNAs for radioastronomy applications using advanced industrial 70 nm metamorphic technology”, *IEEE J. Solid-State Circuits* 45 (2010), 2008-2015

[20] R. E. Lehmann and D. D. Heston, ”X-Band Monolithic Series Feedback LNA”, in *IEEE Transactions on Microwave Theory and Techniques*, 33 (1985), 1560-1566

[21] L. Boglione, R. D. Pollard, V. Postoyalko and T. Alam, ”Specifications for a linear network simultaneously noise and available-power matched”, *IEEE Microwave and Guided Wave Letters*, 6 (1996), 407-409

[22] T.K. Nguyen, ”CMOS low noise amplifier design optimization techniques”, *IEEE Trans. Microwave Theory Tech.*, 52 (2004), 1433-1442

[23] I. Bahl, ”RF and Microwave Transistor Amplifiers”, NJ, Hoboken:Wiley, (2009).

[24] W. Ciccognani, S. Colangeli, E. Limiti, P. Longhi, ”Noise measure- based design methodology for simultaneously matched multi-stage LNAs”, *IET Circuits Devices Syst.* 6 (2011), 63-70

[25] H. A. Haus, R. B. Adler, ”Optimal noise performance of linear amplifiers”, *Proc. IRE* 46 (1958), 1517-1533

[26] R. B. Adler, H. A. Haus, ”Network realization of optimum amplifier noise performance”, *IRE Trans. Circuit Theory* 5 (1958), 156-161

[27] H. Rothe, W. Dahlke, ”Theory of noisy four poles”, *Proc. IRE* 44 (1956), 811-818

[28] H. A. Haus, ”Representation of noise in linear twoports”, *Proc. IRE* 48 (1960), 69-74

[29] W. Ciccognani, P. Longhi, S. Colangeli, E. Limiti, ”Constant mismatch circles and application to low-noise microwave amplifier design”, *IEEE Trans. Microwave Theory Tech.* 61 (2013), 4154-4167

[30] D. M. Pozar, ”Microwave and RF Design of Wireless System” in , John Wiley and Sons Inc, (2000)