



**HAL**  
open science

# T-S Fuzzy Observers to Design Actuator Fault-Tolerant Control for Automotive Vehicle Lateral Dynamics

Naoufal El Youssfi, Rachid El Bachtiri

► **To cite this version:**

Naoufal El Youssfi, Rachid El Bachtiri. T-S Fuzzy Observers to Design Actuator Fault-Tolerant Control for Automotive Vehicle Lateral Dynamics. Building Transportation, Traffic and Engineering Systems, IntechOpen, In press, 10.5772/intechopen.92582 . hal-02644435

**HAL Id: hal-02644435**

**<https://hal.science/hal-02644435>**

Submitted on 19 Sep 2020

**HAL** is a multi-disciplinary open access archive for the deposit and dissemination of scientific research documents, whether they are published or not. The documents may come from teaching and research institutions in France or abroad, or from public or private research centers.

L'archive ouverte pluridisciplinaire **HAL**, est destinée au dépôt et à la diffusion de documents scientifiques de niveau recherche, publiés ou non, émanant des établissements d'enseignement et de recherche français ou étrangers, des laboratoires publics ou privés.

# We are IntechOpen, the world's leading publisher of Open Access books Built by scientists, for scientists

4,800

Open access books available

122,000

International authors and editors

135M

Downloads

Our authors are among the

154

Countries delivered to

TOP 1%

most cited scientists

12.2%

Contributors from top 500 universities



WEB OF SCIENCE™

Selection of our books indexed in the Book Citation Index  
in Web of Science™ Core Collection (BKCI)

Interested in publishing with us?  
Contact [book.department@intechopen.com](mailto:book.department@intechopen.com)

Numbers displayed above are based on latest data collected.  
For more information visit [www.intechopen.com](http://www.intechopen.com)



# T-S Fuzzy Observers to Design Actuator Fault-Tolerant Control for Automotive Vehicle Lateral Dynamics

*Naoufal El Youssfi and Rachid El Bachtiri*

## Abstract

This article presents a fault-tolerant control (FTC) procedure for the automotive vehicle lateral dynamics (AVLD) described by the Takagi-Sugeno (T-S) fuzzy models. This approach focuses on actuator faults, which requires knowledge of the system parameters and the faults that are occurring. For this reason, T-S fuzzy observers are suitable for simultaneously estimating system states and actuator faults. The proposed control makes it possible to maintain vehicle stability even in the presence of faults. The design of fuzzy observers and fuzzy controllers is mainly based on the one-step method of Lyapunov, which is provided in the form of linear matrix inequalities (LMIs). The simulation results clearly illustrate the effectiveness of the applied controller strategy to maintain vehicle stability.

**Keywords:** fault-tolerant control (FTC), automotive vehicle lateral dynamics (AVLD), linear matrix inequality (LMI), fault estimation (FE), continuous Takagi-Sugeno (T-S) fuzzy models

## 1. Introduction

The vast majority of road accidents are due to faults or incorrect driving reflexes. This is why the automotive industry and researchers in the field of road safety have dedicated themselves to developing and producing vehicles that are more reliable, more relaxed, and safer, which are discussed in Refs. [1–3]. In recent decades, many new solutions have been suggested by the introduction and development of new passive safety systems such as airbags and driver-assisted active safety systems such as adaptive cruise control (ACC), antilock braking system (ABS), dynamic stability control (DSC), and electronic stability program (ESP) [4–6]. Furthermore, the dependence of the control of these systems on actuator components is becoming increasingly complicated. Generally, these systems can be exposed to certain catastrophic faults such as unknown actuator faults. It is well known that conventional control strategies are unable to adapt when system failures happen.

To address this challenge, some previous research has based on estimation techniques for vehicle dynamics, road bank angle, and faults in order to develop control laws capable of ensuring that the system maintains strict stability even when various faults happen. This task is commonly referred to as fault-tolerant control

(FTC), which is widely studied in modern control systems [7–9]. In fact, the safety of persons and the preservation of system performance are crucial requirements that have to be considered in the control design. The problem of fault tolerance has long been addressed from many angles. The FTC synthesis approaches are categorized as passive or active FTC. For the passive FTC approach, we consider possible fault situations and take them into account in the control design step; this approach is similar to the robust control design. It is pointed out in many books that this strategy is generally restrictive. While active FTC improves post-fault control performance and addresses serious faults that break the control loop, it is generally advantageous to switch to a new controller that is either online or designed offline to control the faulty plant. The FTC process is based on two theoretical steps: fault estimation (FE) and setting the controller so that the control law is reconfigured to meet the performance requirements due to the faults.

The FTC procedure was first adjusted for linear systems. Most engineering systems include vehicle dynamics that have nonlinear behaviors. The T-S fuzzy representation is widely known to be a successful solution to approximate a large class of nonlinear dynamic systems. T-S fuzzy models are nonlinear systems represented by a set of local linear models. By mixing the representations of linear systems, the global fuzzy model of the system is obtained, which makes it much easier for the observer and controller to synthesize. A major advantage is that it provides an efficient design strategy for representing a nonlinear system. As a result, many researchers have become interested in the FTC approach for T-S fuzzy systems (see [10–12]).

In this regard, great efforts have been made to improve the stability of the vehicle lateral dynamics to enhance the safety and comfort of the passengers in critical driving conditions. Since the vehicle is a very complex system, the challenge is to achieve more precise control designs and to increase the effectiveness of a vehicle dynamic control system, which necessitates an accurate knowledge of vehicle parameters, in particular, sideslip, roll, and yaw angles [12, 13].

Our main objective in this chapter is to apply a fault-tolerant control method in the vehicle lateral dynamics system. The model used contains four states: lateral slip angle, yaw rate, roll rate, and roll angle. The problem of the design of fault-tolerant active control of nonlinear systems is studied by using the T-S representation which combines the simplicity and accuracy of nonlinear behaviors. The idea is to consider a set of linear subsystems. An interpolation of all these sub-models using nonlinear functions satisfying the convex sum property gives the overall behavior of the described system over a wide operating range. The stability of the T-S models of the vehicle lateral dynamics is mainly studied using the Lyapunov function, and sufficient asymptotic stability conditions are given in the form of linear matrix inequalities (LMIs).

The chapter is structured as follows: the second section deals with the model of vehicle lateral dynamics considering roll motion, the third section presents this model through the T-S fuzzy model, the fourth section presents the fault-tolerant control strategy based on the T-S fuzzy observer, and the fifth section is devoted to simulations and analysis of the results. Finally, the conclusion will be included in the last section.

**Notation:** A real symmetrical negative definite matrix (resp. positive definite matrix) is represented by  $X < 0$  (resp.  $X > 0$ ).  $X^{-1}$  indicates the inverse of the matrix  $X$ . The marking “\*” signifies the transposed element in the symmetrical position of a matrix.

## 2. Description of the lateral dynamics of the automotive vehicle

The automotive dynamics model is very challenging to use in controlling and monitoring applications due to its complexity and number of degrees of freedom.

For this purpose, a nominal model for the synthesis of observers and controllers is needed. The vehicle motion is characterized by a combination of translational and rotational movements (see **Figure 1**) [14], generally six principal movements. The model used in this document outlines the lateral dynamics of the automotive vehicle, taking into account the rolling motion (**Figure 2**) [15]. This model is achieved by considering the widely known “bicycle model” with a rolled degree of freedom. Here, the lateral velocity  $v_y(t)$ , the yaw angle  $\psi(t)$ , and the roll angle  $\phi(t)$  of the vehicle are the differential variables. The suspension is modeled as a spring and torsion damping system operating around the roll axis, as illustrated in **Figure 2**. The pitch dynamics of the vehicle is ignored or even neglected.

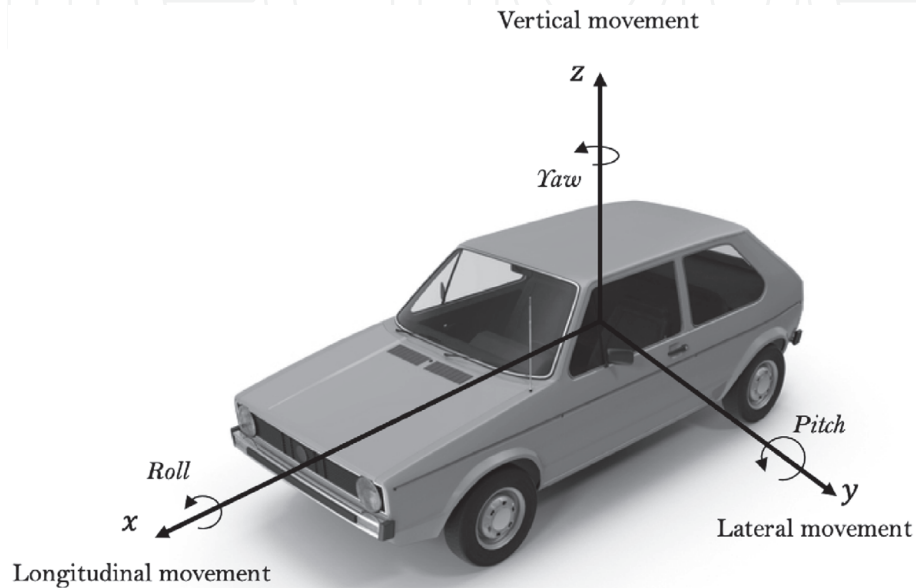

**Figure 1.**  
 The movements of the automotive vehicle bodywork.

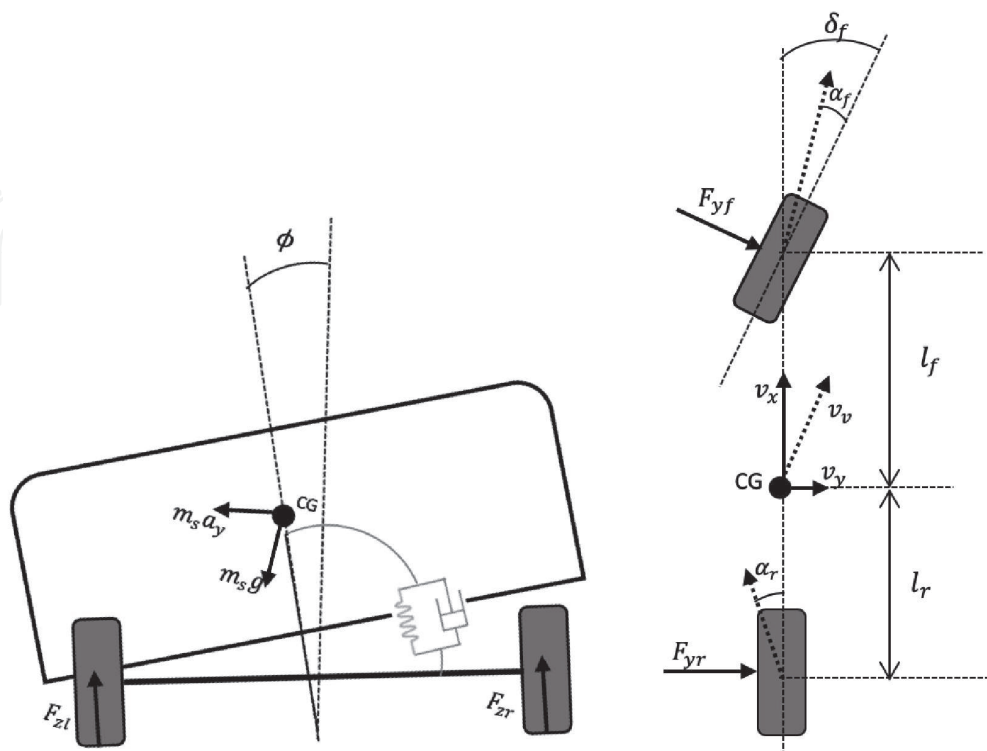

**Figure 2.**  
 Bicycle model with roll behavior of automotive vehicle dynamics (3-DOF).

The nonlinear model of the automotive vehicle lateral dynamics considering the roll angle to be small is given in [12] by the following simplified differential equations:

$$\begin{cases} m\dot{v}_y(t) = -m\dot{\psi}(t)v_y(t) + 2(F_{yf} + F_{yr}) \\ I_z\dot{\psi}(t) = 2(l_r F_{yr} - l_f F_{yf}) \\ I_x\ddot{\phi}(t) + K_\phi\dot{\phi}(t) + C_\phi\phi(t) = mh_{roll}(v_y(t) + v_x(t)\dot{\psi}(t)) \end{cases} \quad (1)$$

All system parameters are defined in **Table 1**.

Lateral forces can be given according to Pacejka's magic formula referenced in [16], depending on the sliding angles of the tires. To simplify the vehicle model, we assume that the forces  $F_{yf}$  and  $F_{yr}$  are proportional to the slip angles of the front and rear tires:

$$\begin{cases} F_{yf} = C_f\alpha_f(t) \\ F_{yr} = C_r\alpha_r(t) \end{cases} \quad (2)$$

where  $C_f$  and  $C_r$  are the front and rear wheel cornering stiffness coefficients, respectively, which depend on the road adhesion coefficient  $\sigma$  and the parameters of the vehicle. The linear model functions very successfully in the case of small slip angles; however, in the case of increasing slipping, a nonlinear model should be envisaged.

### 3. T-S fuzzy representation of the automotive vehicle lateral dynamics

The challenge in modeling vehicle dynamics accurately is that contact forces are complex to measure and to model. By using the T-S models' method proposed in [15, 17], it is a highly useful mathematical representation of nonlinear systems, as they can represent any nonlinear system, regardless of its complexity, by a simple structure based on linear models interpolated by nonlinear positive functions. They have a simple structure with some interesting properties. This makes them easily exploitable from a mathematical viewpoint and makes it possible to extend certain results from the linear domain to nonlinear systems.

Parameters	Description	Unit
$m$	Vehicle total mass	[kg]
$v_x/v_y$	Vehicle speed/vehicle lateral velocity	[m/s]
$I_x/I_z$	Roll/yaw inertia moment at the center of gravity	[kg m <sup>2</sup> ]
$l_f/l_r$	Distance from the center of gravity to front/rear axles	[m]
$h_{roll}$	Center of gravity height from the roll axis	[m]
$C_\phi/K_\phi$	Combined roll damping/stiffness coefficients	[N.ms/rad][N.m/rad]
$F_{yf}/F_{yr}$	Front/rear lateral forces	[N]
$\alpha_f/\alpha_r$	Front/rear tire slip angles	[rad]

**Table 1.** Parameters of the automotive vehicle lateral dynamics system.

Tire characteristics are usually assumed that the front and rear lateral forces (2) are modeled by the following rules:

$$\text{if } |\alpha_f| \text{ is } M_1 \text{ then } \begin{cases} F_{yf} = C_{f1}\alpha_f(t) \\ F_{yr} = C_{r1}\alpha_r(t) \end{cases} \quad (3)$$

$$\text{if } |\alpha_f| \text{ is } M_2 \text{ then } \begin{cases} F_{yf} = C_{f2}\alpha_f(t) \\ F_{yr} = C_{r2}\alpha_r(t) \end{cases} \quad (4)$$

The front and rear tire slip angles are given in this instance as cited in [12], by

$$\begin{cases} \alpha_f(t) \approx \delta_f(t) - \frac{a_f \dot{\psi}(t)}{v_x(t)} - \beta(t) \\ \alpha_r(t) \approx \frac{a_r \dot{\psi}(t)}{v_x(t)} - \beta(t) \end{cases} \quad (5)$$

The proposed rules are only made for  $\alpha_f(t)$ ; this assumption reduces the number of adhesion functions and considers the rear steering angle to be ignored;  $\alpha_f(t)$  and  $\alpha_r(t)$  are considered to be in the same fuzzy ensemble. The combined front and rear forces are generated by

$$\begin{cases} F_{yf} = \sum_{i=1}^2 h_i(\xi(t)) C_{fi} \alpha_f(t) \\ F_{yr} = \sum_{i=1}^2 h_i(\xi(t)) C_{ri} \alpha_r(t) \end{cases} \quad (6)$$

With  $h_i (i = 1,2)$  as membership functions, relating to the front tire slip angles  $\alpha_f(t)$ , which are considered to be available for measurement, they satisfy the following assumptions:

$$\begin{cases} \sum_{i=1}^2 h_i(\xi(t)) = 1 \\ 0 \leq h_i(\xi(t)) \leq 1, \quad i = 1, 2 \end{cases} \quad (7)$$

The membership function  $h_i(\xi(t))$  expressions are the following:

$$h_i(\xi(t)) = \frac{\omega_i(\xi(t))}{\sum_{i=1}^2 \omega_i(\xi(t))} \text{ with } : \xi(t) = |\alpha_f(t)| \quad (8)$$

and

$$\omega_i(\xi(t)) = \frac{1}{\left(1 + \left|\frac{\xi(t) - c_i}{a_i}\right|\right)^{2b_i}} \quad (9)$$

To determine the membership function parameters and the stiffness coefficient parameters, an identification method based on the Levenberg–Marquardt algorithm in combination with the least squares method is used as in [18], the values listed in **Table 2**.

Nominal stiffness coefficients	$C_{f1}$	$C_{f2}$	$C_{r1}$	$C_{r2}$
Values	55,234	15,544	49,200	13,543
Membership function coefficients				
$a_1 = 0.0785$	$b_1 = 1.7009$		$c_1 = 0.0284$	
$a_2 = 0.1126$	$b_2 = 12.0064$		$c_2 = 0.1647$	

**Table 2.**  
Nominal stiffness and membership function coefficients.

The nonlinear lateral dynamics of the automotive vehicle, described by Eq. (1), can be written as follows:

$$\begin{cases} \dot{x}(t) = \sum_{i=1}^2 h_i(\xi)(A_i x(t) + B_i u(t)) \\ y(t) = \sum_{i=1}^2 h_i(\xi) C_i x(t) \end{cases} \quad (10)$$

where  $x(t) = [v_y \quad \dot{\psi} \quad \phi \quad \dot{\phi}]^T$  is the system state vector,  $y(t)$  is the measured output vector, and  $u(t)$  is the input vector. In this study, we consider that the input signal is the front wheel steering angle given by the driver  $u(t) = \delta_{fd}$ .  $\{A_i, B_i, C_i\}$  are sub-model matrices, which are given as follows:

$$A_i = \begin{bmatrix} a_{11} & a_{12} & 0 & 0 \\ a_{21} & a_{22} & 0 & 0 \\ 0 & 0 & 0 & 1 \\ a_{41} & a_{42} & a_{43} & a_{44} \end{bmatrix}; B_i = \begin{bmatrix} b_{11} \\ b_{21} \\ 0 \\ b_{41} \end{bmatrix}; C_i = \begin{bmatrix} c_{11} & c_{12} & 0 & 0 \\ 0 & 1 & 0 & 0 \end{bmatrix}$$

with

$$\begin{aligned} a_{11} &= -\frac{2(C_{f1} + C_{r1})}{mv_x}, & a_{12} &= \frac{2(a_f C_{f1} - a_r C_{r1})}{mv_x} - v_x, & a_{21} &= -\frac{2(a_f C_{f1} + a_r C_{r1})}{I_z v_x} \\ a_{22} &= \frac{2(a_f^2 C_{f1} - a_r^2 C_{r1})}{I_z v_x}, & a_{41} &= -\frac{2h_{roll}(C_{f1} + C_{r1})}{mv_x I_x}, & a_{42} &= \frac{2m_s h_{roll}(C_{f1} + C_{r1})}{mv_x I_x} \\ a_{43} &= \frac{h_{roll} m_s g - K_\phi}{I_x}, & a_{44} &= \frac{C_\phi}{I_x}, & c_{11} &= -2\frac{C_{f1} + C_{r1}}{mv_x}, & c_{12} &= -2\frac{C_{f1} a_f - C_{r1} a_r}{mv_x} \\ b_{11} &= \frac{2C_{f1}}{m}, & b_{21} &= \frac{2a_f C_{f1}}{I_z}, & b_{41} &= \frac{2m_s h_{roll} C_{f1}}{m I_x} \end{aligned}$$

**Lemma 1.** [19] Let the matrices  $N_{ij}$  and the condition be

$$\begin{aligned} \sum_{i=1}^r \sum_{j=1}^r h_i(\xi(t)) h_j(\xi(t)) N_{ij} &= \sum_{i=1}^r h_i^2(\xi(t)) N_{ii} \\ &+ \sum_{i=1}^r \sum_{i < j}^r h_i(\xi(t)) h_j(\xi(t)) (N_{ij} + N_{ji}) < 0 \Xi \end{aligned}$$



true if there exist matrices  $\Xi_{ii}$  and  $\Xi_{ij}$  such that the following conditions are fulfilled:

$$\begin{aligned} N_{ii} &< \Xi_{ii}, \quad i = 1, \dots, r, \\ N_{ij} + N_{ji} &\leq \Xi_{ij} + \Xi_{ij}^T, \quad i, j = 1, 2, \dots, r, \quad i < j \\ \begin{bmatrix} \Xi_{11} & \Xi_{12} & \dots & \Xi_{1r} \\ * & \Xi_{22} & \dots & \Xi_{2r} \\ \vdots & \vdots & \ddots & \vdots \\ * & * & \dots & \Xi_{rr} \end{bmatrix} &< 0 \end{aligned}$$

#### 4. Fault-tolerant control strategy based on T-S fuzzy observers

The purpose of this section is to design a faulty T-S fuzzy system for the vehicle model. Then, observers are trained to estimate system states and actuator faults. Next, a fault-tolerant control law is developed from the information provided by the observers.

##### 4.1 Faulty vehicle lateral dynamics system description

From the T-S zero fault model (10), the system in the presence of actuator faults  $f(t)$  is described as follows:

$$\begin{cases} \dot{x}_f(t) = \sum_{i=1}^2 h_i(\xi(t))(A_i x_f(t) + B_i(u_{FTC}(t) + f(t))) \\ y_f(t) = \sum_{i=1}^2 h_i(\xi(t))C_i x_f(t) \end{cases} \quad (11)$$

where  $x_f(t)$  is the faulty system state vector,  $y_f(t)$  is the measured output vector of the faulty system, and  $f(t)$  are the actuator faults.  $u_{FTC}(t)$  is the control law to be conceived thereafter; it is considered to be equivalent to a fault-tolerant control law added to the front wheel steering angle given by the driver.

##### 4.2 T-S fuzzy observers design

In this subsection, the T-S fuzzy observers are constructed to simultaneously estimate states and actuator faults. Consider the following T-S observers:

$$\begin{cases} \dot{\hat{x}}_f(t) = \sum_{i=1}^2 h_i(\xi(t)) \left( A_i \hat{x}_f(t) + B_i (u_{FTC}(t) + \hat{f}(t)) + L_i (y_f(t) - \hat{y}_f(t)) \right) \\ \hat{y}_f(t) = \sum_{i=1}^2 h_i(\xi(t)) C_i \hat{x}_f(t) \\ \dot{\hat{f}}(t) = \sum_{i=1}^2 h_i(\xi(t)) G_i (y_f(t) - \hat{y}_f(t)) \end{cases} \quad (12)$$

where  $\hat{x}_f(t)$  and  $\hat{f}(t)$  are the estimates of the state vector and the faults, respectively.  $\hat{y}_f(t)$  is the estimate of the output vector.  $L_i$  and  $G_i$  are the gain matrices with the appropriate dimensions to be resolved.

The output error between faulty T-S fuzzy systems (11) and T-S fuzzy observers (12) is given by

$$e_y(t) = y_f(t) - \hat{y}_f(t) \quad (13)$$

$$= \sum_{i=1}^2 h_i(\xi(t)) C_i (x_f(t) - \hat{x}_f(t)) \quad (14)$$

$$= \sum_{i=1}^2 h_i(\xi(t)) C_i e_x(t) \quad (15)$$

The dynamics of the estimation error  $e_x(t) = x_f(t) - \hat{x}_f(t)$  can be written as follows:

$$\dot{e}_x(t) = \sum_{i=1}^2 \sum_{j=1}^2 h_i(\xi(t)) h_j(\xi(t)) ((A_i - L_i C_j) e_x(t) + B_i e_f(t)) \quad (16)$$

with  $e_f(t) = f(t) - \hat{f}(t)$ .

The tracking error  $e_t(t)$  is expressed by

$$e_t(t) = x(t) - x_f(t) \quad (17)$$

and its dynamics is given by

$$\dot{e}_t(t) = \sum_{i=1}^2 h_i(\xi(t)) (A_i x(t) + B_i u(t)) - \sum_{i=1}^2 h_i(\xi(t)) (A_i x_f(t) + B_i (u_{FTC}(t) + f(t))) \quad (18)$$

$$= \sum_{i=1}^2 h_i(\xi(t)) (A_i e_t(t) + B_i (u(t) - u_{FTC}(t)) - B_i f(t)) \quad (19)$$

### 4.3 Design fault-tolerant control based on T-S fuzzy observers

A fault-tolerant control is proposed in this section to ignore the impact of faults and to maintain the stability of the faulty vehicle dynamics system. The suggested control procedure is outlined in **Figure 3** [20].

Consider the following control law:

$$u_{FTC}(t) = - \sum_{i=1}^2 h_i(\xi(t)) F_i (x(t) - \hat{x}_f(t)) + u(t) - \hat{f}(t) \quad (20)$$

where  $F_i$  are the controller gains.

Substituting Eq. (20) in Eq. (19) gives:

$$\dot{e}_t(t) = \sum_{i=1}^2 \sum_{j=1}^2 h_i(\xi(t)) h_j(\xi(t)) (A_i e_t(t) + B_i F_j (x(t) - \hat{x}_f(t)) - B_i e_f(t)) \quad (21)$$

$$= \sum_{i=1}^2 \sum_{j=1}^2 h_i(\xi(t)) h_j(\xi(t)) ((A_i + B_i F_j) e_t(t) + B_i F_j e_x(t) - B_i e_f(t)) \quad (22)$$

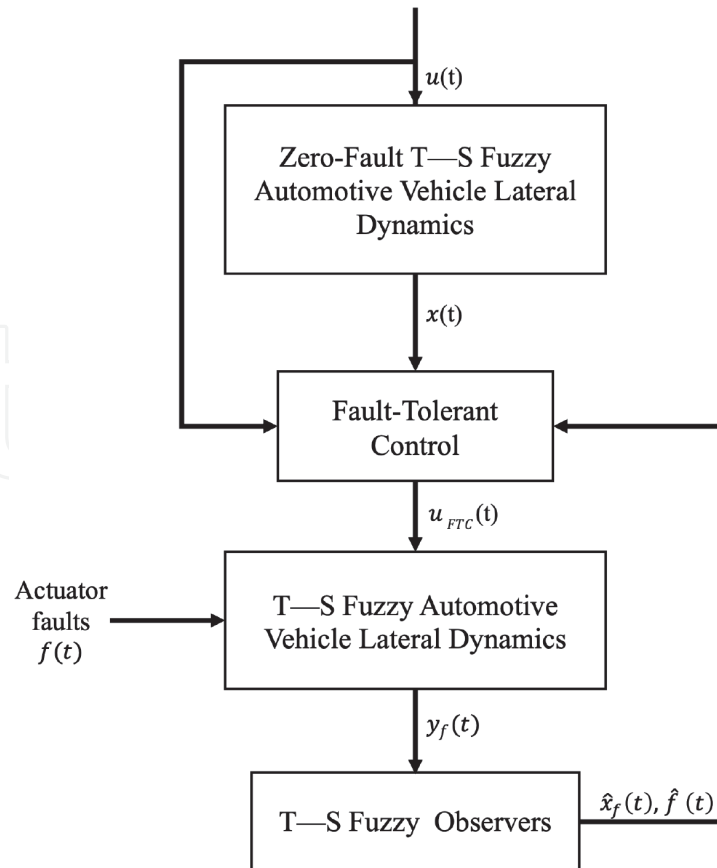

**Figure 3.**  
 Observer-based FTC scheme.

Assume that  $\dot{f}(t) = 0$ , so the dynamics of the fault estimation error  $e_f(t)$  is given as follows:

$$\dot{e}_f(t) = \dot{f}(t) - \sum_{i=1}^2 h_i(\xi(t)) G_i (y_f(t) - \hat{y}_f(t)) \quad (23)$$

$$= - \sum_{i=1}^2 \sum_{j=1}^2 h_i(\xi(t)) h_j(\xi(t)) G_i C_j e_x(t) \quad (24)$$

Consider the following augmented system:

$$\dot{\bar{e}}(t) = \sum_{i=1}^2 \sum_{j=1}^2 h_i(\xi(t)) h_j(\xi(t)) \bar{A}_{ij} \bar{e}(t) \quad (25)$$

where  $\bar{e} = \begin{bmatrix} e_t(t) \\ e_x(t) \\ e_f(t) \end{bmatrix}$  and

$$\bar{A}_{ij} = \begin{bmatrix} A_i + B_i F_j & B_i F_j & -B_i \\ 0 & A_i - L_i C_j & B_i \\ 0 & -G_i C_j & 0 \end{bmatrix}$$

**Theorem 1.1.** The state tracking error  $e_t(t)$ , the system state estimation error  $e_x(t)$ , and the fault estimation errors  $e_f(t)$  converge asymptotically toward zero if there exist positive scalar  $\rho > 0$ , symmetrical matrices  $P > 0$ ,  $Q_2 > 0$ ,  $Y > 0$ , and  $Y_{ii}$  ( $i = 1, 2$ ), as well as other matrices with appropriate dimensions  $U_i$ ,  $V_i$  and  $Y_{ij}$  ( $i, j = 1, 2 \& i < j$ ), such that the following conditions are satisfied:

$$\Delta_{ii} < Y_{ii}, \quad i = 1, 2. \quad (26)$$

$$\Delta_{ij} + \Delta_{ji} \leq Y_{ij} + Y_{ij}^T, \quad i, j = 1, 2, \quad i < j \quad (27)$$

$$\begin{bmatrix} Y_{11} & Y_{12} \\ * & Y_{22} \end{bmatrix} < 0 \quad (28)$$

where

$$\Delta_{ij} = \begin{bmatrix} A_i P + P A_i^T + B_i V_j + V_j^T B_i^T & B_i \bar{X}_j & 0 \\ * & -2\rho Y & \rho I \\ * & * & Q_2 \bar{A}_i + \bar{A}_i^T Q_2 - U_i \bar{C}_j - \bar{C}_j^T U_i^T \end{bmatrix} \quad (29)$$

$$\text{with } \bar{X}_j = [V_j \quad -Z] \text{ and } Y = \begin{bmatrix} P & 0 \\ 0 & Z \end{bmatrix}.$$

The gains of T-S fuzzy observers  $L_i$  and  $G_i$  and T-S fuzzy controllers  $F_i$  are calculated from

$$F_i = V_i P^{-1}, \quad \bar{E}_i = \begin{bmatrix} L_i \\ G_i \end{bmatrix} = Q_2^{-1} U_i \quad (30)$$

**Proof:** the gains  $L_i$ ,  $G_i$ , and  $F_i$  are calculated by analyzing the system stability outlined in differential Eq. (25) by using the Lyapunov method with a quadratic function.

Let us select the following quadratic Lyapunov function:

$$V(\bar{e}(t)) = \bar{e}^T(t) Q \bar{e}(t) \quad (31)$$

where  $Q$  is divided as follows:

$$Q = \begin{bmatrix} Q_1 & 0 \\ 0 & Q_2 \end{bmatrix}$$

The time derivative of  $V(t) = V(\bar{e}(t))$  can be shown to be

$$\dot{V}(t) = \bar{e}^T(t) Q \dot{\bar{e}}(t) + \dot{\bar{e}}^T(t) Q \bar{e}(t) \quad (32)$$

$$= \sum_{i=1}^2 \sum_{j=1}^2 h_i(\xi(t)) h_j(\xi(t)) \bar{e}^T(t) Q \bar{A}_{ij} \bar{e}(t) + (\bar{A}_{ij} \bar{e}(t))^T (t) Q \bar{e}(t) \quad (33)$$

$$= \sum_{i=1}^2 \sum_{j=1}^2 h_i(\xi(t)) h_j(\xi(t)) \bar{e}^T(t) (Q \bar{A}_{ij} + \bar{A}_{ij}^T Q) \bar{e}(t) \quad (34)$$

$\bar{A}_{ij}$  can be defined as follows:

$$\bar{A}_{ij} = \begin{bmatrix} A_i + B_i F_j & B_i \bar{F}_j \\ 0 & \bar{A}_i - \bar{E}_i \bar{C}_j \end{bmatrix} \quad (35)$$

where

$$\bar{F}_j = [F_j \quad -I], \quad \bar{A}_i = \begin{bmatrix} A_i & B_i \\ 0 & 0 \end{bmatrix}, \quad \bar{C}_i = [C_i \quad 0], \quad \text{and } \bar{E}_i = \begin{bmatrix} L_i \\ G_i \end{bmatrix}$$

Inequality (34) is negative if the following conditions are satisfied:

$$\dot{V}(t) = \sum_{i=1}^2 \sum_{j=1}^2 h_i(\xi(t)) h_j(\xi(t)) \Lambda_{ij} < 0 \quad (36)$$

with

$$\Lambda_{ij} = \begin{bmatrix} Q_1 A_i + A_i^T Q_1 + Q_1 B_i F_j + F_j^T B_i^T Q_1 & Q_1 B_i \bar{F}_j \\ B_i \bar{F}_j^T Q_1 & Q_2 \bar{A}_i + \bar{A}_i^T Q_2 - Q_2 \bar{E}_i \bar{C}_j - \bar{C}_j^T \bar{E}_i^T Q_2 \end{bmatrix} \quad (37)$$

Using the lemma of congruence, we have

$$\Lambda_{ij} < 0 \Leftrightarrow X \Lambda_{ij} X^T < 0 \quad (38)$$

with

$$X = \begin{bmatrix} Q_1^{-1} & 0 \\ 0 & Y \end{bmatrix}, \quad Y = \begin{bmatrix} Q_1^{-1} & 0 \\ 0 & Z \end{bmatrix}, \quad Z = Z^T > 0$$

Then, this inequality is obtained

$$\begin{bmatrix} A_i Q_1^{-1} + Q_1^{-1} A_i^T + B_i F_j Q_1^{-1} + Q_1^{-1} F_j^T B_i^T & B_i \bar{F}_j Y \\ Y B_i \bar{F}_j^T & Y S_{ij} Y \end{bmatrix} < 0 \quad (39)$$

The negativity of (39) enforces that

$$S_{ij} < 0$$

with  $S_{ij} = Q_2 \bar{A}_i + \bar{A}_i^T Q_2 - Q_2 \bar{E}_i \bar{C}_j - \bar{C}_j^T \bar{E}_i^T Q_2$ .

which can be analyzed using the following property:

$$\left( Y + \rho S_{ij}^{-1} \right)^T S_{ij} \left( Y + \rho S_{ij}^{-1} \right) \leq 0 \Leftrightarrow Y S_{ij} Y \leq -\rho (Y + Y^T) - \rho^2 S_{ij}^{-1} \quad (40)$$

Accordingly, (39) can then be delineated as follows:

$$\begin{bmatrix} A_i Q_1^{-1} + Q_1^{-1} A_i^T + B_i F_j Q_1^{-1} + Q_1^{-1} F_j^T B_i^T & B_i \bar{F}_j Y & 0 \\ * & -2\rho Y & \rho I \\ * & * & Q_2 \bar{A}_i + \bar{A}_i^T Q_2 - Q_2 \bar{E}_i \bar{C}_j - \bar{C}_j^T \bar{E}_i^T Q_2 \end{bmatrix} < 0 \quad (41)$$

Using lemma 1, and with some manipulations, we can obtain easily (26)–(28). This completes the proof.

**Remark 1.** *The calculation of the observer and controller gains is done independently in [11, 21], which is restrictive. Therefore, in this study, the resolution of the LMIs is carried out in one step.*

## 5. Vehicle simulation results

In this section, the computer testing displays a critical driving situation. Initially, the system states and actuator faults will be estimated. Next, to demonstrate the effectiveness of the proposed FTC, the states of the faulty system will be simulated considering the fault-tolerant control law.

Simulations are performed with the forward steering angle profile given in **Figure 4**. This shows a sequence of right and left turns. The vehicle data is shown in **Table 3** [22].

Each  $(A_i, C_i)$  is observable. The resolution of the LMIs of the theorem above, using the LMI toolbox [23] and selecting  $\rho = 4$ , results in the following matrices:

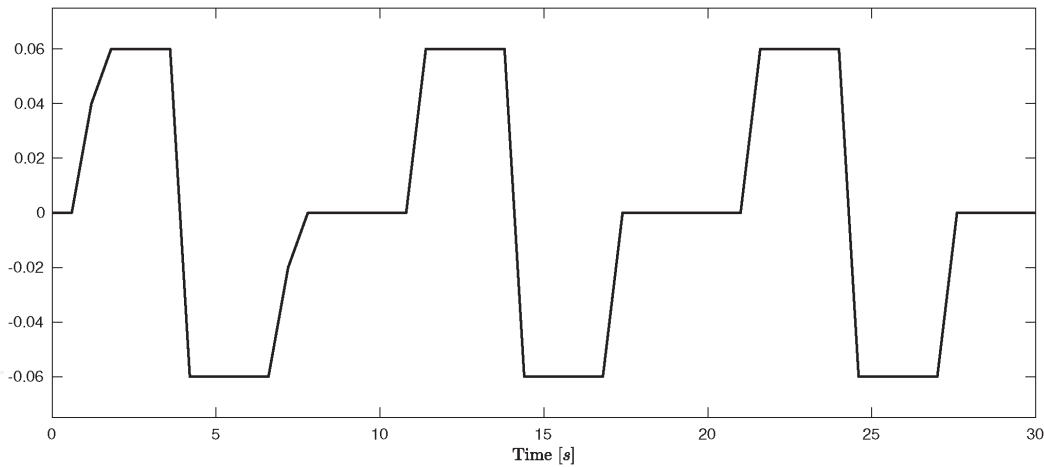

**Figure 4.** Steering wheel angle  $\delta_f(t)$  by [rad].

Parameters	Value	Parameters	Value
$g$	9.806 m/s <sup>2</sup>	$l_f$	1.18 m
$m$	1832 kg	$l_r$	1.77 m
$v_x$	23 m/s	$h_{roll}$	0.90 m
$I_x$	614 kg m <sup>2</sup>	$C_\phi$	6000 Nms/rad
$I_z$	2988 kg m <sup>2</sup>	$K_\phi$	140,000 Nms/rad

**Table 3.** Values of the vehicle parameters used in the simulations.

$$P = 10^3 \begin{bmatrix} 0.3145 & 0.0416 & 0.0057 & 0.0696 \\ 0.0416 & 0.0197 & 0.0026 & -0.0219 \\ 0.0057 & 0.0026 & 0.0844 & -0.3410 \\ 0.0696 & -0.0219 & -0.3410 & 3.5255 \end{bmatrix}, F_1 = \begin{bmatrix} 0.2112 \\ -0.8970 \\ -0.0188 \\ -0.0094 \end{bmatrix}^T$$

$$Q_2 = 10^3 \begin{bmatrix} 0.0844 & -0.1222 & 0.0146 & -0.0014 & 0.0250 \\ -0.1222 & 1.5054 & -0.0286 & -0.0433 & -0.0480 \\ 0.0146 & -0.0286 & 3.2562 & 0.0068 & -0.0039 \\ -0.0014 & -0.0433 & 0.0068 & 0.0464 & 0.0001 \\ 0.0250 & -0.0480 & -0.0039 & 0.0001 & 1.3162 \end{bmatrix},$$

$$F_2 = \begin{bmatrix} 0.2642 \\ -1.1348 \\ -0.0227 \\ -0.0117 \end{bmatrix}^T$$

$$L_1 = \begin{bmatrix} -2.0916 & 14.8942 \\ -4.8065 & -1.8332 \\ -0.1687 & 1.0810 \\ 19.9900 & -6.3497 \end{bmatrix}, L_2 = \begin{bmatrix} 22.4158 & -43.4496 \\ 0.8851 & -1.4886 \\ 0.5984 & 0.3418 \\ 18.2517 & -11.5319 \end{bmatrix}$$

$$G_1 = [40.1735 \quad 39.7987], G_2 = [5.8133 \quad 6.7343]$$

To see the effectiveness of the proposed scheme, we compare the states of the zero-fault T-S model with the states of the faulty system both with and without the FTC strategy.

**Figure 5** illustrates the time evolution of the fault  $f(t)$  and its estimate  $\hat{f}(t)$ , which shows that the fault estimate followed closely the fault, whereas **Figures 6–9** show the response of the automotive lateral dynamics reference system states simultaneously with its states in the presence of faults, in two scenarios: with and without the application of the FTC approach.

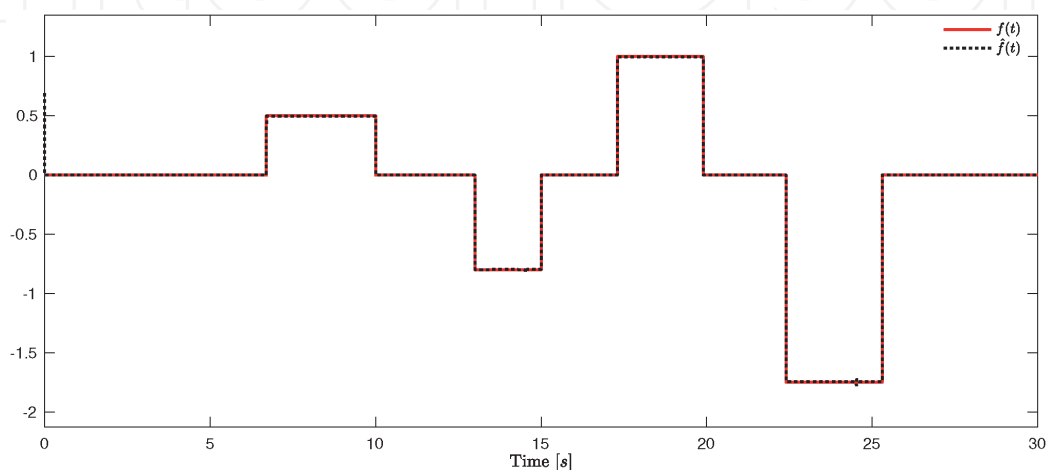

**Figure 5.**  
 Fault  $f(t)$  and its estimate  $\hat{f}(t)$ .

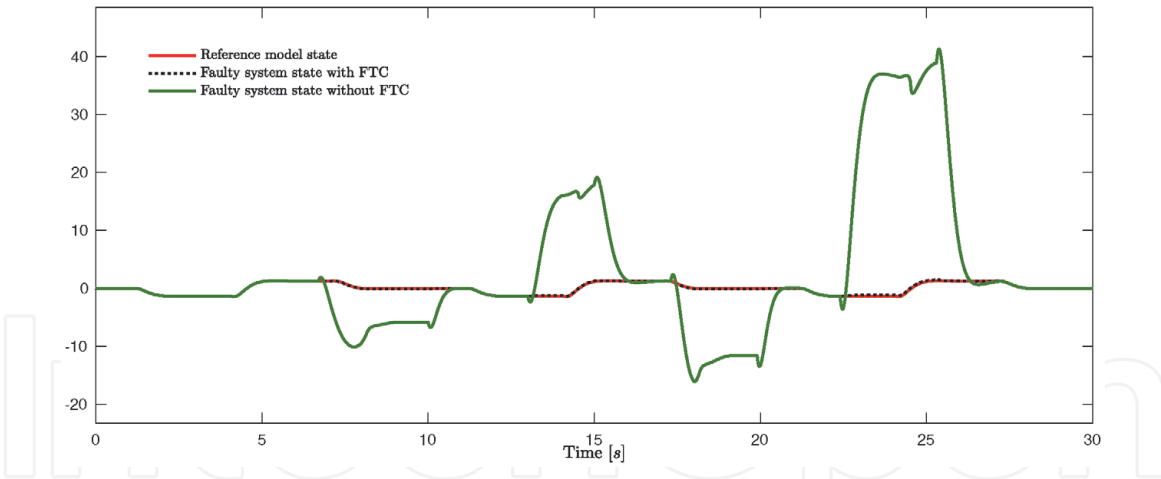

**Figure 6.**  
Comparison of the lateral velocity state  $v_y(t)$  response in the presence of actuator faults with the reference.

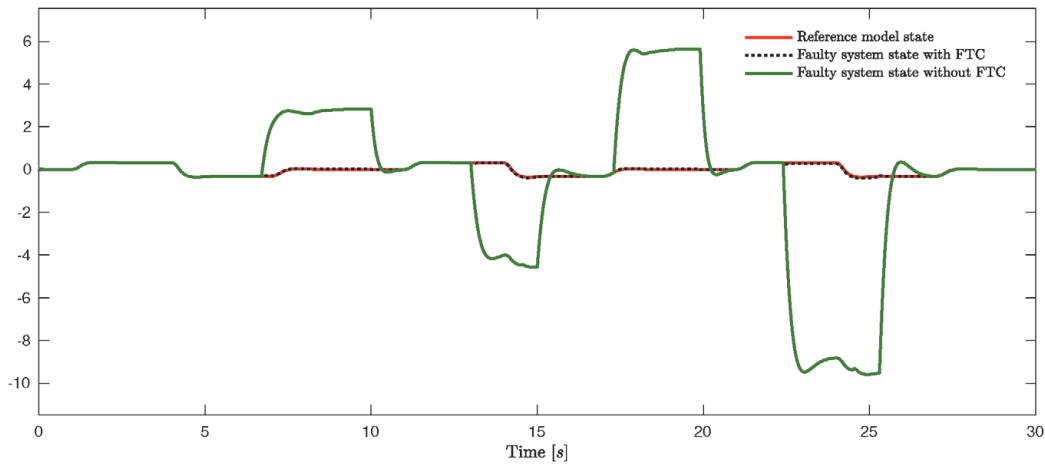

**Figure 7.**  
Comparison of the yaw rate state  $\dot{\psi}(t)$  response in the presence of actuator faults with the reference.

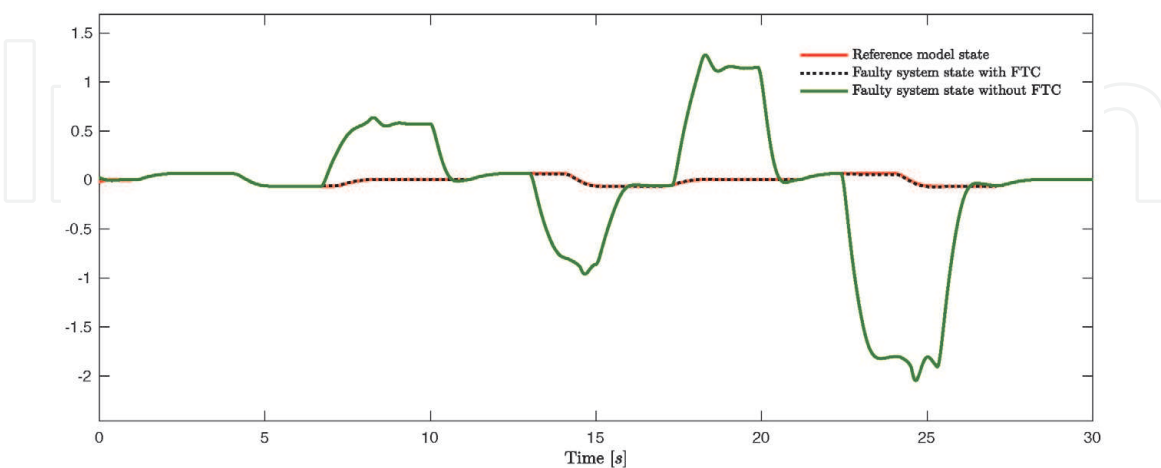

**Figure 8.**  
Comparison of the roll angle state  $\phi(t)$  response in the presence of actuator faults with the reference.

In **Figures 6–9**, simulations of faulty system states in the absence of FTC clearly show that the performances of the vehicle has been lost and that its states reached unsustainable levels immediately after the actuator became faulty, but applying fault-tolerant control law, the vehicle stays stable throughout the simulation



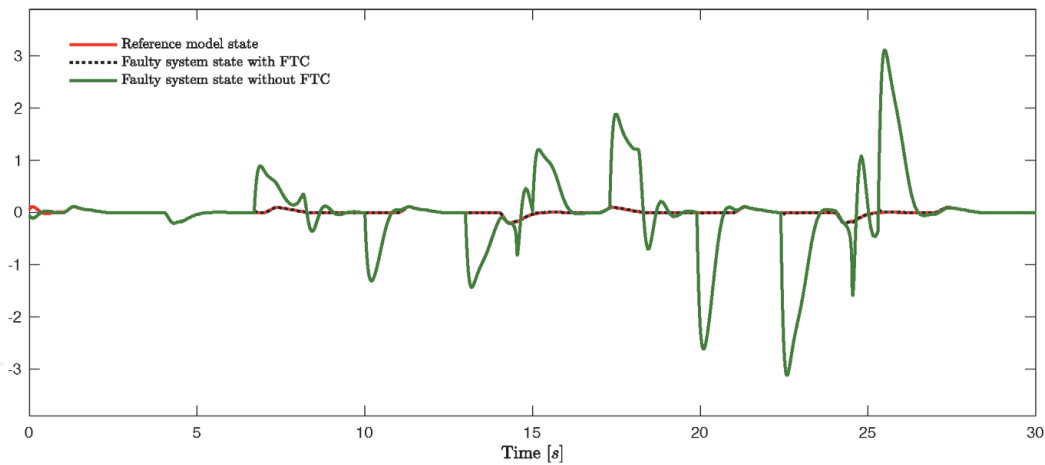

**Figure 9.**  
*Comparison of the roll rate state  $\dot{\phi}(t)$  response in the presence of actuator faults with the reference.*

without losing performances despite the presence of faults, demonstrating the success of the proposed FTC approach.

## 6. Conclusion

In this chapter, a fault-tolerant nonlinear control law scheme is proposed to reform the states of the lateral dynamics system of the automotive vehicle when it becomes faulty at the actuator side. The nonlinear model of the lateral dynamics of the automotive vehicle is first represented by a T-S fuzzy models, and then the fault-tolerant control design based on the T-S fuzzy observers is presented. The mentioned strategy is based on the use of the T-S reference models and the information provided by the T-S fuzzy observers. This control law is developed to reduce the deviation of the faulty system from the reference; it uses the steering angle, the estimation error, and the tracking error. The stability of the whole system is investigated in one step with the Lyapunov theory and by solving the LMIs constraints. The simulations of the automotive vehicle strongly demonstrate that the engineered FTC is very successful and can be adapted to the specific driving situations. These results will be applied to the CarSim software in future work.

### Conflict of interest

The authors declare no conflict of interest.

IntechOpen

IntechOpen

### **Author details**

Naoufal El Youssfi\* and Rachid El Bachtiri  
Industrial Technologies and Services Laboratory, Higher School of Technology,  
CEDoc-Engineering Sciences and Techniques, Faculty of Science and Technology,  
Sidi Mohamed Ben Abdellah University, Fez, Morocco

\*Address all correspondence to: [ely.naoufal@gmail.com](mailto:ely.naoufal@gmail.com)

### **IntechOpen**

---

© 2020 The Author(s). Licensee IntechOpen. This chapter is distributed under the terms of the Creative Commons Attribution License (<http://creativecommons.org/licenses/by/3.0>), which permits unrestricted use, distribution, and reproduction in any medium, provided the original work is properly cited. 

## References

- [1] Delgrossi L, Zhang T. Vehicle safety communications: protocols, security, and privacy. Vol. 103. 2012. Available from: <https://trid.trb.org/view/1246249> [Accessed: 14 January 2020]
- [2] Mastinu G, Plchl M, editors. Road and off-Road Vehicle System Dynamics Handbook. CRC Press; 2014. Available from: <https://www.taylorfrancis.com/books/9780429129810> [Accessed: 22 January 2020]
- [3] Du H, Zhang N, Naghdy F. Velocity-dependent robust control for improving vehicle lateral dynamics. *Transportation Research Part C: Emerging Technologies*. 2011;19(3):454-468. Available from: <https://www.sciencedirect.com/science/article/pii/S0968090X10000884> [Accessed: 22 January 2020]
- [4] Ye X, Hu J, Qi J, Fang Y, Tian P, Shao Q. An integrated multidisciplinary optimization search strategy for automotive passive safety optimization. In: *Proceedings of the 2nd International Conference on Intelligent Systems, Metaheuristics & Swarm Intelligence*. 2018. pp. 89-97. DOI: 10.1145/3206185.3206209 [Accessed: 22 January 2020]
- [5] Anderson ZM, Giovanardi M, Tucker C, Ekchian JA. U.S. Patent No. 10,377,371. Washington, DC: U.S. Patent and Trademark Office. 2019. Available from: <https://patents.google.com/patent/US10377371B2/en> [Accessed: 25 January 2020]
- [6] Genta G, Morello L. *The Automotive Chassis: Volume 2: System Design*. Springer Nature; 2019. DOI: 10.1007/978-3-030-35709-2 [Accessed: 25 January 2020]
- [7] Yang H, Xia Y, Geng Q. Fault-tolerant control with effectiveness loss. In: *Analysis and Synthesis of Delta Operator Systems with Actuator Saturation*. Singapore: Springer; 2019. pp. 331-349. Available from: [https://link.springer.com/chapter/10.1007/978-981-13-3660-7\\_18](https://link.springer.com/chapter/10.1007/978-981-13-3660-7_18) [Accessed: 22 January 2020]
- [8] Marx B, Koenig D, Georges D. Robust fault-tolerant control for descriptor systems. *IEEE Transactions on Automatic Control*. 2004;49(10):1869-1876. Available from: <https://ieeexplore.ieee.org/abstract/document/1341595> [Accessed: 22 January 2020]
- [9] Zhang Y, Jiang J. Bibliographical review on reconfigurable fault-tolerant control systems. *IFAC Proceedings Volumes*. 2003;36(5):257-268. Available from: <https://www.sciencedirect.com/science/article/pii/S1474667017365035> [Accessed: 31 January 2020]
- [10] Shen Q, Jiang B, Cocquempot V. Fault-tolerant control for TS fuzzy systems with application to near-space hypersonic vehicle with actuator faults. *IEEE Transactions on Fuzzy Systems*. 2011;20(4):652-665. Available from: <https://ieeexplore.ieee.org/abstract/document/6111465> [Accessed: 19 January 2020]
- [11] Kharrat D, Gassara H, El Hajjaji A, Chaabane M. Adaptive observer and fault tolerant control for Takagi-Sugeno descriptor nonlinear systems with sensor and actuator faults. *International Journal of Control, Automation and Systems*. 2018;16(3):972-982. DOI: 10.1007/s12555-017-0546-8 [Accessed: 27 January 2020]
- [12] El Youssfi N, Oudghiri M, Bachtiri RE. Control design and sensors fault tolerant for vehicle dynamics (a selected paper from SSD'17). *International Journal of Digital Signals and Smart Systems*. 2018;2(1):50-67. DOI: 10.1504/IJDSS.2018.090874 [Accessed: 27 January 2020]

- [13] El Youssfi N, Oudghiri M. Fault estimation and tolerant control for vehicle lateral dynamics. In: 2018 7th International Conference on Systems and Control (ICSC). IEEE. 2018. pp. 213-218. Available from: <https://ieeexplore.ieee.org/abstract/document/8587619> [Accessed: 30 January 2020]
- [14] Barton DC, Fieldhouse JD. Vehicle mechanics. In: Automotive Chassis Engineering. Cham: Springer; 2018. DOI: 10.1007/978-3-319-72437-9\_1 [Accessed: 27 January 2020]
- [15] El Youssfi N, Oudghiri M, Aitouche A, El Bachtiri R. Fuzzy sliding-mode observer for lateral dynamics of vehicles with consideration of roll motion. In: 2018 26th Mediterranean Conference on Control and Automation (MED); IEEE. 2018. pp. 861-866. Available from: <https://ieeexplore.ieee.org/abstract/document/8442946> [Accessed: 27 January 2020]
- [16] Pacejka HB, Bakker E. The magic formula Tyre model. *Vehicle System Dynamics*. 1992;**21**(S1):1-18. DOI: 10.1080/00423119208969994 [Accessed: 28 January 2020]
- [17] El Youssfi N, El Bachtiri R, Chaibi R, et al. Static output-feedback  $H_\infty$  control for T-S fuzzy vehicle lateral dynamics. *SN Applied Science*. 2020;**2**:101. Available from: <https://link.springer.com/article/10.1007/s42452-019-1897-y> [Accessed: 02 February 2020]
- [18] Geng C, Mostefai L, Denai M, Hori Y. Direct yaw-moment control of an in-wheel-motored electric vehicle based on body slip angle fuzzy observer. *IEEE Transactions on Industrial Electronics*. 2009;**56**(5):1411-1419. Available from: <https://ieeexplore.ieee.org/abstract/document/4776489> [Accessed: 28 January 2020]
- [19] Chang XH. Takagi-Sugeno Fuzzy Systems Non-fragile H-Infinity Filtering. Vol. 282. Berlin: Springer; 2012. Available from: <https://link.springer.com/book/10.1007%2F978-3-642-28632-2> [Accessed: 29 January 2020]
- [20] Ichalal D, Marx B, Ragot J, Maquin D. Observer based actuator fault tolerant control for nonlinear Takagi-Sugeno systems: An LMI approach. In: 18th Mediterranean Conference on Control and Automation, MED'10; IEEE. 2010. pp. 1278-1283. Available from: <https://ieeexplore.ieee.org/abstract/document/5547874> [Accessed: 01 February 2020]
- [21] Han J, Zhang H, Wang Y, Liu X. Robust state/fault estimation and fault tolerant control for TS fuzzy systems with sensor and actuator faults. *Journal of the Franklin Institute*. 2016;**353**(2): 615-641. Available from: <https://www.sciencedirect.com/science/article/pii/S0016003215004494> [Accessed: 29 January 2020]
- [22] El Youssfi N, Oudghiri M, El Bachtiri R. Vehicle lateral dynamics estimation using unknown input observer. *Procedia Computer Science*. 2019;**148**:502-511. Available from: <https://www.sciencedirect.com/science/article/pii/S1877050919300651> [Accessed: 30 January 2020]
- [23] Gahinet P, Nemirovskii A, Laub AJ, Chilali M. The LMI control toolbox. In: Proceedings of 1994 33rd IEEE Conference on Decision and Control, Vol. 3. IEEE. 1994. pp. 2038-2041. Available from: <https://ieeexplore.ieee.org/abstract/document/411440> [Accessed: 30 January 2020]