



HAL
open science

Unique Fresnel demonstrator including ORC and thermocline direct thermal storage: operating experience

S. Rodat, A. Bruch, N. Dupassieux, N. El Mourchid

► **To cite this version:**

S. Rodat, A. Bruch, N. Dupassieux, N. El Mourchid. Unique Fresnel demonstrator including ORC and thermocline direct thermal storage: operating experience. *Energy Procedia*, 2015, 69, pp.1667-1675. 10.1016/j.egypro.2015.03.127 . hal-02640782

HAL Id: hal-02640782

<https://hal.science/hal-02640782v1>

Submitted on 6 Sep 2024

HAL is a multi-disciplinary open access archive for the deposit and dissemination of scientific research documents, whether they are published or not. The documents may come from teaching and research institutions in France or abroad, or from public or private research centers.

L'archive ouverte pluridisciplinaire **HAL**, est destinée au dépôt et à la diffusion de documents scientifiques de niveau recherche, publiés ou non, émanant des établissements d'enseignement et de recherche français ou étrangers, des laboratoires publics ou privés.



Distributed under a Creative Commons Attribution - NonCommercial - NoDerivatives 4.0 International License



International Conference on Concentrating Solar Power and Chemical Energy Systems,
SolarPACES 2014

Unique Fresnel demonstrator including ORC and thermocline direct thermal storage: operating experience

S. Rodat^{a,*}, A. Bruch^b, N. Dupassieux^a, N. El Mouchid^c

^aUniv. Grenoble Alpes, INES, F-73375 Le-Bourget-du-lac, France
CEA,LITEN, Laboratoire Systèmes Solaires Haute Température (LSHT), F-38054 Grenoble France,

^bUniv. Grenoble Alpes, F-38000 Grenoble, France
CEA,LITEN, Laboratoire Stockage Thermique (LST), F-38054 Grenoble, France.

^cALSOLEN, 9 avenue du Marais, 95100 Argenteuil, France.

Abstract

A unique Fresnel prototype is currently running in France. It is composed of a 1000 m² solar field, a thermocline thermal storage and an Organic Rankine Cycle (ORC). This CSP plant is perfectly suited to test the three main parts of a solar power plant (ie. solar field, storage and turbine). More than two years of experience is achieved and the paper aims at presenting some results about this operating period. It shows that this kind of technology is very versatile. Automation experiences along with thermocline behavior are discussed. Electricity production using the storage capacity is also presented. This experimental tool will be upgraded with water chilled production and desalination. The perspective is the optimization of the whole system for MW scale installations.

© 2015 The Authors. Published by Elsevier Ltd. This is an open access article under the CC BY-NC-ND license (<http://creativecommons.org/licenses/by-nc-nd/4.0/>).

Peer review by the scientific conference committee of SolarPACES 2014 under responsibility of PSE AG

Keywords: Fresnel; Operating experience; Thermocline thermal storage; Organic Rankine Cycle; Control;

* Corresponding author. Tel.: (+33)4 79 79 21 20
E-mail address: sylvain.rod@cea.fr

1. Introduction

The best energy mix scenarios show that integration of photovoltaic plants together with concentrated solar plants will become compulsory [1], however, concentrated solar plant developers have to improve their main asset: thermal storage. In order to decrease costs and constraints of two-tank thermal storage, the CEA is working with Alsolen company on dual-media thermocline storage that permits to include both hot and cold fluids in the same tank. On the one hand, it avoids the use of expensive heat exchangers required when the heat transfer fluid is not the same as the storage medium and on the other hand, it avoids expensive storage material. In place of it, dual media thermocline is filled with non-expensive media such as rocks. The purpose of the paper is not to present detailed performances of the thermal storage but rather to show how it can be operated all along the day on a representative Fresnel demonstrator connected to an Organic Rankine Cycle (ORC). Indeed, a lot of research works are dedicated to specific components with most of the time theoretical approaches (i.e. storage [2-3], solar field [4], receiver [5], ORC [6]) but operating experience is also a very useful feedback to define new R&D needs. To date there has not been operation results of a Fresnel power plant coupled to a dual media thermocline thermal storage and an ORC. In this paper, this point is addressed. Section 2 is dedicated to a brief description of the demonstrator. In Section 3, results about experimental runs are commented: specifically, the solar field control, the storage management, the electricity production with an ORC and finally the integration of sea water desalination and chilled water chilled production will be introduced.

2. Experimental demonstrator

A unique experimental tool named Alsolen is currently being operated in France (Fig. 1). It includes a Solar Field (SF) of 1000 m², an ORC and a direct thermocline thermal storage. It is used as a small simulator to test the best control strategies of solar power plants as it includes the three essential components. The whole installation is fully operational and numerous experimental runs are available. The system (Fig. 2, [7]) is composed of two north-south oriented solar fields. The fluid is going from north to south in the first one and returns in the second one in such a way that piping and thermal losses are limited. Each solar field is composed of ten 50 m length rows of mirrors. The heat transfer fluid is synthetic oil which circulates at atmospheric pressure and outlet temperature is limited to 300°C in order to ease operation and maintenance for users in isolated areas. The flow-rate ranges between 2000 kg/h and 7000 kg/h as function of the solar field inlet/outlet temperature difference. The plant is equipped with temperature sensors (high precision calibrated platinum resistance temperature detectors) and Coriolis-type flowmeters. The input and output temperatures of each solar field are monitored. A Kipp&Zonen CHP1 Pyrheliometer for on-site DNI measurement in the spectral range 200 to 4000 nm with a daily uncertainty of 1% is also available on site. The response time (95%) is 5 s [8]. All the variables are stored and available for interpretation. The thermocline storage tank is a 30 m³ cylindrical vessel instrumented with inlet/outlet high precision calibrated platinum resistance temperature detectors and imbedded thermocouples placed on three specific planes (at the bottom, in the middle and at the top of the rock bed) to follow the evolution of the thermal front. This unique demonstrator allows to confirm and to validate some of the results obtained at smaller scale by the authors ([9]) as well as other specific operating scenarios.

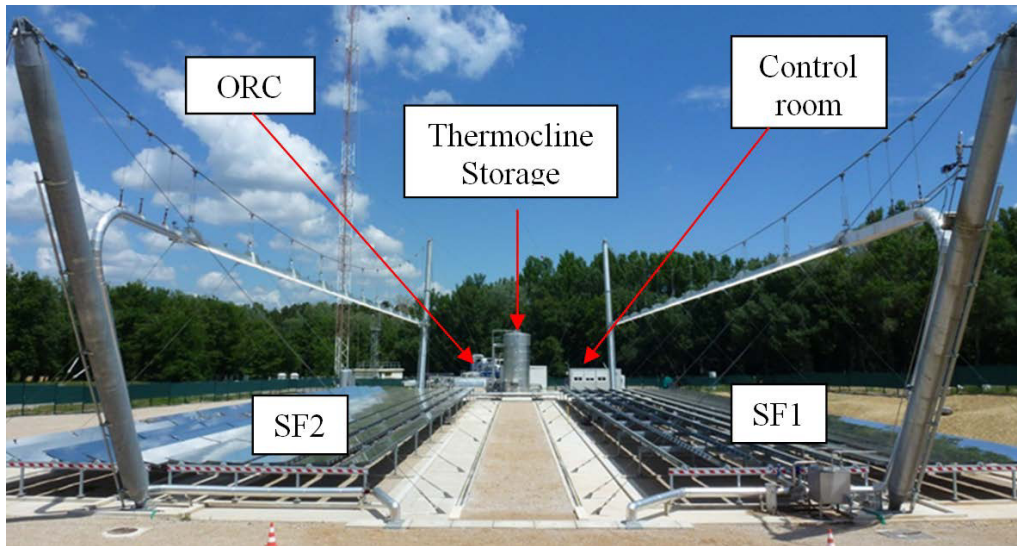

Fig. 1. Experimental Alsolen demonstrator including a solar field, a thermocline thermal storage and an ORC.

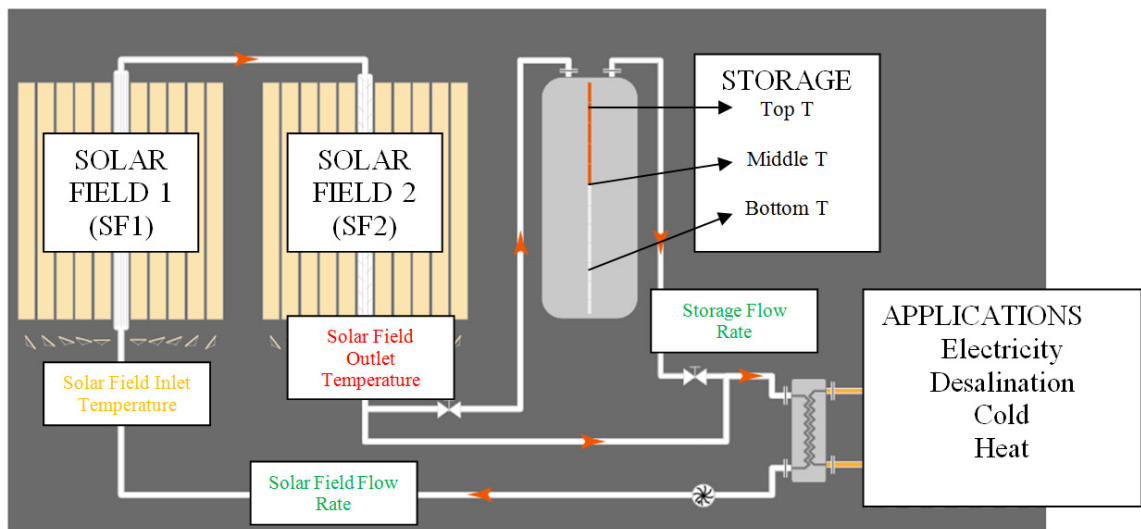

Fig. 2. Simplified flowsheet of the demonstrator installation

3. Operating experience

Experimental results including solar field performances, storage capabilities and electricity production will be disclosed in sections 3.1 to 3.3.

3.1. Solar field

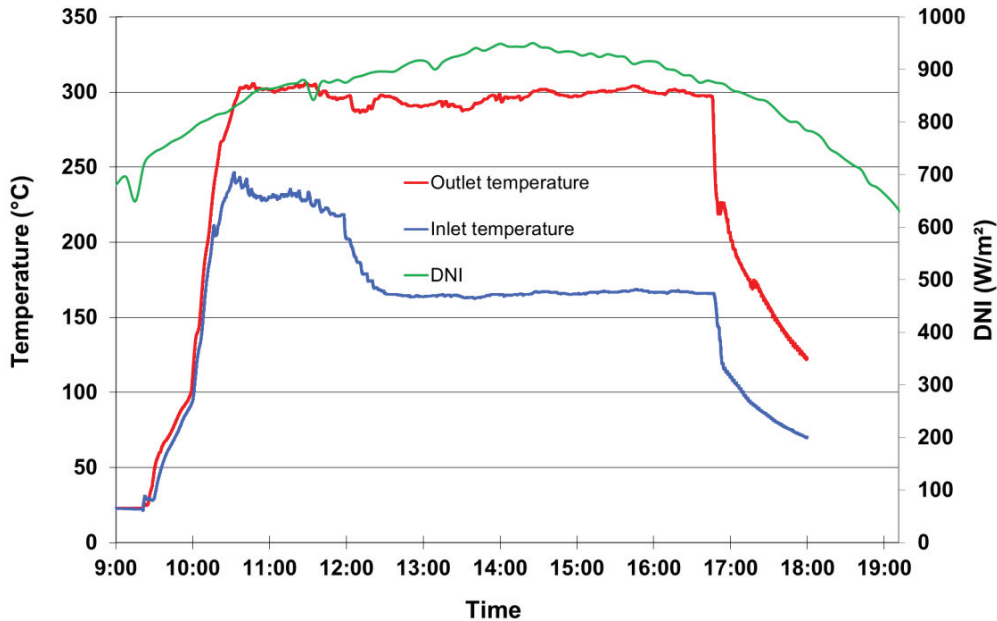

Fig. 3. Inlet and outlet temperatures of the solar field along with DNI for a sunny day

In figure 3, inlet and outlet temperatures of the solar field are plotted along with the DNI (Direct Normal Irradiance). It shows that the nominal temperature of the plant (300°C) is maintained along the day. A test was carried out in order to enhance the variation of temperature in the solar field at midday by decreasing the inlet temperature. It can be noted that the response of the plant is quite smooth and permits to maintain the targeted temperature while adjusting the flowrate. This kind of variation of the inlet temperature can be observed when an additional heat sink is placed after the ORC (for example chilled water production). This option is commented here below.

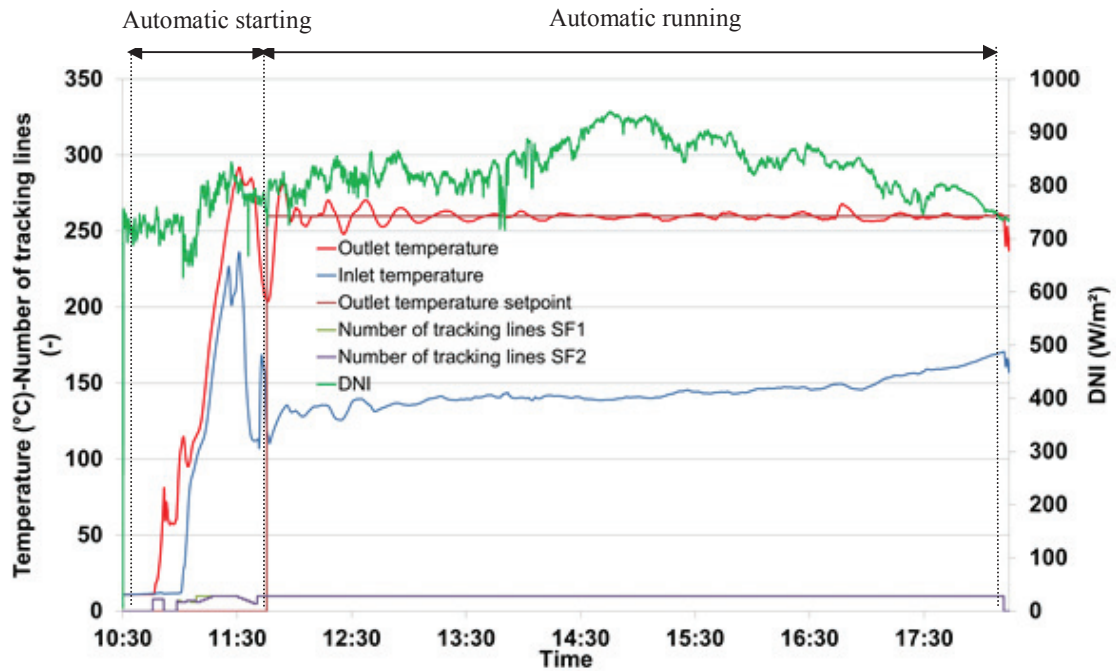

Fig. 4. Inlet and outlet temperatures of the solar field along with DNI, outlet temperature setpoint and number of mirrors focalizing (after 13:35, both Solar Fields are tracking (curved superposed))

In Figure 4, a regulation test is displayed on a hazy day. It shows the DNI along with the inlet and outlet temperatures of the solar field and the number of focalized mirrors on each solar field. The temperature setpoint is also plotted. The figure shows a day in automatic mode (from the starting point around 10:30 to the shutdown of the installation around 18:00). All the starting procedure is controlled by the automaton that chooses the right number of mirrors that can be focalized according to the DNI and flowrate. In order to avoid wall overheating, the number of mirrors is adjusted during the starting procedure while the flow is not turbulent. After the starting phase, the temperature control is started and the flowrate is regulated in order to stick to the set point. Some adjustments were required on the PI controller (see cascade control, figure 5), but after 13:30, the outlet temperature is fairly well regulated ($\pm 5^\circ\text{C}$) even though the DNI is not stable ($850 \text{ W/m}^2 \pm 100$). The cascade control is based on two integrated loops. The first one gives a quick response for the flowrate control while the second one is slower and adjusts the temperature. A predictive control is also used to help the temperature control by providing a rough value of the setpoint. It enables to have a more reactive and precise control for heavy transients. The Fresnel power plant is able to run along the day without any human operation. This strategy is also implemented for the storage control and tests are currently running.

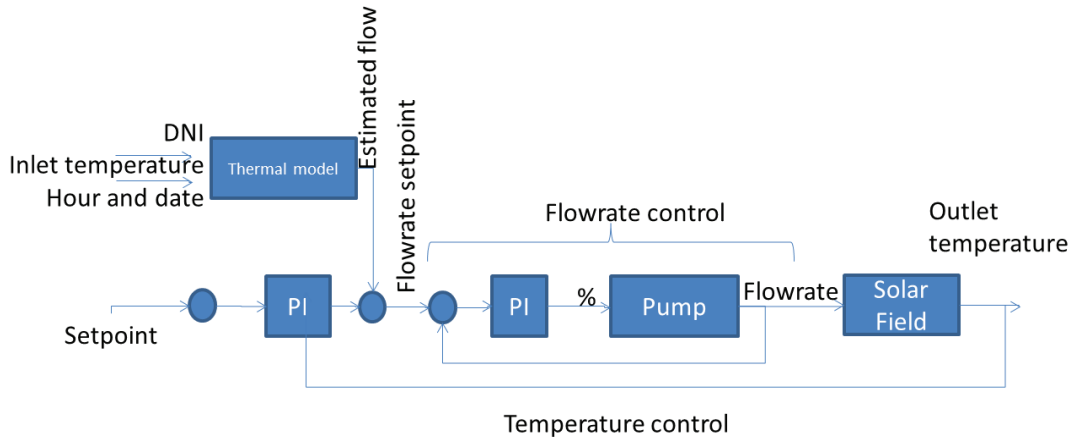

Fig. 5. Regulation principle of the outlet temperature of the solar field

3.2. Storage management

Figure 6 presents the typical response and behavior of the thermocline storage tank while charging, through the time-evolutions of the injection temperature (solar field outlet temperature), the storage mass flow rate and the mean values of three representative temperatures inside the storage tank (at the top, at the middle and at the bottom of the rock bed).

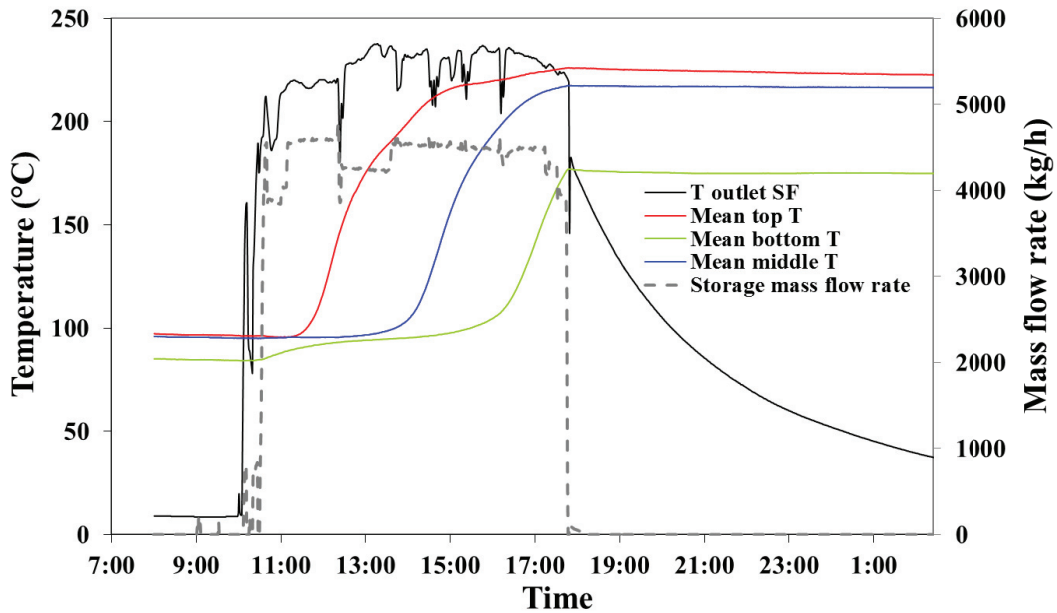

Fig. 6. Behaviour of the storage tank in charge mode.

Figure 6 exhibits typical thermocline profiles characterized by thermal gradient running vertically from the top to the bottom of the storage tank (charge mode). Due to fabrication constraints and in order to keep an “industrial design” of the storage tank, rock bed temperature is measured on only three transversal planes with 10

thermocouples on each to study the temperature transversal homogeneity. Figure 6 show that the embedded temperature instrumentation allows to finely follow the propagation of the thermal front inside the storage tank. Despite the fluctuations of charge temperature due to regulation and DNI variations, the measured temperature profiles are smooth, with no experimental scattering. The transversal temperature homogeneity has been checked on the measurement planes and typical transversal variations less than 10°C are observed during thermal front propagation, confirming the expected packed-bed piston-like behavior.

Figure 7 presents a relevant example of control strategy of the Fresnel power plant which illustrates its versatility and the easiness to couple/uncouple the different components. After an initial warm-up of the power plant, the thermocline storage tank is first used in support of the solar field to run the ORC machine in nominal conditions during periods of low solar irradiation. With increasing available solar irradiation, the thermocline discharge mass flow rate is progressively decreased to zero as ORC machine nominal conditions can be achieved by solar field contribution only. At about 13:00, specific tests are performed on the solar field, thus the thermocline storage and the ORC machine are by-passed. The power plant is finally stopped at about 15:00 and started again at 16:00 to simulate the evening stop (low solar irradiation) and the night operations (discharge-only electricity production). For all these operating conditions, transitions from a power plant configuration to another one occur smoothly with no significant perturbation of the process.

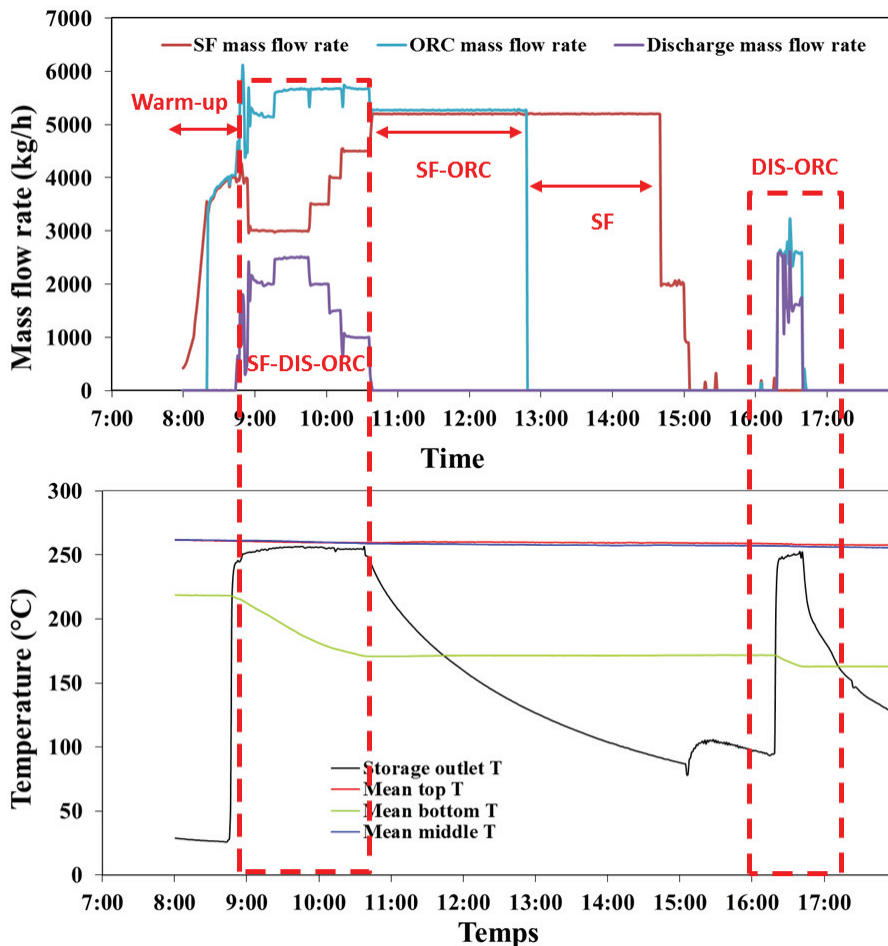

Fig. 7. Representative control strategy of the Fresnel power plant. The abbreviations SF and DIS refer to Solar Field and Discharge, respectively ((7a) top figure, (7b) bottom figure).

In addition, investigation of the temperature profiles inside the storage tank (figure 7b) shows a very good behavior of the thermocline: from an almost full tank, all the tests performed lead to a smooth evolution of the temperature at the bottom of the tank, whereas above and outlet temperatures remain constant. This clearly confirms the ability of thermocline storage to match the requisitions of a solar power plant and the versatility of the present Alsolen Fresnel power plant.

3.3. Electrical production

In Figure 8, electrical production on a cloudy day is displayed. The storage is used to provide thermal power. Both inlet and outlet temperatures of the ORC and DNI are plotted. Normalized thermal and electrical powers are also showed. It is worth noting that the inlet temperature of the ORC is absolutely stable. This highlights the quality of the thermocline since the inlet temperature of the ORC corresponds to the outlet temperature of the storage. At about 16:15, some adjustments were made on the thermodynamic cycle that permit to slightly increase the electrical output. At 16:45, the thermal power is increased and the electrical output reaches nominal value. The experience shows that the storage is a really appreciable tool for the optimization of the ORC since it provides stable output temperature and flowrate which is of primary importance in order to perfect control parameters. From the results concerning the thermal and electrical powers, it can be seen that the increase in thermal power is not proportional to the increase in electrical power (electrical power increases more quickly than the thermal power). This is due to the fact that close to nominal conditions, the phase difference is improved on our small machine. The Alsolen demonstrator is the first experimental installation producing electricity thanks to a dual media thermocline and ORC. This coupling turns out to be really versatile in order to produce electricity in various modes (storage+solar field, solar field only, storage only).

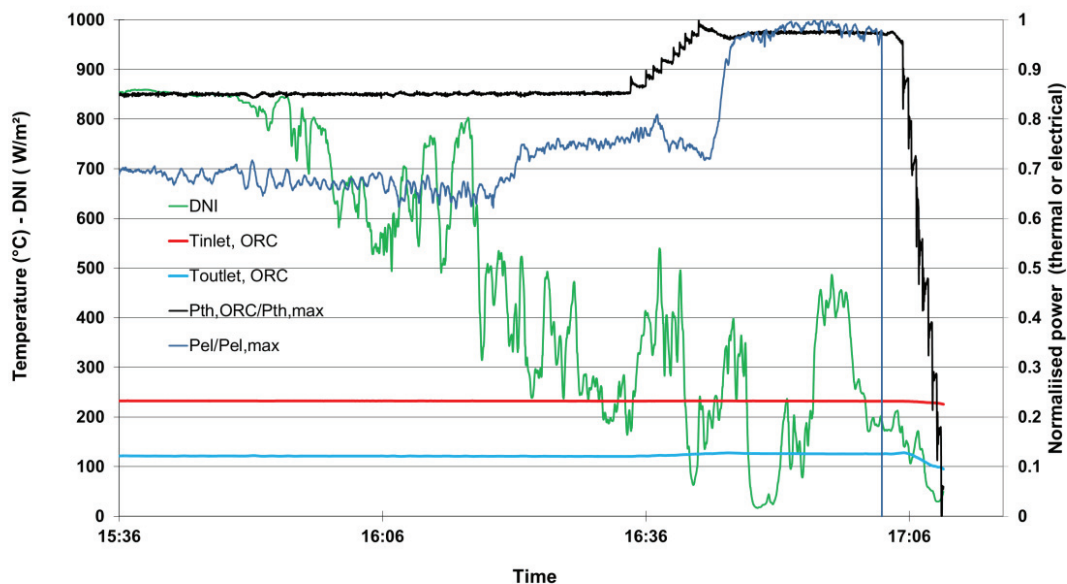

Fig. 8. Electrical production during a test run, electrical and thermal powers are normalized

3.4. Desalination and cooling options

The plant is currently upgraded with desalination and chilled water production including ice production (internally developed system) (Fig 9.). The former is used to recover waste heat from the ORC condenser so that the solar energy is better used and drinkable water is produced only at the capital cost of the distillation system. The latter is placed after the ORC in order to use low temperature heat for the absorption chiller. For example, it can

permit to optimize heat use during thermal damping periods in summer. In fact optimization can be much more complex and can include use of the heat of the thermocline region that should have to be extracted to prevent from quick degradation [3]. The prototype will thus include the three main parts of a current standard solar power plant but also desalination and cooling options that will be part of the next generation of solar power plants. This will enable them to be more efficient, more economic and more in harmony with local needs. Alsolen generator will show that Alsolen technology Fresnel mirrors and direct thermocline storage is able to generate simultaneously 4 applications: electricity, process heat, desalinated water and chilled water in a stable and durable way with optimized energy recovery management.

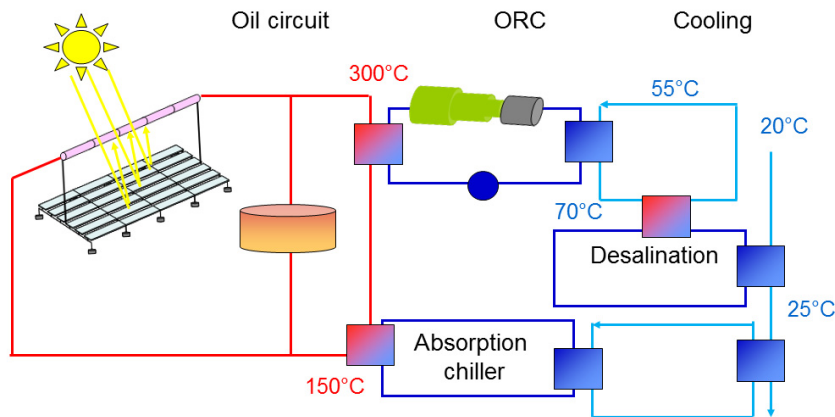

Fig. 9. A possible solar plant layout including, solar field, storage, turbine, desalination and absorption chiller

4. Conclusion and outlook

The presented demonstrator shows that it is a really useful tool to experiment and validate suitable operating strategies. It is an essential step toward industrialization and workforce training. The solar field, the storage and the ORC are operational. In perspective, the addition of desalination and chilled water solar production is scheduled. R&D needs that can be evoked are the strategy optimizations of the coupling of all components (i.e. use of the temperature gradient of the thermocline, use of heat loss at the condenser...). This can be related to meteorological previsions forecast and load demand or energy price curves levels. These strategies are currently being investigated for MW scale installations.

References

- [1] J. Forrester, The value of CSP with thermal energy storage in providing grid Stability, *Energy Procedia*, 49 (2014) 1632-1641.
- [2] K.M. Powell, T.F. Edgar, Modeling and control of a solar thermal power plant with thermal energy storage, *Chemical Engineering Science*, 71 (2012) 138-145.
- [3] M. Biencinto, R. Bayon, E. Rojas, L. Gonzalez, Simulation and assessment of operation strategies for solar thermal power plants with a thermocline storage tank, *Solar Energy*, 103 (2014) 456-472.
- [4] G. Hautmann, M. Selig, M. Mertins, First European linear Fresnel power plant in operation - operational experience & outlook, *Solarpaces 2009*, Berlin (Germany).
- [5] J. Facao, A.C. Oliveira, Numerical simulation of a trapezoidal cavity receiver for a linear Fresnel solar collector concentrator, *Renewable Energy*, 36 (2011) 90-96.
- [6] Y.L. He, D.H. Mei, W.Q. Tao, W.W. Yang, H.L. Liu, Simulation of the parabolic trough solar energy generation system with Organic Rankine Cycle, *Applied Energy*, 97 (2012) 630-641.
- [7] S. Rodat, J.V.D. Souza, S. Thebault, V.Vuillerme, N. Dupassieux, Dynamic simulations of Fresnel solar power plants, *Energy Procedia*, 49 (2014) 1501-1510.
- [8] Data available at www.kippzonen.com, CHP1 pyrhelimeter, Instruction Manual 0811
- [9] A. Bruch, J.F. Fourmigué, R. Couturier, Experimental and numerical investigation of a pilot-scale thermal oil packed bed thermal storage system for CSP power plant, *Solar Energy*, 105 (2014) 116-125.