

Expert system: a decision support tool for fire safety analysis in nuclear area

Presenting author

W. Plumecocq (IRSN)

Other contributors

E. Chojnacki (IRSN)

L. Audouin (IRSN)

International Workshop on Developments in Safety Assessment
Approaches and Safety Management Practices of Fuel Cycle Facilities

OECD Conference Centre, Paris, 7-9 October 2019

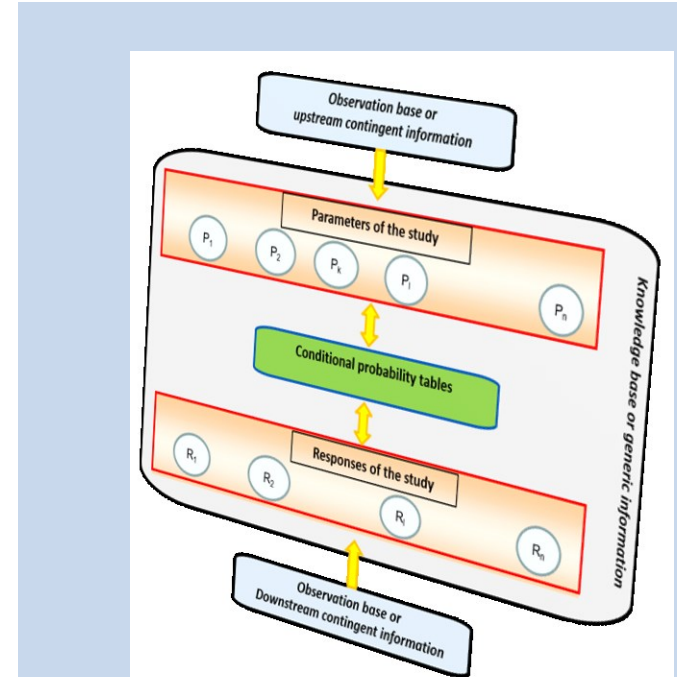

Why developing expert systems?

- The two-zone model SYLVIA is used for fire safety studies in nuclear facilities
- To take into account the different sources of uncertainty coming from initial and boundary conditions and from model parameters, SYLVIA is associated with SUNSET, one of the IRSN statistical tool used in support of risk analysis studies
- Such a use of SYLVIA requires a **large number of runs** and a **significant statistical analysis**, not always compatible with the requirements of safety assessments in terms of deadlines
- To overcome this difficulty, IRSN is currently developing expert systems based on SYLVIA databases. This approach allows deriving the most likely diagnosis or prognosis in a very short time, but also **deriving a more complex form of reasoning** combining prognostic and diagnostic inferences

The expert system

- Computer program that has the ability to answer questions in a very short time, by **reasoning** from **observations** and **generic knowledge**

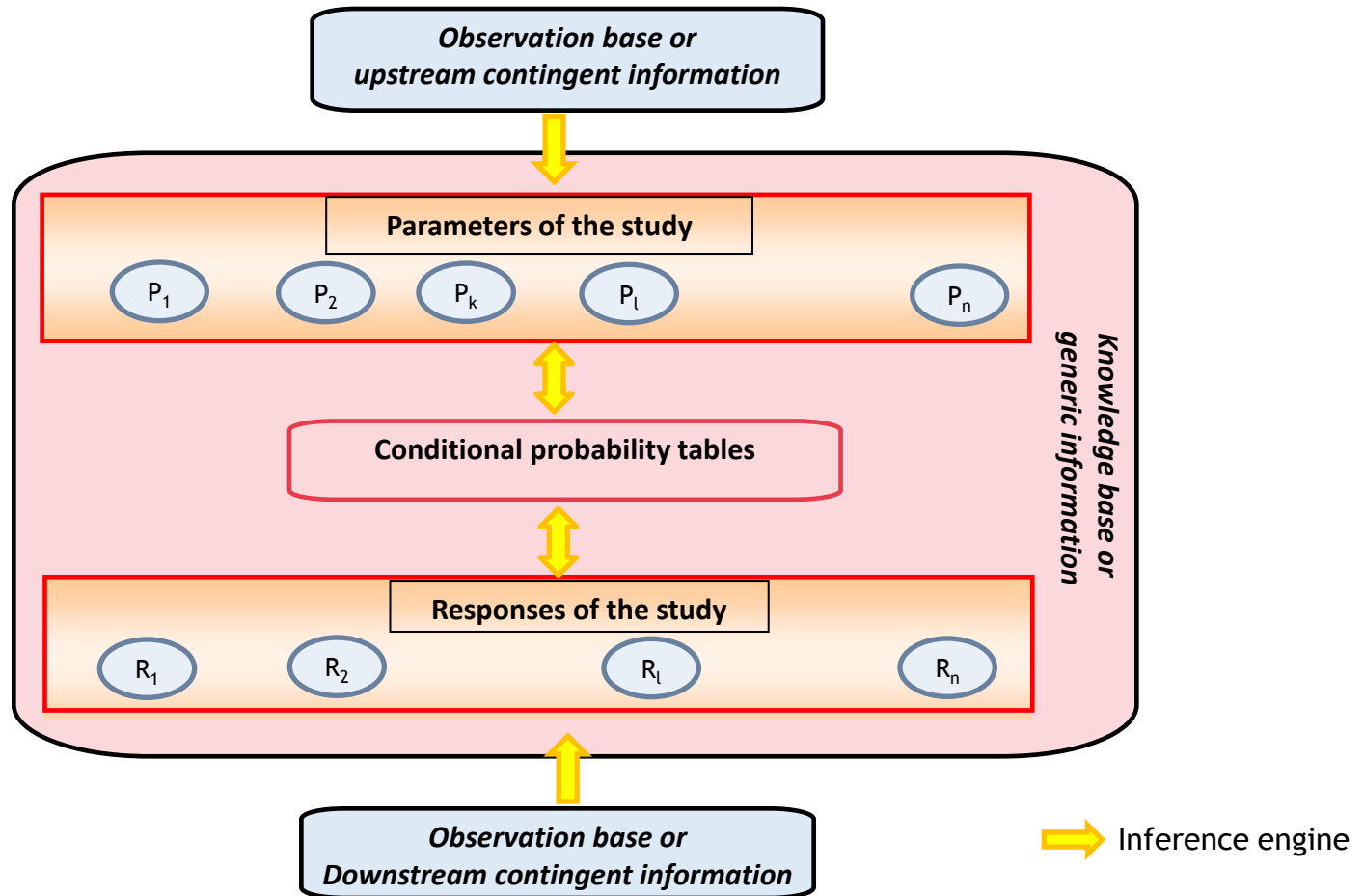

Expert system based on Bayesian Belief Network methodology

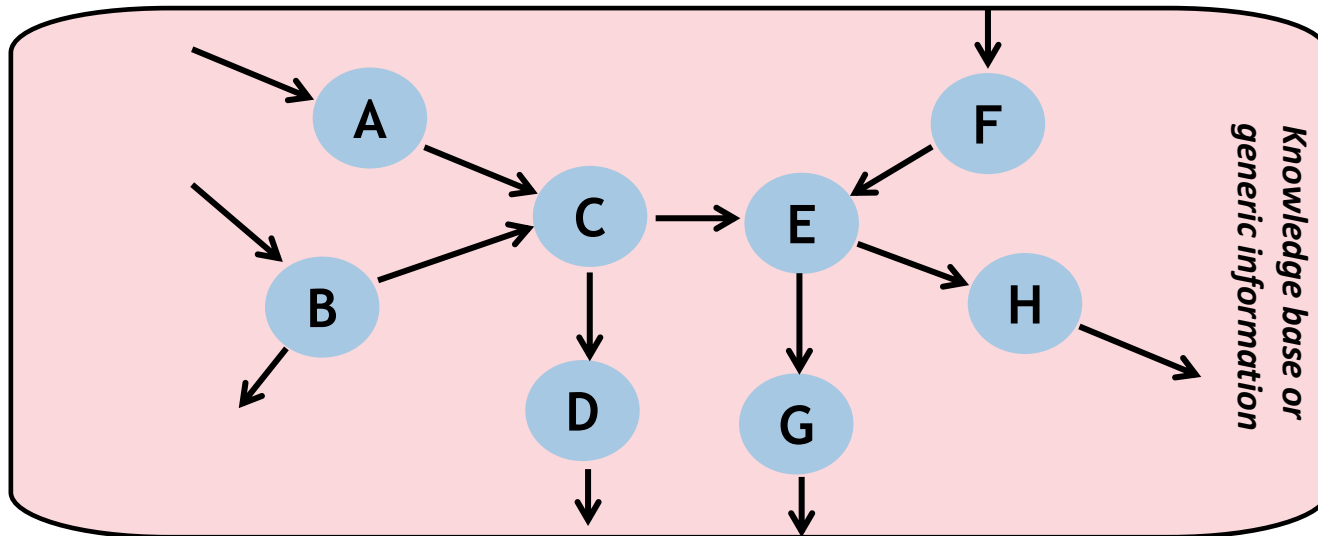

- An arrow models a causal relationship
- A single processor (processing unit) is associated with each arrow for the local transfer of the information
- The graph allows connecting all single processors

Conditional probability tables

- The link between responses and parameters is encoded by means of Conditional Probability Tables (CPT)
- Two simplifications are made to limit the size of CPTs:
 - Discretization of the parameters and the responses of the study
 - Only the dependency links between a response and its influential parameters are taken into account due to the combinatorial explosion of the configurations

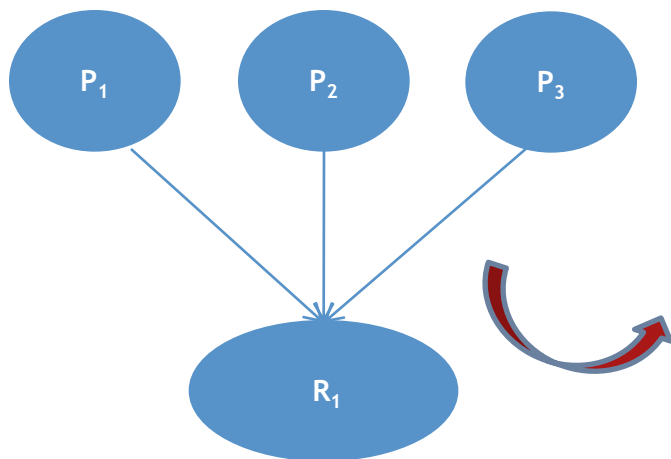

R1	Class 1	Class 2	Class 3	Class 4
$P_11P_21P_31$	0,96	0,04	0,00	0,00
$P_11P_21P_32$	1,00	0,00	0,00	0,00
$P_11P_21P_33$	1,00	0,00	0,00	0,00
$P_11P_22P_31$	0,56	0,31	0,10	0,03
...
$P_13P_25P_33$	1,00	0,00	0,00	0,00

The two-zone model SYLVIA

- Software developed at IRSN for the study of ventilation, fire and airborne contamination transfers inside nuclear facilities
- Advantages of the SYLVIA software
 - Complete modeling of an industrial ventilation network
 - Coupling of the fire with the ventilation
 - Low CPU time consumption
 - Computer architecture suitable for big data

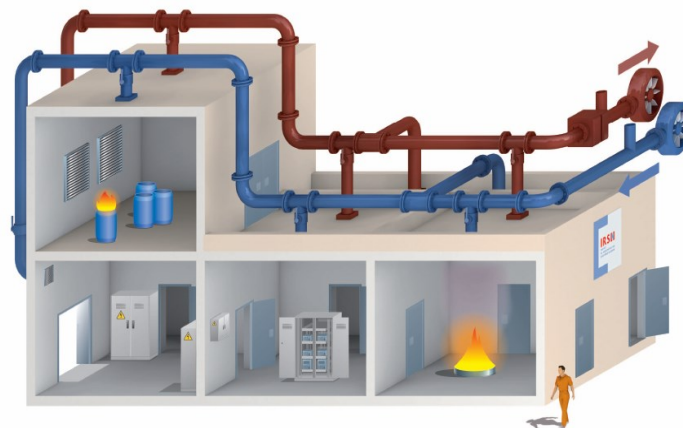

DIVA facility of IRSN

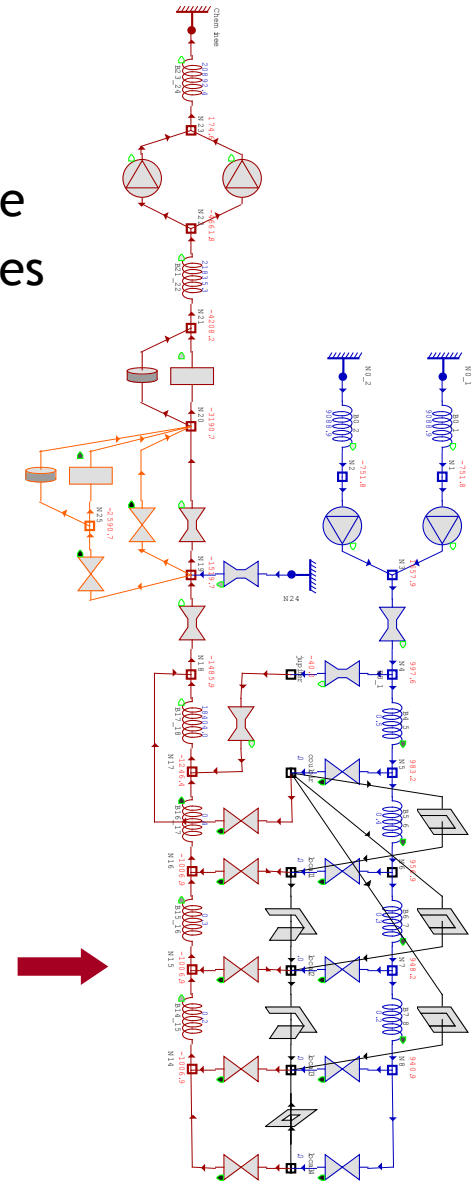

SYLVIA database

- SYLVIA database obtained from a Monte-Carlo simulation
- For each parameter of the study, a value is randomly drawn in its range of variation, creating a set of values of the parameters characterizing the SYLVIA calculation to be performed. By performing this simulation, we obtain the values of the responses associated with this parametric configuration
- The Monte Carlo method consists in reiterating this procedure a large number of times

Pressure effects on fire barriers

Possible consequences of pressure effects generated by a fire on fire barriers:

- A mechanical effect with the severe damage or even the breakdown of the fire barrier elements
- An aeraulic effect with the smoke transfer and other pollutants
 - Malfunction of equipments
 - Intervention delay
 - Transfer of radioactive particles



Test of mechanical behavior of a fire break door under a pressure stress in the STARMANIA facility

Perimeter of the knowledge base

- The perimeter of the knowledge base determines the scope of the expert system

General framework of the study

- Two fire sectors represented by two compartments connected by a fire break door

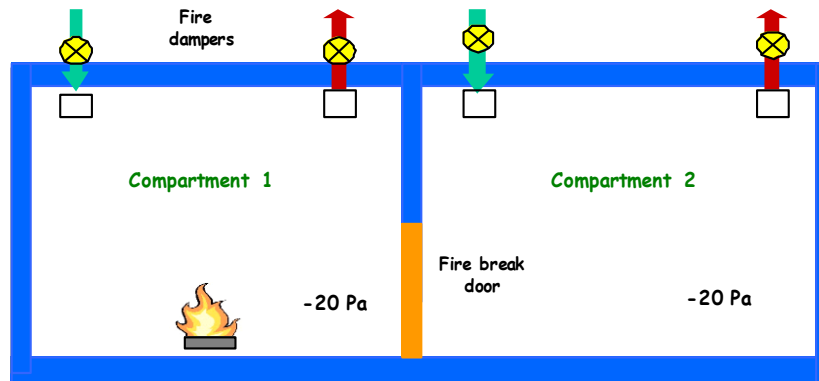

- Fire source modeled by a design fire (αt^2 law)
- Independent management of the ventilation of the two fire sectors

Responses of the study

- 7 responses

Reponses	Discretization
Maximum pressure difference at fire break door (hPa)	< 20 [20 ; 40] [40 ; 60] > 60
Maximum pressure in each compartment (hPa)	< 20 [20 ; 40] [40 ; 60] > 60
Maximum gas temperature in the hot gas layer of each compartment (°C)	< 65 [65 ; 100] [100 ; 140] [140 ; 180] [180 ; 210] [210 ; 300] [300 ; 350] [350 ; 400] [400 ; 500] > 500
Maximum soot concentration in the hot gas layer of each compartment (g.m ⁻³)	< 1 [1 ; 2] [2 ; 3] [3 ; 5] [5 ; 10] > 10

Parameters of the study

- 16 parameters

Parameters	Type	Discretization
Volume of compartments (m ³)	C/D	[100 ; 300] [300 ; 500] [500 ; 700] [700 ; 1000] [1000 ; 3000] [3000 ; 7000] {inf}
Closing time of fire dampers (s)	D	{0 ; 150 ; 1200 ; inf}
Free volume of compartments (%)	C	[80 ; 90] [90 ; 100]
Leakage rate of compartments (vol.h ⁻¹)	C/D	{0} [0.1 ; 0.4] [0.4 ; 0.7] [0.7 ; 1]
Air renewal rate of compartments (h ⁻¹)	C	[1 ; 5] [5 ; 10] [10 ; 20] [20 ; 40]
Resistivity of the ventilation network (hPa)	C	[1 ; 4] [4 ; 7] [7 ; 10]
Fire growth factor (kW.s ⁻²)	D	{2 10 ⁻⁴ ; 3 10 ⁻³ ; 0.012 ; 0.047 ; 0.19}
Maximum HRR in open atmosphere (kW)	C	[200 ; 800] [800 ; 1500] [1500 ; 3000] [3000 ; 5000]
Oxygen limiting law and fire extinction (-)	D	{no limit ; 0 %} {no limit ; 8 %} {no limit ; 12 %} {Peatross ; 12 %}
Production rate of soot (%)	C	[0 ; 2] [2 ; 5] [5 ; 10] [10 ; 15] [15 ; 20]
Resistance of the fire break door (m ⁻⁴)	C	[1000 ; 3000] [3000 ; 6000] [6000 ; 9000]

Influential parameters

- Identification for each response of its most influential parameters done with a covariance analysis on a sampling of 10,000 runs

	P _{max} C1	P _{max} C2	ΔP _{max} FBD	T _{max} C1	T _{max} C2	C _{s,max} C1	C _{s,max} C2
Vol C1	-3%	0%	-4%	-52%	-14%	-13%	4%
Vol C2	-3%	-8%	2%	0%	-20%	0%	-12%
Air renewal C1	4%	2%	4%	3%	1%	-6%	-2%
Air renewal C2	0%	-1%	1%	0%	-3%	0%	-3%
Res fire door	7%	0%	10%	0%	-3%	0%	-1%
tc dampers C1	-18%	-9%	-17%	11%	-10%	-29%	-7%
tc dampers C2	-5%	-10%	3%	0%	-1%	0%	-5%
Fire kinetics	17%	4%	21%	12%	5%	-1%	-1%
HRR max	20%	9%	21%	55%	28%	5%	11%
Res vent network	2%	1%	1%	0%	2%	0%	1%
Free volume C1	2%	1%	2%	3%	3%	-1%	1%
Free volume C2	0%	0%	0%	0%	-1%	0%	-1%
Leakage C1	-34%	-19%	-32%	0%	-25%	1%	-18%
Leakage C2	-7%	-18%	4%	0%	9%	0%	7%
O ₂ limitation	-4%	-3%	-3%	-25%	-13%	-22%	-15%
Soot production	-2%	-1%	-2%	-4%	-1%	78%	22%

Minimum size of the database

- The number of simulations must be sufficient to contain simulations for each configuration of the influential parameters associated with the responses
- The CPT associated with the response " ΔP FBD" includes 92,160 configurations. A SYLVIA database of **1.6 million calculations** ensures that each parametric configuration is observed in the database (9 days of CPU time on 60 processors)

	$P_{\max C_1}$	$P_{\max C_2}$	$\Delta P_{\max FBD}$	$T_{\max C_1}$	$T_{\max C_2}$	$Y_{\max C_1}$	$Y_{\max C_2}$
Max size of CPTs (number of lines)	15,360	35,840	92,160	9,600	43,010	7,680	35,840

Example of an inference combining prognostic and diagnostic modes



What are the configurations that could lead to a pressure difference at fire break door beyond 60 hPa in the specific case of a fire of medium kinetics fire growth in a compartment with leaks?

Results of the expert system

SE SYLVIA

Inputs Outputs Plots

Parameters

Volume of the fire compartment (m ³)			Volume of the target compartment (m ³)			Renewal rate of the fire compartment (vol h ⁻¹)			Resistance of the fire break door (m ⁻⁴)			Fire dampers closing time in the fire compartment			Fire dampers closing time in the target compartment		
100-300	<input checked="" type="checkbox"/>	0%	100-300	<input checked="" type="checkbox"/>	14%	1-5	<input checked="" type="checkbox"/>	0%	1000-3000	<input checked="" type="checkbox"/>	5%	0s	<input checked="" type="checkbox"/>	0%	0s	<input checked="" type="checkbox"/>	25%
300-500	<input checked="" type="checkbox"/>	0%	300-500	<input checked="" type="checkbox"/>	14%	5-10	<input checked="" type="checkbox"/>	0%	3000-6000	<input checked="" type="checkbox"/>	28%	2min30s	<input checked="" type="checkbox"/>	0%	2min30s	<input checked="" type="checkbox"/>	25%
500-700	<input checked="" type="checkbox"/>	43%	500-700	<input checked="" type="checkbox"/>	14%	10-20	<input checked="" type="checkbox"/>	0%	6000-9000	<input checked="" type="checkbox"/>	67%	20min	<input checked="" type="checkbox"/>	100%	20min	<input checked="" type="checkbox"/>	25%
700-1000	<input checked="" type="checkbox"/>	39%	700-1000	<input checked="" type="checkbox"/>	14%	20-40	<input checked="" type="checkbox"/>	100%				∞	<input checked="" type="checkbox"/>	0%	∞	<input checked="" type="checkbox"/>	25%
1000-3000	<input checked="" type="checkbox"/>	19%	1000-3000	<input checked="" type="checkbox"/>	14%												
3000-7000	<input checked="" type="checkbox"/>	0%	3000-7000	<input checked="" type="checkbox"/>	14%												
			∞	<input checked="" type="checkbox"/>	14%												

Fire growth factor			Maximum HRR in open atmosphere (kW)			Leak rate of the fire compartment (vol h ⁻¹)			Leak rate of the target compartment (vol h ⁻¹)			Oxygen limiting law and fire extinction criteria			Soot production rate (%)		
very slow	<input type="checkbox"/>	0%	200-800	<input checked="" type="checkbox"/>	0%	0	<input type="checkbox"/>	0%	0	<input checked="" type="checkbox"/>	29%	1	<input checked="" type="checkbox"/>		0-2	<input checked="" type="checkbox"/>	
slow	<input type="checkbox"/>	0%	800-1500	<input checked="" type="checkbox"/>	0%	0.1-0.4	<input checked="" type="checkbox"/>	100%	0.1-0.4	<input checked="" type="checkbox"/>	18%	2	<input checked="" type="checkbox"/>		2-5	<input checked="" type="checkbox"/>	
middle	<input checked="" type="checkbox"/>	100%	1500-3000	<input checked="" type="checkbox"/>	14%	0.4-0.7	<input checked="" type="checkbox"/>	0%	0.4-0.7	<input checked="" type="checkbox"/>	24%	3	<input checked="" type="checkbox"/>		5-10	<input checked="" type="checkbox"/>	
fast	<input type="checkbox"/>	0%	3000-5000	<input checked="" type="checkbox"/>	80%	0.7-1	<input checked="" type="checkbox"/>	0%	0.7-1	<input checked="" type="checkbox"/>	30%	4	<input checked="" type="checkbox"/>		10-15	<input checked="" type="checkbox"/>	
very fast	<input type="checkbox"/>	0%													15-20	<input checked="" type="checkbox"/>	

Pressure
 Temperature and Soot
 Pressure, Temperature and Soot



Responses

Maximum pressure in the fire compartment (hPa)			Maximum pressure in the target compartment (hPa)			Maximum pressure difference at the fire break door (hPa)			Maximum gas temperature in the fire compartment (°C)			Maximum gas temperature in the target compartment (°C)			Maximum soot concentration in the fire compartment (g m ⁻³)			Maximum soot concentration in the target compartment (g m ⁻³)		
20	<input checked="" type="checkbox"/>	42%	20	<input checked="" type="checkbox"/>	88%	20	<input type="checkbox"/>	0%	65	<input checked="" type="checkbox"/>		65	<input checked="" type="checkbox"/>		1	<input checked="" type="checkbox"/>		1	<input checked="" type="checkbox"/>	
20-40	<input checked="" type="checkbox"/>	36%	20-40	<input checked="" type="checkbox"/>	3%	20-40	<input type="checkbox"/>	0%	65-100	<input checked="" type="checkbox"/>		65-100	<input checked="" type="checkbox"/>		1-2	<input checked="" type="checkbox"/>		1-2	<input checked="" type="checkbox"/>	
40-60	<input checked="" type="checkbox"/>	15%	40-60	<input checked="" type="checkbox"/>	1%	40-60	<input type="checkbox"/>	0%	100-140	<input checked="" type="checkbox"/>		100-140	<input checked="" type="checkbox"/>		2-3	<input checked="" type="checkbox"/>		2-3	<input checked="" type="checkbox"/>	
>60	<input checked="" type="checkbox"/>	8%	>60	<input checked="" type="checkbox"/>	0%	>60	<input checked="" type="checkbox"/>	100%	140-180	<input checked="" type="checkbox"/>		140-180	<input checked="" type="checkbox"/>		3-5	<input checked="" type="checkbox"/>		3-5	<input checked="" type="checkbox"/>	
									180-210	<input checked="" type="checkbox"/>		180-210	<input checked="" type="checkbox"/>		5-10	<input checked="" type="checkbox"/>		5-10	<input checked="" type="checkbox"/>	
									210-300	<input checked="" type="checkbox"/>		210-300	<input checked="" type="checkbox"/>		>10	<input checked="" type="checkbox"/>		>10	<input checked="" type="checkbox"/>	
									300-350	<input checked="" type="checkbox"/>		300-350	<input checked="" type="checkbox"/>							
									350-400	<input checked="" type="checkbox"/>		350-400	<input checked="" type="checkbox"/>							
									400-500	<input checked="" type="checkbox"/>		400-500	<input checked="" type="checkbox"/>							
									>500	<input checked="" type="checkbox"/>		>500	<input checked="" type="checkbox"/>							

Conclusion

- This new software can be considered as a complementary tool of the SYLVIA software, allowing an expert to quickly target the configurations at risk in a specific safety assessment
- Expert systems are specially designed to be used as a **decision support tool** for expertise in nuclear safety area
- Expert systems represent a new generation of calculation tools in the field of probabilistic fire simulation. They contribute to building the “enhanced expertise” of tomorrow

“The enhanced expertise”

