



HAL
open science

Long term durability test of open-cathode fuel cell system under actual operating conditions

Loïc Vichard, Raffaele Petrone, Fabien Harel, Alexandre Ravey, Pascal Venet,
Daniel Hissel

► To cite this version:

Loïc Vichard, Raffaele Petrone, Fabien Harel, Alexandre Ravey, Pascal Venet, et al.. Long term durability test of open-cathode fuel cell system under actual operating conditions. *Energy Conversion and Management*, 2020, 212, 10.1016/j.enconman.2020.112813 . hal-02617445

HAL Id: hal-02617445

<https://hal.science/hal-02617445v1>

Submitted on 22 Aug 2022

HAL is a multi-disciplinary open access archive for the deposit and dissemination of scientific research documents, whether they are published or not. The documents may come from teaching and research institutions in France or abroad, or from public or private research centers.

L'archive ouverte pluridisciplinaire **HAL**, est destinée au dépôt et à la diffusion de documents scientifiques de niveau recherche, publiés ou non, émanant des établissements d'enseignement et de recherche français ou étrangers, des laboratoires publics ou privés.



Distributed under a Creative Commons Attribution - NonCommercial 4.0 International License

Long term durability test of open-cathode fuel cell system under actual operating conditions

L. Vichard^{a,b}, R. Petrone^{a,b}, F. Harel^{b,d}, A. Ravey^{a,b}, P. Venet^{b,c}, D. Hissel^{a,b}

^aFEMTO-ST Institute, Univ. Bourgogne Franche-Comté, UTBM, CNRS, Belfort, France

^bFCLAB, CNRS, Belfort, France

^cUniv Lyon, Université Claude Bernard Lyon 1, Ecole Centrale de Lyon, INSA Lyon, CNRS, Ampère, Villeurbanne, France

^dAME-Eco7, Univ Gustave Eiffel, IFSTAR, Univ Lyon, Lyon, France

Abstract

Proton exchange membrane fuel cells are promising energy conversion solutions for both stationary and transportation applications. However, for the latter application, durability still needs to be improved in order to compete with internal combustion engine. Therefore, many researches have been carried out to improve their design, materials, reliability and energy management. A good understanding of the degradation mechanisms is one of the keys to a better durability. However, these degradation mechanisms are not yet fully understood. The purpose of this paper is to present a long term durability test performed on a commercial 1kW open-cathode proton exchange membrane fuel cell system during more than 5000 hours under specific operating conditions that aim at reproducing driving cycles, including electrical solicitations, idle, start-up, shutdown, and environmental temperature conditions. This study presents voltage, efficiency and electrochemical impedance spectroscopy measurements evolution all along the system operating duration. Results are used to investigate and understand effects of ambient temperature on the PEMFC system performance and degradation. Analyses could be used in further studies to improve energy management and extend the system durability.

Keywords: fuel cell system, fuel cell aging, long term durability test, fuel cell experimental data

Nomenclature

μ -CHP	micro-cogeneration	OCV	open circuit voltage
CAN	controlled area network	PEMFC	proton exchange membrane fuel cell
C_{dl}	double layer capacity	RH	relative humidity
EIS	electrochemical impedance spectroscopy	R_{ohm}	ohmic resistance
FC	fuel cell	R_{pola}	polarization resistance
FCEV	fuel cell electric vehicle	RUL	remaining useful life
HMI	human machine interface	SoH	state of health
MEA	membrane electrode assembly	US DOE	United States department of energy
\dot{m}_{H_2}	hydrogen mass flow	ΔH_f	hydrogen lower heating value

1. Introduction

Nowadays the popularity of hydrogen is highly growing as it is playing an increasing role in the energy transition [1]. Fuel cells are thus considered as a promising solution for energy transition, due to their high efficiency, energy density and their limited impact on environmental resources [2]. This study will focus on the Proton Exchange Membrane Fuel Cell (PEMFC) and their reliability and durability for integration in a Fuel Cell Electric Vehicle. Indeed cost and durability are still a limitation to a worldwide commercialization [3]. In 2010 the American Department of Energy (DoE) indicates a durability target of 5000 hours for automotive applications in order to compete with traditional internal combustion engine. In transportation applications, the fuel cell is subject to rough operating

conditions [4–6], such as air impurities, load cycling [7], temperature and humidity cycles [8,9] and vibrations and shocks. Therefore, many researches have been carried out to improve fuel cells design, with better materials, and to improve their energy management. A good energy management is one of the keys to improve durability as a system operating in abnormal conditions, such as bad water management, fuel starvation or catalyst degradation lead to performance drop and possibly to irreversible degradation reducing significantly the component durability [10]. Therefore, the development of monitoring systems, health assessment and diagnosis algorithms, is a mandatory step to implement a good energy management. Concerning health assessment, the stack voltage and electrochemical impedance are often used as the health indicators to estimate the state of health and then predict the

remaining useful life of the fuel cell system. However, measuring impedance requires external expensive equipment. Whatever the considered measurement solution is, the easiest approach for estimating online the SoH of the fuel cell stack relies only on the fuel cell voltage. Although performance decay of PEMFC is inevitable, the degradation rate can be minimized by a good understanding of the involved degradation mechanisms. Long-term durability tests are often required to analyze and understand these mechanisms and then, to improve performance and durability via better materials and energy management strategies. However, such long duration experimental tests (typically thousands of hours) are very costly and very time consuming, even on low power fuel cell stacks. This is a reason why long-term durability tests remain very rare in the recent literature [4][5]. Though some durability tests have been exposed more recently, most of long term-durability tests presented in the literature were performed before the 2010's [5].

Enz et al. [11] studied the influence of starvation effects during automotive operating conditions. The influence on the PEMFC performance is investigated through polarization curves, cyclic and linear sweep voltammetry as well as electrochemical impedance spectroscopy. The study concluded that performances were reduced by 47% compared to initial conditions as a consequence of the dynamic operation.

Hou et al. [12] studied the effect of strengthened road vibrations on PEMFC stack performances. They concluded that road vibrations have a significant influence on the degradation of performances. The gas-tightness of the stack decreases strongly under long-term vibrations. Consequently, the performances are significantly influenced by vibrations.

Pahon et al. [13] proved through experimental tests that air stoichiometry has also a direct impact on performances. The higher the air stoichiometry the higher the drying-out of the membrane is. This is directly linked to the air flow which evacuates the water produced during the electrochemical reaction. The drying of the membrane involves a conductivity decrease that leads to an increase of the ohmic resistance.

Shaban et al. [14] proposes a review on the negative effects on PEMFC performance which are caused by poisoning such as air contaminants, fuel impurities. This review also provides a summary on mitigation strategies to reduce impact of poisoning.

Pahon et al. [15] carried out a 1000-hours μ -CHP durability test. The test was developed for simulating a μ -CHP load demand profile for a complete year. Ambient temperature remains unchanged. Effects of long duration stationary conditions, OCV and sudden load variations are analyzed. The effects of the long-term test duration reduction on voltage decay are then investigated.

Morando et al. [16] propose a prognostic method based on echo state neural network. Used data are issued from an experimental long duration test of 1700 h during which ambient temperature and load current remain constant. Results of the experimentation exhibit a global voltage decay with respect to the operating time. However, performance recoveries due to reversible phenomena can be observed after characterization phases.

Liu et al. [17] reported a PEMFC accelerated durability test. This test can be conducted in 300 h. They concluded that the major failure factor for the membrane electrode assembly MEA

is pinholes degradation of membrane due to increased hydrogen gas cross-over.

Nandjou et al. [18] conducted a detailed analysis of the influence of local temperature and humidity on degradation. They mentioned that the primary cause of failure in automotive cycling is pinhole/crack formation in the membrane induced by high variations of its water content over time. They also showed that water condensation increases the probability of the bipolar plates corrosion since evaporation phenomena induce local deposits in the cell.

Robin et al. [19] propose a method to model the aging of a PEMFC stack. For this purpose, they performed a first 2000 hours durability test under steady state operation and then a second 2000 hours test under dynamic conditions. They observed a performance decay overtime. However, ambient conditions i.e. ambient temperature was not considered as a variable parameter.

Cai et al. [20] performed a 1000 hours durability test to investigate the durability under high back pressures. Ambient conditions were not considered as variable parameters. Electrochemical Impedance Spectroscopy (EIS) and polarization curves are used to follow the performance evolution. Their results indicated that the main reason for the deterioration was the declined in water management capability of gas diffusion layer (GDL) rather than the deterioration of the membrane and catalyst.

Of typical PEMFC system configurations, the air-cooled open-cathode systems differ from typical closed-cathode systems. As illustrated in Figure 1, open cathode fuel cells have cathode channels exposed to atmosphere thus operate at atmospheric pressure and only use low power fans for supplying external air and cooling it [21]. In closed-cathode PEMFCs the air is supplied by a compressor and can operate at higher pressures which results in better performance and higher voltages. However, operating at atmospheric pressure avoids considerable parasitic loads as system do not require air blower, liquid cooling, liquid pump, heat exchanger, compressor and pressure regulation. Furthermore, this configuration allows to use the generated water, so no external humidifier is needed. This is why open cathode PEMFCs are growing more popular for use in low and middle power mobile applications such as drones, unmanned aerial vehicles [22], lightweight road vehicles [23] and low power stationary applications (<5kW) due to their simple structure, low cost, light weight and simple balance-of-plant concept [24].

Several research studies have investigated the open-cathode PEMFC. Most of them focus on control strategies and performance improvement. Mahjoubi et al. [25] proposed a thermal control strategy which combining concurrently the stack temperature regulation and the air stoichiometry adjustment to ensure a performance improvement and the degradation prevention of the studied system. Firstly, the author developed a multi-physical model based on acausal modeling approach. Then, an experimental part by using a 2kW open cathode PEMFC is carried out to verify the performance of the control strategy with different operating conditions. Jian et al. [26] investigated the thermal response characteristics of an open cathode PEMFC stack. Their experimental study contributes to the optimizing of the cooling strategy and thermal management

of open cathode PEMFC stacks. In a different study, Jian et al. [27] investigated the purge process of an open cathode PEMFC stack with a dead-end anode. Different purge intervals and purge time were tested and discussed in detail to identify the best strategy with a stable voltage output and high hydrogen utilization. Their conclusions are helpful to find out an optimal

purge strategy of PEMFC stack with dead-end anode. De Las Haras et al.[28] present a comprehensive study of three possible configurations of the Oxidant/Cooling subsystem in an open cathode PEMFC and investigate the best airflow distribution.

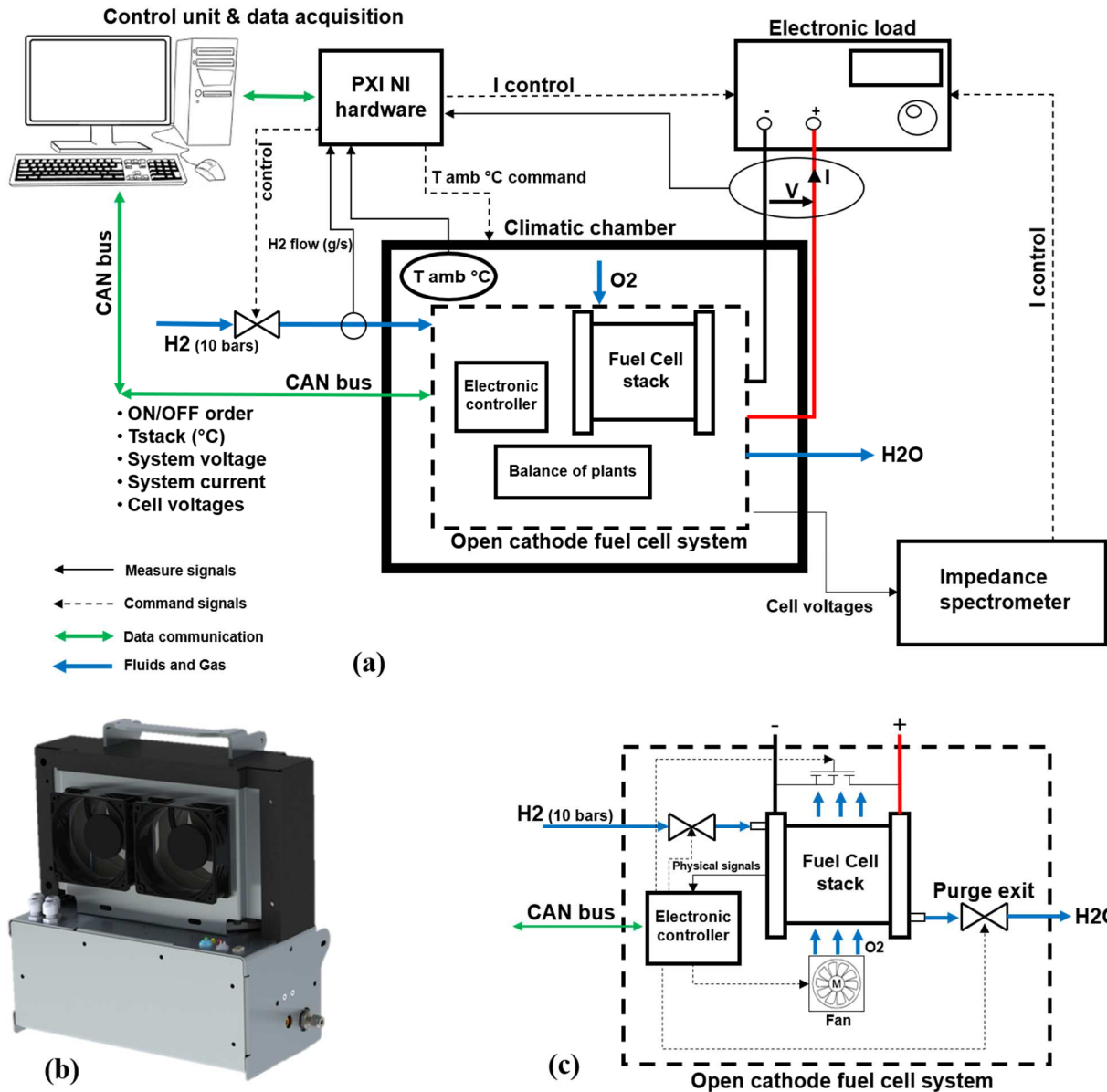

Figure 1: (a) Experimental set up, (b) commercial 1kW fuel cell system, (c) synoptic of the fuel cell system

In the recent literature there is a clear lack of long-term open cathode PEMFC aging tests and particularly carried out on stacks and not on a single cell. Moreover, when considering complete open-cathode fuel cell systems, the publications are still less numerous. Al-Zeyoudi et al. [6] evaluate the effect of monthly ambient air conditions on performance evolution of an open-cathode PEMFC stack under ambient conditions in United Arab Emirates. They showed that the stack performance is highly related to ambient conditions: ambient temperature and humidity. Results indicate that the performance can vary

significantly depending on the period of the year (up to 40% from winter to summer). Moreover, they ensure that the anode humidification results in better stack performance under hot and dry conditions since such conditions lead to a drying out of membranes. They concluded that a careful balance has to be identified between the humidifier parasitic load and the stack power. However, this study is limited to the steady state operation conditions. Moreover, this study focuses on performance variations due to ambient temperature but not on degradation mechanisms.

A fuel cell is a multi-physical system so many parameters and operating conditions can affect performances and durability in different manners. The previous cited studies have only investigated the influence of one-criterion on performance or durability. In real use, the system is subjected to rough operating conditions such as load cycling, road vibrations, humidity variations, variable ambient temperature, etc. which represent many affecting parameters on the entire system degradation [4–6]. In this framework, the contribution of this study is to evaluate and follow during a long-term durability test the state of health of a complete self-humidified open-cathode PEMFC system under vehicle electrical solicitations and variable ambient temperature conditions. The objective is to investigate performance degradation overtime to understand degradation and contribute to durability improvement in order to achieve US DOE targets for transportation applications. For this purpose, the system is operating on a test bench for more than 5000 hours under specific conditions which aim at reproducing driving cycles of a lightweight postal hydrogen vehicle in variable ambient temperature conditions, including startup, idle, operating, shutdown and thermal cycling [29]. In a first step the SoH will be observed thanks online monitored data. In a second step, electrochemical impedance spectroscopy will be used to complete the analyses.

This paper is organized as follow: in a first part, the experimental context and the experimental set up used for the experiment will be introduced. Secondly, the electrical solicitations and the desired environmental conditions will be detailed. Then the results will be drawn and analyzed. Finally, hypothesis to explain performance degradation will be made.

2. Experimental procedure

2.1 Experimental context

The purpose of this study is to approach at best postal delivery conditions met with the vehicles operated during the Mobypost European project. Mobypost project aimed at developing a fleet of ten postal FCEVs and monitoring them during more than three years during day-to-day operation to create a rich database. The vehicle architecture is illustrated in Figure . The fuel cell system is integrated as a range extender in order to power the battery pack and charge it during stop phases.

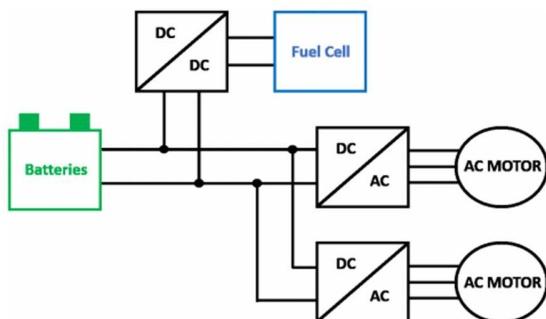

Figure 2: Architecture of the postal hydrogen vehicles developed among Mobypost project

The objective of the study is to analyze and understand degradation mechanisms in order to improve system design and

energy management that will lead to better durability of the future vehicles. That is the reason why the purpose of our long duration test is to reproduce at best the environmental and operating conditions of the fuel cell system integrated in this architecture. Typically as it is shown in [29,30] a postal delivery duration is about four hours during which the fuel cell system should provide quite a constant power to the battery pack all along the driving cycle. Likewise, ambient temperature mainly depends on the considered season in the year. According to the database created through the three years monitoring of the ten vehicles, the temperature in the vehicles have never been lower than 0°C. Moreover, the vehicles were parked in a garage where ambient temperature was controlled to be equal to 12°C in order to avoid freezing during winter.

2.2 Fuel cell system and test bench presentation

The experimental set up is detailed in Figure 1 and Figure 3. The autonomous test bench integrates a climatic chamber, an active load, a fluids control and an electronic control unit which controls and communicates with a fuel cell system. To consolidate measures sent by the fuel cell system, the experimental set up also integrates its own specific sensors to measure temperature and relative humidity of ambient air, hydrogen mass flow, fuel cell system output voltage, fuel cell system output current, fuel cell system output and input air temperatures.

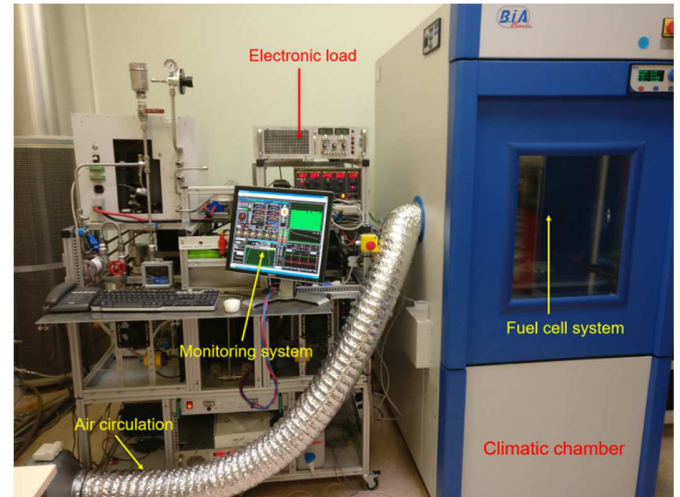

Figure 3: Test bench

The fuel cell system used in this study is a commercial AIRCELL™ fuel cell system from H2SYS company and is illustrated in Figure 1 (b). Typically, as shown in the synoptic Figure 1 (c) a complete PEMFC system integrates a fuel cell stack, a hydrogen supply line, an air supply line, a cooling management system, humidification system and electronics to manage electrical fluxes inside the system and controller to supervise actions and safety functions. Here, the nominal power is 1kW, it integrates an open cathode stack with forced-convection and dead-end anode which is air cooled by fans and

self-humidified by short-circuits. The nominal operating point is 50A, 62°C (stack temperature) and the ambient operating temperature range specified by the manufacturer is +5°C to 35°C. The system can operate autonomously and is able to communicate through CAN bus network its operating physical values such as fuel cell temperature, fuel cell current and output voltage.

The control unit dedicated to monitor and control the test bench and to communicate with the fuel cell system is developed with LabVIEW software and based on a PXI National instrument hardware. The control unit assures the data logging with a sampling frequency of 1Hz, the current load demand, the safety controls, the data display true dedicated HMI.

During experiments, the fuel cell system is placed in a 650L ADF type climate chamber (-20°C to +100°C, ±0.5°C) from BIA climatic company to control the ambient temperature. In the experimental room, the air relative hygrometry is controlled around 50% at 21°C. This means that water content in ambient air remains identical all along the experiments. To ensure these conditions inside the climatic chamber and constantly renew the air, an air circulation was set up as it can be seen in Figure 3. Consequently, whatever the RH value inside the climatic chamber linked to the temperature variations, the water content in the air will remain constant.

2.3 Electrical solicitations and ambient conditions

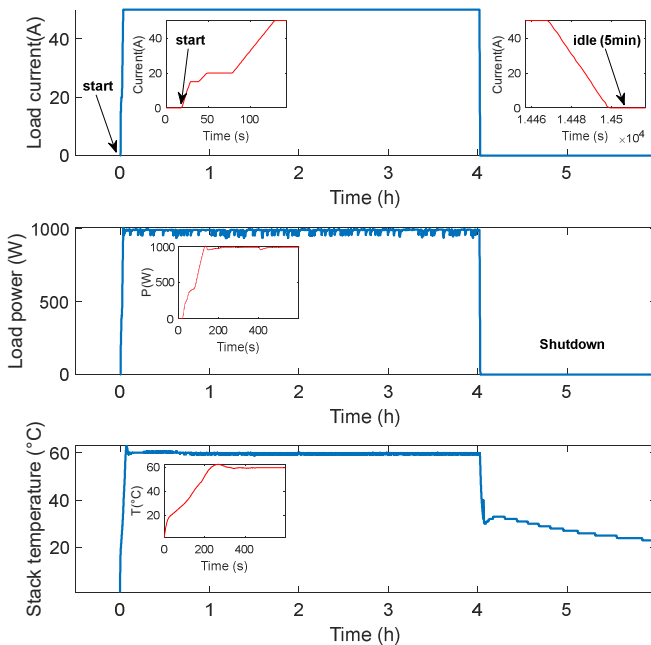

Figure 4: Cycling profile

Figure 4 illustrates the current profile and the stack temperature cycling that was applied to the system all along the experimentation. Based on average postal delivery duration, the system will operate at its nominal operating point (current load = 50A) for four hours followed by two hours of rest by shutting

down the system. This profile will be repeated continuously (4 times a day and everyday) to allow accelerated analysis of performance degradation. After startup at the ambient temperature controlled by the climate chamber, the fuel cell system current is increased with a ramp until the nominal operating point (50A) is reached. At nominal operating point the system controls its own temperature around 62°C. To shut down the system, firstly the current is decreased with a ramp to reach a zero value, then the system mode is idle for five minutes before is stopped. When the system is stopped, the fuel cell system temperature tends to ambient temperature, so the system suffers a complete thermal cycling. Based on the cycling profile, 5200 hours of operating time represent 1300 power profiles illustrated in Figure 4. Concerning the ambient temperature, its value was controlled by a climatic chamber and varied as it is detailed below and illustrated in Table 1.

Table 1 – Ambient temperature evolution.

Stage	Operating time duration (h)	Average ambient temperature (°C)
1	1000	20
2	1000	30
3	400	20
4	600	10
5	1000	20
6	1165	10

- **Stage 1:** the system was placed in the climatic chamber regulated at 20°C for 1000 hours.
- **Stage 2:** the ambient temperature was increased to 30°C during 1000 hours in order to observe the impact of higher temperature on performance degradation.
- **Stage 3:** the ambient temperature was reset to 20°C to observe a potential reversible degradation. Degradation slope of stage 1 and stage 3 will be compared then potential irreversible degradation caused by higher temperature can be identified.
- **Stage 4:** the average ambient temperature was decreased to 10°C in order to study effect of low temperature on the system. Moreover, to observe short time impact of ambient temperature variations a cycling was performed between 5°C and 20°C with the mean value objective around 10°C. This stage lasted 600 hours.
- **Stage 5:** the ambient temperature is reset to 20°C to observe a potential impact of lower temperature on performance degradation. Degradation slope of stage 1, stage 3 and stage 5 will be compared to analyze impact of high and low temperature on the performance evolution.

- **Stage 6:** the temperature was decreased and maintained to a value of 10°C during more than 1000 hours to observe impact of a long duration constant low temperature on the performance.

2.4 Experimental measures

2.4.1 Voltage

Cell voltage measuring is a simple and inexpensive way to implement monitoring. The majority of fuel cell fault modes lead to a voltage drop. Equally it is known that all along the fuel cell lifetime, the stack voltage tends to decrease, thereby this value gives information about the component aging and performance. For example, in their study Futter et al. [31] use the voltage evolution to observe the effects of relative humidity and pressure of inlet gas. Frappe et al. [32] use voltage and polarization curves to identify a flooding or a drying fault condition. Steiner et al. [33] analyze only voltage signal to diagnose the SoH. In their work, they propose a method using wavelets to discriminate between "flooding" and "non flooding" states in a PEMFC. The wavelet decomposition is applied to the stack voltage signal.

In this paper only the stack voltage at nominal operating point will be analyzed with respect to operating time duration and ambient temperature. The purpose is to quantify both system SoH and performance through voltage evolution trends and voltage instantaneous value.

2.4.2 Impedance

Electrochemical impedance spectroscopy (EIS) is a performing tool to give information about the state of health of a fuel cell, or even of a battery. Many studies proposed this tool to identify a fault operating condition or a performance degradation. Kurz et al. [34] presented through their works that impedance measurements can detect a flooding condition a few minutes before they can be observed on the polarization curves. They showed that impedance measurement done at only two specific frequencies, one high and one low, can be enough to predict a voltage drop due to flooding or drying fault conditions. Rubio et al. [35] showed that evolution of both ohmic and polarization resistances can be observed versus time giving information about the global performance degradation of the component. Equally they showed that anode catalyst poisoning

by carbon monoxide can be observed on the EIS Nyquist diagram. Fouquet et al. [36] showed that ohmic resistance is linked to the water content of the membranes. They also presented that polarization resistance is rather linked to diffusion phenomena and significantly affected by aging.

In our experimentation impedance measures were performed to get more information about the dynamic behavior of the system and understand better the degradation laws. All the EIS tests were performed at nominal operating point (50A, 62°C) with an amplitude of the perturbation current of 6A, and the test frequency range goes from 1kHz to 0.1Hz. The equipment used to perform the EIS was designed and developed at the laboratory during the thesis work of Wasterlain et al. [37]. This is important to notify that the ambient temperature will not be the same every-time as it follows the temperature cycle Table 1. Moreover, during the stage 6 the EIS measurements were not performed weekly as the period of characterization has been increased.

3. Results

3.1 System output voltage and efficiency evolution

Observing stack voltage evolution and ambient temperature impact on performance requires some specifications. The operating conditions of the system: load current and stack temperature, must remain strictly identical. For this purpose, the average stack voltage is computed daily considering a period of 1000 seconds during which the stack temperature is stabilized, and nominal operating conditions are ensured (50A, 62°C). As a result of the experiment, Figure highlights performance evolution: output voltage and efficiency of the system with respect to the total operating time and the ambient temperature. The efficiency of the system is computed as in the equation (1). Results let clearly appear that ambient temperature and operating time have a direct impact on the system performance.

$$\eta_{FC} = \frac{P_{load}}{\Delta H_f \cdot \dot{m}_{H_2}} \quad (1)$$

with P_{load} , the net output power of the fuel cell system measured by the current and voltage sensors on the testbench, $\Delta H_f = -241.6$ KJ/mol is the hydrogen lower heating value and \dot{m}_{H_2} is the hydrogen mass flow in mol/s.

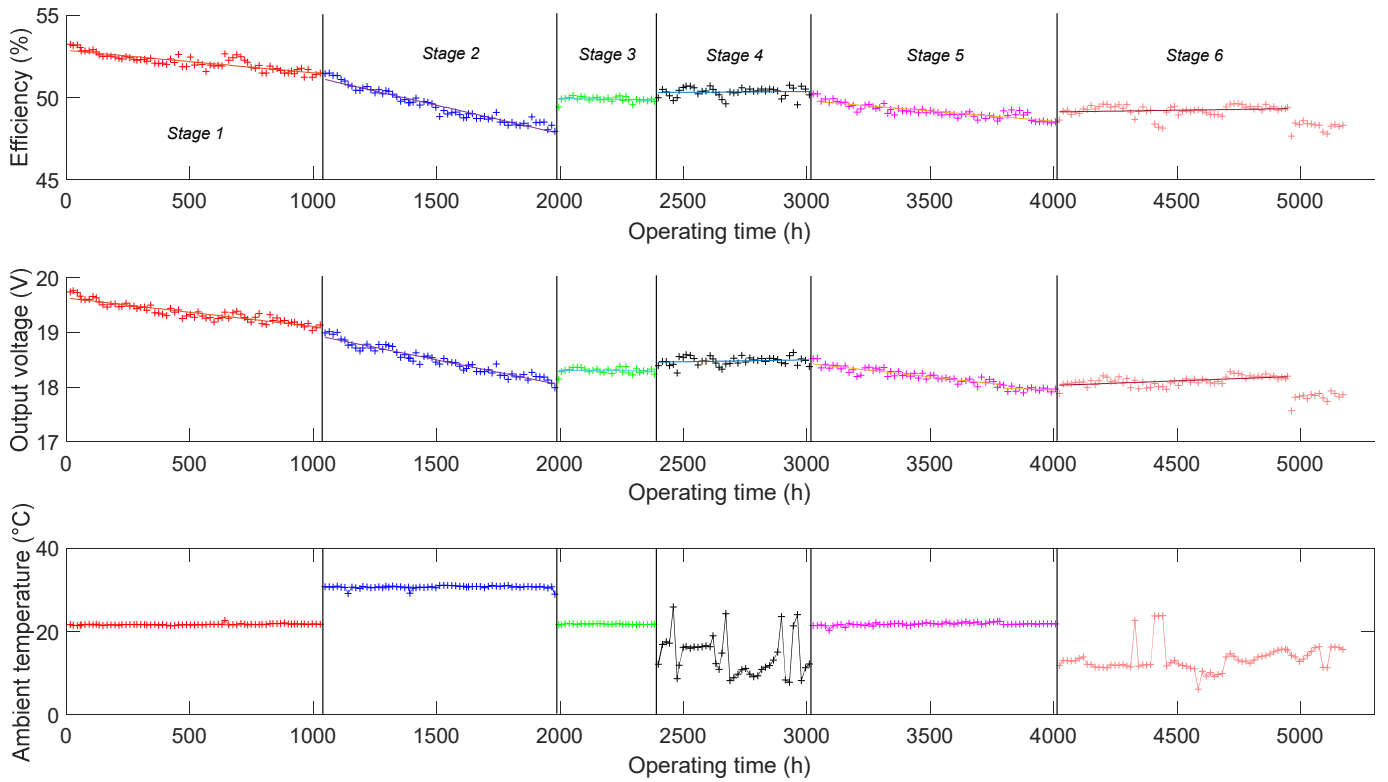

Figure 5: System performance evolution considering ambient temperature variations

Table 2 – Equations of the V_{stack} evolution trend lines.

Stage	Trend line equation (V)
1	$-5.2 \times V_{stack} \times 10^{-4} + 19.63$
2	$-9.12 \times V_{stack} \times 10^{-4} + 19.86$
3	$-0.255 \times V_{stack} \times 10^{-4} + 18.35$
4	$0.73 \times V_{stack} \times 10^{-4} + 18.28$
5	$-4.9 \times V_{stack} \times 10^{-4} + 18.9$
6	$1.74 \times V_{stack} \times 10^{-4} + 17.97$

- **Stage 1:** the ambient temperature is controlled around 20°C, the system output voltage and the efficiency decrease with a linear slope. This phenomenon is expected and has been shown in the literature [15][16]. Stack voltage generally tends to decrease versus the operating time due to system components degradation.
- **Stage 2:** shows higher losses as the voltage and efficiency decreasing is more important once the ambient temperature was elevated. Moreover, as soon as the ambient temperature was changed, a jump on the efficiency can be noticed. These phenomena suggest that ambient temperature has a direct impact on the system current performance and its evolution. More precisely, increasing the ambient temperature accelerates the degradation of the system. As illustrated in Figure 1, open cathode fuel cells have cathode channels

exposed to atmosphere and use fans for supplying external air and cooling it. On the one hand, the power required by the fans at higher temperature to regulate the stack temperature could explain the observed efficiency drop. On the other hand, the important air stoichiometry could explain the observed degradation acceleration as a higher air flow could tend to dry out membranes.

- **Stage 3:** a short-term performance recovery can be observed once the ambient temperature was decreased, translated by an ascent of the efficiency. This efficiency ascent enhances the previous hypothesis that the ambient temperature directly affects the power required by the fans to cool the stack. Moreover, during this stage, the performance evolution is nearly constant so no degradation can be noticed contrary to the first stage whereas the ambient temperature was similar. This phenomenon implies that reducing temperature seems to lead to a long-term system recovery noticeable on the performance evolution.
- **Stage 4:** the same phenomena can be observed. On the one hand, short-term performance variations, directly correlated to the ambient temperature variations, can be noticed and verify the previous observations. On the other hand, contrary to the previous stage, here can be observed that performance evolution presents a positive slope during the entire 600 hours, which is surprising (cf. Table 2). This phenomenon

implies that reducing the ambient temperature to a value lower than 20°C would lead to system performance recovery after a reversible degradation caused by higher temperatures.

- **Stage 5:** the performance evolution returned negative with a slope similar to the stage 1 (cf. Table 2). Contrary to the stage 3, the temperature is increased thus this phenomenon implies that the ambient temperature value is not the only factor affecting the performance evolution. Indeed, there seem to be a difference between increasing ambient temperature and decreasing ambient temperature even if the values are equals.
- **Stage 6:** the ambient temperature was reduced and regulated around 10°C, except four days where the climate chamber met default mode so the ambient temperature in the climatic chamber met the ambient temperature in the experimental room (21°C). During this stage and similarly to the stage 4, reducing the ambient temperature leads to a long-term system performance recovery as the performance evolution is positive during more than 1000 hours (cf. Table 2). At the end of the stage 7, just before 5000 hours, significant performance losses can be noticed both on efficiency and stack voltage evolution whereas the ambient temperature remains unchanged. It is worth noting that the system was suddenly shut down after a safety stop of the experimental room. This emergency stop seems to have caused severe damages to the system.

As already presented in many studies, experimental results show that the operating time clearly leads to irreversible performance degradation as the global stack voltage trend is negative. Otherwise, experimental results highlight interesting phenomena. The ambient temperature affects the system performance and degradation with long, mid and short-term phenomena. Short-term phenomena appear directly with a variation of the ambient temperature. As soon as the ambient temperature changes, a variation of the operating point and of the system efficiency can be observed. Variations are either positive or negative depending if the temperature is increased or decreased. This dependency can be verified during the fourth stage when the ambient temperature is cycling where, short-term variations of the efficiency are directly correlated to the ambient temperature. These variations could be due to the power required by the fans to regulate the stack temperature depending on the ambient temperature value. In addition, very interesting long-term phenomena can be observed. It is noticeable that the value of the ambient temperature has an impact on the performance degradation rate. The degradation rate is more important when the temperature is increased. But when ambient temperature decreases, performance evolution shows improvement. Particularly when the ambient temperature is lower than 15°C, performance trend became positive during hundreds of hours. These phenomena suggest that a recovery of

the system health, after reversible degradation, occurs during such a duration. These phenomena could be linked to the air stoichiometry difference specific to the open cathode configuration and depending on the ambient temperature. A higher air stoichiometry could lead to membranes dry out whereas a lower air stoichiometry would enhance the water content in the membranes. However, this hypothesis is hard to assure with a study of the voltage evolution only. In order to support the proposed analysis and get more information to understand the causes of these phenomena, electrochemical impedance spectroscopy measurements were performed.

3.2 Electrochemical impedance spectroscopy

In the following, measurements issued from EIS are analyzed using a Nyquist diagram. Through this diagram, information about stack resistances and double layer capacity can be obtained [38–40]. At high frequency the Nyquist diagram gives information about the Ohmic resistance corresponding to membrane and cabling resistance. Its value is obtained by the real part of the impedance spectra at high frequency when imaginary part is zero. At low frequency the diagram gives information about complete stack resistance. This resistance is the consequence of ohmic, charge transfers and diffusion phenomena. Its value is obtained by the real part of the impedance spectra at low frequency when imaginary part is zero. In addition, the maximum value of the imaginary part gives information about the double layer capacity as in the equation (2).

$$C_{dl} = \frac{1}{R_{diff} \times \omega_{IM}} \quad (2)$$

Where ω_{IM} , is the radial frequency of the maximum negative imaginary part. R_{diff} is the difference between R_{ohm} and R_{pola} .

The purpose of an EIS study is to observe the evolution of these parameters versus the operating time and correlate the evolution with operating conditions. Indeed, as it was mentioned in the previous section, evolution of these parameters gives information about fuel cell components aging, but also gives information about a possible default mode such as flooding, drying or poisoning. Figure 6 shows the EIS spectra evolution in the Nyquist diagram with respect to ambient temperature and operating time. In order to refine, one spectrum is drawn at the beginning and the end of each stage (cf. Table 1). It can be quickly observed that the area of the spectra tends to increase through the operating time. However, some recoveries (spectra partial reduction) occur depending on temperature variations.

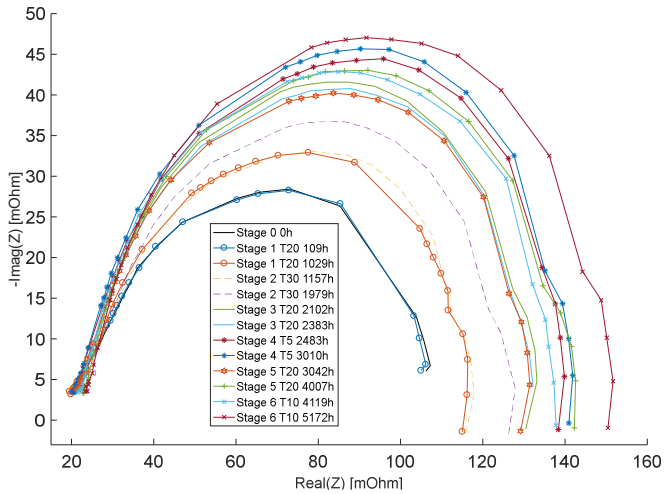

Figure 6: EIS Nyquist diagram at the beginning and the end of each stage

For a better visibility, Figure 7 draws evolution of the parameters, obtained through all the 50 characterizations, versus the operating time and referring to the ambient temperature evolution.

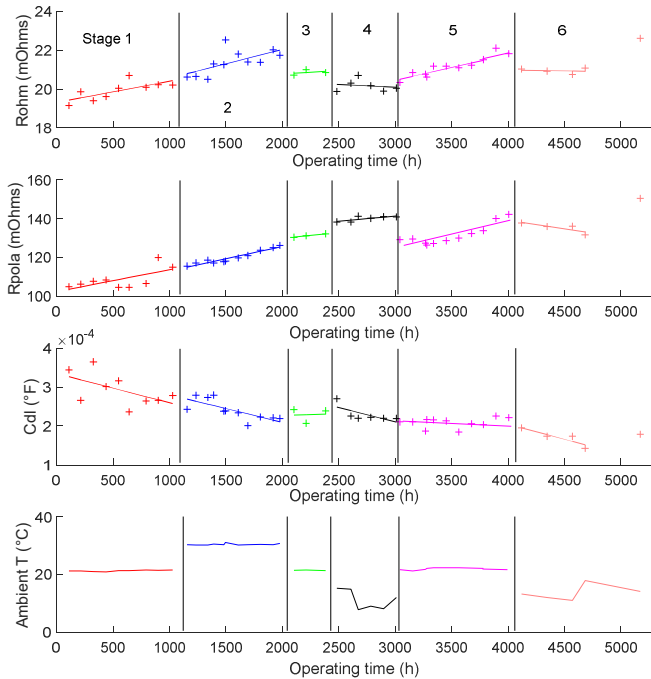

Figure 7: Evolution of the EIS parameters

Concerning the ohmic resistance, except at lower ambient temperature, the trend at each stage is to increase as operating time increases. However, even if the global evolution overtime is increasing, the ohmic resistance value seems to be mainly affected by ambient temperature, more than by operating time. The ohmic resistance refers to the membrane resistance to the

passage of H⁺ ions [38]. Several studies showed that this ohmic resistance is correlated with the membranes humidity [36,38,39,41,42]. The higher the membrane water content the lower the ohmic resistance value, the lower the water content the higher the resistance. Figure 7 show clearly that reducing the ambient temperature leads to a decreasing of the ohmic resistance and particularly when the ambient temperature is lower than 15°C. This declining of the ohmic resistance is a phenomenon that spans hundreds of hours. This phenomenon could imply that reducing the ambient temperature leads to a re-moisture of the membranes.

In contrary double layer capacity seems to be mainly dependent on the operating time as its evolution is continuously decreasing all along the system lifetime. In addition, it is worth noting that the consequences of the emergency stop is observable on EIS measurements as the value of R_{ohm} significantly increased but also on the C_{dl} as the last measurement shows a clear modification of the trend line.

Concerning R_{polo} , dependencies look more complex to identify. A clear impact of the operating time is observable as every stage but the last show a positive trend line versus the time. However slight jumps can be observed between the stages and specially in passing from stage four to stage five. Between these two stages the system was stopped for six weeks and this could be a reason of the resistance recovery. In addition, during the last stage, R_{polo} starts to decrease until the emergency stop showing again the impact of such a sudden stop. Thereby a constant low temperature, and not a cycling like during the fourth step, seems to lead to a R_{polo} remission. However, an impact of the ambient temperature on the evolution of R_{polo} is difficult to identify in this case.

4. Analyzes

The purpose of this section is to propose explanations and support to the previous hypothesis concerning the performance evolution presented in the previous section. The observed short-term performance variations linked to the ambient temperature can be explained by a variation of the operating point depending on the ambient temperature. This means that ambient temperature directly affects the net output power supplied by the system. Indeed, as the load current remains unchanged all along the experimentation, it implies that fuel cell system ancillaries will need more or less power depending on the ambient temperature. The power required by the ancillaries is higher when the ambient temperature increases in order to maintain the same operating temperature in the fuel cell stack, therefore the voltage and the efficiency decrease.

Consequently, this air flow depending on the ambient temperature could explain long term health recovery of the system. Making the hypothesis that the short-circuit self-

humidification strategy is constant whatever the temperature is, thereby humidification level of the membrane is directly linked to the air flow and to the ambient temperature. This makes sense and is clearly observable on the performance evolution on Figure . Once the temperature is decreased, the air flow is decreased, and the fuel cell stack membranes tend to be less dried out due to the air brewing. Indeed, the water created during the electrochemical reactions is less quickly evacuated if the air flow is reduced then the water content in the membranes is more important. Therefore, the system degradation rate is lower as the humidification conditions in the membranes are better (cf. Figure 5). However, the value of the ambient temperature is not the only factor affecting the performance evolution. Indeed, there seem to be a difference between increasing ambient temperature and decreasing ambient temperature even if the values are equals. This phenomenon implies that reducing the ambient temperature leads to a re-moisturize of the membrane after reversible degradation caused by higher ambient temperature. This re-moisturize of the membranes seems to be a very long-term phenomenon as the performance recovery lasts hundreds of hours.

However, even if the humidification of the membranes varies depending on the ambient temperature, the system does not meet a default mode, neither drying or flooding as no significant increases of the ohmic and low frequency resistances were noticed [36].

Finally, it can be observed that after the abnormal system shutdown caused by the experimental room safety stop, which led to important performance decrease on the system, the stack voltage tends again to increase.

To conclude, the system has been operated under good conditions all along the experimentation. Just before 5000 hours of operating time, the system shows a loss of efficiency of 9% and an average degradation rate of $11\mu\text{V}/\text{cell}/\text{h}$. On the entire actual experimentation, global loss of efficiency is about 10% and the degradation rate is $13\mu\text{V}/\text{cell}/\text{h}$ after 5165h running, 1300 start/stops and thermal cycles (ambient $T^{\circ}\text{C}$ to 62°C). Even if a slight variation of the membrane moisture impacts very slightly the system voltage, no default mode was met. The variation of the ohmic resistance is not significant. Concerning the efficiency evolution, the jumps are explained by the power needed by the system to regulate its temperature which is totally normal as it is self-powered. Finally, an ambient temperature range between $+5^{\circ}\text{C}$ and $+12^{\circ}\text{C}$ seems to be an optimal range leading to better operating conditions for self-humidified air-forced convection open cathode systems as the electrolyte membranes operate under better humidification conditions. These better humidification conditions seem to reduce significantly the degradation rate.

5. Conclusion

This study presents a long duration tests of a complete open cathode PEMFC system under accelerated postal delivery driving cycle inspired by Mobypost EU project. The main purpose of this study is to present the impact of the ambient temperature on the FC system performance such as efficiency, voltage, ohmic and polarization resistances and double layer capacitance as a function of operating time. It is shown that ambient temperature clearly impacts the performances with short- and long-term phenomena. A low ambient temperature leads to better humidification conditions and significantly reduces the degradation rate. The considered system is a very promising and reliable power source well adapted to lightweight hybrid vehicle for postal delivery application. Indeed, the performance after 5000 operating hours under variable ambient temperature conditions (5°C to 30°C) and 1300 thermal cycles remains very good with a global efficiency higher than 49% and only 9% loss of performance versus the beginning of life operating conditions, lower than the durability target performances set by the US DOE for automotive fuel cells.

The system is still operating, and further studies will aim at pursuing the experimentation and investigate impact of subzero ambient temperatures. Moreover, future works will focus on the cell voltage evolutions. The final objective is to use analysis from this long duration test results to develop better control laws and improve the system durability.

6. Acknowledgement

This research work was funded by the region of Bourgogne Franche-Comté, France.

7. References

- [1] J.P. Stempien, S.H. Chan, Comparative study of fuel cell, battery and hybrid buses for renewable energy constrained areas, *J. Power Sources*. 340 (2017) 347–355.
- [2] A. Vadiée, M. Yaghoubi, M. Sardella, P. Farjam, Energy analysis of fuel cell system for commercial greenhouse application – A feasibility study, *Energy Convers. Manag.* 89 (2015) 925–932.
- [3] X. Lü, Y. Qu, Y. Wang, C. Qin, G. Liu, A comprehensive review on hybrid power system for PEMFC-HEV: Issues and strategies, *Energy Convers. Manag.* 171 (2018) 1273–1291.
- [4] P. Pei, H. Chen, Main factors affecting the lifetime of Proton Exchange Membrane fuel cells in vehicle applications: A review, *Appl. Energy*. 125 (2014) 60–75.
- [5] J. Zhao, X. Li, A review of polymer electrolyte membrane fuel cell durability for vehicular applications: Degradation modes and experimental techniques, *Energy Convers. Manag.* 199 (2019) 112022.
- [6] H. Al-Zeyoudi, A.P. Sasmito, T. Shamim, Performance

- evaluation of an open-cathode PEM fuel cell stack under ambient conditions: Case study of United Arab Emirates, *Energy Convers. Manag.* 105 (2015) 798–809.
- [7] B. Wahdame, D. Candusso, X. François, F. Harel, M.-C. Péra, D. Hissel, J.-M. Kauffmann, Comparison between two PEM fuel cell durability tests performed at constant current and under solicitations linked to transport mission profile, *Int. J. Hydrogen Energy*. 32 (2007) 4523–4536.
- [8] M. Oszczypok, D. Riemann, U. Kronenwett, M. Kreideweis, M. Zedda, Statistic analysis of operational influences on the cold start behaviour of PEM fuel cells, *J. Power Sources*. 145 (2005) 407–415.
- [9] L. Jia, Z. Tan, M. Kang, Z. Zhang, Experimental investigation on dynamic characteristics of proton exchange membrane fuel cells at subzero temperatures, *Int. J. Hydrogen Energy*. 39 (2014) 11120–11127.
- [10] H. Kanani, M. Shams, M. Hasheminasab, A. Bozorgnezhad, Model development and optimization of operating conditions to maximize PEMFC performance by response surface methodology, *Energy Convers. Manag.* 93 (2015) 9–22.
- [11] S. Enz, T.A. Dao, M. Messerschmidt, J. Scholta, Investigation of degradation effects in polymer electrolyte fuel cells under automotive-related operating conditions, *J. Power Sources*. 274 (2015) 521–535.
- [12] Y. Hou, D. Hao, J. Shen, P. Li, T. Zhang, H. Wang, Effect of strengthened road vibration on performance degradation of PEM fuel cell stack, *Int. J. Hydrogen Energy*. 41 (2016) 5123–5134.
- [13] E. Pahon, N. Yousfi Steiner, S. Jemei, D. Hissel, P. Moçoteguy, A signal-based method for fast PEMFC diagnosis, *Appl. Energy*. 165 (2016) 748–758.
- [14] B. Shabani, M. Hafttananian, S. Khamani, A. Ramiar, A.A. Ranjbar, Poisoning of proton exchange membrane fuel cells by contaminants and impurities: Review of mechanisms, effects, and mitigation strategies, *J. Power Sources*. 427 (2019) 21–48.
- [15] E. Pahon, S. Morando, R. Petrone, M.-C. Péra, D. Hissel, N. Yousfi-Steiner, S. Jemei, R. Gouriveau, D. Chamagne, P. Moçotéguy, N. Zerhouni, Long-term tests duration reduction for PEMFC μ -CHP application, *Int. J. Hydrogen Energy*. 42 (2017) 1527–1533.
- [16] S. Morando, S. Jemei, D. Hissel, R. Gouriveau, N. Zerhouni, Proton exchange membrane fuel cell ageing forecasting algorithm based on Echo State Network, *Int. J. Hydrogen Energy*. 42 (2017) 1472–1480.
- [17] M. Liu, C. Wang, F. Xie, Z. Mao, A polymer electrolyte fuel cell life test using accelerating degradation technique, *Int. J. Hydrogen Energy*. 38 (2013) 11011–11016.
- [18] F. Nandjou, J.-P. Poirot-Crouvezier, M. Chandesris, J.-F. Blachot, C. Bonnaud, Y. Bultel, Impact of heat and water management on proton exchange membrane fuel cells degradation in automotive application, *J. Power Sources*. 326 (2016) 182–192.
- [19] C. Robin, M. Gérard, M. Quinaud, J. d'Arbigny, Y. Bultel, Proton exchange membrane fuel cell model for aging predictions: Simulated equivalent active surface area loss and comparisons with durability tests, *J. Power Sources*. 326 (2016) 417–427.
- [20] C. Cai, Y. Rao, Y. Zhang, F. Wu, S. Li, M. Pan, Failure mechanism of PEM fuel cell under high back pressures operation, *Int. J. Hydrogen Energy*. 44 (2019) 13786–13793.
- [21] Y. Tang, W. Yuan, M. Pan, Z. Li, G. Chen, Y. Li, Experimental investigation of dynamic performance and transient responses of a kW-class PEM fuel cell stack under various load changes, *Appl. Energy*. 87 (2010) 1410–1417.
- [22] J. Kim, D.-M. Kim, S.-Y. Kim, S.W. Nam, T. Kim, Humidification of polymer electrolyte membrane fuel cell using short circuit control for unmanned aerial vehicle applications, *Int. J. Hydrogen Energy*. 39 (2014) 7925–7930.
- [23] A. Ravey, S. Faivre, C. Higel, F. Harel, A. Djerdir, Energy management of fuel cell electric vehicle with hybrid tanks, *IECON Proc. (Industrial Electron. Conf.)* (2014) 3962–3967.
- [24] J. Ishaku, N. Lotfi, H. Zomorodi, R.G. Landers, Control-oriented modeling for open-cathode fuel cell systems, in: *Proc. Am. Control Conf., Institute of Electrical and Electronics Engineers Inc.*, 2014: pp. 268–273.
- [25] C. Mahjoubi, J.-C. Olivier, S. Skander-mustapha, M. Machmoum, I. Slama-belkhdja, An improved thermal control of open cathode proton exchange membrane fuel cell, *Int. J. Hydrogen Energy*. 44 (2019) 11332–11345.
- [26] Q. Jian, B. Huang, L. Luo, J. Zhao, S. Cao, Z. Huang, Experimental investigation of the thermal response of open-cathode proton exchange membrane fuel cell stack, *Int. J. Hydrogen Energy*. 43 (2018) 13489–13500.
- [27] Q. Jian, L. Luo, B. Huang, J. Zhao, S. Cao, Z. Huang, Experimental study on the purge process of a proton exchange membrane fuel cell stack with a dead-end anode, *Appl. Therm. Eng.* 142 (2018) 203–214.
- [28] A. De las Heras, F.J. Vivas, F. Segura, M.J. Redondo, J.M. Andújar, Air-cooled fuel cells: Keys to design and build the oxidant/cooling system, *Renew. Energy*. 125 (2018) 1–20.
- [29] L. Vichard, A. Ravey, S. Morando, F. Harel, P. Venet, S. Pelissier, D. Hissel, Battery aging study using field use data, in: *IEEE Veh. Power Propuls. Conf.*, 2017.
- [30] L. Vichard, S. Morando, A. Ravey, F. Harel, P. Venet, S. Pelissier, D. Hissel, Battery Modeling using Real Driving Cycle and Big-Bang Big-Crunch algorithm, in: *2018 IEEE Transp. Electrification Conf. Expo, ITEC 2018, Institute of Electrical and Electronics Engineers Inc.*, 2018: pp. 309–314.
- [31] G.A. Futter, A. Latz, T. Jahnke, Physical modeling of chemical membrane degradation in polymer electrolyte membrane fuel cells: Influence of pressure, relative humidity and cell voltage, *J. Power Sources*. 410–411 (2019) 78–90.
- [32] E. Frappé, A. De Bernardinis, O. Bethoux, C. Marchand, G. Coquery, Fault detection and identification using simple and non-intrusive on-line

- monitoring techniques for pem fuel cell, IEEE Int. Symp. Ind. Electron. (2010) 2029–2034.
- [33] N. Yousfi Steiner, D. Hissel, P. Moçotéguy, D. Candusso, Diagnosis of polymer electrolyte fuel cells failure modes (flooding & drying out) by neural networks modeling, *Int. J. Hydrogen Energy*. 36 (2011) 3067–3075.
- [34] T. Kurz, A. Hakenjos, J. Krämer, M. Zedda, C. Agert, An impedance-based predictive control strategy for the state-of-health of PEM fuel cell stacks, *J. Power Sources*. 180 (2008) 742–747.
- [35] M.A. Rubio, A. Urquia, S. Dormido, Diagnosis of performance degradation phenomena in PEM fuel cells, *Int. J. Hydrogen Energy*. 35 (2010) 2586–2590.
- [36] N. Fouquet, C. Doulet, C. Nouillant, G. Dauphin-Tanguy, B. Ould-Bouamama, Model based PEM fuel cell state-of-health monitoring via ac impedance measurements, *J. Power Sources*. 159 (2006) 905–913.
- [37] N. Wasterlain, PhD thesis, Probabiliste pour le diagnostic de piles à combustible de type PEM., Université de Franche Comté, 2010.
- [38] R. Petrone, PhD thesis, Electrochemical Impedance Spectroscopy for the on-board diagnosis of PEMFC via on-line identification of Equivalent Circuit Model parameters, University of Salerno - UNISA, 2014.
- [39] I. Sadli, PhD thesis, Modélisation par impédance d'une pile à combustible PEM pour utilisation en électronique de puissance, Institut national polytechnique de Lorraine, 2006.
- [40] T. Gaumont, PhD thesis, Résistance protonique d'électrodes de piles à combustible à membrane (PEMFC): effets de l'humidité et des dégradations, Université de Lorraine, 2017.
- [41] S. Laribi, K. Mammar, Y. Sahli, K. Koussa, Analysis and diagnosis of PEM fuel cell failure modes (flooding & drying) across the physical parameters of electrochemical impedance model: Using neural networks method, *Sustain. Energy Technol. Assessments*. 34 (2019) 35–42.
- [42] J. O'Rourke, M. Ramani, M. Arcak, In situ detection of anode flooding of a PEM fuel cell, *Int. J. Hydrogen Energy*. 34 (2009) 6765–6770.