



# LES of the lean-premixed PRECCINSTA burner with wall heat loss using finite-rate chemistry

**Pierre Bénard, Ghislain Lartigue, Vincent Moureau – CORIA  
Renaud Mercier – SAFRAN TECH**

Combustion-DNS Strategy & Data Analysis Workshop  
May 22-23, 2018, Sorrento, Italy

# Motivation

- **Topology of swirling flows**
  - Recirculation zones [1,2]
  - Advantages
    - ✓ Improved flame stabilization
    - ✓ Improved compactness

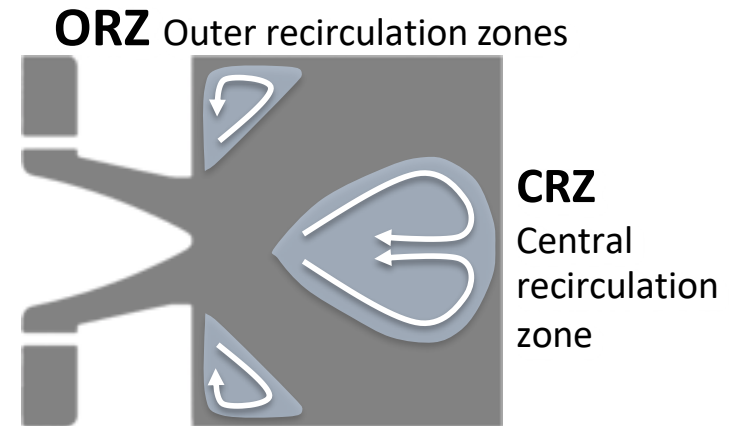

## Objectives

Better understand lean-premixed combustion in swirl burners  
Study the impact of wall heat loss using finite-rate chemistry LES

- Wall heat transfer [3]
  - May influence the ORZ
  - Affects the stabilization process
  - May lead to local flame extinction

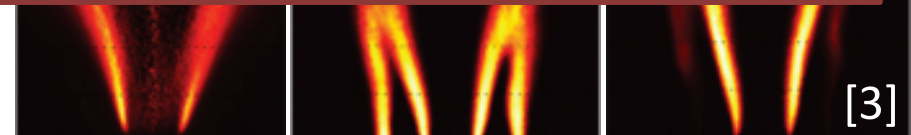

- **Chemistry models**

- Tabulated chemistry (limited parametrization) [4]
- Global chemistry (good reproduction of global parameters only) [5]
- Finite-rate chemistry [6,7]

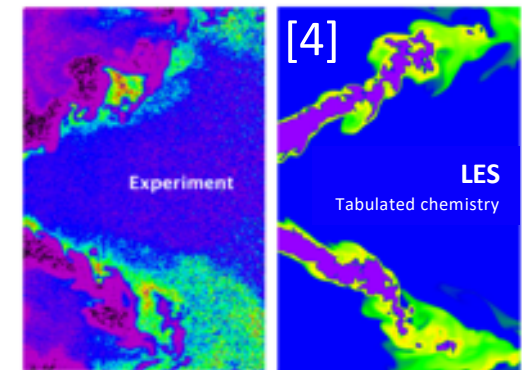

# Application

## PRECCINSTA burner

- **Experimental set-up**
  - Aeronautical swirl burner
  - Detailed experimental database [1,2]
  - Numerous numerical studies [3-6] (adiabatic)
- **Operating condition**
  - ‘quiet’ case at P=30kW

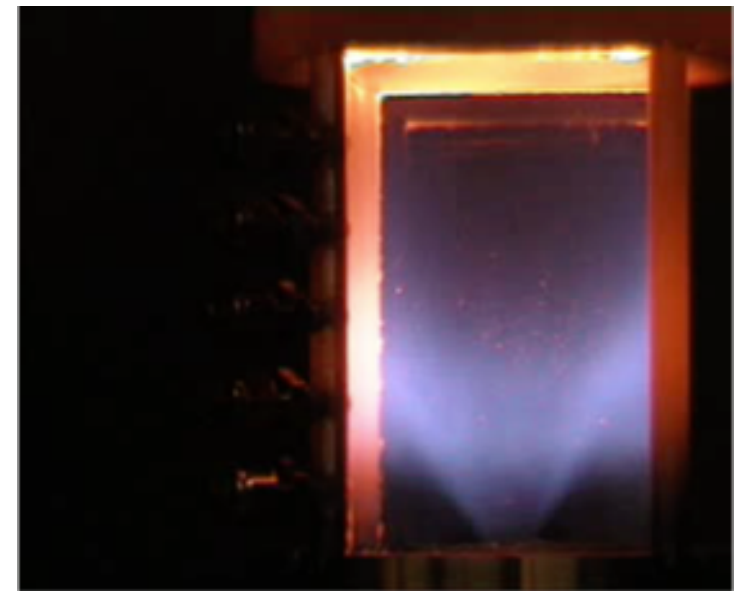

- **Numerical set-up & models**

Mesh name	1	2	3	4
#cells [million]	1.7	14	110	877
Cell size [mm]	1.2	0.6	0.3	0.15

- Chemistry: Lu17 (17 species, 73 reactions) [7]
- Turbulence: Localized Dynamic Smagorinsky model
- Flame-turbulence interaction: DTFLES model

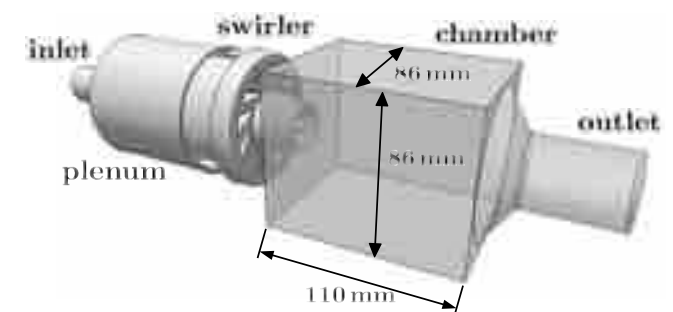

Air flow rate [g/min]	734.2
Methane flow rate [g/min]	35.9
Inlet temperature [K]	300.0
Thermal power [kW]	30.0
Equivalence ratio	0.83

# Numerical method

## LES solver



- Developed at **CORIA** and distributed in the **SUCCESS** scientific group [1,2]
- 220 users in labs and in the industry
- **3 PRACE projects**
- Features
  - **Unstructured meshes** (complex geometries) and **adaptive grid refinement**
  - **Low-Mach number Navier-Stokes equations** (incompressible and variable density)
  - Double-domain decomposition [3]
  - Highly efficient solvers for linear system inversion (PCG, DPCG)
  - **4th-order** central finite-volume method and **4th-order** time integration
  - Combustion modeling (tabulated or finite-rate chemistry, NOx prediction model, ...)
  - Two-phase flows (Lagrangian particles), spray and atomization (Levelset)
  - **Suited for massively parallel computing** (>32 000 procs)

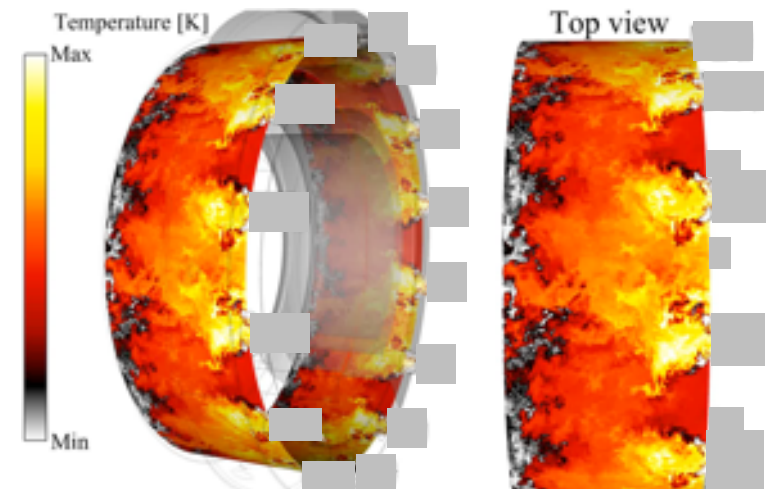
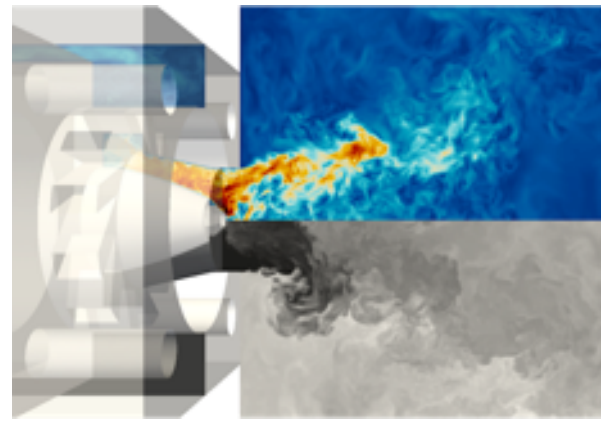
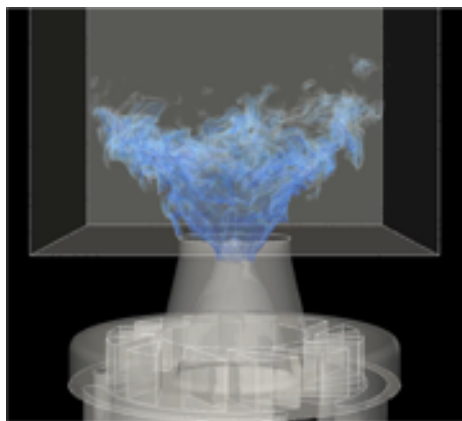



# High-performance strategy for finite-rate chemistry

$$\frac{\partial \rho Y_k}{\partial t} + \nabla \cdot \rho Y_k \mathbf{u} = \nabla \cdot (-\rho \mathbf{V}_k Y_k) + \dot{\omega}_k$$

- **Key ingredients**

Operator  
splitting

- Each phenomenon is advanced at its own characteristic time

CVODE stiff  
integrator

- Variable order and variable sub-timestep integration with analytical Jacobian

Dynamic load  
balancing

- 2-level task sharing algorithm that distributes the source term computation on all cores

- Validated with schemes up to 91 species, 700+ reactions
- Very good parallel performances up to 32'000 cores

## Results

# Adiabatic cases

- **Flame structure**
  - Isocontour  $c=0.7$

Mesh name	AD1	AD2	AD3
#cells [million]	1.7	14	110
Cell size [mm]	1.2	0.6	0.3

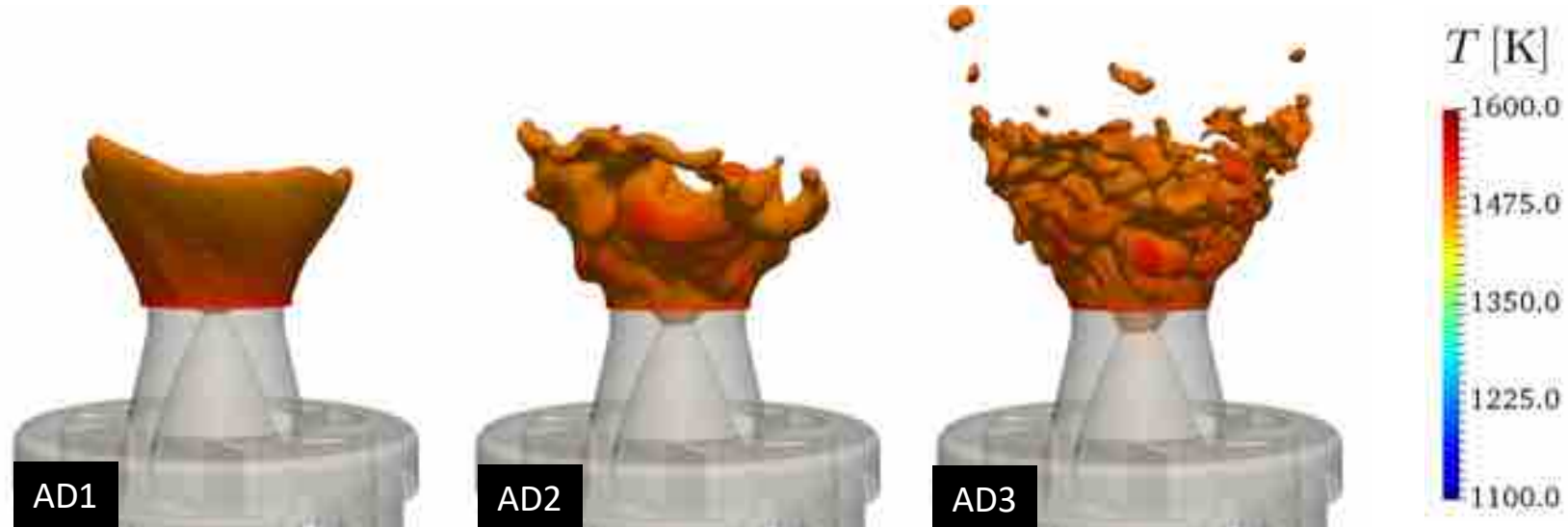

OH field

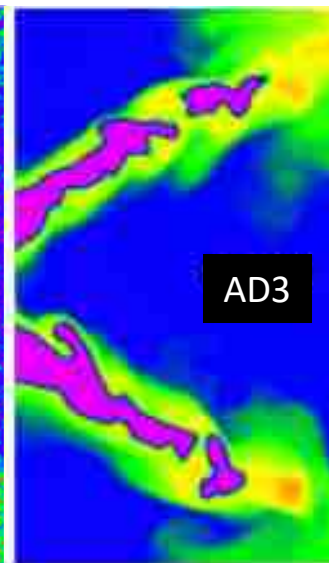
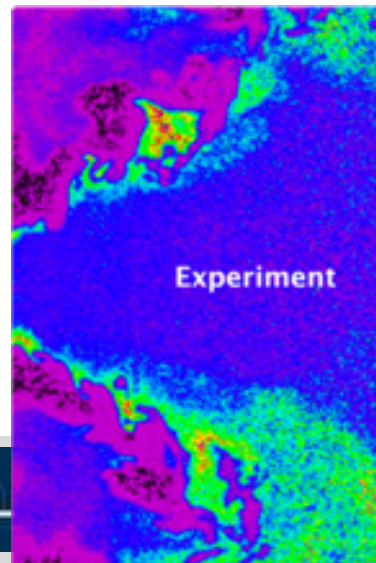

M-shape flame instead of V-shape

## Non-adiabatic condition

# Determination of the wall thermal condition

- **Trial and error process**

1. Modification of wall thermal condition
2. Convergence of LES results
3. Comparison of temperature profile to experimental data
4. Back to 1.

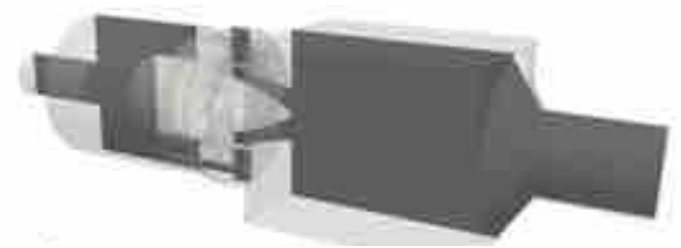

- **On 14M and 110M meshes**

- **Resulting Dirichlet condition**

- External injector wall
  - + chamber base
  - + chamber windows
- Start at  $T=300\text{K}$
- Slight rise of temperature in injector
- $T=500\text{K}$  on chamber base
- High rise up to  $1800\text{K}$  on windows
  - No heat loss in the CRZ

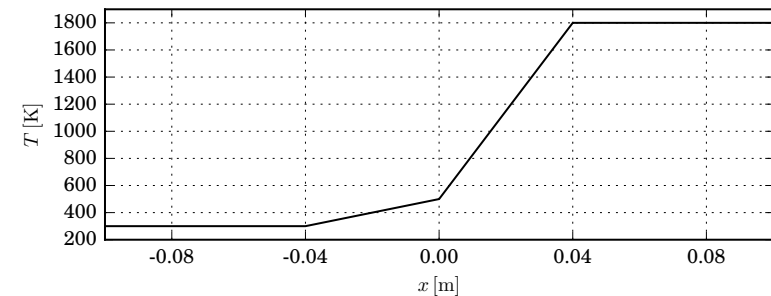
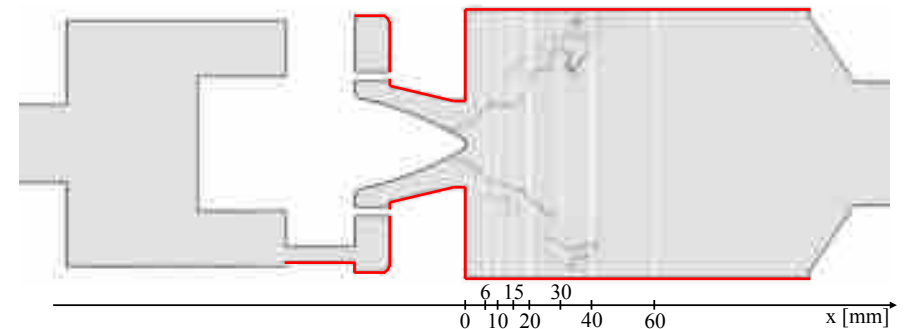

# Mesochallenge Myria 2017 @ CRIANN FIRELES PRACE project of the 15<sup>th</sup> call

Mesh #4, 877M cells

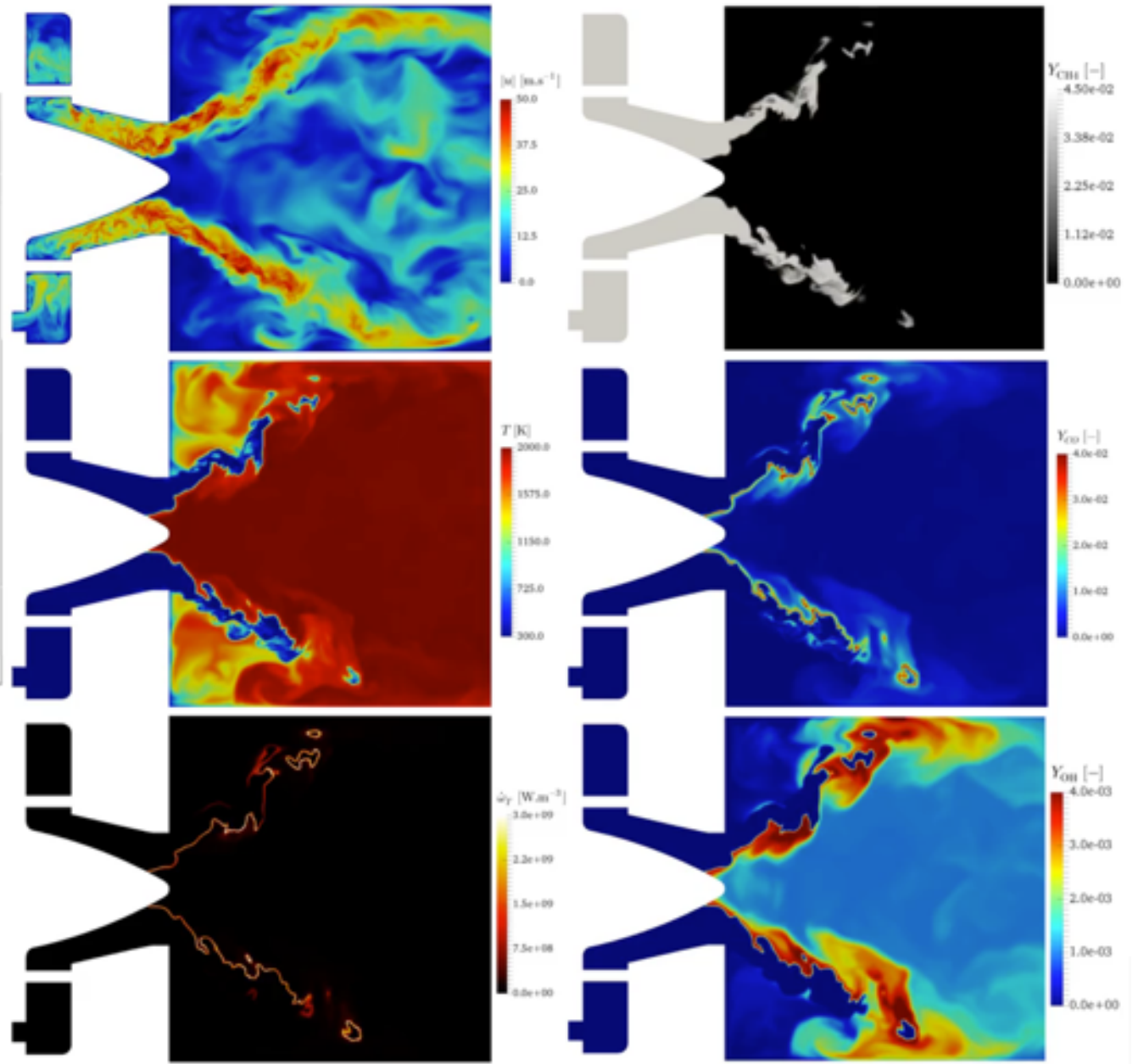



## Results

# Non-adiabatic cases

- Flame structure

  - Isocontour  $c=0.7$

Mesh name	1	2	3	4
#cells [million]	1.7	14	110	877
Cell size [mm]	1.2	0.6	0.3	0.15
Heat loss/Total HR [%]	3.4	6.1	6.5	6.0

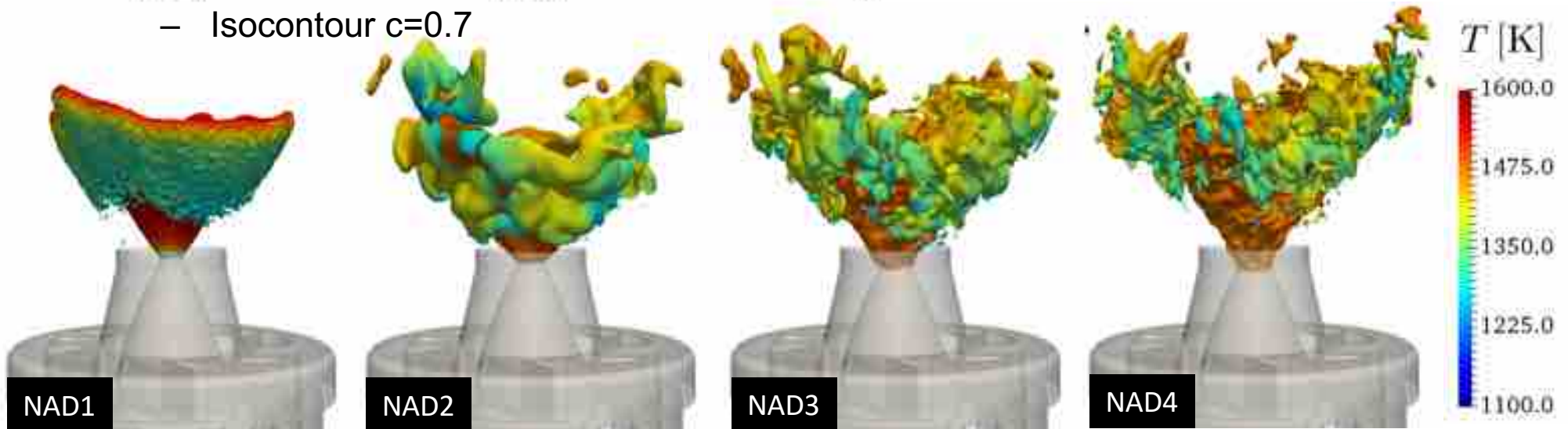

Extinction of external flame => V-shape flame

OH field

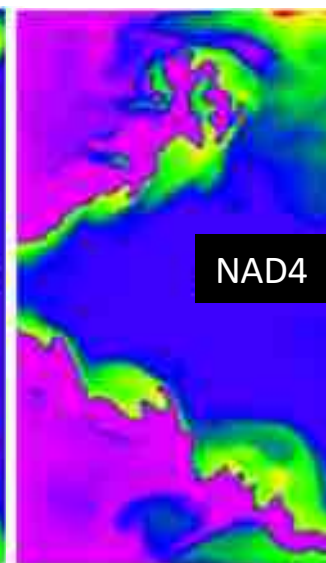
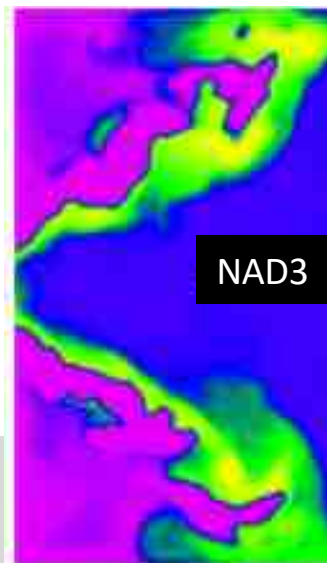
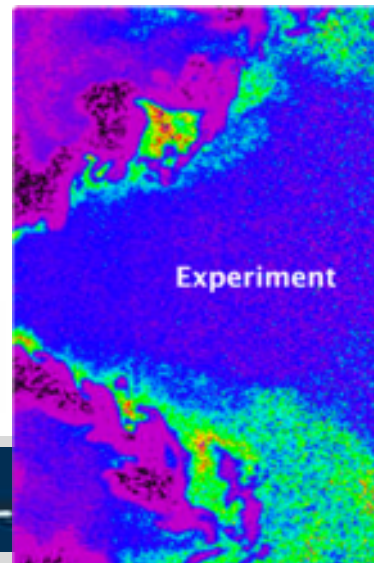



# Results

## Profiles comparison

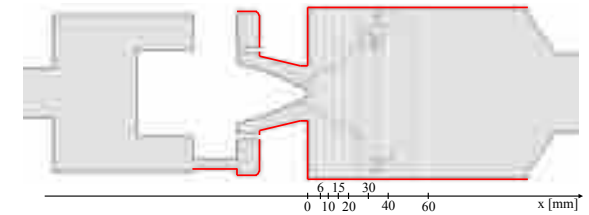

- Mean and RMS temperature

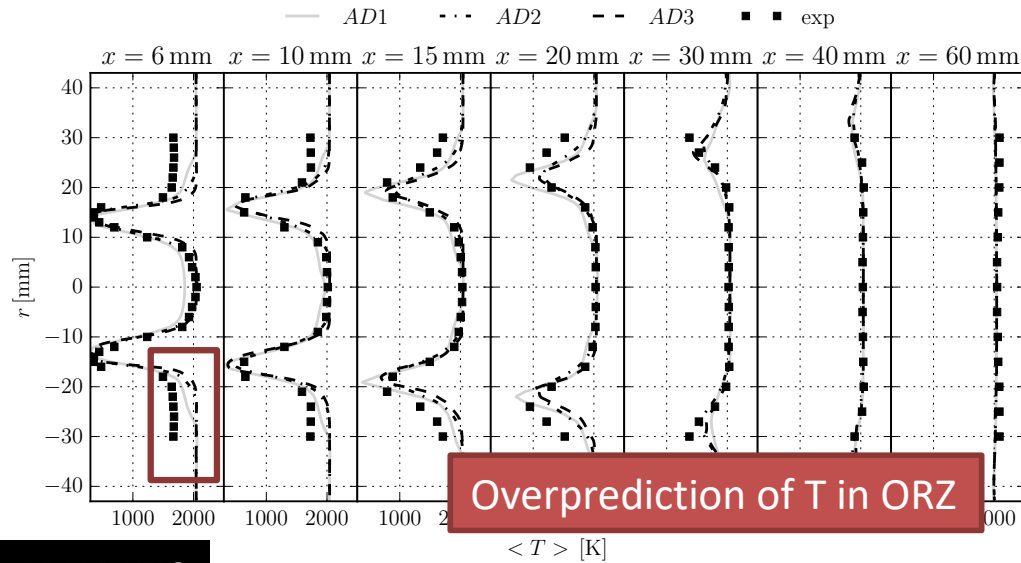

**ADIABATIC**

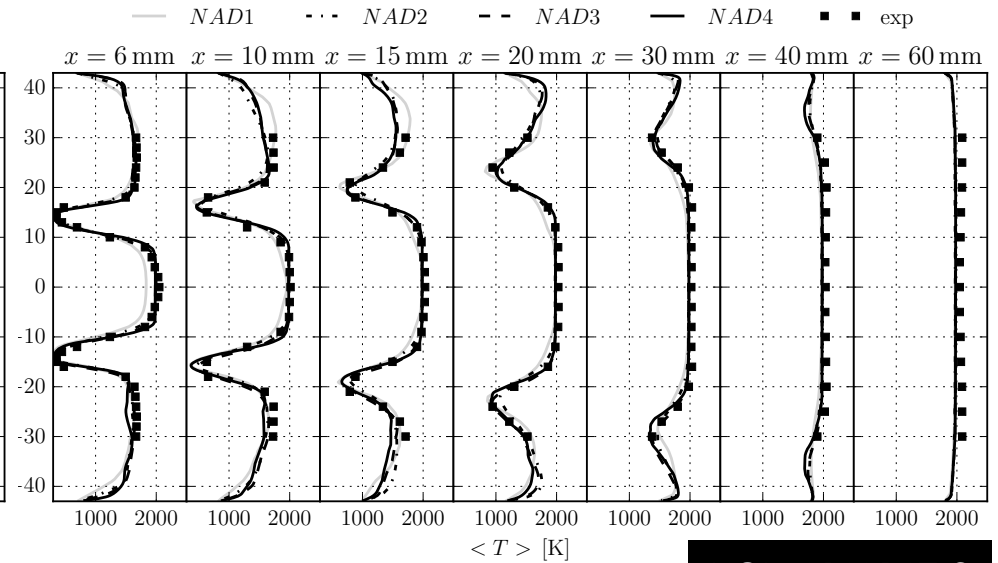

**NON-ADIABATIC**

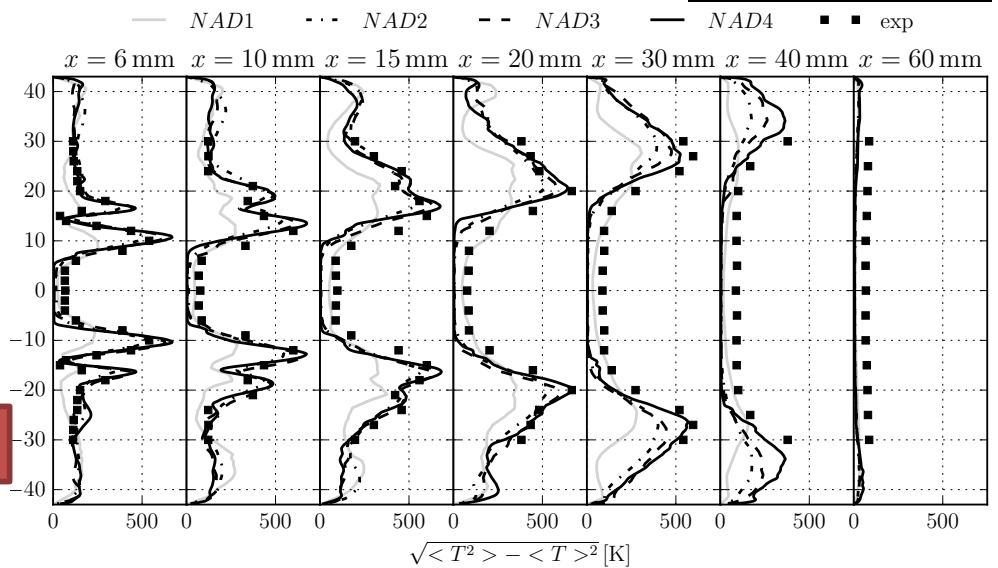
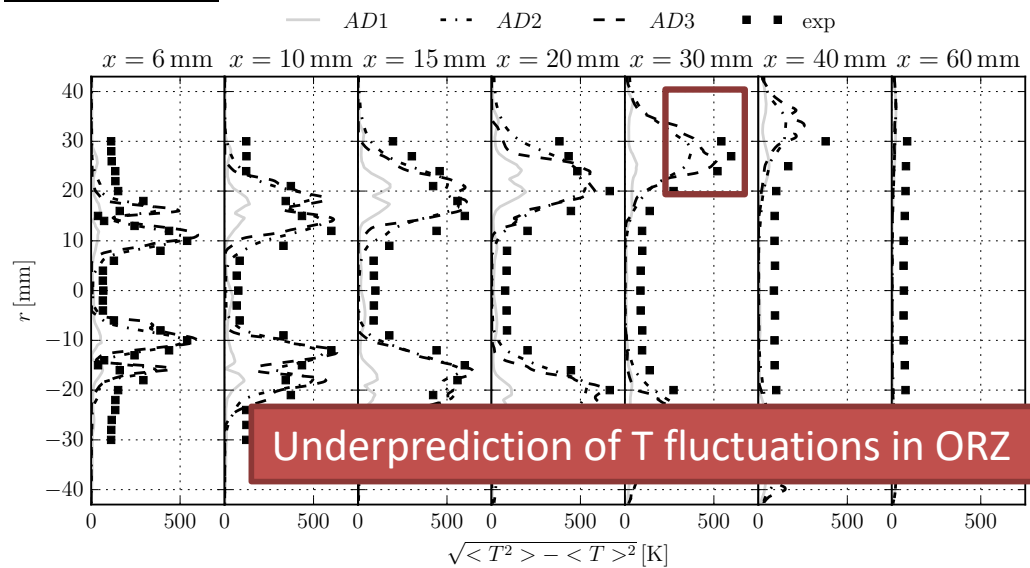

## Results

# Profiles comparison

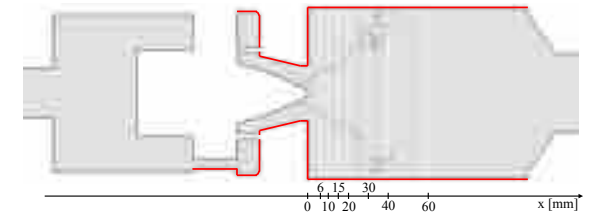

- Mean and RMS temperature

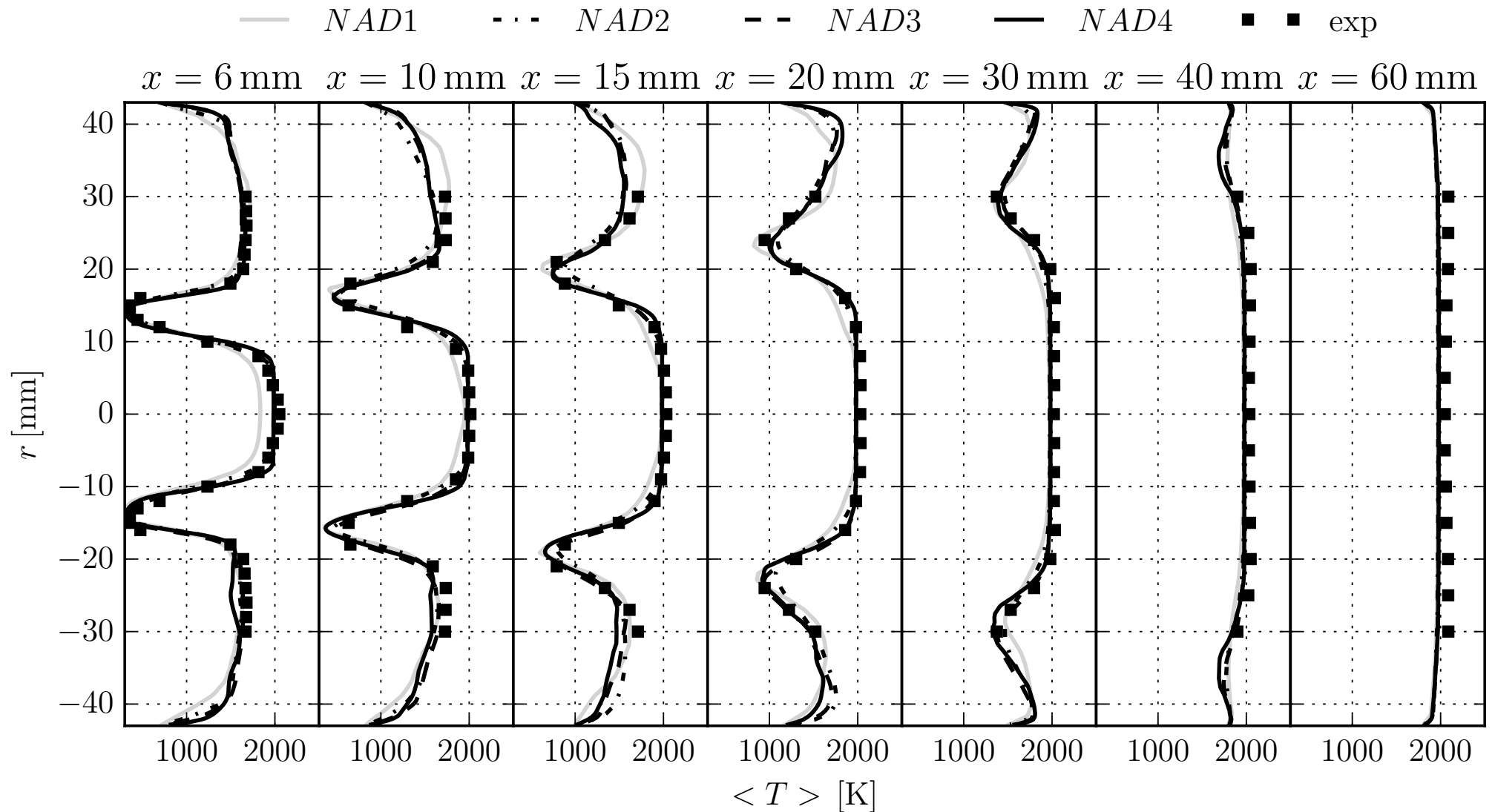

# Results

## Profiles comparison

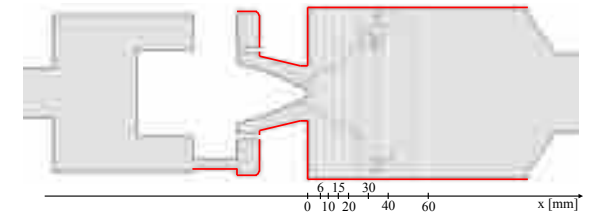

- Mean and RMS CO<sub>2</sub> mass fraction

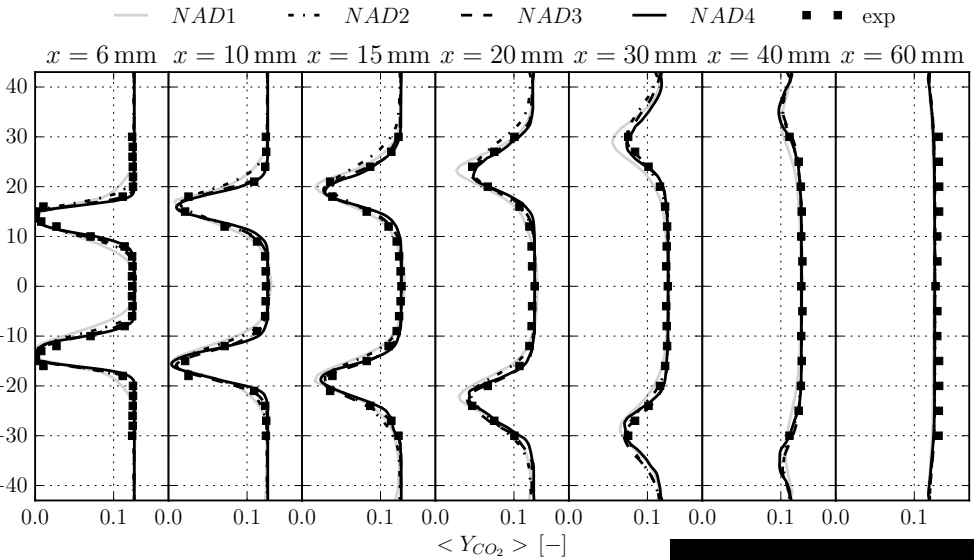
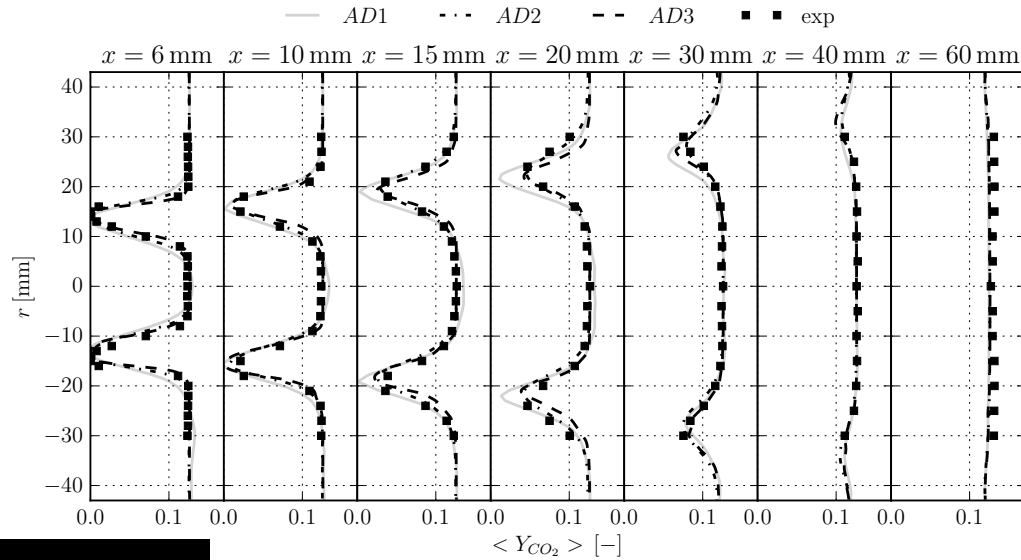

**ADIABATIC**

**NON-ADIABATIC**

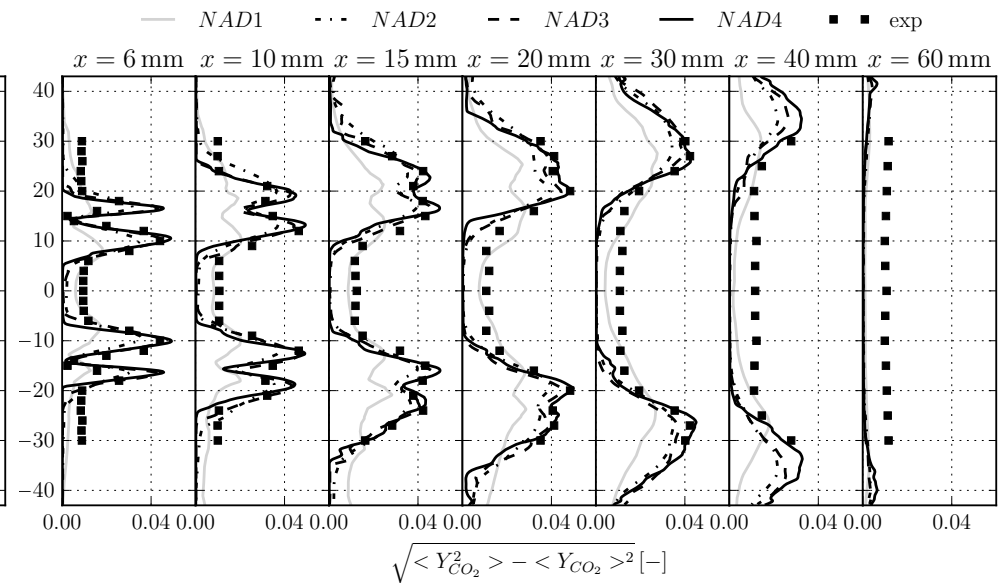
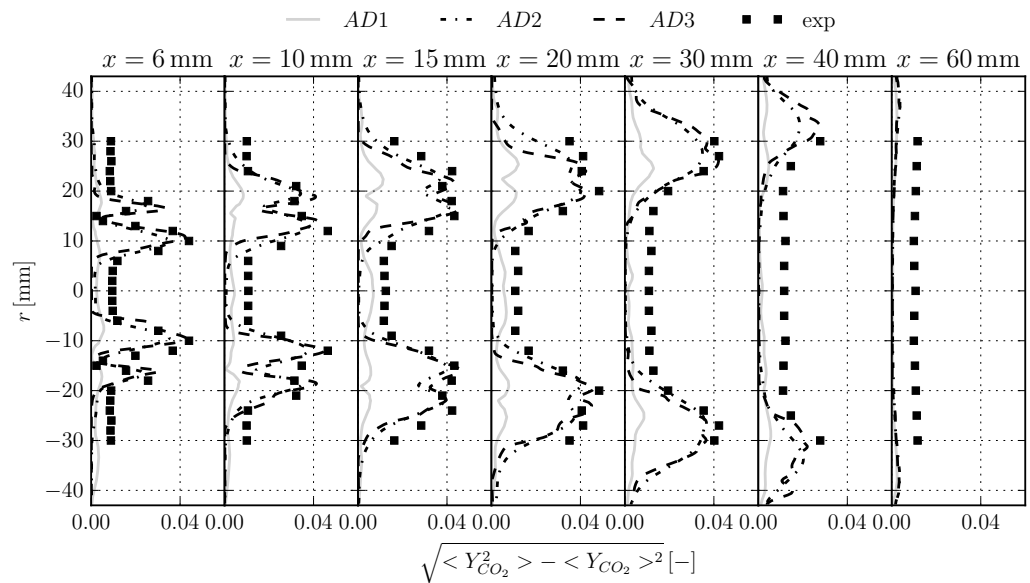

# Results

## Profiles comparison

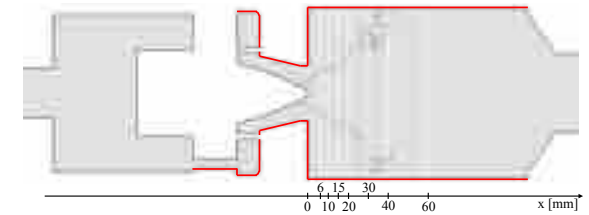

- Mean and RMS CO mass fraction

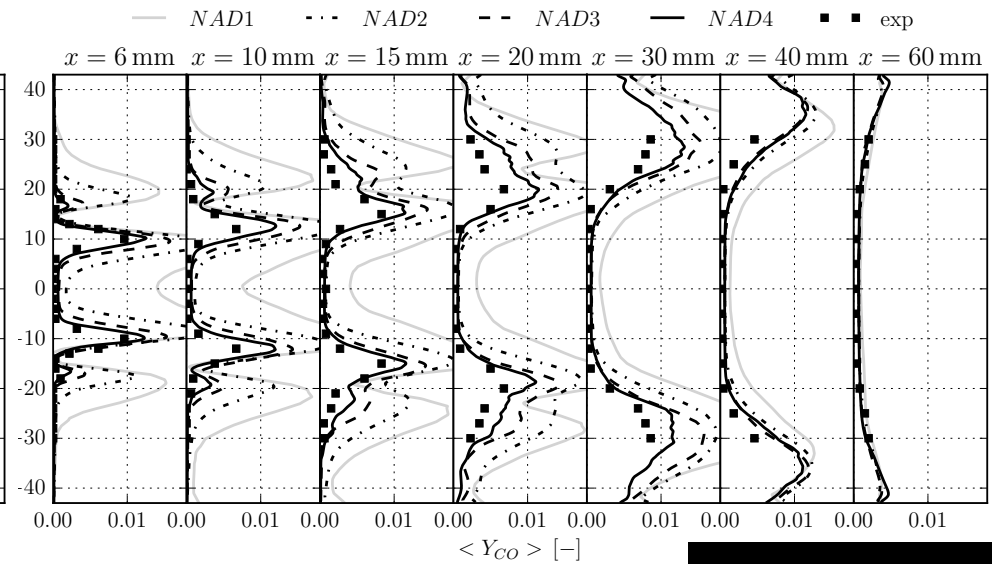
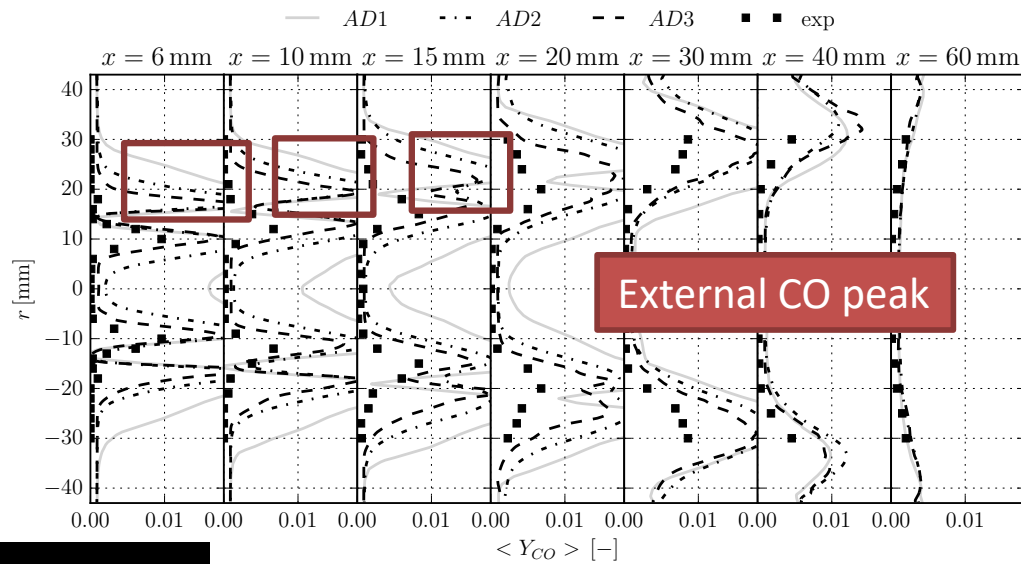

**ADIABATIC**

**NON-ADIABATIC**

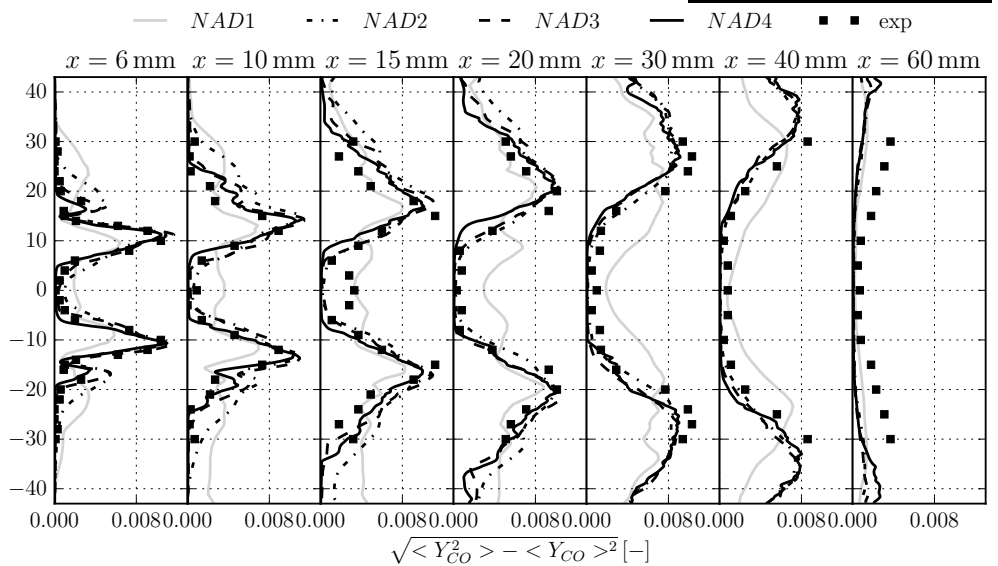
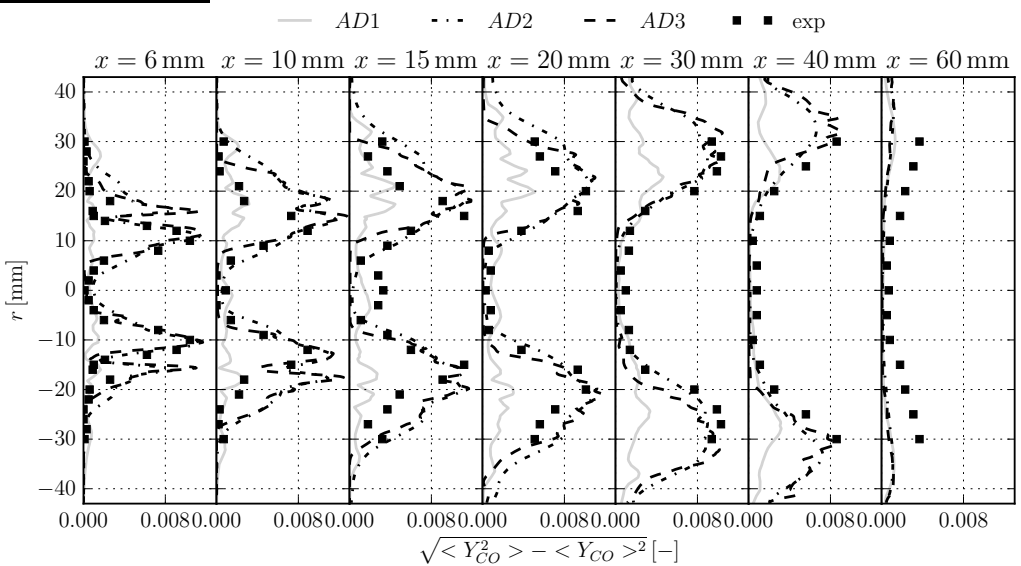

## Results

# Profiles comparison

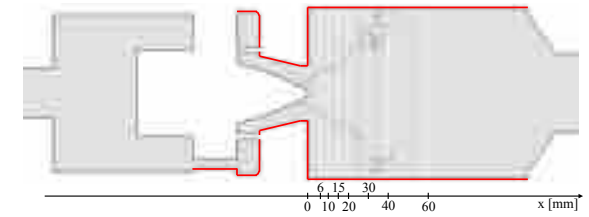

- Mean and RMS CO mass fraction

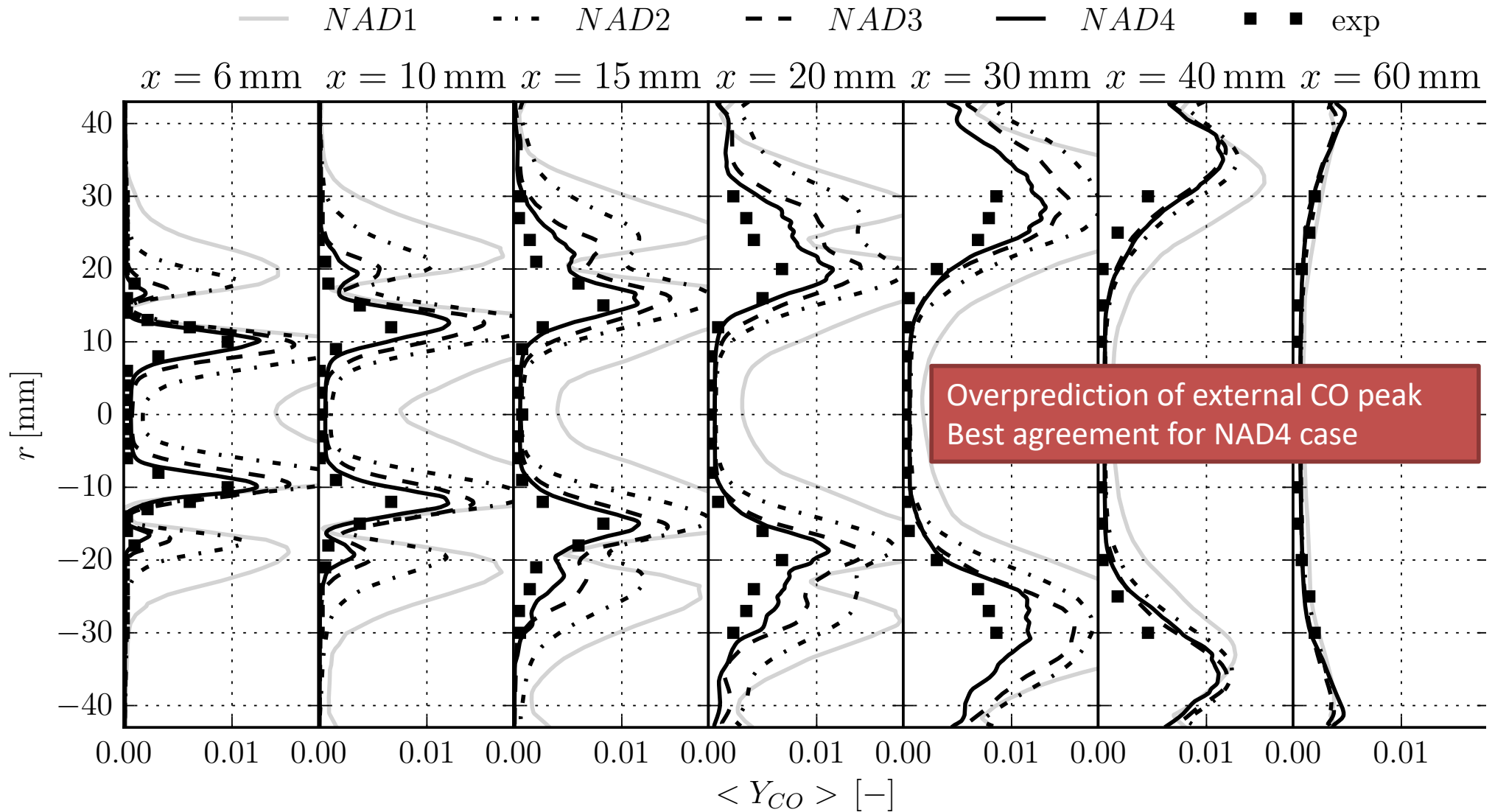



## Results

# Analysis of external flame extinction process

- Enthalpy defect on NAD4 case

$$\Delta H = H - H_{ad}$$

local total enthalpy

total enthalpy of the adiabatic mixture

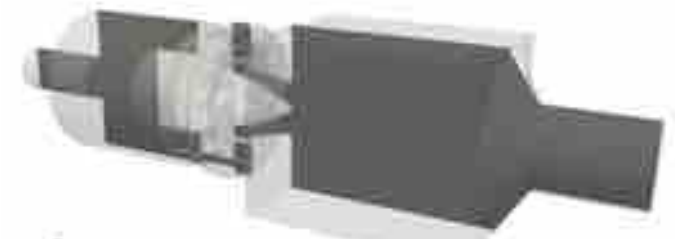

Enthalpy defect is promoted by the high residence time in the ORZ => Higher sensitivity to stretch

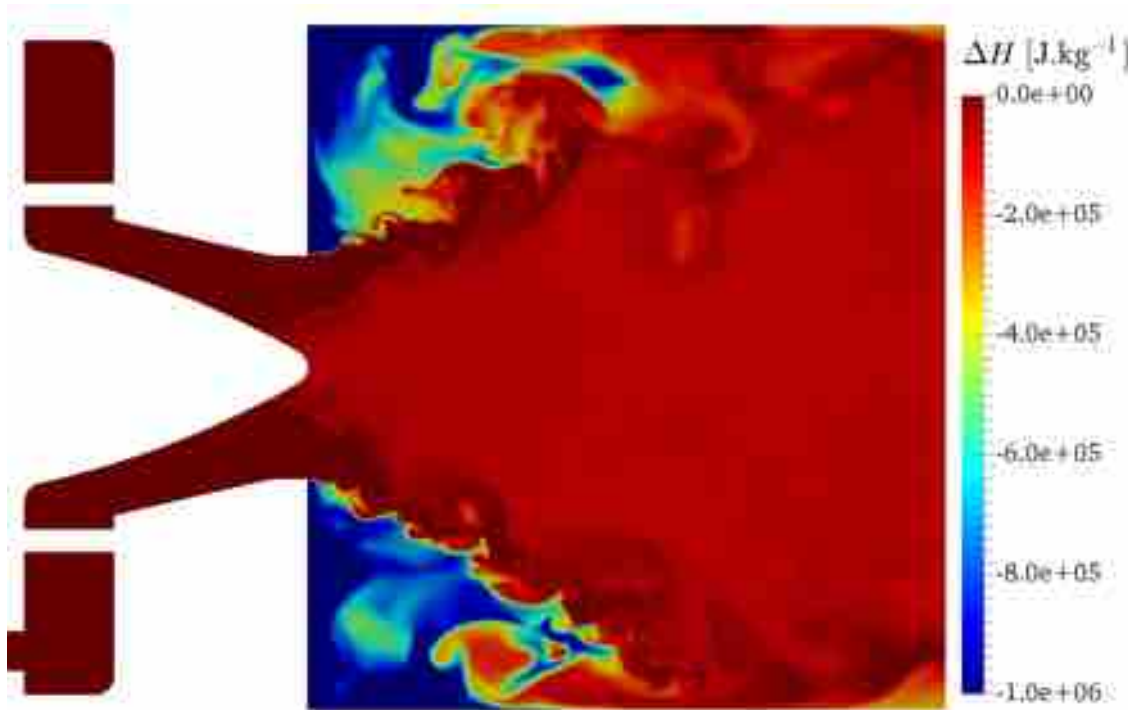

Impact of heat loss on 1D stretched flames

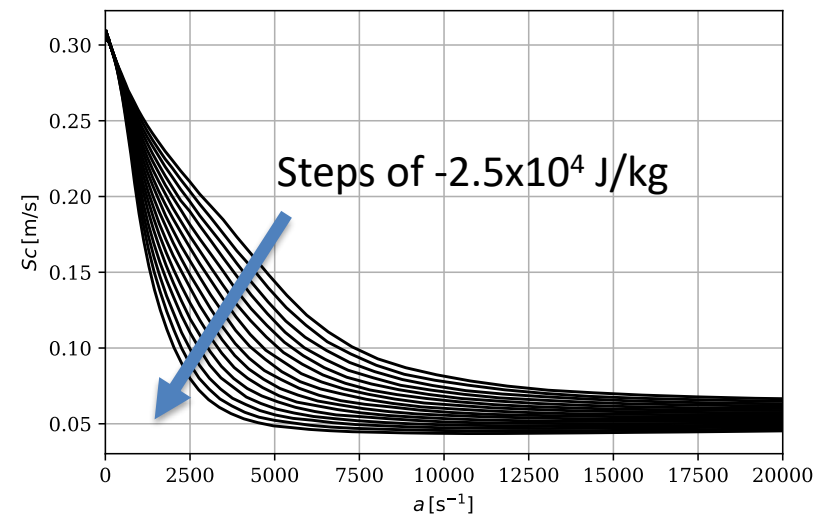

## Results

# Analysis of external flame extinction process

- Scatter plot of points with  $0.75 < c < 0.8$  for case NAD4

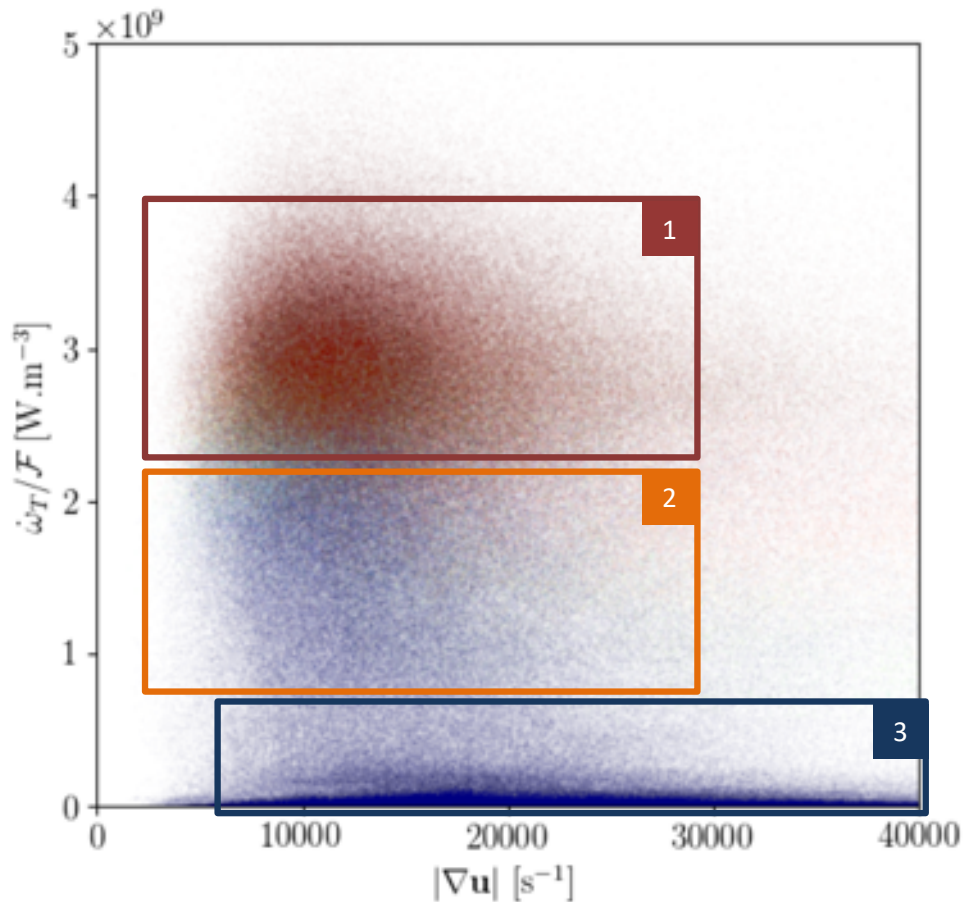

### ZONE 1

- High heat release and adiabatic  
→ Internal flame front

### ZONE 2

- Moderate heat release, high enthalpy defect  
→ Reactive outer flame

### ZONE 3

- High enthalpy defect and no reaction  
→ Quenched outer branch

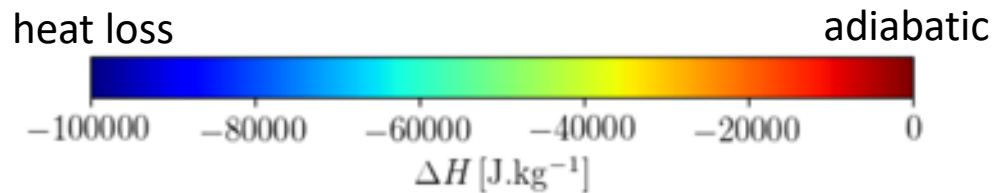
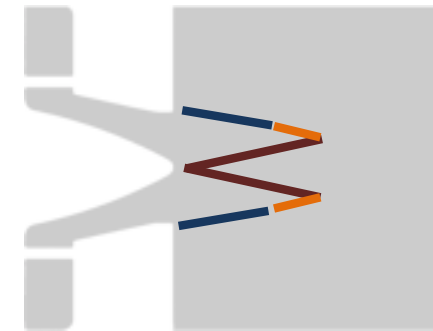

The enthalpy defect decreases the resistance of premixed flame front to high stretch rates.

# When can we expect DNS of lab-scale burners?

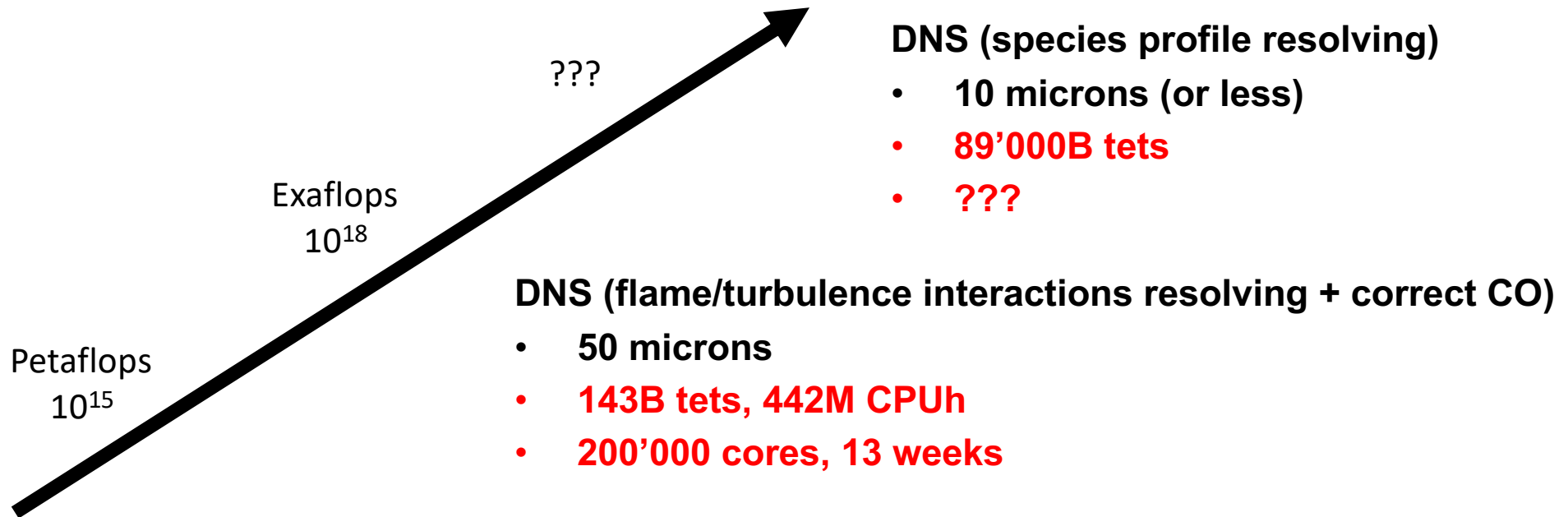

## Present LES

- 17 species, 72 reactions
- 150 microns
- **878M tets, 4M CPUh**
- **4'000 cores, 4 weeks**

Can we reach DNS faster ?

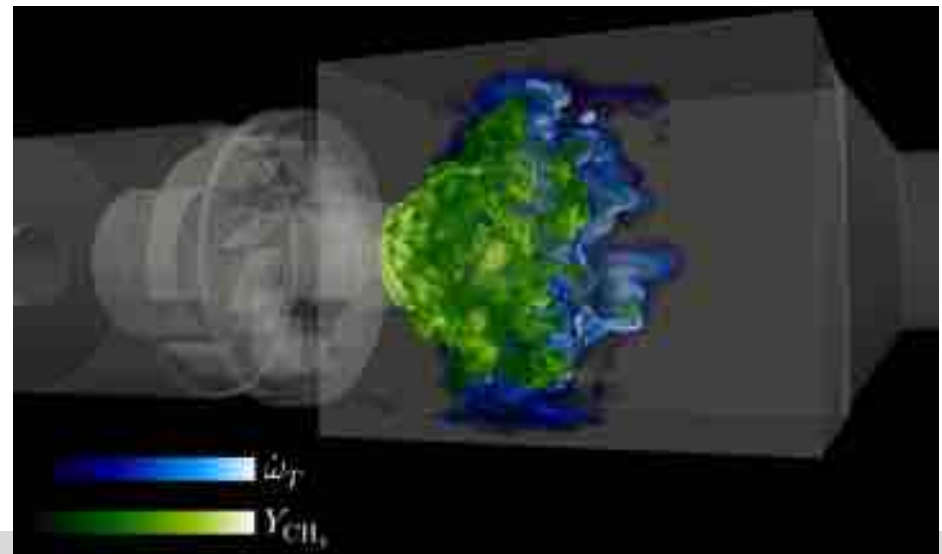





## Dynamic h-adaptation of a premixed flame

- F-TACLES combustion model [1], refinement ratio = 6
- H-adaptation performed with the MMG library from INRIA
- More details in Bénard et al., IJNMF, 2015

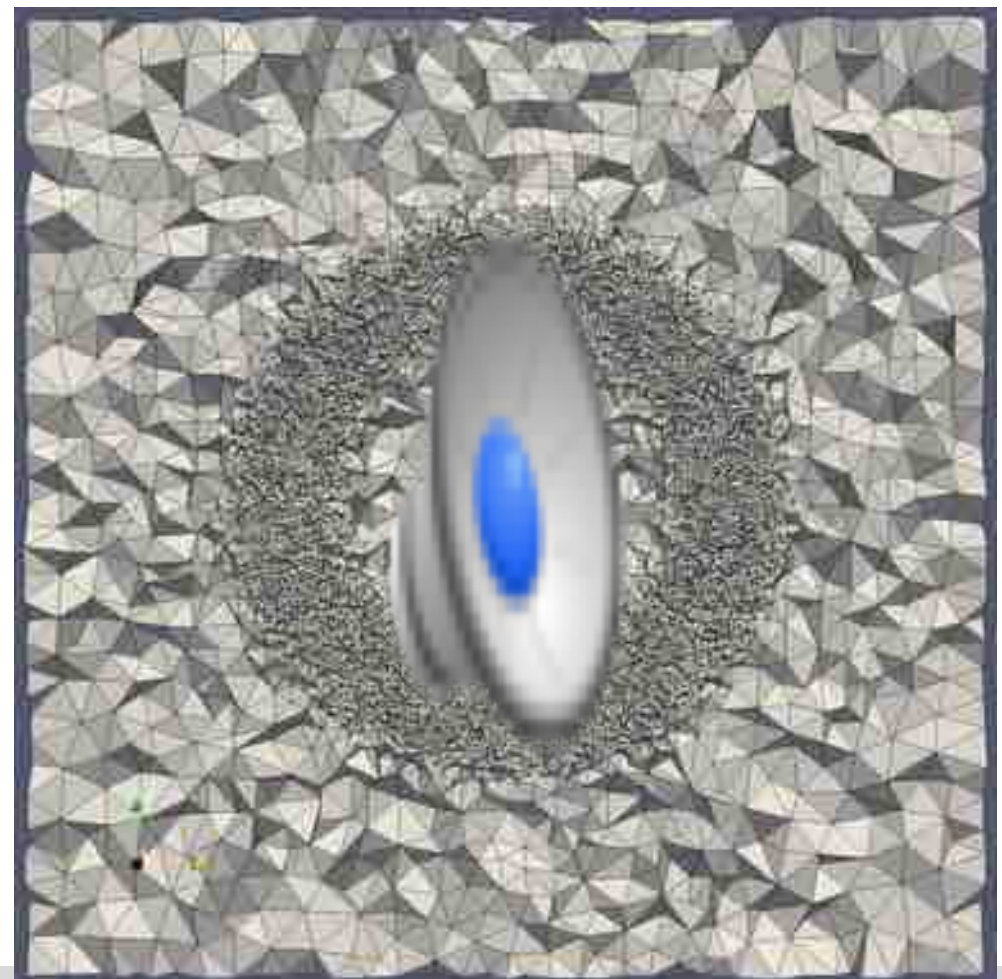
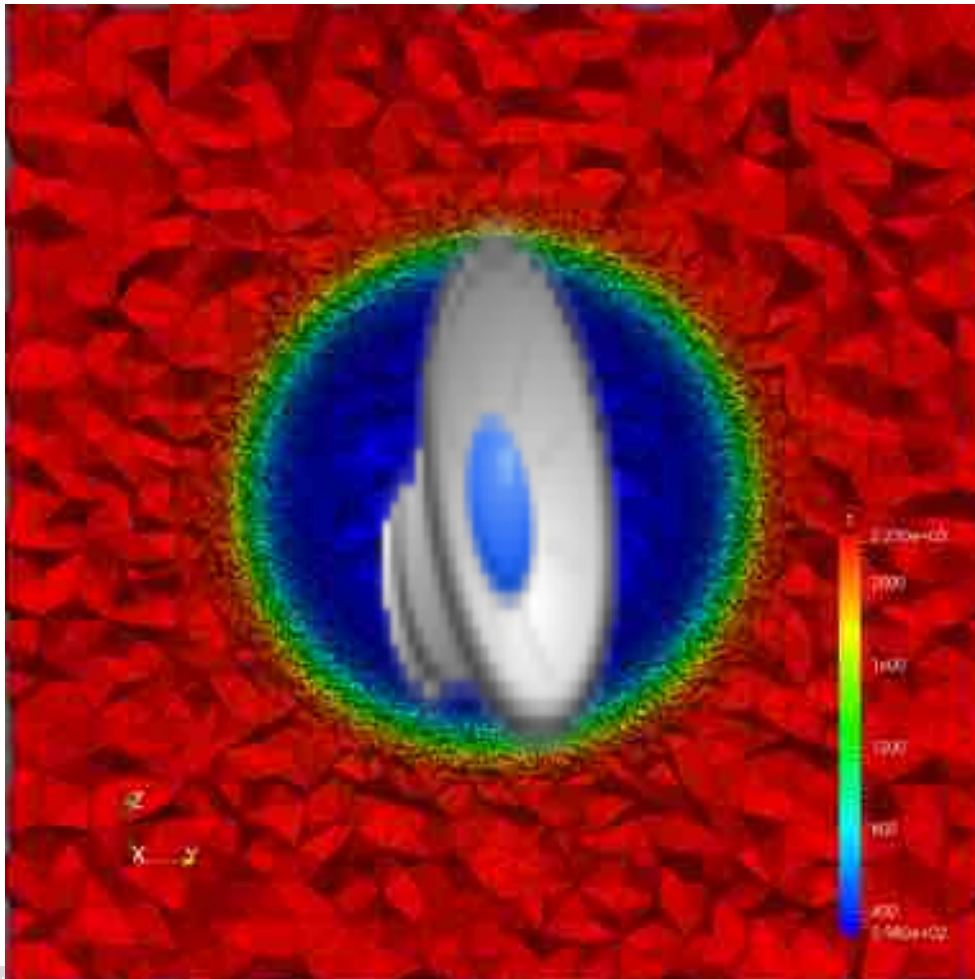

# Application: Ignition in a SAFRAN HE combustor

- **SAFRAN Tech simulation (R. Mercier)**
- **F-TACLES model with variable filter width**
- **Iso-temperature at 1300K colored by vorticity**
- **Parameters**
  - Refinement ratio = 5
  - 41M to 75M tets
  - Physical duration = 0.3 ms
  - 5h on 512 Cobalt cores
  - 1 adaptation every 15 iter.
  - 1 adaptation = 4 minutes
  - Adaptation cost = 50%

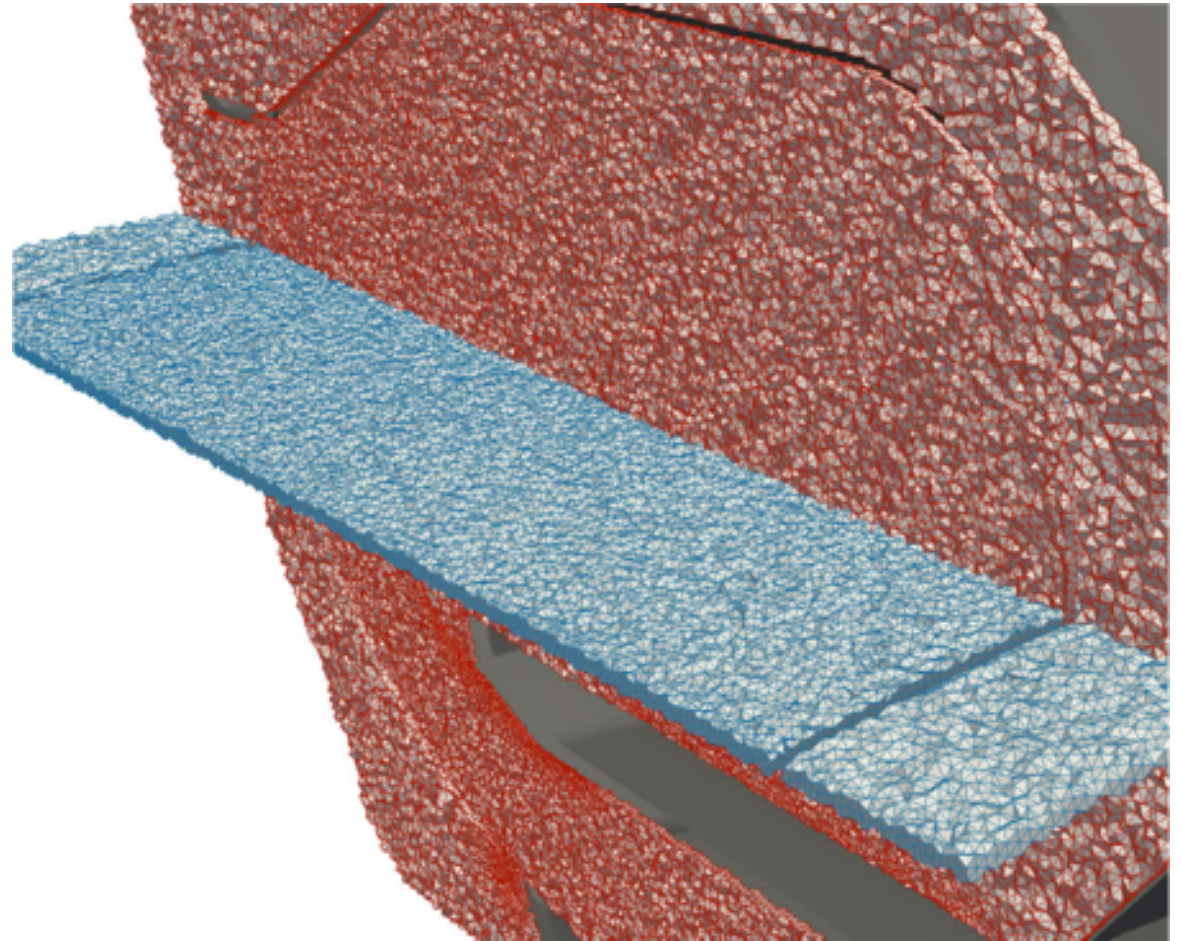

**On-going simulations with periodic dynamic remeshing by G. Vaudor**



# Application: primary atomization of a jet-in-cross-flow

- Kerosene jet in air at 10 bar

10 microns at the interface

Up to 600M cells

Up to 10k Broadwell cores

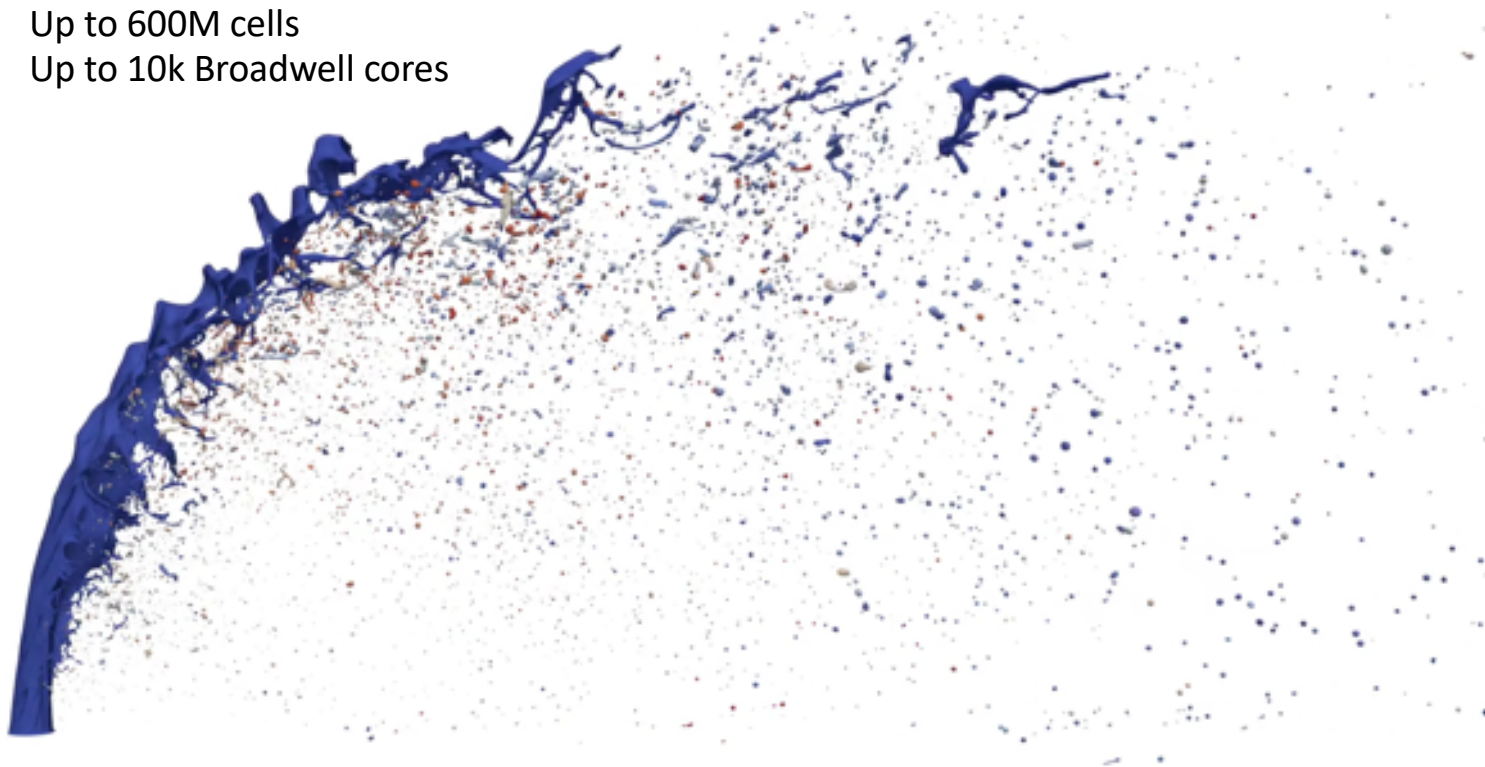

Dynamic mesh adaptation of a kerosene jet in cross flow. J. Leparoux, H. Musaefendic, R. Mercier, V. Moureau, accepted to ICLASS 2018, Chicago.

Ragucci et al. 2007  
Atomization & Sprays

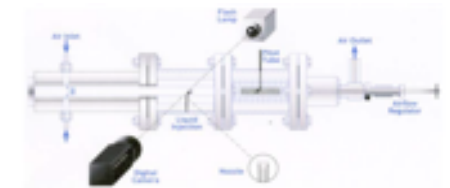
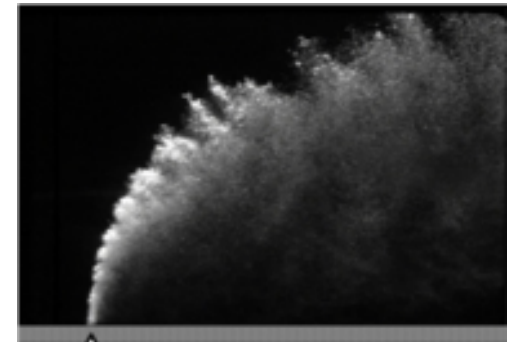

- Injector diameter:  $D=0.5$  mm
- Flow section: 25 mm x 25 mm
- **Pressure: 10 bars**
- $V_{air} = 37$  m/s and  $V_{kerosene} = 17$  m/s
- $Re_{air} = 590$  287 and  $Re_{kerosene} = 4477$
- $We_{aero} = \rho_{air} V_{kero}^2 D / \sigma = 63.5$
- $q = \rho_{kero} V_{kero}^2 / \rho_{air} V_{air}^2 = 14.2$

# Primary atomization in a SAFRAN Aircraft Engines injector

- Pressure-swirl atomizer
- Simulation includes the full injector geometry

## Parameters

Kerosene/Air @  $P_0$

33 to 390 Mcells

$\Delta x_{\min} = 4.4$  to  $15 \mu\text{m}$

180h on 1120 cores

Cobalt @ TGCC

Adaptation cost: 50%

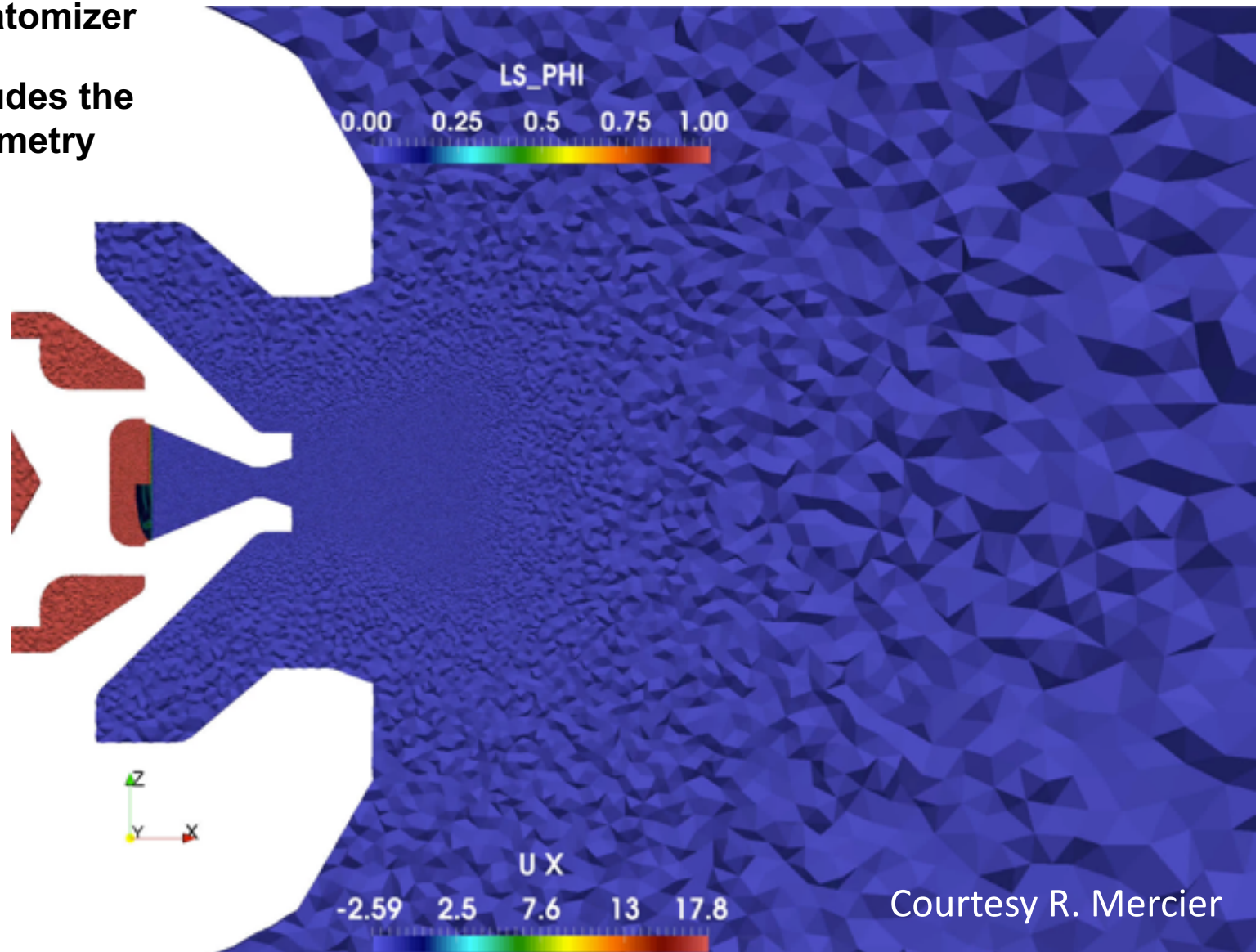



# Conclusions

- **Finite-rate chemistry at high-res is now feasible in complex burners**
- **PRECCINSTA simulations are the closest to experiments to date**
- **FIRELES PRACE project**
  - 23.5 million of CPU hours on Curie and Irene at TGCC, CEA
  - Dynamic mesh adaptation with finite-rate chemistry (GRIMech)
    - Up to 50 microns in flame front
  - More detailed analysis of external flame extinction process
- **Dynamic mesh adaptation is an option to reach higher resolutions**
  - Surface adaptation is in the work

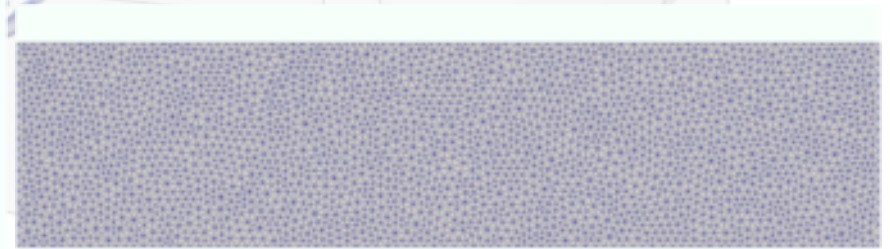
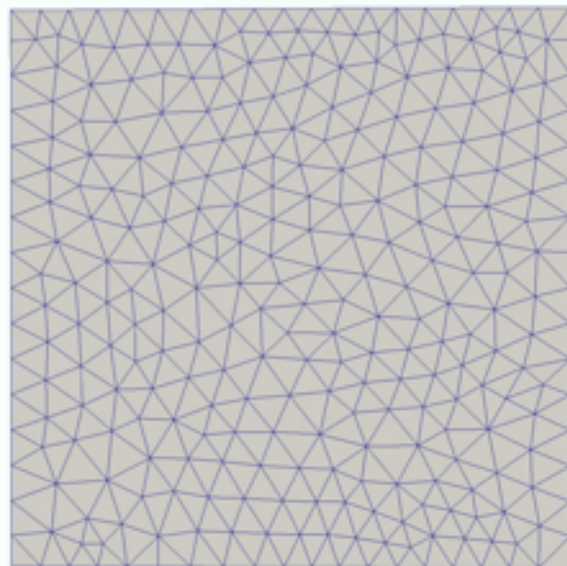
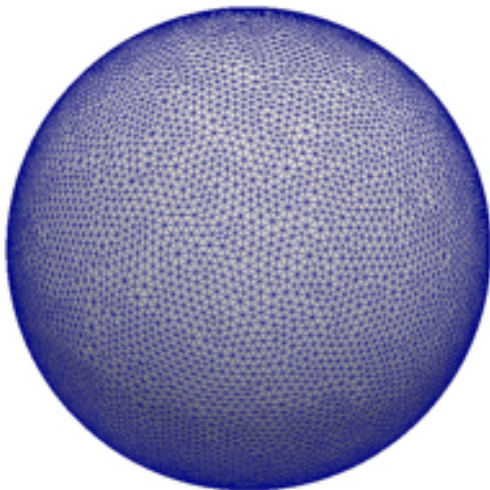

# Acknowledgments

- **PhDs and postdocs:** Geoffroy, Lancelot, Hakim, Nicolas, Yann, Patricia, Francesco, Félix, ...
- **R. Mercier - SAFRAN Tech**
- **C. Dobrzynski, A. Froehly - INRIA Bordeaux**
- **A. Pushkarev, G. Balarac - LEGI**

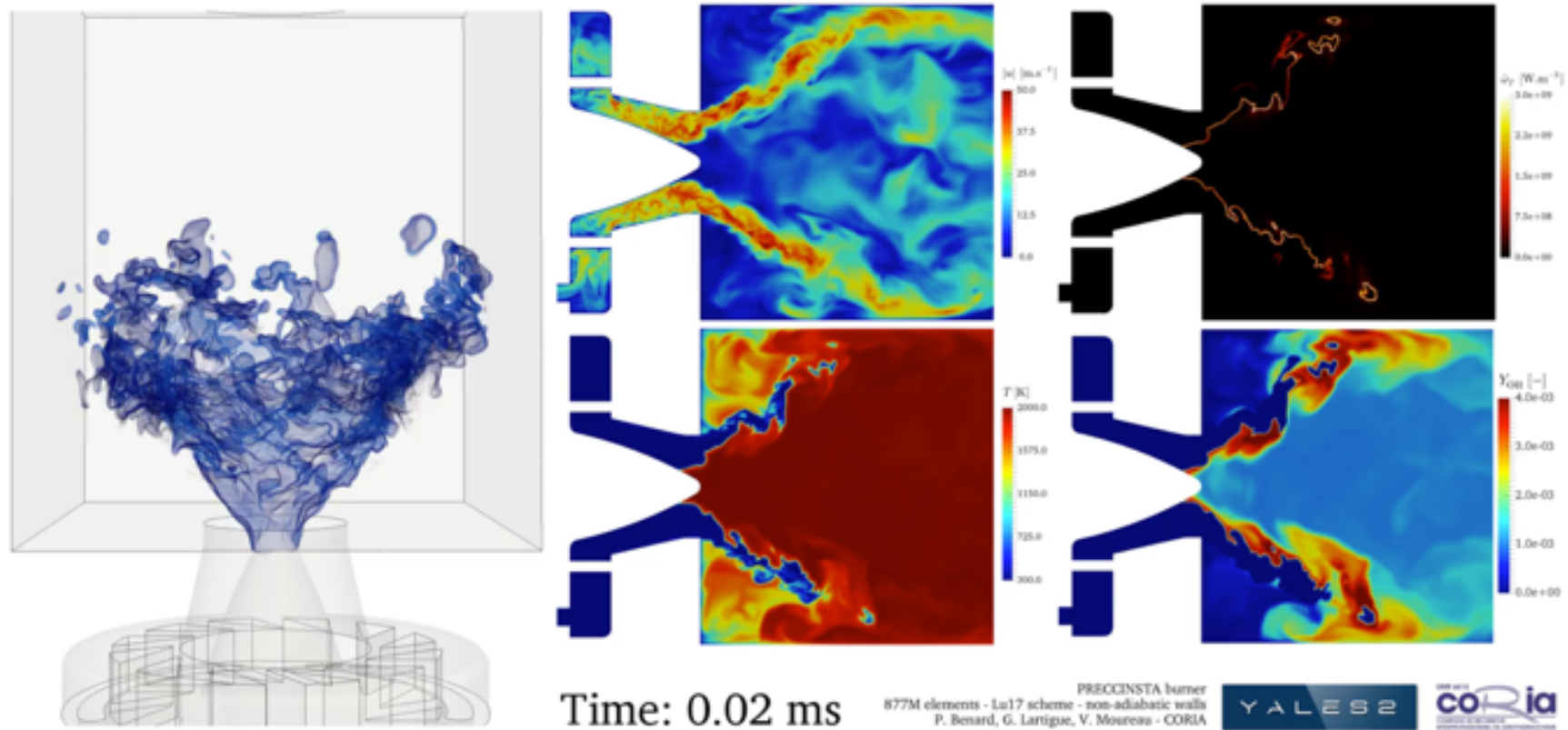

# BACK-UP



# Outline

- Motivation
- Flow solver
- Modeling of turbulent premixed combustion with finite-rate chemistry
  - The PRECCINSTA burner
  - Results for the adiabatic case
  - Results for the non-adiabatic case
- Towards DNS of the PRECCINSTA burner
  - Dynamic mesh adaptation for propagating fronts and interfaces

# Towards optimal and user-independent LES of aeronautical burners

- Courtesy R. Mercier, SAFRAN TECH

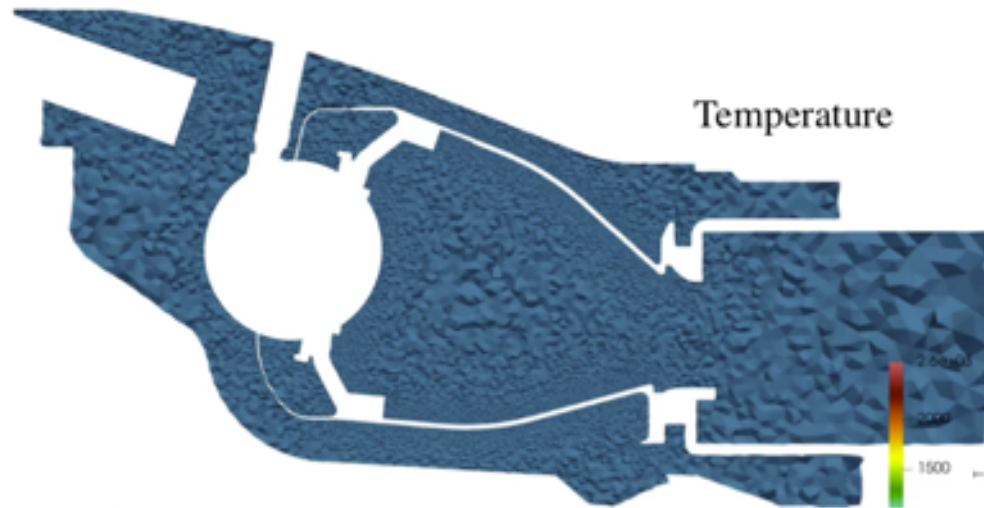

- **Proof of Concept  
Safran combustion chamber**

- Return time : 3 days (versus 13 days)
- Embedded run scenario management : (initialization, fuel injection, ignition, stabilization,...)
- Automatic mesh convergence
- User-specified CPU budget

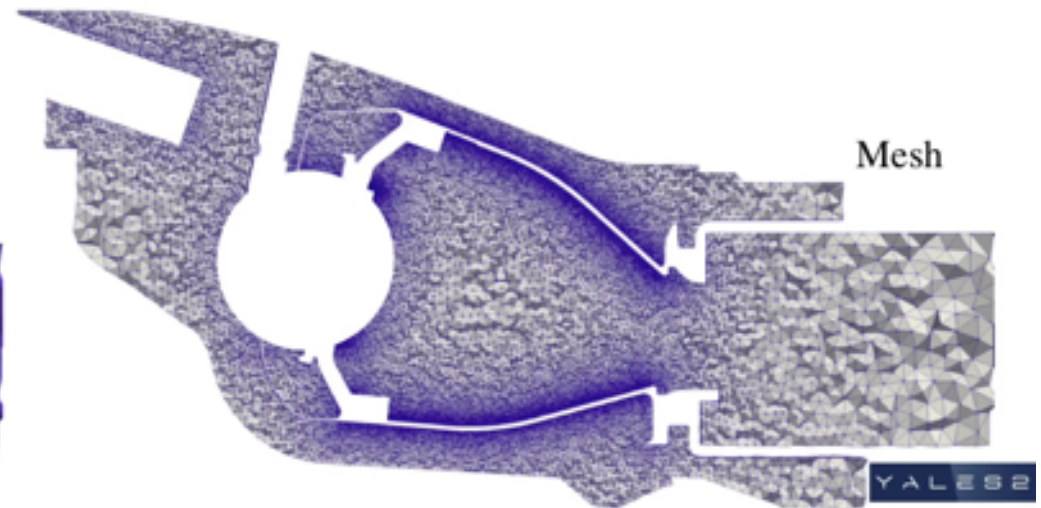
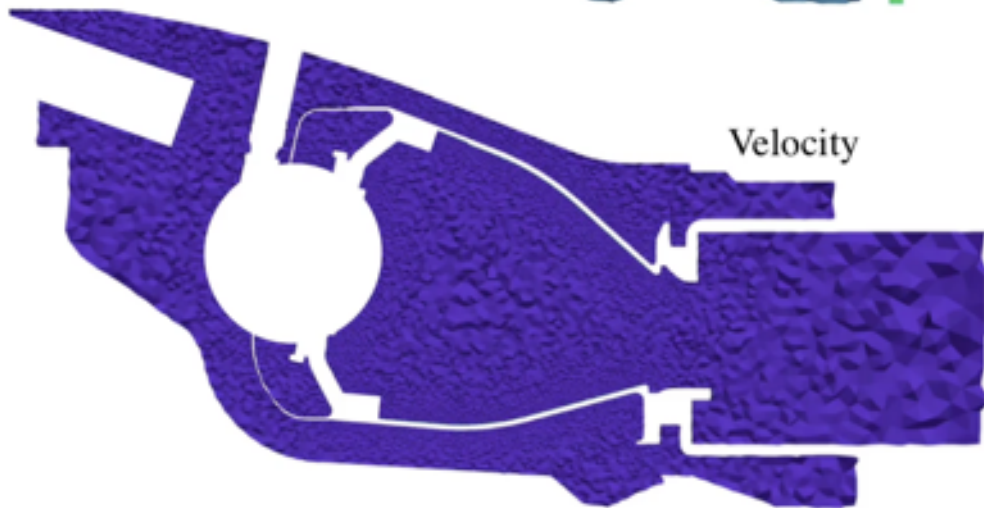

# Motivation

- **Turbulent combustion modeling in realistic devices is highly challenging**
  - Unsteady, multi-scale and multi-physics flow
  - Complex geometry
- **Large-Eddy Simulation (LES) is a powerful tool for the modeling of the physics in aeronautical engines**

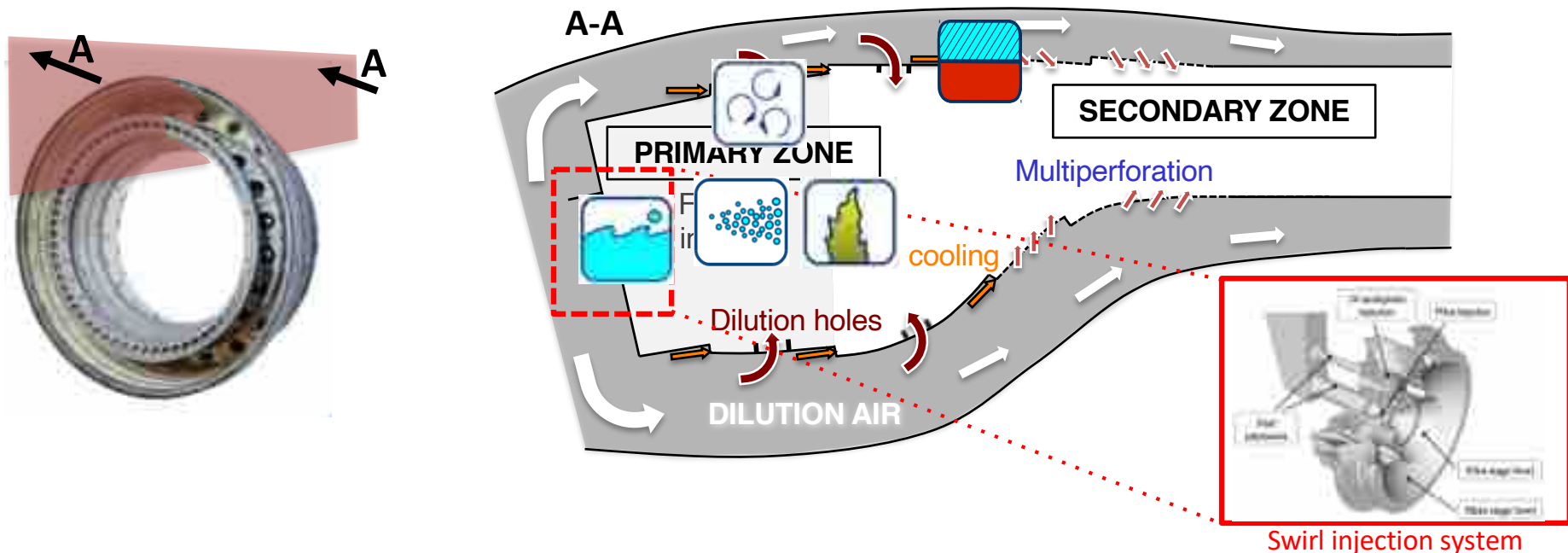

- **Goal: better prediction of pollutant emissions**

## Results

# Non-adiabatic cases

- Flame structure

– Isocontour  $c=0.7$

Mesh name	NAD1	NAD2	NAD3
#cells [million]	1.7	14	110
Cell size [mm]	1.2	0.6	0.3

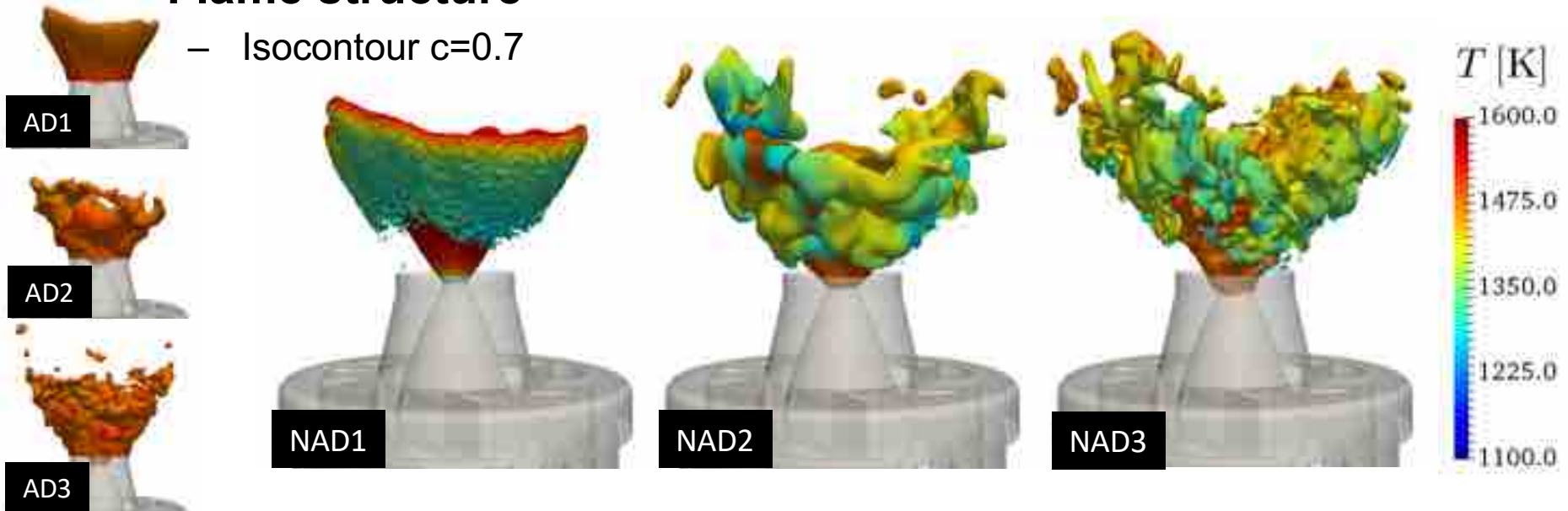

## OH field

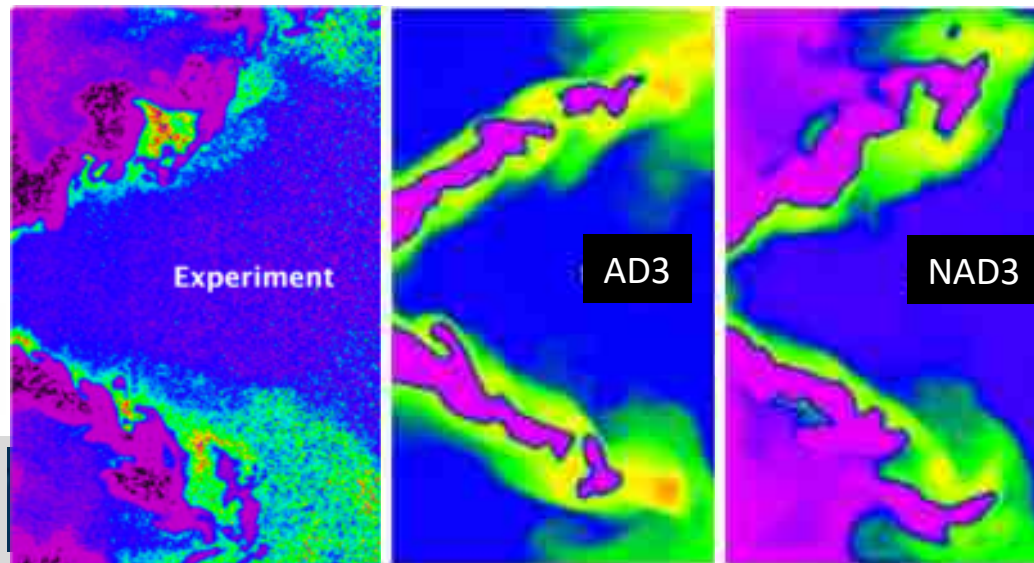

Lifted external flame  
Lower temperature in  
flame front





# Mesochallenge Myria 2017 @ CRIANN

- **Objective**
  - Get a reference solution for the non-adiabatic case => NAD4
- **Increased grid resolution**
  - To have a better description of flame-turbulence interaction
  - To reduce the influence of sub-grid scale models on CO production

## Mesochallenge Myria 2017 – July 2017

- 9.2 ms physical time
- 900'000 hCPU (8 days on 4992 cores)

Mesh name	1	2	3	4
#cells [million]	1.7	14	110	877
Cell size [mm]	1.2	0.6	0.3	0.15

- **Performances**

Portion du solveur	Part de la boucle temporelle [%]	RCT [ $\mu\text{s}/\text{noeud}/\text{iteration} * N_{\text{proc}}$ ]
Advection	0.78	6.5
Implicit diffusion	3.41	28.7
Pressure correction	8.48	71.2
Scalar advection	9.26	77.8
Scalar diffusivity	10.29	86.4
Scalar source term	16.62	139.6
Scalar diffusion	47.09	395.7
<b>GLOBAL</b>	<b>100.0</b>	<b>840.2</b>

Only 17% of computational time in species source term !

# LES of a partially premixed academic burner

- **Dynamic mesh adaptation of a turbulent flame**
- Collaboration with R. Mercier, SAFRAN TECH
- **1.8B tets, 8400 cores of Cobalt**
- 18 min to adapt the mesh
- $\Delta x = 20$  microns in the flame

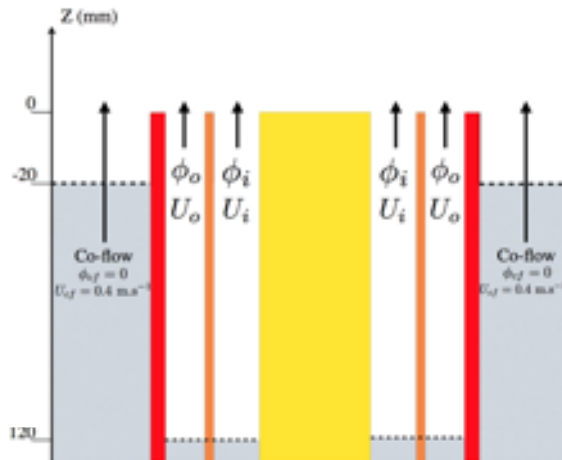

Longitudinal cut of the Cambridge burner (Mercier, 2015)

Case	$\phi_i$	$\phi_o$	$\phi_{cf}$	$\overline{U}_i$ [m/s]	$\overline{U}_o$ [m/s]	$\overline{U}_{cf}$ [m/s]
SwB5	1.0	0.5	0	8.31	18.7	0.4

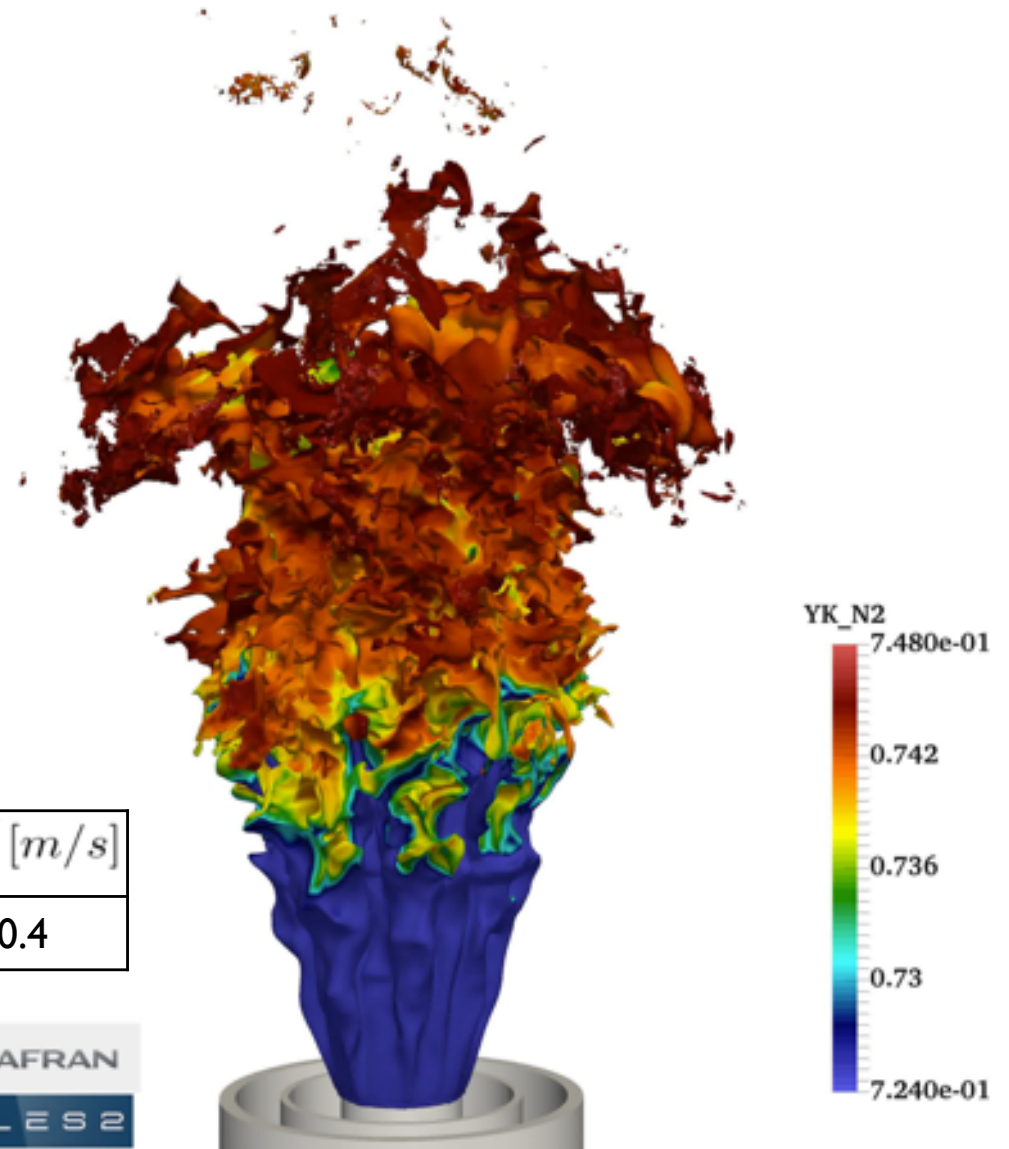



# Results plane Y=0

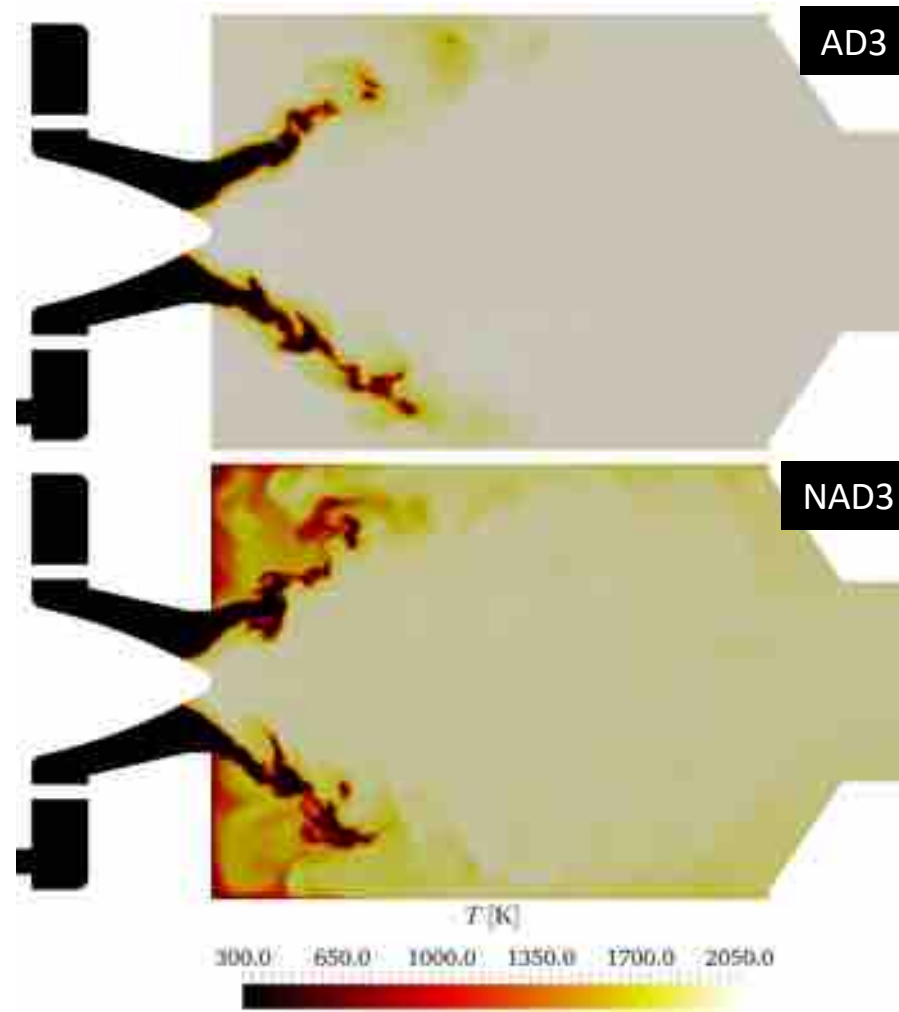
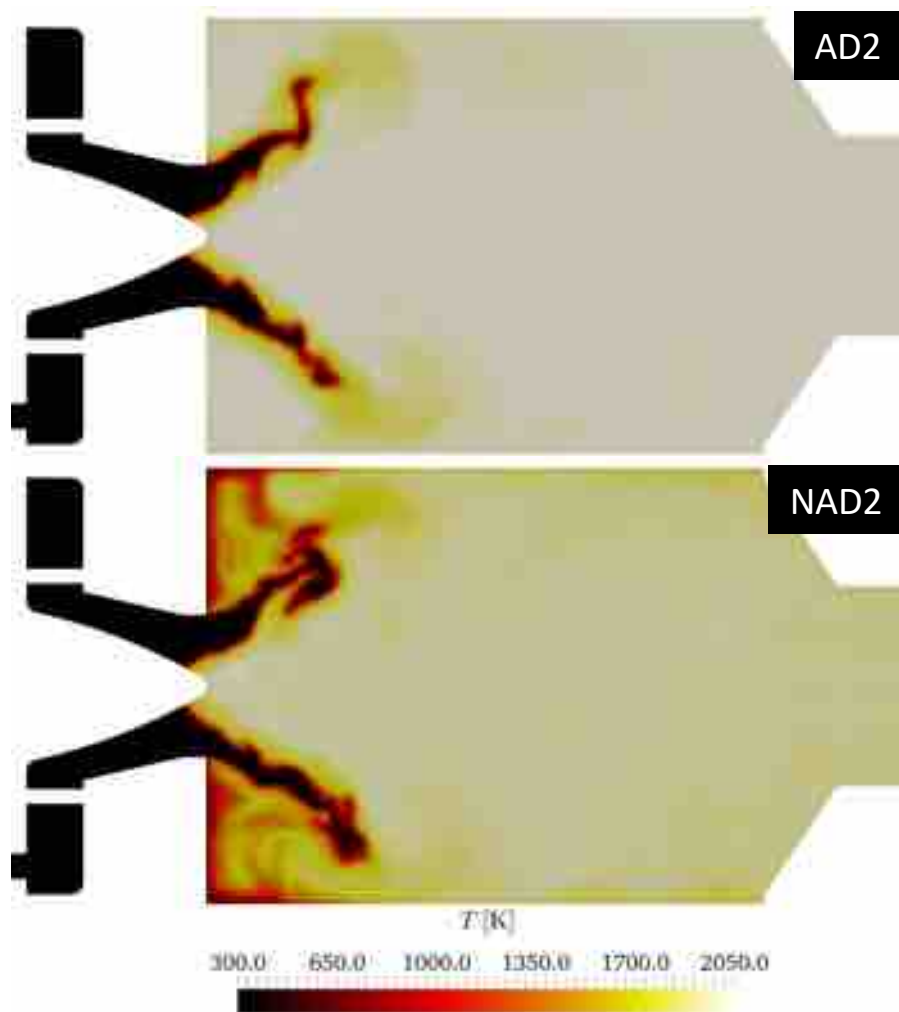

# Results 14M plane Y=0

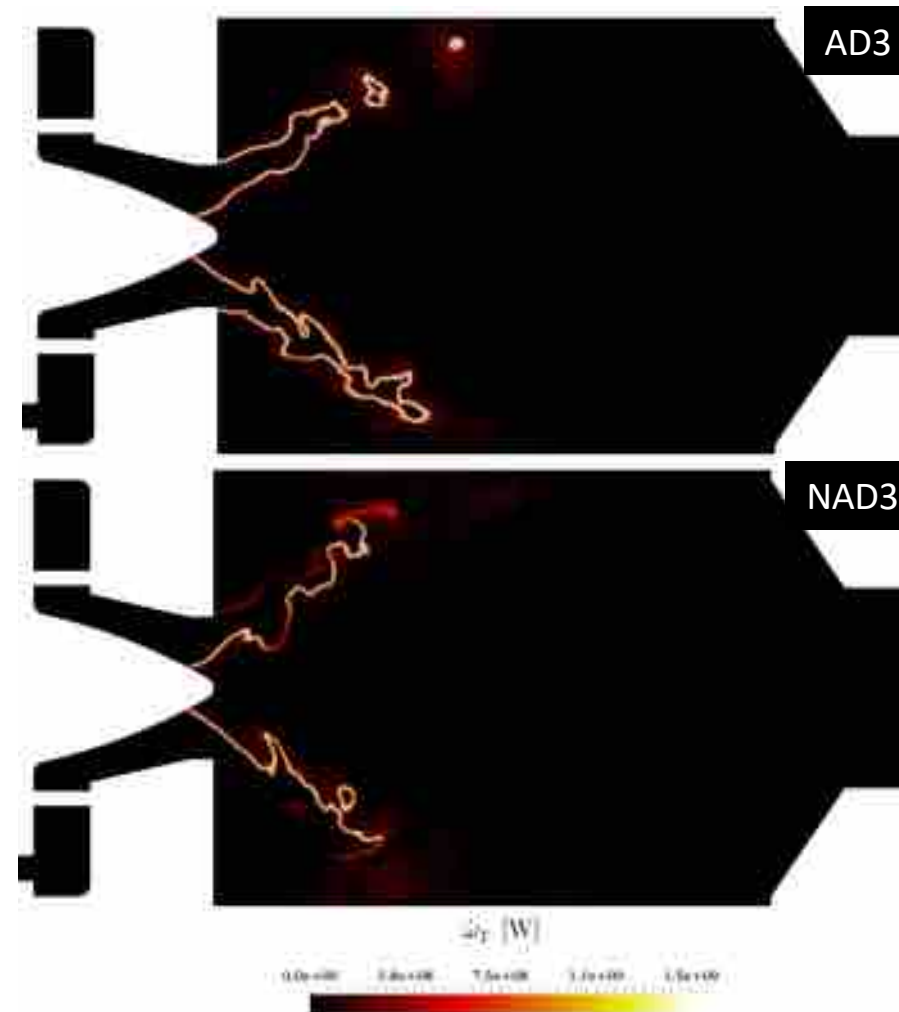
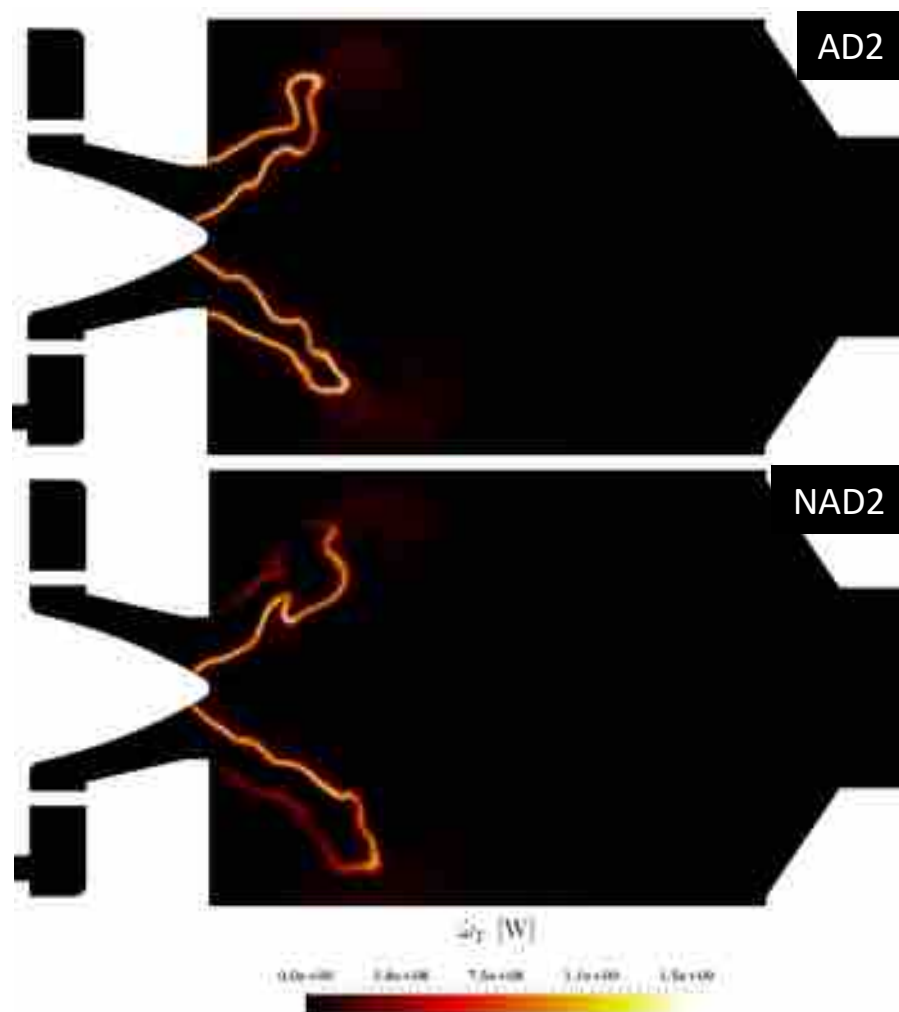

# Results 14M plane Y=0

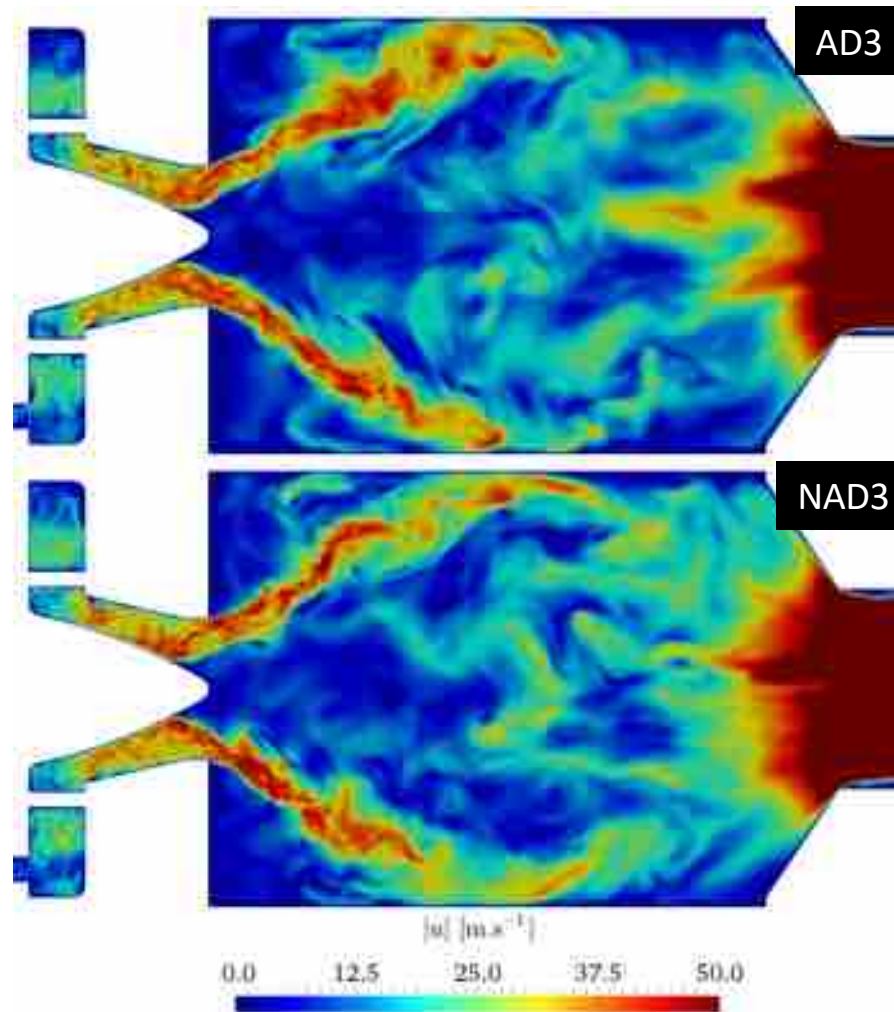
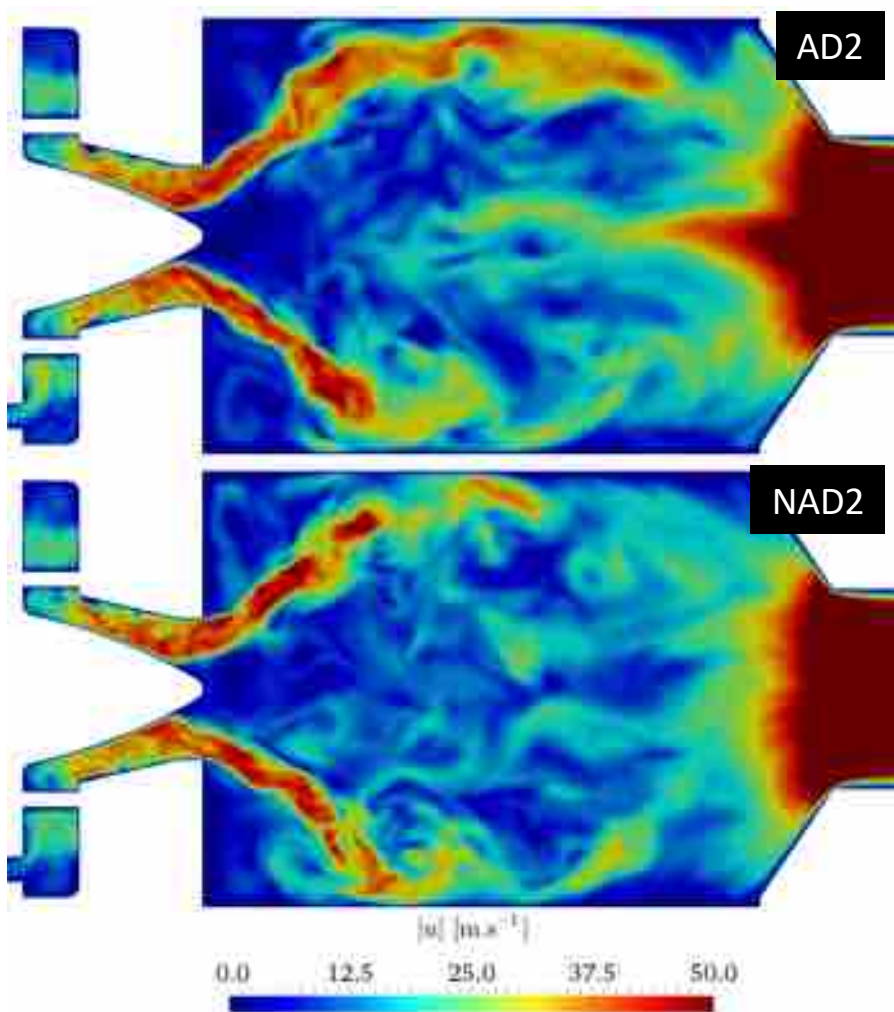

# Results 14M plane Y=0

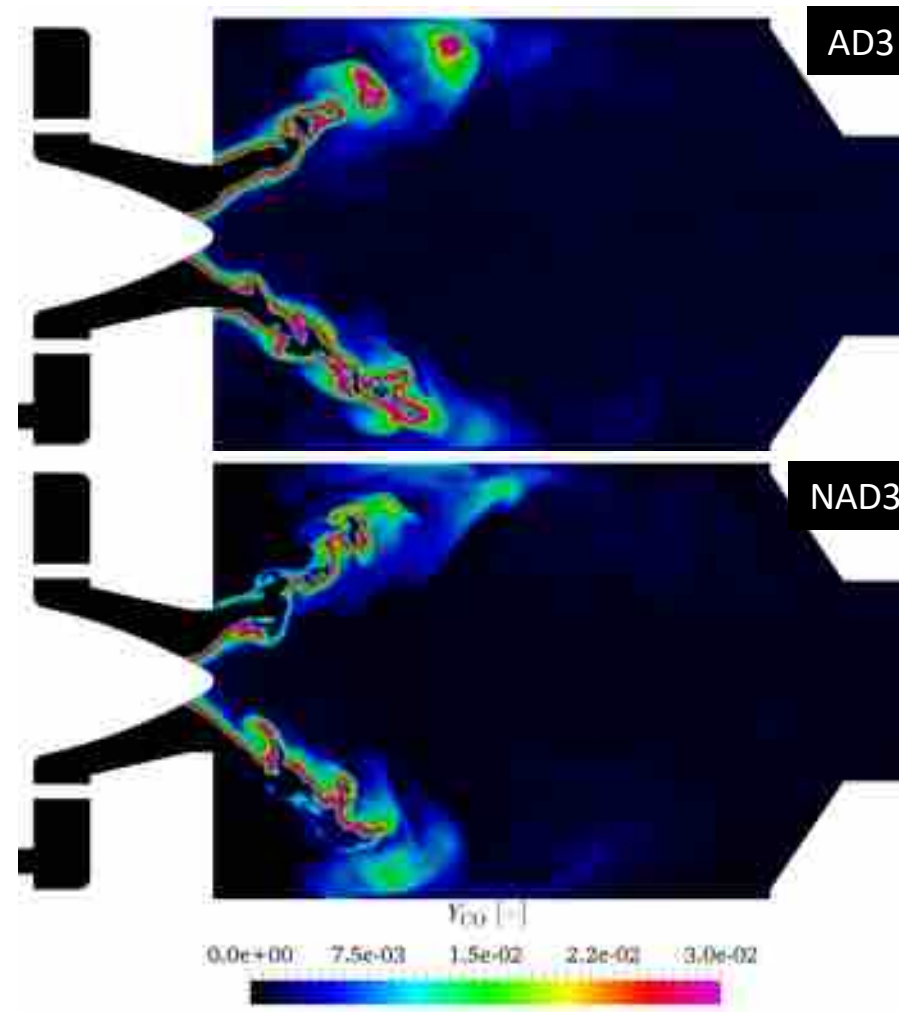
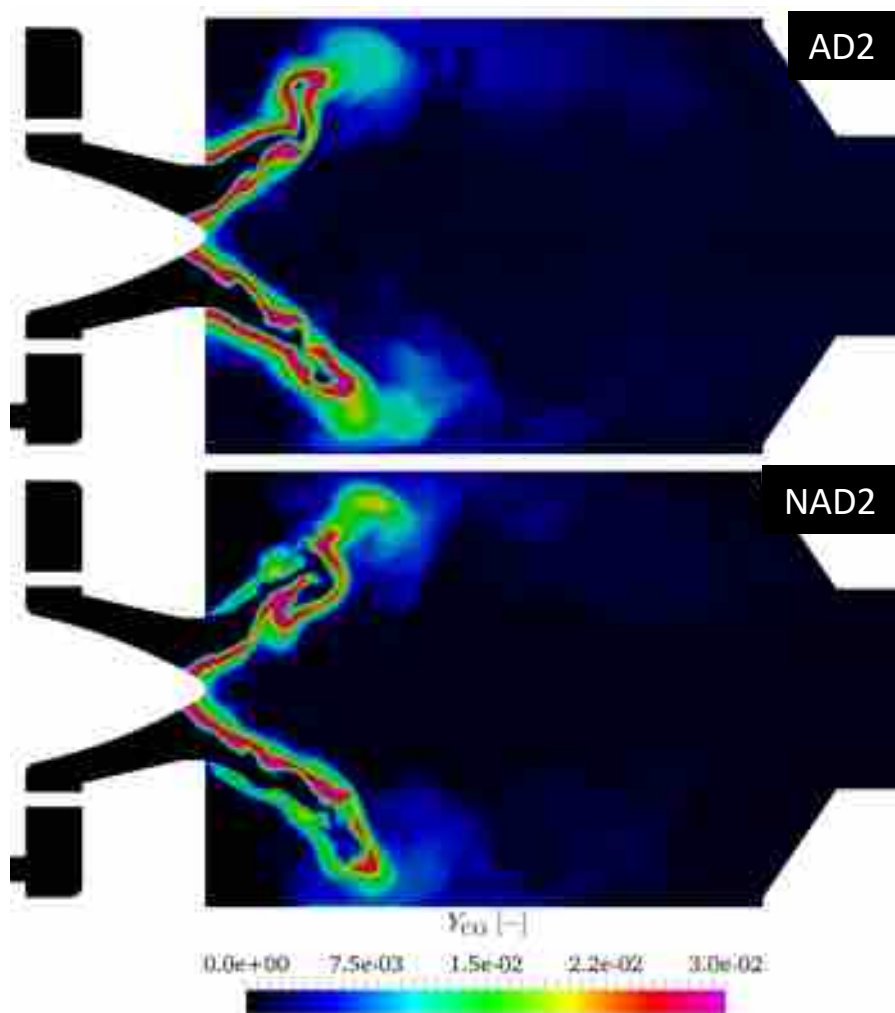



# Results 14M plane Y=0

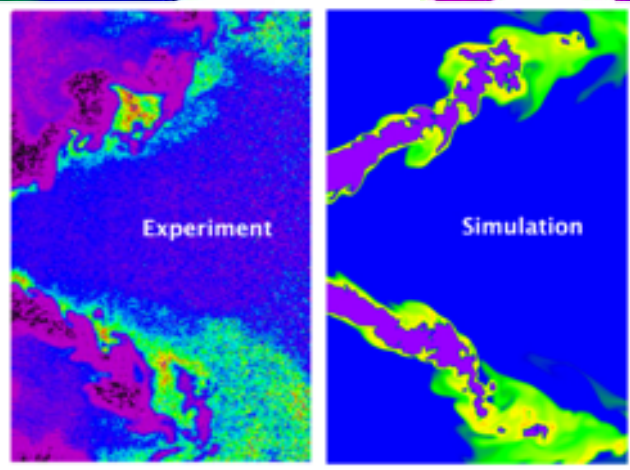
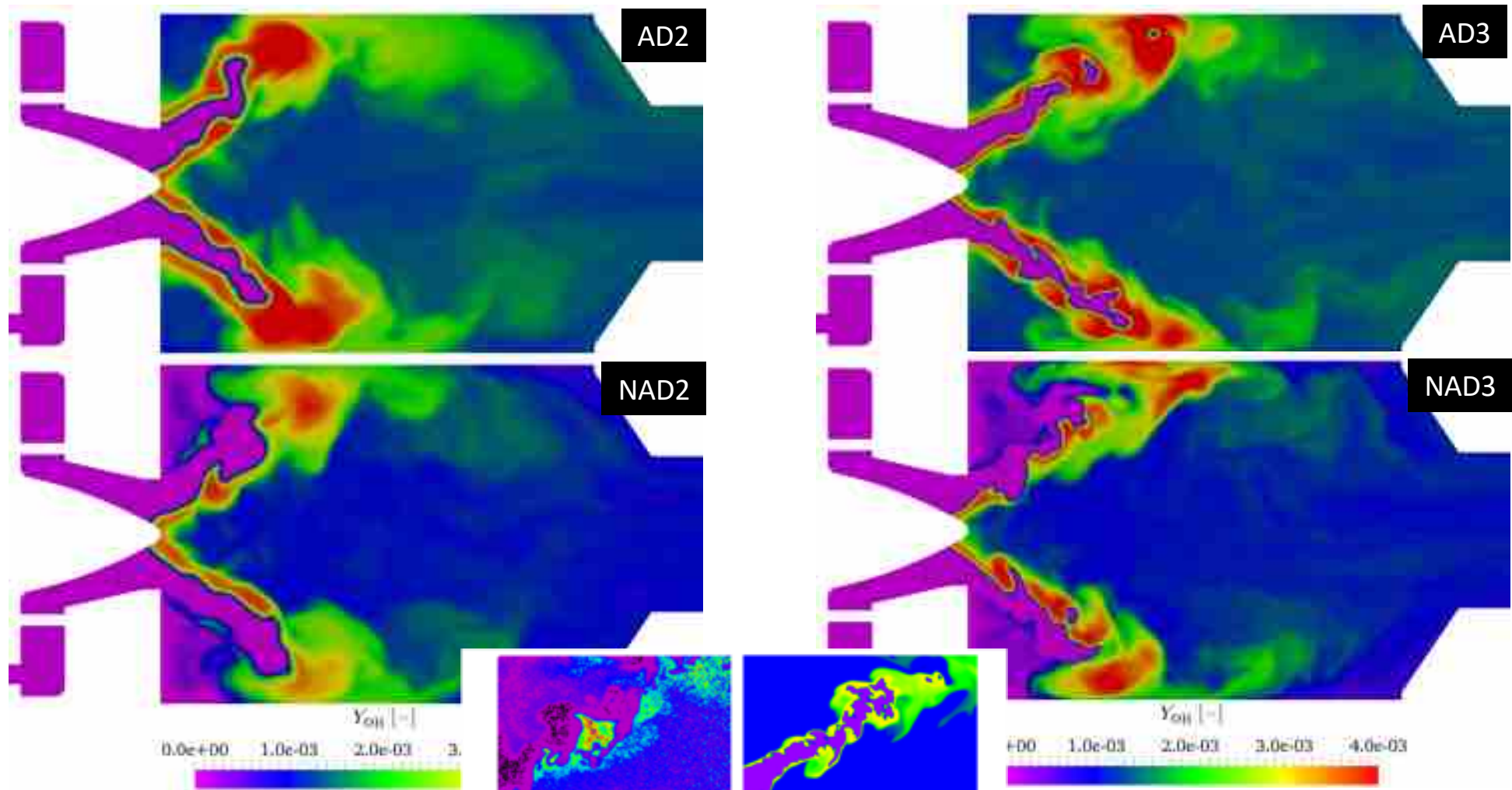



Numerical method

## An important feature of YALES2

- Two-level domain decomposition (Moureau et al., CRM, 2011)
  - Cache aware
  - Additional concurrency level

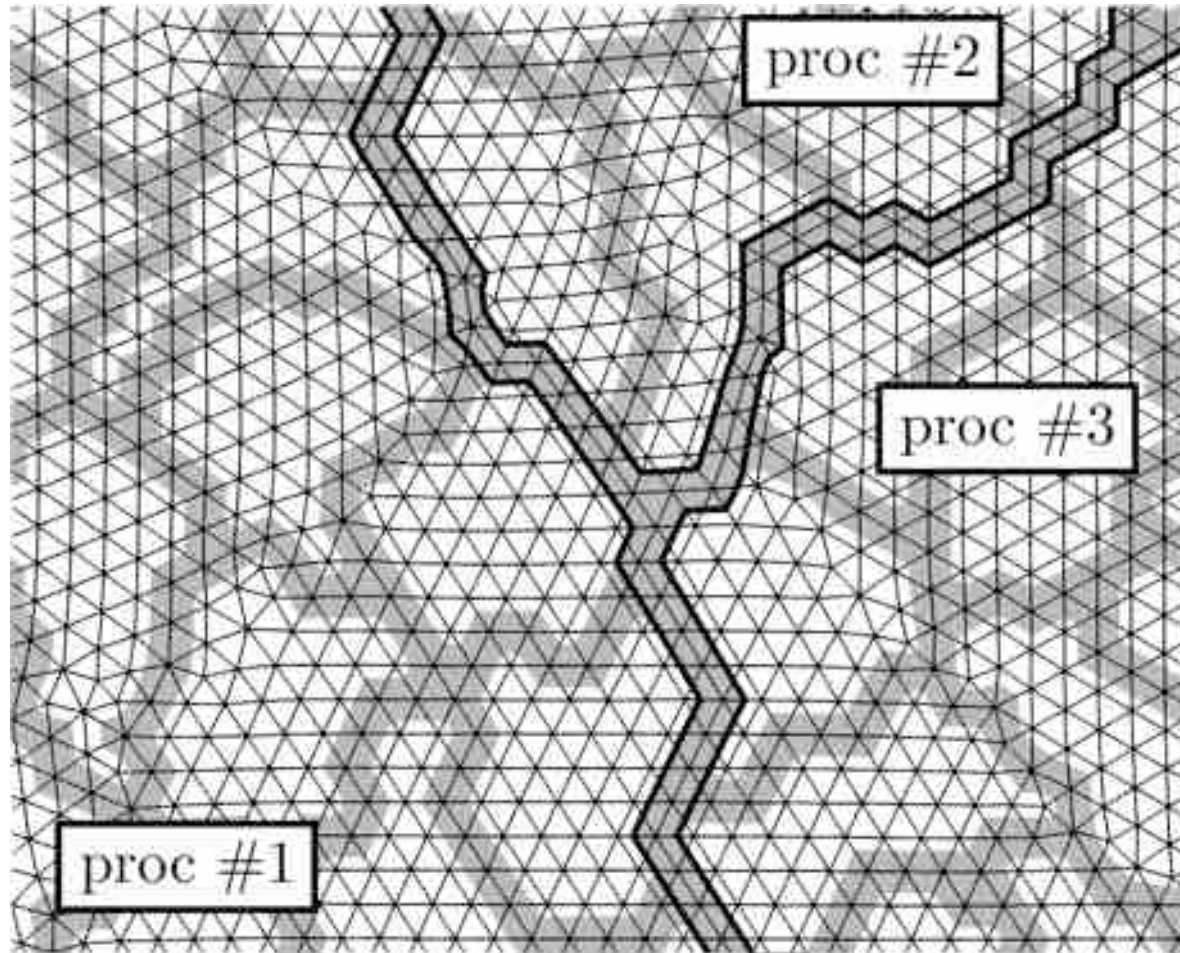

# Driving mechanism: Moore's law

- The power of super-computers almost doubles every 18 months



# Driving mechanism: Moore's law (revisited)

- Erich Strohmaier, ISC 2017, Frankfurt

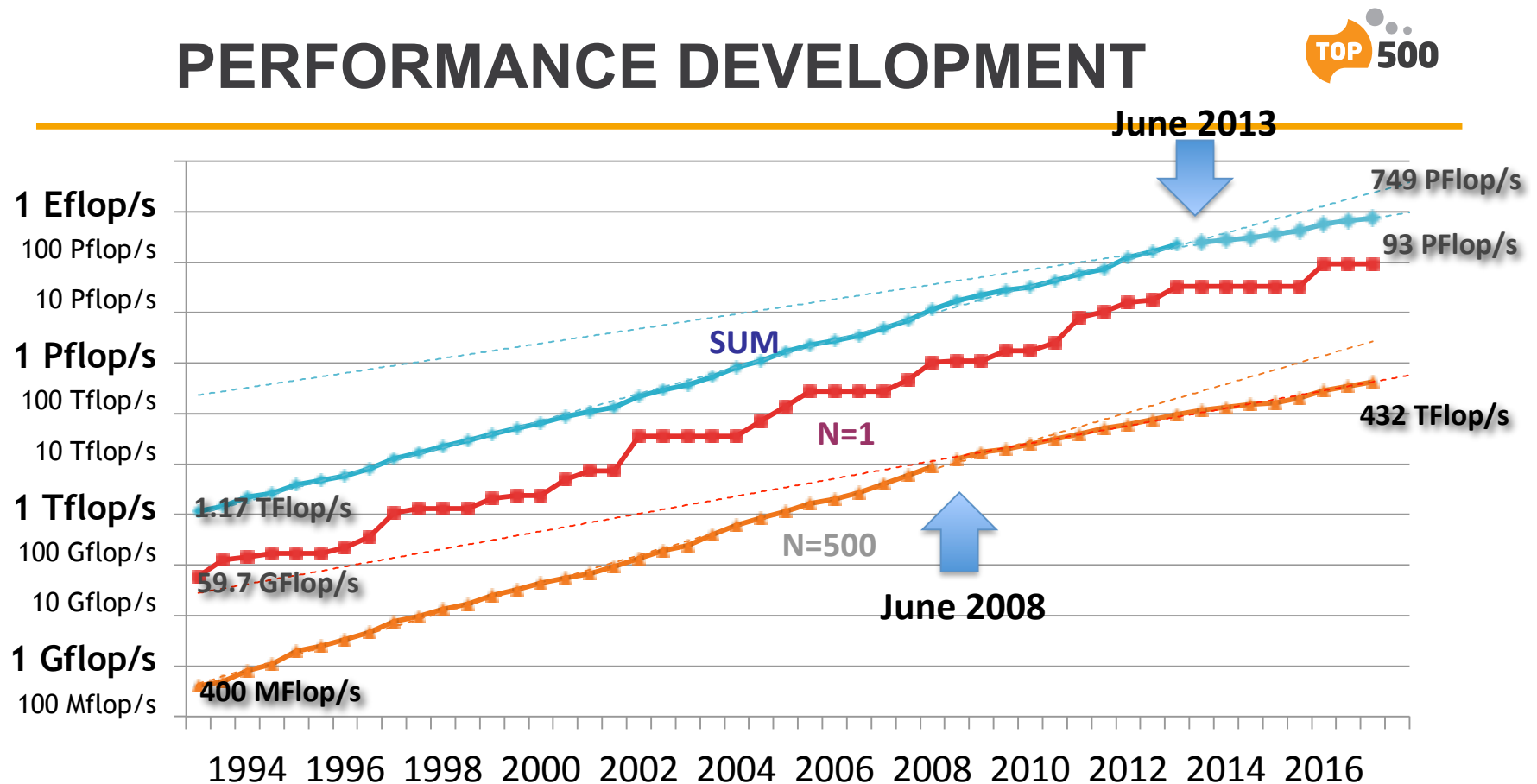

- The end of Moore's law has a strong impact on the new architectures

# Mitigation of Moore's law weakening in YALES2

- **Optimization**
  - Improvement of memory accesses
  - Vectorization: all the finite-rate chemistry is fully vectorized
- **Low-latency communications: PhD of F. Gava, ICARUS project**
  - Hybrid OpenMP/MPI model
  - Partitioned Global Address Space (PGAS)
- **Increased asynchronism**
  - Non-blocking collective communications (MPI3) in pipelined CG
  - Dynamic scheduling of source terms
- **Porting on new architectures**
  - GPU with ROMEO and in GENCI novel technology group
  - KNL with INTEL/UVSQ
  - NEC vector coprocessor (AURORA)
- **Other alternative?**



# H-adaptation

- **Mesh adaptation consists in the use of numerical techniques to refine or unrefine the mesh locally**
  - Node insertion in Delaunay triangulations
  - Edge or face swapping
  - Element collapsing
- **Several sequential libraries exist**
  - MMG3D, C. Dobrzynski, <http://www.math.u-bordeaux1.fr/~dobrzyns/logiciels/mmg3d.php>
  - MADLIB, <http://sites.uclouvain.be/madlib/>
  - NETGEN, <http://www.hpfem.jku.at/netgen/>
  - TETGEN, <http://wias-berlin.de/software/tetgen/>
  - CGAL, <http://www.cgal.org/>
  - MeshAdapt, <http://www.scorec.rpi.edu/~xli/MeshAdapt.html>
- **Very few libraries are (massively) parallel**



# Challenge

- Can we imagine a parallel algorithm based on sequential adaptation?
- If mesh adaptation is performed on each processor, problems will arise at the proc interface. The choice made in YALES2 is to leave the proc interface and the boundaries untouched

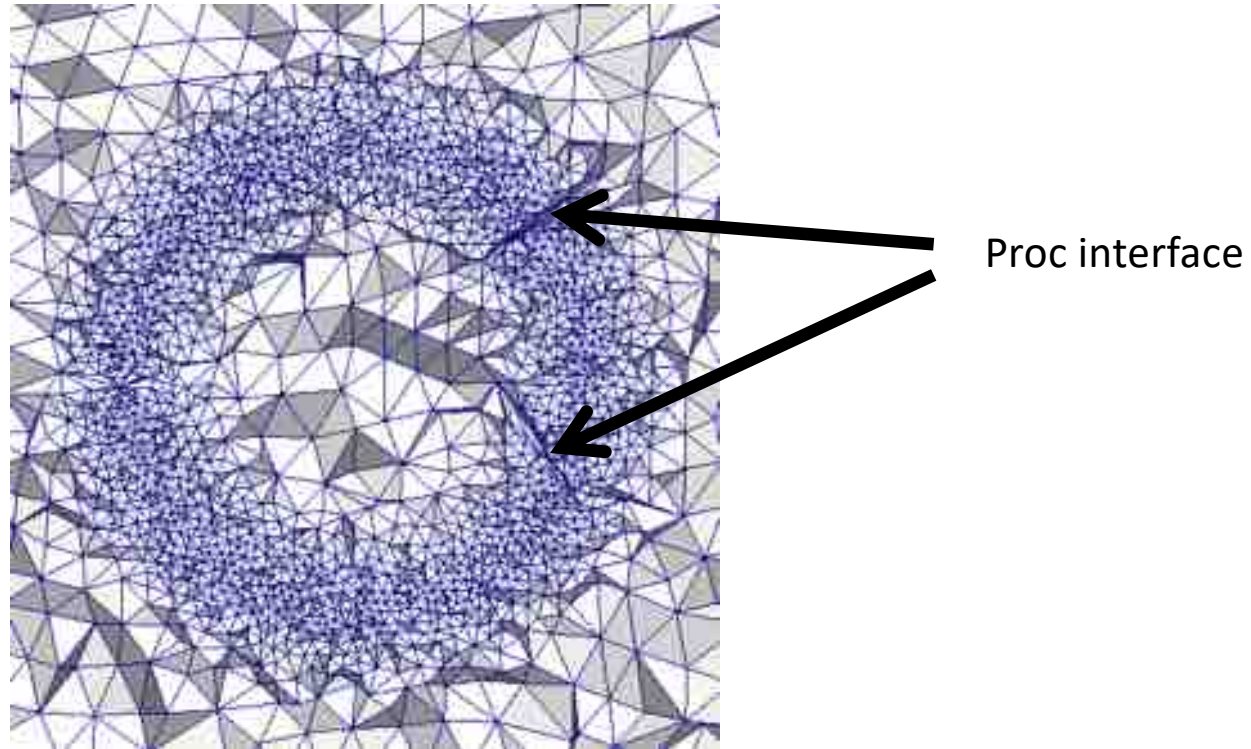

# Parallel h-adaptation strategy

- Designed for massively distributed meshes [1]
- Quality of the mesh is ensured during adaptation
- **Tetrahedral elements only**
- Example for 4 processors

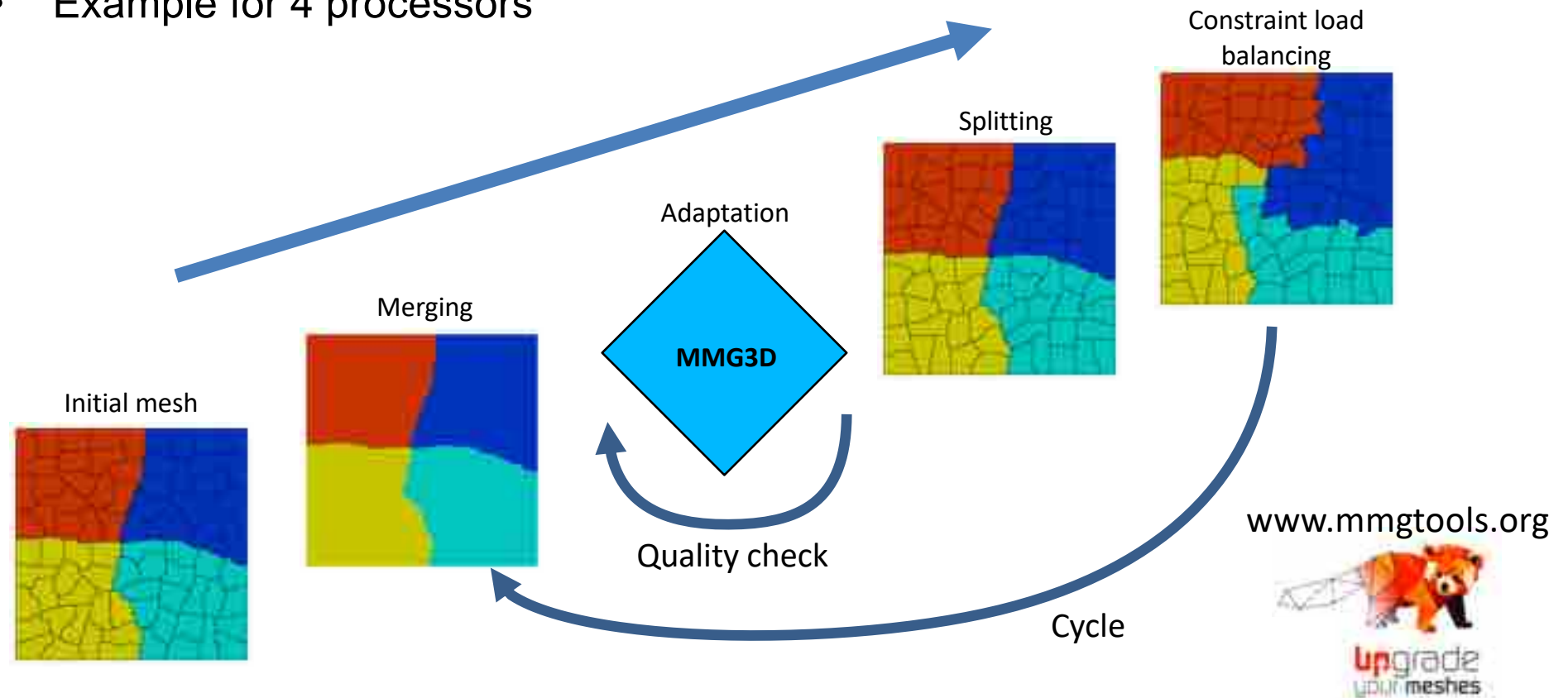



# Application: Turbulent flame kernel propagation

- CH<sub>4</sub>/air BFER scheme, DTFLES model,  $\phi = 1.0$ ,  $u'/S_L = 22.5$
- Refinement ratios = 1, 3, 6

Finite-rate chemistry  
MMG3D4

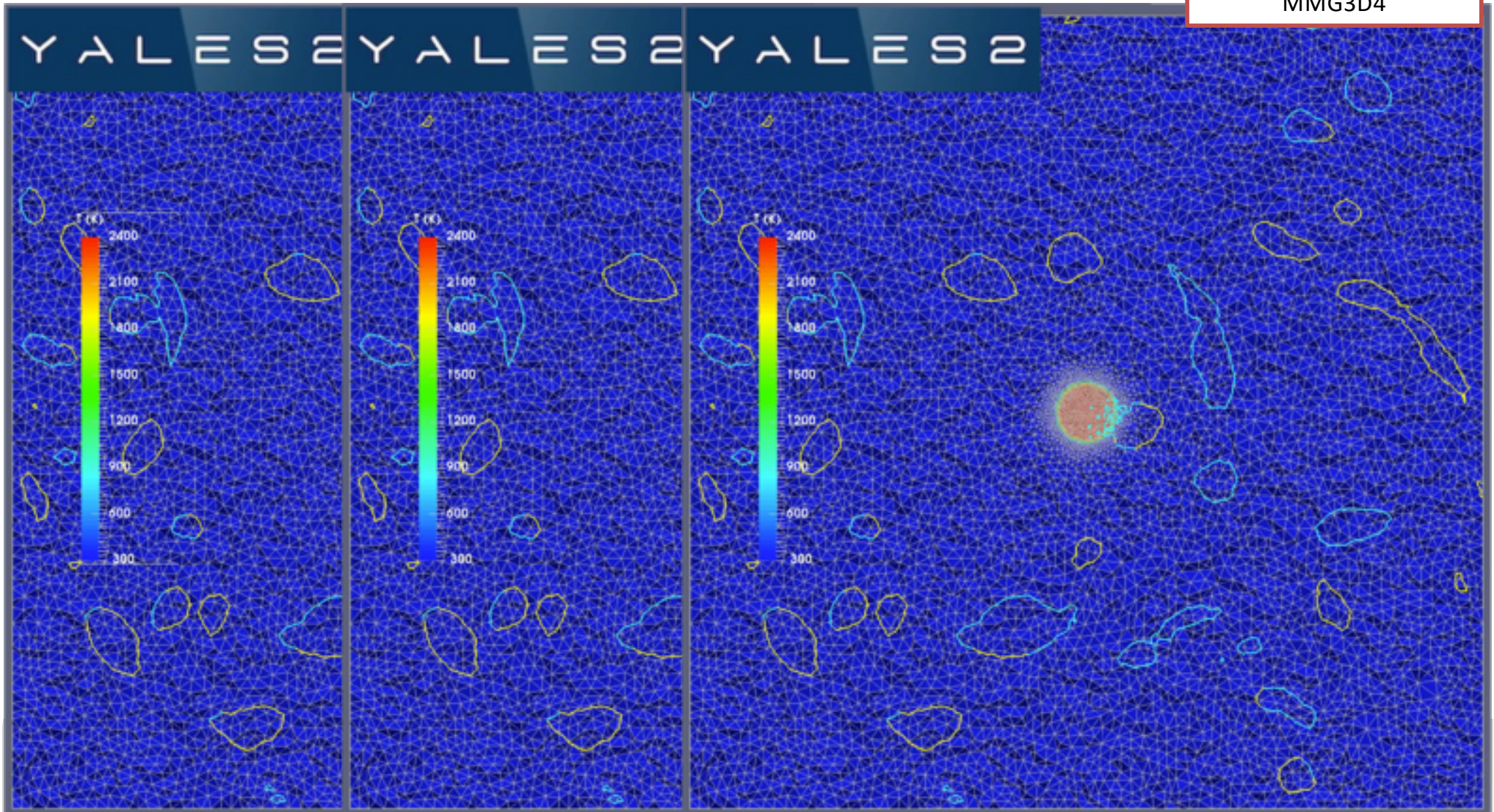



# Jet-in-cross-flow

- Kerosene jet in air at 10 bar

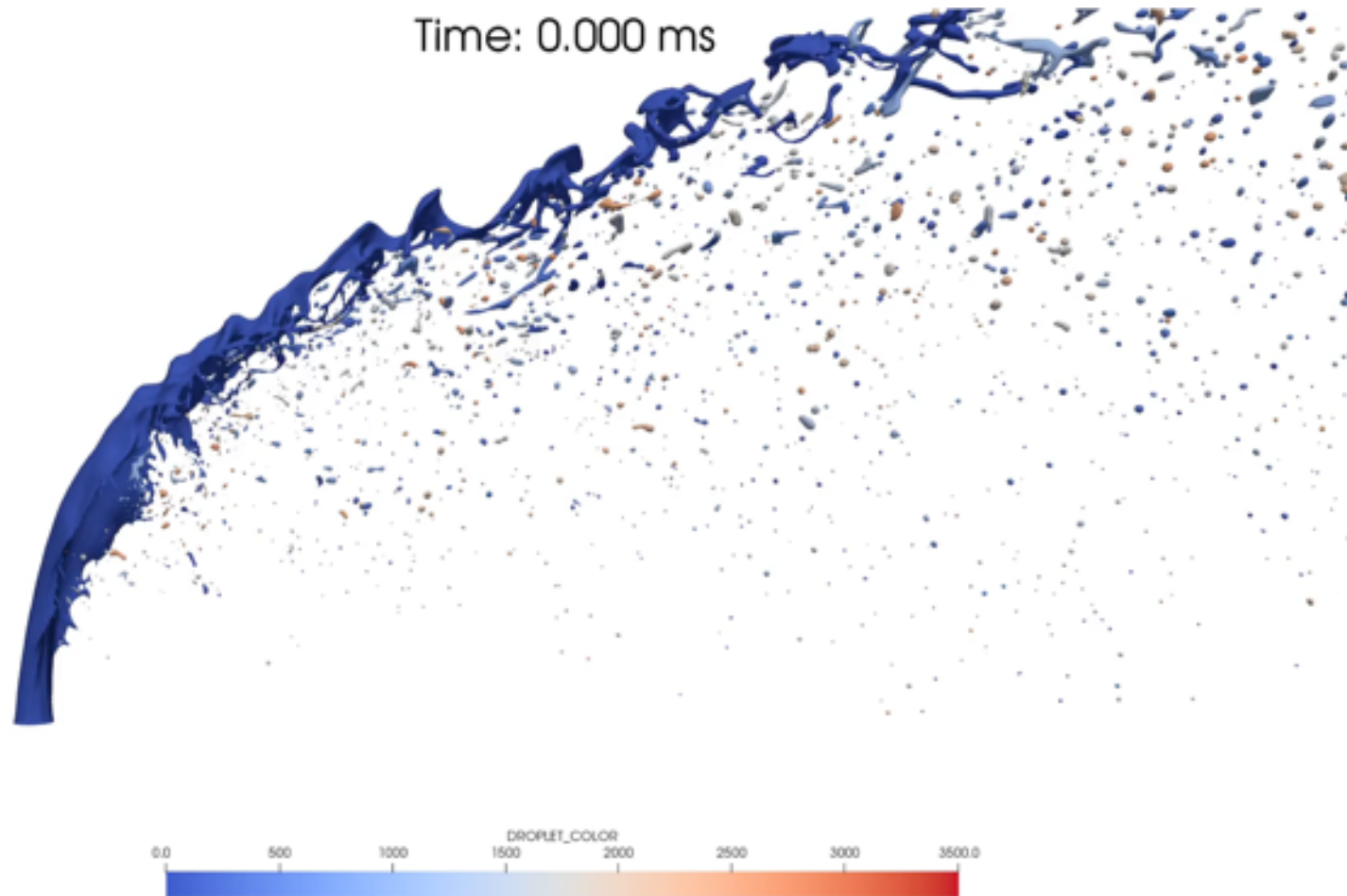

Ragucci et al. 2007  
Atomization & Sprays

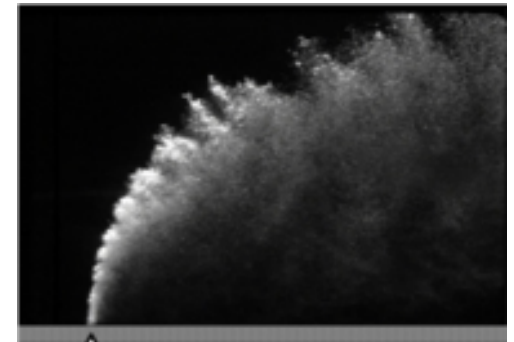

Dynamic mesh adaptation of a kerosene jet in cross flow. J. Leparoux, H. Musaefendic, R. Mercier, V. Moureau, submitted to ICLASS 2018, Chicago.

- Injector diameter:  $D=0.5$  mm
- Flow section: 25 mm x 25 mm
- Pressure: 10 bars
- $V_{\text{air}}=37$  m/s and  $V_{\text{kerosene}}=17$  m/s
- $Re_{\text{air}}=590\,287$  and  $Re_{\text{kerosene}}=4477$
- $We_{\text{aero}}=\rho_{\text{air}}V_{\text{kero}}^2D/\sigma=63.5$
- $q=\rho_{\text{kero}}V_{\text{kero}}^2/\rho_{\text{air}}V_{\text{air}}^2=14.2$
- $Dx=20$  microns

# Jet-in-cross-flow

- Kerosene jet in air at 10 bar

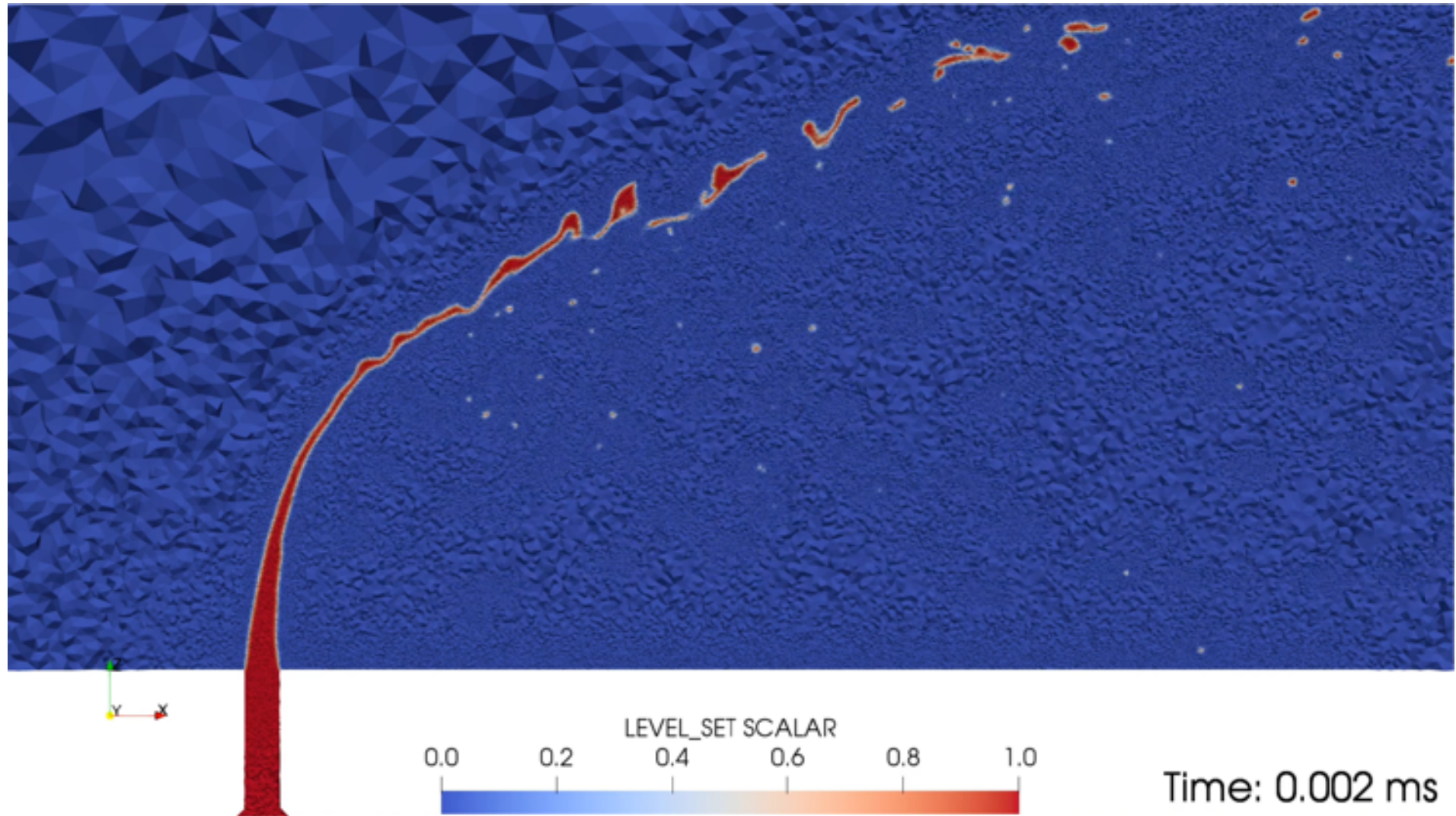

Dynamic mesh adaptation of a kerosene jet in cross flow. J. Leparoux, H. Musaefendic, R. Mercier, V. Moureau, submitted to ICLASS 2018, Chicago.

# Application to primary atomization

with R. Mercier, J. Leparoux, H. Musaefendic, SAFRAN

- High-pressure kerosene jet in cross-flow
- Relevant for multi-point injection systems
- Ragucci et al., *Atomization & Sprays*, 2007

- Reference operating conditions

- Injector diameter:  $D=0.5$  mm
- Flow section: 25 mm x 25 mm
- **Pressure: 10 bars**
- $V_{\text{air}}= 37$  m/s and  $V_{\text{kerosene}}= 17$  m/s
- $Re_{\text{air}}= 590\ 287$  and  $Re_{\text{kerosene}}= 4477$
- $We_{\text{aero}}= \rho_{\text{air}} V_{\text{kero}}^2 D / \sigma = 63.5$
- Momentum ratio  $q = \rho_{\text{kero}} V_{\text{kero}}^2 / \rho_{\text{air}} V_{\text{air}}^2 = 14.2$

- Numerics

- Ghost-Fluid Method [Fedkiw et al., 2000]
- Accurate Conservative Levelset [Desjardins et al., 2009]

- Paper accepted to ICLASS 2018, Chicago

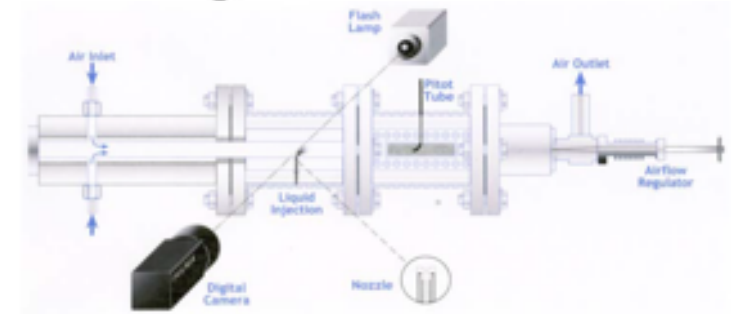
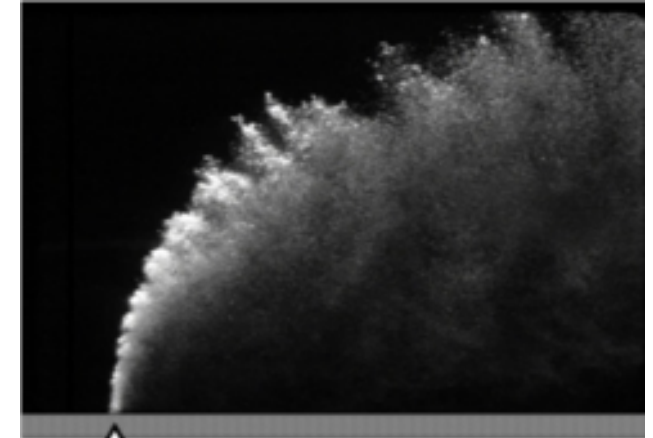

# Application to primary atomization

with R. Mercier, J. Leparoux, H. Musaeffendic, SAFRAN

## ► Quantitative comparisons

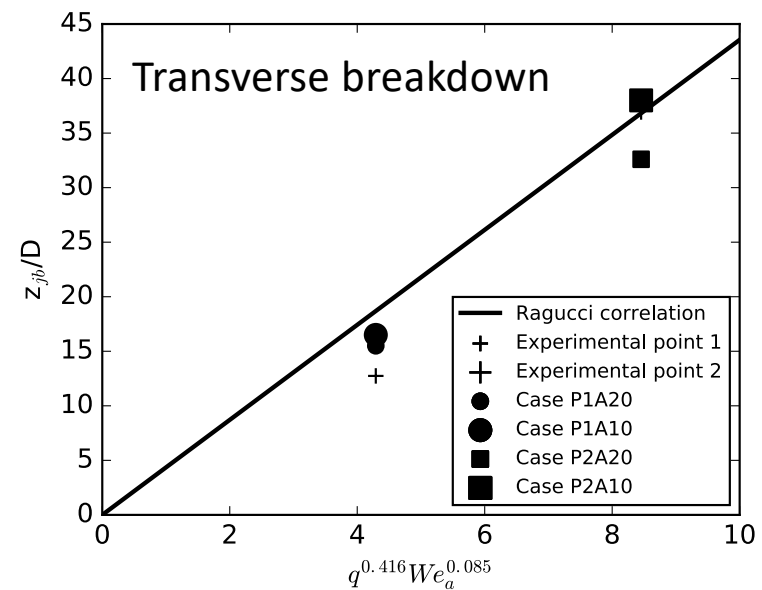
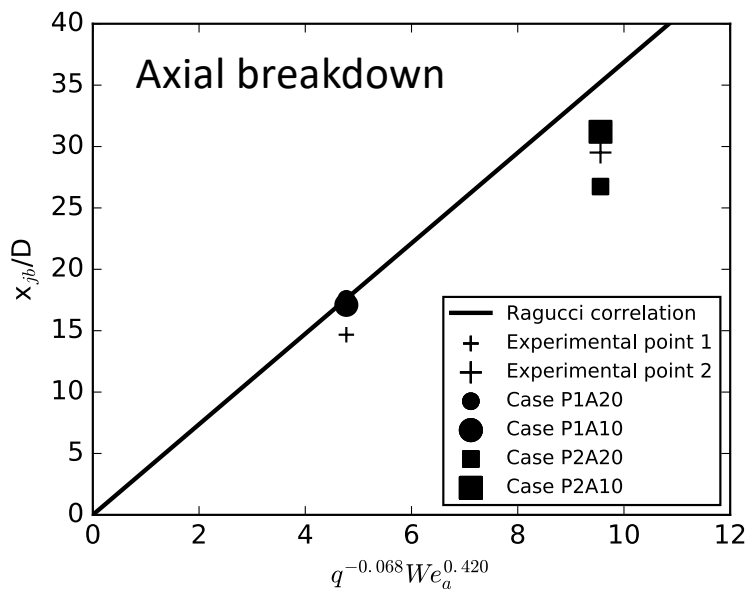
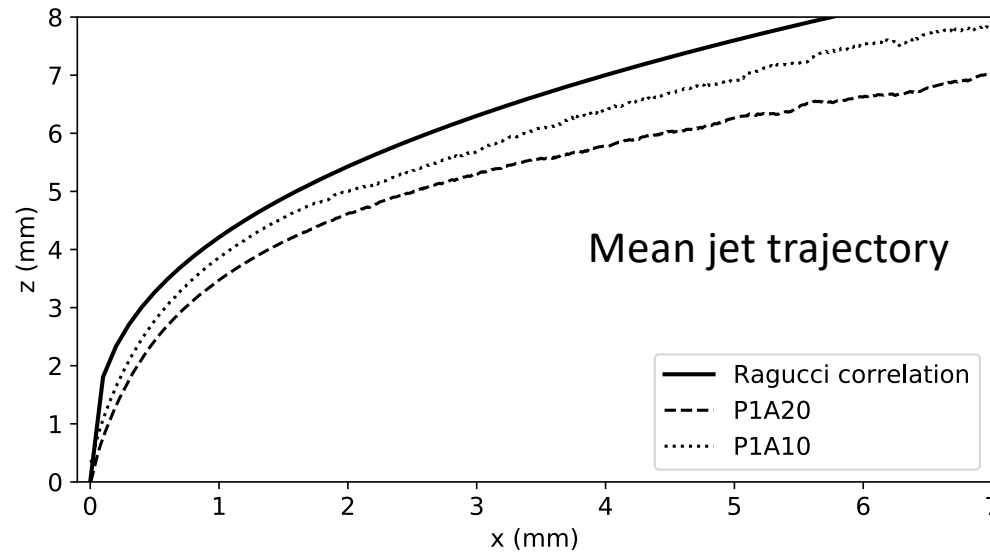



# Spray modeling with finite-rate chemistry

PhD of H. Larabi

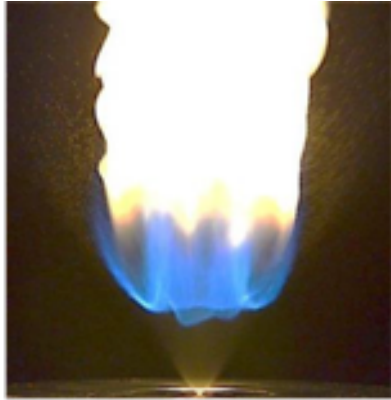

Picture of the jet spray flame

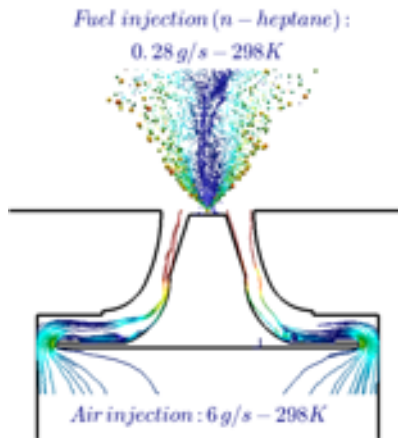

- KIAI spray flame [1]
- Finite-rate chemistry model
  - n-heptane/air scheme from Analytically Reduced Chemistry (ARC) [2]
  - built from Jerzembeck et al. [3]
  - 24 transported species, 32 QSS species and 217 reactions.
- Spray model
  - Point force approach
  - Droplet assumed to be fully atomised at injection
  - Rosin-Rammler distribution with a SMD of  $32 \mu\text{m}$  and dispersion  $q$  of 2.3 (at  $Z = 10 \text{ mm}$ )
  - LISA (Liquid Injection for Swirl Atomizers) model to obtain the hollow cone
- Evaporation model
  - Spalding (1953) / Abramzon & Sirignano (1989)
- Mesh
  - 520 million tetrahedra, 120 microns in the flame front region

[1] A. Verdier et al., 2016, Proceedings of the Combustion Institute.

[2] P. Pepiot-Desjardins and H. Pitsch. (2008). Combustion and Flame, 154(1) :67–81

[3] S. Jerzembeck, N. Peters, P. Pepiot-Desjardins, and H. Pitsch. (2009). Comb. Flame, 156 :292–301.

# Spray modeling with finite-rate chemistry

PhD of H. Larabi

- Flame topology

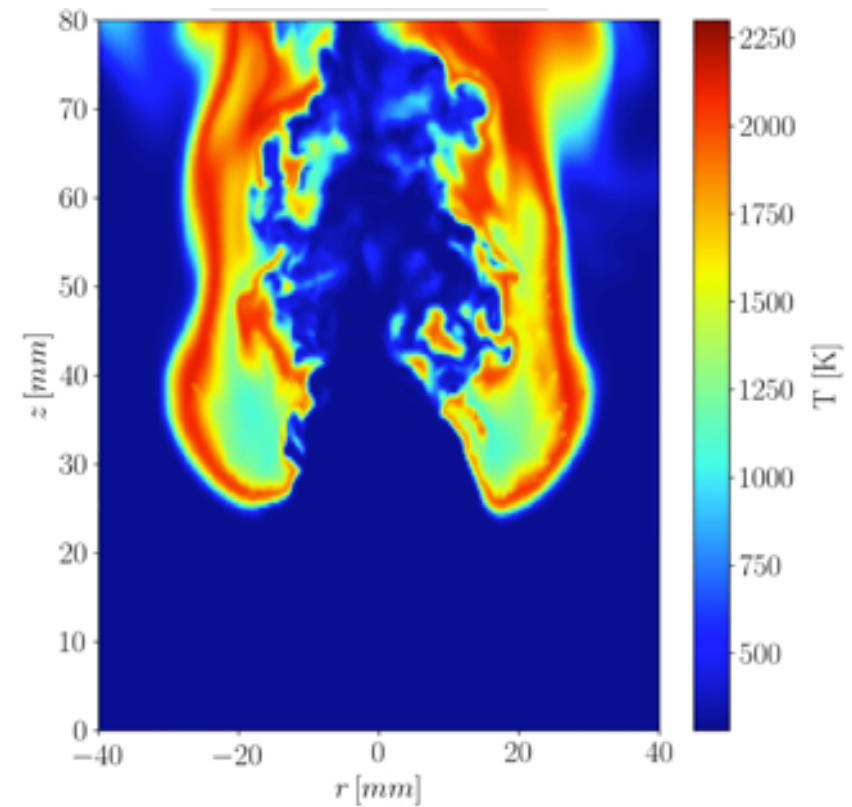
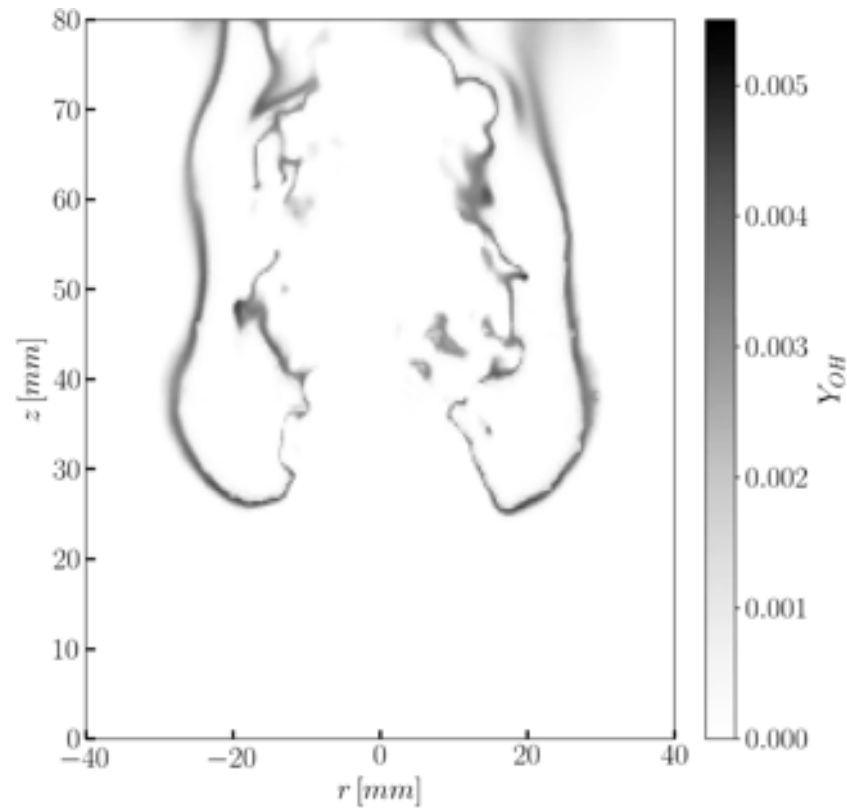

# Spray modeling with finite-rate chemistry

PhD of H. Larabi

- Flame lift-off

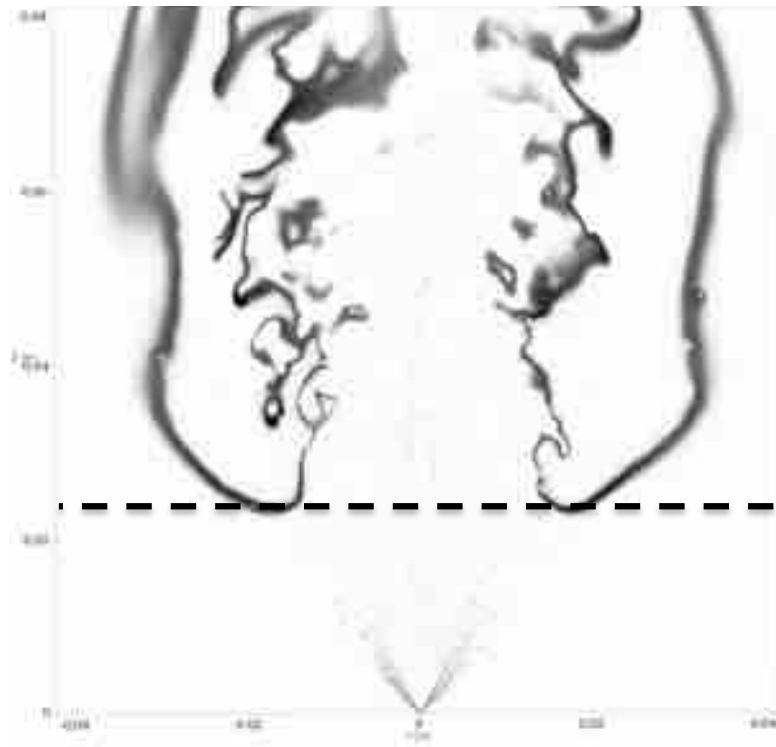

$$Z_{LO,LES} = 23 \text{ mm}$$

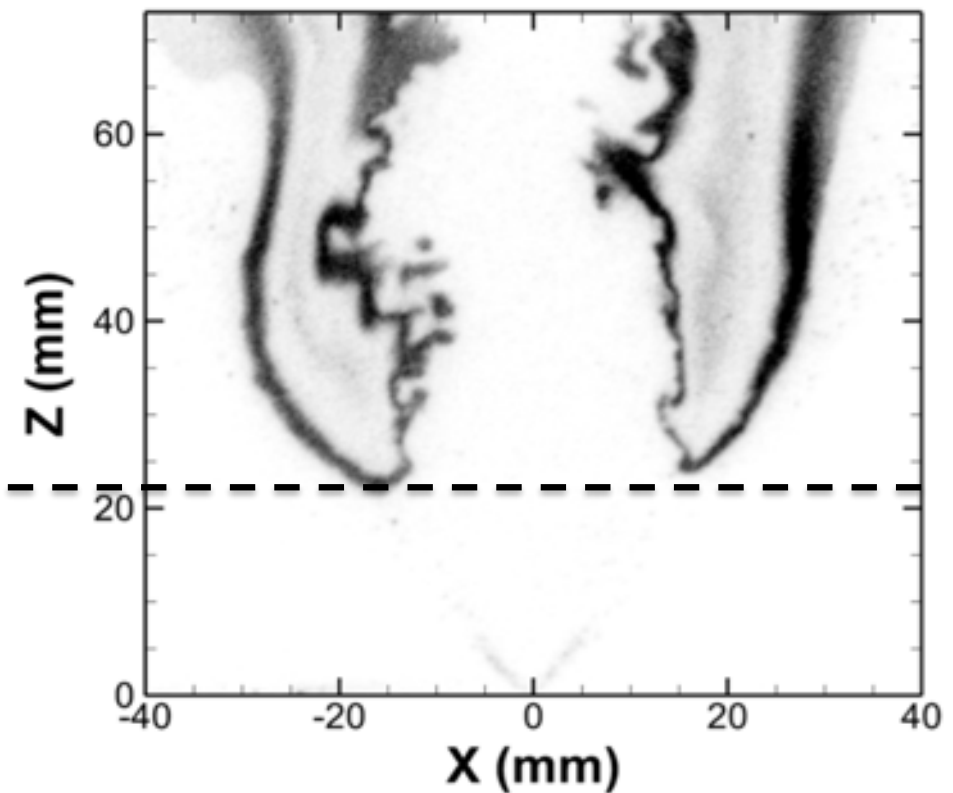

$$Z_{LO,EXP} = 22 \text{ mm} \quad \cdot +/ - 1$$

# Spray modeling with finite-rate chemistry

- ▶ Lagrangian spray models are not well-suited for distributed computing
- ▶ They lead to strong imbalance between the processors
- ▶ Solution: double-constraint dynamic load balancing

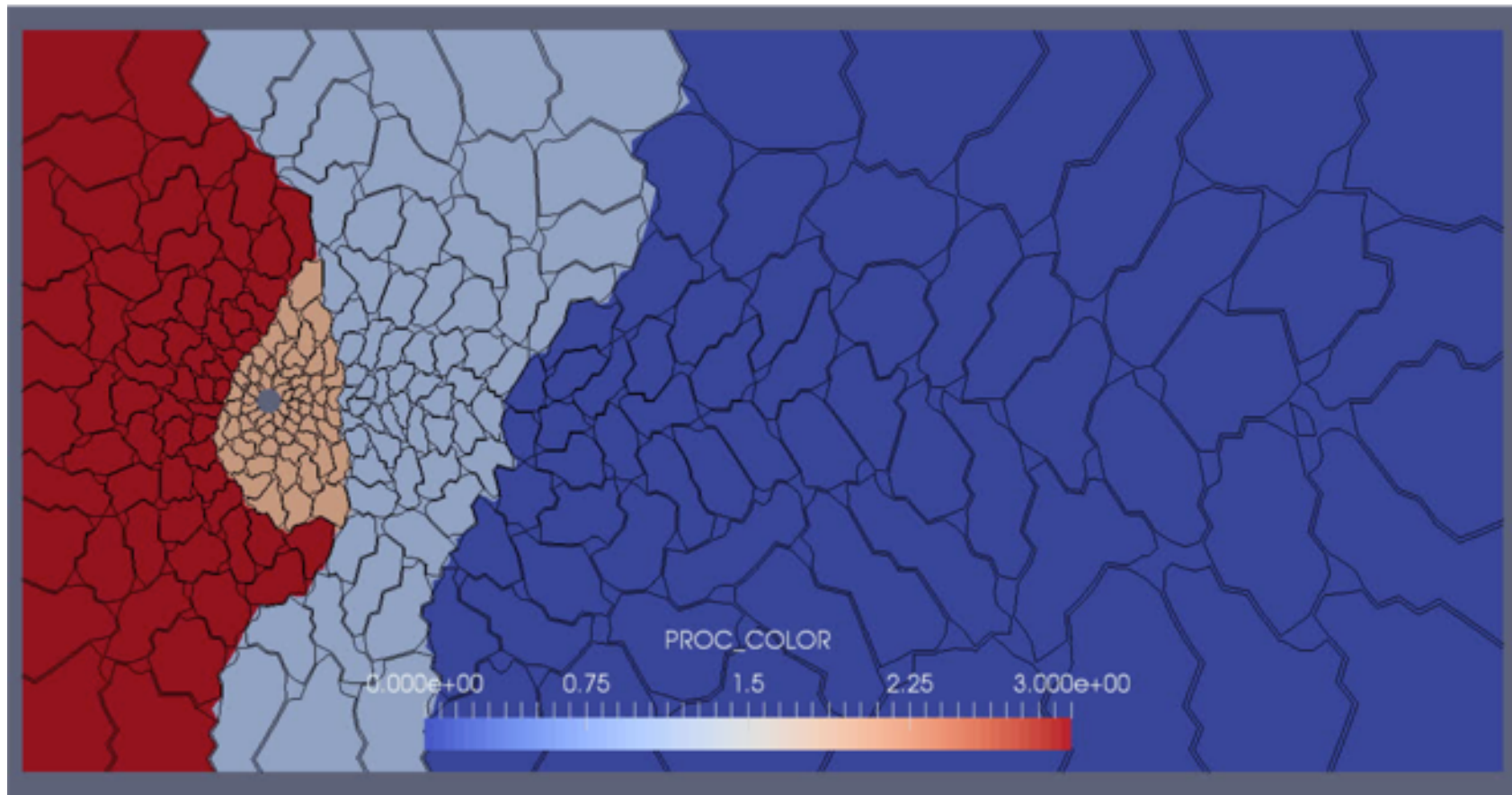



# Conjugate and radiative heat transfer

- Conjugate heat transfer can be modeled by solving the heat equation in the solid and coupling it with the fluid solver



- If radiative heat transfer is involved

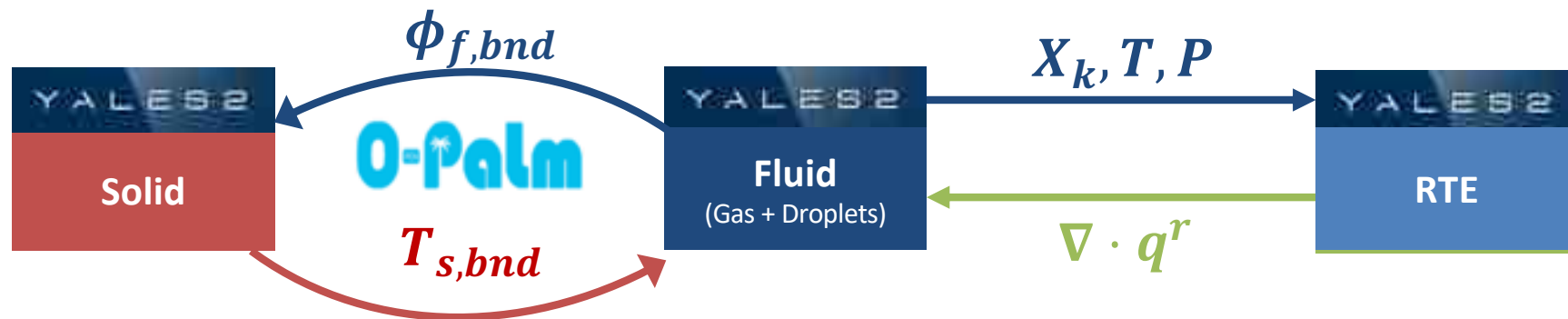

# Radiative heat transfer in CHT

PhD of L. Boulet

- Additional term in the energy transport equation

$$\frac{\partial \rho h_s}{\partial t} + \frac{\partial \rho u_i h_s}{\partial x_i} = \frac{DP}{Dt} + \frac{\partial q_i}{\partial x_i} + \tau_{ij} \frac{\partial u_i}{\partial x_j} + \dot{\omega}_T + \frac{\partial q_i^r}{\partial x_i}$$

- Radiative heat transfer solved by the RTE

$$\frac{dI_\nu(\mathbf{r}, \mathbf{s})}{ds} = -k_\nu(\mathbf{r}) I_\nu(\mathbf{r}, \mathbf{s}) + k_\nu(\mathbf{r}) I_{b,\nu}(\mathbf{r})$$

  Known term     
   Unknown property     
   Unknown variable

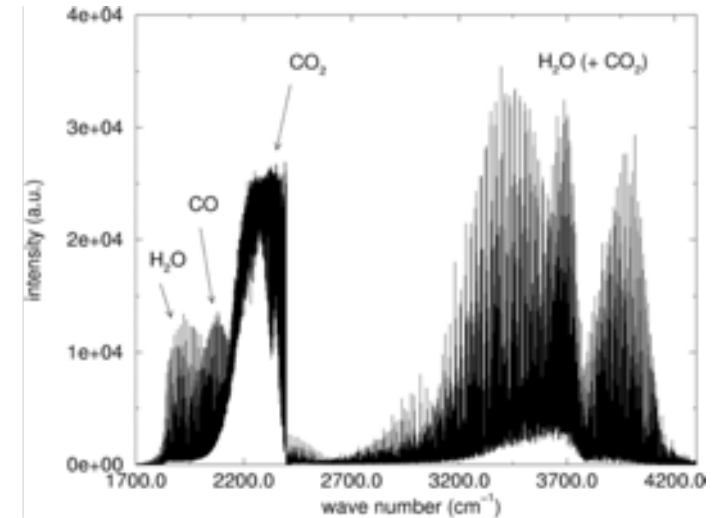

Emission spectrum of a CH<sub>4</sub>/air flame at 2160K

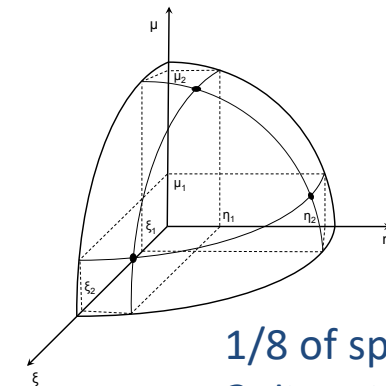

## Modeling strategy

- Spectral quadrature: FS-SNB-Ck
- Angular quadrature: Discrete Ordinate Method (Modest, 2013)
- Spatial discretization: Finite-Volume
- Linear solver: BICGSTAB2
- HPC: vectorization + distributed memory

# Stabilization of a flame behind a metallic cylinder

PhD of L. Boulet

## ▶ 2 types of flame stabilisation

- $\varepsilon = 1$ : downstream stabilized
  - Low T & little recirculation zone
- $\varepsilon = 0$ : upstream stabilized
  - High T & large recirculation zone

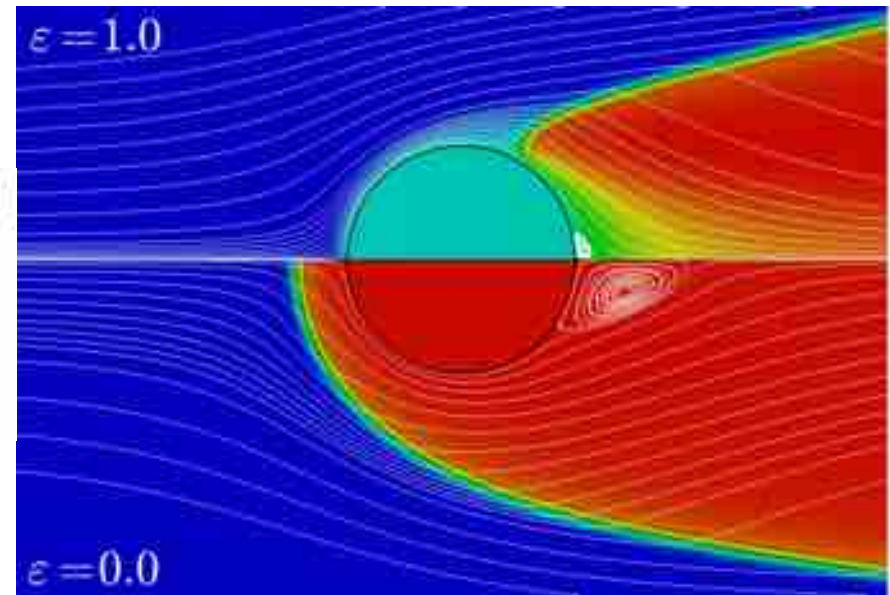
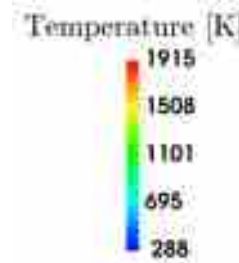

## ▶ Angle profile

- Gap between  $\varepsilon = 0.15$  and  $\varepsilon = 0.1$
- Good comparison with [1]

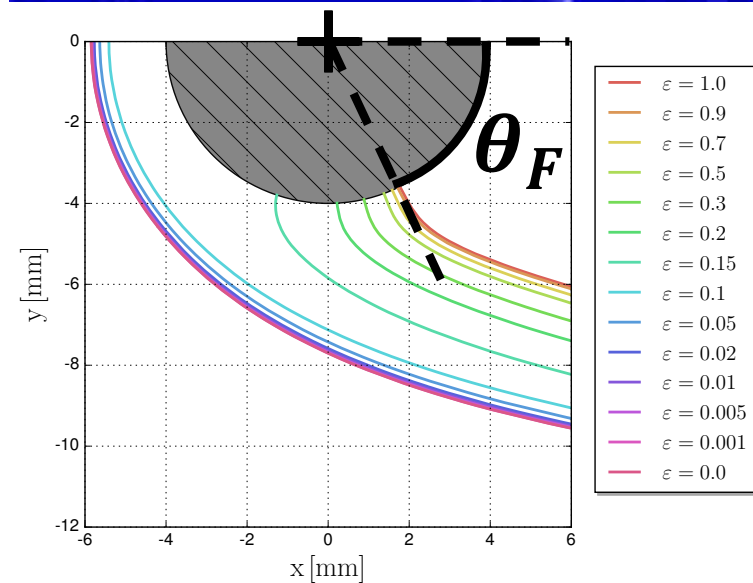
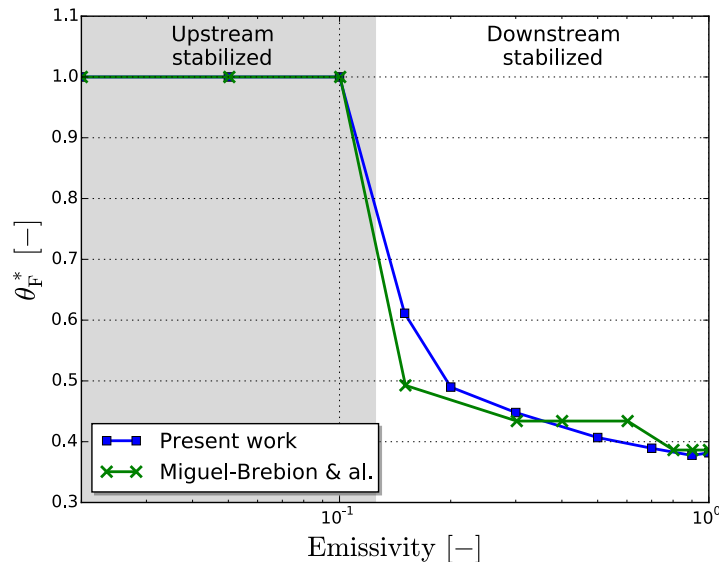

# Conjugate and radiative heat transfer

PhD of L. Boulet

- Fire resistance tests
  - Manufacturers need to certify equipments in terms of fire resistance (housing, fastening engine, ...)
  - Certification: the apparatus needs to be submitted [1]
    - to a kerosene / air burner
    - during a fixed time (5 to 15 minutes)
    - with a standardized flame:  $1100^{\circ}\text{C}$  ( $\approx 2010^{\circ}\text{F}$ ) and  $116 \text{ kW/m}^2$
- Objectives
  - Model fire resistance tests with Large-Eddy Simulation (LES)
  - Improve comprehension of phenomena involved in tests
    - Characterize inhomogeneities inside the torch (burnt gases, droplets)
  - Progress on test modeling
    - Reach a good confidence level for certification
- Difficulties
  - Very different time and space scales
  - Multi-physics and complex geometry
  - Very few studies



Liquid-fuel burner





# Results for a complex CHT case

PhD of L. Boulet



- ▶ **Instantaneous temperature fields**
  - Seems to be lower with participative gases
- ▶ **Mean temperature at the outlet**
  - Adiabatic: too high values
  - Transparent: same level as adiab. case
  - Participative:  $\approx 200\text{ K}$  lower  $\rightarrow$  almost at ISO values
- ▶ **Limitations**
  - Simple chemistry (2 reactions)
  - No model for soot

