



**HAL**  
open science

**Plumier, C., (1749). L'art de tourner en perfection.  
Translated from French into English**

Enrique Wulff

► **To cite this version:**

Enrique Wulff. Plumier, C., (1749). L'art de tourner en perfection. Translated from French into English. 2013. hal-02563057

**HAL Id: hal-02563057**

**<https://hal.science/hal-02563057>**

Submitted on 14 Dec 2021

**HAL** is a multi-disciplinary open access archive for the deposit and dissemination of scientific research documents, whether they are published or not. The documents may come from teaching and research institutions in France or abroad, or from public or private research centers.

L'archive ouverte pluridisciplinaire **HAL**, est destinée au dépôt et à la diffusion de documents scientifiques de niveau recherche, publiés ou non, émanant des établissements d'enseignement et de recherche français ou étrangers, des laboratoires publics ou privés.



CHA.  
R. I.  
TAS

L'ART  
DE  
TOURNER  
EN PERFECTION

*PC*  
LE P. C. PLUMIER  
MINIME

A PARIS QUAY DES AUGUSTINS  
Chez CHARLES ANTOINE JOMBERT Libraire de  
l'Artillerie et du Genie à l'Image Nôtre Dame.

1749

## EPISTLE

### TO MESSIRE **MICHEL BEGON**, HONORARY COUNSELLOR TO THE PARLIAMENT OF AIX, AND INTENDANT OF JUSTICE, POLICE, AND FINANCES of the Pays d'Aunis & Saintonge, & of the Marine of the West

SIR,

As you take so much care to perpetuate the memory of the famous men, who made the ornament of the last century, it is quite reasonable that one perpetuates also yours, and that one makes known part of your merit to the posterity : I would be happy if I could contribute on this by discharging me of the promise made you when I leave Marseilles for my first voyage to America; Non ego te meis cartis inornatum sileri, totve tuos patiar labores impunè carpere lividas oblivions. The great obligations that I have to you and the kindness you had to give your approval when I had the honor to present to you the original at Chastenay close to Paris, would have urged me to dedicate it to you, if I would not been determined by a reason more judicious and stronger, that of your large merit and your rare virtue, that demands more a whole panegyric than a simple dedicated Epistle.

Persuaded of that are so many beautiful Provinces where you have been the Intendant : those which you left cry for you, the one where you manage justice, considers herself happy to have you, and all seek after you. Agent of the King authority, you sustain it with an untiring zeal and a very constant fidelity; as a referee of the people's interests, you disembroil them with prudence, you judge about them with equability. I know that the Peoples of America perceive your Person with such a great respect, that your simple Orders are put in force there as inviolable laws. I know which was the sorrow of the Marseilles inhabitants when you left them for the Intendance of la Rochelle. I have heard the laments of the poor who repeated without coming to an end : We lose a father. In this last I have seen that sweetly you treated even the least of the common people, with which charity you hear their complaints. Although with these qualities own to the King's Man, and to the Father of the people, that you know so well how to assemble with the help of your wisdom and your religion, I can but admire this profound erudition that attracts to you the consideration of all the scholars of the century.

Your rich Medals' Cabinet, your rare Library, are not in your house a vain ornament, but a proof of the extent of your genius. Along the time that you honour me by receiving me at your house, the judgment that I have seen you made on the books, the agreeable and particular detail on what they contain as more rare and solid, would make believe another one that this was your only occupation, but I have had the time to observe, that you sacrifice to the scholarship a period of time destined to rest.

All these rare talents are infinitely enhanced, by your regularity concerning the duties of Christian piety, that you have always make your capital. This Moral purity

appear not only in your Person, and in the education of Sirs your children, but also in the regularity of all the servants who have the honor to be close to you.

I will pray all the life the Heavens to fill you with its blessings ; to give you a long continuance of years, to spread its graces and favours over Your illustrious Family. Those with whom I live with happiness, and by whom you have had some kindness, will not fail to accomplish my wishes, and I will never cease,

Dum memor ipse mei, dum spiritus hos reget artus,  
to testify you in my private individual respectful recognition with which I am

SIR,

Your very humble & very obedient servant, Fr.  
CHARLES PLUMIER,  
Minim.

# TABLE OF CHAPTERS

for the contents in this work

## FIRST PART

*The Elements of the Lathe.*

### FIRST CHAPTER

On the Turner, on the Bench, etc.

### SECOND CHAPTER

On the Perch or on the Arc for the Lathe.

### THIRD CHAPTER

How the Works should be polished.

### FOURTH CHAPTER

How the Iron should be turned.

### FIFTH CHAPTER

On the steel suitable to make tools; with the manner of tempering them, & of sharpening them.

### SIXTH CHAPTER

On the manner of sharpening the tools.

## SECOND PART

*On the simple Lathe.*

### FIRST CHAPTER

On the simple poppets to turn wood and iron between two nails.  
Explanation and detail of the parts of the poppet to turn wood.  
The Poppet to Turn iron.

### SECOND CHAPTER

On the face Poppet, & own to the Face Lathe

Explanation of the former Poppet and of all its parts.  
Explanation of the posterior Poppet and of all its parts.

#### THIRD CHAPTER

Representation of the preceding Poppet  
s, to turn as much between the two nails than to face lathing, posed on their bench.

#### FOURTH CHAPTER

Another disposal of two poppets, and of two various faces to face lathing.

#### FIFTH CHAPTER

Two other manners of face lathing.

#### SIXTH CHAPTER

Two different face poppets, and a different support.

#### SEVENTH CHAPTER

A complete assortment of two different poppets to face lathing, and to easily cut  
screws of all sizes with a crankshaft and a support.

#### EIGHTH CHAPTER

Another different manner of two poppets to face lathing.

### THIRD PART

*On the Lathe to turn figures.*

#### FIRST CHAPTER

On the disposal of the lathe, and of the machines to turn figures.

#### SECOND CHAPTER

On the wheels own to the lathe, and their different disposals.

#### THIRD CHAPTER

Assortment of a crankshaft, and of the poppets own to turn the figure.

#### FOURTH CHAPTER

Another assortment of two poppets, and of a crankshaft to turn figures. On the spring  
and the counterweight.

#### FIFTH CHAPTER

Another manner of assortment commonly called the Chassis, by which one can dispose  
as many figures as desired along the entire length of the crankshaft, with the disposal of  
a wheel. Detail of the parts which compose this Chassis.

## SIXTH CHAPTER

Another assortment of two poppets for the figure. Detail and representation of the posterior poppet and all its parts. Detail of the former poppet and all the parts which accompany it.

## SEVENTH CHAPTER

Various other poppets as well simply to turn in round, as to turn in figure.

## EIGHTH CHAPTER

Very particular assortment for the movement of a crankshaft for figures, which is held and supported through the two ends by two bezels with spring.

## NINTH CHAPTER

On the simple rampant, and on the one for figures, and on the use of the crowns.

## FOURTH PART

*On the engine Lathe for the oval and other figures.*

### FIRST CHAPTER

Assortment to turn in oval.

### SECOND CHAPTER

Assortment of two poppets for the oval figures. Detail of these two poppets and the parts which accompany them.

### THIRD CHAPTER

Singular machine to form the oval. Detail of all the parts which compose this machine.

### FOURTH CHAPTER

Another machine for oval, easier than the preceding one.

### FIFTH CHAPTER

The same machine assembled on four pillars, and laid out to form the oval figures.  
Detail of all the components of the machine for oval.

### SIXTH CHAPTER

Manner of making an oval by means of a ring, and the oval of the tin potter.

### SEVENTH CHAPTER

On the turn driven between four parallel support rings.

### EIGHTH CHAPTER

On the turn with chassis provided with rivet washers.

FIFTH PART  
*On the Machines for the oval.*

FIRST CHAPTER  
On the tambourine box; machine for turning in oval.  
Detail of the parts which compose the tambourine box.

SECOND CHAPTER  
Another tambourine box.  
Detail of all the parts which compose this machine.

THIRD CHAPTER  
Another machine for the oval, less made up than the preceding ones.  
The use of the core.  
Detail of all the parts which compose this machine.

FOURTH CHAPTER  
Expeditious machine for the making of the oval.

SIXTH PART.  
*Figures and Profiles.*

FIRST CHAPTER  
. On the rosettes that serve to turn the works.

SECOND CHAPTER  
Profiles and mouldings.

SEVENTH PART.  
*On the portable Lathes, made in wood or in iron.*

FIRST CHAPTER  
Watchmaker Lathe.  
Detail of all the parts which compose this lathe.  
Design of another portable Lathe.  
Detail of all the parts of this Lathe.

SECOND CHAPTER  
Description of another Watchmaker Lathe.  
Detail of all the parts of this Lathe.



THIRD CHAPTER  
Another Watchmaker Lathe.

EIGHTH PART.  
*On the Works made by pushing.*

FIRST CHAPTER  
Machine for making England's knives handles, or intended to cut diamond points on the  
knife handles.  
Explanation of the machine for making knives handles.

SECOND CHAPTER  
Machine for cutting the columns in network.

THIRD CHAPTER  
Method for tracing and cutting a simple, undulated and gadrooned, column.

FOURTH CHAPTER  
On the simple column.

NINTH PART  
Method to Turn certain singular Works.

FIRST CHAPTER  
To Turn an excentrique piece.

SECOND CHAPTER  
To make with the Lathe a very exact ball.

THIRD CHAPTER  
Diverse gadrooned Works.

TENTH PART  
On the tools and instruments necessary for the Lathe.

FIRST CHAPTER  
On the dies as much in wood as in iron.

Construction of the die for the wood screws.

SECOND CHAPTER  
On saws and compasses.

THIRD CHAPTER  
On the tools that normally are useful at the Lathe.

ELEVENTH PART  
That contains diverse new inventions and researches, on the Lathe, extracted from the  
Memories of the Sciences Academy.

FIRST CHAPTER  
The Machine for making all kind of Polygons on the Lathe. By M. De la Hire.  
Detail of all the parts which compose this machine.

SECOND CHAPTER  
Researches on the Lathe, by M. de la Condamine. I. Memory that contains the  
description and usage of a Machine that imitates the movements of the Lathe.  
Explanation of the Figures that represent the different parts of this machine.

THIRD CHAPTER  
Continuation of the researches on the Lathe, by M. de la Condamine. II. Memory, where  
are examined the nature of the curves that can be traced by the movements of the Lathe.

. FIRST PROBLEM  
Being fixed the contour of whichever Rosette, and the respective position of the centre  
of the Contact and of the tool on the same plan, to find on this plan all the points of the  
resulting design.

SECOND PROBLEM  
Whichever design or contour being fixed by the position of the center of the Contact  
and of the tool, to find on the same plan all the points of the Rosette's contour that must  
produce such a design.

FOURTH CHAPTER  
Explanation of a Turn to make without crankshaft all kinds of screw.

TWELFTH PART  
*Secrecies very useful for the People who apply to the Turn.*

FIRST CHAPTER  
To make and mould, Boxes or Snuffboxes as well of shell, as of horn.

To melt the horn and to mould it.  
Another manner of softening the horn and the bones.  
To soften the shell or the horn and to mould it.  
Other for the horn.  
To weld the shell.  
For tighten a Snuffbox too loose.

## SECOND CHAPTER

Secrecies to mould and colour the bones and the ivory.  
To soften the ivory.  
To dye the softened ivory.  
Otherwise.  
Other.  
To soften the bones.  
To harden the bones after they were softened.  
To dye the bones in red and to make various works thrown to the mould.  
To melt the bones and to make such works of them as one will want.  
To colour the bones in green.  
To dye the bones and the ivory in emerald green.  
Another manner.  
To dye the bones in green.  
To dye the ivory and the bones.  
To redden the bones and the ivory.  
To marble the ivory.  
To bleach the damaged ivory.  
To bleach the green ivory, and to whiten again that which became russet-red.  
To bleach and degrease the bones.  
To blacken the ivory.  
To dye the bones in black.

## THIRD CHAPTER

On the preparation of the wood intended to make works with the Turn and on their dyeing in different colours.  
Preparation of green woods, before employing them, to prevent that they are not split.  
To harden wood.  
To harden and petrify wood.  
Water to dye wood.  
To give to the wood the color that one will want.  
To give the wood an ebony color.  
Another manner of dyeing wood like ebony.  
Another manner for the hard woods.  
Wood color of drowning.  
Ebony color.  
To make a beautiful black on wood.  
To give to wood the Brazil wood color.  
Another purple on the white wood.  
To dye wood in red.  
Crimson color.  
Blue color.  
For the green.

To dye wood in yellow.  
Other.  
Other for the yellow.  
To give a beautiful color to the wood of the Chairs.  
To counterfeit the root of drowning.  
To imitate inlaid wood.  
To marble the wood.  
To marble and to color in various hues the wood.  
To print on the wood of the foliage and other ornaments.

#### FOUR CHAPTER

On the genuine Varnish of China for applying to wood after polished with the Lathe.  
On red Varnish made with lacque gum.  
On the white Varnish made with gum sandarac.  
On the Preparation of wood for the works in the manner of China.  
Application of the light colors.  
Application of the dark colors.  
On the polishing of Varnishes.  
Other very beautiful Varnish of China.  
Dissolution of Yellow Amber for Varnishes.  
Varnish of lacquer gum.  
Excellent varnish of Mr. Ward, English.  
Varnish of China of all colors.  
Varnish of China quite beautiful.  
Other Varnish of China for all kinds of colors.  
Varnish as beautiful as that of China.  
French Varnish.

End of the Table.

## APPROVAL

Of Mr. BELIDOR, Royal Censor, Former Professor of Mathematic at the Artillery Schools of Fère, etc. etc.

I have read by order of my lord the Chancellor a work entitled the Art of Turning, by the Fr. Plumier. The regard which the public made of the first Edition marks enough the utility of the second. In Paris, April seventeen, one thousand seven hundred and forty six.

BELIDOR

## PRIVILEGE OF THE KING

LOUIS, by the grace of God, King of France and of Navarre: To our Loved and Loyal Advisers, the People holding our Parliament Courts, Masters of the Ordinary Requests of our Hotel, the Large Council, Provost of Paris, Baillifs, Seneshals, their Civilian Lieutenants and other of our Dispensers of Justice who it would deserve; SALUTATIONS : Our so Loved, CHARLES – ANTOINE JOMBERT, Bookseller in Paris, has given us proof that he would desire to reprint and to supply the Public with the Books that have as Titles : Oeuvres de Mathématiques de feu M. Ozanam, de l'Académie des Sciences, Secrets des Arts & Métiers, le Teinturier parfait, l'Art de la Verrerie, l'Art de Tourner, par le Pere Plumier, if We liked to grant our Letters of Privilege on this in need : TO THESE CAUSES, favorably wanting to treat the Exhibitor, We have allowed to him and allow, by these Presents, to make reprint the aforementioned Books in one or more Volumes, and as many times as he would like, and to sell them, to put to sell them and to retail them by all our Kingdom during the nine consecutive years time, to be counted from the day of the date of these said Presents; We make forbid to all kind of persons, whichever quality and condition they have, to introduce the foreign printings in any place of our Obedience; like also to all the Printers and Booksellers, or others, to print, to make print, to sell, to make sell, neither to counterfeit the mentioned Books in its totality, nor as a part, nor to make from it any Extract under whichever pretext, on its increasing, amendment, changes or others, without the consentement explicit and written of the mentioned Exposant, or of those whom will have right from him, to a punishment of confiscation of the counterfeit Exemplars, and of three thousand pounds as a penalty facing each of the offenders, of which a third to Us, a third to the Hôtel-Dieu at Paris, and the other third to the referred Exposant, or to whom will have rights of him, and of all expenditures, damage and interests; at the charge that these Presents will be recorded in all its length on the Register of the Community of the Booksellers and Printers of Paris, in three months from the date of these ones; that the reprinting of the aforesaid Books will be made in our Kingdom, and not elsewhere, in good Paper and beautiful Characters, in accordance with the printed sheet, attached as a model under the counter-seal of the aforesaid Present; that the Applicant will conform in all to the Regulations of the Bookshop, and in particular to that of April ten, 1725; that before to expose them on sale, the Manuscripts and Printed matter which will have been used as copy to reprint the aforesaid Books will be put back to the same state where Approval was given, be hands of Our much loved and loyal Chevalier le Sieur Daguesseau, Chancelier of France, Commandeur of our Orders; and that then it will be given two Exemplars in our public Library, one in that of our Chateau du Louvre, and one in that of our much loved and loyal Chevalier Daguessau, Chancelier of France

# THE ART OF TURNING IN PERFECTION

## *FIRST PART* THE ELEMENTS OF THE LATHE

### FIRST CHAPTER On the Turner, on the Bench, etc.

My purpose was not to write so long on the Lathe, & the Works that can be performed with it; I was satisfied to discover to those who like this noble exercise, the most secret procedures that the Curious & and the Wises in this Art have hidden with so much care. With this effect I have searched for the most skilful Turners; & along the long journeys that I have made, I have drawn after the original of all the machines that I have been able to discover, or that even some have guess it for me. After that I have made a quantity of trials in order to see if they answer to my thoughts, as I do not like to give to the Public nothing that I did not carried out myself before. At last, having almost concluded my Work, my friends have compromise me to give the principles or the elements of the Lathe, based on that my book as it is full of curious and rare machines could nevertheless fall into hands of persons, for whom, although showing profound intellectual penetration, it would become as useless, if they are not led step by step on the principles. In so doing they could improve themselves in an Art that requires the supervision & the lessons of a clever Worker. As much as for my book's perfection, as to conform with my friends sollicitation, I have agree in providing the detail on all that must know a person willing to be distinguished by his use of the Lathe.

First a enlightened place must be chosen, (*first Plate*) so that one can well look his work, & that as much as possible, one has the light of the day of front and by the side; & that the last is preferred to the former, as it is always the most advantageous. That the Lathe's bench is well strengthened & motionless, that it is at least raised until the belt, & that the headstocks have such a height on the bench, that one must not be obliged to bring down his own body, in order to see his work, but not so much brought up, that the work is too much close to the face, as it is afraid that the little chips of wood that are produced by working, do jump to the eyes. Lastly, each one will be able to establish the height of the Lathe after his body's bearing & after his sight.

As all the Lathe's science depends on round turning, as the Workers say, it is very important, that who wants to apply himself to the Lathe, well knows how to dress and redress his own piece of work. What must be do with a chopper or a hatchet, of which one of its sides must be flat, & the bevel with the right hand, in order to take only as much

wood as it is necessary, for what guard should well be taken. But for a greater safety, one will make use of a rabble according to the quality of the matter, or of a knife of barrelmaker. One can also make use of a rasp; & having clamped the workpiece in a vise, one will bring it of an equal thickness, as much as possible, and by holding it a little thicker than the drawing than one wants to carry out, it will become proper to be put on the Lathe; but before fixing it at it, both extremities's centers must be found, and that the centers are so well opposite one with other, that the workpiece that turn by the two points of the Lathe, is not higher on a side than on the other; & this is the way of exactly finding the two centers.

The workpiece which one wants to turn, rounded with the axe, the grater, or differently (*Figure E*) or only squared (*Fig.L.*), must be fixed to a bench or a Board (*Plate II. Fig. I.*). Having opened the compass F or Q, towards the half the thickness of the workpiece. It is necessary to hold with a hand the compass, laid down on the bench or the board, by making that one of its points R or S touches the bench or the board, & that the other point I or Q touches the end GHJK or MNOP of the workpiece; then trailing the point R or S of the compass on the bench, & the other point I or O being as little forced as possible, will trace a line IH or ON on the face of the extremity of the workpiece. If it is rounded, one will turn the workpiece four times in four distances, almost equal G, H, K, I, and it will be traced over its extremity four lines GK, KG, HI, IH, which intersection V will give the centre of the extremity exactly. That if the workpiece is only squared like L, it will be turned on each of its faces, & as much of times it will be traced in the same manner than with the rounded one, the lines MP, PM, NO, ON, which intersection X will be the center of its extremity. The same operation must be performed at the two ends of each workpiece, & thus it will be obtained the two opposed centers. After having found the two centers, a little spike must be pushed in on each one, in order to make a hole there being appropriate for the extremities of the headstock's spikes, of which the one that is pricked by the point F of the headstock A (*Fig. I. Plate III*) which is on the left of the Turner, being well fixed, the Turner will place the other extremity at the spike F of the headstock B, & he will consolidate so well the one that remains him on the straight line B by striking with a mallet the corner or the key S, that the workpiece 3 become immovable, but that nevertheless it can be turned without making any somersault. So that if after having posed and tightened the key S, the workpiece gets to totter, he must but to give some blows of mallet to the back of one of the headstocks, to make it bring closer to the other until that the workpiece does not totter anymore. This consolidation is very necessary; because other that one would not be able to round turning, danger of spoiling its own work would occur.

Thus once posed and consolidated the workpiece, the chord should be adjusted, at least making two turns around, as number 3 represents; however in such a way that the two ends of the cord 1 & 2, namely that which is tied to the arc or to the perch and that is noted by 1, & the noted by 2 which is tied to the pedal, are at the right side of the Turner like the chord 1,2 at the workpiece 3 of the Plate III. Fig. 1, so that by lowering the pedal, the movement of the workpiece come facing the edge of the tool, so that the tool can bite the workpiece.

One can even adjust the cord on the workpiece before putting it between the two spikes, holding the workpiece with a hand and adjusting the cord with the other. That if he does not

want to take the trouble to seek the centers according to the preceding way, by judging in the eye the centers of the workpiece, he will present more or less the center of an end to the spike of the headstock in the left side, and will advance the headstock in the right side by striking it with the mallet, until its spike prick closely the center of the other end of the workpiece; having thus softly stopped the right headstock by a little blow of the mallet on the key, he will give a kick to the treadle to make turn the wood, & to judge in the eye if the workpiece is well centered. If he sees when turning that the workpiece is bent, he will strike softly with the mallet the place where it makes highe, until he recognize that his workpiece is on the turn; then he will give a little more strong mallet blow to the back of the headstock so that the two spikes penetrate decidedly in the wood, & also he will give another blow on the key, to stop fixedly the headstock. But those which by fault of practice are not able to judge if their work is right on the turn, will press softly the spike of a tool named *barley corn*, shoring it on the rule or support, that will indicate with a line there where the workpiece is out of its centre; then striking at this line, it will easily put the workpiece in the situation where it must be.

The support, or the rule on which I have just spoken, must be put on the two arms EE, held by the two rods I, I, & buttressed by the rods GG, that are stopped by the screws KK, so that the rule is unmovible & the closest to the workpiece that one wants to work; what it is necessary to make generally all the times that one turns.



## SECOND CHAPTER

### On the Perch or on the Arc for the Lathe.

The Arc, or the Perch, are for the Turner what is the feather for a Writer, that is to say, so indispensable that it is impossible to do without it. One can make use of the one & of the other, by attaching them over the Lathe; in such a way, if it is an arc, that it is in same parallel line that the leads of the lathe, or if one makes use of a perch, it must be almost perpendicular in the middle of the leads; & that the extremity by the side of the Turner advances the minimum beyond these same leads. One usually makes these arcs or these perches of wood of ash, beech, yew, maple; & particularly of box, which is always the best, mainly if one finds some without node.

Thus the perch must be a piece of wood of right design, length from 7 to 8 feet, from the thickness of the arm in its large end, going in reduction until the other end, & a little flat by the lower part in the manner of a hoop. One bores it in its large end, & one stops it with a round iron card, to a piece of wood attached to the floor, in such a way that it can turn. It must be supported approximately towards the third part of its length on a wood rod a little larger than the arm, long approximately of two feet, & stopped horizontally by two wood posts attached to the floor.

The arc is also a piece of wood with a dimension of five feet length, with the thickness of the arm by its middle, plane underneath, & since the middle, going in reduction until each of the ends; and from one end to the other is attached a cord, which as is well bandaged, hold it curved like an arc of circle.

The cords are so necessary as the perch, & the arc. Those made of guts are very good, but as it wears out enough, & and that they are expensive and rare in many places, one will make use more conveniently of cords made with the finer hemp or with flax, well twisted, & of approximately a line and half of diameter. One from time to time moistens them with common water with a sponge in the place where they work, so that they last more.

The workpiece being halted between the spikes of the headstocks, the cord adjusted &, the support emplaced & halted as close as possible to the facility without touching it, one will take a gouge with a size in proportion to thickness of the workpiece, that will be hold with the left hand, by the handle tilted a little, the body free, right ahead, with no support in any back (what I do not counsel to those who begin), & by pressing decidedly the spike of the gouge on the support D, (*Fig. 2. Planche II.*) one will put the cutting edge a little more high than the horizontal diameter *ab* of the workpiece A, **as if one** would like to make a tangent with the curvature of the workpiece; then by pushing with force the pedal with the right foot, from the highest one can bent the leg, to the lowest that one can stretch out it, & by leading with the left hand the gouge firmly and assuredly on the support along the workpiece, one will cut the wood cleanly.

The workpiece being thus polished or sketched with the gouge, one will take a chisel, or a plain. It is a tool long & flat tool in its extent, right and with cutting edge in its extremity. This is a double bevel cutting edge one below & one above like an L (*Fig. 10. Plate II.*) where this tool is represented in what makes its thickness. There is of two kinds, one which edge is a little biased like a K, that is represented in its width, & it is what one properly calls a chisel; & the other one which cutting edge makes two right angles with the two sides like a B, & it is what one call the Plain. So one will hold the chisel in the same manner than the gouge, so it is to say, by holding the handle with the left hand, and by grabbing the iron with the right hand, as close as possible to the cutting edge, & with the same inclination than the gauge, by observing that the cutting edge of the bevel B, (*Fig. 4.*) is not parallel to the line of the centre of the workpiece A;

But rather laying with a little bias to C; so that the cutting edge bites better and with less risk to spoil the work. Some warn must be observed when wanting to cut a quart of round F (*Fig. 5. Planche II.*) on the workpiece D, so that the chisel E must be conducted with a great firmness, & always cutting the wood with the middle of the cutting edge b. Caution should be taken that the wedges of the chisel do not touch the work, because false dashes like those that make ordinarily those that are conducted by the tool would result. It also should be expected that the turned wood is evenly cut, & not badly to strongly push the tool once and not in another occasion; & not to follow the work, what means, to leave alone his hand; & it is the defect where fall almost all the new Turners, who being satisfied to make cut their tool, never turn neither roundly nor evenly; but the usage will teach them this familiar observation if they study the handling of the gouge & chisel, which, indisputably, are the most used & necessary in this Art, especially to the simple Lathe between two spikes. Otherwise one cannot work well on tender and teilleux wood, which are only turned by cutting, only by means of these two tools; because for hard wood, or solid materials, like the box, the horn, the ebony, the ivory & almost generally all the metals, they are hardly turned but by raking or scraping. So, one makes use of some slightly different tools, which one can report to three kinds, & it is always with these three tools that can be made all these kinds of works. The first is the *cross-cut chisel*, of straight face A, (*Fig.6. Plate II.*) The second is another *cross-cut chisel* or *rabot* of round face B, (*Fig.6.*) & the third is a barleycorn, C, (*Fig. 6*) with three sides or cutting edges. It is necessary to have of different size or width, namely larges, small, & means. Their use is extremely easy, since the material must only be scraped, & not to be cut as in the case of the chisel & the gouge. It is why it should be observed that during the work their situation must be different; because they must be held horizontally, it is to be said, that their higher face is almost in the same plan, than the horizontal plane which would cross the middle or the centre of the workpiece, like FGE (*Fig. 3. Plate II.*), where the tool FG makes but one same line with the diameter or horizontal plane cd that would cross the workpiece E. However as all the mouldings which one can make with the Turn on a part, can be only right or round, it is enough to know well the use of these three tools, to make any kinds of works. Because firstly with the straight cape chisel A (*Fig. 6*) one can make a platband X, (*Fig. 7.*) & with this same tool one can round a astragal or roll Y, by leading the cutting edge of the tool sometimes to right, sometimes on the left. The rabot or round cape chisel B, (*Fig. 6.*) is used to cut the round hollows or nacelles Z. Still, the barleycorn C, (*Fig. 8*) can be used to cut the round as well as the flat, by leading the cutting edges biased, sometimes on the

right, sometimes on the left, as one sees it in ST & V, (*Fig. 8.*) & so that these three kinds of tool can be useful more conveniently, and be preserved longer, their bevel must not make an angle too much dull like ABC, (*Fig. 9.*) nor too acute, like DE, but that it approaches as much as one will be able at an angle of 45 degrees, like FGH (*Fig. 9.*), & in this way the cutting edge will last longer, and will render the work more well defined.

In addition to these five kinds of tools, namely the gouge, the chisel, the straight cape chisel, the round cape chisel, & the barleycorn, one still makes use of another of a very particular construction. Truly the use is a little difficult in the beginning, but also when one has learned how to use it well, one is expeditious in the works. It is a kind of hook HI, (*Fig. 11.*) with double cutting edge to be able to make use of it on the right and on the left. It is nevertheless only good for large works, & especially to dig large wood crockery, like mortars, bowls & basins. Italian usually makes use of it, & they call it *il Grampino*. These are the most common tools & most necessary of the Lathe. It is not that one do not need an infinity of others to carry out a thousand of beautiful thoughts which one imagines every day on the Lathe, but as almost all are reduced to these ones, I will not speak about it for the present. I will however give at the end of the book the figure of several kinds, which will serve as a model on those that one can need.

### THIRD CHAPTER

#### *How must be polished the Works.*

The work being entirely formed, it is necessary to polish it. However as it is quite difficult to give it the last finishing, & union with the tools on which we have just spoken, necessarily it must be used of some artifice to polish it, & to make it perfectly united according to the various materials. Because the tender and *teilleux* wood, like pear tree, walnut tree, maple, & C. should be polished only with the skin of dogfish, or with the *presle de montagne* (scouring rush?). The dogfish is a species of fish, and there is of two kinds: The one which skin is greyish, and it is what we properly call dogfish (*Chien de mer*) in French & in Latin *Canicula Aristotelis. Rondelet liv. XIII. Chap. VII. Pag. 380*. The other species has a reddish skin, & it is because of this effect that it is commonly named *roussette* or *tanelle* in French, & in Latin, *canicula faxatilis*, in the same Rondelet, same book, ch. VIII, pag. 383. One and the other of these fishes comes from our seas of Provence, where they are called, *blue dogs* (*aguillats*), *cat-sapwoods* (*cat-aubiers*) or *dogfishes* (*roquiers*). The most worn-out skin is always the best. The new one is not so appropriate because of its roughness.

For the *presle*, it is a plant that is brought to us from the mountains, where it is born in the wet places. Its stems are naked, simple, round, thick, almost like feathers to write. They all are laid out by nodes, & are hollowed like the reeds. It is properly the species in need to be used; because the others are only good to clean the crockery. One calls it in Latin *Equisetum solis nudum, non ramosum, sive junceum C. B. Pin. 16*. the oldest is also the best, but before making use of it, it should be moistened a little bit at least, otherwise it ruffles itself totally, & the softening and the conclusion of the work is difficult. One makes use of it similarly to unite the hard wood, like the box, the gaiac and the ebony, but after they are pressed and cleaned, they should be slightly rubbed with wax or a little of olive oil, that one wipes and that one rubs after that or with chips of the same wood, or with a piece of chamois skin or a little worn fabric.

The ivory, the horn, the silver or the brass, are polished with the pumice finely crushed. One puts it on chamois or on a little of wet linen, then one rubs the workpiece at the same time as one turns it. And for better seeking the angles where there could remain some filth, one makes use of a small brush soaked in water, with which one gently rubs the workpiece while turning, until so that there is no more filth. But to lead it to a greater polish, one will make use of tripoli, then of putty powder or lime of tin. The iron and the steel are polished, with quite fine powder of emery slime; one mixes it with oil, and by putting it between two pieces of a quite tender wood, one will rub well the workpiece. For the tin and the silver, one does not polish them but with a burnisher, or by this red stone that is called *red sanguine*. One can also polish them with the putty powder, putting it dry in a chamois leather, or in the palm of the hand.

## FOURTH CHAPTER.

### *How to turn iron.*

The importance of having a crankshaft or mandrel of iron exactly rounded, to turn with the required accuracy, and the impossibility of being able to do it with the file, has made me look for carefully the Workmen who knew how to turn & to cut iron reliably. But despite the research that I made in all my voyages, I met only two able to satisfy me; the one in Rome, German of nation, called *Il signor Guillelmo*, employed in the factory of coins; & the other in Paris, called the sieur *Pierre Taillemars*, Mathematician, & whose name is well appropriate because of the virtue & the address, since without making use neither of the hook, nor of the wheel, but well by the foot & the perch, with a tool with two bevels, at the Lathe with two centers, or with the mandrel, at the Lathe with two centers, or with the mandrel, also he cuts the iron & steel into chips of wood as large as, & as reliably as the sieur Maubois, this famous Turner of the King in Louvre, cuts the ebony & the ivory. I saw him even cutting in very little time an iron screw of three inches in diameter on four feet & half of length, & which square-pitch had a depth of four lines & half, & a broad of half of an inch. His only secret is just to oppose to the resistance of the hardness of iron or steel, a proportioned power, & this by the solidity of the Lathe & by its support. The construction of his chisel with two bevels also serves him a little, as it has just one line & half of broad on approximately five of height, & being cut only on the angle of forty five degrees. In addition he chooses the finest steel of Germany, which he strongly soaks, reheating it only when it is on the yellow. He sharpens it only on the grinding stone, but strongly: & by holding it very firmly on the support, he inclines it in such way on the workpiece, that only he takes so many parts of iron as he can remove according to the force that resists him. But in addition to the solidity of its Turn & its support, the tempering & the shape of its tool, he proportions the length of its pedal to the size of the workpiece which it turns; by holding it long if it is thick, & shorter if it is small, he pushes it vividly & not abruptly, nor precipitately, & each three blows of pedal he wets its tool in fresh water, by fear that when warming up itself it become softened.

The way of turning the steel & the iron of the sieur Taillemars, having been taught above, requests a very large firmness of fist, & an address as peculiar as the one with which he is gifted to turn & polish with only three tools; the straight chisel with two bevels, the round, & the **barleycorn**, any kind of iron work with screw & mouldings, without making use of files, of emery & putty powder. I will however give a rather sure & easy manner that I have practised even successfully, to turn iron and to make my mandrels. For thus succeeding well, it is necessary firstly that the Lathe that you use yourself, is very strong in all its parts, is strengthened by hillocks against the wall, & the floor, short headstocks, & the support of a piece of wood **put as an end** & stopped by a strong support of iron with a key or corner as close as possible to the work. It is necessary also that the back of the support is so high from two to three lines only over the center of the work; that it is cut out in relay by front, to put there the tool with hook *ae*, such as one sees in *Plate III. Fig. 2*. There will be several of these kinds of tools in various ways, of straight face, round & pointed, or in **barleygrain**.

The Lathe & the tools being so prepared, it should be determined the thickness & the length of your crankshaft or other parts according to the requirements of the works which you have the intention to undertake, & to make from it a wooden model, a little larger of one or two lines than it should not be. Afterward require to forge one similar the best workman than you will be able to know, & of the most excellent iron than you will be able to find, namely, that is not new, but wrought &, well beaten with the hammer, & mainly, that it has neither straws nor cracks, nor overheating; I say that it must be quite wrought because new irons usually, & that were not well beaten with the tilt hammer, still contain round drops coming from the forge, & it is what the workmen call the grains, which blunt it the sharp edge of the tools when one turns, make them break, & remove their cutting edge, finally making that the tools slip over it. The irons of this nature are called **iron misers** by the good workmen, on which neither file nor tools could bite.

Having thus found of good iron, you must forge it well, & so that it becomes more soft, it would be good to heat it with coal of wood, because the coal of stone, in addition that it usually burns the iron, if care is not taken, contains in itself sulphur which makes it sour, making it harder and brittle. That if in the forge one discovers cracks, it is necessary to make them cover with a little fatty ground, and having made give to your iron a sweating heat, it is necessary to weld it well by small blows of hammer at the beginning, & then, when it is welded, strongly to strike it.

Being your crankshaft welded & forged in accordance with your model, you will make him give an annealing, it is to be said, to softly make it redden cherry color, & thus to let it cool on the same coals until that they extinguish themselves, & the iron is cooled by itself. I have seen workmen, who to anneal and tenderize iron covered it with clay or fatty ground, like when pack tempering, & they let it cool in the ground.

After you will have made annealing your crankshaft or piece of iron, you will lay out it to put it on the Lathe, firstly by seeking the centers of the two ends with a compass, & having found them, you will throw a great blow to the center punch in the part of above. And with a drill you will deepen them approximately of two lines, so that they do not escape from the pivots, which must be short, quite sharp-edged & well tempered, that the base is one inch in diameter at least, & the length of as much. The **square shank** crossing the headstock, & filletted at the end to be stopped with a good nut; finally such as X or M in the Fig. 2. Your crankshaft being posed on the two pivots, you will gently slip over the hand, & will make it turn, to see whether it is well posed in its centers, & so if while turning it hops, or it makes belly, having noticed the place, you will approach the center by widening it with the punch on the side which it makes belly, if you do not like better to file this side until it becomes rounded, or without seeking all these ways, you will be able to carry the inequalities with the hook while turning, as here will be said afterwards. But before of turning it, it is necessary to adjust a wood pulley from five to six inches in diameter, & of approximately one inch in thickness. You will stop it well by corners in the middle of the crankshaft, by taking care to pose it with right angles with the crankshaft, by fear that when turning it, it does not let to slip the cord from its slide. Then having made passing the cord of the large wheel above, by making it cross in the manner of the cutlers, you will stop your crankshaft or workpiece on the headstocks, by pushing the keys with blows of mallet, by fear of some shaking. Then, you will put some oil drops at the two ends of your crankshaft, that thus will

be ready to be turned, & since along the turning the oil becomes dried because of the heat of iron, it is necessary from time to time to add more of it once again, for fear that the pivots of the Lathe are not spoiled, & thus that the centers of your mandrel do not vary.

Once your crankshaft adjusted on the Lathe, & ready to be turned, you will make turn the large wheel by two men if it is necessary, & resting the back of a hook with straight face on a groove or relay of the support, you will present one of the corners of the known as hook (which you will have firstly soaked in water) a little over the center of the work, but **à petit fer**, it is to say, a little softly, & by this means you will carry away the inequalities of your crankshaft; then taking another hook with round nose, you will more easily outline your work, & when your tools, will have worked a little, & that they will start to warm up, you will dip them into a full of water vase, that you will always hold near you so that it is more comfortable for you. Then you will take again another hook wet in the same way, & when your work is drafted & particularly round with the hook with round nose, you will take some with straight face, with which by all the extent of its edge you will carry away the traces that the round hook had left there, & thus you will level well your work, on which you can make the moldings that you wish with the **barley grain**, then you will polish it with the well crushed emery, & put with oil between two sticks, as I have previously taught.

Your crankshaft or mandrel being well rounded, & provided with all its moldings, if you like to pierce it in cannon, you will remove one of the poppets with pivot to substitute in its place a poppet with broken glass, on which you will put the neck of your crankshaft. But it must be adjusted in such a way that it does not oscillate in at all. Being established the crankshaft or mandrel, you will take small **drills with nose cut**, & **with double bevel**. Like those that the metal workers use to drill a key, & by starting with a small, then by a larger, you will pierce it to the size, & depth that you will judge to be necessary for you. It is necessary to have a great care to hold the drills resting, & firmly against the support, otherwise one is in danger that the opening does not throw more on one side than on the other. It is also necessary to have care to withdraw the drill from time to time, either to make remove the filings, or also to oil it so that it cuts more easily, & that it is not softened when warming up. And because it is quite difficult to pierce well concentrically with the drills, you will rectify your opening in this manner. It is necessary to take a squared tool, much less thick than the opening of your crankshaft is large, sharp-edged along the length of one of its sides, Z & X (*Plate IV*), quite sharp and well tempered, & **emptied by its middle at least in channel**. This tool is properly similar to a gouge which would cut only by one of the sides of its groove in the sense of its length. There is no tool that is worth what this. It makes about the same effect of those large drills, which are used to clean the cast iron cannons. You will furnish for this effect this tool with a little long sleeve, so that holding it between the armpit and the arm, you use it with the two hands with more firmness & with assurance. In this manner you will remove all the irregularity which will be in the direction of the opening.

It does not remain any more for the whole perfection of your crankshaft or mandrel but to cut there the pitch of the screw, what can be do in diverse places, & in different manners; because some cut them towards the tail, & others towards the neck. But in any share that one lays out them, it is always necessary to well round the part with the Lathe. Some people employ to cut the screws on a crankshaft a double threader; what however is not always

safe, because for little that one presses violently, or that one slants himself a little more on the right than on the left when driving the threader, one endangers oneself of breaking his part, as it very often arrives. To avoid this danger, some people do not finish to fillet the crankshaft with the threader; but being content by tracing the first mark, they deepen it with a file, & afterwards they end to clean it with the same file on the Lathe between the two pivots. But one can act differently; & here it is the most safe method. Take the tarots AB (*Plate IV.*) that are filleted with precision, & with the size of the screw pitch that you wish. While having put C in the opening that you made at the collet of your crankshaft D, you will weld it well with tin, salt ammonia & pitch resin, & as more in the center as it will be possible for you. Then take a poppet provided with a broken wood face K (*Fig. I.*), with which you will embrace your tarot C, which by its sliding into this broken wood face, will take there its step by itself. Previously the crankshaft shall be well established horizontally, & in straight line with the two centers of the faces, so that its play is quite equal & free, to advance & to recoil. After having placed well your crankshaft D between the two faces KL you will approach the support M as much as you will be able of the place where you want to cut the screw. Then you will nail two nails as a pivot aa, on the back of the support M opposite the place where you want to cut the screw, & so distant the one from the other, that your tool C can be placed just there, & held in a quite stable way. Instead of the two nails aa, it is better to notch on the back of the same support M a small cross channel b of the width of your tool c, so that when the crankshaft D will advance or will recoil, the point of the tool is steadfast, & so that you trace only one line; otherwise there is danger that the point of the tool by faltering just a little bit, you do trace various lines, what would tire you beacoup to cut a quite neat screw. In addition to that your tool c or FH must be quite sharp-edged, & its end H must form actually an angle of sixty degrees, like one of the angles of the equilateral triangle P. In this way the full one & the vacuum, or the channel & the edge of your screws will be perfectly equal R. That if you want that the edges are quite cutting, & the channels quite profound, it is necessary that the end of your tool is of an angle a little more acute, like angle 2 in the isoscelles triangle Q. Then you will have the channel quite profound &, quite sharp and acute edges. There are some people that, once having drew a simple line & that they have just a little deepened with a barleygrain c, they finish the screw with a comb with three teeth 3.4. spaced after the pass that they want to make, & others which conclude it with a three square file, or triangular file; but it is the way the less just. For the screw in the opening of the neck of the crankshaft, it is necessary to make use of a pivot with hook N, & same angle O as the first H, after having strengthened it well between the two nails aa, or in the channel b of the support M, you will trace your screw, & will finish it with the same pivot N, or the comb with three teeth 4. This manner of halting the pivot or the comb on the support, is just only for helping those which do not have a wrist strong enough and would be prone to make several false traces. Because above all it is necessary to take guard in getting a good start, and to follow well its first trace. It is why those which do not have a wrist strong enough, nor enough skill to hold the tool quite assured, it is necessary that they provide themselves with some method to consolidate it well; otherwise they will spoil all, & will never have pleasure in their action.

This manner of cutting the screw is the justest of all which can be used for a crankshaft of iron, & in the same way for one of brass. The one of the double threader must be rejected, as I have already said, because of the effort that one needs to make to make it bite; what always puts you in the danger of decentering your crankshaft. I would like much more the



following manner, in spite of being very mechanic in itself. Truly it is quite difficult to take the right steps and in the required exactitude, but at least one is not in danger of decentering his crankshaft, as one can be by the preceding way. I have carried out it several times being at the countryside & in the need for tracing some screw without having neither **tarost** nor threader. Cut for this subject a small paper band of such length & width which it can cover well just all the space that you wish to thread. Then mark on the two edges DQ, FG which must join on the workpiece, the size of the screw with a compass Qilnp & Ghkmoq, & c; having marked all the two edges DQ, FG by equal spaces, draw from the first point Q a straight line at the second point h of the edge FG, & from the second point i of the edge QD another line ik at the third point k of the edge FG, & so on until the line r F. You will have several oblique parallel lines & equally distant one to each other. You will stick then your band of paper **traced in the way on the turrillon** or part that you want to thread, but so that the two edges DQ, FG, touch each other without surpassing themselves. Then all the extremities of the lines that come to mutually meet themselves, will do a much exact pass of the screw. It is to say, a simple screw trace that you will then mark on the iron with a simple knife just notched with the cutting edge of another knife, what will give you a kind of very thin file. Once the first trace has been made with this slightly notched knife you will take a little file to split, & following the first trace you will start to enlarge it, so that you can conduct there with more reliability a little three square file, that will make advance your work. Then get a comb similarly spaced with the measure with which you want to shape your screw; as the crankshaft has been put between the two pivots of the Lathe, you must advance the support as close as you can to the place where your screw is traced. You will pose there your comb above, & having inserted the teeth of the comb in the grooves which you have traced, you will make turn your mandrel with the foot & the arc, & will lead the comb according to the traces which you formed with the three square file. Care must be taken to not force the comb neither on the right nor on the left, but advancing it only ahead to make it cut & often putting at it oil, you will see your screw being formed quickly & being formed by itself.

Since I have showed to trace the screws on the crankshaft or mandrels, it is also in the course of things that I teach the manner of cutting the **combs** that serve to form the screws on the works, they are of two kinds that are called *male & female*. The male is the 4, with which one digs the screws in the inside of a box, & the female is the 3 that are used to prune them outwards. For the first one, cut a tool with hook, but whose edge must be straight, turned towards the left, & with enough length to be able to notch five to six screw passes at most, especially if it is for small & fines screws; because for the largest ones, it is sufficient that it is long enough to be able to notch three or four there.

It is needed that the edge is not soaked, but well sharpened. Pose it then transversely on the screw of your crankshaft of which you want to have the pass, & holding it quite assured, strike its back with a small blow of hammer, the edges of the screw of the crankshaft as being quite sharp & keen will print small notches on the cutting edge of your tool so distant between each ones, like the pass of the same screw. You will do better this operation on a well hardened steel **tarost**, & with the same pass than the screw of your crankshaft. After you will have marked these small notches, take the same notched knife which you have employed to make the first trace of the screw of the mandrel, & at each notch trace a line on the bevel of the tool, perpendicular has its cutting edge. Having traced as many lines as notches on the edge of the tool, do widen them in the same way as you widened the passes

of the screw of your crankshaft, this is to say, by hammering them with a small three square file, until that the edges are sharp. If you operate well just & exactly, that your edges are also well deepened, & equally distant between each other, you will have also a comb quite right & being appropriate for the screw of your crankshaft. You will follow the same method for the female comb, with this difference that its cutting edge must be at the end of the tool just as the one of a chisel with two bevels; & that instead of the blow on the back of the cutting edge of the first to make print the passes of the screw, it is necessary that you give the blow of hammer on the end of the handle of this one.

## FIFTH CHAPTER

On the steel suitable to make  
tools; with the manner of tempering  
them, and of sharpening them.

The experience shows each day that the good tools make the good Masters, like is ordinarily said. Indeed, it is important that those that want to have pleasure and honor in their works, are provided with the best tools. For this subject, it would be necessary that the Lather knows how to choose the best steel; but as this is rather on the side of the iron workmen, like Cutlers, Edge-Tool maker & Metal workers, of having this knowledge, & of taking this care, I will not halt myself to treat on the nature & on the marks of the good steel. However I will say that between the various steels that are seen in France commonly, I have never met best than the named *steel of the rose*, & *the bristle of pig* (*acier à la rose, & le foye du cochon*), because when the balls transversely are broken, one discovers in the medium a black round mark, & bluish, or a rusted spot, & about of the color of the bristle. The steel that one brings to us from Germany, passes for the most excellent, particularly the one from the province of Styria; but it should be treated gently with fire, what does mean, tempered over moderate heat, reddened only of cherry color, & returned into gold color, for whatsoever tools that may be, as much for the wood, the ivory, & the iron, than for any other matter. In absence of the one from Styria, I prefer the one called *steel of Piedmont*; but manufactured in the Dauphiné. It demands more heat when tempering. It still comes rather good from the side of Hungary, but it gives not the same satisfaction than those from the Dauphiné & Germany. I do not say nothing on the one of Damas, because as it does not come to us in France, our workmen cannot handle it, nor to give it fire and soaking. To say truth, it is not better than the one brought to us from the Dauphiné & from Germany; it is only the manner of preparing it & of the temper, which prints this force to it that makes it so much estimable. And here is what I have learned by some Merchants from Marseilles who had for a long time negotiated from the side of Damas. They reported to me that in this country, and in several other Cities of Levant, they do not employ steel to make with it sabres & knives, but after having shoed the horses with it, by saying that the nail of the animals has the virtue of refining the iron after they carry it for a long time. And even I learned at Rome by this *Signor Guillelmo*, on whom I have already spoken, that he made use only of old irons of horses when he wanted to make some fine & delicate work. For the tempering of Damas; here is what these same Merchants have said me. They ensured me that the Turks do not temper their sabres and knives in any liquor; but only in the air, & in this manner. They build by uniting their forging mills, long skylights directly opposed to the North, having an extremely broad mouth, & that narrows little by little like a funnel until that they finish by a narrow, but rather long and broad slit, to place there a sabre in all its length transversely; & when they want to temper it, they particularly wait the time of winter, & that the North wind blows. Because then the wind being engulfed in these skylights, it becomes so cold in the passing of these long slits, that it is impossible to hold the hand there even the lesser space of time. So workmen that make redden a sabre with their forging mill, & at a certain color of fire, they quickly present it to this long slit, & hold it until is entirely cooled. The physical reasoning shows rather clearly that this manner of steel tempering must be better than the one that is done in some liquor. Everyone knows

that the hardness of steel by tempering comes only from that the particles rarefied by the heat of the fire come to narrow and to unite themselves by the great coldness of water or liquor in which one tempers it. But as cold as could be this water or this liquor, the burning steel will heat it always, & by way of consequence they will not be able to be operative with such a strength but in the first instance of the immersion of the steel & this is the reason, so I think, why the most part of the tools are very well tempered in the beginnings, but that they become so soft in the end, that one is committed to temper them again, as properly they have not united & narrowed but the surface particles, by the first force of the water, which virtue slows as the steel warms it. The same is not the case for the tempering in the air. As burning as the steel could be, it can not heat up it, because the new air comes incessantly, that as it does not stop continually to act, so also the steel particles do never stop to narrow themselves & to unite themselves until its very center.

The steels from Spain & Brescia are still good enough, but whatsoever the country they come, always it must be chosen the one with the finest grain, & with silver colour, a little tending to the brown; niform in all its parts.that it is neither straw colored, nor overheated, nor full of barks & veins, but intact & rightly uniform in all its parts. These kinds of steels can only be for making good instruments, especially if the workman takes the trouble to well welding & tempering them. What can be learned only by a long practice, because to say the truth the words alone are not enough to thoroughly inform a person on this matter.

It is however good to know that, for the good welding of the steel, one should employ only the charcoal, particularly of oak or beech. Because coals which have been drawn from the mines, in addition to that they are too violent, & proper to burn the steel or to melt it, they prevent by the thickness of their smoke from knowing well when it should be beaten. Having it redden sufficiently, it must be beaten as slightly as possible, by giving it a form such as wished, like of chisel, of gouges, of chisel with two bevels or of other tools for turning wood simply, according to the thickness that one needs. For the size & width of the tools to cut the ivory, as I usually do it with two butts, what is to say, without handle, & each butt properly able for work, I give them a length approximately of ten inches or a magpie, a width of seven to eight lines, & approximately a thickness of three lines: thus they are rather strong and enough convenient for the work. It is particularly necessary to have care of straightening them well, of flattening them and of making them quite equal; so that if one needs various tools for a part while turning in figure, the cutting edge of each tool comes just in the center of the workpiece. The tool being forged with the length & necessary size, it is necessary to let it cool not very far away from fire, so that it is proper to be filed; & having it filed according to the intention which one has, it is necessary to temper it well, what one can make in several manners, & with several kinds of drugs, that however will not serve but scarcely. But here is the best, the surest and, the easiest one that I know.

It is necessary to have a fresh water seal close to oneself; in order to temper the iron inside it, as promptly as may be. Any water is good, that of well, of river, or of fountain. But coldest is always the best. You put your tool approximately two fingers in fire, so that you can see well when its end will be sufficiently reddened, & quite proper to be tempered. It is needed that it is red *cherry color*, as commonly say the workmen, what is to say, of a bright red; what is not too easy to be explained, & properly there is only the practice, & a specialist of the profession present at the work, who can teach it. Once is seen that the butt

of the iron takes this bright red, one draws it from fire, & one quickly plunges it into water, one leaves it one moment there, & one withdraws it almost at the same time. If having withdrawn it you notice that it is bleached, this is to say, that it has shed a small superficial black crust, you must hope the tempering of your tool is good. Then it will have to be waited until it changes color, & that he takes a certain nuance merged by several colours particularly by gold, & by that with the color of *hair of fox*. In the moment that you will see that this nuance is melt with gold or fawn, you will promptly give your tool in water., & will let it there to cool. It very often happens that the butt that was the first time tempered does not take this gold color; in this case you will put it back on a well lit coal, & will hold it there until it is rather hot, so that when passing the pipe of a feather above, it starts to burn there, at this time you will return your tool in water, & will let it there to cool. Here is the tempering surest, & easiest for the tools to turn wood, & the ivory; otherwise they will be too soft or too hard, & susceptible hence to be shelled, or to be blunted themselves, particularly if you temper them with the color of silver or purple. That if the length of certain tools obliges you to temper them in its entirety, namely, in all their length; here is the manner to engage oneself there, so that they are not distorted, or break by tempering them. It is necessary to have rather deep & broad ground vases so that all your tool can enter easily inside in all its length, or the part which you wish to temper. You will fill this vase with oil of nut or of olive, the one & the other are equally good. Having given the bright red or the color of cherry to your tool, you will lubricate it with soap or tallow, & will plunge it in this oil, & will let it there to cool. This manner of tempering never makes that the tools be distorted, namely, or folded or curved, & it is very good for the long wicks or augers for drilling the oboes, & other large tools on which it is to be afraid that they are broken or distorted, in their length.

In addition to these two manners of tempering the tools, still there is a third one that is called *tempering in package*, because one tempers several workpieces at the same time packed in iron. If you need to do it, here is the manner of undertaking it. It is necessary for this subject to have the fattiest and thickest soot which may be obtained; to press or to crush it well, & to dilute it in a pot with vinegar, or with urine; in such manner that, the vinegar or the urine do float a good finger over the surface, then, you will throw there an onion or a garlic inside, & will hold your pot well covered; more old this drug is, it is better. When you want to make use of it to temper, you will take this soot & will cover your workpiece well with it, that you will lock up in an iron envelope; then you will make redden the whole in a charcoal fire until cherry color. Then you will withdraw the part to be soaked, & will throw it into water quite cool. Here is what is called, to temper in package. Here are the most common methods to temper the tools; but the practice & the use will teach it you better than any theory, *res enim difficilis non potest solo sermone explicari*.

## SIXTH CHAPTER

### On the manner of sharpening the tools

As good as the tools are; and as good tempering as they have, the force of work weakens them, and blunts their cutting edge; also it is very necessary that the Turner is equipped with good sharpening stones, as well sandstone as oil stone, for putting the tools in its right state; but it is above all very important that, he learns which are the good ones. They are usually of two kinds; namely of sand or of stone. The one of sand is a sometimes white, sometimes gray stone, and of an average consistency; easily it cracks and reduces itself to powder, it is appropriate for making paving stone, and to wipe the crockery; but mainly for sharpening the tools. Regarding this they should not be neither too soft nor too hard, the soft ones become hollowed first, and make an importunate mud; those that are too hard scarcely bite the tool, and to be sharpened they consume many time; in addition that almost never one will be able to make a quite right bevel. It is also necessary to consider the grain that is neither too thick, nor too fine; the first uses too the tools and makes the cutting edges too rough, so that one has much difficulty to sharpen them afterwards. For those too fine, too much time is necessary when at taking away a notch from a shelled tool. Thus they should be chosen rather hard, without callus and veins, but uniform in their matter. For the oilstones, the best are those that are brought to us from Levant, but it is very difficult to find the excellent ones; that is, uniforms, without veins, callus, and without marcasite. They are usually of a dirty gray color, and oblong form, broader than thick. They should be chosen well drawn up, and quite neat to be able to notice its defects well; because if you take them rough, you risk to be misled. They should be tested with a graver to know their consistency; if they are too hard, one almost does not advance while sharpening; and if they are too tender, they are undermined at the butt, and one is obliged to often rectify them. Above all an special care must be taken with the veins, and the callus, that usually are of a similar material to marble, or marcassite, the tool does nothing but to slip above, and its cutting edge instead of sharpening itself, blunts itself; it is necessary thus that the consistency is quite uniform, and that it quickly **eats** the iron or the steel well tempered. The stones from Spain hold the second rank after those from Levant; usually they are or brown or black. They should also be chosen carefully, because they tend to have tables, loosing itself by flakes, and to have jumps, that by stopping the hand of a Workman who sharpens, can make to gin a tool itself, and even to break it if it is delicate. Thus, they should be chosen as those more uniform, than could be. One also brings from Hungary and, another country, but those of Levant are more in usage.

Whatsoever goodness that the stones have, they are exposed to be damaged, not in their consistency, but in their figure and their provision; namely, that because of their usage and work, they are undermined more in one place than in the other; and in this case one takes a plate, and with sandstone or sand one makes them quite plane and plain, by rubbing them on this plate. What is called *to sandblast a stone*.

The Turner must thus pay attention, that he uses either an oilstone, or a flattened sandstone A (Fig. 2. Plate IV.) or a round grinding stone mounted (Fig. 3), that one usually calls a **gains small (gagne petit)**, for leading its tools C, B, so equally on all the parts of the stone, that he preserves the surface quite uniformly, and that it does not arch itself, nor that it is

not undermined by the work of the tool, what would make his bevel not quite flat, nor the cutting edge sharpened enough. While sharpening, he must so well assure the bevel of his tools from the moment that he starts to sharpen them, though he uses a flattened sandstone or an oilstone, that the bevel gets at all everywhere, as if one rubs two plans one against the other, and that he does not cease to drive it or to push it on the stone ahead and backwards, until he knows that it has been completely sharpened, and especially also that he holds it as firmly as in the situation that he started, that it does not shake itself in any manner; otherwise he puts himself in danger of making several bevels, or of rounding the bevel instead of making it quite flat. It is necessary also that when he sharpens the top of a tool, as the upper part C of the chisel with two bevels, (Fig. 2.) that this top holds and is entirely support on the flat of the stone; because by little that he puts up the sleeve, he will make that the butt of the tool is arched, and never its cutting edge will be well sharpened. It is the manner of making use of an oilstone, or of one flat sandstone; but when one makes use of a round grinding stone mounted, or **gains small (gaigne petit)** (Fig. 3.) it is necessary to hold its tool B in a quite firm and steadfast way, in the first stable position that one will have given to it, so that the tool does not seek the grinding stone, but rather than the grinding stone comes to meet it by its inequalities while turning; and in this manner bevel of a tool will become as flat as the facet of a diamond.

There are some who does not make use neither of sandstone, nor of grinding stone for well sharpening their tools, but of a round turntable made in lead or tin (Fig. 4) mounted like the one that use the Lapidaries. They cover it with much fine powder of emeryl soaked in a little of olive oil, and by running the tool 8 from above with a hand, they turn the wheel C of the other, and they sharpen their tool very well; but it is necessary to have the hand very firm and assured. These are the three ways to sharpen the flat tools; because for the rounds and the figures, they must be managed in another way.

The gouges are usually sharpened in grooves made on a flat sandstone, which embrace all the bevel of the gouge, by pushing it longitudinally, and withdrawing it in the same way. One then gives him the wire with the back of a small stone to be sharpened, and passing it the same stone in his groove, one removes its wire edge; but this manner is not the best; it is better and rather early done, to sharpen it on a round grinding stone that turns to have more freedom to sharpen its muzzle in oval or, in olive point; what one hardly makes in the channel of a flat stone. For this subject, it is necessary to hold the butt of the back of the gouge on the top of the grinding stone, and by polishing it from right to left, and from left to right, one gives it such figure as one wants either round or oval. It is however also always necessary to have a long small stone, and thick like the finger, and rounded in its length according to the groove of the gouge; and passing this stone in its groove, one entirely removes the cutting edge from it. The rounded chisels with two bevels B, (Fig. 6. Plate II.) are sharpened almost in the same way by polishing the round bevel from right to left, and from left to right, however that the grinding stone turns; then it is nevertheless necessary to sharpen the upper part on a flat stone, by holding the top of the tool in all its length quite resting on the surface of the stone, so that it makes only one same plan with it, as we have already said. The tools that are traced or cut with dagger shape, N O (*Pl. IV Fig. 4.*) must be sharpened differently, not being possible that the round nor the flat grinding stones can enter into their edges, unless one does not want to limit himself to sharpen of it only the upper part; but in this case in addition that in the end the edge of a tool blunts

itself, one arches its butt, and one makes its thickness unequal; but to obviate this defect, the skilful workmen make use of the wheels CDE (*Fig.5. Plate.IV.*) or of tin, or of lead, or of wood, covered of quite fine powder of emery soaked in olive oil. One can put several of these wheels along a same axis between two headstocks A, B, or to have a crankshaft with a squared bearing H (*Fig. 6.*), to bring back such wheel that one wants as K. One can put several of these wheels along a same axis between two headstocks A, B, or to have a crankshaft with a squared bearing H (*Fig. 6.*), to bring back such wheel that one wants as K. It is necessary that each wheel L, M is figured according to the moulding of the tool, and that this moulding is made with the tool, so that when one wants to sharpen it, the mouldings of the wheel precisely enter into the ones of the tool. For the tools with hook, and suitable to turn iron, their lead bevel is applied to the side of the grinding stone, so that, the bevel contacts by all its plan, and then instead of turning the grinding stone while fleeing to the manner of the Cutlers, it is necessary to make it turn against the bevel, supporting your tool with the hand without another support. It arrives at the time, that the grinding stone coming against the bevel of the tool makes there a sharp edge, and puts it in a position to support the effort of the iron when one turns with speed.



*SECOND PART*  
*On the Simple Lathe*

FIRST CHAPTER

On the simple poppets to turn wood and iron between two points

It is quite difficult to be able to determine exactly the thickness, the height and the size of these kinds of poppets, nor even of almost all the machines of the art of the Turner, being free each one to establish them according to its greater convenience and though it is needed that they are quite solid and strong, it is however not necessary that they are so massive nor so weighty, except if one is obliged to turn workpieces of a considerable size.

*Explanation and detail of the Parts of the Poppet to turn wood.*

This poppet has on the face a notch where one attaches the point, which must be posed as close as possible to the edge of the poppet, in order to be able to approximate the support as close as possible to the workpiece to be turned: in this way the tool will be more secured and firmer.

This poppet, considered in its profile, is bored in three places; that is to say, in the tail, by a mortise, the claveter or key which is used for stopping and strengthening the poppet on the bench or slide bars. It is still bored by a second squared mortise, in which one must pass the arm that is used to hold the support. This mortise must be notched at around almost the middle of the poppet height, so that, when one wants to push the poppet with a mallet, one has enough space not to obstruct the screw which is intended to stop the arm.

the stick that must hold the support in stop, so that it does not tumble ahead. This stick and the arm must run easily, so that one can advance and move back them without effort; and for stopping them well in their place, one will make use of a screw of wood or of iron, fixed in the openings practised for this purpose. The heel must be posed on the end of the arm, so that it serves of holder to the support, while the stick firmly holds it by the top, and that a small blade prevents that it does not slip ahead.

It is why it is necessary that this small blade is far away from the heel, in such kind that the thickness of the support can pass easily there.

*The poppet to turn iron.*

The poppet destined to turn iron must be much more solid and basic than the first, to be able to resist, with more strength, to the roughness of work, caused by the hardness of iron. The point must also be stronger, shorter, and be placed in the middle of the face of the poppet precisely, for its greater solidity; and in order to be able to approach the tool as far as required to the workpiece to be turned, one makes use of a different support from that used for turning wood.

This support is composed of two wood pieces and, of an **ankle of iron for hammer** attached or fixed in a wood prism, and stopped with a small key. The first of the two pieces of wood which compose this support, and that I call the base, must have about twice and a half more length than width, and opened or split so that, one can make it advance or move back according to the need. Also, it will be bored towards the end, where the support or second piece must lean on, to be able to place there an iron pivot, on which the stand of the tool or the support must turn.

This stand or support of the tool must have the part on which the tool is based, according to the manner of who turns the iron; because some make only use of a simple **cross-cut chisel**, and others of a bent **cross-cut chisel**. It is needed, for the first, that the back of the support is semi-rounded; and for the seconds, is necessary that the front of the superior edge is or chamfered, or **beveled**, to be able to support the elbow of the tool.

The third part which is used to stop the base of the support, is made up of two parts, one of iron, and the other of wood. The first is **an ankle of iron for hammer**, bored in the end of the tail, by a small mortise, so that with a pin, one can stop it in the second piece of wood, which must be similar to the tail of a poppet, and bored in the same way by a mortise, for the wood corner which must stop it.

## SECOND CHAPTER

### On the face Poppet, & own to Face Turning

After having exposed the simple poppets to turn between two points, we will propose various face poppets or, like it is said, *to face turning*; and because it is always necessary to make use at least of two, we will call the first the *former* one, which is the one that holds the collar of the crankshaft, and the second the *posterior* one which receives the tail of the same crankshaft.

These poppets, though they appear a little complicated, are however easy enough for a simple work, especially to cut the screw in the work.

#### *Explanation of the former Poppet and of all its parts.*

The first or former poppet must have the top of the front notched by a large squared opening, with a small relay for the place of the face, which is of two parts, one stable and stopped by the two ends, and the other mobile on a nail, to be raised and lowered. Each part of this face is a piece of wood much longer than large, very little thick, and garnished, at medium length, with the collet or tin half-ring, to hold the collar of the crankshaft.

One of these parts, namely, the lower, must be stopped with two screws, one in each end, especially in front of the poppet; but the other, namely, the higher, will have only one stopped end, so that one can raise it by the other end, to withdraw and put on again the crankshaft.

For this subject this last end will have a small advance apart from the headstock, to raise it more easily; and the place where the nail passes which must stop it when it is posed on the collet of the crankshaft, must be indented so that the opening is in arc of circle described from the hole opposed like center.

The front of this face must be furnished or covered with an iron or brass platen, indented in the middle, for the unrestricted passage of the crankshaft.

It will be attached by four nails, of which three will be of wood screw, and the fourth of squared stem and with tapped tail, that, by means of a nut, will be used to tighten the platen to stop the higher part of the face, when one poses it on the collet of the crankshaft.

#### *Explanation of the posterior Poppet and of all its parts.*

The second poppet or the posterior one will be also open on the top of the front, about like the first, except that its opening must be less than half of amplitude, with a round notch, for the unrestricted passage of the tail of the crankshaft. Similarly it will be notched in its thickness, by two relays, the one in front of for the place of the face, and the other behind, to place there the piece which it is called the register or keyboard, which is no other thing

but a line of several collars, or of tin or of wood, of different screw pitches, and attached together in a kind of box.

The disposition of this kind of register is extremely convenient to make screws in boxes or in some other workpiece whichever; because without taking the trouble to change, or to advance and make back the poppet, only one has to withdraw the corner that would be the key of the collar and, to transport it onto the collar or the key of the screw pitch that one has to make, and the screw being completed, also one will only have to withdraw this same corner, and put it back on the key of the collar; what is of a very prompt and very easy execution.

One must also say that the box which contains the register, being or of brass or of iron, is much more convenient than if it were simply of wood, because it does not contain such an amount of volume as if one is obliged to cut it in the thickness of the poppet; what would make it inconvenient and very heavy.

### THIRD CHAPTER

Representation of the preceding Poppets, to turn as much between the two nails than to face lathing, posed on their bench.

## FOURTH CHAPTER

Another disposal of two poppets, and of two various faces to face lathing.

They are here the two kinds of faces, each one set up on its particular poppet; and of another poppet garnished with its point, own of these two faces.

This last poppet with point must be bored transversely, from the front to the back, and at an adequate level for the opening of the faces, by a squared and broad mortise, of approximately two inches, to receive the prism or parallelepiped, a little longer than the poppet is thick, and as thick as the squared mortise is broad, but so that it can run easily there.

One can stop this prism, or by a screw out of wooden, or by small a wood cleavette, which passes all through the headstock, so that it tightens this parallelepiped well, just as the small key or corner of wood which tightens the tree of a marking gauge of carpenter.

One fixes on one of the ends of this parallelepiped, a point of iron for the tail of the crankshaft, and on the other end one will be able to practise a hole in a small iron or brass part, for the tail of the crankshaft in the shape of point.

These kinds of crankshafts will be able to have the neck empty or garnished with an iron bushing made out with screws thick and long from seven to eight lines, to attach wood pieces, or brass boxes, tapped in the bottom.

In order to attach the pieces of wood on these bushings cut out of the screw, it is necessary to bore them by a side, and to tap the hole with a tap drill of iron of the same diameter and with the same pitch like the bushing.

After the screw will be made on one of the ends, approximately the length of one inch, one will cut this same end **with inserted sides**, so that the corners or the edges which will remain, are sharp and well cutting; and so that you make your nuts in the piece of wood, it is necessary before to have bored the place with an auger a little less thick than is the tap.

Of the two faces own to these kinds of crankshafts, one is made up of two angles in the manner of a graduated dividers; the other is only one split simple board in the bottom and opened in the top, according to the size of the collar of the crankshaft or the part that one wants to turn.

The first face must be attached against the poppet, by a strong rod, whose stem is almost square, except the end towards the head, that must be round for entering in the opening of the same face.

**In addition to this rod, one must still attach the glasses with a screw out of wooden, by one of his branches, so that this branch being well stopped, the other branch can open easily when one raises the support, being attached which, him by a pin, has a screw with one of his ends, to attach the two branches together.**

## SIXTH CHAPTER

Two different face poppets, and a different support.

These two **Poppets with Support Rings**, & this sort of support seemed to me extremely simple & extremely convenient to face turning the works. One can make the support or of iron NM (Fig. 8) or of wood I (Fig. 5) according to the nature of the Turn, so that all the parts are in conformity, because if it is for an iron Turn, one will need the support of the same material, and if the Turn is in slide bars and Poppets of wood, it will be also more suitable to make the wooden support. Thus if one wants to build this wooden support, one needs that the part that supports the tool, or what is properly the support, has approximately three inches thickness, four inches width, and height in accordance with that of the Support ring, but always so that it is lower than the center of the Support ring; so that the thickness of the tool been supported above can there come almost on the level of the center of this Support ring. **The plant of this support must be especially well levelled, so that when it is tightened, he sat well on his basis H. The roof or the back on which one support the tool while turning, must be cut in heel, to be able to incline the tool towards the handle, and to raise it with dimensions edge.**

## SEVENTH CHAPTER.

*A complete assortment of two different poppets to face turning, and to easily cut screws of all sizes with a crankshaft and a support*

### *Plates XI & XII.*

This last assortment to face turning and for the set of screw threads having been so successful for me in the practice by its great convenience, I wanted to show its manner. Those which will want to carry out it will find it extremely easy.

The Posterior Poppet A must be entirely open by the sides, or split all along as many mortises as screw threads at the crankshaft, in order to place in each mortise a support ring with hinge that is made like a graduated dividers, such as the support ring. M of the following Plate; because each support ring will embrace its screw thread, by tightening it with two little wedges; but it is necessary to tighten the first mortise to embrace the collar of the crankshaft; or one will apply at the front of the Poppet a track garnished with a Platen of brass, as one can see at the two Poppets C and D for the same support ring of the collar of the crankshaft, and that one will also tighten with two wood wedges, as shows the same figure D.

For the former Poppet EF, it should be open only in the top, from the front to the back for the unrestricted passage of the crankshaft. At the front one will also apply to it a track garnished with two opened Platens, the one at the front, the other at the back for The place of the wedge which must tighten the former collar of the crankshaft, as shown at the figures F, G, H.

### *Detail of Plate XI.*

- A Posterior poppet opened by the sides, and the front.
- B The same Poppet split by several mortises, or garnished with several partition walls.
- C The same Poppet garnished on the front with a track with its Platen.
- D The same Poppet seen by its face, and garnished with its support ring, which by the means of two wedges tighten the collar of the crankshaft.
- E The former Poppet naked and opened by the top from the front to the back.
- F The same Poppet garnished in its front with a track made up of two small filling laths, and two open Platens.
- G The same Poppet seen by its face, and garnished with its track and its support ring tightened by two little wedges.
- H The same poppet seen by the back.

One sees in this Plate XII the two Poppets of the preceding Plate laid out for work with the crankshaft embraced of support rings as well on the front as on behind. However to



reasonably hold this crankshaft, so that it does not advance or that it does not move back, it is necessary that the collar of behind is dug as a pulley to be embraced by the first support ring a where one sees that by the means of two wedges, these same support ring a embrace by the posterior collar as a pulley when one wants to turn some part, and when one wants to make use of some screw thread cut on the tail of the same crankshaft, one will draw the two wedges which tighten the collar, and one will make use of them to tighten the support ring corresponding to the screw thread, as one sees on the same figure b b, where I have marked only one support ring for the screw, not to confuse the intention.

*Detail of all the Parts of the Plate XII.*

- ABC The crankshaft and the two Poppets for work.
- DE A support stopped on the slide bars of the Turn at the front of the former Poppet by a long center punch with hammer QV.
- G An iron crankshaft garnished with a wood reel.
- H The same iron crankshaft naked.
- 2,2 The collar in pulley of the same crankshaft.
- 3,3 the lengthened collar of the same crankshaft for the movement of the screw. 4,4 The bearing of the same crankshaft to attach to it the pieces to turn.
- M. Double support ring, with hinge of graduated dividers.
- N Leg or sole of the support split longitudinally to approach and move away the support. It is bored also by a small square mortise P there to place an iron pivot L with square head, for, by the means of a nut O, to fix the support on the leg.
- Q Hammer punch garnished with its plate S and its hat T being used to strengthen the sole of the support on the table of the Turn by the means of the screw V and nut R.

## EIGHTH CHAPTER

Another different manner of two poppets to face lathing.

### *Plate XIII.*

I represent in this Plate an entire assortment to face turning, & I make a very particular detail of it, as well by various profiles as by perspectives, to better give it to understand. I will not however give any determined measurement of it, each one being free to make it or more tall or more small, according to whether it finds it more convenient.

Figures 4,6,7, show all the assembled machine, & each part in detail of the other figures . A B C show the profile of the posterior Poppet, & D E the perspective for the same Poppet. A is the profile on the side, B that of the back, & C the profile of the face. D represents the complete Poppet, but I have cut off in E one of the edges, to make see the inside. It is necessary that this Poppet is open over & by front, but of a width & depth convenient enough for the play of the crankshaft & the keys or wedges which compose the keyboard of the screws. The back will be entirely closed, but however bored by a small square mortise *o*, to receive there the prism or parallelepiped 5 (*Fig. 2.*) which could be useful in the need, & that one will be able to stop with a wood screw *p*. The interior edge of the front's opening must be notched by a small notching *x* with dovetail to be used as track to the support ring R, & the two sides will be bored from the one to the other by the mortises *a a a* corresponding each one to each screw thread of the crankshaft. One will set all through these mortises *a a a* shelves, or wood wedges I (*Fig. 2*) that one will stop by an end with an iron wedge; but they will be mobile at other to be able to freely raise & lower them with a little wood wedge 2 place against the screw thread of the crankshaft to make them be used as nut. These wedges or shelves I must touch the screw thread, so that the screw can better take its place & they will be rounded just a little by the front, so that the wedge 2 has its freer entry there.

The figures F and G (*Fig. I.*) represent an iron part which must be enchased and attached in the groove *u* with two good screws, as one can see with the marked Figures 12 & 13. Its head will be square and surmounted by a screw to attach to it with two nuts 16,16 the iron Platen H (*Fig. I.*) by three square holes *nn*. This Platen must be as long as the Poppet A is broad at C, and large and thick in proportion with its length, so that it is stronger. One will attach at its middle, which will be bored transversely by a round hole L, another square Platine I which one will indent in round and in slope, to be used as collar, and to stop jointly the nut M with the Piece K, as it is marked by the Figure MHTVXH. This nut M will be used to raise and lower another collar N or V by its tail as a screw *y* in the track *dd* of the support ring R, as one can see in the same Figure MHTVXH. This collar N or V must tighten by lowering with the nut M the collar of the crankshaft 7, which must be dug as a pulley; and this to reasonably hold the crankshaft when one turns simply in round; but one will raise this collar N or V with the same nut M when one wants to make the screw, so that the crankshaft is free to advance or to move back through the light *m* of the support ring R or P, which will have its edges cut in bevel to slip more easily into the track with dovetail *x* of the Poppet D or E. It is not necessary that the round light *m* of the support ring P or R is of an exact accuracy to receive the crankshaft 7, it is enough that the crankshaft

can enter there freely, since wedge 2 tightening the small plank against the screw thread prevents that the crankshaft slips.

The Poppet of the front, or the former 6, must have the head bored transversally, as one can see by the figures 12 & 13. The inside of this opening will have in each bord near the edge of the front a square groove to be used as track by the support ring or collar 17 and 18. The two outside bords will be also notched with respect to this groove by two other small grooves to attach to them, and there to enchase inside with two screws, as in 3, an iron piece 11 garnished with a pivot as a screw, which will be used to stop the Platen 10, whose middle will be tapped for the screw 14, in order to tighten the crankshaft 7 with the collar 17,18. And so that the shock of the Turn does not make slacken this screw 14, it is very good to hold it reasonably, by tightening it against the Platen 10, with a nut with mumps 15, as one can see in figure 6. I have opened one of the holes of the Platen 10, so that while loosening just a little one of nuts 21, one can drive it on the other trunnion, in such a manner that one can freely withdraw the crankshaft of above the Poppets.

One can do without the procedurer TVX by making use of this last method; but it is necessary that the first of the wedges I of the Poppet 4 is used as a collet to the collar of the crankshaft in the place of the collar N or V. Figures OPQS, 3,9 & 8 are the plans & the profiles of these two Poppets and support rings.

THIRD PART  
*On the Lathe to turn figures.*

FIRST CHAPTER  
*On the disposal of the lathe, and of the machines to turn figures.*

Plate XIV.

After having shown several various dispositions of crankshafts, of support rings, of Poppets and of supports, to turn just in round, I propose in the following Plates several manners of machines adequate to carry out the most curious pieces of the Lathe, or like it is said, to turn in figure. One understands by this word to turn in figure, to turn pans, puckers and in oval; because a simple Turn can only turn in round, but one does not understand by this word to turn in figure, to turn the Portrait by example of a man; what however some very skilful Turners ensures is extremely easy; and they even praise themselves to know the secrecy of it. I acknowledge that of all the features of the Turn always this one appeared to me very curious; but after well having examined the machine that has been showed to me, and that they want to make me think that it was able to do this, I judged that it was only an imagination, and that at most one cannot but crudely to begin to take the shape of, spending many time, the simple contours of a face, with almost no relief, and without being able to bring out neatly all the circular lines that traces the tool while cutting, since it is only a simple nail a little larger than a needle. And to make better understand the subject, and the difficulty of well succeeding well in it, I will briefly explain on what the machine consists. One makes use of two ordinary Poppets, garnished each one with a support ring. The crankshaft has a collar at each end, and to one of these ends one attaches the hollow of a Portrait, if one wants to make a relief, or a relief if one wants to cut a hollow. At the other end of the same crankshaft one attaches also the matter on which one wants to trace the Portrait; and so that the crankshaft can be driven ahead to backwards, or backwards to ahead, one makes use of a spring, or of a counterweight, to give it movement while it turns in round by the means of a wheel, or a pulley.

The crankshaft being ready to turn on the two support rings, one lays out at the front of the original a key of steel, well soaked and sharpened as a needle. But it is necessary before to trace on this original a straight line from the center to the circumference, to be used as guide for the point of the key. In addition to that it is necessary that the aforementioned point is on the same level as the center of the medal, and that the point of the tool is also at the same height, and always located opposite and directly at the point of the key.

Thus to begin the Portrait one puts the point of the key on the center of the medal, and at the same time as the crankshaft turns, one presents the point of the tool to the center of the matter, if the center of the original is hollow, the center of the matter will be in relief; and on the contrary. The center being thus cut, one advances the point of the key to the nearest point of the line that has been traced on the medal from the center to the circumference, and at the same time one advances also the point of the tool to the point of the matter directly

opposed to the point where the point of the key. The rotating crankshaft on the support rings, and advancing and moving back by the means of the spring or the counterweight, will make that the point of the tool will trace on the matter a circular line of the same nature than the one that the point of the key traces on the medal; and thus on all the remainder. And because one cannot make use but of a pointed tool as a needle, and of a pointed key alike, necessarily each blow of tool forms a circular trace; that can only make one Portrait extremely unequal and extremely hard, and that one cannot undoubtedly polish but by erasing many lines that will make it defective.

Having thus explained what one understands by this word of figure in what concerns the Turn, I show in the present Plate the disposition and dimensions of a bench suitable to turn the figures. One can make use of some Turn, but the disposition of this one being quite easy because one can turn sitted, I want to give all the measurements of it, and to show as it is the one that I use myself. The scale of forty inches marked at the bottom of the Plate will make known the whole dimension. However each one is free to make one after his pleasure, and such as he will judge it more convenient.

*Detail of all the Pieces of the Plate XIV*

- A Profile of the front face of the workbench.
- B Profile of the length and height of the workbench.
- CC Thickness and width of the two forked stem.
- D Length and thickness of the two forked stem.
- E Distance between the two forked stem.
- FF Double jamb of the forked stem.
- G Profile of the length and width of the sole of the jamb.
- H Plan of the length and thickness of the bored soles of two mortises for the tenons of the jamb.
- I Plan of the length and width of the forked stem bored towards the extremities for the double tenon of the jamb.
- K Profile, height and width of one of the parts of the jamb.
- L Thickness of one of the parts of the jamb.
- MN A jamb piece in perspective.
- O A forked stem in perspective.
- P One of the two soles, with its mortises, seen in perspective.
- QRS Width, thickness and plan of the spacer which holds the two parts of the jamb assembled.
- TV The spacer in perspective.
- X The whole workbench in perspective and posed on four knobs.
- 1,2 Mortises where the tenons of the pasting of the wheel are enchased.

## SECOND CHAPTER

On the wheels own to the Lathe, and their different disposals.

### *Plate XV & XVI.*

As it is almost impossible to pass without the use of the wheels in the execution of the works of the Turn for working and promptly and with more facility. I have wanted to show the disposition of several, and all assembled; so that one can rebander the cords when they are slackened. But before coming into that with too much detail, I have thought appropriate to make know which must be their size approximatively; though truly it is quite difficult to be able about it to determine the size, because the quality of the works and the matters require that some are large and the other averages. By example, if it is to turn or the iron or large pieces of wood, one must make use of a large wood wheel, similar to that of the Cutlers, and even several times larger; but when it is to turn only delicate pieces or of wood or of ebony, a wheel of approximately three feet in diameter is sufficient enough to the force of the movement, which one will be able to even increase by garnishing the wheels with some lead Platens, so that gravity compensates for the brevity of the lever; or one will be able to decrease the diameter of the cranks shafts, if it is wanted that the movement is made with more speed, particularly when one turns simply in round; but when one wants to turn in figure, it is necessary to decrease gravity and the diameter of the wheels, so that the movement is moderate; because by a too fast and precipitated movement a risk to spoil & the machines & the works exists. For this subject, one can adjust several wheels together, and all of various diameters, to be able to give a movement in conformity with the work, as one sees at the present Plate XV two wheels b b, one large, the other small, attached together; the one for a moderated movement, and the other for a fast movement.

As for the size or proportion that the two wheels must have, the one of the foot and the one of the crankshaft that is called the pulley, I will say that to simply turn in round, it is enough that the one of the foot has approximately three feet long, and that of the crankshaft three to four inches in diameter. But if it is to turn in figure, one needs that the two wheels are of an equal diameter, namely of approximately a foot. With two wheels of these size, there will be a slow and soft movement, and that will not cause a violent shock, that very often spoils and the machines and the work; especially when one does not have the hand enough strong and sure.

One cannot make use of the wheels without the help of the ropes, of which some are done of bowel, and the others are done of hemp. The first are always best and less prone to the slackness, but also the rats spoil them and often cut them if there is not care or to withdraw them in the night, or to anoint it with oil of aspic. Whatever rope one uses, it is necessary to weld them, namely, to join and to bind so well the two ends, that they cannot be untied, and that even the welding or binding do not appear. As for the ropes of bowel one can only well weld them but onto the wheel of the Rope-makers, by twisting the two ends the one on the other: For the ropes of hemp here it is the most liable way. For this subject it is necessary, after you will have cut your rope at the required length, to ravel a cord of each end approximately the length of ten inches. Then you will make these two ends overlap approximately one inch more before the place where one finished ravelling the cords, you will fill with the ravelled cord the place of the other, that one will finish one inch beyond

this one; tie the both from the lower part in top, and tighten the node well, so that these two cords do not come undone. You will have at the opposite end, four twisted cords from two to two, namely two long and, two short. Disentangle one of these short ones and fill its place with one of the two long just in the middle of the junctions of the two ends of the rope, and in this middle point you will tie these two cords in the same way as the two first. Tie then the two other cords which remain, and you will have a well welded rope.

The place and the situation of a Lathe regulate and determine very often the place of a wheel. Because sometimes one is obliged to place it or under the bench of the Turn or over it, and sometimes at the side; but in any place that one puts it, it is necessary always to place it in the most convenient and in such a manner that the rope fit well to the crankshaft or chuck, and that the two wheels, as well as that of the foot as that of the crankshaft, are always in the same plan; the movement will be easy, and will not put in danger the rope to escape from the pulley; and if the layout of the premises does not forbid it, it is also always better that the rope crosses between the two wheels, it will set ablaze much more their circumference, and will facilitate the movement more. To facilitate work it is still necessary, particularly when one is obliged to turn the wheel, that the pedal is five to six feet length if the place allows it, and that the crank of the crankshaft of the wheel has roughly a half of a foot of elbow. And so that the handle of the crank remain suspended in such a way that, when the wheel ceases turning, with the first kick one still gives the movement to it, without being obliged to put at it the hand, the weight on the edge of the wheel at the opposite place to the crank will be increased; so that its handle remains at the same level of the horizontal diameter of the wheel when one ceases turning.

I have believed these opinions necessary for the convenience of the Turners; and to facilitate the work, I am going to show now, in the two following Plates, some kinds of wheel or by the lower part, over, or beside the bench. The wheel that I represent in this Plate XV, is intended for the bench of the Lathe of the preceding Plate. It sticks against one of the right feet of the Turn, but so that one can withdraw it when one wants. For this subject it is assembled on two feet or posts C parallel and perpendicularly posed on a basis made out in a sash A. And here it is the detail of all the parts that compose all their assemblage, and on the foot and measures of the same bench or workbench of the precedent Plate.

- A Plan of the base made out in a sash.
- B Face and height of the base and of a right foot.
- C Profile of the base and of the two right feet.
- D Length and width of one of the pressure shoes of the base.
- E Tenon of the pressure shoe that one enchases in the mortise 1,2 of one of the soles of the bench of the Lathe of the preceding Plate. (*Plate XIV. Fig. P. & X.*)
- F Length and thickness of the pressure shoe.
- G perspective for the same pressure shoe.
- 1,2 Mortises for the tenons of the bridging pieces H of the base.
- H Length and thickness of a bridging piece.
- I Length and width of a bridging piece.
- 7 Mortise of the bridging piece for the tenon B of the post or right foot L.
- K The same bridging piece seen in perspective.

- L Height and width of a post.  
M Height and thickness of an post.  
N A post seen in perspective.  
O All the assembled foot seen of face.  
P The same assembled foot seen of profile.  
Q, R, S Plane, height, width and thickness of a slide which carries the axle of the wheel, and which is used for raising or lowering the wheel to tense again the slackened cord.  
TV The same track in perspective.  
X The wheel gone up on its foot.  
*a* Size or diameter of the large wheel.  
*b* Its thickness. This wheel is not useful for the rope, but only for, by its diameter, to give a greater movement to the small wheel *bb* that is attached to it, and around which the rope rolls. However to give it more strength, one will garnish it with some lead Platens, so that, as I already have said, the great gravity compensates for the brevity of its lever.  
*bb* Size & thickness of the wheel that is used by the rope.  
*c* Axle of the wheel with a crank suitable to turn the wheel with the hand.  
*d* Axle of the wheel with a crank suitable to turn the wheel with the pedal.  
*e* Platen of iron with hook, that one attaches to one of the soles of the Turn to the opposite of the wheel.  
*f* Treadle or control garnished with an iron ring *p* for the hook *q*.  
*g* Pedal of the treadle.  
*h* Leather belt of double braid 5,4, of which one receives the collar 5 of the control *f*, and the other that of the crank *d*.  
*i* A screw with square stem which attaches the pedal *g* to the control *f* by the holes *n*, *o* with a nut *k*.  
*l* Little wedge to hold reasonably the collar of the axle of the wheel.  
*m* Wedge that is used for raising and lowering the track TV. For this subject it must be a little narrower by an end than by the other, so that by advancing it or moving back it one can raise or lower the track, when one wants to tense or relax the rope of the wheel.  
*p* Ring attached to one of the ends of the control to be inserted at the hook *q*.  
*r* Notch for the spade *s*. This spade must be attached to the sole of the right foot of the Lathe; in such manner however that it is easy to drive to insert it in the notch *r*, and also to withdraw it. This spade *s*, is only to stop the foot of the wheel against the legs of the Turn.

In the following Plate, one sees two various manners of assembling a wheel; the first *K* is the same one as that of the Cutlers. The height of its foot must be such, that a man being stand up can conveniently turn the crank, & this same height regulates consequently the diameter of the wheel. However this manner is only proper to turn large parts of iron or of wood, but it is also extremely convenient, because one can advance it & move back it, & even to transport it at whatsoever place. One can still make use of it if one wants for little delicate parts, & to even turn in figure, by applying a small wheel to it, like it is seen at the present Plate, & turning it very gently.



The second manner of assembling a wheel is done by the means of two sashes C, E, of which the one E is attached perpendicularly against a wall FG, & supported by two rafters H, H. The other sash C is applied to the first, and supports the wheel N. This one must be mobile on two small pivots v v, in order to be able it to raise it and to lower it by the means of a large wood screw I. This manner of mounting is only proper when, as not being able to establish the wheel under the bench of the Turn, one is obliged to emplace it over it; then it is necessary to arrange the sashes at such a height that one can easily reach the screw with the hand, when it is need to raise or to lower them, to slacken or to tense again the rope.

*Detail of the Parts that compose this mounting.*

A Plan of the sash that carries the wheel.

B Profile of this sash.

C The same sash seen in perspective.

D Plan of the large sash that one must plant in the wall.

E This same sash seen in perspective.

O O Two small right feet of the large sash which holds reasonably well the sash of the wheel.

u, u Bearings on which the sash of the wheel is driven.

N The wheel assembled on its sash G.

G The sash garnished with the wheel N, and assembled on the large sash F.

I Large screw of wood with its crank at the head.

H, H Rafters which support the large sash planted against the wall.

M. Treadle to turn the wheel N.

The figure L represents a simple treadle for an ordinary Lathe; one can as well make use of a treadle such as M.

### THIRD CHAPTER

Assortment of a Crankshaft, & of the Poppets own to turn the figure.

#### *Plates XVII & XVIII.*

This manner of assortment is the most ordinary one of all those which I have ever seen; but however it is one of the simplest & rather easy. I have represented it in two Plates to make it better understand. It is necessary that the former Poppet is opened by the top in the front, & that it is split, at each side, transversely by a mortise D, & precisely at middle of the large opening of the front, or of the center of the ring support. The front of the same Poppet is also bored at the bottom P, for the place of a nail which must retain the support ring. The two lips of the large opening must be furnished each one with a sub band of iron F, pierced with two holes for the nuts G. One applies to the front of the face of the Poppet a Platen of brass if it is wanted to facilitate the play of the support rings; which will slip much more easily on a brass platen quite united than on the naked wood, as much polished & united as it can be. One must always observe that, in all the occasions in which there are frictions for the movement of the figures & of the machines that look at it, one always makes use of metal, & not simply of naked wood. And as long as one will be able of iron on brass, or of the brass on iron; because they support themselves always well the one with the other. The two ends of the mortises D are garnished with two small iron pieces I, dug at the middle in track or notching, for the play of a small iron platen K, whose two pivots slip into this slide. This platen K being pressed by the two screws H, stop the key or meets O in the place where one wants to put it. The stirrup L which is used for strengthening & retaining the support ring Q, must be attached as highest as one will be able to make the ring support firmer, & of such a manner that it has its movement free. The small strap hinge M is used to hold the spring N. It is necessary that it exist one at each side of the Poppet to change the spring, according to whether the work requires it.

#### *Detail of all the Parts of the present Plate.*

- A Face of the Poppet. *Fig. 3.*
- B Profile of the Poppet. *Fig. 2.*
- C Large opening of the top. *Fig. 3.*
- D Mortise on the sides. *Fig. 2.*
- E The Poppet in perspective. *Fig. 1.*
- F Sub band bored of two holes for nut.
- G Hole for nut.
- H Bored capscrew. *Fig. 4 & 5.*
- I Small iron piece in track, or grooves.
- K Small iron platen with pivots rounded.
- L Stirrup to retain the support ring.
- M. Strap hinge for the spring.
- N The spring.
- O Recoil or lever of the figures, or rivet washers.
- P Opening for the nail R of the support ring.
- Q Support ring.

*On the crankshaft, support ring & base for the Poppet from the Plate XVIII*

One sees in this Plate XVIII the detail of all the pieces that must achieve the matching of the Poppet on which I have just spoken; namely its crankshaft, its base, its support ring, & some kinds of lever.

The crankshaft is an iron piece of approximately one inch thick, & of a foot & a half long. On what it is good to remark, that for the use of the figures or rivet washers, the longest crankshafts are always the best, especially when they move themselves on a point; because the irregularity which the arc that the collar describes by the means of the support ring can cause, is not so sensitive on the work, that when a crankshaft is a little too short. For this same reason, it is good that the support ring is a little more long when it must to act on a center, as in the present example, where the support ring Q moves itself on the nail that holds it attached to its Poppet, & describes consequently an arc. Thus the length of the crankshaft being approximately from eighteen to twenty inches, & that of the support ring of fifteen, the irregularity or the inequality that causes on the piece the circular motion of the support ring, will not be so sensitive, & so large; being quite difficult that when one wants to turn a piece in figure, the tool cuts rather by one side than by the other on the front of the same piece, if the crankshaft & the support ring are a little too short, & if they make their movement on a center.

One usually divides the length of the crankshafts into three parts; namely the collar, the stem, & the tail. The collar is properly this part which fills & occupies the eye of the support ring. Usually one makes it a little bit longer, for the action of the screw. For this subject, it is necessary that it is also thick, & especially exactly round. For the thickness, one inch will be enough, & for the length, approximately one inch & a half.

For the stem one makes it by sections, or squared for the rivet washers that one must put there, so that they are more assured & more firms. As for the tail it must be round, & rather long, to cut there various screw threads. Usually it finishes at a peak to support it on a Poppet, or one notches there a small pulley somewhat at the top of the screws, if one wants to press it on the support ring.

The lever or the recoil is a piece of iron or of brass cut & manufactured in a different way according to the profile of the rivet washers or the ornaments which are claimed to be made. For this subject, the ones must be flats, the other pointed, & the others made in casters.

The suitable base for turning the figure must have the back flat & horizontal, as well to hold the tool firmer, as for the regularity of the figures, as I would show it in another place, when I will talk on the use of the rivet washers, & because of the shock which these rivet washers cause, can make vary the point of the tool while turning the figure, one adds some parts to this base, which are used to hold the tool firm & immovable. These pieces are made in various manners that I will also describe in other subjects, & other Plates. The manner of this one is an iron rule O edged with a groove, inside which one fastens the teeth

of the claw P. This rule is attached to the top of the front of the support, & the edge where its groove is notched, must be on the same level of the back of the base that I have composed of two parts, of which one is raised & dropped by means of two screws which hold it attached on the other. I found that this method was extremely useful for the exactitude of the regularity of the works. Because as it is very necessary that the cutting edge of the tool is at the same rise, & at the same level as the center of the crankshaft or of the piece that one turns, it is necessary to make sure to put it right there in the occasions where the tools are not of equal thickness.

Detail of the Pieces of the present Plate.

A Plan or profile of an iron crankshaft.

B The naked crankshaft in perspective.

C The same crankshaft garnished with its reel, its wheel & some rivet washers. D Plate of wood for the support rings.

E Brass platen for the Platen of wood.

F Piece of fence to hold the collars G, H in safety.

G, H Two collars for the support rings. These kinds of collars are usually of tin; but they will be also as good at the very least, if they are done of wood boiled in oil.

I Flat recoil.

K Pointed & blunted recoil.

L Recoil, or lever with caster.

M Piece of iron with pivots to stop the lever at the place that one will want, as one sees it in K, (fig. 4. & 5.) of the preceding Plate.

N Broken base.

O Base platen for the claw P.

P Claw with hooked fingers to ensure the tool.

Q Profile of the Poppet garnished with its support ring, where one sees the place of the spring which must push back the support ring at the same time as the rivet washer rubs against the lever or recoil.

## FOURTH CHAPTER

Another assortment of two poppets, and of a crankshaft to turn figures.

### *Plates XIX & XX.*

Though this assortment appears a little too made up, it is however of an extremely easy execution if all the parts are well aligned, and of a required accuracy. It is an invention of the sieur Maubois, whom I owe its knowledge. I make a very particular detail on it in order to give an entire explanation; what has obliged me to draw all the pieces which compose it, in two Plates. In the first I explain the former Poppet, and in the second the posterior one with all the pieces which accompany them; like the crankshaft and the support rings and all the assembled assortment. And though I did not give determined measurements of them, nor a singular description, I believe that the drawings that I give on them, as much in profile than in perspective, will easily give to understand the construction of all the machine, and of all the pieces that compose it. Here is the detail of each one.

#### *Detail of the Parts contained in Plate XIX.*

- A Face of the former Poppet.
- B Profile of the same Poppet.
- C perspective for this Poppet garnished with two sub-bands, and four screws.
- D perspective for this Poppet garnished with two sub-bands, the support of the support ring, and two Platens which are used to tighten the lever, or recoil.
- E Plan and profile of the crankshaft without reel, without wheel, and without figure or rivet washers.
- F The same naked crankshaft in perspective.
- G Profile of the wheel of the crankshaft, and of the crowns which accompany it. H Face of the same wheel and of these crowns.
- I The same crankshaft seen in perspective, garnished with its wheel, with its crowns, and with some rivet washers.
- K Profile and thickness of the support rings of the former Poppet.
- L Face and width of the same support ring.
- M Perspective for the same support ring.
- N Plan of the track of the same support ring.
- O Plan of the collar that must enter the track.
- P perspective for this same collar.
- Q Plan of the piece of enclosure.
- R The same piece of enclosure in perspective.
- S Punch like a screw to tighten the buckle of the support ring.
- T Nail as a screw to tighten the lever or recoil.
- V Platen of iron that is used as buckle with the support ring.
- X Platen of iron which tightens the lever, or recoil.
- Y Crown crimped that one attaches facing the wheel.
- Z Another crawling crown for the same wheel.
- & Capscrew to attach the crowns to the wheel.

The Italic characters explain the support ring of the posterior Poppet. This support

ring is made up of two pieces; namely by what is properly the support ring, and of a foot that supports it, bended at a right angle like a square. The composition of this support ring is extremely appropriate for the double movement that the crankshaft must make from right to left, and from the front to the back by means of the rivet washers and the crowns.

- a* Face of the foot of the support ring.
- b* Plan of the track of the foot.
- c* Profile of the foot.
- d* perspective of the same foot.
- e* Tierod, or lever of the support ring.
- f* Profile of the support ring.
- g* Face of the support ring.
- h* perspective of the support ring.
- m* Ring of the support ring.
- n* Tenon of the support ring to slip into the track *o* of the foot.
- o* Track of the foot *d*.
- p* Screw to tighten, or to stop the support ring on the track of foot *d*.

One sees in this Plate XX the whole disposition of all this assortment, and particularly that of the posterior Poppet, of which here it is the detail, and of the pieces that accompany it.

*Detail of the Pieces contained in Plate XX.*

- A Face of the posterior Poppet.
- B Profile of the same Poppet.
- C This Poppet seen in perspective.
- D The back of the same Poppet garnished with its support ring.
- E Face of the former Poppet garnished with its support ring.
- F Profile of all the assortment, where one sees the disposition of all the pieces that compose it.
- G H Lever or recoil with wedge and caster of the Poppet of the front.
- I Punch or needle that joint two support rings, so that they are driven together jointly with the crankshaft.
- K perspective of the back of the posterior Poppet garnished with all the pieces for the movement of the crankshaft from the front to the back.
- L perspective of the register of the posterior Poppet.
- M perspective of the former Poppet garnished with a counterweight and the lever for the movement of the crankshaft from the right side to left side.
- N Bracket to attach to it the tierod or lever where the counterweight is attached which draws the crankshaft from the front to the back.
- O A lever or recoil with caster that one opposes to the crowns.
- P One of the levers of the register seen separately with the little wedge Q, which is used to tighten each lever against the thread of the screws of the crankshaft when one wants to cut a screw on the work.
- R Counterweight for the movement of the support rings and of the crankshaft as well from the right side to left side, as from the front to the back.

*On the Spring and the Counterweight.*

One cannot turn the figure without the help of a spring or a counterweight, which bandaging the crankshaft against the lever, obliges it to move back or advance according to rises and nooks of the rivet washers; thus it is good to know of which must be the force of the spring, and how much must weigh a counterweight for the movement of the figures. Usually the springs are made of a blade of steel, or of some stick or woodruler of a hard and collapsible consistency, like of boxwood, of maple, or of ash; but of whatever matter that one does them, it is necessary that they are neither too rigids nor too weak; because if they are too rigid, they cause a movement and difficult and hard; and when they are too weak, they do not push enough, and the tool not finding resistance, does not bite at the places where it is necessary to insert in the workpiece. One also falls into the same defect while making use of a counterweight or too heavy or too light. It is why it is necessary to use a fairly strong spring, and a sufficiently heavy counterweight. The practice has taught me that a counterweight from twelve to fifteen pounds is sufficient for pushing a crankshaft well, and overcoming the resistance of the tool, and that more the rope which supports it, was long, more the movement of the crankshaft was equal and sure. As for the springs one can not exactly, neither so precisely determine the thickness of it neither the width, nor even the length and figure. Because one can make them right, curved or bent, short, narrow and thick; but of whatever nature that they are, it is always necessary to observe that they are neither too rigid nor too weak, what one can determine only by the usage and the practice.

## FIFTH CHAPTER

Another manner of assortment commonly called the Chassis, by which one can dispose as many figures as desired along the entire length of the crankshaft, with the disposal of a wheel.

### *Plate XXI*

This Plate represents another way of assortment appropriate to turn in figure. It is usually called the chassis, because indeed all the principal pieces being well assembled represent a chassis well composed of a crankshaft, two support rings, and a cross bar, which each end is supported by a support ring. I have found this manner of assortment very convenient, because one can thread in all the length of the crankshaft, since the narrow part until the wheel, several rivet washers of various figures.

The detail of all the parts which compose this assortment, will make some well know the composition.

A Profile of the Lathe and of all the assembled assortment.

B Profile of the posterior support ring.

C Width and height of the posterior support ring.

D Profile and thickness of the former support ring.

E Width and height of the same support ring.

F Length, width and thickness of the cross bar.

G Plan of the same cross bar with its round opening for the passage of the rope.

H The same cross bar in perspective.

I Two assembled support rings and the cross bar.

K A screw with square stem to stop the movement of the chassis when one wants to turn simply in round.

L Small screw on the ring of the posterior support ring, to stop the pipe N.

M. Profil of the pipe N whose bottom must be bored as a nut to receive the screw of the punch P.

N perspective of the pipe N which must enter into the ring of the posterior support ring C.

O Small spiral spring that one puts in the pipe N.

P Punch of iron whose screw is encased in the nut that is at the bottom of the pipe M to press against the point of the crankshaft the small **journal** Q.

Q Small journal whose tail must enter into the spiral spring.

R The pipe N, garnished with the punch P, the spiral spring O, and the small **journal** Q. The use of this spiral spring is intended for the movement of the crankshaft from the front to the back. For this effect one will withdraw the punch P, so that the movement is free.

S All the assembled machine and all the Turn garnished with its wheel in perspective.

T. The lever or recoil with caster.

V Support garnished with a platen suitable to be raised or lowered to level the cutting edge of the tool at the center of the crankshaft.



X Bar or iron cross bar that joint the two Poppets, and along which the lever with caster runs to be put on the place of the rivet washer which one will want to use for the ornament of the work.

a Profil of the former Poppet.

b Face of the same Poppet.

c Mortise for the iron bars XX.

d Mortise for the screw with square stem K.

e Mortise for the passage of the cross bar I.

f The former Poppet in perspective.

g Hole for the passage of the nail h.

h Nut which attaches the support rings to the Poppets by their holes l, l.

*The Reader will observe that the Engraver represented the Turn on the right, and it must be on the left.*

## SIXTH CHAPTER

Another assortment of two poppets for the figure.

### *Plate XXII*

I represent in this Plate the detail of an entire assortment of two Poppets for the figure. And for better making known the dimensions, I have put a scale of 20 inches at the bottom of the Plate, though it is free to each one to make them more or less large, according to whether he judges it necessary.

The posterior Poppet must have the top of the face bored by a square mortise to place at the inside a square pipe of smooth brass D, so that the prism or parallelepiped F also of smooth brass can slip easily there. The top of the head of the same Poppet A or C must be also bored at b, for the passage of a screw 4 which is used to stop the prism. One will attach to the bottom of the back of the Poppet a good steel spring L, whose end at the top is precisely applied to one of the ends of the prism 5 to push it back from the back to the front when one makes use of the crown to figure a piece. Then screw 4 will be loosened so that it has its free movement. And so that the pipe of brass do not leave the mortise, one will attach on each end of the same mortise a platen of brass also bored with a square hole equal to the size of the prism E.

Detail and representation of the posterior Poppet and all its parts.

A, B, C the face, profile, and the perspective of the posterior Poppet.

D Pipe of square brass.

E Thickness and length of the prism or parallelepiped of brass that must enter into the pipe D.

F Thickness of the prism seen by one of its ends.

G Prism in perspective.

H Square pipe filled of the prism.

I Platen of brass that one applies in front of the square mortise I, to prevent that the square pipe do not leave.

K The same platen in perspective.

L Thickness, length, and width of a spring.

M Profile of the Poppet garnished with all its parts.

N Strap hinge to hold the spring.

O Nut to tighten the strap hinge.

P Poppet in perspective, sight by the side, and from the front.

Q The same Poppet in perspective seen by the side, and from the back.

The former Poppet must be broader, and less high than the posterior one. The front must be notched by a double track for the two tails of the support ring, that will be made of brass or of iron, and of an enough great thickness to prevent that it does not make spring when the rivet washer of the crankshaft pushes the lever of the recoil. Its double tail X must run easily in the double track of the Poppet, in order to be able to raise it and to lower it as much as it will be necessary when one wants to put the center of the crankshaft at the same level that the cutting edge of the tool. It makes on this occasion the same function that the

broken base represented in Plate XVIII, and when one establishes it at the required height, it must well be tightened to the Poppet with the iron leg p, q. It must be split transversely and, at each sides of the opening for the crankshaft, and about at the same level of the center of the crankshaft by two mortises, enough long to be able to advance or to move back the arms which carry the lever or recoil, according to the size of the rivet washers. The large opening for the crankshaft must be cut as grooves or tracks, to make there slide the two collars of the crankshaft. These two collars hi should not be indent like those which entirely embrace the collar of the crankshaft, but one must make them right and very plain, and put them quite parallel and distant the one from the other in such a manner that the neck of the crankshaft can slip easily between the two. It is also necessary to pose them well horizontally, so that the crankshaft in its movement is always in the same stable position.

*Detail of the former Poppet and of all the parts which accompanies it.*

- a* Face of the former Poppet.
- b* Profile of the same Headstock.
- c* perspective of the same Poppet.
- d d* Double track for the support ring with double tail.
- e* Support ring with double tail.
- f* Thickness and profile of the same support ring.
- g* perspective of the same support ring.
- h* One of the right collars for the crankshaft.
- i* perspective of the same collar.
- k* Plan of the same collar.
- l* Plan of the support ring.
- m* Profile of the arm that carries the lever or recoil.
- n* perspective of this same arm.
- o* Square capscrew to stop the collar.
- oo* Another screw as a collar to attach the rope to it or to the spring or to the counterweight.
- p* Iron leg or staples to stop the support ring against the Poppet.
- q* perspective of this same leg.
- r* Nut for this leg.
- s* Pulley for the rope of the counterweight.
- t* Ring of brass on which the pulley rolls.
- u* The Poppet garnished with all its parts seen from the front.
- vv* The same Poppet garnished with all its parts seen by the side.
- aa* Profil of the lever, or recoil.
- bb* perspective of the same lever.
- cc* The front of the same lever.
- dd* An arm garnished with the lever.
- ee* An arm garnished with the lever against which a rivet washer with eight sides rests, in the same manner that it rests in the time of work.

## SEVENTH CHAPTER

Various other poppets as well simply to turn in round, as to turn in figure.

### *Plate XXIII*

Having found the use of the Poppets of the present Plate extremely convenient, as well for turning simply in round, than for turning in figure, I have wanted to give on it the detail as well by their dimension, as by different views to better give them to understand. The two first A & D are used for the same assortment, the Poppet A being the former, and the Poppet D the posterior one. And here it is the detail of all their parts and their dimension.

#### *Detail of the Poppets of the Pieces of the present Plate XXIII.*

- A Face of the former Poppet.
- B Profile of the same Poppet.
- C The same Poppet in perspective.
- D Posterior poppet viewed from front.
- E Profile or thickness of the same Poppet.
- F The same Poppet seen in perspective.
- G Platen of brass that one must apply in front of the face of the former Poppet with four small nails cut as a screw.
- H Fillet to be used as support ring to the crankshaft when one only wants to turn simply in round.
- I Another fillet for the collar of the crankshaft when one wants to make it be used for turning in figure. One needs a pair of each fillet, namely to turn in round or in figure. The first pair H must be indented at the middle to embrace the collar of the crankshaft; but the second I must be entirely plain, so that being parallel, the crankshaft slips easily between two in the movement that it must make when one wants to turn in figure.
- K Former headstock garnished with its platen of brass G, and two fillets h & q, that one must tighten with two little wood wedges s, s.
- L The same former Poppet garnished with its platen of brass and the couple of fillets appropriate to turn the figure. One tightens them also with two little wedges of wood, t, for maintaining them quite parallel.
- M. Face of another Poppet appropriate to turn in figure.
- N Profile and thickness of the same Poppet garnished with two iron subbands that form the slide for the support ring.
- O Face of the same Poppet garnished with two subbands, and its support ring made up of four fillets, of which the two at the middle uu are properly the support ring of the crankshaft. The two other rules tt, are used immediately as tracks for the two reglets uu, that one must make also equally broad, so that they can slip well uniformly between the two rules tt. And it is for this subject that these two quite parallel rules should be adjusted, but so that the two rules uu can slip between two easily. One stops the two rules tt with two small screws, once they were put quite parallel, like can be seen in the Poppet P,

represented in perspective. It is also with two small screws as must be stopped the two rules uu, when they are tightened to the collar of the crankshaft. And when one wants to turn in figure, one will loosen the screw of one of these two rules from the side where the crankshaft must move itself, so that it has its free play.

Q Profile of posterior Poppet D. One attaches in the channel hollowed at the front of this Poppet diverse wood rules to be used as register to the screws and the collar of the tail of the crankshaft. Also one attaches at the back of the same Poppet a spring b that is used to return the crankshaft from the back ahead when a screw is turned; and after having finished the screw, one tightens this same spring by the means of a wood wedge p, that one inserts in the cramp o.

R The same Poppet in perspective garnished with its register, the spring b, the cramp o and the wedge p.

a Crampon in perspective.

b The spring of behind the Poppet.

c Brass or iron small pipe that one enchases in the opening of the Poppet d, and where the end of the crankshaft d is inserted.

e k f l Represents another kind of support ring that one attaches on a Poppet, as one can see on Poppet STV. The collar of the crankshaft is retained in this support ring by means of a small ruler k, and a forked collar g and h that one can tighten against the collar of the crankshaft with the wedge l to prevent that it roams.

## EIGHTH CHAPTER

Very particular assortment for the movement of a crankshaft for figures, which is held and supported through the two ends by two bezels with spring.

### *Plate XXIV.*

The use of this assortment for the movement of the figures is one of the easiest that I have ever practised; it is why I have wanted to give a particular detail of all the parts which compose it, not only by various plans and profiles, but still by a scale of twelve inches marked at the bottom of the Plate, to make know better its measurements and composition.

### *Detail of the Pieces of this Plate.*

A Face of the former Poppet.

B Profile and thickness of the same Poppet.

C The same Poppet in perspective. It is bored transversely by a square mortise r, in which one must pass the tail of the key L, which, like a hinge, must support a second key M, as one sees in the figure P. The same Poppet is also dug at each side by a groove answering directly under the mortise r, for the free entry in the tail of the key M. The disposition of this mortise, of this groove, and of these two keys must be such, so that one can duly establish the lever at the level of the rivet washers; namely, to be able to precisely establish the center of the lever on the same horizontal line than that of the rivet washers or of the crankshaft, by raising or lowering the key M. And so that one can also approach as one will want it the lever to the rivet washers by advancing or moving back the key L in its mortise r. For this subject an iron or wood screw will be attached behind the Poppet, facing the mortise r, so that by tightening it one can well stop the key L. In the same way it is necessary to stop the key M on the first key L with another screw, as one can see in the figures P & HH.

The Turners will find a very great serviceability in this disposition; because there is no one who does not know the need that there is, that the center of a lever or as a wedge or as a caster, is precisely on the same horizon that the center of the rivet washers or the crankshaft; and also as long as one can make that the support ring that carries the crankshaft, always remains in the right perpendicular, when one wants to turn in figure. Because if one is committed to tilt the support ring, on the side of the lever, one will not be able to avoid that the tool bites rather one side than the other on the face of the piece, what always causes irregularity.

D Face and width of the posterior Poppet.

E Profile and thickness of the same Poppet.

F The same Poppet in perspective. This Poppet must have the top of its head split back to front by a groove with dovetail 4, to place there a prism or piece of wood X, to which one will attach an iron screw for firm and stable stop of the lever p p; so that it cannot move back when one turns or the rampant or the

crown. This same Poppet is still dug at the front and quite in the middle from the bottom to the top by the channel u as large as the support ring G. It is however necessary that the support ring G as it is there enchased, it has its free play when it will make the spring in the movement of the crankshaft front to back, or back to front. Also it is necessary that this same channel is much more inserted towards the head than towards the tail, for the same reason that I have just said.

G Support ring for the former Poppet.

H Support ring for the posterior Poppet. It is necessary that the tails of these two support rings are long, and that they are of a rather sufficient thickness, that is of a little more than one line; so that they are enough strong to be able to make the spring for the play of the crankshaft front to back, and back to front. The head of the first G must be rather large and open to place there the two narrow parts of the collar of the crankshaft. It must also have two small arms like screws to be able to stop it with two nuts, as one can see in the figure FF, so that it cannot waver from right to left, or from left to right when only the simple round is turned. But one will loosen the nuts to give him the necessary play when one wants to turn in figure.

The second support ring H must be equally wide all over, and its top end must be split in such a way that it can receive the collar a of the tail of the crankshaft AA, as one can see in the figure DD, where the simple profile shows how the collar of the tail of the crankshaft is enchased in the slit of the support ring H. One can also attach each one of these two support rings by two nails cut as screw n at the bottom of their Poppets if it is wanted that the spring is more vigorous. For this effect, one needs that the opening of the top nail is a little longer than wide, as one can see in the two support rings GH; so that they move freely from right to left, and from left to right, when one turns in figure, by loosening the nut of the top nail.

I Profile and thickness of the key that must enter in the square mortise r of the former Poppet A and B.

K Plan of the same key.

L The same key in perspective.

M Face of the key to which must be attached the lever, and whose tail enter the square mortise of the key L.

N Thickness of the same key M.

O The same key M in perspective.

P The same key M attached by a screw in the mortise of the key L.

Q Plan of the cramp with four teeth, that must be attached by two good screws, at the top of the face of the former Poppet.

R Profile of this same cramp.

S This same cramp in perspective.

T Iron bandage that must be used as a buckle to the support ring of the former Poppet, when it must make its movement from right to left, or from left to right.

V This same platen in perspective. It must have one of its openings for the passage of the screws that attached it to the Poppet, split until the edge, so that it can

- be lowered when one will like to turn the rampant. Being lowered, it must not forbid the movement back ahead of the former support ring G.
- X Piece of wood that enters into the track 4 at the top of the posterior Poppet. (Fig.D and F.).
- Z Profile and length of the same piece.  
& Face of the same piece.
- HH The former Poppet viewed in perspective, and garnished with two keys L and M, the cramp S, and the iron platen V. One sees there how the lever is attached to the key M, and how this key M is attached to the head of the key L by a screw, and how finally another screw attaches the same key L to its Poppet.
- KK Posterior Poppet in perspective, where it is seen how the piece X is inserted in the groove with dovetail 4, and how the lever pp for the rampant and the crown, is stopped under this piece X by means of a screw.
- AA Profil and length of the crankshaft garnished with several rivet washers, its pulley, and a Platen for the rampant, and still with a crown. This platen for the rampant, and the crown for the waves are attached each one on the end of a cylindre of wood that is bored transversely all to length in order to be threaded by the tail of the crankshaft. One can stop it by a small iron pin which passes through the tail. One can also withdraw it by removing the pin according to the need that one will have, or of the rampant, like in figure DC, or of the crown as in the figure aa.
- BB Is an iron stem which also threads in the body of the crankshaft, and where one stopped it by means of a small iron key. I have found this manner enough convenient to report on the same crankshaft several different rivet washers; but the whole should be quite fitted, so that the rivet washers are not off-center. One can make this stem or round or square. I find the round, easier and just, but the rivet washers o are not so well ensured as the rivet washers oo when the stem is square.
- DD Profil of the posterior Poppet and part of the crankshaft, to show how the tail of the same crankshaft is enchased in the notch of the support ring H by its small coll.
- EE The former Poppet in perspective to show how the platen V holds restrained or firmly the support ring G, so that it does not advance, or does not move back ahead back.
- FF A part of this support ring to show how by means of two nuts it is firmly held, so that it can not displace neither from left to right nor from right to left.

Also I have wanted to represent in this same Plate a very convenient kind of support, as well to raise and lower it, as to hold the tool assured and firm. This support is composed of three parts, of which the first L L is a piece of wood sufficiently high and thick, so that one can notch in its two sides a track or grooves for the legs of the trestle II. The second part is this same trestle II, of which the top or the back must be exactly right and levelled, and the legs well in right angle to put it well horizontally, what is very necessary in any kind of support; because for little that a support leans more than one side that of the other, the angles of the figures that one notches on a piece while turning, will



never be accurate, and the ones will be higher than the others. What causes deformity on the piece. It is also necessary that the legs of the trestle II are split for the passage of the screw qq, that must be used to stop it at the height that one will have established; and so that its higher plan remains always well on level, it is necessary that its legs slip neither too easily, nor also with force in the grooves of the piece of wood. The upper part of this same trestle must be split by a long mortise, and enough wide, so that it can receive another small iron trestle dd, which is the third piece that composes this support, and which is used to hold the tool immovable by the means of a small screw that tightens it on the platform of the large trestle, as one can see in the figure LL, mm. This small trestle dd, must easily run all along the mortise of the large trestle, in order to be able to transport the tool from a side to another.

b Profile of the length and height of the small trestle.

c Profile of the thickness of the same little trestle.

dd This same small trestle in perspective.

LL Screw that is used to stop the large trestle on the piece of wood OO.

f Profile of the length and height of the large trestle.

g Another profile of the legs of the same trestle.

h Higher plan of the same trestle that shows the length and the width of the mortise.

II The same large trestle in perspective.

OO, LL, mm All the three pieces together viewed in perspective to show how one can raise and lower the large trestle, and how the tool t must be posed to be strengthened between the legs of the small trestle by means of a screw.

n Nail as a screw to attach the support rings to their Poppets.

pp Lever as well for the rampant as for the crown. One sees in figure DD this same lever in its place, and how the rampant, coming to rubbed against its point, makes make the spring to the support ring H. The bent part of the same lever pp is useful for the play of the crown. For this effect, the front of this elbow must be cut as a hump rounded, or a little blunted, so that it is inserted more in the notches of the crown.

## NINTH CHAPTER

On the simple rampant, and on the one for figures, and on the use of the crowns.

### *Plate XXV*

I represent in this Plate, three cranks shafts of the same structure, but garnished with different pieces to make various ornaments. The first crankshaft F is garnished with a ramp and a rivet washer for the rampant, as well simple as figured; what is carried out by a double movement that the crankshaft makes from right to left, and ahead back. One can for this subject put the ramp with the rivet washer, all uniting to the collar of the crankshaft; but it is necessary in this case to cut a little long rivet washer, such as one sees in this example on the crankshaft F, and to make use of a double lever e or f, so that at the same time as the crankshaft is pushed back from left to right, the other pushes it ahead back. One needs also to make use of two springs or two counterweights the one beside the rivet washer to push from left to right, and the other, at the tail of the crankshaft, pushes it back back ahead. By this means one can cut a baluster or a rampant and gadrooned box, or with sides, and of such ramp, and of so many angles as one will want, according to the inclination that one will give to the ramp, and the number of sides in which the rivet washer will be divided. I call the ramp a round platen of iron or of brass, opened in the middle, and attached at a cilindre cut skew D. Or so that the cut in skew is quite right, it is necessary to dig a channel in a piece of wood squared B, and there to make a notch transversely a or c with a saw, with such a skew, or according to the angle that one will want that the slope is inclined, and there to stop the cilindre E in the channel C, the notch that one will have already made there with a saw, will be used as control to cut it skew in two parts DD. After that it will have to be observed that of as much more than the slope is inclined, one must hold the collar of the lengthened crankshaft, so that it has sufficient play in its ahead back movement. It is necessary to also observe that the rivet washer is long enough like it is seen in the present example, so that it has space enough for the lever to press it always. It is necessary to cut these rivet washers into eight rounded sides if it is so wanted that the baluster, the vessel, or another piece that is wanted to be made, is also in eight sides, that will become right if it is used the double lever to wheel GG situated at the opposite of the edge of the tool; and the same sides will happen to be rounded or gadrooned if the cutting edge is put where it is the lever to wheel, by making turning the crankshaft on the same side. It is still necessary to know that the lever that presses the ramp, must be made as a cone a little truncated, but rounded in its extremity, like a small nipple; and so that both ones last still more, namely, the lever and the ramp, it is necessary to make this one of a iron platen united and polished, and that one of one of brass shruff.

The theory of the first crankshaft that carries the ramp, will give enough to know the theory of the two others K, N garnished with various crowns to make these ornaments in network, such as those of the boxes O2 and O3. One notches for this subject the edges of these crowns by opposite notches LM round, right, or acute according to the ornaments which one wants to make. One can also cut the back of each crown as sides or as gadroons like g, g to make with the double recoil, or lever f or e, at the same time on the same subject the gadroon and the crown. One still can with these crowns, particularly with the small notched crown of the crankshaft N, to cut a rose in network i, or rays undulated o on the lid

of some limps. It is necessary for this subject to have figured tools, namely, those which edges are circumvented according to the ornaments that one wants to make. By example, if one wants to make a rose in network, one needs that the cutting edge of the tool is curved like an arc of circle, such as the profile cc; and if one wants to make rays undulated, it is necessary that the cutting edge of the tool is undulated like aa; and that they are indented in moulding plane aa, bb, if one wants to make ornaments like beads of rosary on the edge of the lid. Each curved or undulated tool will make its notches of comparable nature than its profile; namely, that the tool with curved cutting edge cc will make arcs of circle at the bottom of the box 7,8, and if the cutting edge is undulated like aa, it will make undulated rays o.

There are some who to cut the rose i use two different tools whose cutting edges are curved in the same arc of circle, but in opposite directions k, l. This way is neither convenient nor clean; just a sole tool is enough for that; and here it is the way of making use of it to cut the arcs in such a way that crossing the ones with the others, they form this rose reticular. As the crankshaft is turning by its ordinary movement, and the workman holds the cutting edge of the tool between him and the center of the limps, the tool will form the first arcs of circle 7, which being formed, it must only to change the cutting edge of the same tool on the opposed side of the box, namely, on the other side of the center, and he will make turning the crankshaft in the opposite direction, so that the tool cutting edge cuts; then it will make the second arcs of circles 8; that as being opposed to the direction of the first, will come to cross together, and will form the reticule i.

FOURTH PART  
*On the engine Lathe for the oval and other figures.*

FIRST CHAPTER  
Assortment to turn in oval.

*Plate XXVI, XXVII & XVIII.*

This way of turning in oval is even carried out by the oval, by applying an oval rivet washer to each end of a crankshaft. The great inequality of the diameters of these oval rivet washers obliges to make use of two at the same time, so that the movement of the crankshaft from right to left, and from left to right, being parallel to its axis, the tool also cuts by all the piece; what one cannot do with only one rivet washer; because then the crankshaft as it describes a large arc of circle, the tool cuts rather one side of the piece than the other, and makes it consequently of an unequal thickness. However to avoid this defect, one is obliged to make use of a crankshaft garnished at each end with an oval rivet washer. One can even to avoid this inequality in all the other figures, as by example in the octagone, to adjust two octogonal rivet washers on the same crankshaft just as the two oval rivet washers, in order to have a parallel movement.

I stopped not in describing the way of tracing an oval. I will say only that if one wants to turn of large frameworks or oval edges, it is necessary that the oval rivet washers that one will want to adjust on the crankshaft, have the large diameter the double longer than the small one, namely, that if the small diameter is of two inches; it is necessary that the length has four; two rivet washers of this size will be enough to turn a framework of almost a foot and half of diameter.

Since one must apply two rivet washers to the crankshaft so that its movement is parallel to its axis, it is also need to make use of two Poppets garnished with equal support rings, and two quite equal springs; so that being bandaged both also, the one does not pull more than the other. The detail of all the parts which compose this machine, and the assemblage of all together, will make better know the construction, and the scale at the bottom of the Plate will give all its measurements. And to give a more precise detail of it, I have draw all the pieces in two Plates, of which the first (Plate XXVI) shows the Poppets as well naked as garnished with their support rings, their springs, and their levers; and the second (Plate XXVII) all the pieces which compose the crankshaft, at last all the assembled machine.

*Detail of the Pieces of the Plate XXVI.*

- A Face of the former Poppet.
- B Profile of the same Poppet.
- C Another profile of the same Poppet, where one views the side bored by a small mortise to attach there a spring.

- D This same Poppet viewed by the back in perspective.
- E The same Poppet viewed from the side in perspective.
- F Face of the posterior Poppet.
- G Profile of the same Poppet.
- H Another Profile of the same Poppet, where one sees also a small mortise to attach another spring to it.
- I This same Poppet viewed by the back in perspective.
- K The same Poppet viewed by the side in perspective.
- L Face of an iron support ring that one must attach to the Poppets.
- M. Thickness of the same support ring.
- N The same support ring viewed in perspective.
- O Profile of a small iron blade, that must be added to the support ring.
- P Plan of the same blade.
- Q The same blade seen in perspective.
- R The support ring in perspective and garnished with its small blade.
- S Face of the Poppet garnished with its support ring.
- T The same Poppet garnished with its support ring in perspective.
- V The same Poppet garnished with its support ring and its spring.
- X A spring attached to a handle for the mortise q of the Poppet T.
- Z The naked spring.
- @ The handle without spring.
  - a Face of a key where it is attached a lever of recoil c.
  - b Profile of the same key.
  - c Profile of the lever.
  - d Thickness of the lever.
  - e Plan of the same lever.
  - f The key of the lever in perspective.
  - g The lever in perspective.
  - h The lever attached to its key viewed by front.
  - i The same lever attached to its key viewed by behind.
  - l Nut that holds the key attached to the support ring.
- m, n Wedges as a screw to hold the support rings attached to the Poppets.
- o p Nuts of these wedges.

One sees in Plate XXVII all the detail of the crankshaft intended to the execution of this way to make the oval. One sees there also this same crankshaft garnished with all its parts, assembled on its two Poppets also garnished with the support rings and the springs for the movement of the same crankshaft.

*Detail of the Pieces of Plate XXVII.*

- A Profile of an iron naked crankshaft and finished by two screws.
- B This same iron crankshaft, naked, viewed in perspective.
- C Profile of this same crankshaft naked and garnished with a brass collar. It is necessary that this collar is stopped so well by the punch of the crankshaft, that it is completely motionless; what one will be able to do, or by welding it there, or by stopping it with two small pins rivetted which must cross the collar and the crankshaft.
- D This same tree garnished with its brass collar in perspective.
- E Profile of this same crankshaft garnished with two collars, two oval rivet washers, its reel and its pulley.
- F Nut of the screw of the tail of the crankshaft, that is used to tighten, and to firmly hold all the pieces that cover it.
- G, H Size and perspective of two little pulleys b, on which one passes the ropes of the springs that bandage the crankshaft against the recoils or levers.
- I, K, L Face, profile and perspective of the nut that must firmly hold the piece to be turned against the escutcheon of the large collar of the crankshaft. And so that the piece is better stopped, it is necessary to attach two small iron points a, a to this same escutcheon. These two small points a, a by entering into the piece when the nut L is pressed, will prevent that, at the moment of turning it, it will ever move from its first situation, and it will itself not be decentered.
- M Profile of the collar of the tail of the crankshaft.
- N This same collar in perspective.
- O Rivet washer with eight sides.
- P Oval rivet washer.
- T One sees in this figure how the oval rivet washer by making its friction against the lever by means of the spring, can make advance or move back the crankshaft.
- V One also sees in this figure the crankshaft garnished with all the parts, except the pulley, assembled on the two Poppets, and hauled against the two levers by means of the two springs.

*Explanation of the Plate XXVIII.*

One sees in this Plate two different dispositions of two wheels. The first figure shows how turning to the hand a large wheel similar to that of the Cutlers, one can make to turn a crankshaft garnished with rivet washers, assembled on the Poppets described in Plate XXII.

The second figure shows the whole machine described by the two preceding Plates, in a position to work by means of a wheel attached under the bench of the Lathe, and described in Plate XV.

## SECOND CHAPTER

Assortment of two poppets for the oval figures.

### *Plate XXIX.*

Though the two Poppets that I represent in this Plate, can be useful for all kind of crankshaft in figure, I have however adapted them for the gadrooned oval. Each one is made up of two Pieces; the one stable, and the other mobile, because one can raise it or lower it according to the needs for the work.

*Detail of these two Poppets, and the Pieces that accompany them.*

A Face of the stable piece of the former Poppet.

B Profile of the same piece.

C The same piece in perspective.

D Brass platen that must be applied to the back moving piece K.

E Front platen of the same moving Piece K.

F Profile of the moving piece K garnished with its two platens; which must be made a little thick to produce this piece rather strong, so that it can resist the spring which can cause the movement and the violence of the figure.

G Width, height and face of the support ring that must enter into the track u, u of the moving piece. This support ring must be of iron or brass; it should not be entirely flat, but thicker at the middle r than on the edges, so that its play is freer. For this same reason, the opening at its bottom, where the nail that hold it attached to the piece must pass, must be a little larger than the nail is thick.

H Thickness of the same support ring.

I perspective of the same support ring.

K The wood Plank of wood of the moving piece, in perspective.

L One of the brass platens that must garnish the front and back of the wood Plank K.

M The same wood Plank garnished with its two platens, or the whole moving piece in perspective.

N All the Poppet garnished with all its pieces as viewed by front.

O The same Poppet garnished with all its pieces as viewed by its back.

P Face of the former Poppet.

Q Profile of the same Poppet.

R perspective of the same Poppet.

S Face of the moving piece of the same Poppet.

SS This same moving piece in perspective. Because it is dug in track, it is enough to apply a brass Platen to its front.

T Face of the support ring that must enter into the track of the moving piece SS. This support ring must be garnished by front and behind with a brass platen.

V Profile of the same support ring garnished with its two platens.

X The same support ring in perspective.

a Piece of fence for the support ring G.

b Plan of the same piece of fence.

c Perspective for the same part of fence.

d, e, f Double iron arm to hold the lever h.

g Nut that stop the double iron arm on the moving piece M or N.

h, i The recoil or lever with caster.

l, m Width and plan of a wood or tin collar for the Support Ring G.

n Small screw of the piece of fence that is used to tighten the collar.

o Fastens that is used to attach the moving parts against the stable parts of the Poppets. This staples has the stem squared for the also squared openings uu. It must enter the slits tt of the two stable pieces AP to hold them quite tight when one raises them to the necessary height.

p Nut to tighten the staples o.

q Plan of the track of the support ring G, where must run two collars l.

r Plan of the stem of the same support ring that show how this stem must be convex for the free play from right to left. If it were entirely flat, the arrises could prevent the movement, by rubbing the face of the platens.

u Platen or key that enchess in the track X of the support ring T. The opening of this key is hold firmly the interior crankshaft oo of the machine to make ovals, as one will see in the continuation, by two small notches 2 3, so that it does not turn.

x Thickness of the same key.

z Perspective for the same key.

AA One sees in this figure all the assembled machine, and the crankshaft of the oval garnished with a gadrooned rivet washer and supported against the lever by means of a counter-weight.



## FOURTH CHAPTER

Another machine for oval, easier than the preceding one.

*Plates XXXI, XXXII, XXXIII, & XXXIV*

In order to better make understand the construction of the preceding machine, I indeed wanted to give the thought that Monsieur the Abbot Forcet uses himself. I have drawn in four different Plates all the pieces in detail and through figures a little more wide, but I put no precise measurement there; one will be able to adjust it almost to those of the preceding one, whose construction and size are almost the same ones, except that the nut of that of Mr. the Abbott Forcet is in some way different. Because instead of the preceding one where the bearing of the nut slips immediately into the track that form the two half-round Platen, the bearing of this one is just only one small pivot, that being encased in a small opening in the middle of a small squared shelf, obliges it to slip into the groove of the track of these two half-round platens.

*Detail of the Pieces of the Plate XXXI.*

In the first of the four Plates that develop this machine, one sees the second platen truncated, namely that which must slip into the track of the large and first platen, and that must carry immediately the piece to be turned. One sees there also the two canons and the rod, as well in profile as in perspective.

- A Profile of the second platen according to the length of its diameter. *First fig.* B Another profile of the same platen to show how both arrises are chamfered or cut with a bevel.
- C The interior face of the same platen. *Fig. 2.*
- D The exterior face of the same platen. *Fig. 3.*
- E One of the half-round platens that form the track in groove or laminated at the bottom of the second platen. *Fig. 4.*
- F This half-round platen seen by behind for showing the rabbet.
- G Interior face of the second platen garnished with two half-round platens which form the track.
- H The same interior face of the second platen garnished with two half-round platens and with the small squared shelf I put in the track.
- K Plan of this squared shelf.
- L Profile of the same shelf.
- M. This same shelf in perspective.
- N Profile of the great cannon.
- O The same cannon in perspective.
- P Profile of the small cannon that must be encased in the large one.
- Q This same small cannon in perspective.
- R Profile of the rod which must line in the small cannon.
- S The same rod in perspective.

T Nut for the second cannon, *Fig. 11.*

V Nut for the rod, *Fig. 13.*

*Detail of the pieces of the Plate XXXII.*

One sees in the second Plate the nut attached on its horseshoe, the leg of the rod, and this same nut adjusted on this leg, and garnished with the small squared shelf in the track of the two half-round platens. Also one sees there the profile of the two great platens which compose the piece attached in continuation, and in this same profile, the one of the two cannons of the rod, and of the pivot of nut inserted in the opening of the squared shelf.

A Profile of the thickness, and width of the horseshoe of the nut.

B Profile of the width and thickness of the base and of the bearing of the nut.

C The leg of the rod seen in perspective.

D Profile of the front of this leg.

E Profile of the length and thickness of this leg.

G Plan of the horseshoe.

H Plan of the base of the bearing. It is necessary to attach this base on the rounded end of the horseshoe with four well rivetted nails.

L The top of this base seen in perspective.

M The top of this same base with its pivot or bearing in perspective.

N Naked horseshoe in perspective.

O This same horseshoe furnished with nut seen while having.

P This same horseshoe garnished with the nut seen by behind.

T Another sight of this same horseshoe garnished with its nut.

V The horseshoe and its nut garnished with the small squared shelf, adjusted on the leg of the rod.

X This same horseshoe with its nut assembled on the leg, and viewed by the top.

Z This same horseshoe assembled on the leg, and viewed by the lower part.

Q Profile of two different platens united together, of the two cannons, of the rod, of the nut, of the shelf, and of the two half-round platens.

R The disposition of the two half-round platens in the interior bottom of the track that they form, the nut attached to the small squared shelf by its pivot.

*Detail of the pieces of the Plate XXXIII.*

I have drawn in this third Plate the main platen of this machine as seen from all the sides, and still garnished with the second platen in its track. I have also expressed there all the assembled machine, namely, the crankshaft and the platens

garnished with all their parts.

A Face of the large platen garnished with the second placed between the two tracks. *First figure.*

B Face of the same large platen garnished only with two tracks. *Fig. 2.*

C The back of the large platen. *Fig. 3.*

D Naked face of large platen. *Fig. 4.*

E Plan of the large platen jointly with the plan of the two tracks and of the two pieces of iron which hold them attached against the large platen.

F One of the tracks.

G Thickness of the tracks. It should here be noticed that the two small openings *aa* of these two tracks must be the double longer than wide, as one sees it in figure 4, to have the means of putting them quite parallel, and to adjust them so well, than the second platen if it suddenly slips between two of them it can run well easily, without however oscillations. The four small screws *m* of figure 2 are useful for this purpose, by making them advance or moving back them.

H This iron piece is put at the back of the large platen, facing the back of each track. Its two openings are enclosed by the screws that hold the tracks attached to the large platen.

I This iron piece has also the two holes enclosed for the screws *m*, which are used to press the two tracks when one wants to put them quite parallel.

K Screw as much for the piece I than for the piece H.

L The whole machine garnished with its reel, its wheel, and two rivet washers for the gadrooned oval. *Fig. 5.*

*Detail of the pieces that compose the Plate XXXIV.*

One sees in this fourth Platen all the assembled machine, and in a position to work. (*Fig. 2.*) It is necessary for this effect that the two support rings *BC* that carry the crankshaft, are attached to the same Poppet *G* by a long punch with squared head *Q*, so that they play at the same time.

A Perspective of the posterior support ring detached from the Poppet (*Fig.3.*) This support ring is garnished with its piece of enclosure *T*, of which the two small screws *bc* are used the one to tighten the collar *I*, and the other to tighten the running key *H*, *Fig. 4.*

B, C The two support rings attached to the Poppet *G* by the punch with squared head *Q*. *Fig. 2.*

F Face of all the machine assembled on its naked Poppet and with double tail. *Fig. 1.*

G The Poppet naked and with double tail. *Fig. 9.*

H Running key (*Fig. 4.*) that inserts itself in the track *aa* of the support ring *N*. (*Fig. 6.*) This key is to firmly hold the second cannon of the machine, so that it does not turn, by embracing it by two notches that are cut at its end.

- I, I Tin collars for the two necks of the large crankshaft. *Fig. 4.*
- K Hole that bores the Poppet in all its length for the passage of the punch with the squared head Q. *Fig. 1,3 and 7.*
- L The naked posterior support ring seen in perspective. (*Fig. 8.*) Each support ring must be made up of three pieces, namely of a plank of wood and of two platens of brass one at the front and the other behind, to form the two tracks *aa* and *oo*, as one sees it in figure 6. The track *aa* receives the key H, and the track *oo* the two collars of tin I, I.
- M. Brass platen for the support ring L.
- N Support ring garnished with its two platens in perspective. *Fig. 6.*
- O Face of the support ring stripped of its two platens, but garnished with two collars. *Fig. 11.*
- P The same naked support ring viewed in perspective. *Fig. 10.*
- Q Punch with squared head to join the two support rings, one at the front of, and the other behind the Poppet. *Fig. 13.*
- R Face of the piece of fence of the posterior support ring. *Fig. 12.*
- S Plan of the same piece of fence.
- T The same piece of end in perspective.
- a, a Track for the running key H.
- b, b Iron band attached along the higher plan of the Poppet G, to hold firmly the two levers *ee*. *Fig. 2.*
- e, e Grooves for the two levers.
- E Flat lever, (*Fig. 5.*) in case that the rivet washers of the crankshaft are cut with right sides; but if the sides were rounded, then it is necessary to make use of a pointed key as a wedge, or of a key with caster. The movement is made by means of two counterweight, attached each one to each support ring, as one sees it at the second figure.

## FIFTH CHAPTER

The same machine assembled on four pillars, and laid out to form the oval figures.

### *Plates XXXV and XXXVI.*

I represent in this Plate XXXV the same chassis than in the Plate XXI, assembled out of four pillars of iron jointed by cross bars, and laid out in the manner of a cage or of a work of the Marshals. One can put on this sash any kind of crankshaft in figures, although I have not adequate it but for the oval in figures; the scale of eighteen inches shows the dimensions of all the pieces that compose this machine, that I have found the most convenient one for the usage of the Lathe for figure.

#### *Detail of all the Pieces of the Plate XXXV.*

- A Crankshaft or chuck to make the figured oval, garnished with all its pieces, and in a position to be posed on the support rings of the chassis. *First figure.*
- N, N A running key which must enter the track M of the support ring ND in the sixth figure. This running key is used to hold fixed the second cannon of the crankshaft for the oval.
- B Profile of the front, or width of the cage. *Fig. 3.*
- C Profile on the side, or length of the cage. *Fig. 2.*
- F Pillars or posts of the cage. *Fig. 2 & d 3.*
- D Cross bars to support the chassis Q of the figure 6.
- d Opening or mortise for the passage of a screw b that is used to hold motionless the chassis when one wants to make use of it only to turn in round. But when one wants to turn in figure, one will only have to loosen this screw. And in order that the crankshaft and the chassis have their movement free, it is needed that this opening d is double longer than wide, as one sees in the present figure 3.
- c Hole for the passage of the screw a that attaches the chassis Q against the cross bar  
D.
- R Profil of the platform on which the cage is posed, Fig. 6.
- G Tenon of this platform to be able to stop it with a wedge on the bench of the Lathe like in the ordinary Poppet. (Fig. 2 & 3.) It is necessary to make an opening even in this platform, at the place of the opening L of the chassis for the pasaje of the rope, that must make turn the crankshaft.
- H One of the pillars in perspective.
- e Tenon of the pillar.
- f Screw of this same tenon.
- g Nut that holds the pillar attached in the pad.

The sixth figure represents the cage, the chassis, and the platform assembled and viewed in perspective.

To better make know the use of this cage, I was obliged to represent all the machine assembled and garnished with its crankshaft for oval in the following Plate. One sees there at the first figure that by means of the counterweight A the chassis and the crankshaft are

attracted to the side of the caster C against which the rivet washer B by rubbing give form to the oval gadrooned. This kind of cage can still be useful for any kind of crankshaft in figure, by adapting the posterior support ring of the chassis to the crankshaft that one will want to put there. In this figure the posterior support ring of the chassis is not appropriate but for the machine for oval.

I have also represent in the same Plate a simple machine for oval assembled on only one Poppet. The dimensions of its two principal platens are the same ones than those of the platens IK of the Plate XLIII, but with this difference that the large platen A of this one (Fig. 2.) must be much thicker to be able to dig in its thickness a pulley for the rope, also as to be able to make a neck rather broad B at its middle for the collet C of the crankshaft D, as one can see in the two profiles B and C. The nut of this machine is still a little different from the others; because the bearing E must be indented until half its thickness; and the head F of the rod G must be cut in such a manner that the axis of the same rod can come to answer at the center of the bearing, when the rod and the nut are adjusted together, as the two figures H, I mark it.

*Detail of all the pieces of this machine for oval.*

A Face of the large platen.

B Profile of the same platen.

C Collet of the crankshaft.

D Part of this same crankshaft that must be cut at the side for the Opening Q of the Poppet O.

N The crankshaft in perspective.

O Face of the Poppet. It is necessary to attach to this Poppet two brass platens; the one in front of and the other behind, for the rubbing of the large platen, so that it rolls more easily on that of the front. That of behind must be used for pressing more strongly the large nut R of the tail of the crankshaft.

P Profile of the Poppet and of all the machine for oval assembled.

Q Octogonal opening which must receive the octogonal part of the crankshaft.

L, L Various sights of the rod, in order to better show how its head must be cut.

M. Plan of the same rod seen by the back.

F, G Plan of the same rod, viewed by the side.

E, E Profile and perspective of the nut.

K Plan of the same nut.

## SIXTH CHAPTER

Manner of making an oval by means of a ring, and the oval of the tin potter.

*Plates XXXVII & XXXVIII.*

One sees in this Plate, two whole sets for two different ways of turning an oval. The first is made by means of an iron or brass ring, assembled on a crankshaft, in such a way that turning on its axis one can incline it according to the degree which one will want, so that the extent of the oval is more or less. Because as much more the ring will be tilted on its crankshaft, as much the oval will have both diameters different; and the reason of this is that the ring because it is perpendicularly stopped, the axis of its crankshaft remains always equally distant from the platen on which the ring rubs while turning, because the two diameters, the perpendicular and the horizontal one, are in the same situation; but when one of these two diameters, namely the perpendicular, comes to change its situation due to the inclination of the ring, the axis of the crankshaft will have the opportunity of more approaching the platen when the ends of this tilted diameter will touch it, and to move away some more when the two ends of the horizontal diameter will touch it too. I call horizontal diameter of the ring, that one on which the ring moves like on an axis, and I call perpendicular diameter, the one that cuts at right angles first, and that incline itself on the axis of the crankshaft when the ring also inclines itself. This theory easily makes understand why an oval forms itself on the piece that is wanted to turn, and why it is longer or shorter, namely, its two diameters different, according that the ring is more or less inclined on the axis of the crankshaft.

For carrying out this theory well, it is needed that the ring is exactly round, as much in its thickness than in its circumference, and that the platen on which it rubs while turning, is also exactly plain and united. As for the size and thickness of the ring, four inches diameter are enough, and a little more of half an inch in thickness. However it should be observed that by this manner one cannot trace an oval close to the center of the piece, like by the method of a crankshaft garnished with one or two oval rivet washers, it is rather formed a figure similar to one eight in numerals, or to the sole of a slipper.

*Detail of all the Pieces of this Plate.*

The first figure represents a crankshaft assembled on two Poppets, and garnished with a ring for the oval, a platen for the rampant, and with a crown attached against its wheel. The two small Poppets N M represent the use of the two levers M, N. (*Fig. 7.*) This one which is useful for the crown, must be garnished with a small caster, and the other which is used for the rampant, must have its point blunted and round.

B Profile of the crankshaft garnished with the crown, the platen E for the rampant, and with a small escutcheon, on which one must attach the ring, (*Fig. 2.*). This small escutcheon F must be enchased in a mortise C split in the end of the crankshaft. (*Fig. 3.*)

The two small squared capscrews that one sees there represented, are to hold this escutcheon fixed and stopped, so that the intended inclination for the ring, cannot vary while turning; and so that the escutcheon F is more surely stopped, it is good to tighten it well with four screws, two at each side of the crankshaft.

D, D Represent two reels of the crankshaft. They are skew cut according to the inclination that is intended to give to the platen E. (*Fig. 4.*)

E Platen for the rampant; its opening 2 must be oval, so that one has freedom to incline it on the crankshaft as far as one will want it.

F Small round escutcheon. (*Fig. 5.*)

3. Tenon of this escutcheon, where are tied the tenons 4 of the ring G.

G Ring for the oval.

4 Tenons of the ring that are tied to the tenons 3 of the escutcheon F. It is indeed necessary to have care that these tenons are tied the ones to the others by well rivetted nails, so that the ring remains firm and immovable. Note that to make this ring quite right and well rounded, it will have to be turned on its crankshaft after being erected perpendicularly, and stopped with the four small screws on this same crankshaft.

K Platen of iron smooth and polished, which must be used as lever with the ring G. Namely, that the crankshaft being attracted by a counterweight P, the ring will make its rubbing by slipping on this platen K.

L Another iron platen with a small rounded tenon 8. This platen and its small tenon are used to make an crawling oval. On this occasion it is necessary to make use of a spring Q at the tail of the crankshaft, (*Fig. I.*) and of the counterweight P at the head of the same crankshaft. The ring by rubbing at the same time at the level of the platen, will make an oval by the means of the counterweight P, and by rubbing at the same time the rounded side of the small tenon 8, it will make that this same oval will be crawling by the means of the spring Q.

La figure 10th represente un arbre garni de deux rosettes ovales, et monté sur un chassis attaché sur deux Poupées. On appelle cette manière le Ovale du Potier de étain, parce que elle sert aux Potiers de etain à tourner de grands bassins à ovale; on se sert ordinairement de un gros contrepoids qui tirant le arbre contre une planche garnie de une platine de laiton, fait que les deux rosettes ovales frottant contre la platine de cette planche frment en meme temps le ovale. Il faut que ces deux rosettes ovales soient un peu plus amples que celles dont je ai deja parle en expliquant la Planche XXVII, à cause de la grandeur des bassins que on veut faire, mais il ne est pas toujours necessaire que il y en ait deux en chaque arbre; une seule suffit lorsque le arbre est monté sur un chassis, comme on peut voir dans la Planche suivante (*Fig. 1 et 2.*) De meme si on veut se servir de un anneau pour tourner de grandes pieces ovales, il faut que il soit de un grand diametre, tel que celui de la meme Planche (*Fig. 4.*) autrement on ne pourra tourner que de fort petites ovales. The 10th figure,



represents a crankshaft garnished with two oval rivet washers, and assembled on a chassis attached on two Poppets. One calls this manner the Oval of the tin Potter, because it is used by the Potters of tin to turn the large basins to oval; one usually makes use of a large counterweight that drawing the crankshaft against a plate garnished with a brass platen, makes that the two oval rivet washers rubbing against the platen of this plate make at the same time the oval. It is necessary that these two oval rivet washers are slightly wider than those on which I have already spoken by explaining the Plate XXVII, because of the size of the basins that one wants to make, but it is not always necessary that two of them are in each crankshaft; only one is enough when the crankshaft is assembled on a chassis, as one can see in the following Plate (Fig. 1 and 2.) The same if one wants to make use of a ring to turn large oval pieces, it is in need one of a large diameter, such as that in the same Plate (Fig. 4.), otherwise one will be able to turn only very small ovals.

Thus for turning large ovals, as well by the ring as by the rivet washers, the large diameter of these ones is enough long of half of a foot, and the least of a little more than three inches, or almost four. As for the ring it is necessary that it has at least nearly five inches in diameter, and a little more half inch in thickness. I will show in the following Plate another manner of mounting these rings, by the detail of all the pieces.

I thus represent in this Plate XXXVIII, (*first and second Figure*) another crankshaft A assembled on a chassis DC, and garnished with only one oval rivet washer F. The first figure shows how the rivet washer must rub against the Plate or platen D, and the second how the crankshaft and the chassis are drawn against this same platen D, by the counterweight E. The third figure shows another chassis and its crankshaft garnished with a large inclined ring, and the fourth and fifth show the profile and the perspective for all the assembled machine and in a position to work.

*Detail of all the pieces of the Plate XXXVIII.*

First and second Figure. A The crankshaft.

B C The chassis.

D Plate garnished with a brass platen which is used as lever to the oval rivet washer F.

F The oval rivet washer.

E Counterweight that draws the crankshaft and the chassis against the platen or large lever D.

*Figure 3.* A A squared crankshaft on which one must mount the ring C.

B Profile of the length and thickness of the same crankshaft.

C Large ring garnished with its axis.

D Profile of this same ring which shows its roundness and the small edge on which one attaches the axis.

E The axis of the ring C.

F The ring garnished with its axis and two quadrants which by the means of four small screws hold it tilted on its crankshaft.

G Profile of the crankshaft garnished with its ring viewed in two situations, namely when it is located perpendicular to the crankshaft, and when it is tilted on the same crankshaft.

H The crankshaft in perspective garnished with its ring; where it is seen how the two arcs

of circle hold the ring inclined on the crankshaft, and how these two arcs of circle are stopped by screws. One sees there also a little wedge that crosses the crankshaft and retains the axis by its notch, so that the ring cannot at all to move back or from the right to the left, nor from the left to the right-hand side.

Figure 4. Profile of the face of the machine; where it is seen how the counterweight M attracts the crankshaft and the chassis against the plan of the lever or large platen L.

Figure 5. All the machine in perspective and viewed by the side where the counterweight M draws the crankshaft and the chassis against the large lever or platen L.

## SEVENTH CHAPTER

On the turn driven between four parallel support rings.

*Plate XXXIX.*

I have already pointed out enough in the explanations of the machines appropriate to turn in figure, that the arc of circle which describes the end of the crankshaft while turning, necessarily prevents that the cutting edge of the tool touches all the contour of a piece of work, when one turns for example the top of one limps; what causes a thickness inequality, particularly at the time the piece is of a large diameter. However to avoid this defect, it has been sought the means of making the tool equally bite everywhere by doing the movement of the crankshaft, like it is sayd, parallel; namely, that the tail moves itself at the same time as the head from right to left, and from left to right; so that the two situations of backwards and forwards are always parallel to the axis of the crankshaft. I already showed two various specific machines to this subject, namely, whose crankshaft is driven in parallel with its axis. The first is done by the means of two also large rivet washers and also figured and attached each one at each end of the crankshaft; and the second is done by the means of the chassis which however does not prevent the arc that describes the support ring. The machine that I show you in this Plate, is free from this defect, since the axis of the crankshaft is always driven on the same horizon in all its length, and always parallel with itself. It was invented by Mr Ambert, Bourgeois of Lyon, whose merit is not only distinguished because he invents, but also because he carries out the most industrial machines in all the extent of mechanics.

The essence of this machine consists particularly of four support rings, two stables B, B and two mobiles A, A, united from two to two and two mobiles has, united two by two AB on each end of an iron pin F, as one can see in the first figure. Each support ring must be garnished with two right collets of brass or of tin, perpendicular, c d in the mobile support ring A, A and horizontal e, f in the stable support rings BB. It is good that these collets have approximately three inches length, so that the collar and the tail of the crankshaft have more extent in their movement between the tracks that form these collets as well the horizontal ones as the perpendiculars. These tracks, must be exactly equal, and as wide as the collar and the tail of the crankshaft are thick. They must be laid out in such a way, that those of the mobile support rings cross with right angles those of the stable support rings, as one sees it at 1, at the time the mobile support rings will be stopped on the stable ones by the means of a small pin a b. These tracks being thus laid out, it should carefully be observed that the crankshaft does not waver in any manner, without however being too constrained. It still should be observed that at the time one will want to turn in figure, having withdrawn the two pins a b, the two mobile support rings A A move themselves freely and equally, what cannot be made if all the support rings are not quite parallel together, and that the axis of the crankshaft is not as well parallel to the axis of the pin F. It is necessary also that the two holes 3 of the fixed support rings, where must be slipped the two ends of the pin F, are directly faced to and bored on a same line perpendicular to the faces of the support rings. For this subject it will be necessary to round on a Lathe the two ends of the pin, and to bore the two holes together having well united the two support rings,

so that they are more directly opposite the one with the other. Lastly, it is still in need to control that the face of a support ring is applied precisely to the face of the other, namely, that the face of the mobile support ring slips on the face of the fixed support ring along the movement of the figures. With this intention, one will have care to file them similarly well and evenly well, so that friction is done without effort.

All these characteristics are very necessary for an exact accuracy of this machine; what being well observed and carried out, the crankshaft will turn inevitably parallel, since its movement from right to left and from left to right is always made in the same horizontal track *e f* (Fig. K.) of the stable support ring BB. Because although the perpendicular track *c d* (Fig. K) of the mobile support ring inclines itself sometimes on the right, sometimes on the left, it however pushes always the crankshaft in the same horizontal track, and consequently the crankshaft will turn always in parallel; what is the peculiar effect of this machine.

*Explanation of all the Pieces of this first Figure.*

*First Figure.* Profile of all the assembled machine.

A Mobile support ring.

B Fixed support ring.

*a, b* Two small pins which are used to stop the mobile support rings on the fixed ones when one wants to turn simply in round, or to make use of the crowns attached to the pulley of the crankshaft.

E The naked crankshaft.

F Iron poppet spindle which joints together the support rings. The tenon which enters the fixed support rings, must be round, and the part of this same tenon which enter the mobile support ring, must be squared.

G Spring for the play of the crowns.

H Height and width of this same spring.

AA Face of the mobile support ring.

BB Face of a fixed support ring. Each support ring is garnished with two squared collets *c d, e f*. The two collets *c d* of the support ring A A must be indented as swallow tail at the two ends II, to be held firmly by the chamfrein *aa* of the support ring C. For this subject the piece of closing L of the support ring AA must be also chamfered, or cut with bevel LL. But the two collets *ef* of the support ring BB must be ribbed longitudinally to be held firmly by the chamfer of the support ring D. The small marked screws at the two sides of the support ring AA are only used for tighten the two collets *cd*, just as the small screws of the support ring BB are used to tighten the collets *ef*.

O Small iron Poppet to hold the recoil or lever of the crowns attached to the pulley of the crankshaft.

OO Wide and height of this same small iron Poppet.

OV The crankshaft garnished with all its pieces.

*The second Figure* represents the same Lathe in perspective garnished with its support rings, a spring and a small Poppet.

P Q Two header rivet washers, to turn limps in the same way. Their width must be of six

parts, and their length of eight. The 4 sides of the rivet washer P must be a little convex, and the four corners, a little rounded. To make the convexity of these four sides, it is necessary to draw two infinite lines, that cut themselves at right angles in the center of the rivet washer. Take then twenty parts of the six or the eight of the length or width of the rivet washer, and transport them on the infinite lines by starting with each point a, b, d, P. You will have by this means the centers of these 4 arcs of circle which form the convex contour of this rivet washer P of which you will round the corners by forming a square at each one inside the field of the rivet washer with the size of one of the parts b, P. The interior angle of each square will give you the center for the rounding of these corners. One can form at the contour of this rivet washer several different figures, as one sees it in Q, to decorate the works variously.

R, S Buckles of iron to tighten the support TV which carries the recoil or lever of the rivet washers.

R Thickness of the loop.

S Width of the same loop.

T Width and height of the support of the same loop.

V Profile of this same support.

The *third figure* is sent to the end of the work, where one will find the explanation of it. The fourth Figure of this Plate shows the manner of making easy the movement of a crankshaft when the question is that of turning in figure. Usually one makes use of two wheels, of which the one is large, and the other small; this one immediately attached to the crankshaft, and the other posed on two leads to be turned or with the hand or with the foot; but as it is absolutely necessary that the rope is well bandaged, the crankshaft is in some way obstructed, and like stopped by the rope towards the large wheel, which causes it some difficulty in its movement. To obviate this violence, and to make this movement easy, it was thought to add a third wheel b posed in the same plan than the wheel of the crankshaft a and than the large wheel c. In this manner the rope by making all its effort and all its impression on the third wheel b, gives its freedom to the crankshaft for turning without any resistance. One needs for this subject that the wheel b is of the same diameter that the wheel a, and that it is placed as close as it could be to that one, so that the rope by embracing a greater portion of the wheel a, makes it turn with more roideur. One will thus lay out the rope in such a manner that it crosses itself in two places, namely between the large wheel a, and between this one and the wheel b, and this is all the node of the business, of which we owe the invention to the sieur Paradis, one of most skilful Tourners of the Kingdom, whom we can name another Maubois, for the great skill and delicacy in all that can be imagined as curious on the Lathe.

The *fifth Figure* represents a cape chisel a, b very appropriate to link the pieces of work with the Turn well, over all the ivory and the materials a little hard, by making it cut by the biased angles f, g and not from the cutting edge e of the front.

## EIGHTH CHAPTER

On the turn with chassis provided with rivet washers.

### *Plate XL*

This Plate represents three different machines for three different kinds of works. The first is a chassis garnished with its crankshaft appropriate to turn in figure as well by the rivet washers as by the crowns. Its disposition is very comfortable in the course of the operation; and it comes from the genius and at the hands of Sieur De la Grange, not only very skilful engraver, but indeed one of the most experienced Turners of Paris in all kinds of simple and illustrated works and on all kinds of matters; since it is employed in the Mint to turn all the steel and iron dice to engrave there the Medals of the History of the King. This chassis is composed of two shafts AC, BD, and of two cross bars AB, CD. The two shafts and the lower cross bar must be forged of the same piece for a greater firmness, but it is enough that the higher cross bar is a simple round rod, each of its ends being stopped by a small tenon in a small mortise split at the end of each shaft. This rod is not only used to hold firmly the two ends of the two shafts, but even to attach the counterweight to it, as one sees in Figure 2. At the middle of the face of each shaft, (Fig. 3) it must be very much widened and split by a huge notch II, to place there two small tin collars nn, that must form the support ring of the crankshaft. The small channel oo (Fig. 2) notched towards the beginning of this large notch, is there to receive the little wedge uu which must hold firmly the two collars of tin nn. At the front of this large notch II, one must attach to it with two screws a platen ee, indented in the same way, and dug longitudinally by a small channel u to form the track u, in which one passes the wedge tt, which must firmly hold the crankshaft Q by its collar like a pulley aa.

This chassis is supported by two small iron Poppets L L, and each Poppet is garnished with two pointed screws, one downstairs S, and the other upstairs r. The screw downstairs S is used as a pivot or hinge on which the chassis makes its movement when the question is that of turning in figure; but the screw upstairs r is used to stop this same chassis when it is only necessary to turn in round, by tightening it against the shaft.

The form and the disposition of the spring K is indeed strongly to be considered in this machine; it is made in the way of an arc, which at its middle point is bored by a large round opening, able to receive the tail of the nut N O. Its two ends are made by biting to embrace the posterior shaft AC, as one can see in E, (Fig. 1.). The explanations of the preceding Plates where it is exposed the use of the springs, will give enough to know the use of that, without making me stop there any more, since it is not useful that for the play of the crowns attached to the anterior face of the pulley G by the opposition of the lever P.

*Explanation of the other Parts of this same Machine.*

H Face of one of the shafts representing large notch II for the tin support ring n n.

Q The iron crankshaft with squared stem to place the rivet washers there.

N Nut of screw 33 to tighten the rivet washers on the crankshaft.

M Small iron axle box slide that one attaches on the cross bar downstairs, and which is used to carry the lever P for the crowns attached to the front of the wheel G.

*Figure second.* All the machine without crankshaft in perspective.

T The support of the lever V. It is a piece of wood garnished upstairs with a small roller to support the rope of the counterweight x. It must be attached to an iron piece cc, cc bent at right angles, but enough strong to be able to support the effort of the recoil of the rivet washers, so that it does not make any spring. This iron piece bent cc, cc stopped on the bench of the Turn by the means of an iron clamp bb, in the same way like the other supports.

R One of the Poppets which support the chassis.

Z They are eight different rivet washers from the set of the same crankshaft Q. They have approximately two inches and half of diameter; their effect is very pleasant. They are of well hardened steel. I never saw so right nor so filed. The scale of twelve inches put at the bottom of the Plate will make known the dimensions of all the machine.

[FIFTH PART  
*On the Machines for the oval*]

]

SECOND CHAPTER  
Another tambourine box.  
Detail of all the parts which compose this machine.

*Plate XLII*

The Soul of this machine is the same one as that of the preceding one, but the construction of it is a little different, because into that one the base of the flashed rebate slips into the track of the second box, and because the bearing of the same flashed rebate is inserted in the head of the crankshaft, which with this intention must be bored with several holes as large as the bearing of the flashed rebate is thick, and all arranged in straight line after the same diameter of this head, in order to have several eccentric points according to various qualities of the ovals which one will want to make. For example, one will insert the pivot or bearing 7 of the flashed rebate R in the hole 4 of the head of the crankshaft L if one wants to turn an oval whose large diameter is not much longer than the small one; but if one will like to turn an oval whose large diameter is much longer than the small one, one will insert the same bearing 7 in the hole 2, or 1, or 6 of the head of the crankshaft.

*Detail of all the pieces that compose this machine.*

I did not put a scale of measurements of this machine. The one of the precedent will serve to make a judgement about the dimensions that must have all the pieces of this one; with no prejudice neither to the largest nor to the smallest pieces, provided that the whole is quite right and solid.

A Profile of the large box.

B Face of the large box.

a Groove of the large box.

C Inside of the box in perspective.

D Another profile of the same box to show the profile of the groove a.

E Face of the second box which must be inserted in the bottom of the large one on the side of the Poppet.

F Profile of the second box.

G This second box viewed in perspective.

b Mortise of the second box through where the stem of the crankshaft L must pass.

H The two boxes, together united, viewed from behind.

d Nuts of the screws, which hold united the two boxes together.

I Profile of the crankshaft.

K Face of the head of the crankshaft.

L The same crankshaft seen in perspective.

M Profile of the machine assembled on its Poppet, where it is seen how the small bearing of the flashed rebate is inserted in the head of the crankshaft at the same time as the base of the same flashed rebate is inserted in the groove a of the large box.



- N Face of all the machine assembled on the Poppet.
- d Heads of the screws which cross the two boxes to hold them united together.
- O The same machine assembled on its Poppet viewed in perspective.
- P Profile of the flashed rebate, according to its thickness and width.
- Q Another profile of the flashed rebate according to its length.
- R The same flashed rebate seen according to its length.
- 7 Bearing or pivot of the same flashed rebate.

### THIRD CHAPTER

Another machine for the oval, less made up than the preceding ones.

#### *Plate XLIII*

Though this machine is the same one, as the two preceding ones, however it is less composed, as I show it by the drawing that I provide, and by the detail that I will make there. One can see the dimensions of each piece on the scale put at the bottom of the Plate.

The first & main platen A is to be enough thick to be able there to notch on the edge the pulley for the rope. Its opening at the middle B must be in talud or funnel, to receive the head g of the crankshaft f. (*Fig. P, Q.*)

The second platen H has its front raised by a gully 2, whose bottom must be entirely open 2, in order to permit the advancement or moving back of the core V without being obliged to dismantle the platen H, whose internal face L must be dug in all its length by a large channel 3 to be used as a track by the two other small platens KN which must also form the track b, (*Fig. Y.*) into which the bearing of the core V must slip. These two small platens K, N attach themselves to the second L by a small tenon as a screw 4. Thus I have put them mobile, namely, able to be detached from the platen L so that one can repair the default and the inequality of the track which they form when the movement of the bearing of the flashed rebate uses it by its friction; and in order to be able to move away and to approach them the one to the other in order to establish the track b as equal to the thickness of the bearing of the core V. The slits 8 8 should be notched a little long. In this, care is to be observed with the edges of the platens N, which must form the track, are always quite parallel and sufficiently distant so that the bearing of the core V can there easily slip between the two without causing oscillation.

FOURTH CHAPTER  
Expeditious machine for the making of the oval.

*Plate XL*

The second machine represented in this Plate is used to turn the ovals. It was communicated to me by the very honourable and very industrial Monsieur l'Abbé Forcet, who as having tested it, has ensured me that it was very easy to operate with it. It is made up only of three principal pieces, whose first is a brass circle of approximately three inches and half of diameter, and broad in its projection of approximately four lines. This circle is attached to two small platens, more or less as long as the diameter of the circle, opposed diametrically and split longitudinally by the middle. This piece is attached by two screws on a Poppet garnished with a common iron crankshaft, like it can be seen in the Figure P, but it must be observed that the two screws are planted in the same perpendicular line which precisely crosses the center of the crankshaft.

The two other pieces which compose this machine, are the same ones as the two orbicular platens of the other machines for doing ovals, on which I have already spoken, however with the difference that the largest of the two *e* is split by two long mortises longitudinally, and diametrically opposed, and that it has behind a tail or a box tapped inside, to be encased with the bearing of a crankshaft of iron 22 or *n i*. The front of this same platen is garnished with two brass reglets *h* which form a track for the second platen *g*, which is also bored by two other diametrically opposed small slits. One must attach to each of these two small slits a tenon *I* or *K*, and each tenon must be also far away from the center of the same platen. They must be both also distant the one from the other the length of the diameter of the ring *a*. These two bearings *rr* of the figure *M* must turn all around the ring *S*, as one sees in the Figure *Q*, while the platen *M* is attached to the bearing of the crankshaft. And when these two bearings turn around the ring, they slip into the slits *r r* of the platen *M*, and it is while slipping into these two slits that they make raise and to lower the platen *nn* in the track of the Figure *L*. One can make these two bearings *rr* squared or blunted on the arrises, so that they can slip more easily into the two slits *rr*, *rr* of the large platen *M*. It is necessary here to observe (and it is there all the spirit and the secrecy of this machine) that when the circle *a* is stopped on its Poppet concentrically in the center of the crankshaft 22, as one sees in the Figure *N*, the platen *nn* will not make any movement and then one will not turn simply but in round. Although if this circle *a* is stopped by the two screws in such a manner that its center must be or higher or lower than the center of the crankshaft 22; then the eccentricity will oblige the platen *nn* to slip or to move inside its track, what will give the means of infallibly turning an oval longer or shorter, proportionnally to the center of the circle *n i* (Fig. *N*) will be moved away or nearer to the center of the crankshaft 22.

. SIXTH PART.  
*Figures and Profiles.*

FIRST CHAPTER  
On the rosettes that serve to turn the works

*Plates XLIV & XLV.*

The ordinary and common Turn being able to form only works of a simple contour, namely, uniform round, the curious ones have sought the means of making them more pleasant by giving them various figures, like undulated, octagones and ovals. For this subject, they have added to the cranks shafts or mandrels cut pieces in the same way, and called them roses or rivet washers, because indeed their contour resembles that of a rose. These roses thus, or rivet washers, are properly only platens of brass or iron, thick from two to three lines, and broad of approximately two inches, and even a little more. Those of iron are the best, above all if once their contour has been filed and polished, one gives them a good hardening, because they last more, and slip much better on the key.

In this Plate and in the following one I explain and I show the theory and the effect of several various rivet washers, namely, what causes these different hollows and reliefs that one notices on several copper works, as in these side boxes, gadrooned, grooved and notched by various angles or edges or rounding-offs. However for the well understanding of this, it should be known that what is relief in the rivet washer, causes also a relief in the same piece. Here is the reason. The salient angles or the reliefs of the rivet washer by meeting the key move away the piece from the cutting edge of the tool; thus this same tool cannot bite the piece at the place where these angles are; but when the hollow of the rivet washer approaches the tool's piece, the tool dig the piece at the place that results from the hollow of the rivet washer. As for example, in the first figure, the angle a of the rivet washer abcdefgh by meeting the key lm moves away the piece IK, IK, & c. of the cutting edge of the tool ni, and prevents consequently that this cutting edge i of the tool bites the place K of the piece IK. On the contrary when the side ah of the rivet washer abcdefgh, as in the third figure, is applied to the key ah, then the piece IK, IK approaching the cutting edge of the tool mi, the cutting edge i bites the piece at the place i of the piece IK, IK, and it is at this place that the piece hollows itself, the place K remaining raised.

However, it should be noticed that this reason takes place only when the key is on the left of the rivet washer, or by the side of the workman, as in the preceding example. Because when it is at the right-hand side of the rivet washer, or opposed to the workman, then the effect becomes the contrary, namely, that the relief of the rivet washer causes the hollow of the piece, and the hollow of the same rivet washer the relief of the same piece, as one can see in figure 6, where angle 5 of rivet washer 12345678 as it meets the key KL at the point 5 causes the hollow n of the piece abcdefgh, because as angle 5 approaches the piece by the cutting edge n of the tool in, the piece hollows itself at the place n and remains raised at the place m, and this relief does not come but because the side 45 of the same rivet washer 12345678 as coming to be applied to the face of the key KL, makes that the point m of the

piece abcdefgh moves away from the cutting edge n of the tool in, and consequently this same place m remains raised. And it is all that it was necessary to show.

For a greater satisfaction of the Turners I have wanted to represent here several different rivet washers of the most pleasant contour in the workmanship, the manner of dividing them, and all their different effects according to the various keys, and always assuming that the key is opposed to the workman or on the right-hand side of the rivet washer. And although I have already explained elsewhere the difference of the keys, it is however good to know here that the difference between the rivet washers also obliges to make use of the different keys, the flat ones l m (Fig. I.) ah (Fig. 3) and KL (Fig. 6.) the other acute like a key X (Fig. 13) and the other rounds or like casters V (Fig. 4.) The flat and rounds keys or in casters are always easiest in work; but in addition that they blunt early the corners or the sharp advances of the rivet washers, they only can be useful when the rivet washers are divided only by right faces or rounded ones by inside or outwards like part of the rivet washers of Plate XIV, or when the dents are rather large and not very deep, so that the caster can there enter inside, as in the rivet washers IKLM, it is then necessary to make use of an acute key or cut like a corner X (Plate XLIV) so that the reliefs which form these dents on the workpiece, become better formed, and more raised".

Thus this are all the different effects or the different figures and different divisions of the rivet washers marked in these two Plates. The first and the third in the Plate XIV are divided into eight sides equal and right, on a work it forms an octogonal round gadroon, the key being located on the workman side, as much the key is flat as is round. But when the key is at the opposite side from the workman, the same rivet washer will form a contour with octogonal sides almost right like in figure 6.

One of the most ordinary and the most pleasant works of the Lathe for figures, it is what one vulgarly calls the basket or the osier, and it is properly some box or notched vase so that the gadroons of a row are alternate with the gadroons of the other. Namely that the reliefs of the gadroons of the higher row are directly opposed to the hollows of the gadroons of the lower row, just as it is seen at the osiers of a basket. There are some who for this effect make use only of one rivet washer; but they are obliged to raise or to lower the support at each row of goodrons that they want to make, or to make use of a double cross-cut chisel H, namely, whose cutting edge of the one is much higher than the edge of the other. But this manner is neither so right nor so regular that the work requires it, by the need that there is that the edge of the tool either or low or higher than the edge of the other. But this manner is neither so right nor so regular that the work requires it, because of the need that the cutting edge of the tool is always quite horizontal with the center of the part, if one wants to make gadroons quite regular, such as one sees in figure 5 or T. Because for little that the edge of the tool is or lower or higher than the center of the piece, then one sees a manifest irregularity, the top or the highest point of the gadroon being closer to a hollow than to the other, as one can see in the figure S. And because it is quite difficult that by raising or lowering the tool, or even by making use of a double cross-cut chisel, one can meet precisely the horizon of the center of the piece, never I have approved these two manners. But here it is one very sure, and very just. It is necessary for this subject to adjust on the crankshaft two rivet washers of the same division, and of the same diameter; namely, both two inches in diameter, and ten or twelve or sixteen sides. It is necessary that the

divisions of a rivet washer are quite alternate with the divisions of the other rivet washer; in such a manner that each point of a rivet washer is directly opposite to the middle of each side of the other rivet washer, as one sees in the 4th figure where the two rivet washers abcdefgh, and iklmnopq, are laid out in such a way that the point a of the rivet washer abcdefgh answers directly to the middle of the side qi of the second rivet washer iklmnopq; these two rivet washers being laid out in this way, one will not be obliged to raise or lower the support, nor to make use of a double cross-cut chisel, but only of a simple one, by changing the lever or key sometimes on a rivet washer and sometimes on the other, to make gadroons alternate; and so that the gadroons are quite horizontal as in the figure M, it is also necessary to hold the cutting edge of the tool rightly horizontal on the support like in P, but if it is wanted that these same gadroons are slanted like N, the same tool will just to be hold in a some biased way like Q, namely, that one of the points or angles of the tool is a little higher than the other, then one will make a gadrooned ankle like a ribbon, over all if the tool is crossed cut.

As regards the most convenient and most common division of the rivet washers, it is to divide them into sixteen parts, such as are the majority of those that I represent in these two Plates. One can also to divide them into six, eight, twelve parts, finally in as much as one will want, and as possible in even number; but before to divide them it is necessary to round them exactly on the same crankshaft, on which they must be useful for the work, and that all those which must be used in the same crankshaft, are as much as possible of the same diameter, and that finally, the division of each one begins towards the same place, so that all the parts of a rivet washer answer exactly to the parts of the others. Thus, after having rounded for example four rivet washers of the same diameter on the same crankshaft; if one wants to divide them into sixteen or twelve, or in such number that one will want, it is necessary to establish the beginning of the division by drawing a line parallel with the crankshaft, and that crosses the four together. This line being thus traced, then each rivet washer will be divided into sixteen or twelve parts etc. At the time all the divisions will answer the ones to the others exactly. This equal division is very necessary, so that when one wants to cut various ornaments on a same work, all the angles and all the faces of an ornament answer directly the angles and all the faces of the other; as one sees in figure 10 of the Plate XLIV or in the three roses that are traced there, all the angles and all the reams answer the ones the others regularly. And because one can bring back an infinite number of rivet washers on a same crankshaft, it is necessary to mark a den there, in order to know exactly the place where one must begin divisions of the rivet washers. This den is not other thing that one small blow of punch, which is used to know the place where one must bring back the parts, when one is obliged to pull and to put on again them on the same crankshaft, or the same machine.

After having divided exactly the contour of the rivet washer into as many parts as one will have determined, it is necessary to enchase it and to ensure it with cement in the hollow of some plate, in such a manner that the surfaces of one or the other are on the same level; in order to be able to pose the point of the compass when it is necessary to trace the pushed circular divisions, like that of figure 7, and almost all the others. For this subject it is necessary to make use of a short compasses, strong and garnished with quite sharp-edged and well soaked points; so that the dashes that one will trace on the plan of the rivet washers, are righter and more sensitive. After all these exactitudes, it is still very necessary

to file well also, and well with balance all the notches, and to leave all the edges right and sharp, so that the angles of the figures which one will trace by the help of these pieces, are acuter and sharper. All these observations are necessary for the exactitude, and the greatest accuracy of the works; it is why I have judged correct to deliver the advice on it to the workmen, before to show them to trace some different profiles of rivet washers.

The Figure 7 on Plate XLIV, being divided into sixteen equal parts, the compass will be open after the length of one of these parts, and holding one of the points on a point of division, one will form an arc of circle. And thus from point to point forming on each division an equilateral triangle out of the rivet washer, from the point where all these arcs cross themselves, as a center, one will trace another arc of circle on the field of the rivet washer, so that this arc precisely passes through the two points of division, as one sees in fg, that are not marked on the same rivet washer, which will form on the work by the means of the lever X emplaced at the opposite of the workman, the waves a at the Figure 9 of this third rank.

The rivet washer of the Figure eighth being also divided into sixteen parts, one will divide them all into six, which four at the middle will be for the large notches rrr, and the two others for the smallest abcd, etc... To trace the large notches rrr, one will open the compass with the distance of these four parts, one will pose one of the points of the compass on the exterior angle as the center, and with the other point one will form the arc of circle r. All the sixteen arcs r having been traced, one will trace on the face of the rivet washer and its center S an inner circle abcd, etc... concerning precisely all these arcs rrr. One will form then the small notches abcd, etc... until the aforementioned circles by cutting them or straights or curves. This rivet washer will form on the work, by the means of the lever X placed at the opposite of the Workman, the undulations of the part b of figure 9.

The rivet washer of the figure 11, form the part 4 of the figure 12, shadowed by the perpendicular cut and the rivet washer of the figure 13 forms the part 3 of the figure 12, which is horizontally shadowed; key X being posed at the opposite side of the workman. Here it is the manner of tracing the first rivet washer. After having divided it into sixteen equal parts, one will divide each one of these parts into five other equal parts. In this rivet washer there are eight large notches and eight small. Of the eight large notches there are four of them abcd formed each one by only one arc of circle which center is out of the plan of the rivet washer; and the four others 5,6,7,8 formed each one by two arcs of circle, whose center are in the same field of the rivet washer like 0. To form the notches abcd, it is necessary to take four of the five last parts into which each sixteenth part was divided, and this from a towards i, and from the same a towards k. Then taking all the eight parts ik, it is necessary to form with the compass the equilateral triangle ikl, and from the center l one will form the arc of the circle i2k, and in the same way with the other notches 1,2,3 and 4. These four arcs being traced; from the center S of the rivet washer one will describe the inner circle 1,5,2, etc in such a manner that the aforementioned inner circle touches the aforementioned arcs at the points 1,2,3,4. Then to trace the four other notches efgh, one will take also four of the last parts from h until m, and from the same h until n; and thus on the three other efg from the point m to the point 5, or from the point n to the point 5 one will draw a straight line, on which one will describe a equilateral triangle m50, and from the point 0 like center, one will trace the arc of circle 5m, and so with the others. For the eight

small notches nmk, etc.... it is necessary to draw a straight line from the point m to the point p, and thus consecutively, and there will be all the rivet washer divided into eight large and eight small notches.

Such is the division of the rivet washer of figure 13, and which forms part 3 of figure 12, the lever X being opposed to the workman. After having divided all its contour into sixteen equal parts, eight will be assigned in an alternative way and opposed the ones to the others, like 12345678. One will describe an equilateral triangle abq on each one, and from the center q, one will describe the arc of the circle ab for the large curved notches. After what from the center of the rivet washer S, it is necessary to describe the circle abcdefgh that touches all these arcs of circle. However to trace the average notches abcd, etc... one will divide the eight other alternate parts each one into four parts, of which two will be useful for sizing the average notches, and of the two parts which remain, each one will be useful for one of the small notches. Each average notch will be inserted just until the circle abcd, etc... But for the insertion of the small notches, one will draw a straight line from i to i, and another straight line from L to L, the intersection of these two lines ii and LL will give the insertion of the small notches.

The rivet washer A at the first figure, (Plate XLV) is divided only into five equal parts abcde, each point of division must be used as center to trace each side with the compass. Such as for example, from point a as a centers one will describe the arc of the circle cd, and in the same way with the others. The lever is opposed to the workman, it will form the rose A. The division of the following rivet washers in the same Plate is rather obvious by itself; thus I am satisfied to have limited myself to the explanation of the preceding rivet washers, and to have marked in the field of each one their particular effects, the levers being, as I said before, posed at the opposite of the Workman. It does not remain but to speak on the thickness, size and matter of these rivet washers. It is enough that they have three lines of thickness, and two inches in diameter, although it is possible to make smaller and bigger ones; but the size of two inches is enough reasonable to make the divisions quite right. As regards the matter, one usually does them of brass; but they are much better of iron, they last more, and slip better on the lever, having being well furbished once.



## SECOND CHAPTER Profiles and mouldings.

### *Plate XLVI.*

To become a skilful Turner it is not enough, of knowing thoroughly the machines and of rightly handling the tools of the turn; but it is still necessary to rightly understand the profile to give the good taste to the works. I call the profile a simple contour; and good taste, this approval with the sight which first satisfies the spirit only because of the look and aspect of the work. Truly it is quite difficult to be able to explain this good taste, and to lay down precise rules of it, since it depends rather on the idea and the genius of the people than of any unquestionable method. The eye alone must about it prescribe the rules and the laws, just as in the art of painting and the architecture, where all the rules that one could give never arrive to form works as pleasant as those which very often only the idea or only the whim imagines; as can testify several beautiful works of some great men. Our famous Pierre Puget of Marseilles, great Painter, great Sculptor, and also great Architect, by seeing a Book of Architecture which I had drawn after Palladio and the Vignole, testifies me great pleasure of seeing it, but he acknowledged me at the same time that all the rules of these Authors were scarcely in need, and that it was necessary that the same Architect form himself suitable drawings at the places and the situations where one was to build; and that this was only the harmony of the work which made the laws and the rules of a good architecture, and not the intentions nor the books. Indeed how much large and beautiful buildings does have not been in the need to be rebuilt, in absence of this beautiful harmony when they were completed, in spite of been very beautiful on the drawings and the models. It is not only for one whole body of a work where the harmony must be used as rule; but it is also for each member until its least parts, since Monsieur d'Aviler very erudite in Architecture, having give in the great Work that he composed on it *Volume I pag. 327.* proportions and rules to the balusters, he however acknowledges that the grace of their contour depends on the good taste of the drawing. It was also the feeling of great and famous Michel-Angelo, as I have heard it when in Rome by Sieur Dominique Barriere, French of nation, one of the most skilful Designers and Engravers of Rome. I have heard him to say many times to have seen a Manuscript in own hand-writing of Michel-Angelo between the hands of this odd Architecte the Cavaliere Borromini, containing several beautiful lessons of architecture, where he however concluded that the best were those properly of the genius of the Architect.

After the authority of these three Great men, one can judge difficult to lay down precise and particular rules for the works of the Turn; especially as being almost infinite, and of very different nature. But in spite of the difficulty of establishing laws on the harmony of the works of Painting and Architecture, the authors did not rid of giving some particular rules, especially on the outline of the members. I believed that one could about it also give some for the works of the Turn, in particular on the profiles and the moldings.

The Architects and the Carpenters usually call Profile what is properly only the outline of a figure drawn by a simple line according to its height and width. They call also the Moldings, the eminent or inserted parts, squared, round, straight and curves which are useful for the ornaments of the works; but the Turners call profile the figure or form of the same work, made up of various hollows and reliefs, and say: Here is a vase, a candlestick or one limbs of a beautiful profile, when they are of a pleasant and well worked composition, such as those of Sieur de Launay, very skilful Goldsmith of the King, and those of Sieur Maubois, the most excellent Turner of this century.

They even form their works only by their own ideas at the same times as they make them work, and they nevertheless surpass all that the best considered rules will be able to prescribe to them. However because the Art of turning has many relationship with the Architecture and Carpentry, it is good that the Turner forms and traces firstly on the paper the drawings of his profiles and mouldings, according to the rules of those of Architecture; namely, with the compass and the rule, for a greater assurance and accuracy. Because as says very well the same Sieur d'Aviler at the beginning of his Treaty of Architecture. " The outline of each moulding is established on the Geometry, and just as there are only three kinds of lines in the Geometry, which are the line, the curve and the mixed one; also there are three species of mouldings; that is to say, squared mouldings, rounds, and those which are made up of these two kinds of lines. That one could never well trace without the help of the compass and the rule, since they are only or half rounds, or quarter of rounds, or two arcs combined together as in the heels and ogee mouldings.

Of all the mouldings according to the same Sieur d'Aviler, the ones are large like the Ogee mouldings, the Ovums, the Coves, the Heels, the Toruses and the Scotias. The others are little, like the Filets, Beads and hollow mouldings. These small mouldings are used to crown and separate the large ones, and to give them also more relief, and distinction. However as all these mouldings are in the Art of turning what the letters are in the writing; namely, that by the combination of the characters it is made an infinity of words, also by the mixture of the mouldings, one can invent a quantity of different profiles, which however will be able to receive their pleasantness only by well proportioned combinations; namely, that the largest members do not surplus too the small ones, nor that the eminences are too large and too advanced, and the hollows too narrow and too deep. And because there are three species of these eminences; namely the rounds, the flats and the pointed ones or cutting, one must at least give to the rounds a quadrant of projection for a quarter of round or ovum, and a half-circle for a torus or stick, such as those of the base of the doric column. However to give more charm to the work, one will be able to give them a little more projection. What one will also observe related the hollows rounded, like hollow half and scotias, particularly when they are simple, namely, made up of only one quarter, or of only one half-circle. Because if some mouldings obliges to form the mentioned hollows of two arcs of circle of two different diameters, it is necessary that they are or two quadrants of a complete circle, or a half circle combined with a quadrant of circle, except for heels that are a little advanced, and the same for some heels and ogee moulding, where one can join for the first a half circle with a half quarter of a larger diameter, like in the collet of the ballot box or vase of the present of this Plate; and for the seconds, namely for the heels and ogee mouldings, one will be able to combine some time two arcs of circle of the same diameter; but described on the side of an equilateral triangle, such as one can see in the two

ogee mouldings, the one lengthened and and the other square, and in the reversed heel, of the same Plate. As for the flat, or squared projections like the bands, the listels or the reglets, one can give to those ones as much projection as width, except when they are a little too wide; in which case one will be able to give them half of their width. For the bands, it is quite difficult to determine the projection; truly only the taste and the discretion of the workman can determine it, just as the projection of the pointed or cutting mouldings. Nevertheless usually I give to these last ones as much projection as can carry a circular angle formed by two arcs of circle as described on the two sides of an equilateral triangle whose base is the very width of the cutting or pointed moulding.

I believe well that this little of instruction must be enough for well ordering the mouldings in a work. But as it would be an infinite effort to want to determine the proportion and the size of the ones regarding the others, I have limited myself, for the satisfaction of the curious, to add at the end of this present Treaty, the drawings of some pieces, whose profiles could be used as models to many others. There are some that are of my invention; but the majority are from the genius and hand of the late the Illustrious Monsieur de Servieres Gentil - man of Lyon, and of Monsieur his son, the Great Prior of Savigni, whose Cabinets which one can count among the most curious in Europe, are decorated of a quantity of other pieces from the Lathe, of an surprising invention and execution. I have added as well the elementary mouldings to make them better understand, and to explain its terms, such as one will be able to see in the present Plate XLVI.

. SEVENTH PART.

PORTABLE LATHES,  
OF WOOD OR IRON.

FIRST CHAPTER  
*Watchmaker Lathe.*

*Plates XLVII, XLVIII & XLIX.*

One calls *Portable Lathes* or *Lathes for Watchmaker*, these kinds of Lathes that can be easily transported from a place to another, and that can be posed or attached to some bench or on some table in the manner of a vice, such as I represent them in the two next Plates, of which the first shows all the parts which compose them in detail, and the second all these parts assembled, and all the Lathe assembled on a bench in a position to work. The scale of twenty inches marked at the bottom of the first Plate, shows the dimensions of all the parts that compose this Lathe. However each one is free to make them larger or smaller.

The principal part of this Lathe is a bar of brass or iron of approximately twenty inches length; of one inch broad; and of approximately twenty inches length; of an inch broad; and of approximately nine lines thickness. Its back is cut in chamfer or bevel, so that the Poppets stay in place there firmer and more assured, the bar being pressed by the screws that hold them. Each Poppet is used for two uses; or to turn in the air or to turn between two points.

*Detail of all the Parts which compose this Lathe.*

- A Width, length and height of the poppets.
- B Thickness of the Poppets.
- C A Poppet seen in perspective.
- D Closing part for the support rings.
- EG Collet of the support ring.
- F Closing part in perspective.
- H Screw for the closing part. This screw is used to tighten the collets.
- HH Width and length of a small Poppet or key for the support.
- I Thickness and width of this same Poppet or key.
- K This same Poppet or key in perspective.
- L Profile of a squared punch at which head the support is put.
- M This same punch in perspective.
- N Face of the support whose tail enters into the opening of the head of the punch
- M.
- O Profile of this support.
- P The support in perspective.
- QRS Width, thickness and perspective of a track for the support, when one turns between two points.

- T A screw that stops the support P at the head of the punch M according to the situation that one gives to it.
- V Small squared iron arm which sticks by its screw in the thickness of the poppets, and that supports the track QRS.
- X Perspective for this same arm.
- XX The tree of the Lathe garnished with its reel.
- ab* The two points of the Lathe.
- c* The profile of the track for the registers to make the screw.
- d* Width and height of this same register.
- f* Thickness of the listels for the register.
- g* Width of this same listel.
- h* The register in perspective seen by the front.
- i* The same register seen in perspective by the side that is stuck to the Poppet by its tenon worked as a screw.
- k* This same box as seen from the opposite side.
- ll* Plan of the crankshaft, the two Poppets, and the register assembled.
- m* Profile of the Poppet and the register which is attached to it.
- n* Perspective for the stem which carries the bar of the Turn, and that one attaches to a bench or a table by a good headed screw x.
- o* The front of this same stem. One attaches in a channel oo dug in its head, the bar of the Lathe by two good screws.
- 5 Iron punch which crosses the listels of the register.
- q* Steel arc.
- r* Reel for the rope as well for the Lathe as for the arc.
- t* Round brass platen which is applied to each side of the reel, to prevent that the rope of the Lathe does not escape.
- S* The iron ring which is used to hold the arc attached over the arrow.
- 6 This arrow in perspective.
- 7 The front of this arrow.
- 8 Profile, thickness and height of the same arrow whose tenon rr must enter into the squared mortise SS of the stem o, which must be stopped by a good nut 9.
- u* The reel of the rope of the arc in perspective and garnished with its two platens.scape.

The rope of the arc must be made up of four branches or cords which cross this reel in four different places, and with the same distance between one and the other. It is necessary that these four branches or cords are well bandaged, so that the spring which they make while being disentangled by the return of the rope of the Turn, is more vigorous. Its disposition will be seen of the Lathe united and assembled in the following Plate, where I have represented all the parts which compose them assembled, and all in a state of working in the first Figure A. It is in this situation that the crankshaft, the register, and the support disposition for the same crankshaft are viewed. One sees in the second Figure the disposition of the Poppets for when one wants to turn between the two points. Finally in the third Figure one sees the support intended to Turn between the two points, posed on its two

tracks, which one can advance or move back on their arms, and to stop them there by screws, just as the support or the rule.

*Drawing of another portable Lathe.*  
Plate XLIX.

The construction and the spirit of this Turn are almost the same ones than those of the precedent, with the reservation that this one is entirely composed of wood, that it attaches itself by two split arms, on a table, and that its two Poppets are crossed by two iron punches, on which they can turn from right to left, or from left to right, according to whether one requires, or the points or the support ring. I did not assign there any measurement, nor put registers to make the screws. One can add there one of the same construction of them like the one of the preceding Lathe. And each one can make the Lathe as large and as small as he will consider it suitable.

*Detail of the Parts of this Lathe.*

- A Plan of the two leads of the Lathe attached on its two arms.
- B Profile of the two leads and of the arms.
- C Length and width of the Poppets.
- D Thickness of the Poppets.
- E One of the leads viewed in perspective, where one sees the groove in which must run the flat and the squared head of the punch L. One sees there also the mortises for the tenons of the arms.
- F A Poppet in perspective.
- G All the bench of the Lathe assembled on its two arms, in perspective.
- H One of the arms seen in perspective.
- I Iron punch to attach the two arms on a table.
  
- L Another iron punch, whose flat and squared head must slip into the grooves of the two leads, so that the two Poppets can be close or distant the one from the other, and to be stopped by tightening the nut K of the same punch L.
- M Point of the Poppets of the Lathe.
- N Plant or base support.
- O Squared off iron understrip, which one must attach to the corners of the Poppets to make there the place of the points.
- P Squared arm, along which must slip the track which carries the support. This arm properly sticks itself by its screw in the Poppet.
- Q The support for the support ring.
- R All the Lathe mounted and assembled in perspective seen from the side.
- S The same mounted and assembled Lathe in a frontal view in perspective.
- T Track which must hold the support of the points.
- V A flat capscrew to tighten the track T against the arm P.

THIRD CHAPTER  
*Watchmaker Lathe.*

*Plate LI, LII & LIII.*

The composition and provision of this Lathe are the invention and mastery of Monsieur l'Abbé Forcet. It is composed of two iron leads united together on the tenons of two stems, which one attaches on a bench or a table in the manner of the stem of a vice. Its use is only for the delicate parts, such as are the trimmings of sand glasses, the wheels of clocks of pocket, and other parts of this nature. To better give it to understand I also drew it in two Plates, whose first shows the detail of all the parts which compose it, and the second all the assembled parts, and all the Lathe in a position to work.

*Detail of all the parts in Plate LI.*

- A Profile of the two leads attached to the tenon of a stem, together the profile of this stem.
- B Length and width of the leads and the thickness of the two sticks.
- C A stem in perspective.
- D One of the Poppets of the Lathe in perspective, & garnished of a squared point that is stopped by means of a screw.
- E Key for the nut *a* of the gudgeon *b* of the same Poppet.
- F Another Poppet with a point like a screw that is stopped behind the Poppet with a nut. This point is made like a screw in order to make it advance, & by this way to hold the piece to be turned or the crankshaft of the Lathe when they shake themselves; & in order to avoid that it moves backwards because of the work force, once it has been pressured, the nut behind the Poppet is well tightened.
- G The two leads attached on the two sticks in perspective.
- H Squared chisel for the support L whose tail must enter into the head of this chisel, where it is stopped by a screw *c* with a square head.
- I The two collars for the support ring of the Poppet R.
- K The Lathe's crankshaft garnished with its reel.
- L Iron's support.
- M Profile of this same support.
- NN Two iron's jaws cracked to hold a ruler also in iron, that is properly the support when one turns between the two points.
- O Face of a support ring Poppet.
- P Profile of this same support ring Poppet.
- Q The same support ring in perspective without closing parts.
- R The same support ring Poppet garnished with its support ring and its closing part.
- S Closing part in perspective.
- T Hook to stop the little squared chisel V, that is useful to retain the closing part at its place.

XX It is a prisme inside a track against which it rests the end of the crankshaft. This prisme is bored all along by diverse nuts of different threads like the screws at the tail of the crankshaft.

*Detail of the Parts of the Plate III*

At this Plate, all the parts in the precedent Plate are viewed as assembled and, they are mounted in a position to work. The first figure makes see this Lathe garnished with its support ring Poppet, with its crankshaft and the support proper to face turning. The third figure shows this same Lathe garnished with its Poppet proper to turn between two points, with the supports required for this subject. At last, the figures 2 & 4 represent two other little Clockmakers' Lathes, one to Turn between two points, & the other for the support ring.

As the goodness of a clock very often depends on the rightness of its wheels, they must be necessarily rounded and adjusted on a Lathe together with its axles. With this purpose broken and cracked supports are used; so that the width of the wheels does not prevent from approaching them the points of the Lathe. Because as far as the support is close to these points, as much the chisel or the tool is firm, & consequently it cuts better the metals, & make them more net & more accurate. Thus, I have represented in this Plate LIII two other Clockmaker's Lathes of a different construction than those of the two preceding ones, with two of these supports broken or cracked intended for the free play of a wheel.



EIGHTH PART.  
ON THE WORKS MADE BY PUSHING.

FIRST CHAPTER

*Machine for making England's knives handles, or intended to cut diamond points on the knife handles.*

*Plates LIV & LV.*

This machine is one of the most clever of all those which ever have been invented in the arts. It is usually called the machine with the handles of knife of England, or because one brings to us from this country knives provided with handles hallmarked in diamond points by the means of this machine; or because, so I think, it was invented by some up-and-coming Englishman, whom I would like to know the name, to publish his merit. It has been communicated to me in Paris by Monsieur l'Abbé Forcet, whom I could not too much thank for his big industry and delicacy in all kinds of works, either in iron, or in brass or ebony. I have designed it on the same base, namely with the same dimensions than the one that he himself have manufactured, by reducing it to the small foot that one will see at the bottom of the Plate. And in order to better make it understand, I have designed it in two Plates, as well in detail of all the parts, as by composing them all whole by various plans, and various sights. I believe that in this way one will understand best the structure that by all the speeches and descriptions that I could make on it.

The principal parts which compose this machine, are firstly four united rules from two to two by cross bars. The second is a small crankshaft with winch to attach there the part to be worked. The third is a small plane running in a groove by the means of a long screw; and the fourth is this screw even. The whole must be assembled on a wood platform cut of manner that one can attach it to a vise when one wants to make use of the machine.

*Detail of the parts represented in Plate LIV.*

The first figure represents the profile of all the whole machine, namely, of all the parts which compose it assembled.

The second figure represents the total face of the same machine gathered, and assembled on its platform.

The third figure represents the plan of the platform, on which one sees also the plan of the two lower rules united by three cross bars; and also the plan of the crankshaft with winch, and a screw which is used to tighten the part to be worked against the narrow part of the same crankshaft.

The fourth figure represents the plan of the two higher rules united by two cross bars; one at the middle, and the other towards an end, in which the nut d of the long screw is cut. One also sees in this same figure the plan of the small plane M, that the long screw must make run in the grooves of the two higher rules, that one sees in perspective in figure 5.

These two higher rules aa have each one an end cracked in hinge, to receive there a round and flat head like a small palette with long tail 4. 2. (*Fig. 1.*). The other end of these two rules must be a little thicker than all the body, to bore there a mortise for a rule of direction half right, half curved II in the following Plate. The curved part of this rule of direction is an arc of circle described from the point 4 (*Fig. 1.*) as the center taken on the edge of the rule even directly under the center of the hinge.

These two rules aa, (*Fig. 5.*) are united only by two cross bars, one at the middle c, and the other towards the ends with the heads d. The first cross bar at the middle is bored by a long mortise e in its length, for the passage of the figured rules C, D. (*Plate LV.*) The second cross bar d is bored by a nut for the screw which must draw the plane M along the grooves notched along the length of the two rules. It is why the space interior of each one of these rules ranging between these two cross bars, is cinnamon by a groove f for the control of the tenons g of the plane running E, which in addition to these two tenons must have two advanced heels h, which must rest and slip all along the higher limb of the two rules, making the course of the plane more equal and more assured.

D Is the plan of the aforementioned naked plane.

E It is the face.

F The thickness or profile.

G The sight or the perspective. The small closet I must be applied to a groove notched in front of the face of the plane, and must be bored in bottom by a small mortise m, inside which must enter the tenon a of the figured rules CD of the Plate LV.

H It is the plane of this closet. The small hole that one sees at the middle, is used to pass a small iron pin there L (*Plate LV.*) to stop the tenon of the figured rules.

K It is this same closet in perspective.

L It is the plane garnished with this closet, which must be dug by a small channel on the face that applies to that of the plane, as in the figure K for the passage of the handle of the tool P. The handle 6 of this tool or chisel P must be tapped in order to be able to raise it and to lower it by means of the nut O. The collet of this nut O must be dug out as a pulley 5, so that being enchased in the groove of the chapiteau M, it must be stopped there so well with a small platen N, that it cannot leave it when turned to raise or to lower the chisel P. This chisel or mortise chisel must have the edge round and notched by a small notch to trace small nets in relief, at the same time as the mortise chisel or chisel forms the diamond points at the work.

The two lower rules (*Fig. 6.*) *Plate LIV.* must have the same length, the same width and thickness than the two higher; but with this difference that the ends of each one are a little thicker than all the body, in order to be able there to dig there small mortises for the tails 22 of the head of the hinge, and of the rule of direction 3. These same lower rules must be united by three PP cross bars; of which one is almost towards the middle, and the two others at each end. The interior face of each rule must have a small groove S towards one of the ends, to be used as slide with the tenon of a fourth cross bar q, at middle of which one

must bore a nut for the screw, which is used to press the knife's handle for strengthening it well in the collet T of the crankshaft with winch V.

*Explanation of the Plate LV representing the machine for the handles of knives.*

The first figure of this Plate represents another profile of all the machine assembled on its platform. It is represented there depending on the state of the two higher rules as compared with the two lower ones when at the time of operation. One sees there the profile of a handle b attached by an end to the narrow part of the crankshaft with winch. However because these kinds of handles have the shape of a truncated cone, namely, that they are thinner sticks by an end than by the other, so the chisel a would also not bite along the entire length of the handle if both higher rules were parallel to the lower ones. It is why they should necessarily be raised in such a way that the two grooves into which the small plane slips, where is attached the tool a, are quite parallel to the line that would shave longitudinally the surface of the handle b.

The second figure represents the machine truncated in order to show more obviously how the rule to make figures aa is attached to the small mortise of the plane t through the small pin L, and how the rays of the winch resting against this rule by the means of the counterweight S, make make a shock to the handle b which gives place to the tool, while it runs in straight line , to form in top the points of diamond, or some other figure in conformity with the rule to make rules C or D.

The third figure of this Plate represents in perspective all the machine assembled in a state for the operation. It is seen there how the long screw by the means of its crank trails the plane, and makes it to trace on the sleeve a moulding in conformity with the salient angles of the rule to make figures C.

T Hub attached at the end of the crankshaft with winch. It is bored in its circumference by several small mortises equally distant one from another, and with the same number than the rays of the winch P. Namely, that if the winch is provided with eight rays, it is necessary also that the hub is bored by eight mortises corresponding each one to each ray. The use of these mortises is for attaching there a small hook QR, at which end must hang a counterweight S, that because its gravity presses a ray a, that corresponds to it facing the rule to make figures, gives a shock to the handle, and at the same time the chisel attached to the plane traces by moving back on the sleeve a line or an undulating moulding , in conformity with the falls and rises of the rule.

When the first moulding is completed, one draws the hook from the first mortise, and one introduces it in the following one, to make one second trace or moulding; and when this second moulding is completed, one introduces the hook in the third mortise. And thus in all the others so on, until with as many mouldings are made on the handle, as there are rays in the winch, or mortises on the hub. Then to make a tailstock, namely, to trace other second mouldings, whose angles are tailstocks with the angles of the first, one starts again to put the hook in the first mortise, but in such a manner that if the tail of the hook

where the counterweight is attached was before on the right, it will be in the second operation on the left.

Also the rule to make figures must be changed, namely, that if the points of the angles a faced in the first operation on the right, in the second they must face on the left, and so by following all the mortises in the opposite direction, one will trace on the handle the impressions or mouldings in tailstock with the first , which by way of consequence will form a handle finely wrought with diamond points, or like a net, like the one that can be seen on the handle RR.

*Detail of the other parts of the same Plate.*

- F Profile of the crankshaft with winch.
- G The crankshaft with the naked winch.
- H Small track that sticks at the end of one of the lower rules, as one sees it in f at the first figure, by the means of a small screw d. The head of this track is bored by a small squared opening, to place inside it a small pin also squared M. But the use of this pin M and of the track H is to preserve the situation of the two higher rules with the same angle, compared to the two lower rules. For this effect when the angle that they must form between them is established, the track f is raised or lowered until the end of one of the higher rules is immediately based on the end of the squared pin e, what will prevent that all times that one will want to put the higher rules in the first situation, they do not go down further low than it is convenient, and this way they will always preserve the same angle which they form with the lower.
- II Is a small rule, half right and half-curve in its length. I have already explained in the preceding Plate by which center, and with which diameter one must describe its arc of circle. Its use is to balance the two higher rules, so that they divert neither on the right, nor on the left when they are raised, or when they are lowered. One sees in the third figure of this Plate how are stopped on this rule, by the means of the screw H, the two great higher rules according to the height than one wants than they have by taking into consideration the two lower rules.
- K It is a small pallet that one attaches to the tenons or pivots of the cross bars. Their tail is established in the wood platform, and is used to raise all the machine over this platform in case the part that one will want to work with was so thick that it touch at the platform. One can do without these small pallets by digging a channel all along the platform.
- b Nut which is used to tighten the rules against the cross bars.
- c A flat capscrew to tighten (H *fig. 3.*) the higher rules against the rule.
- d Small escutcheon that one applies to the heads of the hinges.

SECOND CHAPTER  
*Machine for cutting the columns in network.*

*Plate LVI.*

The construction of the preceding machine gave me the idea to compose this one, and to make it clean to trace on the columns the same ornaments as on the handles of the knives. For this subject, differently than in the preceding one in which the grooves where runs the small plane are right, it is necessary that in this one they are dug curved in accordance with the bulge of the columns which one wants to carve. It is necessary also that the tenons of the plane are curved after the same top rail of the grooves, so that as the plane is to be drawn by the screw, they can run easily in the grooves of the two higher rules. The winch is also a little different from the first one. Because in this one, I have put at it only three rays, of which the one at the middle is used as guide to make the traces of the mouldings on the column, and the two at the side carry the counterweight alternatively, by changing it from the one to the other when one wants to make the tailstock center: This same winch a must turn around a bolt b, whose edge is divided into several parts equal and even, and each one marked with a figure, by beginning with one, like 1,2,3,4, etc. Thus to trace the first undulated moulding on the column, one will put the ray at the middle directly opposite the first mark of the bolt. Once traced the first undulated, one will put the same ray at the middle opposite the second mark, and thus so on with the other marks; once all being traversed, one will put again the same ray of the middle on the same marks by moving back from the last one until the first one. By this means one will make second mouldings by quilting them with the first one. Foot-note, that the winch should be well tightened with the nut of the end of the crankshaft all the times that one will make that it changes its place.

*Detail of the parts of this Plate LVI.*

- A Profile of all the assembled machine.
- B One of the higher rules carved by a curved groove.
- C Plan of the rule to make figures that is used to trace the network or points of diamonds on the column K.
- D The crankshaft with winch.
- E The winch garnished with three rays.
- F The end of the screw that must pull the plane out, to run it inside the groove of the higher leads.
- G Nut that stop this end of screw F at the handle G.
- H The plane garnished with the handle G.
- I This same plane not provided with its handle, to show how the end of the rule to make figures must be stopped at the plane with the small flat pin O & a.
- K A column carved as a network or like points of diamond assembled on the crankshaft.
- M Small iron pipe, notched in one of its ends, so that being pressed by the nut f, the points of the teeth enter into the base of the column, and hold it by this way so well

stopped, that it cannot turn around the stick of the crankshaft while the chisel violently carves it, and it is on what one must take caution, so that the traces are also enough distant.

N The naked plane.

*aa* Tenons of the plane.

L The very assembled machine, & in a position to work, as viewed in perspective. I did not mark a scale at the bottom of the Plate, because the size of the columns that one will want to carve, will regulate the one of the machine.

### THIRD CHAPTER

Method for tracing and cutting a simple, undulated and gadrooned, column.

#### *Plate LVII.*

The authors who carefully sought the origin of the ornaments and of the principal parts of the architecture, notice that the pure occasions and the hazards very often provided the inventions and the ideas of them. The one of the Corinthien capital is a proof enough convincing, since Callimachus, this great architect having seen by hazard a basket surrounded by sheets of acanthus, has formed the thought of this capital, the most beautiful ornament of Architecture. I think also that hazard or occasions, have given the subject to the inventions of the twisted columns, and that their origin can have come from these large trousseaus of foliages of which one surrounds by winding the pillars or columns for the decorations of the Temples in the solemn festivals, or for the triumphal arches which one draws up at the entries of the Princes. One could even say that the slades of vineyards, of hop, or of any other plant of those that the Botanists call *Periploques* twisted around the trunks of the trees, have given the opportunity to form the idea of these twisted columns; finally in any way that they were imagined, it is certain that they decorate an Architecture very well, and that their aspect is very pleasant, especially when they are well understood, like those of the large Altar of the Church of S. Peter in Rome, and also the one that one sees in the same Church enclosed in a pillar, and which it is said being the remainder of those of the Temple of Solomon. One can see in various places an infinity of these twisted columns, and everywhere one notices that they very much enrich the works that accompany, not only those of Architecture, but even those from the Turn, since there are very few Turners who do not prick themselves to understand them well, and that they decorate their more beautiful works with some parts like a twisted column, as I have seen in several Cabinets. But because I never noticed there that a simple and united manner, and at most accompanied by some nets or mouldings, I have sought the means of adding some characteristics to make them more curious and more pleasant, by intermingling there curving cords, or making the mouldings undulated, and it is what I show in the present Plate; but it is necessary first that I report that its scarce extension did not enable me to draw the whole Poppets, and that I was obliged to cut off there the tails as well in the profiles as in the representations in perspective.

This is the detail of all the parts that are marked there; namely of two Poppets of the twisting crankshaft, and the manner of tracing the various screws above it. The Figures 1 and 3 show the naked face of these two Poppets; it is needed that they are rather equal anyway, on its size there is no rule. However I have put a scale of twelve inches at the bottom of the Plate, to show the dimensions of the total machine that I have used myself for the execution of the twisting.

The first Figure represents the face of one of these two Poppets garnished with a support ring made up of two rules a b a little thick, and united together almost as the two branches of a proportional compass. One of these two rules a must be nailed and static against the Poppet. But the other b should have only one nail at the bottom or, an ankle; and in such a way that it can be driven like on a center. One attaches about the middle of the first rule a a

small cross bar c as long as the two rules together are broad, so that the part c, that advances, holds the rule b. At the top and beside this same rule b one will plant a pin or a hook f to attach to it a small cord for the counterweight e which must be suspended at the rule b opposite side, in order to hold it against the rule a, when the rivet washer of the twisting crankshaft makes it put aside. And so that the cord of this counterweight has its easier play, one will make it pass on a small pulley d attached to the corner of the Poppet opposed to the pin f.

D It is a squared opening for the place of the lever or recoil. Which must be a piece of wood almost as thick as large, and enough strong so that it does not fold or makes spring by the violence of the friction of the rivet washer. Its length must be sufficient for the twisting which one claims to make. The front part of this workpiece, or the place where the rivet washer must make its friction, must be garnished with a brass platen, so that it has more resistance, and one will place so well this piece of encounter that the rivet washer can touch or rub it in all along its length; what one will be able to do by the means of some wedge that will advance it or move back it until it is well situated.

The figure 2 represents the profile of the two Poppets FF united by the key E, and garnished each one with its support ring GG. These two support rings must be of the same size and height, attached in the same way each one on its Poppet, garnished with a small cross bar and a counterweight of equal gravity. However the opening of the support ring of the posterior Poppet must be round X, and of the same diameter than the twisting crankshaft O or M. But the opening of the support ring of the Poppet of the front must be square or in rhombus g h, (Fig. 6.), for the sake of the part M to be cut as a twisting. It is necessary also that one of the parts or rules SV (Fig. 10.) that compose the support ring of the posterior Poppet, is bored out like a nut aa, at its side, directly in the middle of its notch, to place there the ankle or screw T, whose end, that is cut like a cone, must be used as a guide to the crankshaft of the twisting. The point of this ankle or screw must be cut like a cone as thick as the channel of the screw of the crankshaft is wide, so that it fills it exactly, either in the simple twisting, or in the undulated twisting.

Figure 4 represents all the machine seen in perspective from the side of the key N. One sees there how the rivet washer L attached to the crankshaft to twisting O as it rubs the key N, can make draw aside the rule K that makes part of the support ring IK, and how it can still at the same time make draw aside the rule ik, that forms also part of the support ring ik. One also sees there how both counterweight ee attract these two same rules, so that they press the rivet washer L against the key N. This moving back and advancement of the rivet washer L against the key N by making advance or move back the part M from right to left and from left to right, also makes that the tool 4 by remaining firm and immovable on its support 2,2 forms on the column the undulated mouldings at the same time in spiral than twisting. Notice that this tool 4 (fig. 6) must be located in such a way that its edge 3 makes almost a tangent with the part to be cut 6; because if it is located on the same horizon than that of the part, instead of cutting it, it will do nothing but to scrape, with the result that the mouldings and the waves will never become quite clear.



Figure 5 represents the same machine as seen in perspective from the side of the part to be worked with, M. One sees there more obviously how the rivet washer L comes to rub against the key N, and it causes the same effect that I have just explained above.

Figure 9 represents the part a of the support ring ab. (Fig. 1.) It shows it garnished with its cross bar R marked C in the first figure.

g Figure 6, is one of the parts of the support ring of the former Poppet. It shows how its notch must be as a dovetail, to form with its leads an opening as a rhombus, so that this same opening can always also embrace the part N, as well in its smaller, as in its larger diameter.

The construction of this machine, and the provision of these two support rings is able, not only to cut a twisting equally thick, but also columns reinflected at the middle, or which are thick by an end and thin by the other; such as is the part L. For this effect, it is necessary that the crankshaft m n is half as a cylindre m, and the other half n as a truncated cone, if the part must be like a cone, as the part L which one will bore in all its length in accordance with the part n with one of these long percolators own to bore the Oboes. At last it is also necessary that the matter of this same part L is similarly thick everywhere if one wants to form an up to date and entirely emptied column. Previously to pack the part N in the pipe of the part L, care must be taken to place, and even to stop fixedly well the rivet washer Z between the cylinder and the cone, and also to stick the two ends of the pipe of the part L at the two ends of the part n, so that the tool while cutting does not force it to change its emplacement, what would entirely spoil the work. One can stop it in several ways; but whatever it could be, it is extremely necessary that it is in a firm and immovable way.

It now remains to show the method to trace a spiral line on the cylinder m. One can make use of several different ones, but here it is the shortest and most assured. It is necessary to cut a paper P, as long as the whole cylinder, and so broad as it can wrap exactly this same cylinder. One will divide then the two edges of the paper into an equal number of equal parts, by starting at one end until the other one. One will give as much distance to all these parts as one will want that the screw thread is large. These distances being marked, one will put a rule on the first point a on a side, and on the second point b of the opposed side, and one will trace a line ab. One will trace then another from the point c to the point d, and thus all the remainder.

All these lines being traced, one will properly stick the paper on the cylinder, and so exactly that each opposite point meets one with the other. As by example that the point a meets the point e, the point c the point b, and the point f the point d, and thus consecutively; by this means one will obtain a very just line espirale. Once the paper is dried, one will follow this spiral line by making a trace with a saw, deep of approximately two lines. This first trace being made, one will widen it with one of these three-square files in order to make a similarly deep, and enough wide furrow to receive the point of the screw or ankle T, (Fig. 10) that for this subject must be made like a cone, and must be able to fill the width and the depth of the furrow made with the three-square file, since this same point must make the function of guide or nut to advance and move back the cylinder.

One can trace this spiral line from right to left or from left to right, and even both of them together on the same cylinder, as in Q, if one wants to trace on a same part a network like a peak of diamants, which will form an extremely pleasant work. One can also make that the spiral twists itself, like in R. (Fig. 8.) One will divide for this subject all the width of the paper R into four equal parts, which will divide consequently each oblique and transversal line into four equal parts; on each one one will trace alternatively an equilateral triangle *tux*, one inside and the other outwards, and from the center *x*, and with an interval *xt* one will describe an arc of circle *tu*, and so on on each part, which will form a line in spiral and that twists. But because one cannot deepen on wood a line of this nature with a saw nor with a file, it is necessarily in need to make use of a small chisel. For this subject one will trace all the twisting spiral by a double line *ii*, *ee*, so that the space between these two lines is useful as a guide to dig the furrow enough equally broad and in conformity with the thickness of the point of the screw or ankle T, because it must be used as a guide or as a nut for this twisting spiral, as well as for the simple spiral.

One can still by this method trace on a same cylinder, an unequal spiral, namely, which its contour and thread are always of a decreasing width from an end until the other; because having divided into several equal small portions the length of the two edges of a paper S, one will take the first two parts of each edge, then the three following ones, after four, and then five, and so on by always increasing by a part. What being made, one will trace an oblique line since the first part of the left hand until the second of the right hand, and since the second part of the left, until with the fifth of the right hand, and so on as one can see in the figure S.

The Author having given no explanation of this Plate LVIII in his first Edition, where it was only referred, as several other Plates which were in the same case, it has been estimated if to remove them from this new Edition, or if to let them remain there without being able to explain its use. However as it appears that this one gives the development of a machine suitable to groove and to make waves on the handles of knives, columns, etc such as those which one already explained in this Chapter and in the preceding: not to deprive the enthusiasts of the Turn of the lights which they could withdraw, this Plate has been inserted here following those that have just been seen which are about in the same taste.

FOURTH CHAPTER  
On the simple twisted column.

*Plate XL. Fig. 5.*

The machine which is at the bottom of this Plate represents the simple method to turn a twisted column, what is to be made in this manner. One will turn two cilindres 4 and 7 (Fig.5.) which size and length will be intentionally determined, and both finished by a head enough ample to place there all around three screws. The head of the cilindre 4 must be a little longer than that of the cilindre 7, in order to notch there the place for the cord of the Turn. One will dig inside each head a rather ample and enough deep entrance to receive there a tenon 6 which one will leave at each end of the part 5 to be turned. It is necessary to observe here that this tenon must enter just and without shaking into the entrance of the cilindre, so that when both cilindres are joined to the part to be turned, and that the screws will be tight, they will be in the same line than the aforementioned part. Each Poppet 22 and 24, must be bored from one side to the other by holes directly opposed the one to the other, and each one in the same caliber as the cilindre for which it must be used. Namely that the hole of the Poppet 22 will be of the same diameter than the one for the cilindre 4 and that the one at the Poppet 44 will be also of the same diameter than the cilindre 7. I do not teach here the manner of tracing a twisted column or spiral around a cilindre; since I already taught it at the end of the preceding Chapter. It is necessary, lastly, that the top of the Poppet 22 is also bored by another rounded hole, and that it penetrates until the hole where the cilindre 7 must enter, in order to place there inside a rounded handle t or 2 garnished at the end of a little iron tongue or brass tip u or x which will be used as control for the twisted column. There are some who make this hole squared, but it is more convenient to make it round, because the same handle t can be useful for any kind of twisted column, by placing it according to whether they are or more or less oblique. The small screws of wood 3 and 3 would be the one to stop and strengthen the handle 2, and the other one to ensure the play of the cilindre 7 so that it runs without shaking.

In addition to the rivet washers and these three machines, I have added in the same Plate XL, under the figure 2, a very expeditious tool for percolating, because it bores the wood with a facility and a marvellous promptitude. It is also of the invention of the sieur Le Grange. Those who will want to make use of it, will test its convenience. I have represented only its end, the Plate not having allowed me to represent it whole. One can make a tail there to adjust it on one crankshaft, to which it is particularly appropriate. I have represented it in profile a o, and on flat o a in order to make better understandable the form. The point or tongue I at the middle must be cutting by the two sides, about like a scratcher knife, but it must be much thicker. It is used as guide when one has started to bore, so that the hole does not warp. The two horns 2 and 3 must have their bevels opposed, namely, that the bevel of a horn must be notched on a face, and the bevel of the other on the other. Each horn must be quite advanced at the side, and a little arched on the front 4; but in an opposed manner, namely, that a horn will be arched on a front, and the other horn will be also arched on the other in the front.

NINTH PART  
Method to Turn certain singular Works.

FIRST CHAPTER  
To Turn an excentrique piece.

*Table LIX*

I call that to Turn an eccentric, or an eccentric part, is to make with the Turn a work on some part, out of the center of the part. As for example when one wants to dig several boxes in a same box, out of the centre of this same box, or several small basins on a round table around the center of this same platen, such as in figure 8. One can also Turn several small platens, tablets or round draughts, by posing the ones over the others, and supported each one by its pivot and all on various centers, as it can be seen in figures 13 and 14. I propose in this Plate two different machines suitable to turn these eccentric parts. About it I could give some others, but these ones are the most convenient.

The first of these two machines is made up only of two principal parts. Namely by a thumb wheel (Fig. I.) tapped at the middle a to be attached on the bearing of some crankshaft. It is also made up of a brass platen (Fig. 3.) cut almost in half-moon C, and opened at the middle b. This platen C is attached to the thumb wheel A by three screw shaped nails D. One must apply the part to be turned between it and the thumb wheel, and then to tighten it well with the three screw shaped nails D in order to make it firm and immovable, in the situation where it will have been established, as one sees it on figure 8.

The second machine is composed of four parts, namely of a shelf I, a thumb wheel M, and two platens of brass N,R. Its shelf I (Fig. 7.) must have a bearing d tapped to be able to be attached to the crankshaft. The slide or the track e of the thumb wheel M (Fig. 10.) must slip along this shelf, and when one raises or lowers the aforementioned thumb wheel along this shelf, it will be stopped with the two screws f, f (Fig. 12.) at the point where it will have been established. The first of the two platens N (Fig. 11.) must be of the same diameter than the thumb wheel; it is cut almost like a horseshoe, and must be held at the thumb wheel by four screw-shaped nails which are used for well tightening the second platen R, when one put it in the necessary situation.

*Detail of all the parts of this Plate.*

*Fig. 1.* A Face and size of the thumb wheel of the first machine.

*Fig. 2.* B Profile and thickness of the same thumb wheel.

*Fig. 3.* C Half moon platen.

*Fig. 3. & 4.* D Screw shaped nail to stop the platen on the thumb wheel.

*Fig. 5.* F The thumb wheel garnished with its platen as viewed by behind.

*Fig. 6.* G The same thumb wheel garnished by its platen, as seen by front.

*Fig. 8.* K The same thumb wheel seen with a part to turn attached on it.

*Fig. 7.* H Profile of the shelf of the second machine.

I Length and width of the same shelf.

*Fig. 9.* L The same shelf seen in perspective.

*Fig.10.* M The cut thumb wheel of a track e.

*Fig.11.* N Horseshoe platen.

*Fig.15.* R Second part with its tapping bearing.

*Fig.12.* All the machine assembled and garnished with all its parts. I did not give any fixed measurement of it; each one can make these machines large or small according to the need that he will have.

## SECOND CHAPTER

To make with the Lathe a very exact ball.

### *Plate LX.*

The ordinary workmen use various manners in order to Turn a quite round ball. The ones make use of a hooked compass, the others of a platen bored with the Turn according to the diameter of the ball, and they call this platen Calibre. Others Turn it in two various rounds; because having began it about on the two points, they trace at the middle of the two poles a large circle, which one could name the equator of the ball, and taking two other poles on this equator, in such a way that the two first would represent the one the nadir and the other the zenith of the ball, this same large circle is used by them as a guide to entirely round it. Those ones approach enough the good method. It is however quite difficult that all and sundry can arrive at this right exactitude of the true roundness of a ball. The way that I will show is to my feeling the best and truest, as much as the art can allow it, and I am quite assured that by observing and carrying out all the required characteristics exactly, one will make a ball very right. Here is how it is necessary to proceed.

First it is necessary to Turn a cilindre A with the same material of which you want to form a ball. The diameter of the base of this cilindre must be equal to the diameter of the ball which you claim to make, and that the height or length of this same cylinder is quite equal to the diameter of its proper base. Having established the thickness and the length of your cilindre, you must trace over its length precisely at the middle between the two bases, a line b the most subtle and most delicate that you will be able; if your cilindre is quite right you will trace a true circle. After this, you must dig a wedge or wooden mark C (fig. 2.) in such a manner that you can make enter there a part of your cylinder B, not through its base, but by its length; so that there is a little more than a half out of the wedge, once you have had applied it inside. It is here where it is necessary well to take guard with two characteristics. The first is that the portions of the bases of the cylinder which enter into the wedge, are exactly equal; and, in the second place, that the circles of these same bases touch each one by two points exactly aa the edge of the opening of the wedge. These two observations are extremely necessary for the exactitude of the work; and because in the operation the cylinder could get out of its place, it will be very good to attach it in its wedge with a little glue.

Once the cylinder is well established and ensured in the manner that I have just said, one will remove by Turning with the Point of a tool the superfluous matter from the part which remains outwards until we have arrived at the circle b, as one can see in figure 3. It is necessary to take guard that the center remains quite whole, especially by polishing with the edge of the point of the tool the rays that one could have made with the point. Having completed this part, you will detach the total from the first wedge, and you will apply the part turned in another box or wedge F, (Fig. 4) in such a way that the opening that you will make to this second, receives exactly the part of the cylinder already turned, and that the four faces of the corners a (Fig. 3.) are applied with a good fit to the face of the edge of the wedge; Then you will remove with the point of the same tool what remains of superfluous until that you caught the remainder of the circle; and you will have a quite accurate and exactly rounded true ball e.

The ball being thus completed, inside one can turn there diverse curious gallantries, as boxes, vases and snuffboxes, as one will see in the Turn that I will give after that. However I have wanted to show in this Plate LX the manner of cutting inside a ball a bludgeon K, (Fig. 7) with twelve equal and regular points. Firstly take exactly the diameter dd (Fig. 5.) of the ball H with a hooked compass, or other. Having taken the diameter of the ball, describe a circle dd of the same diameter than the ball, and divide its diameter into seven equal parts. Draw then a cord dc in this circle which cuts the diameter dd into right angles on the second part or division of this same diameter. Take with a compass the interval dc., and by putting a point of the compass on one of the poles d of the ball I, (Fig. 6.) describe the circle ee. You will make the same one on the opposed pole, and will describe the circle fg. Then you must divide each circle ee, fg in five equal parts; in such a manner that the divisions of a circle are alternatively opposite with the divisions of the other. The ten points of these divisions, and the two of the two poles will divide all the surface of the ball in twelve equal parts, all these twelve points being equally distant each one from the others. The ball being thus divided into twelve equal parts, one will apply it in a wedge or pattern cavity L, (Fig. 8) but in such a way that the point of the place where one will want to start to dig, is quite concentric with the center of the crankshaft. One will change the ball at each point of the division one at a time, and always in such a way that each point is well in the center of the crankshaft, as one can see in figure 8.

### THIRD CHAPTER Diverse gadrooned Works.

#### *Plate LXI, LXII, LXIII, LXIV, & LXV*

The following Plates are drawings of vases and ballot boxes, which I drew of after the Originals which are in the practice of Monsieur de Servieres in Lyon. I drew of them only some which appeared to me of enough good taste to be used as models to those wanting to improve in the works of the Lathe.

If you wish to make a similar box to the one represented in Plate LXI, it is firstly necessary to have formed your box on the round; then to carve it, do serve yourself of the rivet washer M, (Fig. 12.) at the Plate XLV, in the Chapter on the figures and rivet washers, and you will make this work easily. It is also necessary to have some concave tools which we call Crowns, and others with round point or moulding planes which carry some nets, so that all at the same time can make the mouldings.

If you wish that the inside of the box that you want to work, is worked like the outside, namely with figures, it is necessary to have another opposed rivet washer, namely, that inserts itself where the first raised, and that where the part was concave it is convex with this one; what is not difficult for those having in some measure the genius of the Lathe. You see the profile of the box to the bottom of the Plate, where the part that raises in the outside, is concave in the inside, so that a part of ivory worked in this way seems rather a part of goldsmith's art made with the hammer, than a work made with the Lathe.

The two globes of the Plate LXII are rather skilfully worked. One sees in the one, a star with point subtilized in the thickness, but moreover several globes one in another, which appears embarrassing to those which does not know the Lathe, but not very difficult to those which know the use of it. Thus it is necessary to have a hook, and having dug around each hole constantly, and your circles will be detached from themselves.

In the other globe, there is a gadrooned snuffbox, and the openings are like faces, what is done by the rivet washer. One detaches then this first cover with hooks, and by center changing at all times when your hook has bitten all its length, it remains to you an ivory mass, that before to detach it with your hooks, one needs to percolate, to dig and to thread. Once it has being made, you stop it on the mandrel, and having put the key against the rivet washer, you will gadrooned it while the hull or bearing rolls above the work. It is necessary to work slowly and slightly.

The Plate LXIII represents a vase with a basket. It is needed, to carry out it, to have a tool made as a cape chisel with a width like the one you want to make the cordons, or if you like it better, to make a tool that carries four cape chisels distant the one from the other the thickness that you want to make your cordons, and that is of a sole part. You will mark first four cordons gadrooned by leaving circles between two which are not worked. Then changing the key to another rivet washer, you will present the tool to the cordons which



were not worked, they will raise where the first go in, and they will go in where the first do raise.

The other figure is a globe, where by only one opening Monsieur de Servieres has made a portrait box made up of three frameworks, where the one at the middle carries two screws at the edge of its framework, and there are two portraits at each side, and the two other frames are the two lids, inside which are also other portraits and screws around; so that one can close the four portraits by the two frames that embrace the one at the middle with a screw.

The Figure LXIV is a very beautiful ivory vase. I have drawn it of the same size than it is, as well for the beauty of the work, the taste, and the manner, as to provide ideas to those which start.

The Plate LXV, represents a sceptre that it has been necessary to cut into two parts because of its too big length. This sceptre is the invention of the Author who rained himself to gather there all that one can imagine of more difficult and more delicate in the Lathe, to show the variety of different works that can be carried out by the means of this beautiful art.

TENTH PART  
On the tools and instruments necessary for the Lathe.

FIRST CHAPTER  
On the dies as much in wood as in iron.

*Plate LXVI.*

After having shown all that I have been able to discover of peculiar and rare to improve the Art of the Lathe, and for the pleasure of curious, I believed that it would matter to add to the present Treaty, the use and the ways of the most necessary tools, like dies, tarauts, saws, compass, gouges, scissors, cape chisels and drills. I speak only on the most common ones, and on those the most often in usage, since one can invent new ones each day for a variety of works. Thus one will see in the five following Plates the construction and the figure of several most ordinary tools, but which could be used as an idea for giving form to others more particular to execute the intentions than one wants to carry out. I represent in the first of these five Plates two kinds of dies, the one for wooden screws, and the other for iron screws; because it is quite difficult and, even almost impossible, to be able to do without the one and the other, in the use of the Lathe.

*Construction of the die for the wooden screws.*

This die is made up of two Planks of wood of pear tree or sorb apple tree, or of some any other wood, provided that it can suffer the cut of the tap, and that the nut comes enough strong, quite accurate, and especially quite intact and without scratches. I do not give fixed measurements of the size and thickness of these Planks, since the quality of the screws that one wants to make, requires that they be or larger or smaller: it is necessary however that they are both as much large, and double longer than broad. For the thickness, it is necessary that one of two is sufficiently thick for it to be able to at least suffer six steps or drill tap nets which must be used to make the nut or die in its thickness. One will be able to make the second Plank the half less thick than the first, provided that it can suffer some screw pitches in its thickness, for the screws which must join them together. Both must be bored by the middle from one side to the other; but before to bore them, they must be united together, like at the Figure F by two small screws of wood, so that the opening of the first answers directly well to the opening of the second. The opening of this one b must be a little larger than the opening K of the other; and to bore these proportioned openings it is necessary to have two different drills, the one as wide as is thick the tap N, that one wants to use for oneself to tap the die, and the other still as broad as this same tap would have thickness if one entirely file the edges which form the steps of its screw. For this subject, it is necessary to round a stick or cylinder R whose end is as thick as the tap drill, as I have said, would be if one had filed the edges of its screw. This end of stick will be used as gauge for the opening K of the thick Board A. The body of this same stick must be as thick as all the body of the tap drill, and it will be used as gauge for the opening b of the Board C. But so that these two openings are directly facing each other, firstly it is necessary to bore

the two Boards together with the small auger according to the gauge of the end of the stick or of the ankle R; after which one will sever the two Boards, and one will enlarge the hole of C, the one less thick, with the large auger or drill according to the thickness of the tap drill N that one wants to use for tapping the opening K of the Board A. Or to tap this Board, it is needed that the end of the tap drill is a little less thick than the body, namely, that it is made as a truncated cone, so that he can easily start to tap his opening. This opening K being tapped, one will notch on the edge of its center two small cavities, one to place there the chisel G, and the other I to make run out the chips that this chisel makes by cutting the screw on wood or stick. The shape and the situation of this chisel are the main thing of this machine, and it is to what must be taken guard, because if the chisel is not well placed, the screws will be never good. But here it is the way of placing it well, and of which figure it must be, as for its form or appearance. It is necessary to take a small squared ball in steel P, almost half a finger long, and thick from three to four lines. One forms on one of its ends a forked edge like a V by digging a channel on one of its faces, and by filing the part opposite to this face like a bevel. The opening of this edge must form an angle of sixty degrees, such as the angle of an equilateral triangle Q. The opening of this edge must form an angle of sixty degrees, such as the angle of an equilateral triangle Q. For the situation of this chisel, it is necessary that the higher edge of the small cavity, in which one wants to place it, is in respect to the entry of the opening that crosses the Board, about like the tangent with the circumference of a circle, but however in such a manner that the back of the edge of the tool is a little higher than it would be a tangent, as whom would draw a line parallel to a tangent that would come a little in the area of the circle. It should be taken guard, as well, that the back and the angle of the edge of the tool, of course, meets the first edge of the nut, like one can see in M, figure B. The chisel being also rightly placed, the two Boards F will be joined, with the two small wooden screws dd, and when one will want to cut a screw, it is necessary to turn a wooden peg R as thick as the opening b is large, but so that it can easily enter there. It is also necessary that the end of this same ankle is of the same diameter as the opening K, which will be used as control to hold the ankle quite perpendicular to the Boards when one will want to start to cut the screw on the wooden peg body, R. The wood appropriate for these kinds of screw after the pear tree, and the cormier, are the charm, the walnut tree, and the beech. The too hard wood do blunt or do chip the edge of the chisel, and the too dull wood cannot suffer the cut without shucking the edges of the screws.

#### Detail of all the Pieces of this Board

- A Long and large of the most thick Plate.
- B Profile or thickness of the same Plate.
- C Long and large of the less thick Plate.
- D Profile and thickness of the same Plate.
- E The more thick Plate in perspective.
- F The two Plates joined together.
- G The chisel put in its place.
- H Opening tapped of the thick Plate.
- I Light to make run out the chips of the woodf the chisel edge in respect to en piece that is been tapped.
- K Size of the opening of the thick Plate, by considering the opening b of the less thick Plate

C.M Situation of the edge and of the angle odu taillant et de le angle du taillant du ciseau compared to the steps of the nut.

N Iron tap to cut the nuts in a wooden piece.

O This same tap with a sleeve. It is necessary to groove these taps at three or four places in order to give them the mean to cut the wood.

P Little chisel with forked edge.

Q Equilateral triangle to show the angle that must be or make the inflection of the edge.

R Wooden peg disposed to be tapped, or that must be useful as a caliber to the openings of the two Plantes.

S Steel tap to thread the iron pieces.

T Screw plate with two arms **rised** and furnished with two steel threads also tapped.

V Autre filière emmanchée et garnie de trois jumelles de acier aussi taraudées.

X Deux paires de jumelles de acier taraudées.

f Écrou pour serrer les vis des deux branches de la filière T.

g Vis de fer qui sert à serrer les jumelles dans la filière.

h La filière emmanchée V en perspective, pour montrer comme elle doit être canelée en dedans pour y placer les jumelles, et comment elle est un peu échanquée pour faire entrer les jumelles dans la canelure.

i Représente un des bras tronqué de la filière T, et comment le coude de ce bras doit être aussi canelé pour la place des jumelles.

SECOND CHAPTER  
On saws and compasses.

Plate LXVII

*Detail of all the pieces in this Plate.*

A Iron double saw in iron.

B Post of this saw that has its end made like a screw b, in order to be able to, with the aid of the nut a to bandage or slacken the saws.

C Saw with hook.

D Little squared iron stick, with one of its ends chopped for attaching there the saw, and the other cut as a screw in order to bandage there the saw with the help of the nut e. This stick D must slip on the handle of the saw and the knob 0; and this same knob 0 must be stacked at the end of the same handle. e autre pièce arrondie au Tour.

E Another double saw assembled on wood.

F Double outside compass, whose two branches at the right are used to take the diameter of the inside of a box, or of some pipe, and the two hooks the thickness of a round stick or cylindre, and of some other piece being rounded with the Turn.

G Another compass with outwards bent points. This compass is appropriate also to take the size of the diameter of some opening.

H Trimming or **assust** of a crankshaft.

I Hooked ordinary compass.

L Another hooked compass or outside compass with hooked branches, and with right branches.

K Another double hooked compass.

M, N Two kinds of Hachets to blank or trim the wood.

THIRD CHAPTER  
On the tools that normally are useful at the Lathe.

Plate LXVIII

*Detail of the Tools in the Plate LXVIII.*

At the next three Plates are represented the Lathe more ordinary tools. This is the explanation on those that are seen at the Plate LXVIII.

- A Chisel.
- B Curved chisel.
- C Gouge
- D Round cold chisel
- E Flat cape chisel.
- F Round-point chisel.
- G Round-point chisel with three streaks or bits.
- H Bevel on the right.
- I Bevel on the left.
- K Lengthened bevel, or to dig.
- L Round bevel or, quarter of round bevel.
- M Flat hook.
- N Round hook.
- O Pointed hook.

*Detail of the Tools in the Plate LXIX.*

- A Molding plane.
- B Quartered timber on the right.
- C Quartered timber on the left.
- D Half-quartered timber on the right.
- E Half-quartered timber on the left.
- F Little flat cape chisel.
- G Little round cape chisel.
- H Double flat hook.
- I Double round hook.
- K Double acute or pointed hook.
- L, M Other round hooks.
- N, O Hooked molding plane, on the right and on the left.

*Detail of the Tools in the Plate LXX.*

A Long drill with gutter.  
B Great crescent to dig.  
C Little crescent to dig.  
D Drill or snake tongue.

E Long rounded bevel.  
F Long right bevel.  
G Another long and right bevel.  
H Comb for the nuts or for the interior screws.  
I Comb for the external screws.

K Little round hook.  
L Another little acute hook.

*Plate LXX.*

This Plate LXXI is between those about which it has been spoken already on page 169, that were found with no explanation, it has been inserted here, following the others, so that nothing is cut off from what was in the old edition.

## ELEVENTH PART

That contains diverse new inventions and researches, on the Lathe, extracted from the  
Memories of the Royal Academy of Sciences.

### FIRST CHAPTER

The Machine for making all kind of Polygons on the Lathe. By M. De la Hire, Read in the  
Assembly on August 30, 1719.

#### *Plate LXXII.*

First it has been Turned in round, then in oval, and only in this late terms, it has been found  
the way of Turning in figure.

Usually it is not understood by Turning in figure, to Turn a Portrait or another  
similar thing, though one can make it on the Lathe, but only to Turn a Polygone, that is to  
say that its sides are rectilinear, spherical, elliptic, or that they have some other curve. To  
turn these kinds of figures, they should before have been formed with the hand, then to  
adapt them to the Lathe, and by the means of a sharp copper or iron key which touches  
these figures, and of a spring which counter-weights the crankshaft on which they are  
threaded, to trace with the tool a parallel to these figures. Here is the way in which to turn  
in figure. However it is constant that the acuter the angles of these kinds of figures are,  
more there is difficulty to form them, in that the edge of the key and the angle of the  
Polygon which is used as mould, so to speak, to the part that it one works, do pass so  
quickly one against other while Turning, that a small jump is made in this place, with the  
result that instead of a perfect angle that the tool was to trace on the work, it described there  
only one angle whose end is always round.

Until now it appeared impossible to the Workmen, and even to the Curious about  
the Turn to be able to turn a triangle and a square; though several have already  
unnecessarily tried to come to end, they have not go beyond the Pentagon. If one  
understands by the word Turn, to work a part on the Lathe, by giving to this part a circular  
motion; in first instance I acknowledge that the machine that I propose will not be used to  
Turn the square nor the triangle; but if one limits itself to understand by the word Turn, to  
make a work on the Lathe, by making use of the ordinary tools to Turn, by consequence it  
is certain that it could be used to turn the square, the triangle, and any other Polygon that it  
is.

Indeed, it appears to me that it is few essential that the Work turns or that it does not  
turn, provided that by this machine one can arrive at the same goal where it would be  
arrived if the Work turned indeed on itself.

One should not believe for that, that the Work does not turn at all, it is only that it  
does not turn with a continuous motion on itself: because it is obvious that if it did not turn  
at all, one could not turn any Polygon with this machine. The Work thus turns, it is to be  
said, that it turns only when it likes to the Workman to make it turn to work all the sides;



out from this time the Work is fixed on the machine, thus the Workman is Master to work the side that he wants of a Polygon, that is to say that he wants only to outline it or to entirely finish it.

The machine is made up of three principal parts; namely, of a slide, of an iron rule that moves itself freely in the slide, and finally of a dial which is used to determine the number of sides of the Polygon that one wants to make.

The slide is made of two rules of iron posed vertically at equal distance it one of the other, having in inside, each one, following their length, a groove in their thickness.

Between these two rules, there is another one much longer than the preceding ones; the two sides of this rule are finished like beveled edges above and below, which forms along its edges a double bevel of each side: These bevels enter in the grooves of two small rules, so that the great rule is embraced by the two little one, in such a way that it can go and come freely from top to bottom and upwards between the two small rules.

The Carpenters unite almost in this manner the Walls of a partition when tongue and groove assembling them.

As the great rule is the only one of all the parts which compose this machine, which is moving and which carries the Work, I will name it the working part; the two other rules which form the slide being fixed on a Poppet by means of several screws.

In the middle of the working part is placed fixed a copper turntable which is used as dial. From the middle of the turntable an iron bearing is encased in a round hole which is in the lower part of a copper part on which the Work is masticated; by this means this part can turn on the bearing as on a pivot.

At the base of this part, there is a rule or sector arm which is attached there, and which extends itself on the dial to fix the sector arm reading device at the wanted point of the dial; there is around the part which carries the sector arm reading device, three or four screws which stop this part on the bearing. It is why all the times that one wants to make-work the sector arm reading device on the dial, it is necessary to release the screws, and all the times that one wants to fix it, it should be tightened.

It seems from there that as the part where is attached the sector arm reading device is the same which carries the Work, we cannot make turn the alidade on the dial without making turn the Work with it, and changing at the same time its place.

Thus when one wants to make use of this machine to make a Polygon, first one needs to put the sector arm reading device on one of divisions of the dial, to tighten the screws and to make move from top to bottom the working part, to present the tool rested on the support to the piece which one wants to work, and one will form one of the sides of the Polygon; after that one will change the place of the sector arm reading device by carrying it to another point of division; one will then make change the working part and one will work

another side. If in a Lathe of dial one changes three times the sector arm reading device, a triangle will be formed : if it is changed four times, it will be a square, and thus other Polygons.

To make move the working part, it should be known that this part has at each end a hole in which one passes a cord; the cord which comes from the higher end of the working part is attached to the pole or to a spring placed above the Lathe; that which comes from the hole of the lower end is bound to the pedal; so that by putting the foot on the pedal, in the ordinary manner of the Turners, one will make move the working part from top to bottom and upwards.

By the help of this machine, it is obvious that the angles of the Polygons which one will form will never be rounded.

This machine still has an advantage which is to be able to be used to work only one or two sides of a part, and then to make a simple rule.

If it was wanted that the Work was tarred, it would be necessary to attach to the length of the working part towards the edge an iron rule tarred, to oppose to this rule a key and a spring which was used to push the working part against the key: but then it would be necessary that the Poppet which carries the machine slipped on the side into a slide, or that it is mobile on a nail towards the down.

*Detail of all the Parts which compose this Machine.*

The first Figure represents the machine in perspective assembled on the Poppet and garnished with the Work.

A It is the working part.

B The bevel of the same part.

D, D The two rules forming the slide which embraces the working part by means of the chamfrain or double bevel B that is cut along the length of its opposite edges.

e, e The screws that attach to the Poppet the rules which form the slide.

F The dial.

H The sector arm reading device.

I A triangle representing the work.

K, K The cords which are used to displace the working part between the slides.

L, L The Poppet on which all the machine is assembled.

The second Figure shows the profile of the machine assembled on its Poppet.

A It is the Work.

B The part on which the Work is attached. One sees around this part the screws which are used for fixing it around the bearing.

C The dial.

D One of the sides of the slide.

E, E The working part of which one sees the double bevel by the front.

F, F Cords to drive the working part.

G, G The Poppet.

H The support on which the tool I is posed, both in the position where they must be put when the Workman works.

The third Figure represents the working part garnished with two clamps which cross it at the top and at the bottom with their screws which are used for tightening and retaining the Work between the clamps. This working part so garnished is useful only when one wants to make a rule at the Lathe with this machine.

The fourth Figure is used to show the bottom of the part on which the Work is masticated.

A It represents this part in whose middle there is a hole B where the bearing is encased.

C, C The screws which stop this part on the bearing.

D The sector arm reading device.

E The Work, as one sees it by the bottom when it is masticated on the part which carries it.

## SECOND CHAPTER

*Researches on the Lathe by M. De La Condamine : on July 8, 1733.*

### FIRST MEMORY

*Containing the Description and the Usage of a Machine that imitates the movements of the Lathe.*

The Lathe seems to have been only imagined to give a perfect roundness to the Works for which this form could be appropriate. This machine provides a means sure and convenient for this.

But what has passed initially as a way of access to the Masterpiece of Art, has become early an ordinary and common practice. All the address and the industry of the Artists have been employed almost just to move away more and more, in the Works of the Lathe, from the circular form which had been the goal of the Inventor in the first discovery.

The Lathe has been carried for one century, and over all nowadays, to a great perfection. We have Works that one hardly conceive that the Lathe can carry out, but that one imagines even less that could be done without the help of the Lathe. Several skilful Workmen, and various particular who have applied themselves to this clever mechanics, have found in various times the secrecy to make on the Lathe new and singular things; but the majority held their practice secretes, in the sight of making their Works more admired or sought.

The Father Plumier, Minim, published in 1701 his Book the Art of Turning, in which he revealed the most secret mysteries of this Art, or at least he has given the means of carrying out what it had been seen of more singular in this respect. It is the only French Author, come to my knowledge, who deepened this matter and who went into such a great detail on the uses of the simple Lathe and of the Lathe of figures. One has just seen what M. de la Hire had given in 1719 in the Mémoires de l'Académie, which can be of use only for the particular case of the Polygons with right sides to which he limited himself.

The construction and the use of the Lathe are known enough, especially today that it has become a fashion recreation. However in favour of those with which the mechanical of the Lathe is not quite familiar, one will recall in few words what is necessary for the intelligence of this Memory.

One calls simple Lathe, the one which is only used to turn in round. The Lathe of figures is the one which is used to turn any other figure than the Circle. I do not speak about the oval Lathe, which has its particular construction, though one can turn whatsoever oval with only the help of the Lathe of figures.

The principal part that characterizes the Lathe of figures, is that one which is named the Rivet washer; it is the only one that provides the means of tracing the various figures that one can give to the works of the Lathe; without it, with all the remainder of the apparatus of the Lathe of figures, only could be described Circles.

The Rivet washer, as one knows, is a piece of flat iron of about three or four lines thickness, and approximately two or three inches of diameter. Its girth is usually framed, sometimes simple, sometimes waved or tarred. There can be of an infinity of figures different according to the taste and the imagination from the Workman.

This Rivet washer is bored in its center of a square hole, the crankshaft of the Lathe is also squared to receive it and to serve as axle. The Rivet washer thus adjusted, it turns with the crankshaft; and the edge of the Rivet washer, while turning, comes across a point of foam iron, that one calls *Touche*.<sup>1</sup> This Key is fixed and motionless, but the crankshaft which carries the Rivet washer can be displaced in parallel to itself, and consequently to approach and move away from the Key against which it is continuously pressed by a spring laid out for that.

Thus while the Rivet washer turns, it always contacts by itself with the Key, thus being forced by the force of the spring; the center of the Rivet washer thus approaches or moves away from the Key according to whether the inequalities of the contour of this Rivet washer allow it, which presents successively all its points to the Key. Consequently, the center of the piece which one performs, that is adjusted and centered like the Rivet washer, but at the other end of the crankshaft, will approach and move away from the point of the tool that one presents to it, as the Rivet washer approaches or moves away from the Key; the tool will thus bite on the part, sometimes nearer and sometimes more far from its center, and consequently will trace on the part a contour dependent on that of the Rivet washer.

One does not speak about another movement that one can get for the crankshaft of the Lathe in the direction of its axis, and that is used to practise hollows and reliefs on the work. It is question here only of the contours which one can be traced on a plane surface.

With the first blow of eye one could be tried to believe that the same Rivet washer can produce only one same figure; until now the Turners were hardly further, at least one can say that with the same Rivet washer they trace hardly two really different contours: the one that is almost similar to that of the Rivet washer, the other which is, so to speak, the equivalent of the first.

The first similar or almost similar drawing, to the contour of the Rivet washer, is the effect of the Key placed by the same side of the crankshaft than the tool, because in this situation of the crankshaft by its movement of parallelism approaches and moves away from the tool and the Key at the same time. The other drawing is the effect of the Key

---

<sup>1</sup> The Key, for a greater convenience in the execution, is usually furnished with a Caster, but not to complicate this description, it is assumed, as for the present, the simple Key, and reaching the Rivet washer only in one point, as when it is cut out in wedges, what is practised also sometimes.

placed at the opposite of the tool, in the other side of the crankshaft, because then the crankshaft moves away from the tool when it approaches the Key, and reciprocally; what must necessarily change by the concave arcs of the Rivet washer into convex arcs on the part, and the convex ones into concave. This is, with little thing near, until where the practice of the Workmen extends itself, and the P. Plumier itself, which gathered in its Book all that he collected from the most skilful Turners, and what its own experience provided him, not to say anything more.

But by considering it more closely, one will discover that the same Rivet washer can give a very great number of different contours; that it is only in one single case that the traced contour is perfectly similar to the Rivet washer, and that then it is also equal to it; at last that some extremely simple Rivet washers give in certain cases extremely odd figures, like tied and interlaced curves, amazing things between the Turners.

It would be thus useful to know the various contours which the same Rivet washer can produce, and until where can extend their variety; in a word, of knowing, a Rivet washer being given, all the advantage that one can draw from it. Yet it is not all : with a great number of different Rivet washers, and an exact knowledge of all the possible effects, one would not be more advanced, if one had to trace some figure which could not be produced by none of the Rivet washers whose capacity would be known.

It is true that as it is known that there is a case where the Rivet washer and the figure are similar and equal, one could sometimes succeed, by employing as a Rivet washer the same figure which one wants to trace; but generally the figure proposed could be not very convenient, for reasons which we will say elsewhere, and sometimes also it would be impossible to make use of it; by example, if the trace of the figure was interlaced, as in those which have nodes, which can however often be produced by the means of a Rivet washer with simple outline.

Thus it is not enough to be able to know all the possible effects of a proposed Rivet washer. In order to be never stopped, it would be necessary to have still the means of finding all the possible Rivet washers which can produce the figure that one can trace; because then between all these Rivet washers one would be in a position to choose the most suitable for the easiest of execution. I had heard on a Machine which its Inventor<sup>2</sup> has held extremely in secret, and who was useful, it was said, to both of these two usages; firstly, a Rivet washer being given, to know all the figures which it can describe; in the second place, a contour being given, to find all the Rivet washers which can be used to trace this contour. I have sought which could be the Machine that produced these two effects, here is one which I have imagined.

M. du Fay, through whom I have been invited and encouraged to make this research, also has worked to ascertain or to replace the mysterious Machine. I admit that the greatest merit of those which I have to propose is the relation that they have with M. du Fay, that

---

<sup>2</sup> M. Grammare, Présid. au Grénier à Sel de Harfleur.

M. du Fay, par qui je ai été invité et encouragé à faire cette recherche, a aussi travaillé à deviner ou à remplacer la Machina mystérieuse. Je compte que le plus grand mérite de celles que je ai à proposer est le rapport que elles ont avec M. du Fay, who since then has given up this work. It is in 1729 that I have presented to the Academy, where I did not have the honor to be Member yet, my first essay on this matter, on which I have made new reflexions since. I have waited, to speak about it in our Reports, that I could join to it the geometrical examination of the nature of the Curves of the Lathe, that was just touched then. It is the subject of a second Report, that is to be found in this same volume.

By the mechanics of the Lathe of figures that we have just explained, one conceives that the crankshaft of the Lathe has two movements: firstly, it moves circularly around its axis, what it has in common with the crankshaft of the simple Lathe; and moreover it moves horizontally in straight line to approach or to move away from the Key, according to the requirements of the protuberances and the hollows of the contour of the Rivet washer, and it is in what the simple Lathe differs from the Lathe of figures.

If the crankshaft of the Lathe of figures had movement only on its axis, and that in absence of this horizontal movement of the crankshaft that is useful to make it approach and move away from the Key, the Key makes up for it by approaching or moving away by itself to the center of the Rivet washer to follow the inequalities of its contour, it is easy to see that the effect would be absolutely the same one, since it supposes little that the crankshaft approaches the Key or, that the Key approaches the crankshaft, provided that in the case of the mobile Key, the point of the tool has the same movement that the Key, and approaches or moves away from the center of the work as the Key will approach or move away from the center of the Rivet washer, and this is precisely the effect of the Machine, of which here is the way to construct it.

A movement of a spring Pendulum concealed by the platens AAA, BBBB, (Plate LXXIII. Fig. 1.) and whose wheel is seen marked (Plate LXXIV. Fig. 2.), by itself makes all the operations, after having prepared the suitable parts above; C (fig. 1.) is the crankshaft of the winder, D is the detent, EF is a trigger which retains the wheel G. This trigger being raised, it leaves the wheel free, and consequently the wheel which turns with all the force of which the spring is able. The crankshaft of the pinion which the cylinder makes move, is prolonged from one side and the other outside the platens; the end I from one side (Fig. 1.) carries a flat piece H which represents the Rivet washer of the Lathe that is assumed here square, and on the other side (Fig. 2.) the drum IL; as the one and the other are fixed to this crankshaft, they are necessarily pulled by the revolutions of the pinion. The small piece M (Fig. 1.) which applies on the edges of the Rivet washer, is what takes here the place of the key of the Lathe, the part which rubs is cut out as a knife. This key which holds to the piece ON can be removed when one wants it, to substitute at its place another flat key that is fixed on the square K, and about which one will speak in the continuation. The part ON is attached by two screws on a second similar part united to two stiles PQ, RS, which slip freely into four tenons Z.

These parts and these montans are used to contain and prevent from tossing the key M that raises and drops alternatively according to whether the Rivet washer H, by turning on its center, presents its angles or its sides; it is clear that the angles of the Rivet washer will

raise the key M, by pushing back it in top with the part ON and the montans PQ, RS. The whole tends to go down not only by its proper weight, but even by the means of a small barrel T adapted on the platen behind the Rivet washer, and of a wire rolled on the barrel and attached to a small card 9, so that the key always reaches to the edges of the Rivet washer in all its situations. To this same part is fixed also a kind of pin or flat rod V V (Fig. 5) which crosses the movement, and goes up and goes down with the key in the two grooves L of the two platens. (Fig.2.) This rod has its other end bent and marked by the letters WXY (Fig.5). It is at this end Y that one adjusts the pencil a, b, c, d, (Fig. 2) which represents the tool and which traces the figure on the plan IL. The pencil can be placed in various points, on the right, on the left, up and down, by means of the grooves made in the middle of the arms a, b, f, c, that slips the one on the other, and that one stops fixedly where one wants with the screw e.

Fg is a hook under which is a spring r that always pushes back the hook ahead; this hook is mobile on its fulcrum F, about the three quarters of its length; its other end hidden behind the drum IL holds a tooth that crosses the platen, and stops a wheel that holds at the crankshaft of the pinion to fix it when it has made an entire revolution, without what the same outline would be repeated with each revolution of the drum, and the pencil would pass again incessantly on the same line. When one wants to make act the Machine, one must take care to release the tooth, by weighing on the end g, after having putting away the trigger E that is at the opposite platen (Fig. I.) and that retains the wheel G.

The drum IL is mobile on a round plate HK firmly attached on the turntable by two screws, the one at p, and the other in the opposite site towards f. The edge of this plate represents a part (Fig. 4) and more distinctly, is divided into equal parts, by making answer the azimuth reading device M with each turn of the drum also on various different divisions equally distant. The same though is repeated by crossing itself under the angle that one wants to form, what makes interlaced and symmetric lines which can make a pleasant effect to the sight.

The following Figures contain the development of the parts of the Machine.

ABC (Fig. 5.) is the carry-pencil with its slides and its cartridge BC where enters the rod or flat pin YXW, that by one side holds the key M which is attached to it by the screws ON, and by the other the pencil A. It carries also an end of square rod K of which the use will be explained.

KH (fig. 4.) is the circle about which it has been spoken, divided and fixed on the plate. It is on this circle that the drum IT turns, in the which thickness are several paperboards or papers on which the figure is traced. One removes these papers the one after the other with the point of a pin, each time one wants to change the drawing, or to repeat the same one on another paper. One cuts all these papers at the same time with a punch.

M is the mobile azimuth reading device on the divisions of the circle KH.

N is the cannon that turns on the axle of the mobile circle.



OP (Platen LXXIV. Fig. I.) is a full copper circle, cut at its middle by two grooves laid out at right angle, and on which there is a small mobile part QR at the point R, which is adjusted along the sides of the grooves R, K, R, Z, to draw the lines crossing themselves in right angle at the center of the paper on which one wants to trace a figure. These two lines, the one vertical, the other horizontal, are used to take the dimensions to place the pencil in the suitable dispositions; for this effect, one makes enter the casing b c, adherent to the copper circle, at the site of the similar part B C of the carry-pencil, on the part YX been disposed to receive it.

STV (*Planche LXXII Fig. 5.*) est un assemblage de trois pièces que on adapte sur le carré K de la Figure 1. (*Planche LXXIII.*). On fait entrer ce carré dans la ouverture E, dans laquelle on le arrête par le moyen de la vis D.

Si on veut voir les effets de la touche plate TS, on détache le côté SV et le arc VT, en lachant le écrou T, et on fait porter la plaque TS à plat sur les côtés de la Rosette : si on veut une touche plate inclinée, on remet en place le assemblage TV, VS, au moyen de la vis T, et des deux pointes qui entrent dans les deux trous S, on incline plus ou moins V S sur TS, à la aide de la vis T, mobile dans la rainure de le arc VT.

On voit que les mouvements de cette Machine sont absolument equivalents à ceux du Tour. Le arbre du Tour qui porte la Rosette et le ouvrage, tourne sur lui meme, ce que fait dans la Machine le essieu qui porte la plaque et le tambour. Toute la différence consiste en ce que dans le Tour le arbre a un second mouvement parallelement a lui même, qui lui permet de se approcher et de se éloigner de le outil et de la touche, le un et le autre fixes, au lieu que dans la Machine, ce est la tringle, portant à ses deux bouts la touche et le crayon, qui se meut parallelement à elle même et le essieu qui represente le arbre, et qui porte la plaque et le tambour. Il a été plus simple et plus commode, dans une Machine de Horlogerie, de laisser le pivot qui porte les roues, et de transporter dans la tringle le mouvement de parallelisme, du reste il est clair que cela revient au même.

Il faut encore observer que le mouvement de parallelisme se fait de ordinaire horizontalement sur le Tour, au lieu que il a paru plus commode de le executer verticalement dans la Machine, ce qui ne change rien à le effet.

On a fait faire (*Planche LXXIII. Fig. 5.*) un coude en X à la tringle mobile pour faire approcher plus près du centre le bout M qui porte sur la Rosette, sans être obligé de rendre les Rosettes plus grandes. Ce coude ne empêche pas que la tringle ne se mauve parallelement, et il ne apporte aucun changement essentiel à la construction de la Machine, il en résulte seulement une plus grande commodité en plusieurs cas.

On se servira indifféremment dans ce Memoire du mot de outil ou de crayon, puisque le crayon represente ici le outil du Tour : par la meme raison on entendra la meme chose par la extremité de la tringle mobile, que par le terme de touche.

Le premier usage de cette Machine, et celui qui se presente de abord, est de trouver par son moyen quelles sont les diferentes figures que on peut faire tracer à le outil avec la meme Rosette, ce qui est très facile à executer, dès que on a en cuivre ou en fer un modèle de la

Rosette que on veut essayer; car ayant placé et assujetti ce modèle, ou cette plaque de cuivre, comme nous avons dit, à une des extrémités I (*Fig. 1. Planche LXXIII.*) de le arbre du grand pignon, le crayon ajusté à la autre extrémité a (*Fig. 2*) qui par le moyen des rainures ae, fc, peut se placer dans tous les points différents du papier, tracera dans toutes les différentes positions que il peut recevoir, tous les dessins possibles que peut fournir la rosette donnée, et cela dans la dernière précision, si la Machine est bien faite.

On est surpris de la extreme différence qui se trouve entre certaines figures produites par la meme Rosette; peut être aussi paraîtra-t-il singulier que ce soient de ordinaire les Rosettes les plus simples qui donnent les figures les plus bizarres. Il est certain, du moins, que les Rosettes qui ont un grand nombre de cotés, ne produisent dans aucun cas des desins aussi différents de elles memes, que une Rosette simplement triangulaire ou quarrée, et cela doit être ainsi.

Pour en rendre la raison plus sensible, et en meme temps pour donner quelque idée de cepremier usage de la Machine, nous allons examiner ses effets dans quelques cas particuliers, résultants de différentes positions du crayon; et afin de rendre la chose plus simple, nous prendrons de abord pour exemple la Rosette quarrée, telle que nous le avons proposée dans la description de la Machine.

Dans toutes les figures suivantes, on suppose les plans parallèles de la Rosette et du dessin projetés le un sur le autre, le centre de la Rosette et celui de la figure seront par conséquent le meme point C (*Fig. 3*); le trait ponctué marquera le contour de la Rosette, le autre trait marquera le dessin qui résulte de cette position, T le point de la Rosette où porte la touche, et O le point du papier où le crayon répond au meme instant.

### THIRD CHAPTER

*Continuation of the researches on the Lathe, by M. de la Condamine.*

#### SECOND ESSAY

*Where are examined the nature of the Curves that can be traced by the movements of the Lathe.*

We will suppose in this Essay all the preliminary concepts which we gave in the precedent, concerning the Lathe to make figures, and its principal part called the Rivet washer.

In addition to all the various situations that one can give to the tool, that change, like it has been seen, the traced figure by preserving the same Rivet washer, the outline of the Rivet washer which can be varied infinitely, it is clear by what has been explained, that one can trace on the Lathe, infinite different Curves; but as the traced Curve whatever it can be, has in all these possible situations of the tool, a ratio, necessary and depend on the outline of the Rivet washer which produced it, it is this ratio that one proposes to examine here, and by this, to know in general the nature of the Curves that one can plot on the Lathe, by considering as known those which form the outline of the Rivet washer.

In addition to the rotation movement on the axis which makes the essential of the simple Lathe, and which is common to all the Lathes, and the movement of parallelism which is particular to the ordinary Lathe to make figures, that one can name Lathe with Rivet washer; I have already noticed that the crankshaft of the Lathe could receive a third movement in the direction of its axis. This movement, with the assistance of a second key, of a second spring, and a part called the *Crown*, which acts in this sense as Rivet washer, it serves to carry out hollows and reliefs on the plan of the work. The majority of the Lathes to make figures has this third movement, and this mechanics is about that of an extremely clever and commun Lathe in Germany, which is used to copy medals. It is possible to conceive that in a Lathe which has these three movements, and that can be called the Lathe with Rivet washer and Crown, the plan is changed by the point of the tool, and that consequently the Curve traced becomes with double curvature.

The principal goal which is proposed in this Memoir, is to examine the nature of the plane Curves that the tool traces in the ordinary Lathe to make figures, on a level parallel with that of the Rivet washer, by disregarding the third movement that would make to change the plan to the tool; and it is this kind of plane curve that we will understand under the name of *Curve of the Lathe*.

If one wishes something more, after having found, as one can do it by decomposing the movements of the Lathe, which are in a Lathe that has the three movements, the two curves which would be plotted each one separately; one on a level parallel with the axis, by disregarding the movement of parallelism; the other on a level perpendicular to the axis, by disregarding the direct movement of the crankshaft; the other on a perpendicular level to the axis, by removing the direct movement of the crankshaft: one will be able, by the

method of M. Clairaut <sup>3</sup>, to find the curve with double curvature which will result from the combination of these two plane curves considered as its projections. As for the present these are plane curves that matter.

To start with the simplest case, first one will suppose the pointed key, namely, such that one and a single point of the key, reaches successively all the points of the outline of the Rivet washer. Then one will examine the flat keys, convex flats, concave flats, with caster, etc of which the use is real or possible; but until so that we make a new assumption, it is good to warn that all that follows must be understood under the hypothesis of the pointed key.

It still should be observed that by the name of tool, we understand only one point which traces only one simple feature, such as the tool that the Turners name grooving plane.

The ratio of the curve plotted by the tool with the outline of the Rivet washer, is difficult to see only because the tool operates on a different level from that of the Rivet washer, and moreover mobile of a double movement. To raise these two obstacles, 1°. We will bring back the curve plotted by the tool to the plan of the Rivet washer, as one has made in the figures of the first Report. 2° One will suppose that the crankshaft, and consequently that the Rivet washer has no more any movement, neither of parallelism, nor of rotation, and they will be replaced by equivalent movements that one will give to the tool. All this will be conceived better by an example.

Let  $T\Theta\theta\tau$  be the Rivet washer, whose center and that of the crankshaft of the Lathe is  $C$ . 1°. The plan of the work on which the tool traces the figure  $O\omega\Omega$ , a plan that, in the ordinary construction of the Lathe, is situated at the other end of the crankshaft, parallel to the Rivet washer, will be here assumed, brought closer and projected on the very plan of the  $T\Theta\theta\tau$  Rivet washer, such as it can be seen in the figure. This assumption does not change anything in the essential of the construction of the Turn, it is only as if the length of the crankshaft which is made only for the convenience of the workman, was reduced to a point, so that the surface of the work or the plan on which the tool works, was contiguous to the plan of the Rivet washer.

In this connection it can be observed that like it has been more convenient in the machine of the first Essay, to make the movement of parallelism in the vertical line, instead that in the ordinary construction of the Lathe, the crankshaft is driven horizontally; one will suppose here in all the figures, the key in  $T$ , over, and not under the Rivet washer in  $t$ , what does not change anything for the purpose.

2°. The axis of the crankshaft reduced to a point being represented in the figure by the center  $C$ , the movement of the point  $C$ , in the plan of the work, along the line  $CT$ , will represent the movement of parallelism of the crankshaft of the ordinary Lathe; to replace this movement, by supposing that the Rivet washer is motionless, it should be conceived that the key  $T$ , and the tool  $O$  are adherent to the plan of the work that have become by the preceding assumption, contiguous in the plan of the Rivet washer, and that this same plan

---

<sup>3</sup> Recherches sur les Courbes à double courbure. Paris, 1730.

which carries the key and the tool, is mobile, so that its center can describe the line TC.

To represent itself this movement well, it must be only imagined that the contiguous plan to the Rivet washer, in which we have fixed the key and the tool, carries a groove or slide in the direction TC, which enables him to go and come along this line, by approaching or moving away from the point C, which is taken at the plan of the Rivet washer having become motionless. In this manner, whatever the position of the key T and the tool O can be, this movement of the plan of the work will replace the one that has the center of the Rivet washer along the same the line TC, or tC, in the ordinary construction of the Lathe.

3. At last, instead that the plan of the Rivet washer  $T\Theta\theta\tau$ , had to turn on its center C, the key and the tool kept motionless in T and O, it will be the parallel plan to the Rivet washer, and contiguous to it, which carries the key and the tool T & O, that we will make turn on the center C, while the Rivet washer is to become fixed, what is still absolutely the same thing.

The groove TC of the plan contiguous to the Rivet washer allowing, by the second assumption, to the key T, that is fixed at this plan, to approach and to move away from the fixed center C of the Rivet washer, and because of the last one, being mobile the same plan on its center, it is easy to conceive that these two assembled movements will result into the facility of making walk the key T on the edges of the Rivet washer, while following the inequalities of its contour; the tool O, pulled by the same plan which carries it, will describe the same line than in the ordinary construction of the Lathe.

All this well understood, the solution of these Problems, of which the one is the reverse of the other, arises by it same.

#### PROBLEM I.

Given the contour of an unspecified Rivet washer, and the respective position on a same plan of the center of the key and the tool, to find on this plan all the points of the drawing which will result from it.

#### PROBLEM II

Given a drawing or an unspecified contour with the position of the center of the key and of the tool, to find on the same plan all the points of the contour of the Rivet washer which must produce a similar drawing.

That is to say, all that one has already assumed in the preceding figure, the tool that answers to the point O on the plan of the Rivet washer, in the moment when the key comes into contact with the edge of the Rivet washer at the point T. That the contiguous plan to the Rivet washer on which the key and the tool are fixed, starts to turn on its center, so that the key starting from the point T, always carries, while turning, on the edge of the Rivet washer; it is clear that it will answer to the points T, t,  $\tau$ ,  $\theta$ ,  $\Theta$ , successively; but because of the same reason, the tool starting from the point O will answer in the same order to the

points  $O, 0, O, \omega, \Omega$  because, when the key arrives at the point  $T$  on the angle of the Rivet washer, the line  $TC$  in which is driven the center of the plan which carries the key and the tool, the line  $TC$ , I say, will be transferred onto  $TC$ ; and the distance from the key to the tool being always the same, by taking on  $TC$ ,  $TO$  equal to  $TO$ , one will have the point  $O$  where the tool will answer then; similarly one will find all the points  $0, O, \omega, \Omega$  of the tool, corresponding to the points  $T, \Omega, \theta, \Theta$ , of the key, thus one will have in this position of the tool, the figure  $O O 0 O \omega \Omega$ , similar to Fig. 5. (Plate LXXIV.) of the first Report, where the positions of the key and the tool were the same ones.

If the key was between the center and the tool; for example, if the tool was at the point  $Q$ , more far from the center than the key  $T$ , it would not have there more difficulty in finding the points of the curve, and one will proceed always there in the same way, as long as the pencil and the key will be in the alignment of the center, on any point of the line  $TC$ , prolonged or not prolonged, where is placed the tool. If one supposes that it is placed in  $Q$ , the key being in  $T$ , one will find the curve  $QABCE$ , similar to that of the Fig. 4 (Plate LXXIV) of the first Report, which had been traced with the Machine, in similar circumstances.

In the preceding examples, one always supposed the tool in the alignment of the center and the key. When the position of the tool is oblique, namely, when it is placed out of this alignment, the case becomes a little made up, but one will not stop to find the points of the curve also exactly.

Let us suppose, for example, the tool placed out of the alignment of the key and of the center at the point  $O$  of Figure 7, the key being in  $T$ . When the key arrives in  $T$ , one will find the place of the tool or pencil, by taking the point  $O$  at the same distance from the key  $T$ , that was the point  $O$  of  $T$ , and on the line  $TO$  that makes the same angle with the ray  $TC$ , in which is now the key  $T$  that made  $TO$ , in its first situation, with the ray  $TC$ .

Consequently for the same reason, when the key will arrive at the point  $t$ , by drawing to so that it will make with  $tC$  the same angle than  $TO$  with  $TC$ , and by taking after to prolonged, the distance to equal to  $TO$ , we will find the point  $o$ , and so on with the others, the series of the points  $O, O, 0, O, \omega$ , will form a contour similar to that of the Fig. 3 (Plate LXXV) of the first Report.

One will find in the same way all the points of the curve, in whatever point that the tool out of the alignment of the key or the center is placed, and we would find here, by covering all the positions of the key and the tool, all the figures of the first Report, traced in the same circumstances. The three examples that we have just referred, are enough to show that in all the cases, either the position of the tool is direct or oblique, one has a means for finding all the points of the traced figure, which is the resolution of the first Problem suggested; let us pass to the second.

It is supposed now that the contour that the tool must trace, is given, the respective positions of the center of the key and of the tool are similarly given; one seeks the Rivet washer which, in these circumstances, will produce the drawing given. There will not be more difficulty than in the other case.

To give of it an example sensitive and different from the precedents, I suppose that one seeks the Rivet washer which would make the tool trace the contour  $O\theta o$  of the head of the profile represented by the Fig. 4. the center common of the sought Rivet washer and of the given drawing being supposed at C, and the key at T, when the tool is at O.

From each point O, O, 0, O,  $\omega$ , etc taken on the contour of the drawing, one will draw from the center C, the lines OC, OC, 0C, oC,  $\omega C$ , indefinitely prolonged, and carrying one of the points of compass opened a quantity OT successively on all the points O, O, etc the other point will mark on the prolonged lines OC, OC, etc, the points T, T, t; T,  $\tau$ ,  $\theta$ ,  $\Theta$ , that will form the contour of the sought Rivet washer, and one will have the resolution of the second Problem suggested.

Otherwise, if one moves the end O of the straight line OT on the contour O, O, 0, etc so that the same line OT applies successively to the lines OT, 0t,  $\sigma\tau$ ,  $\omega\theta$ ,  $\Omega\Theta$ , always passing through the center C, the other end T of the mobile line OT will trace the contour of the Rivet washer TTt, etc of a continuous motion.

It is what has given the idea of the instrument of which a description will be given.

If the key was assumed to be out of the alignment of the center and of the tool, for example, at the point T, when the tool is in O, so that OT make an angle with OC at the point O, instead of making with OC only one straight line, one would need, to find all the points T, T,  $\tau$ , etc of the Rivet washer, to command to make make at this line OT, measurement of the distance from the key to the tool in its various positions OT, 0t,  $\sigma\tau$ , etc an angle at the points O, 0, O,  $\omega$ ,  $\Omega$ , with the lines OC, 0C, oC,  $\omega C$ ,  $\Omega C$ , always equal to that which OT makes with OC in its first position, as it has been observed in the example of the oblique position, Fig. 7 of the precedent Platen.

Each one of these two Rivet washers is the single one which can make trace with the tool the contour of the profile  $OOO$  in the given situations of the points C, T, O; but it is conceived that all the possible changes of the situation of one of these three points, will make to find a different Rivet washer, able to make trace with the tool the contour, if one has freedom to take these three points at will, and that only being given the drawing, one seeks the Rivet washer most suitable to produce it. Among the diverse respective positions of the points C, T & O, that will give as many various Rivet washers, one will choose, for the facility of the execution, that which will give the contour more smooth and least angular, and that whose angles will be less acute.

It is in this view, and in the same time for more simplicity, than with the exception of some particular reason, 1. One will take the center C about at the middle of the figure.

2. One will prefer the direct position or in straight line TCO of the key of the center and the tool (*Figure 10. Platen LXXVI of the first Report*) to the oblique position TCO (*Figure 11, in the same Platen of the first Report.*)

3. [2.] One will place the key and the tool at the two opposite sides of the center in T and O,

rather than at the same side of the center.

4. One will take the smallest interval TC of the key at the center, larger than the least CO from the center to the tool, so that the contour of the Rivet washer is anywhere more far away from the common center than that of the drawing, and can embrace it.

While remembering what was observed previously, and in the first Report, on the various positions of the key and the tool, one will easily find the reasons of the choice of these circumstances, whatever the respective situation of the key and the tool, either straight, or oblique with respect to the center; we have thus an unquestionable means to find all the points of the figure sought in the plan of the Rivet washer given, or all the points of the contour of the Rivet washer which are sought, on the plan where it is traced the prescribed figure, what is the resolution of the double Problem that we ourselves had proposed preliminarily, for better recognizing the ratio that have between them the two contours.

Before passing over this purely geometrical examination, it remains us to give the description of the instrument on which it has just been spoken, that provides a straight and easy mean to trace through a continuous movement, all the possible contours of the rivet washers, appropriate to carry out a given drawing, and reciprocally all the possible drawings that can be produced by given Rivet washer; and that without being obliged to file copper models, as in the Machine described in the first Report.

This instrument has the same uses, and can serve as the Machine of Mr. Grammare, about whom it has been spoken in the first Report, that he called his Oracle, and on which no knowledge has been able to be provided.

ABCD is a ruler of three inches in length, opened by a groove in its length, part AB is bored by several holes like nuts, in order to approach or to move away more or less the point B, of which the head is made out like a screw; this ruler is embraced by the tenons E, G, with a second ruler also bored by a groove; the first can slip under the second which carries a small barrillet L, of which the spring always draws with him the ruler from the lower part which is attached to him with a wire in D, this same ruler carries a second point N, that, consequently, always tends to approach the center P; this center is determined by a third point P which crosses the two rulers, and which is fixed on the top ruler EG, at the point where one wants, with the nut Z. This is how one makes use of this Machine.

Let be the contour of the profile of a head T (Fig.4.), for which one seeks the most suitable Rivet washer; after having cut out this profile as a chart, one sticks it on another chart RS, then one takes at will a point T as center inside the contour of the head; one bores the two charts at this point, and one attaches them on a plan, by inserting the point P there; after which one poses the point N on the contour of relief of the cut out head; one turns then with the hand, all the Machine, by always making carry the point N on the edge of the indentation, or even best, one does nothing but to turn with the chart at its center with a hand, while turning with the other one the fixed Machine, and by having attention that the point N does not leave the edge of the cut out chart.

In the one and the other case, the point B bearing on chart RS, traces there the feature VX



which is the contour of the sought Rivet washer; the point N, incessantly recalled towards the center P, by the effort of the spring L, and pushed back by the relief of the cut out profile, follows its contour easily, as long as this contour does not move away from the center in straight line, it is what it is necessary to avoid as much as possible, by choosing inside this contour, a center to place the fixed point P. If one cannot prevent that the point N does not hang in some place, as at the top of the nose, for example, and that the contour cut has the slope too stiff, to push back the point N by slipping, it will be necessary to help a little with the hand; but one will be able to still avoid this small inconvenience, if one retrace the same feature by turning the paperboard in an opposite direction ; in this manner the point which could not, to go up without the help of the hand, from the nostril towards the point of the nose, will slip without difficulty, and will be recalled by the force of the spring, from the point of the nose towards the nostril. By changing the center P, or by moving away more or less the two points B and N, one will make various contours, and one will choose the more slippery and more practicable on the Lathe, to be used as a model with the Rivet washer; before cutting it, it is appropriate to check it, by cutting out a chart after the line VX of the found Rivet washer, and by doing to bring a point on the contour, to see whether the other point N will give again exactly the contour of the head T that we have been proposed ourselves to carry out.

In this instrument it has been assumed that the key, the center and the tool are in straight line, because this situation is simpler and more convenient for the practice. If one was curious to see the effect of the oblique positions, it would be easy by adding at the end.

We have arrived to our main object here. The question is of discovering the nature of the Curve plotted by the tool of the Turn. The line of the Rivet washer and that of the drawing being brought back on the same plan, as the means for this have been provided, their ratio will appear by itself.

Let us with the simplest case, and always in the assumption of the pointed Key.  
 st CT, la distance de le outil O à la touche T.

Let be the line AB (fig. 3) the side of a Rivet washer of which C is the center; let us TO taken in straight line on CT, the distance from the tool O to the key T. From the explained use of the preceding instrument and its movements proved to be equivalent to those of the Lathe, it follows that while the Key T runs through the side AB of the Rivet washer, the tool O always remaining in the alignment of the Key and the center, and preserving its same distance TO, TO, to the Key T, will describe.

1°. The curve OOO concave with relation to the center C, if the tool is further away from the center than the Key T, and located for example at O, on the other side of the line AB.

2°. The curve O' O' O', convex with respect to the center C, if the tool is more close to the center than the Key T, and placed as in O' below the line AB.

3°. Finally the reentrant curve O' 'O' 'O' ', if the tool is located for example in O'' on the other side of the center C, regarding the key T.

It is seen that the three cases have that of commun that the points O, O', O'', are always in the lines TC, TC, prolonged or not-prolonged, and that the lines TO, TO', are equal between them, like TO, TO', and TO'', TO''.

One recognizes already this curve as much after its figure than after the way to describe it as the conchoid of Nicomedes, of which C, the center of the Rivet washer, will be the *pole*, AB the side of the Rivet washer, the *base*, of which T the Key will be the *point that runs*, O the tool the *describing point*, and OT the distance from the one to the other the measurement. This does not need demonstration, it is an obvious consequence of what was previously exposed.

It is necessary to observe that if ordinarily under the name of the conchoid of Nicomede it is comprised only the first of these three curves, namely, OOO, or some time the second O' O' O' produced the one and the other by taking equal parts TO or TO' on the rays drawn from the pole C either below, or beyond the base AB, it is less true than the curve O' O' O' which has a portion below to and the other beyond the pole C, and that is described in the same way and with the same conditions than the two others, is precisely the same kind of curve, and that this third case is contained like the two first in the equation of the conchoid of Nicomede.

But two circumstances distinguish the curve of the Lathe as generally taken from the Nicomede Conchoid, one is that this one always has as a base a straight line, unlike the side of the Rivet washer that is used as a basis for the curve of the Lathe that can be an unspecified curve; the other one, that in the conchoid of Nicomede the describing point which plots the curve is always in the alignment of the pole and the running point, unlike that in the curve of the Lathe the point of the tool can be located out of the alignment of the center and the Key, as in the positions that we have named obliques, and of which it has been given some examples.

The curve of the Turn, generally speaking, is thus not a Conchoid of Nicomedes ; but as the differences that have been just noticed do not deteriorate the principle of generation, that, basically is always the same one, the curve of the Lathe can be regarded as a kind of Conchoid more general than that of Nicomède.

Indeed, let be the base AB (Fig. 4.) representing the edge of the Rivet washer, an unspecified curve, instead of a line, as in the preceding example. Let be the point C the center of the Rivet washer, and T the place of the Key; if the tool is located at the point O on TC prolonged, it will not miss to the curve O O<sup>2</sup> O<sup>3</sup> which it will plot, to be Conchoïde de Nicomède, but to have a right base; but if the tool is located at the point Ω out from the line TC, so that the line TΩ, distant from the Key to the tool that has been named the measurement, forms a constant angle with the line TC which always passes by the pole C, and that we will name the Rule; the curve Ω Ω<sup>2</sup> Ω<sup>3</sup> traced by the point Ω will be another kind of Conchoid different from the first one.

From all that has been just observed, one can draw the following conclusions, which are general on the present assumption of the pointed Key, and which, considering what precedes, will appear obvious.

1°. Any figure traced on the Lathe is made up of as many arcs of Conchoids considered in the sense that we have just explained, than there are straight or curve lines which compose the contour of the Rivet washer.

2°. Each one of these arcs of Conchoid has as a base the part of the contour of the Rivet washer, along which the Key has slipped while the tool plotted the curve.

3°. Consequently these arcs will be equal or similar between them, if the sides of the Rivet washer are equal or similar, or they will not be such, if the sides of the Rivet washer are different.

4°. The Pole of all these arcs of Conchoids which compose the figure traced by the tool, is the center of the work or plan on which the figure is traced, and this center answers to the one of the Rivet washer, each of both being a point of the axis of the crankshaft of the Lathe.

5°. The describing point of all these Conchoids is the point of the tool which, although motionless in the ordinary construction of the Lathe, traces on the plan of the work, at the moment of the movement of the crankshaft, the same line that it would describe if the crankshaft was motionless, as we have supposed, and that its movements had passed in the key and the tool.

6. The point that runs on these same Conchoids, namely, the point which, in the description of these curves, follows the line which they use as their basis, is represented on the Lathe by the point of the Lathe which, though motionless, makes the same way on the edges of the turning Rivet washer, that it would make if it were desplaced on the contour of the motionless Rivet washer, as it has been showed. Thus in the ordinary construction of the Lathe, the point that goes through the traced curve is not situated on the same surface where the curve is plotted, namely on the plan of the work, but on the plan of the Rivet washer, which is parallel to it. The means have been given of reporting the contour of the Rivet washer and that of the figure on the same plan.

7. The measurement of the Conchoid, or the distance between the describing point and the point that runs is always on the Lathe, the interval between the key and the point of the tool, reported on the plan of the Rivet washer, or over any other parallel plan, and that whatever the position of the key and the tool, either right, or oblique.

8. Finally the rule of these same Conchoids, or the line drawn from the point that runs, passing by the pole, and indefinitely prolonged, will be on the Lathe the line drawn from the key by the center of the Rivet washer.

To distinguish the two species of Conchoids  $O_3 O_2 O$  and  $\Omega_3 \Omega_2 \Omega$  (Fig.4.) one will name direct Conchoid, the first  $OOO$ , in which the measurement  $TO$  is taken on the prolonged rule  $TC$ ; having already named direct, this position of the tool  $O$  in the alignment of the key  $T$  and the center  $C$ , one will name by the same reason, oblique Conchoid, the second  $\Omega\Omega\Omega$ , in which the measurement  $T\Omega$  forms an angle  $\Omega TC$  with the rule  $TC$ , this position of the

tool O out of the alignment of the key T and the center C having been already named *oblique* position.

On the simplest hypothesis that we currently examine, namely, on the hypothesis of the pointed key, which only one and the same point touches the edges of the Rivet washer, they are thus generally speaking, arcs of Conchoid that the tool describes. But to see more particularly which are the differences that result in the plotted curve, after the diverse assumptions which one can make, so much on the figure of the Rivet washer, than on the respective position of the key and the tool, we will follow the various cases that the hypothesis of the pointed key gives, before to pass to the effects of the other keys; that will give us place at the same time, to point out what was made on this matter, several of the curves of which it is here question, being presented in various meetings to famous Mathematicians, which did not always consider them under the aspect of Conchoids, under which they meet.

I distinguish three principal cases that include all the particular cases.

The first is that where the side of the Rivet washer is a line, being the tool in a direct position, or in the alignment of the center and the key.

The second, the one where the side of the Rivet washer is curve, the tool being in a direct position similarly.

The side of the Rivet washer, being either straight or curve, I make of them just one case, when the position of the tool is oblique, or out of the alignment of the key and the center; this case which is the third, is the most general, and contains all the others; and though the Turners until now commonly did not give an oblique position here to the tool, it has been shown in the first Report, which were its uses and its advantages.

In the first case, the curve of the Lathe is a Conchoid de Nicomede, it was seen, and that is obvious (fig. 3.).

In the second, it is necessary to distinguish, because the sides of the Rivet washer make arcs of circle, or portions of another curve. If they are arcs of circle, there are still several subdivisions to make, because the center on which turns the Rivet washer can be taken, or on a point of the circumference, or inside, or outside of the Circle-Rivet washer, and in all these cases the distance from the key to the tool can be equal to the diameter or to the ray of the same circle, and either larger or smaller than the one and the other; one will see why we distinguish each one of these various cases.

If the contour of the Rivet washer is circular, the center on which turns the Rivet washer is taken on a poi[n]t of the circumference of the Circle-Rivet washer, and the distance from the key to the tool is equal to the diameter of the same circle, the curve of the Lathe will be that on which Mr. Carré gave a Report in 1705.

To show it, it is enough to observe that the curve of Mr. Carré is not other than the Conchoid whose base is a circle PBGB, the pole a point of the circumference P, and the

measure PG a diameter of the same circle. Mr. Carré quotes on this curve a certain Mr. Koërfma, except that, he gives it as new.

However Mr. de Reaumur showed<sup>4</sup> that it was a portion of a geometrical Cycloid, what does not prevent that it is not also a Conchoid, because it is true that Mr. Carré gives up his curve at the point C, almost at its origin, not making that the end B runs through the mobile diameter PG which becomes  $\beta P$ , Bc and PC, but through the semicircumference GBP inside the circle, undoubtedly because to go through the other one PbG, it had been necessary that the mobile diameter as arrived at PC, had left the fixed point or pole P, which was not an obstacle, provided that its prolonged alignment always passed by the pole. While continuing to go through with this condition, the other semicircumference PBG, at the same point B, by arriving at P, of the mobile diameter, by the external side of the circle, the other end c of this diameter will describe the portion C c F of the curve until F; so the point G having been successively transported in  $\beta$ , B, P, B, B and G, will have described the whole circumference of the circle having left the point G, and returned at the same point. However there will be still only a half of the plotted curve, because a second time by doing go through the circumference the same point b of the mobile diameter currently returned in FG, by doing that this diameter successively takes the positions  $\beta x$ , PC, Bc, GP, so that this diameter even or its prolongation, passes through the pole P, one will obtain the other punctuated half FxCcP, equal and similar to the first, and both together will compose the whole curve, of which one sees a half described in the Treaty of Mr. de la Hire on Conchoids<sup>5</sup>, on which we soon will speak.

This Author points out at the same place<sup>6</sup>, that this sort of Curve was examined by Mr. de Roberval long time ago; Mr. de Roberval must not be the first one who had spoken about it, because he names it Mr Paschal's snail. Besides, although the Curve properly in question at the place quoted by Mr. de la Hire, is at a guess a little bit different from the previous one, as we can see by the Figure<sup>7</sup>, it is really absolutely the same. The one and the other have as a base a circle, as a pole a point taken on the circumference, both have a fixed measurement. Their only difference consists in that Mr. Carré takes as a measurement a line equal to the diameter PG, and that Sirs Paschal and Roberval take a line equal to the ray SP what makes that their curve SCPCF returns inside the circle, which does not change the nature of the curve. From which it follows that the Curve of Mr. Carré and the Snail of Mr. Paschal are two particular cases of the same curve.

As for the application of the latter to the Lathe, one sees that the distance between the key and the tool being taken equal to the ray, instead to the diameter, as in the preceding case, and the remainder of the assumption remaining the same one, the tool, instead of plotting the Curve of Mr. Carré, will trace the Snail of Mr. Paschal.

It can be told that by saying that the tool plots such curve, one always hears the portion of this curve corresponding to the arc of the Rivet washer which is used as a basis.

---

<sup>4</sup> *Mém. de l'Académ.* 1708. Pag. 208.

<sup>5</sup> *Mém. de l'Académ.* 1708. Page 50. Fig. 9.

<sup>6</sup> Pag.46. Fig.6.

<sup>7</sup> *Mémoire* 1708. *Ibid.* Fig. 6.

As long as the pole will be taken on the circumference of the circle, the figure of the curve will move away little from the two preceding ones. If the measurement is taken larger than the diameter, the curve will have in its contour a point of reflection as in Figure 5 where the measurement was equal to the diameter. If it is smaller, as in Fig. 6. the point of reflection of the curve will become a node as much smaller than the measurement will be larger.

If the pole is taken inside the circle, as long as the measurement will be larger than the diameter, the figure of the curve will differ little from the Fig. 5. It will start to have a node, when the measurement is smaller than the diameter, and to approach to the Fig. 6. The Figures in these two cases will be the same ones as the Fig. 13,14, etc (Plate LXXVI.) of the first Report, that belong to the eccentric Circle taken as Rivet washer. It is evident that one has to, in what concerned by the practice of the Lathe, limit to these two assumptions in the first Report, since it is not possible to turn if the centre of rotation was taken out of the contour of the Rivet washer.

It was seen that to plot the whole curve, when the pole was taken on the circumference of the circle base, it was necessary that this measurement goes through this circumference twice, and not only when the curve had a node inside, but even when it had only one simple contour. When the pole is taken inside the circumference, it arrives all the opposite, and either that the curve is simple, or that it has a node, only one revolution of measurement around the pole is enough to trace it.

Finally if the pole is taken out of the circumference, the curve has a great number of various figures according to the various ratios which will have between them the measurement, the diameter of the circle and the distance from the pole in the center of this same circle. But the curve will always have two portions closed and returned in themselves; the closest to the pole will be able to have the figure of one 8 as a number, of a spearhead straight or reversed, of an almond, an oval, a fan, etc; the most remote from the pole will have constantly a figure rather similar to a lunule, which width will be as much less, and the angles as much acute, than the measurement will be large. As long as the measurement will exceed the ray, the two portions of the curve will be isolated. They will start to touch themselves, if the measurement is taken equal to the ray; and if one makes it shorter, they will cross themselves.

All these curves which have a circle as a base, a pole and a constant measurement, are, as it is seen, Conchoids of the circle. Though I have go through all the various combinations, I do not give here the figures of each one in particular, to avoid a too long detail. I already noticed that several had been examined and considered under another aspect. In addition to what was quoted, one will find three of these Curves in a passage of Mr. Jean Bernoulli, inserted in the Reports of Leipsick, year 1695, page 59, on the occasion of a Problem on the Curve along which must be suspended a weight to retain a lift Bridge balanced in all the possible situations.

Mr. de Reaumur, in the Report already quoted, applies to all the possible Curves, taken as a base, the same principle of generation that Mr. Carré had employed only for the Circle. Moreover, Mr. de Reaumur gives freedom to place at will, in an unspecified point of the

plan, the fixed point that Mr. Carré placed only on the circumference of his circle, and by these two generalizations not only it contains the cases of the Snail of Sirs Paschal and Roberval, the Curve of Mr. Carré, and all those of the same kind which have a Circle as a base, but it embraces an infinity of other Curves.

Thus not only the Curve of the Lathe is that of Mr. de Reaumur, when the side of the Rivet washer is an arc of circle; but still whatsoever the curvure of the Rivet washer, and in what point the centre of rotation is taken, what extends to all the second case, namely, *to all the direct positions of the tool, the Rivet washer being with curved sides*, and what contains eminently the first case *where the sides of the Rivet washer are supposed to be right*.

It remains the third, which is the most composite, and which includes them all. It is *that of the oblique position of the tool, being the Rivet washer of sides either right or curved*. And it has been showed that the curve plotted in this case was the new species of Conchoid, as taken in the sense which was explained.

After being sure that the curve of the Lathe was a Conchoid endorsed in a wider sense than the one usually taken for it; before further engage me in the examination of its nature and its properties, I wanted to see whether someone had treated on it. It is by perusing the Reports of the Academy that I have found what I have just quoted from Sirs Carré and de Reaumur. I fell then on the scholar Report of Mr. de la Hire on *Conchoids in general*. *In general the Conchoid*, according to the result of its definition, *is a Curve plotted on a motionless level by an unspecified point of a moving plan, in which there is a given straight line of position which always passes by a fixed point of the motionless plan, while the end of this line goes through a straight or curve base, plotted on the same plan*.

My surprise was extreme, by seeing that by this definition which includes what we named *direct Conchoid*, and what one called *oblique Conchoid*, that this curve under the point of view which Mr. of Hire considers it, is precisely that from which we come to speak, namely a more general Conchoid than that of Nicomède, by the entrenchment of these two particular conditions, the *straight base*, and the *describing point caught in the rule*, which narrowed the curve of the former Geometrician. The Conchoid of Mr. de la Hire is thus exactly the curve of the Lathe which he then did not keep in mind; it is rather singular that while following its object, he does not generalise the Conchoid neither too much nor too little, but as much as necessary to meet the curve of the Lathe, to which is applicable all that it says of its Conchoids.

I do not speak here about a Geometry scholar work by the R.P. PierreNicolas, Jesuit, published in 1697, under the title *De Conchoidibus et Cissoïdibus*, this Author having adopted another principle of generation for his Conchoids, whose measurement is constant only when their base is a circle, with the result that there is just in this sole case where its Conchoid is the same curve as ours.

The terms of *base*, of *pole*, of *measurement*, of *running point*, and of *describing point* that I have employed, all the Geometricians have used them in the same sense; I have borrowed from Mr. de Hire that of *rule*, having looked at it not only like the neatest term, but as consecrated in this sense by its use on the part of this famous Academician. The only new

terms of which I have made use myself, are those of *direct Conchoid*, and of *oblique Conchoid*, to avoid a long periphrasis.

The work of M. de Hire, in which he gives the methods to find the tangents, the corrections and the quadratures of a great number of curves, still has this particular merit, that it is almost very synthetic, and that consequently it must have cost much more the Author.

It remains little to glean in a field harvested by so skilful hands, however as all that contributed M. de la Hire does not consider the curve of the Lathe, but in the case of the pointed key, the cases of the flat key, and of the curved key remain intact. Besides M. de la Hire has not given the means to find in general the place of the Conchoids, either the *direct* ones, or the *obliques*, and it even appears that he at least doubted that these last ones were geometrical, judging after the words of the Report already quoted<sup>8</sup>, *all the Conchoids that have geometrical lines as a base, are also geometrical lines, provided that in the description of Conchoid, the measurement is directly united to the rule.*

#### OBSERVATION.

*M. de Condamine gives here several very erudite and extremely required Problems, where it shows that all Conchoids either direct, or oblique, without exception, that have as a base geometrical lines, are also geometrical, by giving the means of always finding the equation in the case of the pointed Key, about which it matters here, and their tangents and the elements of their rectification and of their quadrature. He makes also the application of the method to the example of M. de la Hire, where he takes the circle for base, what gives place to some observations.*

*Then he examines what becomes the curve of the Lathe under the various assumptions that it can be made in what concerns the Key, after the hypothesis of the right or flat Key and in that of the curved Key; the Problems on which we have just spoken, being applicable only to the hypothesis of the pointed Key, or which only one and the same point would touch successively all those of the contour of the Rivet washer, which is the simplest case, but that cannot be rigorously true in practice, nevertheless one would make use of a pointed Key.*

*As all that this clever Author says about these kind of curves is too difficult and too abstract to be understood by simple Practiciens such as those for which this Work is composed, it has been thought a duty to remove it, by forwarding those which will have the curiosity to follow it in his erudite research, to the Mémoires of the Académie Royale des Sciences, Year 1734, from where this is extracted.*

Thus it has been shown that in the case of the pointed key, the curve plotted by the tool of the Lathe was always a Conchoid as taken by following the definition of M. de la Hire; and though that is not true any more out of this hypothesis, to bring back the curve of the Lathe to the same point of view in all the assumptions which one can make on the various figures

---

<sup>8</sup> Pag. 19.



of the key, it has been given the means of always considering the line traced by the tool, like a Conchoid, by seeking in the various cases of the rectilinear or curvilinear Key, the curve which can be used as a basis for the one of the Lathe as taken for a Conchoid, namely, to apply it to the Lathe, the curve whose outline would be in need to the Rivet washer for making the tool follow the same line, by assuming that the Key is pointed.

Whatever the figure of the Rivet washer and the Key, and whatever the position of the tool, in this case one has the means of recognizing the nature and the kind of the curve plotted by the tool of the Lathe, which was the object that we had committed ourselves.

I did not speak about the Lathes whose fixed tree by an end, is mobile only by the other, like a lever of the second species. The only difference between the effect of those ones, and the effect of the Parallel lathe that we have described, consists in that in those here in question, the traced figure can, while preserving its proportions, become more or less large, while approaching or while moving away just the work from the Rivet washer; rather than in the Parallel lathe, where the distance from the Rivet washer to the tool, does not bring any change in the dimensions of the figure.

Also there are Lathes in which the crankshaft, instead of being moved in parallel to itself, is carried by two mobile Poppets, on a common axis parallel with the crankshaft, so that the axis of the crankshaft, instead of being displaced in a plan, is moved in the surface of a cylinder, and that the center of the Rivet washer, instead of describing a line, like it describes it in its alternative motion to the parallelism, that we have explained, described an arc of circle. It is true that the height of the Poppets being of one or two feet, the ray of this circle is so large compared to the small arc which the center of the Rivet washer describes, that this arc can be taken mostly for a straight line; and the construction of this Lathe is made only to avoid another more complicated, that would ask for the movement of parallelism itself.

In what makes the curve of the Lathe which results, it is a Conchoid still more complicated than all those of which we have spoken, since this construction of the Lathe makes concerning the plotted curve, the same effect that if the rule that we always supposed straight, became circular. The same methods that we have employed would make find the equation of this new Conchoid; the calculation only would be longer, and there is nothing which invites to overcome its difficulties.

Instead of supposing the rule as circular, one could suppose it curve of an unspecified curvature, assumption very far away from the practice, and which would result only in particular cases of all that we gave of more general, but this Report is already only too long.

## TWELFTH PART

*Secrecies very useful for the People who apply to the Turn.*

### FIRST CHAPTER

To make and mould, Boxes or Snuffboxes as well of shell, as of horn.

It is firstly necessary to form a cast iron mould of the size which you will judge adequate, according to the size of your boxes. This mould must be made up of two parts; namely of a ring or circle h, g, f, (Fig. 3) of such diameter that you will like it, thick of approximately half an inch and broad in a proportion with the depth of your boxes. It is necessary that it is at least a little in talud in order to withdraw more easily the moulded scale. The second part is a round platform m, l dug in the same talud as the ring and so that it can rightly receive at least half of the ring o. The middle of the hollow of this platform must be a little concave to then be able to form a convexity on the top of the boxes. These two parts being formed, it is necessary to round your chip in such a size that being moulded, its edge exceeds a little that of the ring so that you are not without matter.

The mould and the chip being thus laid out, you will pose on the cross bar ox of the press an iron platen ee (fig. CC.) thick of approximately two lines. On this platen ee you will place the ring d directly under the screw of the press, namely, that the axis of the screw falls perpendicularly into the center of the ring; you will put then your chip c, c on the ring (fig. B B.) in such a way also that its center and that of the ring are in a same line with the axis of the screw. The ring and the chip thus laid out, you will pose on the chip a tampon or wood core bb, rounded a little in talud, namely almost in cone truncated and less thick than the diameter of the ring twice the thickness of the chip, and it is on what it is much necessary to put on guard, because if it is thicker than is needed, it will be to fear that the chip does not burst, and if it is lesser, the edge of the box will become wrinkled and waved, what would spoil the matter. Finally you put a platen of iron aa on this plug or core bb, and will press gently all with the screw DD, because if you press too strongly, the parts would draw from a blow out of their place. The whole being strengthened and being well pressed reasonably, you will plunge your press in a Boiler put on fire and full of ebullient water. Approximately after the time of two Miserere the chip or the horn starting to soften, you will tighten as much few the screw so that the plug, pressing the chip already a little softened, is inserted little by little in the mould, what you will do from time to time until it is entirely get in. After which you withdraw the press from inside the ebullient water boiler, and will plunge it in another full of cool water.

After the chip will be cooled, you will withdraw it from the mould n that you will put in the platform o to drive back the edges of the box, in the bottom of which you will put a tin platen, tx, round (as one sees in the figure marked 1.) and as much thick as you will wish that the edge of the box be broad. You will put in the bottom of the mould (like in the figure marked 2.) another one, su, almost of the same thickness than tx, and reversing the marked box 1. you will put it again on mould 2. After that you will give the whole on the same iron platen ee, and over the whole the iron platen aa, and pressing all gently with the

screw to strengthen the whole together you will put it again in the same ebullient water boiler, and when you know that the chip will be softened, you will strongly press the screw. Then the box leaving its form in talud n will take the form p whose bottom is entirely flat, but you will return it convex, as it is seen in r, by drawing the platen 2 and putting the box p in its place and in the bottom of this box a convex platen of tin q, on which you will put a wood plug that you will press with the screw of the press, in the same boiler full of ebullient water when the chip will be softened: and then the bottom of the box will take the same convexity as the platen q, and that the bottom of the platform. It is the way in which the Sieur de la Grange was used to do for moulding its Snuffboxes of shell.

*To melt the Horn and to mould it.*

First, it is needed to do the lye as it follows. Take three pounds of ashes of new wood and one pound of new quicklime which you will mix together, then you will sprinkle them with a little water, only as much as it is necessary to dissolve the lime. That being made, it is necessary to leave the composition during one night, then to stir up it and put it in a small vat at the bottom of which there will be a hole that it is necessary to stop with straw, and over the wisp, one will put a little poured ground bowl so that ash cannot pass, but only clear water that it is necessary to put over. Then it is necessary to put to heat water and to pour it in the vat on the ash that one will have had care to spread equally by all the same thickness, and to even press it a little with the hand: one will let distil the water that will have been versed on this ash and one will receive it in a vessel. So that the lye is not too strong it is still necessary to make heat some other water and to pour it on ash with that which one will have already collected, and to thus let distil the whole; and the lye will be made.

To melt the horn and to mould it, it is necessary to make it grate or rake and to boil it in the lye above referred until so that it is quite dissolved and thick like pulp. If you want to give some colour to the horn, when it will be melted, you will throw there such colour out of fine powder that you will like it, and it will be incorporated with your composition that you to will put in your moulds after having them well oiled before; then let rest the work which will harden while drying.

*Another manner of softening the Horn and the Bones.*

You must put to extinguish quicklime, inside urinates, and water being stale, you shall infuse there tartar, or wine-lees ash during some time, then pass and filter the water. It is necessary to have then horn or raked bones which you will put to cold-infuse in this water where you will put such color that you will wish, and when the horn and the bones are dissolved and well softened you will throw the whole in moulds. If the work that you will withdraw remained soft, it would be necessary to harden it to soak it in vinegar.

*Other.*

You shall take ashes of wine-lees and quicklime, fifty-fifty, you must make a strong lye; you will put inside filings of horns and you will let it to well boil: then put there such a colour as you will wish, and throw it in your mould.

*To soften Chip and Horn.*

Put six pints of water in a cauldron, add there an ounce of olive oil, or other, make boil water and put at it your chip, it will soften itself there. Take it subtly, and promptly put it in

the mould under the press, and it will take the form which you will wish. It is necessary that is done very promptly, because for little that the chip cools one misses his blow. It should not be pressed strongly but little by little.

*Other for the Horn*

Take a pound of quicklime, half-pound of dear ash or wine lees, four ounces of tartar or gravel, two ounces of common salt, put the whole to boil in a pot or two pints of water and even more: let boil the whole until so that two thirds are evaporated, then pass the remainder by a linen. The lye being made, put there filings or rapure of horns, and let them well boil together, until it becomes like pulp: then you will be able to add to it the color which you will want, and you will throw this pulp in the moulds which you will have prepared.

*To weld the Chip.*

Clean with a file or a knife the two sides of the chip which you want to join together, then having joined them, envelop them with some double linen wrap well wet. Then make heat two iron platens a little strong so that they can keep their heat some time. Put your package where is the chip between these two platens under the press which you will strongly tighten, and you will leave it there until so that the whole is cooled, and your chip will be welded. If the thing misses first once, there is nothing wrong and one will be free to start again the operation.

*For tighten a too loose Snuffbox.*

If you have a chip Snuffbox which is too loose and which is not closed, make boil of water in a casserole and soak the opening of the Snuffbox in this water: it will widen soon and fill the lid of the Snuffbox. Guard should be taken to let it soak too long time, otherwise it would widen too much.

## SECOND CHAPTER

Secrecies to mould and colour the bones and the ivory.

### *To soften the ivory.*

Take three ounces of spirit of nitre, fifteen ounces of white wine, vinegar, or even of common water. Put there to soak your ivory until so that it becomes soft and flexible, which will arrive without fire into three or four days.

Or, take a large root of Mandrake, cut it per small pieces which you will make infuse, to boil in water. Put there then to boil the ivory that you want to soften, and it will become indeed soft like wax.

### *To dye the softened ivory.*

Make dissolve in spirit of wine the colours with which you will want to dye your ivory: if it is in red, for example, it is necessary to take wood of Brazil or Cochineal, and when the spirit of wine gets all the dyeing, put it on your ivory, and leave it there until so that the ivory is well penetrated of the colour, and when it will be so in the thickness of one crown, it is dyed better than it would be a piece of cloth which one would have put at the dyeing. One can then put this ivory in such form that one will want; and to harden it after being moulded, it is necessary to wrap it in blank paper and to cover it with common decrepit salt and driest that it could be, leaving it twice twenty-four hours there.

### *Otherwise.*

Take black soda of Alicant, one pound; quicklime, three handfuls: put that in two pints of ebullient water and leave it to settle during three days. If it is almost red it is rather right, if not one needs to put again there the same drogues until it takes the ressemblance. At the time one let soak there the ivory and the bones which one wants to soften, during fifteen days and they will become like soft wax. Then to harden the works, one can make dissolve alum in water and put at it bone of cuttlefish in powder as much as alum, to make boil water until boiling point, and to put the ivory or the bone at it to soak approximately an hour, and having withdrawn it to put it at the cellar during some days.

### *Other.*

Take vitriol and common salt, in equal parts, draw from it the spirit, put inside your grated ivory, and it will become a paste which you will be able to mould. Then made to boil your ivory moulded in good vinegar and it will become again hard like before.

To soften the bones.

It is necessary to take ice of alum and smelt it in water on fire, then to put at it a part of rose water and ash passed well finely and there to let soak the bones or the ivory along a time of twenty four hours and they will be softened, then by making them to boil in clear water they will become again to their first state.

To harden the bones after they were softened.

Put in a glass vase, equal parts of common decrepit salt, rock salt, of ammonia salt, alum of feather, alum of succarin, alum of rock and alum of chip. It is necessary that the whole is reduced to powder. Then bury the vase in horse-dung and leave it there until so that these powders are reduced to water, that you will make take or freeze, on the hot ashes: then you will again give this matter in the manure, until so it is reduced a second times to water. To harden the bones and to restore in body the limes, plasters and other similar things, you will make use of this liquor.

To dye the bones in red and to make various works thrown to the mould.

Make boil in a large new pot with sufficient quantity of water, twelve quicklime pounds and a pound of calcined alum. Water being decreased by a third you will add two more quicklime pounds to it, then you will still make boil the whole until so that water can sustain an egg that does not sink. Then having withdrawn and having let stand the liquor, you will pass it by the filter. with four ounces of shearings or scrapings of scarlet, and will make boil the whole a small half fifteen minutes, with slow fire. After that you will remove what will be clear and neat and will put it in a vase aside. Then you will give water like before, but a third less, on deposit of scarlet and of Brazil; and having made boil like the first time, you will put this second dyeing with the first, and will continue in this way until that water does not take any more color. Then you will take rasped bones that have boiled before in the quicklime water and which are quite neat. Then you will put it in a flask with sufficient quantity of dyed liquor, and you will put the flask on sand with small fire, until that water is extremely evaporated : what you will reiterate until that the raped bone is reduced in soft paste, which you will throw in mould that will give it such form that you will judge right. You will leave it dry during one day or more, if it is necessary; and then to harden it and making it solid, you will make it boil in salpetre and alum water, then in the nut oil. If one would like to make figures of another colour, instead of wood of Brazil and scarlet one would serve of other dyeings, and in this manner one will make very beautiful figures which will attract admiration.

To melt the bones and to make such works of them as one will want.

Make burn in lime as much of bone than you will want: having drawn them; pulverize them well finely and pass them by a fine sieve. Take from this powder a part, half of

After that, make dissolve asphalt in a little wine, provided that there is enough to can dissolve it: put there then your bones and stir up the whole until so that it has acquired a consistency similar to cold puree. Then you will throw your matter in moulds which you will have rubbed before with oil, mainly if they are of paperboard. Let them well cool there, and withdraw them only at the end of twenty four hours, they will become hard like ivory. You can in last fusion give them the color which you will want, red, for example, with cinnabar, or beautiful minium, the blue one with azure, the green one with green of gray, and thus of the others.

To colour the bones in green.

Take a few well crushed verdigris, put it in a copper vase with vinegar, then put the bones at it. Cover well the vase and darken it so that it does not enter there any air: being thus closed put it during some fifteen days or so in the horse-dung. At the end of this time you will withdraw the bones which will be quite green and which will not lose this color

*Or.* Take crushed verdigris, put it in goat's milk until so that this milk becomes green. Then put the whole in a copper vase with the bones which you want to dye, well cover the vase and darken it like higher up in the page, then put it in the manure during eight or ten days, and after that you will remove the bones which will be well coloured. If you want to turn them more colourful, boil them in nut oil; because the more they will boil, the more they will become coloured. You will then polish them with marrow of elder tree, and to give them the gloss you will rub them with nut oil.

Otherwise. Take one pint of strong vinegar, pulverized verdigris and filings of yellow copper, three ounces each: a handle of *rhuë*. You must pile rightly the whole together and put it in a vase of glass that you will close well after having put there the bones. Then you will put this vase at the cellar in a cool place during fifteen days or more, and the bones will be dyed.

To dye the bones and the ivory in emerald green.

You must put in aqua fortis as much of copper rust as it will be able to corrode, then you will make soak in this water what you will want to dye during twelve or fifteen hours, and the colour will be perfect.

Another manner.

Take one pint and half of strong detergent, of ashes of vine shoot; there add an ounce of beautiful verdigris, a common salt handle, and a little of ice alum. Make boil until reduction by half, having care of throwing the ivory or the bones in this mixture as early as it boil. When you withdraw your dyeing from the fire, you will let there soak your ivory until it is

coloured enough.

#### To dye the bones in green.

Take two parts of alum of rock and part of alum of feather: make them boil in vinegar or common water. At once that the liquor will boil, throw there the bones until it is reduced to a little more than a half. After you will have withdrawn them, put them to soak in a soap detergent in which you will merge verdigris dissolved in aqua fortis with one pint and half of strong vinegar. You will leave them in this dyeing until they took the color which you wish.

#### To dye the ivory and the bones.

Put to infuse during seven days copper filings, alum of rock, and Roman vitriol. The infusion being made, put it in another vessel with ivory and bones, and add there the color that you want to give them with a little alum of rock, and make boil the whole until so that the matter took a beautiful dyeing.

Observe that before to dye the ivory it would be adequate to prepare it by making it boil in a small bath made up, of common water, nitre and copperas. After extracting it from this broth it should be put at the dyeing still hot.

#### To redden the bones and the ivory.

Make to boil sheer of scarlatte in common water; when it starts to boil, throw there a quadron of wine-lees ashes that will make to throw the color. Then, to put there a little alum of rock to clear up, and pass the dyeing by a linen. Do make a shearing of scarlate in common water; when it starts to boil, throw there a quateron of wine-lees ashes which will make throw out the colour. Further, do put there a little alum of rock to clear up, and do pass the dyeing by a linen. You will soak your ivory or the bones in aqua fortis and will throw them in the dyeing. If you want to make white spots there, it is necessary to cover these places of wax drops, and by wherever it is, the dyeing will not be able to bite, and they will remain white.

#### To marble the ivory.

Mould well together half of wax yellow and half of resin: then throw this composition in small bottles sweats the ivory, like when the Books are marbled. That made, put to boil the scarlet shearings with wine-lees ash; add a little alum of rock to this dyeing, and having clarified it while passing it by a linen, stew your ivory which you will have care to rub before with aqua fortis.



To bleach the damaged ivory.

Take as many alum of rock as one needs in proportion to the quantity of the parts that one wants to whiten again, and until the water is quite white. Then made boil it a bubble and put to soak the ivory there during approximately an hour, by rubbing it from time to time with small brushes of hair: then put it to dry at leisure in a wet linen, otherwise it would be split.

*Or.* Take a few black soap, apply it to the ivory part, approach it to fire, and having boiled it a little, wipe it.

To bleach the green ivory, and to whiten again that which became russet-red.

To bleach and degrease the bones.

To blacken the ivory.

To dye the bones in black.

Put your ivory to soak in water where one will have extinguished quicklime, and make boil it until so that the ivory appears extremely white to you. To polish it then, one needs to adjust it on the Lathe, and after having put it in movement, take horsetail and pumice-stone powder quite fine, and with water rub it as much as the work appears to you quite plain everywhere: one completes it to polish by rubbing it on the Lathe with a quite white linen and a piece of leather of sheep. Being well overheated on the Lathe, take whiting with a little olive oil, then rub it still dry with white alone, and lastly with a white linen, and the ivory will be very white and polished.

To bleach and degrease the bones.

Put quicklime in a new pot with a handle of bran and sufficient quantity of water. Put there the bones and make boil the whole until so that the bones are entirely degreased. Otherwise. Having removed their useless ends with the saw, make a strong detergent of ashes and lime, and on a seal of this detergent, add four ounces of alum: put to boil there the bones the space of one hour; then remove the cauldron from the fire, and let them cool, then you will make them dry in the shadow.

To blacken the ivory.

It is necessary to make soak during five or six hours your ivory in water of Wales, wine-lees ashes and arsenic, then to give it several layers of black of which one is used to blacken the Pear tree when one wants to counterfeit ebony, as one will see it in the following Chapter.

It is necessary to make soak during five or six hours your ivory in water of Wales, wine-lees ashes and arsenic, then to give it several layers of black of which one is used to blacken the Pear tree when one wants to counterfeit ebony, as one will see it in the following Chapter.

*Or.* Dissolve silver in aqua fortis, then put there a few scabiosa water or rose water, rub with it your ivory and make it dry then, Sun exposed.

To dye the bones in black.

Take six ounces of litharge and as much of quicklime, put the whole to boil in common water by adding the bones to it at the same time. You will stir it up always until the water starts to boil. Then remove it from the fire and do not cease stirring up until so that it is cooled, and withdrawing your bones, you will find them dyed in black.

### THIRD CHAPTER

On the preparation of the wood intended to make works with the Turn and on their dyeing in different colours.

*Preparation of green woods, before employing them, to prevent that they are not split.*

Having cut your wood according to the parts to which you have intended to, put it in a vase full with a light detergent, made with ashes of new wood. Made boil there approximately an hour, then having removed the cauldron from above fire, let cool the detergent without withdrawing your wood: after that withdraw it, and make it dry in the shadow.

*To harden wood.*

Being worked, made it boil a half fifteen minutes, in olive oil; and it will become hard like brass.

*To harden and petrify wood.*

Take rock salt, alum of rock, white vinegar, infused lime, powder of sharp stones, equal parts; put the whole together and mould it well, it will be made a boiling which being finished, the liquor which will come from it, will petrify the porous matters that one will put at it, such as wood, etc leaving there four or five days. It is necessary that the amount of this liquor is over the double, than the matters are wanted to put there in order to petrify them.

*Water to dye wood.*

Put the strongest white vinegar in a ceramic vase, you will make to infuse into it during seven days the copper filings, Roman vitriol, alum of rock, and the green of gray. You will then make to boil this water with the wood which you want to dye and it will take the color of it. If one wants to colour wood in red, instead of verdigris one will put red at it: if one wants to colour it in yellow one will put yellow at it; and thus of the other colors, always putting at it alum of rock, for any color that it is.

*To give to the wood the colour that one will want.*

Collect the freshest and wettest horse crotin that you will be able to find, strongly press it in a white linen, and put in a bottle of glass the juice that you will have expressed from it. If you have for example a half septier of it, you will merge, at large, alum of rock powder, and also pulverized gum arabic. When these two drugs are molten, you will put a few spoonfuls of this liquor in a small cup and will mix such color there that you will like it. Having let your color to rest during three days, you will make use of it to dye your works, by exhibiting this wood thus dyed to the Sun or to the fire to dry it, and by reiterating several times until it acquired the color that you will wish.

*To give the wood an ebony colour.*

It is necessary to take wood of India & to make boil it in water until the colour is well violet. The dyeing being almost made, you will throw there a piece of alum of the size of a

nut, & you will rub with it the piece of wood that you want to blacken with a brush, while it is still ebullient. Then, it is necessary to put to infuse iron filings in vinegar on hot ashes & to mingle a pinch of salt. You will pass with a brush of this vinegar on the dyed wood with the violet colour, & you will see that it will become black at first. To make the colour more durable, it is necessary to give on the black one, a second layer of the violet colour, and over it another of vinegar, & when the whole is dry, you will smooth the wood with an oil-cloth which will return it shining, as if it had there varnish. The harder the wood is, the more the colour is beautiful.

*Another manner of dyeing wood like ebony.*

It is necessary to crush four ounces of roman galls & to put it in a new clay vase. One will add to it one ounce of wood from India put in small pieces, a quarter of ounce of vitriol, & a half ounce of verdigris. Make to boil together all these drugs, & having passed them still hot through a linen, you will rub two or three times the wood with this composition, what will make it very black. It is necessary then to let it dry, and you will give it the gloss by rubbing it extremely strong with a waxed linen.

For the second layer, you will put to infuse a half ounce of iron filings, in a half bowlful of strong vinegar, after that you will give it some heat : being cooled, pass this water on the wood already blackened which will become black of ebony colour. Put into it until two or three layers, always letting dry the one after the other, & rubbing each layer with cheesecloth while it is still fresh. When the whole is dry, you will rub the wood with a waxed linen.

*Another manner for the hard woods.*

After having given to your wood the figure that you wish, do rub it with aqua regia, it will rise initially, while drying, some small wood wires which you will remove by rubbing them with a stone sandpapers; what you will do until twice, after which you will be able to rub it with the following composition.

Do put in a glazed clay vase, one pint of very strong good vinegar, two ounces of the finest iron filings, half pound of crushed galls: you will make infuse the whole during three or four hours on hot ashes. At the last moment you will increase fire and, will throw there four ounces of vitriol or copperas, and a flask of water in which before you will make dissolve half ounce of borax and as much of indigo. Make boil the whole a boiling, rub with it your wood at several layers, and being dry do polish it with a leather where you will have to put Tripoli.

*Wood colour of drowning.*

Do take barks of green and India nuts, parts equal: make boil them together in two pints of water until reduction by half and rub the wood with this liquor.

Or: Do take soot, scales of green nuts, galls nuts, vitriol; do make to boil the whole in water until it is reduced to half, and do use it to colour your wood.

*Ebony colour.*

Do put in two pints of strong vinegar, a half pound of iron filings, four ounces of burned vitriol, and four ounces of galls nuts; let soak the whole during fifteen days, and do use it.

*To make a beautiful black on Wood.*

Put to soak your wood during three or four hours in tepid water, where you will have dissolved a little of alun, then do have wood of India that one calls wood of Campêche, put some two grounds finely cut in a pint of water, that you will make boil until so that your water is decreased of more than a half. If you add a little Indigo to it, the dyeing will be more beautiful. Pass it hot, a layer on your wood with a brush, what will make a violet color. Let the whole to dry, once it is dried, do pass a second one and, let it dry; then a third one. What being made, you will boil as much copper acetate with strong vinegar as you like and, you will pass a layer on your wood: being dry, you will rub it with brushes, and then with oils and chamois. There is nothing so beautiful like this color, and it perfectly imitates ebony.

*To give to wood, the colour of the Brazil wood.*

Do extinguish the lime in urine, and the wood being laid out and being worked with the Lathe, of this composition, still heat, do make a coating, then let it dry. Being quite dry, remove this layer of lime and rub it with a chamois leather and, oil.

*Otherwise.* Once your wood being prepared, put it to soak in water where you will have made dissolve alum, then having made to boil five or six hours in water, wood of Brazil, you make to soak during one night your plated wood in this dyeing, then being dry, you will rub it with oiled chamois.

*Or.* Take half a pound of wood of India, four ounces of wood of Brazil, and an ounce of common alum. Make to boil the whole with your wood to dye until that it become of a beautiful purple.

*Another purple on the white wood.*

Take German litmus paper from which the Painters are used for themselves to paint in soaking, dissolve it in water which you will pass by a linen. Give a colour of this water to your white wood, and you will have a color of crimson. If the color is too strong, give another water colour less coloured while pouring of clear water among your first dyeing in order to whitening it. Continue to make dry and to give a new layer on your wood until you like the color. Then brown it with the burnishing stick.

*To dye wood in red.*

Infuse the pieces of wood that you want to dye, in red vinegar, during twenty four hours. Then take sufficient quantity of alum of rock and of powder of wood of Brazil which you will throw in the vinegar: give there to soak the same pieces of wood and let it there boiling until that the color seems beautiful to you.

*Or.* Take wood of Brazil, grate it quite fine and put it in oil of tartar: rub your wood several times, letting it dry at each time. Then, have care to polish it well with cloth or an oil-cloth.

*Otherwise.* Being your wood being well united and well rubbed with shave-grasse, give it four or five layers of subtly crushed vermilion and dissolves it with, water of cheese and lime. The whole being quite dry, you will polish the work with shave grass and a little oil

of aspic. Finally you will put over four or five layers of varnish made with yellow amber and, oil of aspic, and you will let it dry.

*Crimson color.*

Soak German litmus paper in water, add dye of Brazil which boiled with lime water, and you will have a color of crimson. Rub your wood with it, varnish it then and polish it with the burnishing stick, or cloth.

*Blue color.*

Put four ounces of German litmus paper to dissolve in three flasks of water, where quicklime has been put to extinguish, and make it to boil during one hour: after that you will make use of it like above, by giving several dyes to the wood.

*For the green.*

Crush the 'vert d'Espagne' to subtle powder by levigating it with strong vinegar. There merge approximately two ounces of green vitriol and, make to boil these drugs during fifteen minutes in two pints of water. Then throw there your wood that you will leave there until you find the color as you like it. For the remaining, you will proceed like above.

.....

If it was not yellow enough, it should be added two big of gamboge to it, then with a linen or a soft brush, you will apply to your wood a layer, that you will let dry, and reiterates it several times in the same way until the wood took a beautiful color.

*To counterfeit the root of drowning.*

On your wood you will pass, seven or eight layers of glue until it remains shining: then you will give shuffled blows of brush soaked in the yellowish brown, dissolved with common water.

## FOURTH CHAPTER

*On the genuine Varnish of China for applying to wood after polished with the Lathe.*

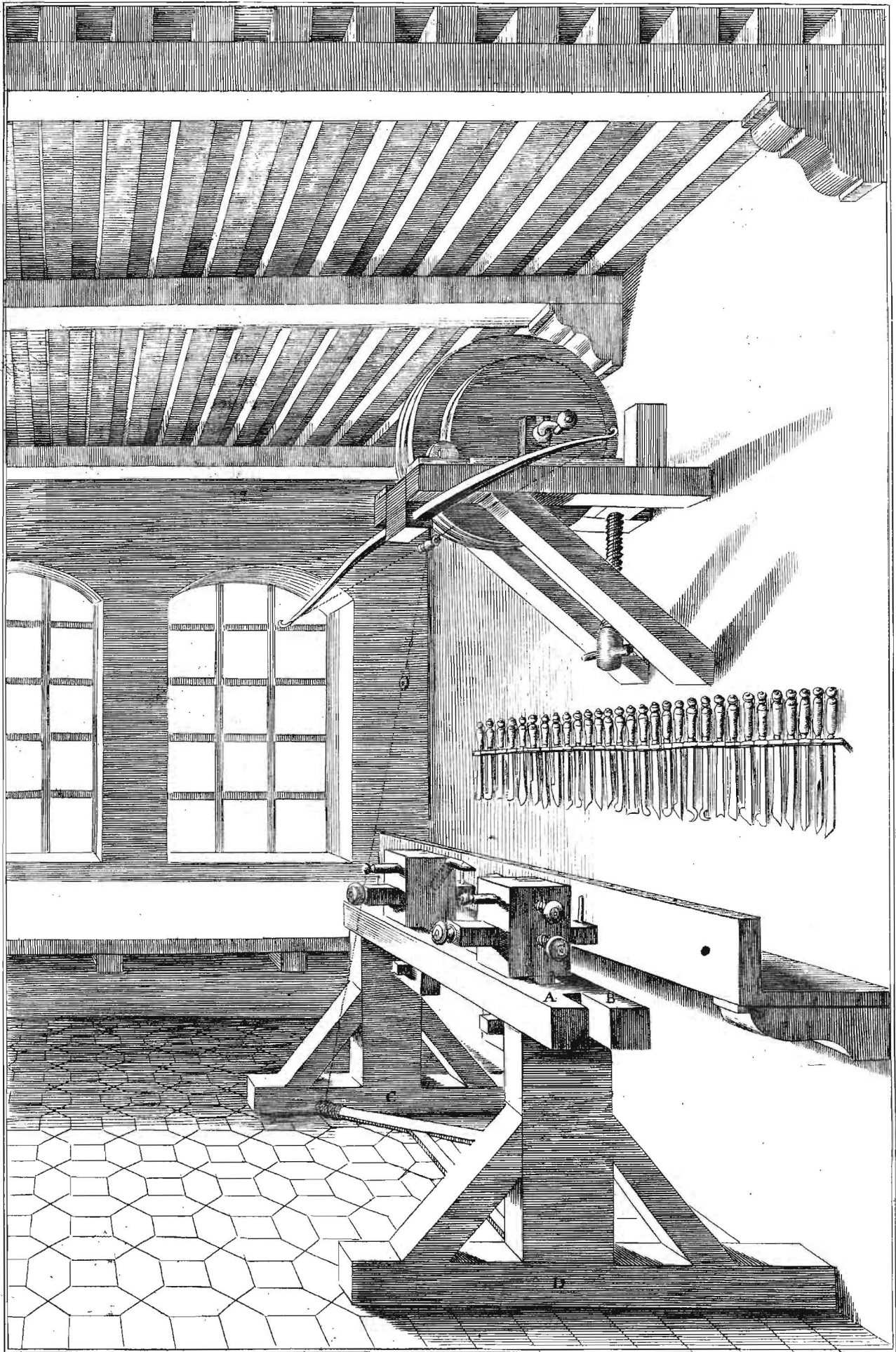




Figure Premiere

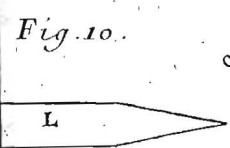
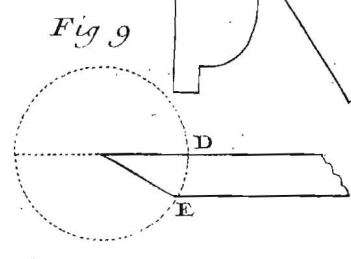
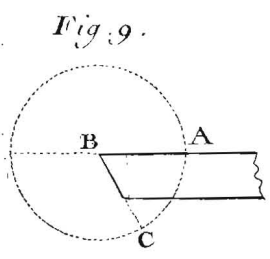
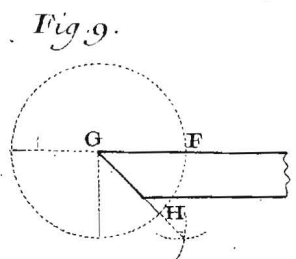
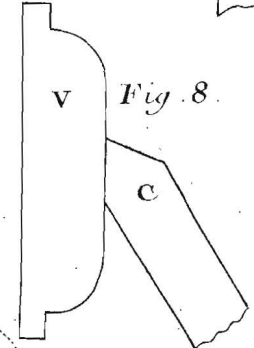
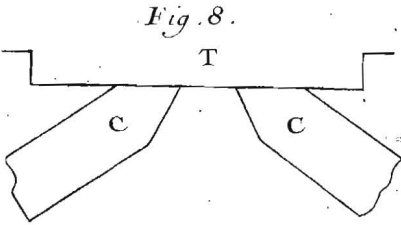
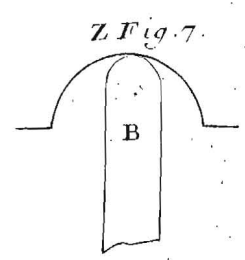
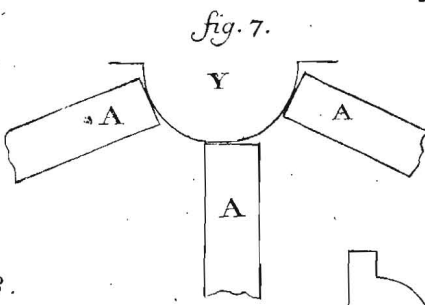
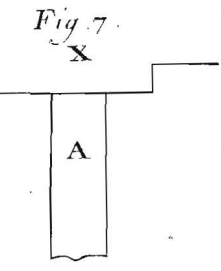
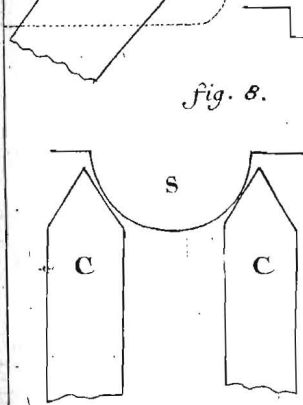
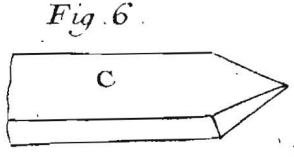
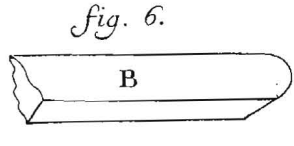
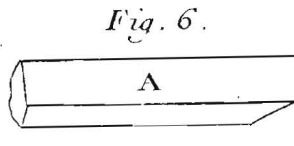
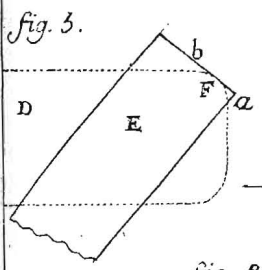
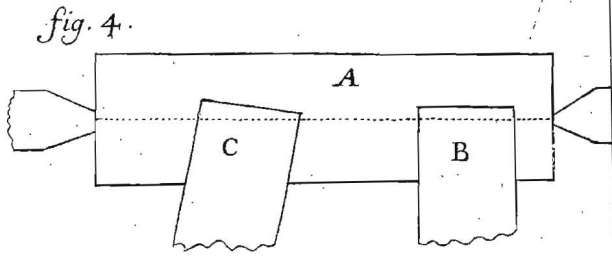
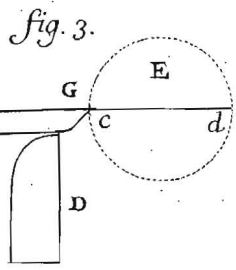
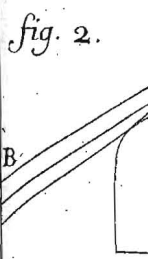
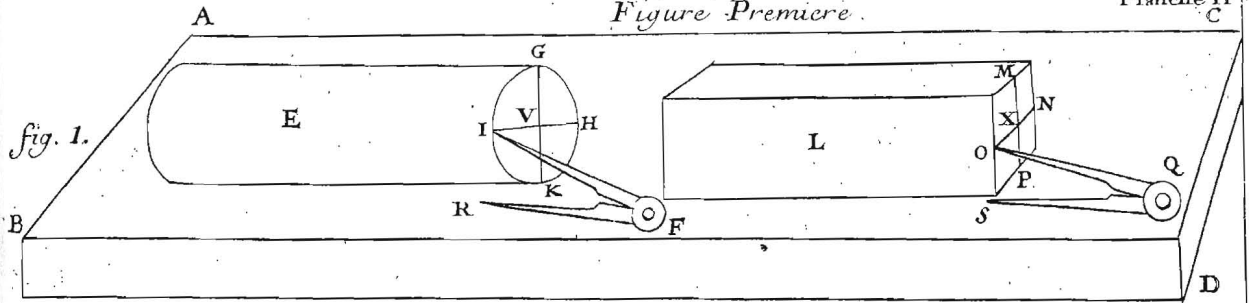


figure .10.

Fig.10.

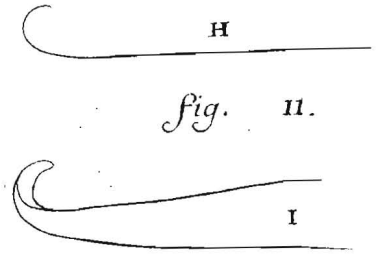
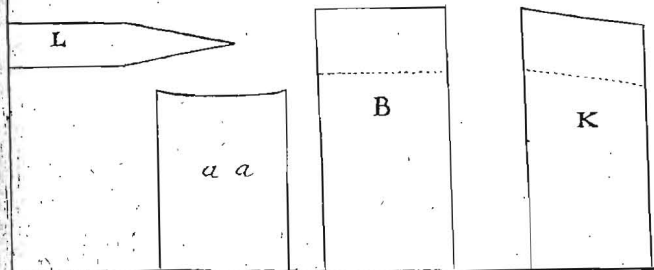


figure Premiere

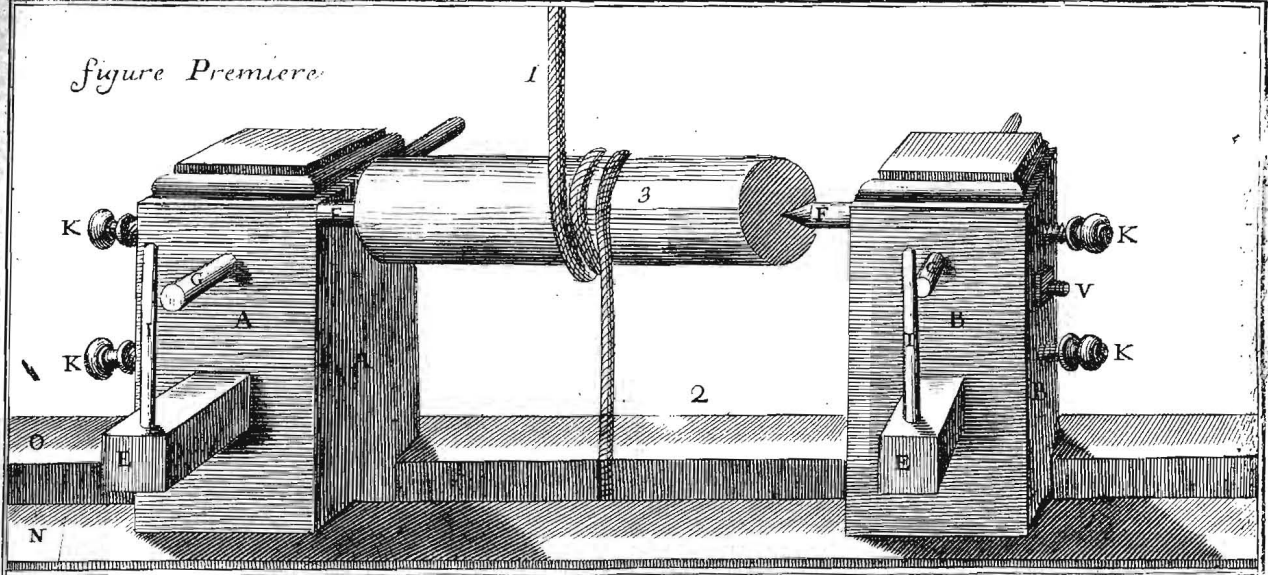
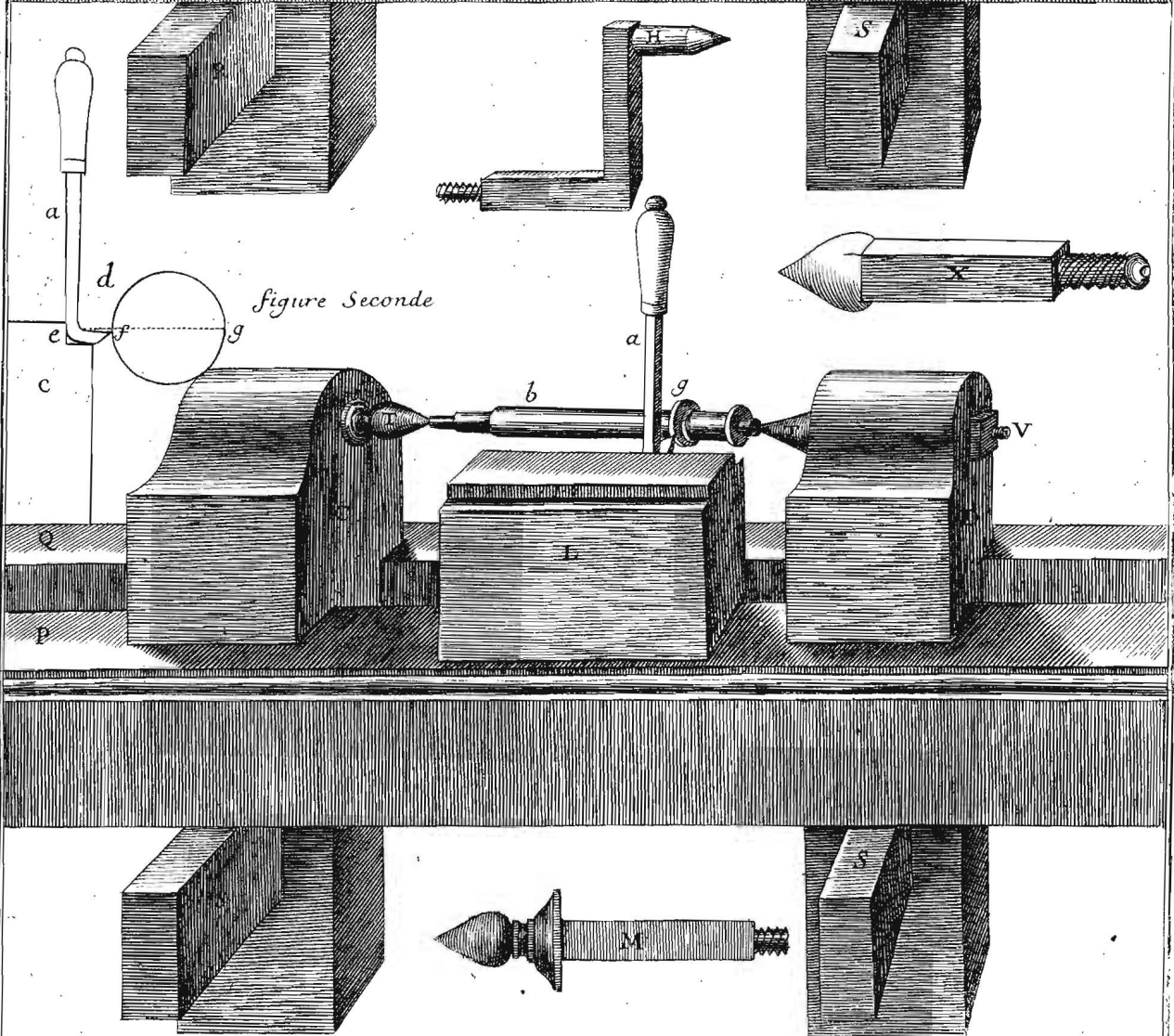
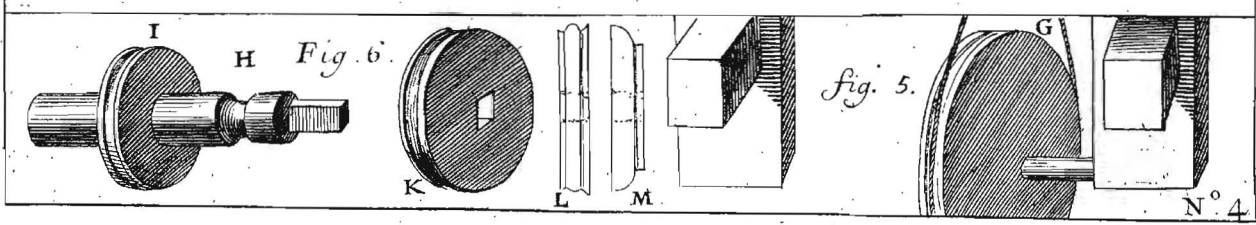
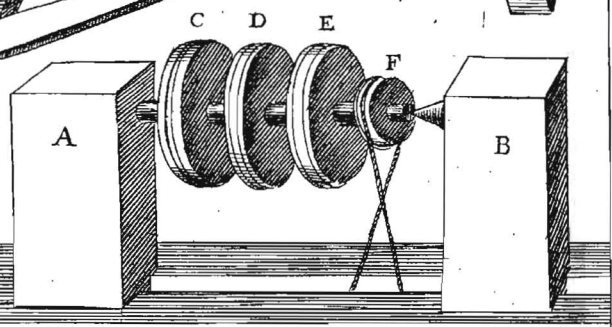
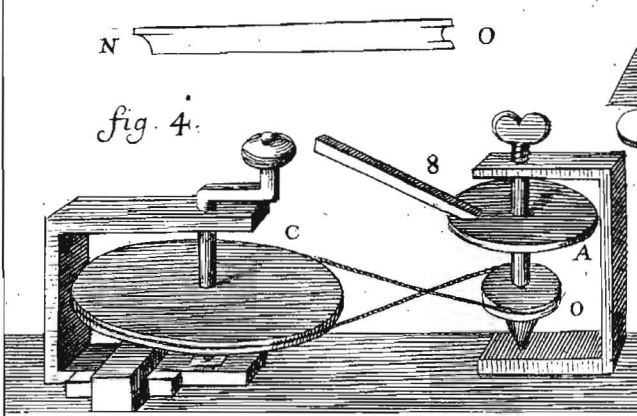
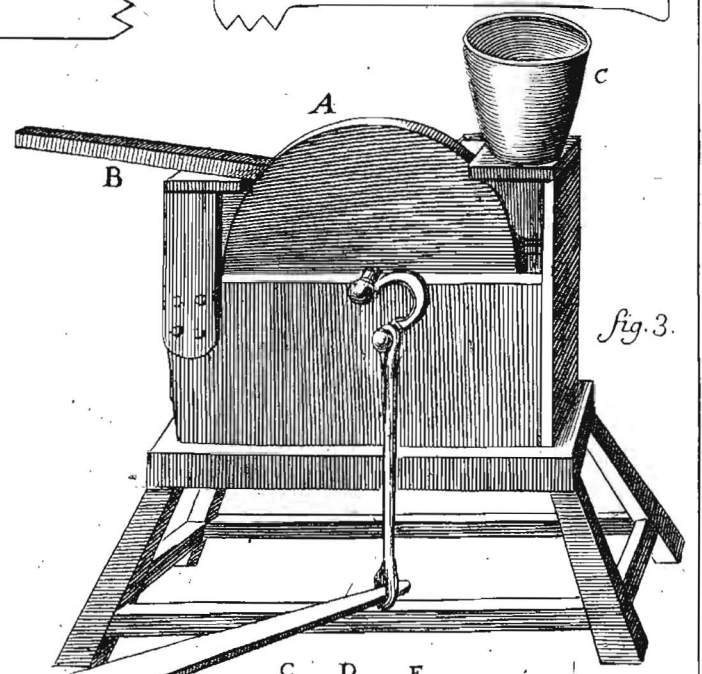
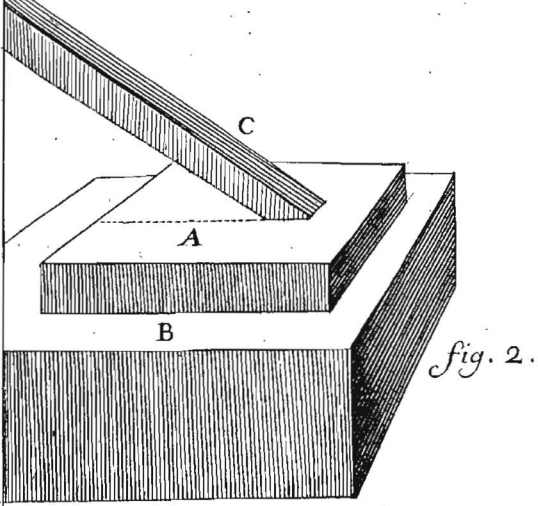
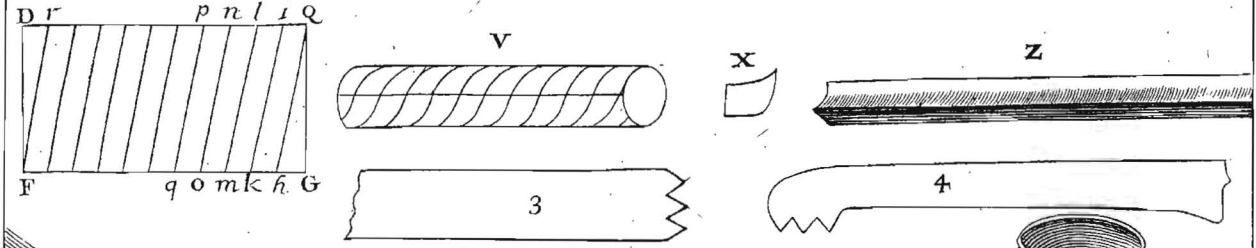
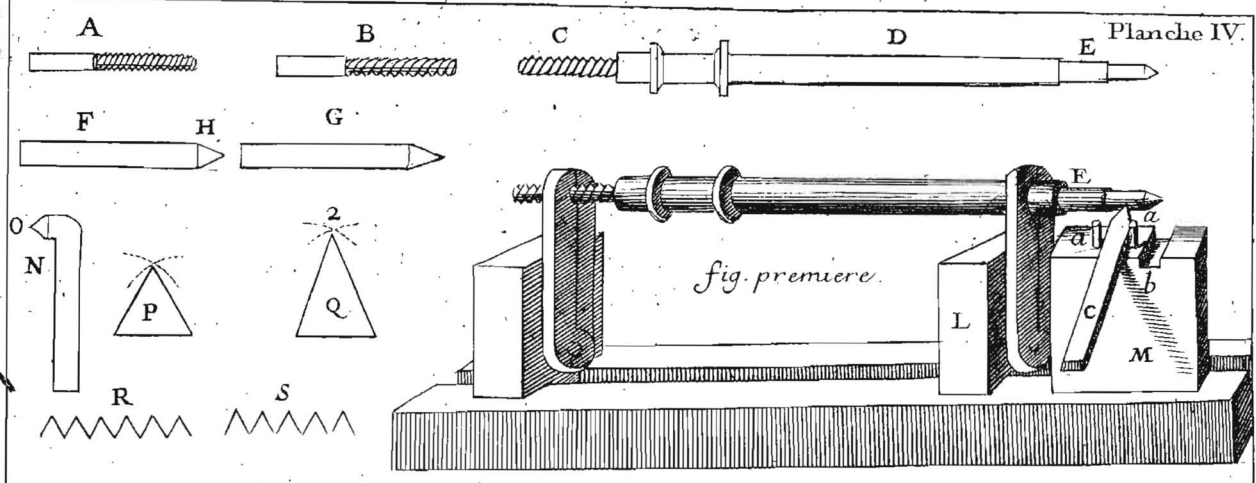


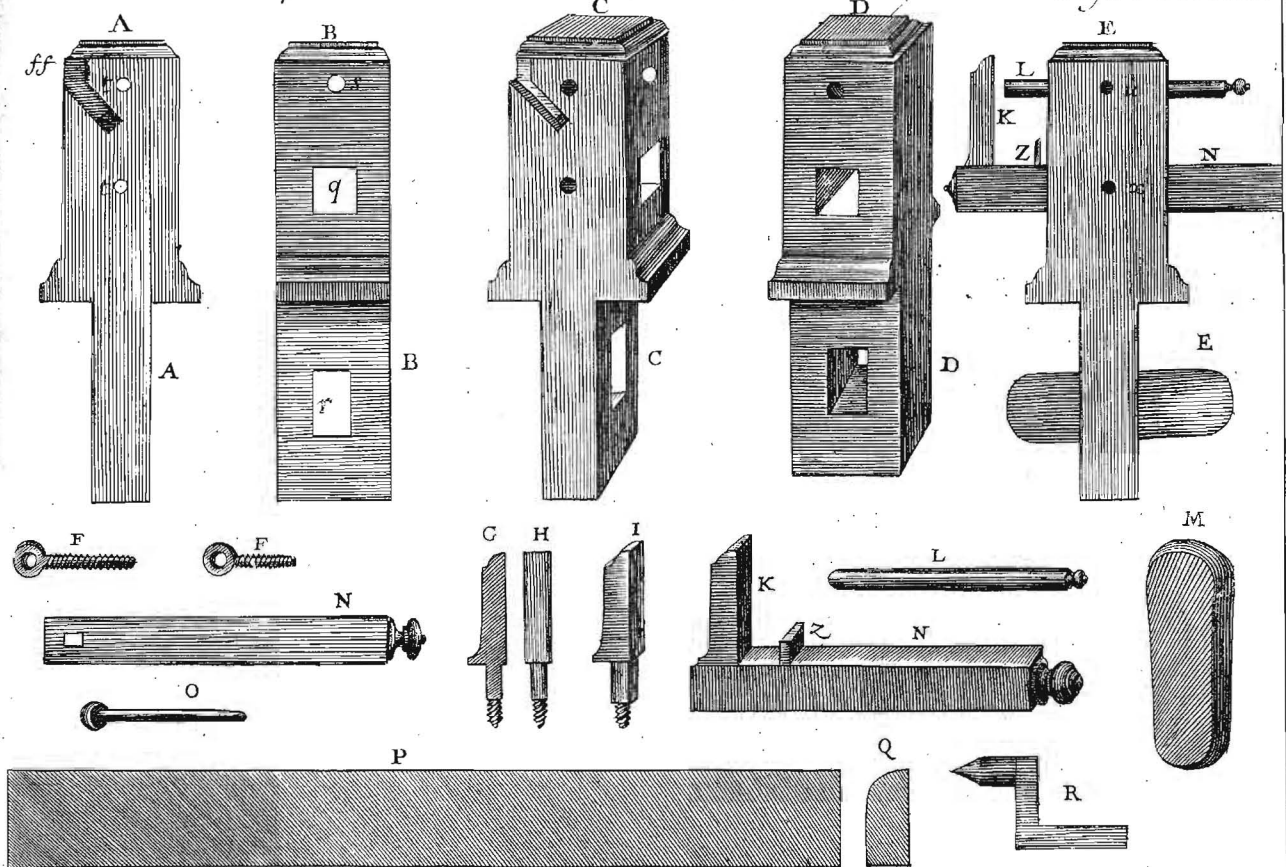
figure Seconde





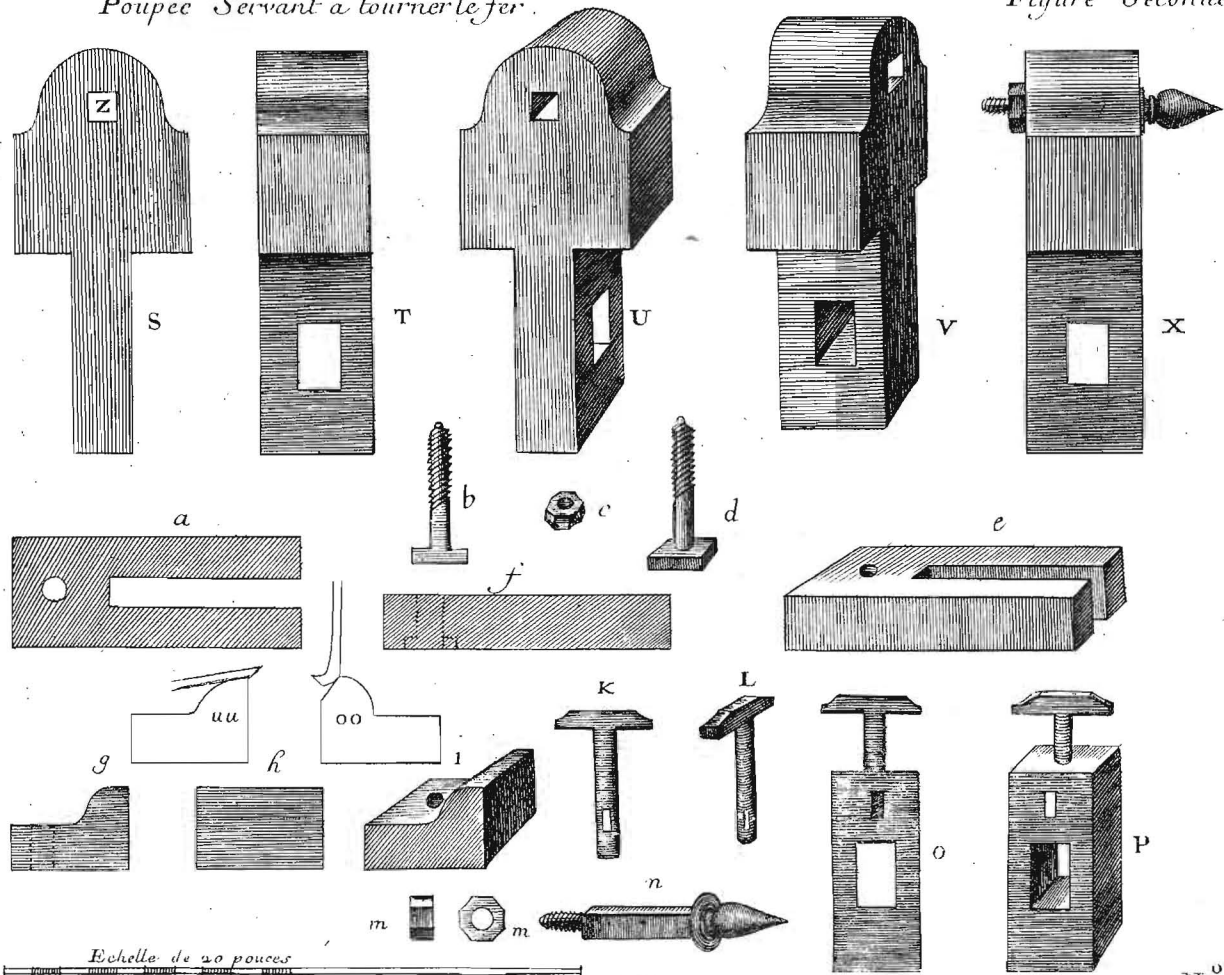
Poupée Servant à tourner le bois.

Figure Première



Poupée Servant à tourner le fer.

Figure Seconde



Echelle de 20 pouces



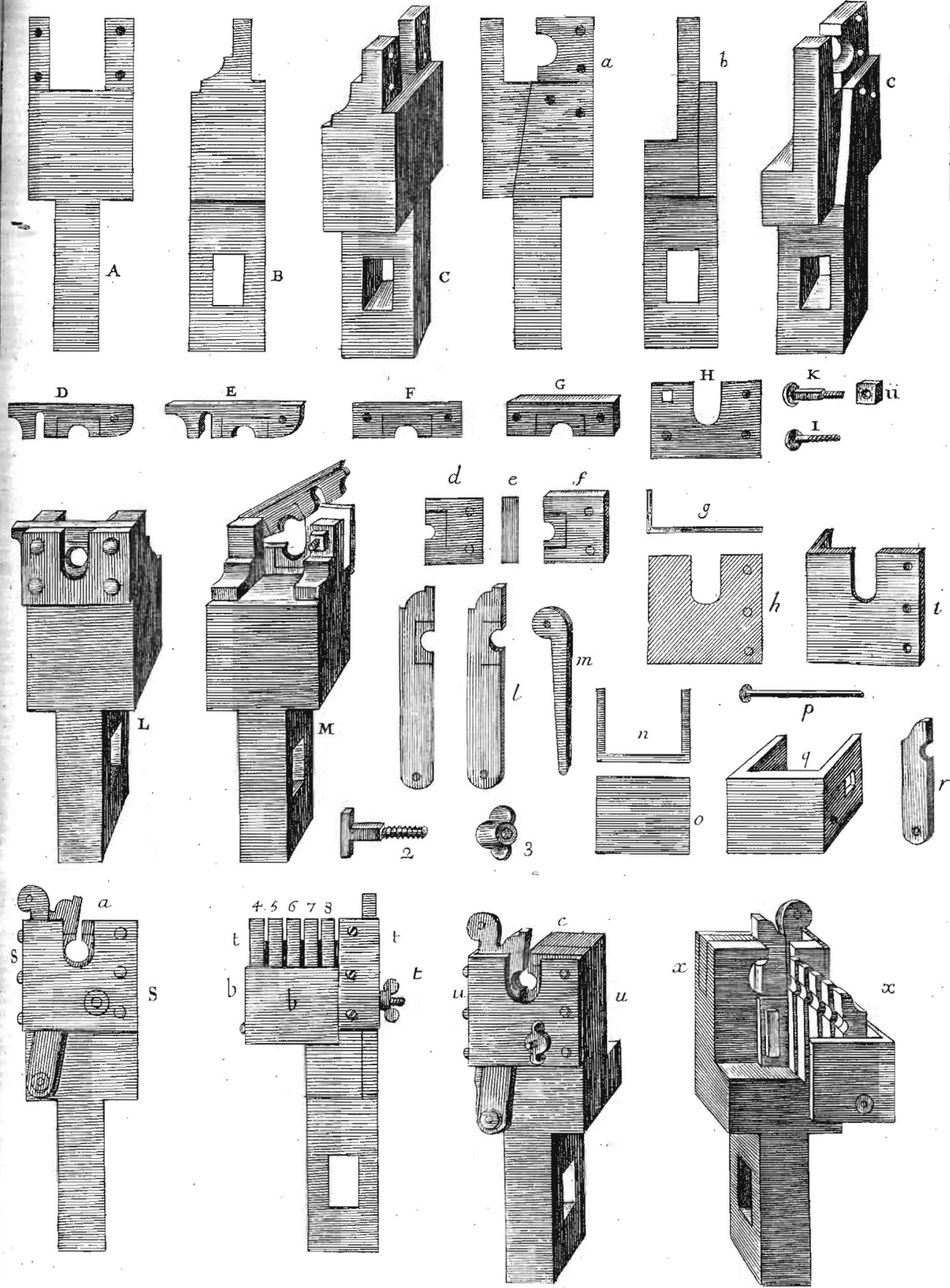


Figure premiere

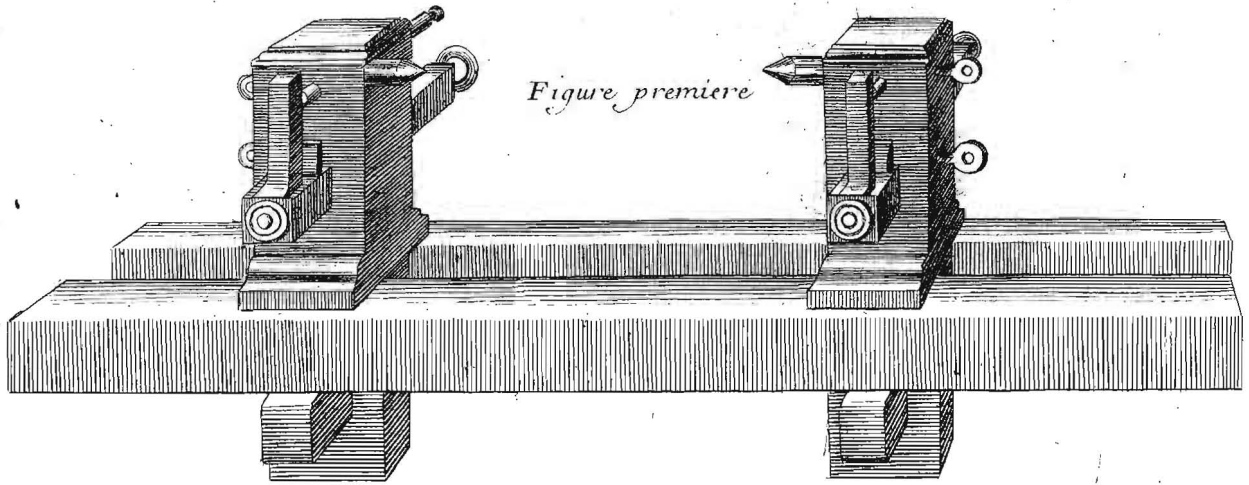


Figure Seconde

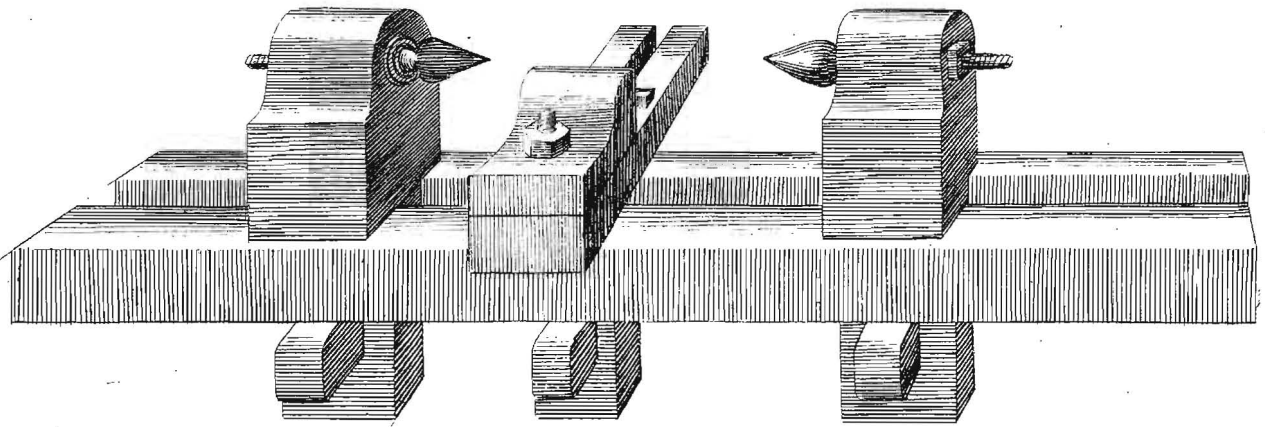
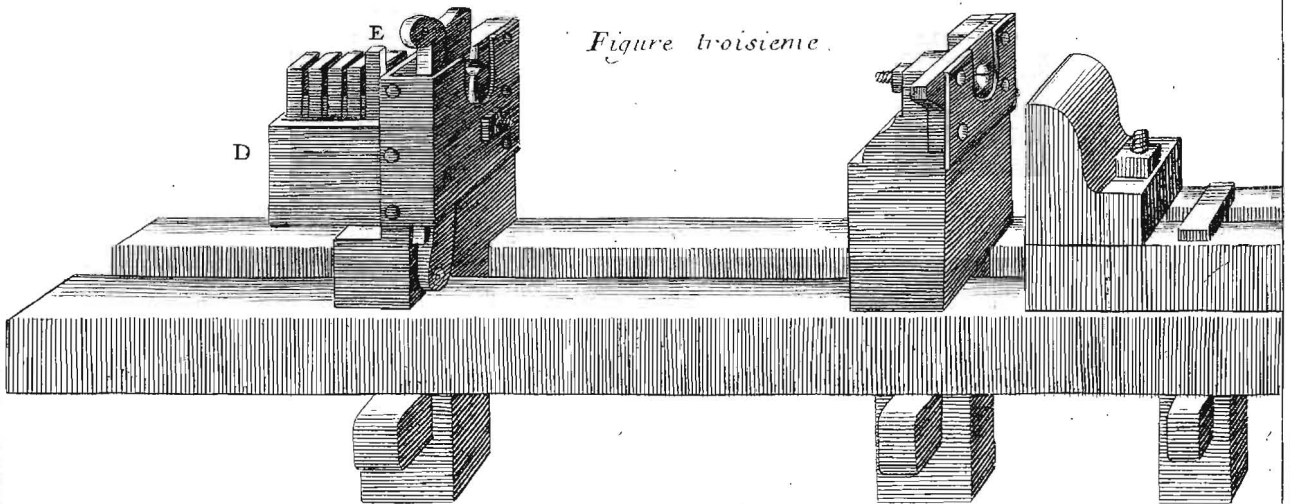


Figure troisieme

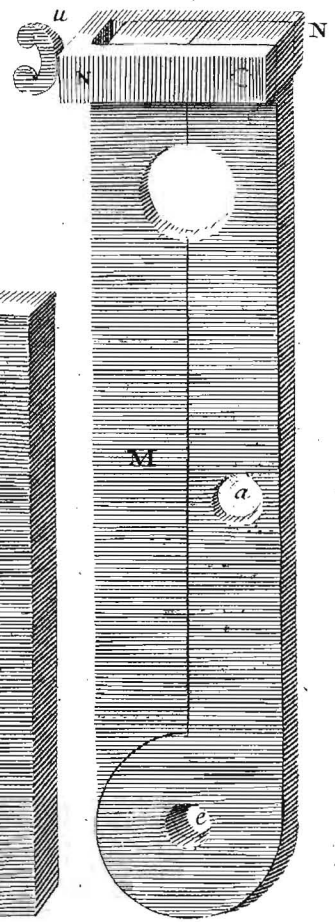
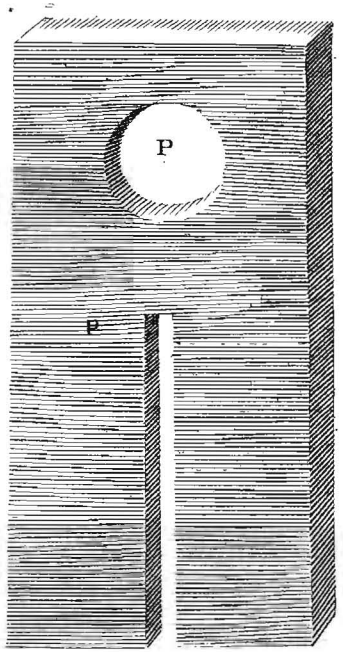
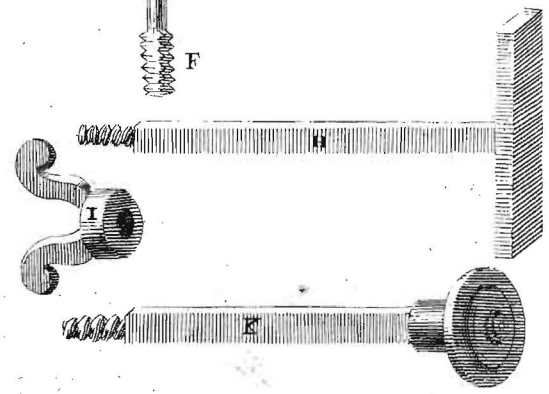
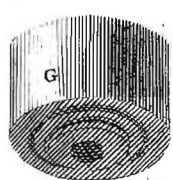
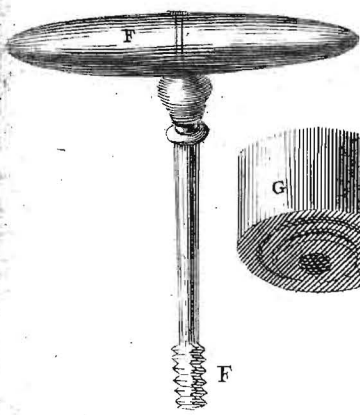
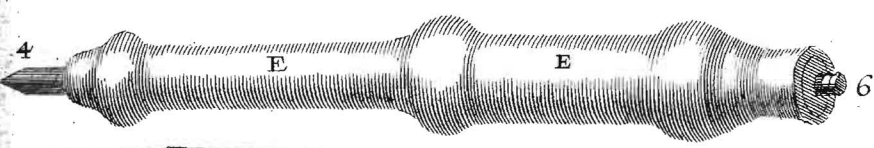
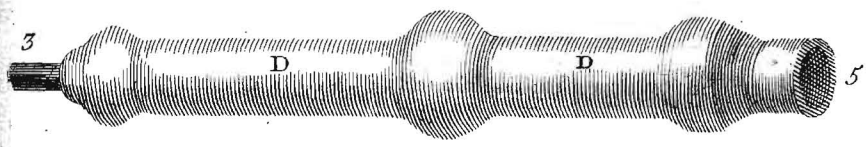
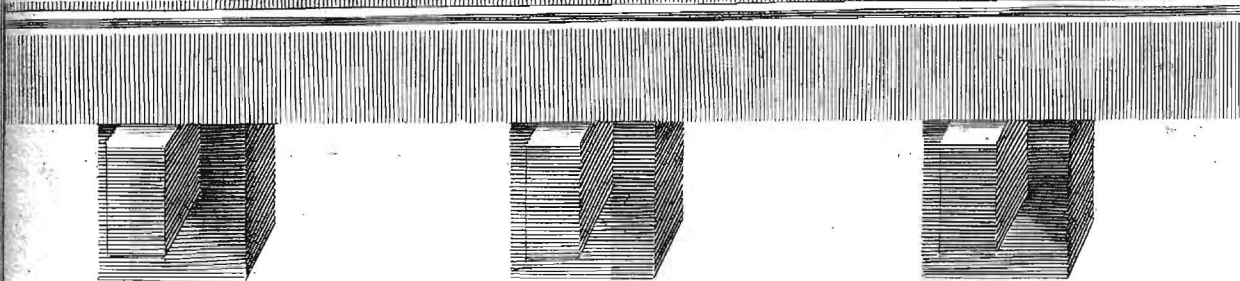
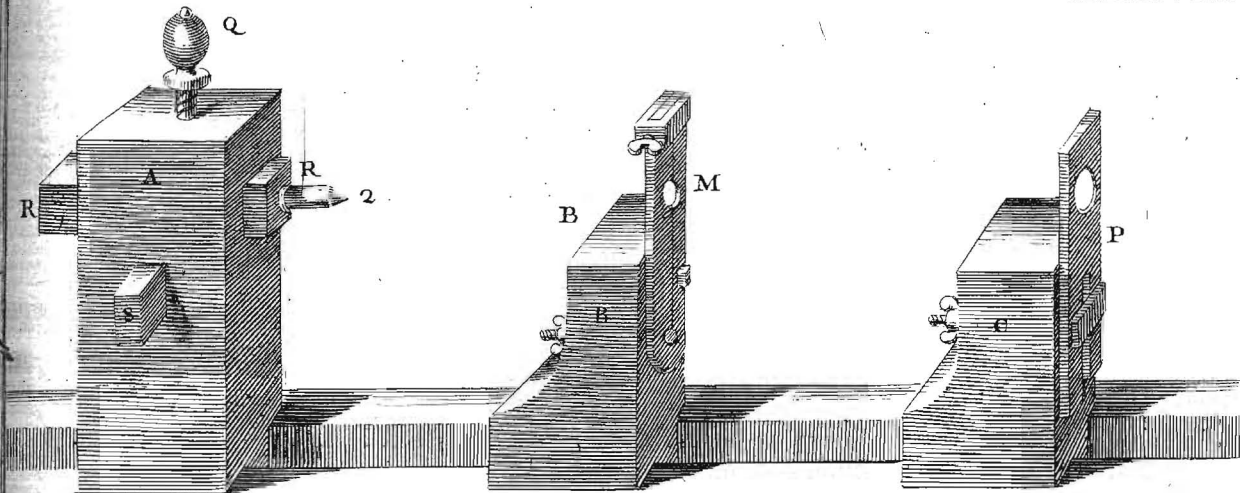


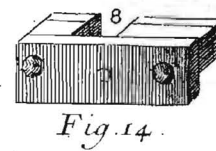
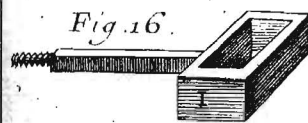
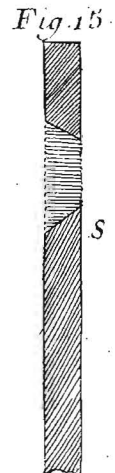
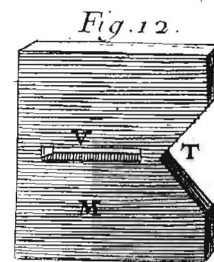
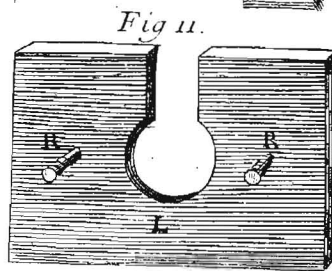
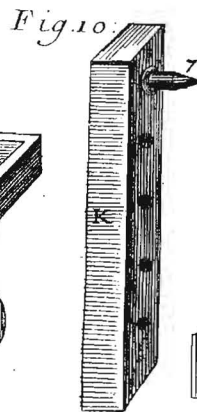
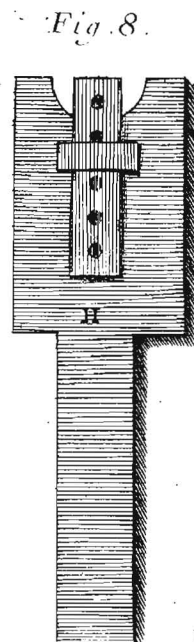
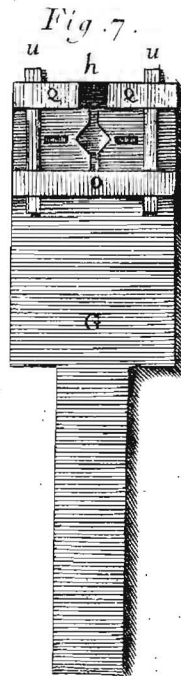
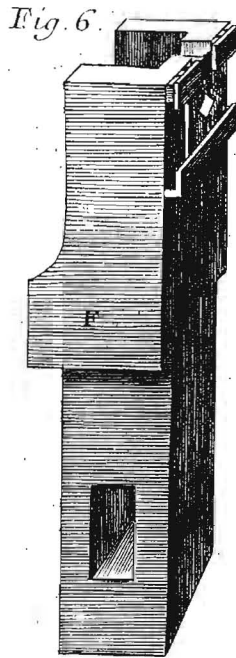
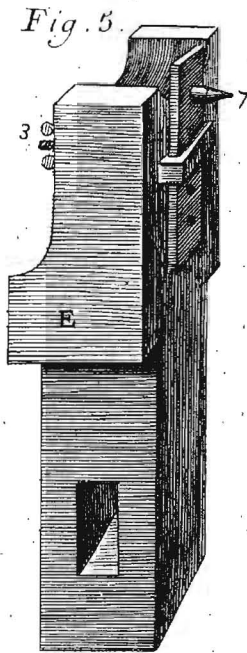
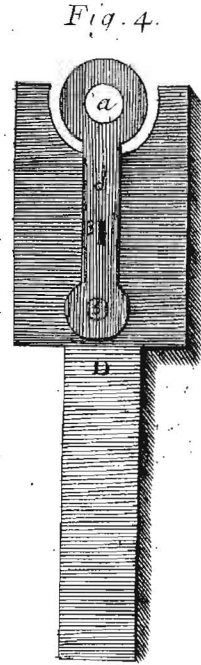
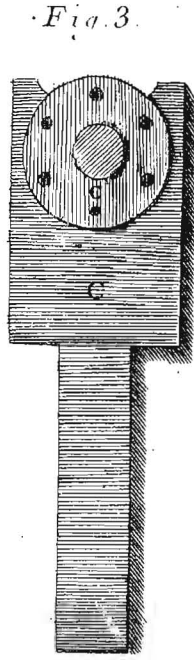
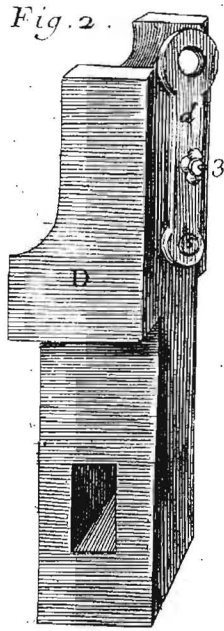
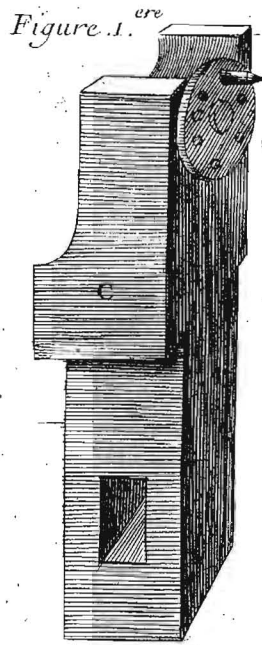
Echelle de 20 pouces



F. Carolus Plumier Minimus ..

N° 7







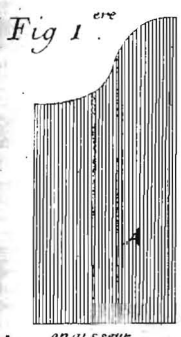


Fig. 1.

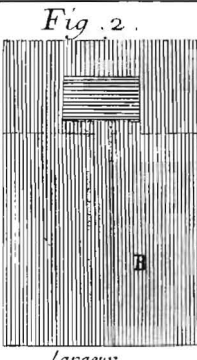


Fig. 2.

largeur

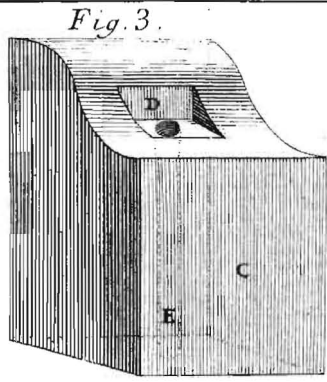


Fig. 3.

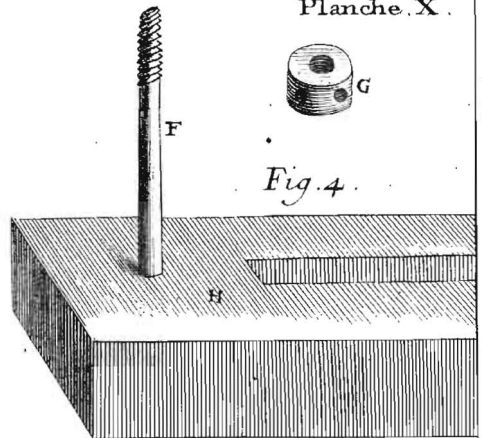


Fig. 4.

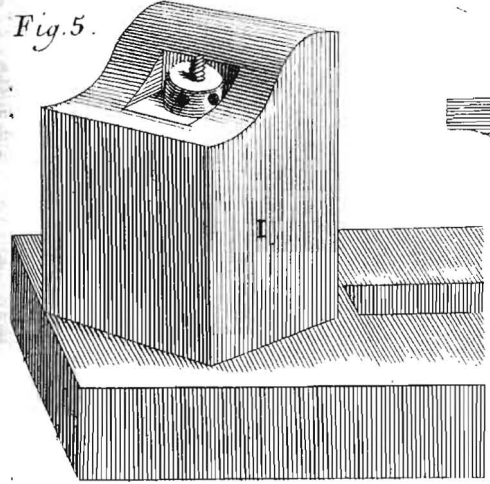


Fig. 5.

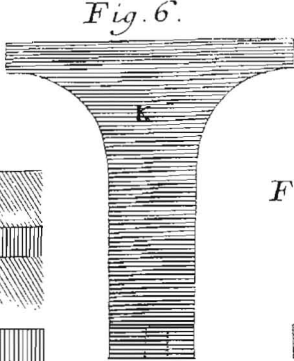


Fig. 6.

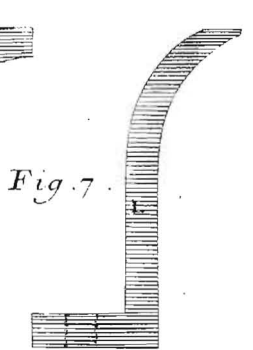


Fig. 7.

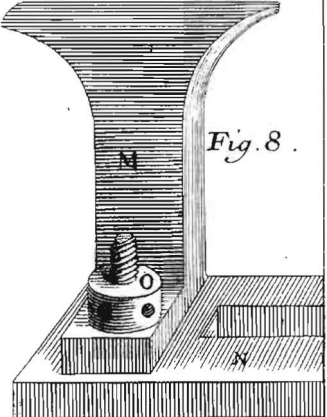


Fig. 8.

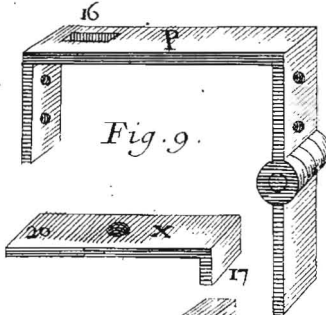


Fig. 9.

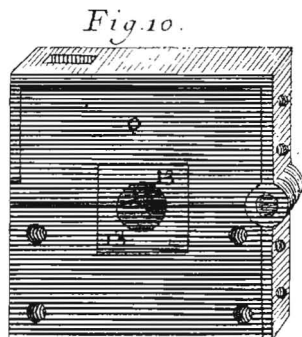


Fig. 10.

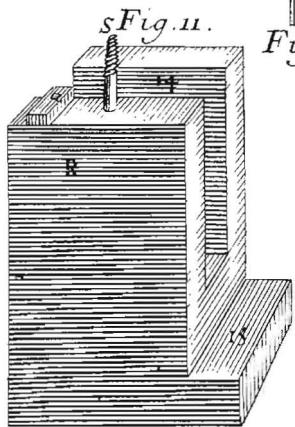


Fig. 11.

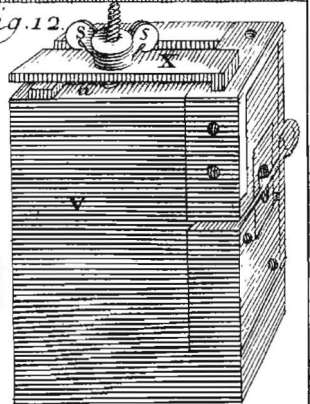


Fig. 12.

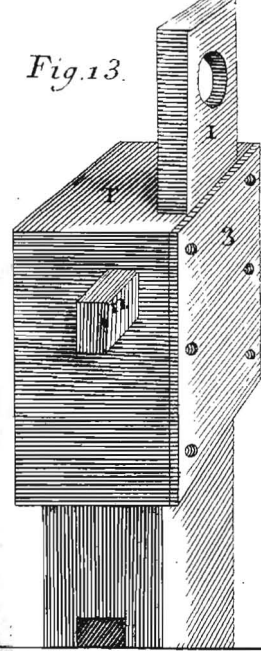


Fig. 13.

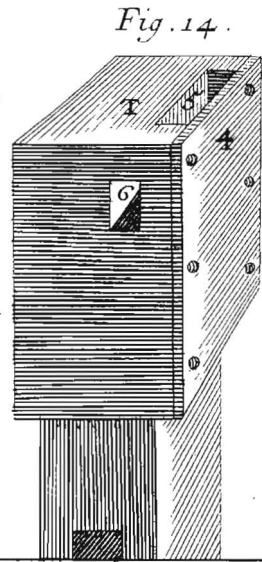


Fig. 14.

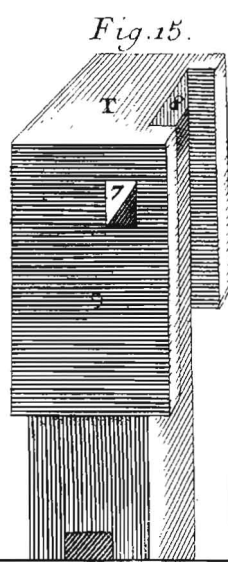


Fig. 15.

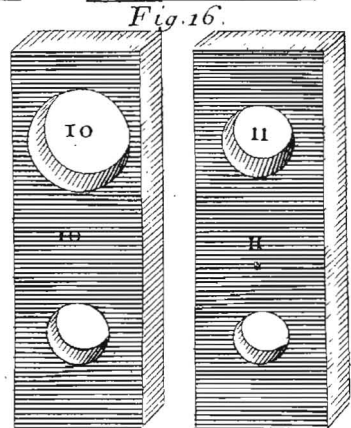


Fig. 16.

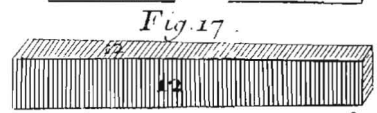
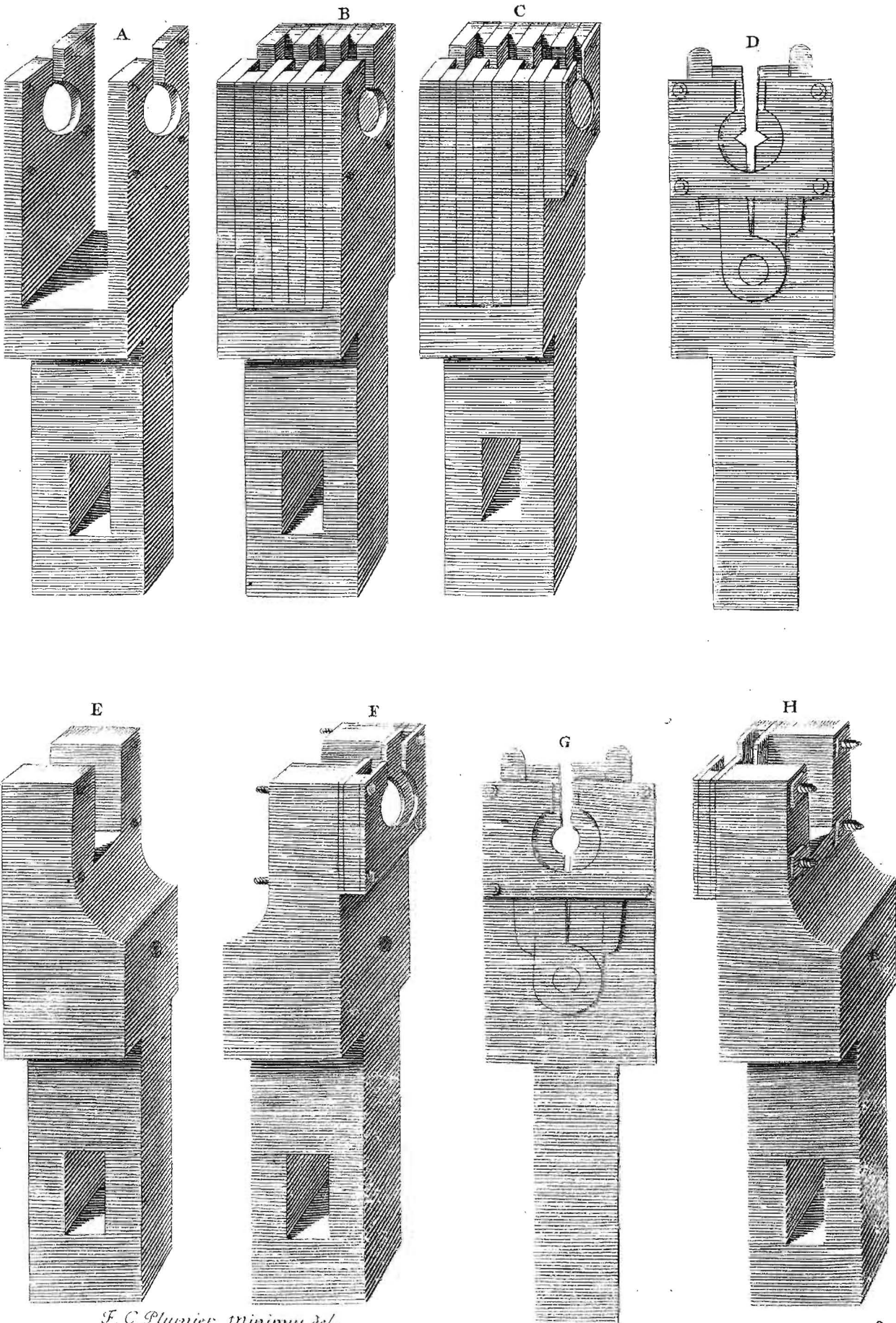


Fig. 17.



F. C. Pluvier Minimus del.

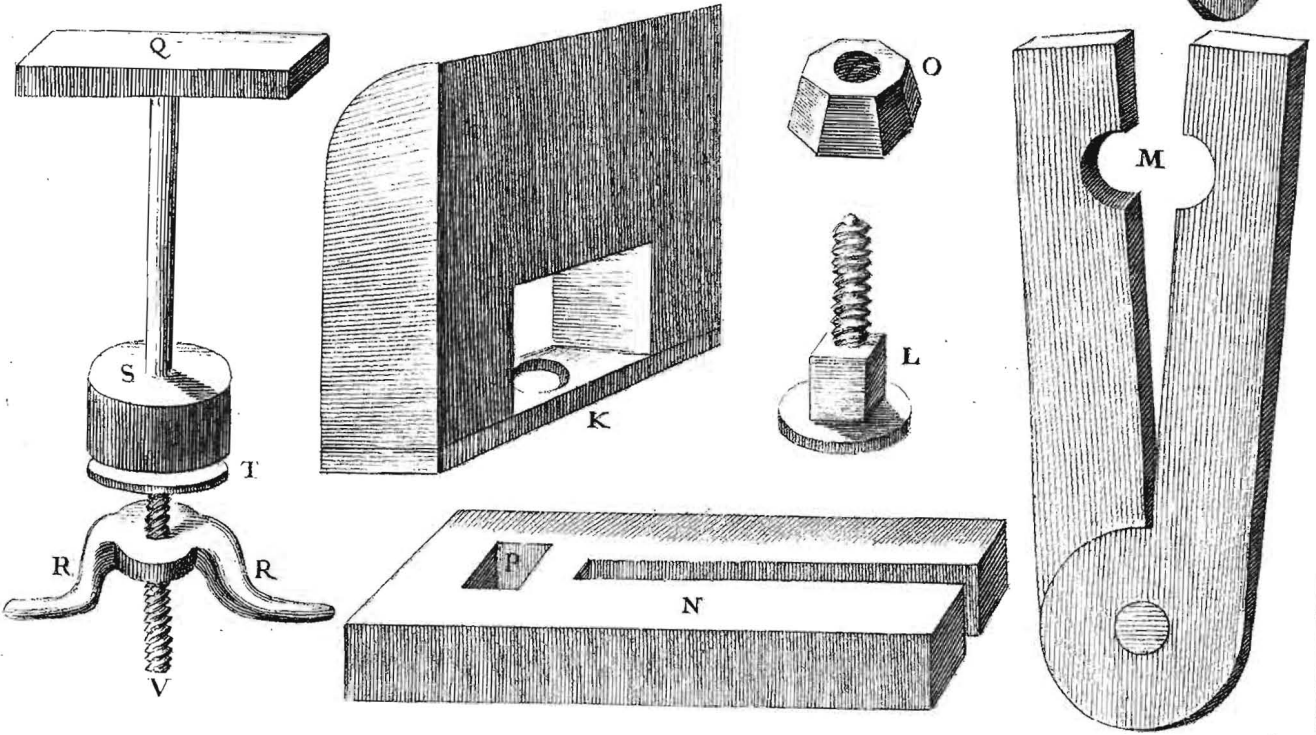
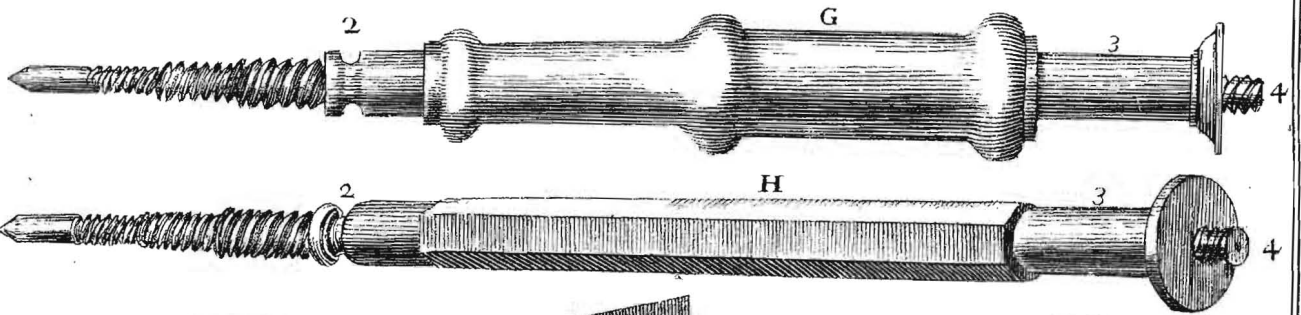
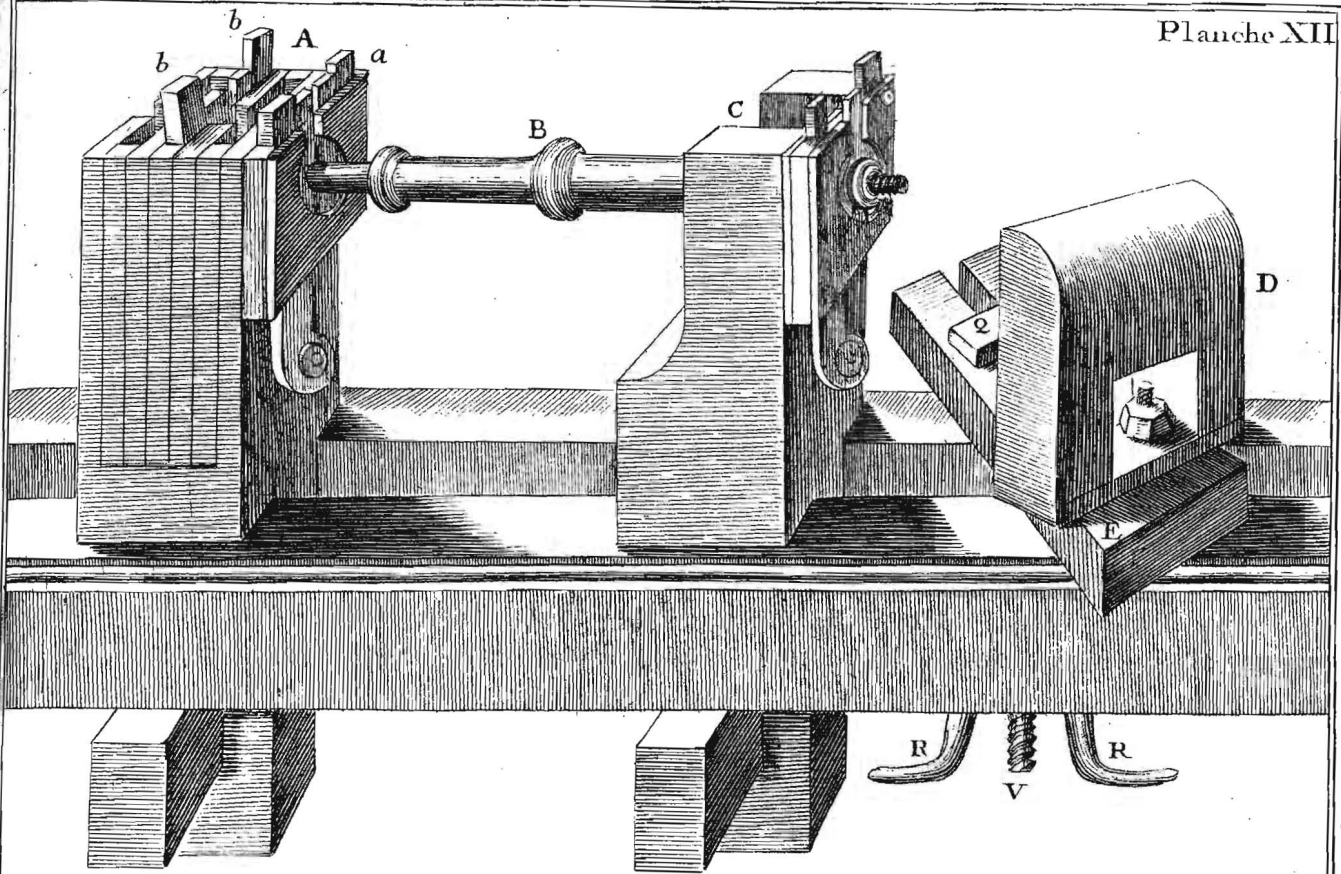


Figure premiere.

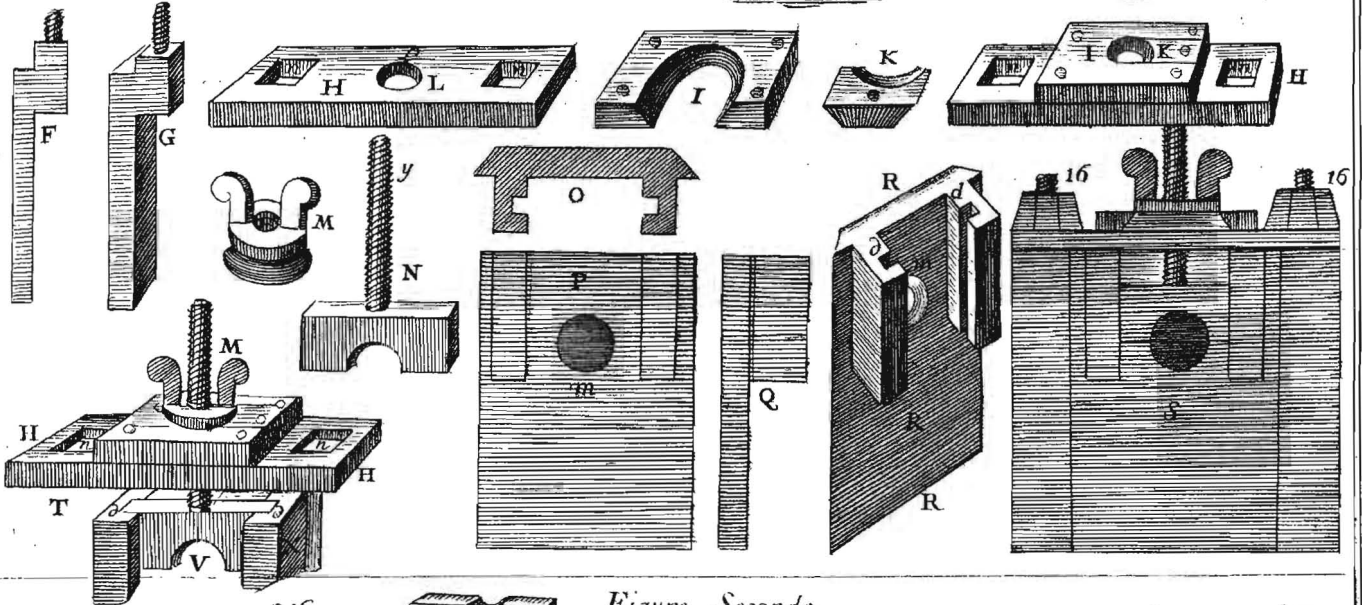
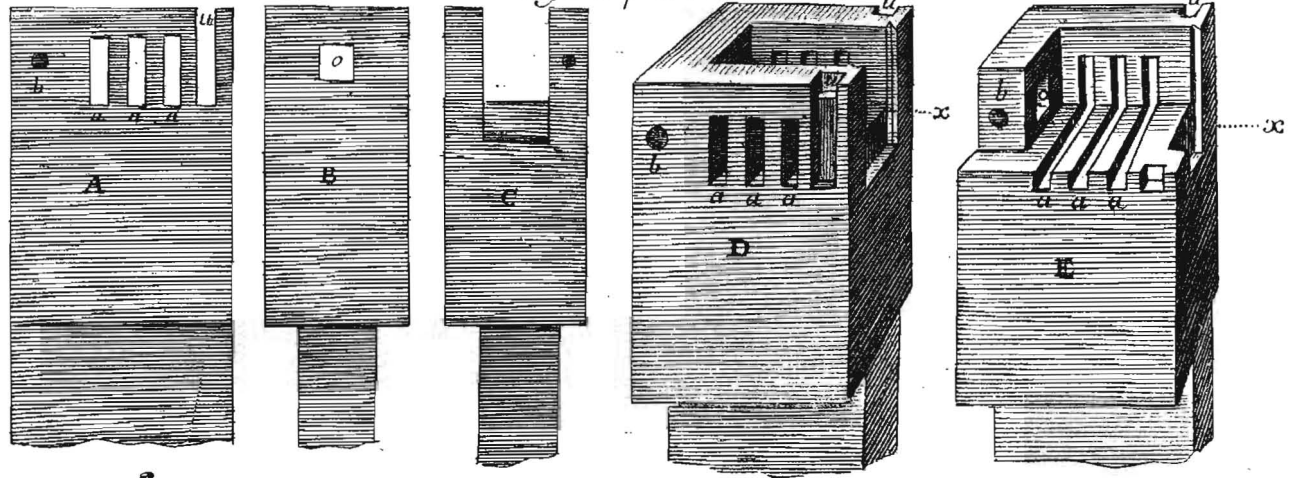
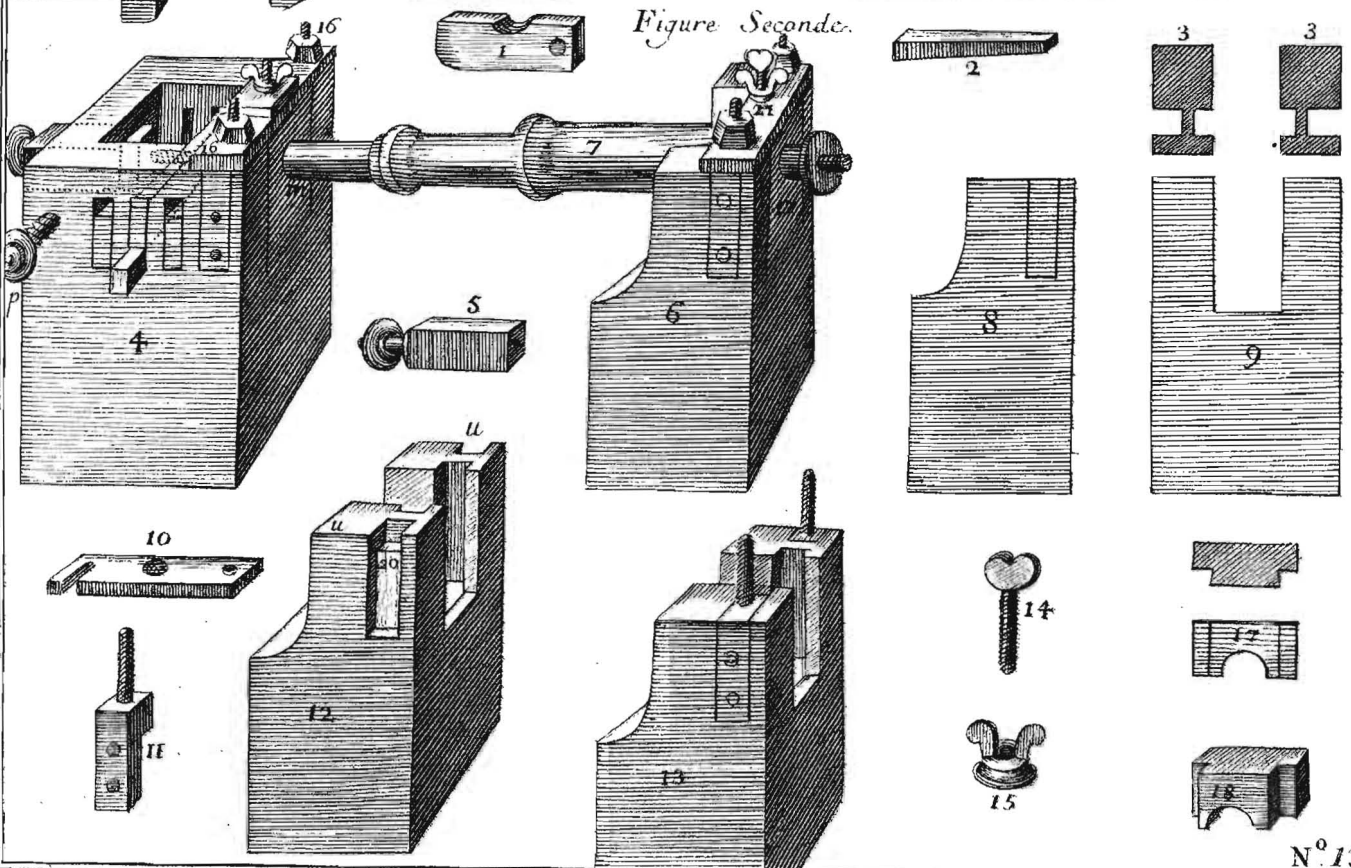
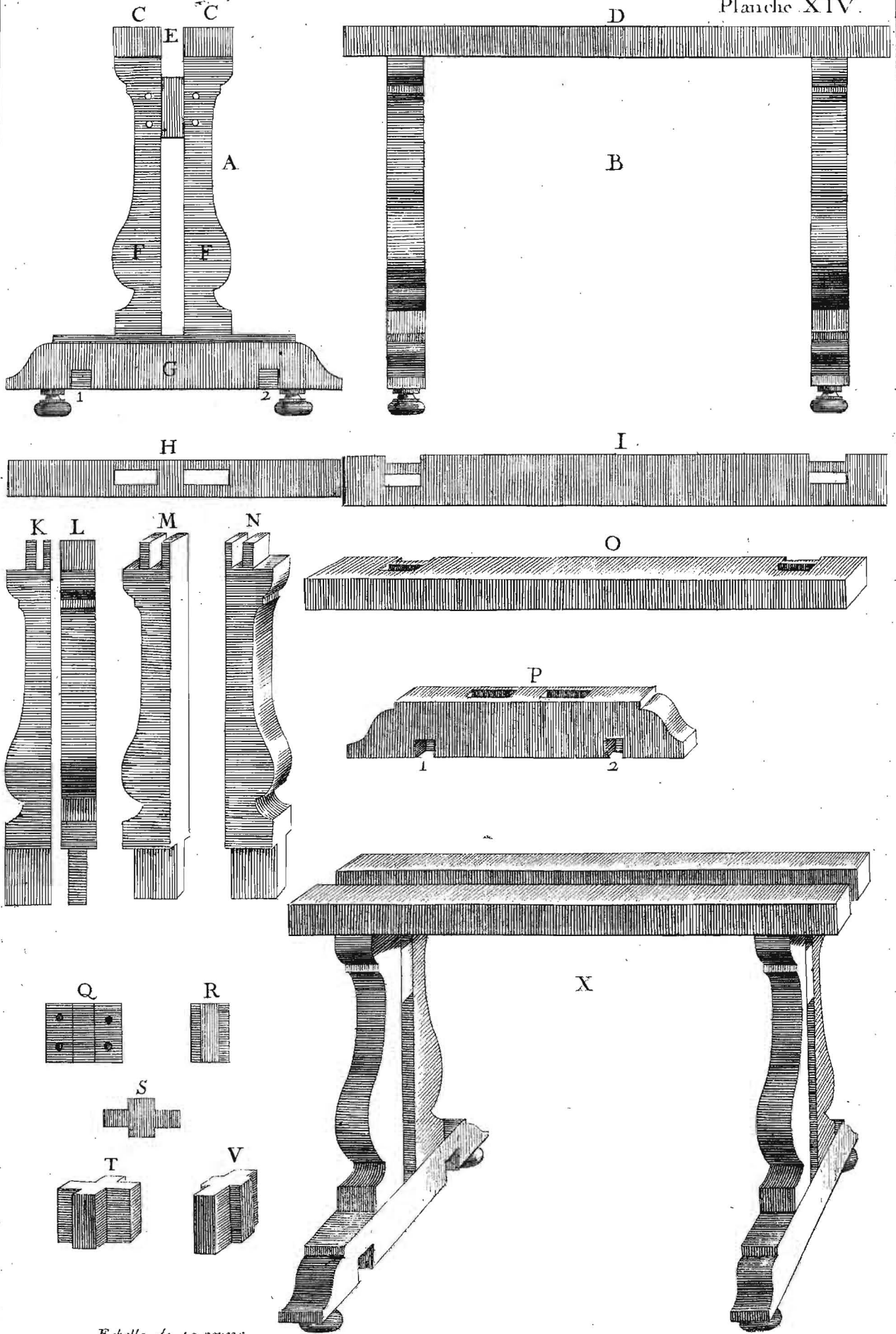
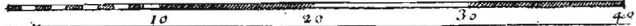


Figure Seconde.

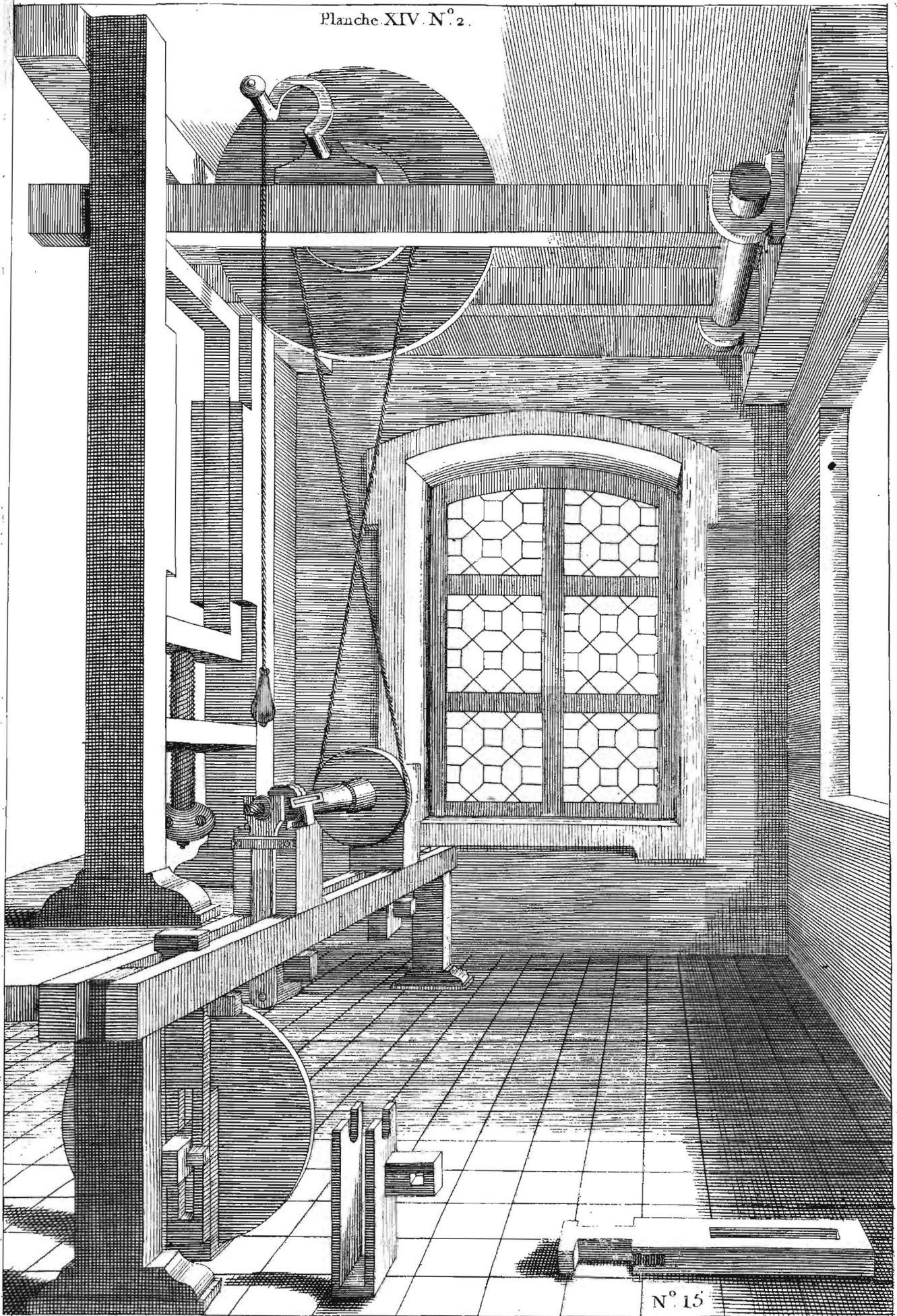


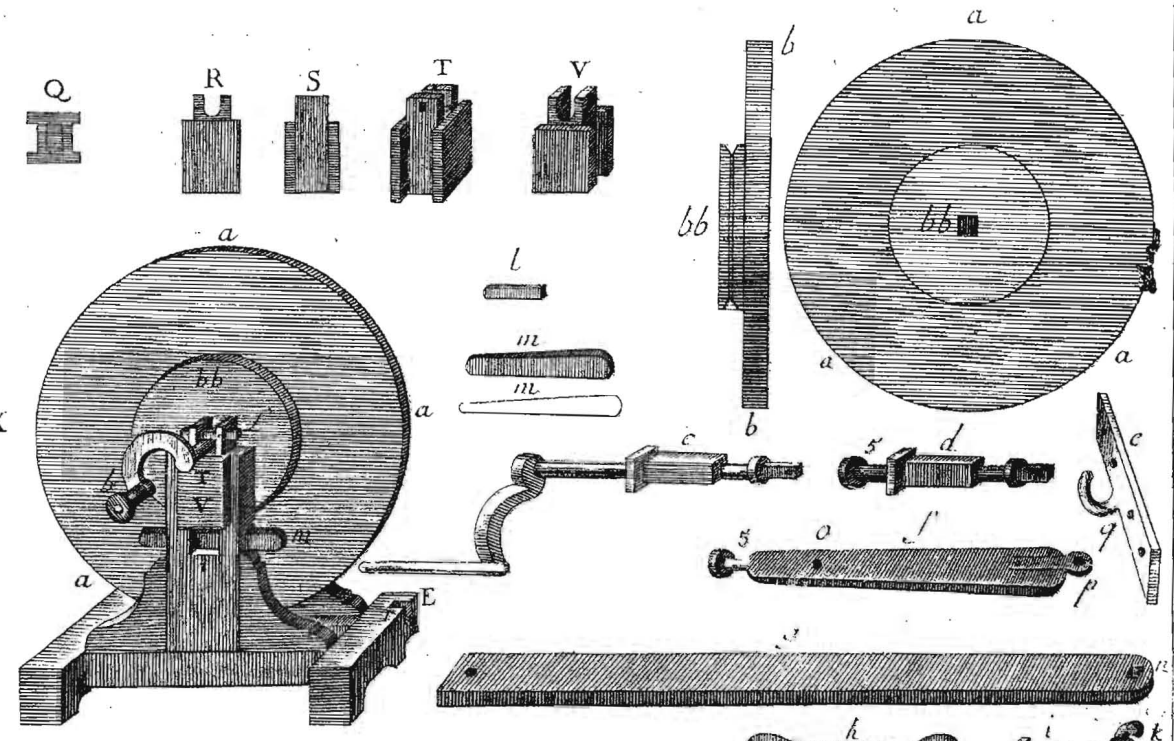
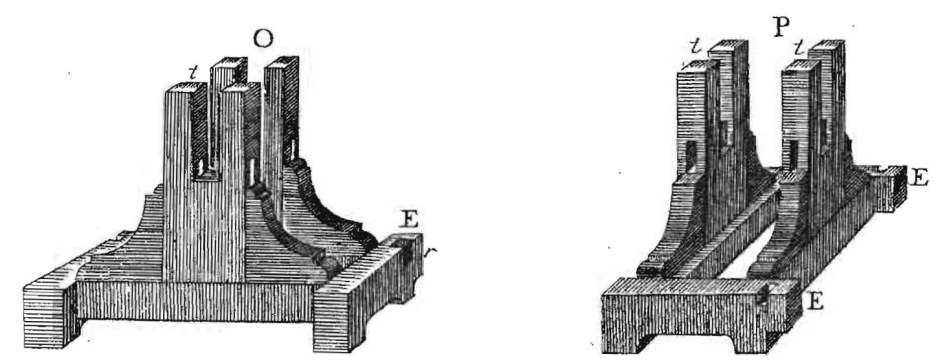
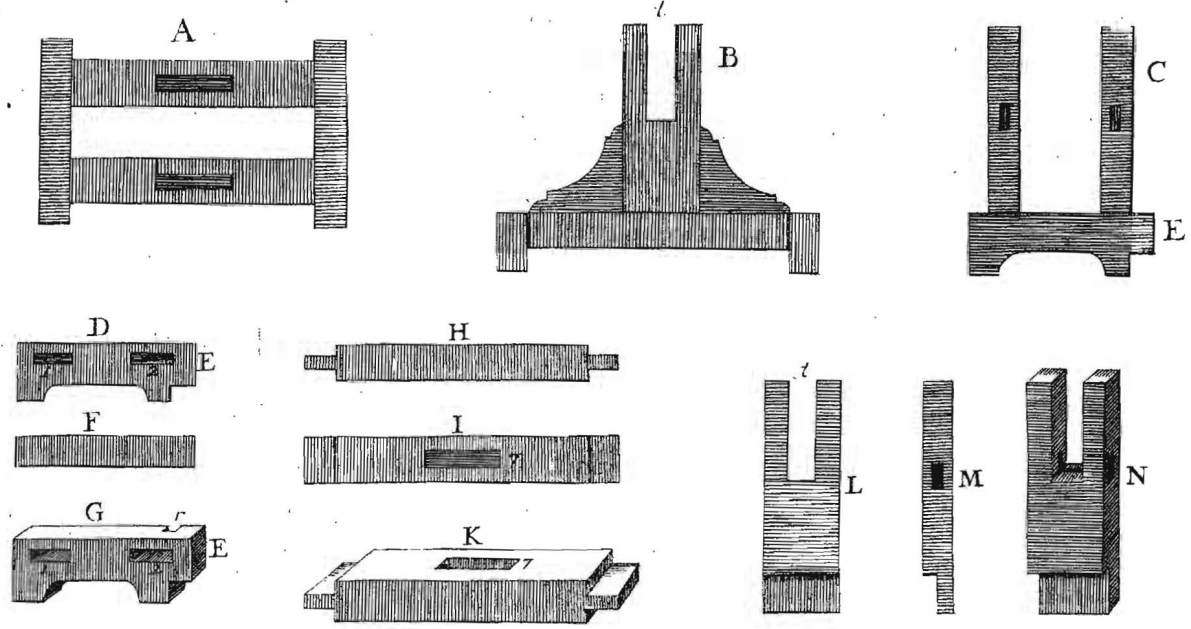


Echelle de 40 pouces.

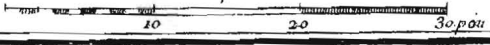


P. Castus planicus Minimus delin.

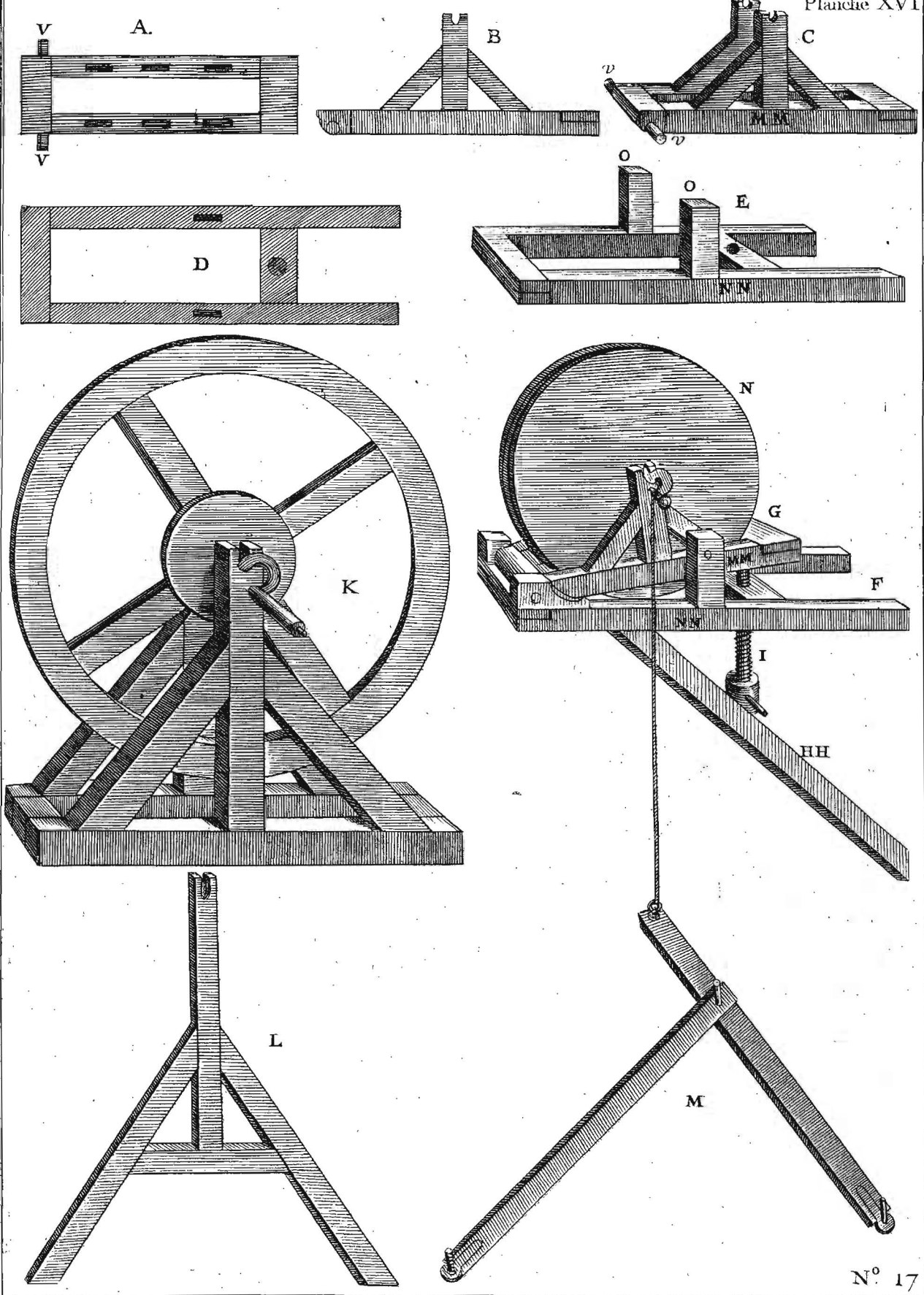




Echelle de 30 pouces.



plumier d'Aluminium Selin. N° 16





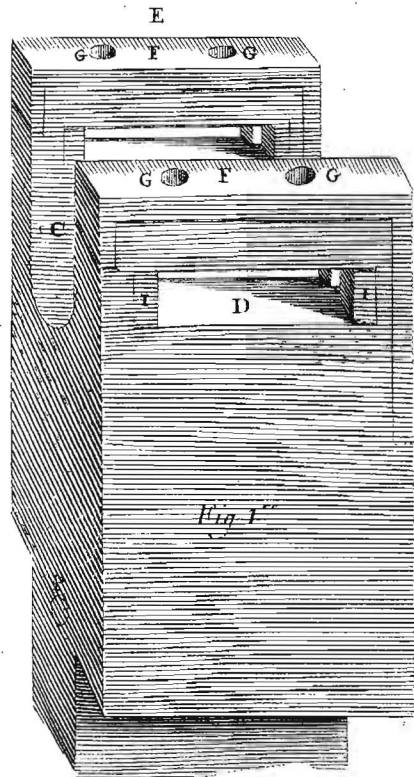


Fig. 1.

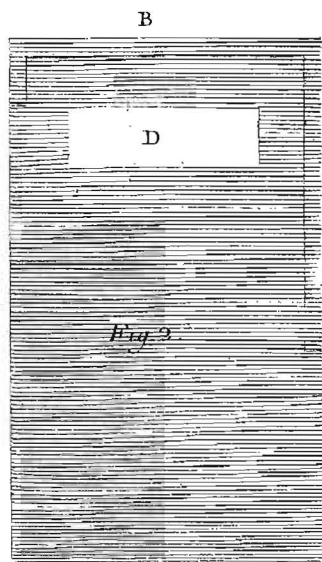


Fig. 2.

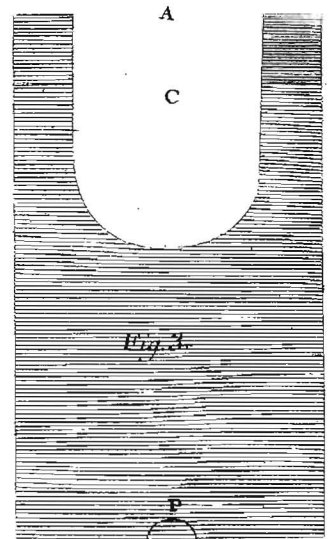


Fig. 3.

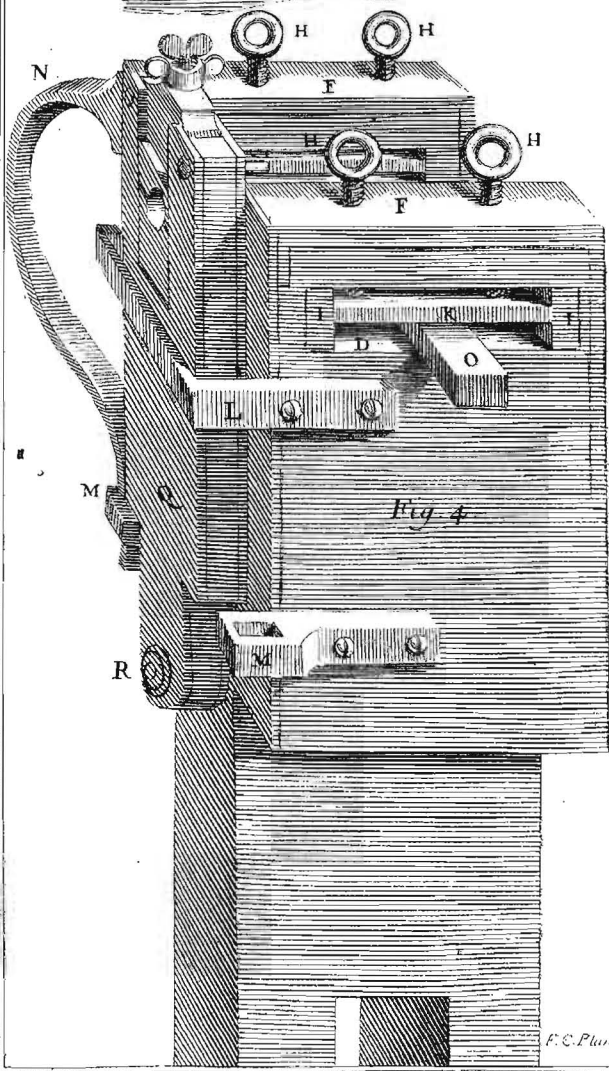


Fig. 4.

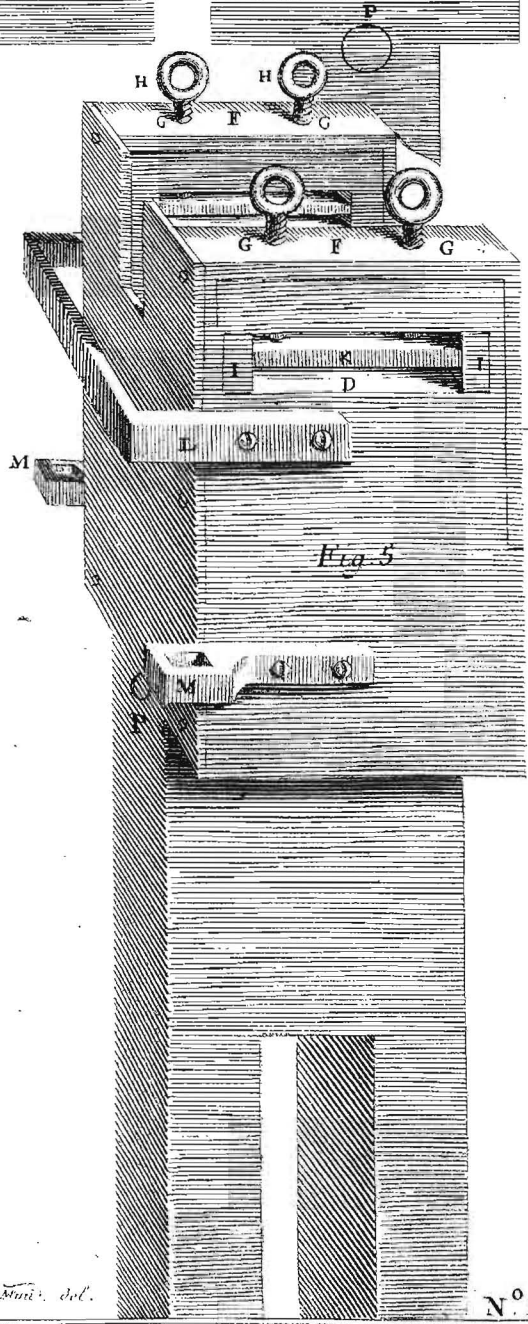
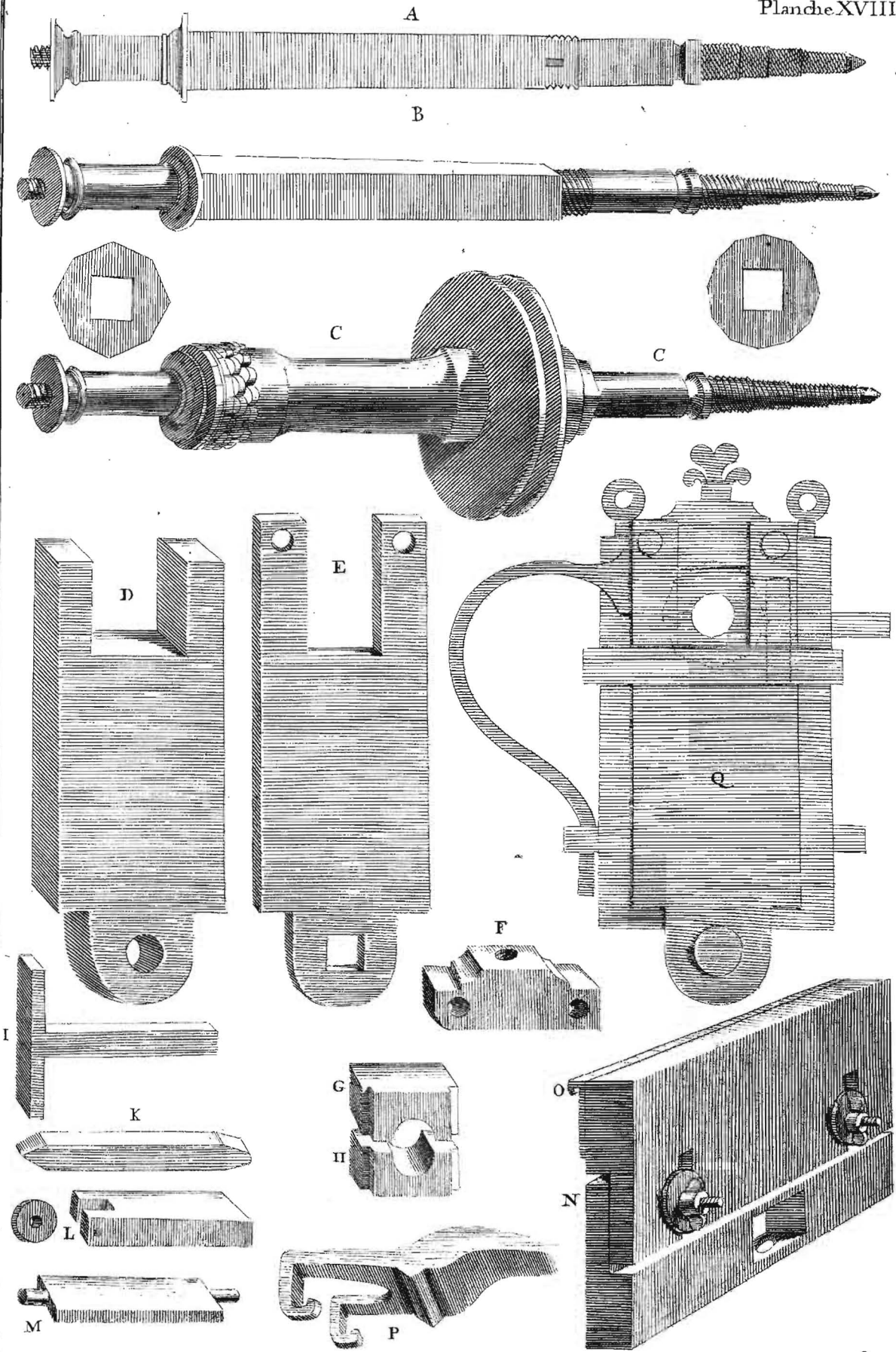
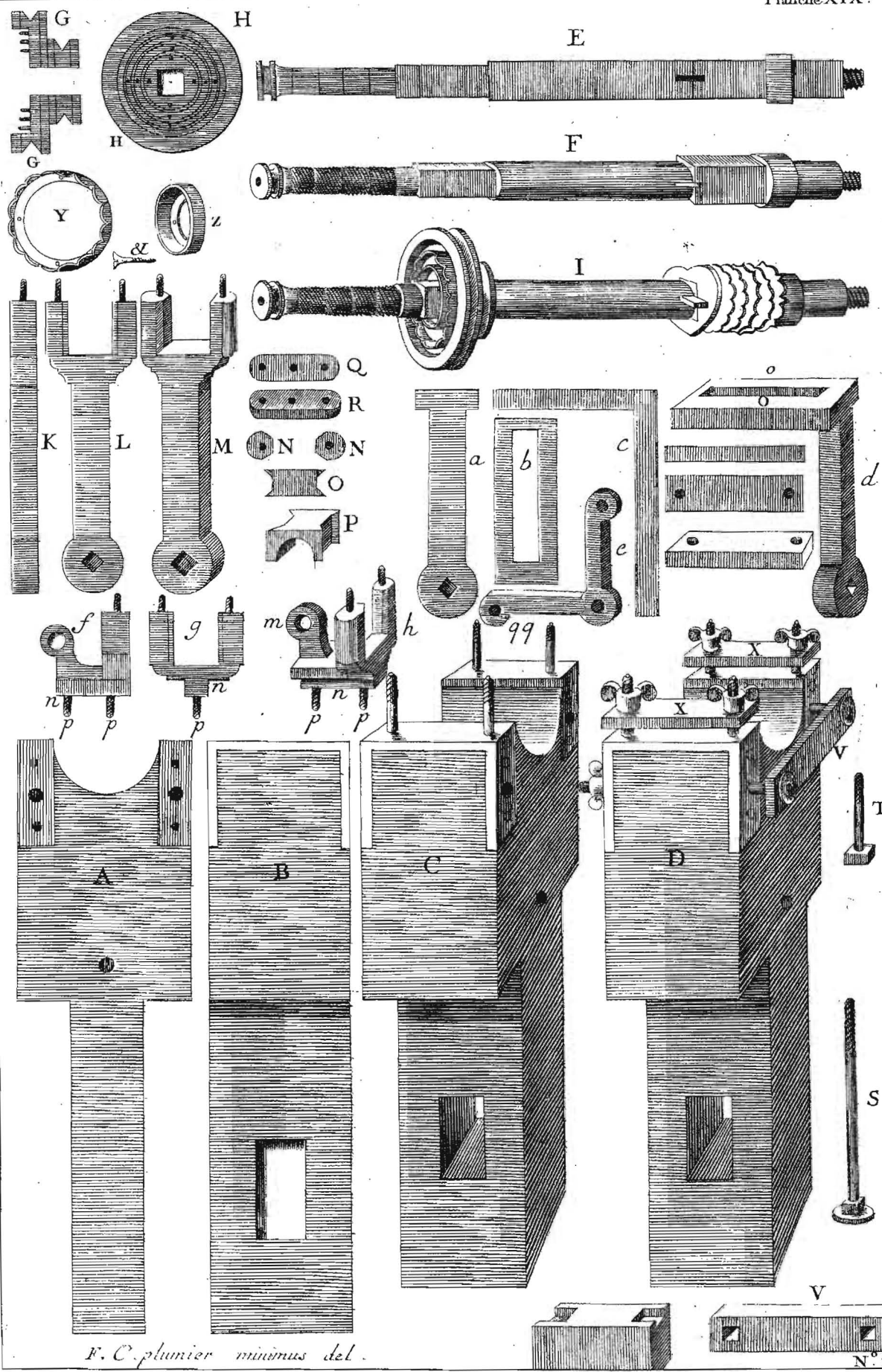
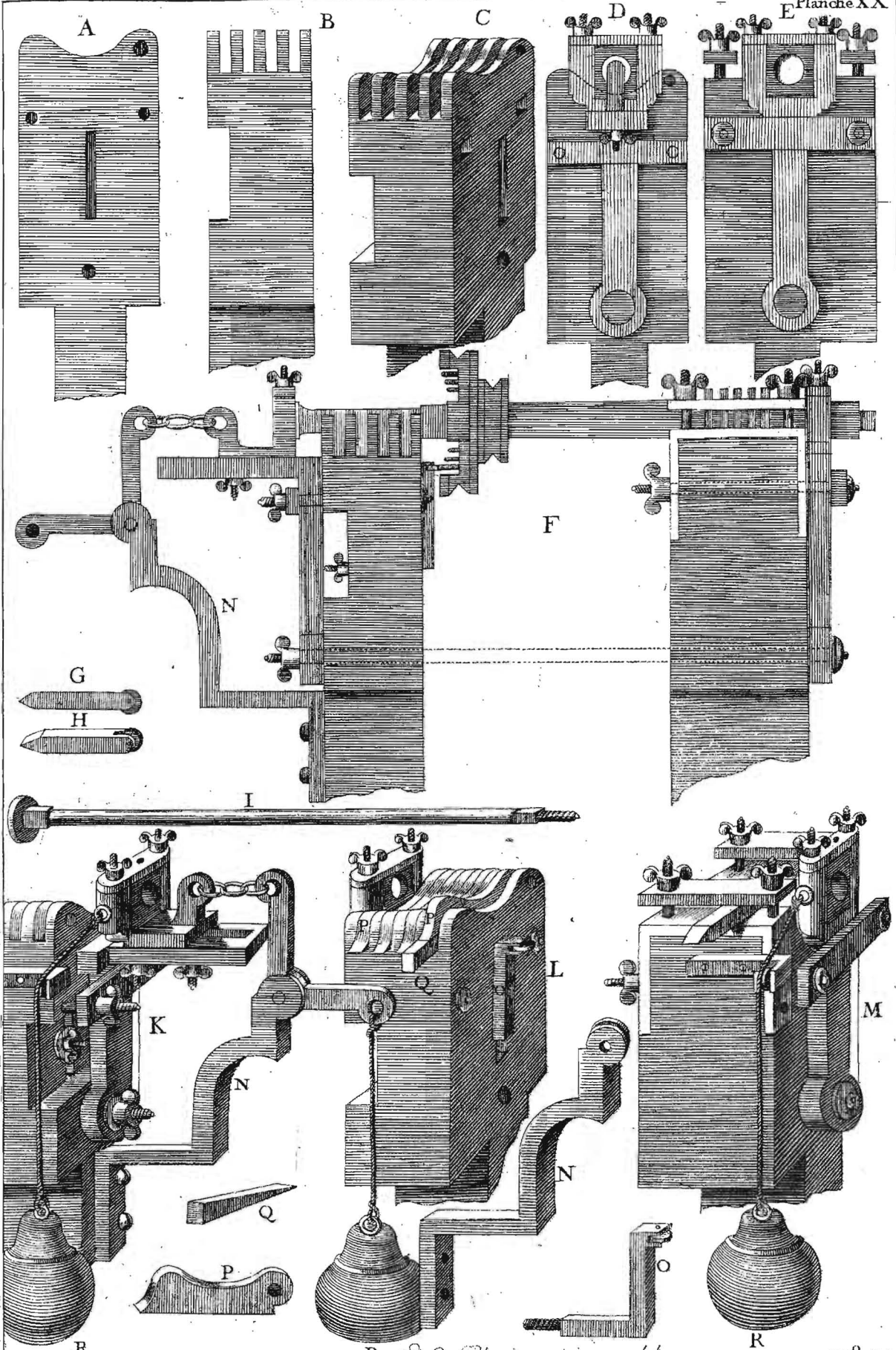


Fig. 5.

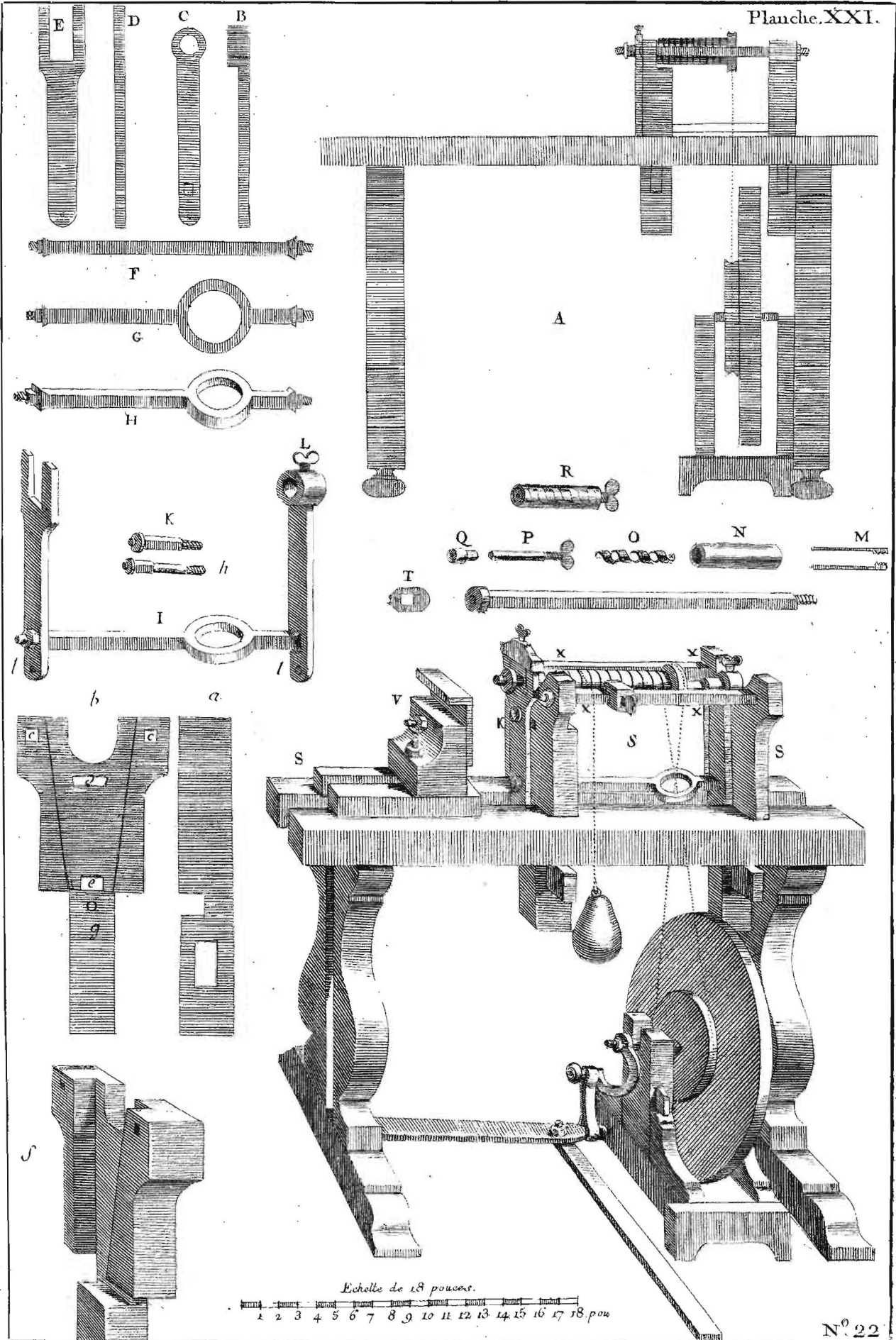




F. C. plumier minimus del.

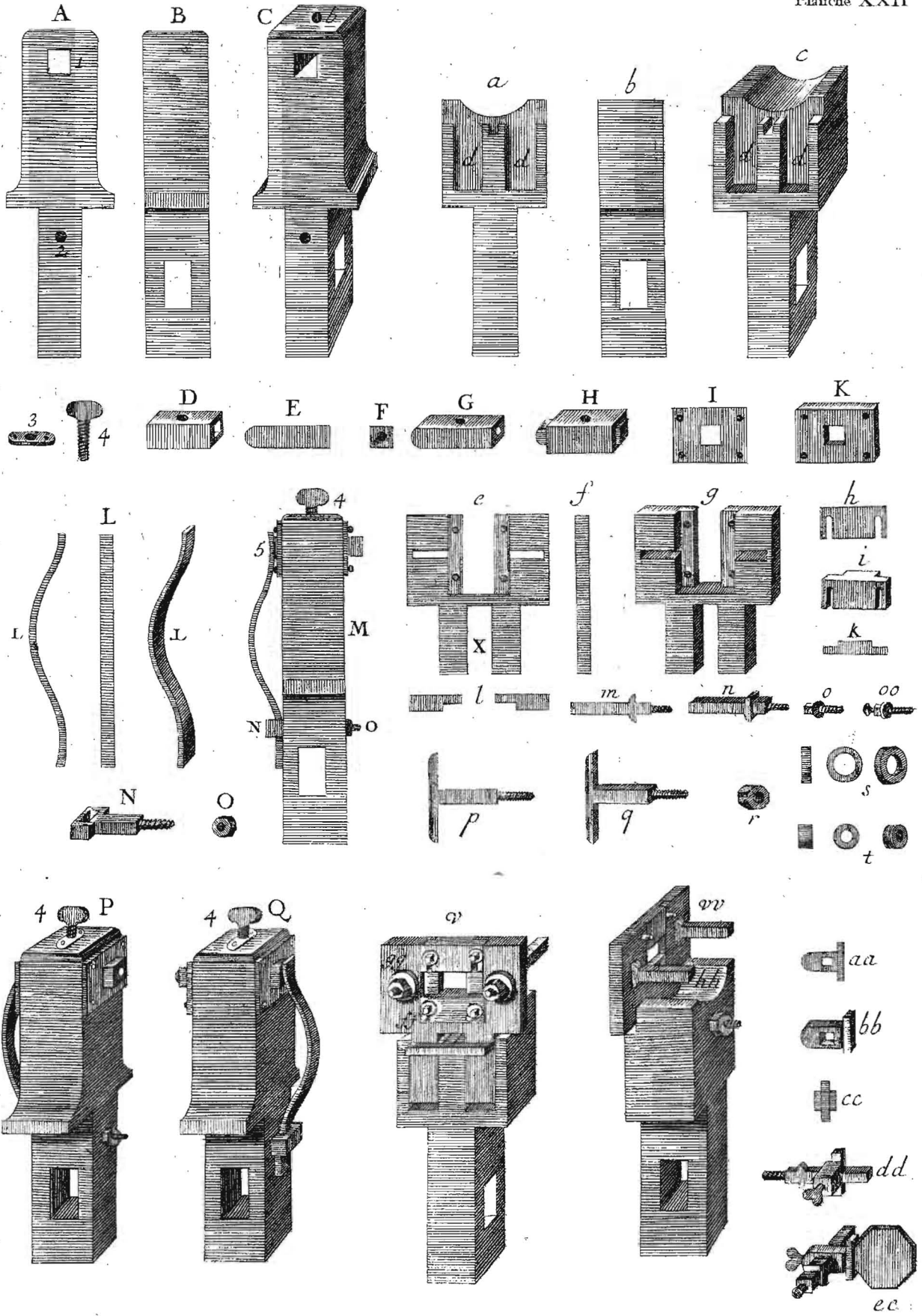


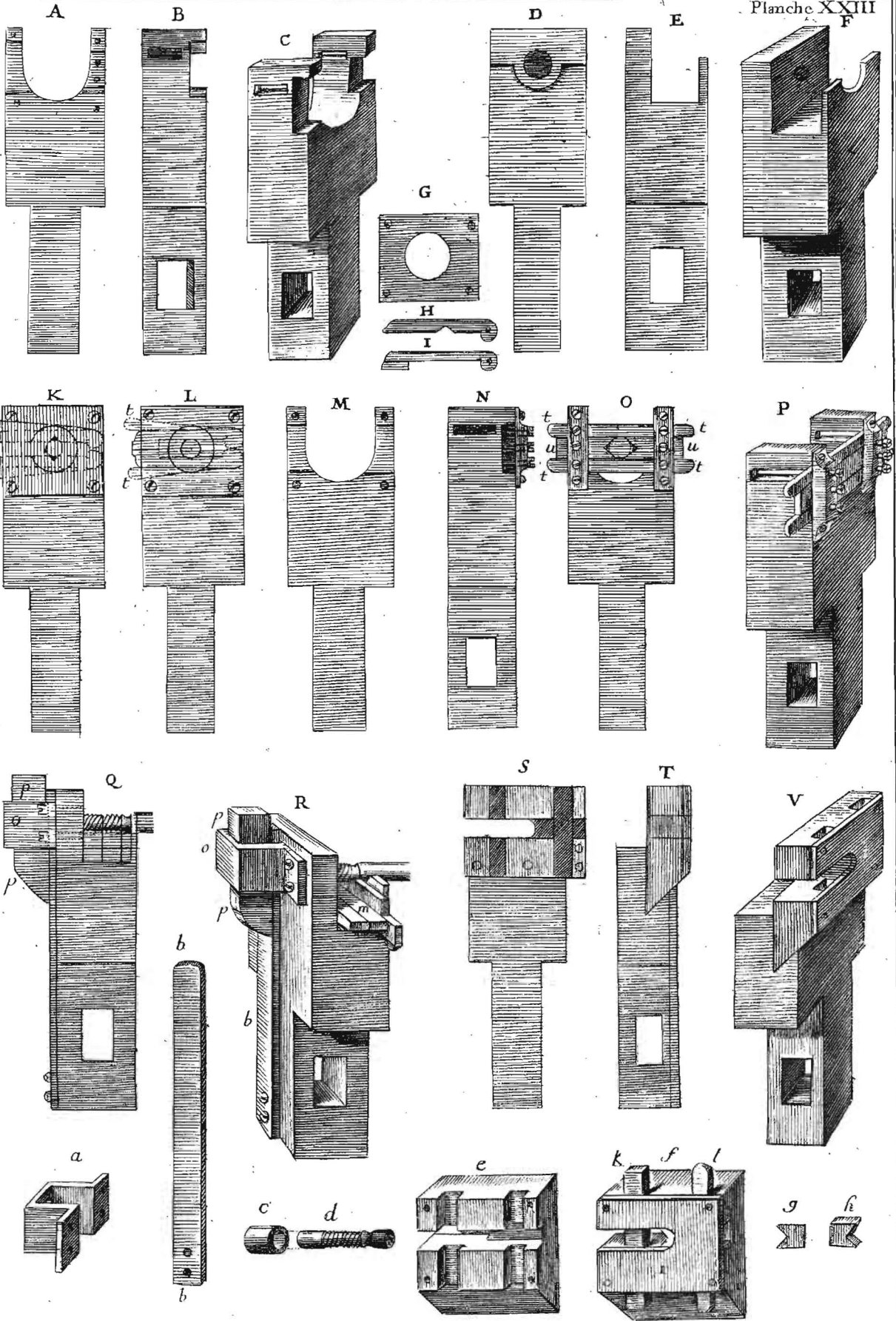
R P.C. Plumier minus del.



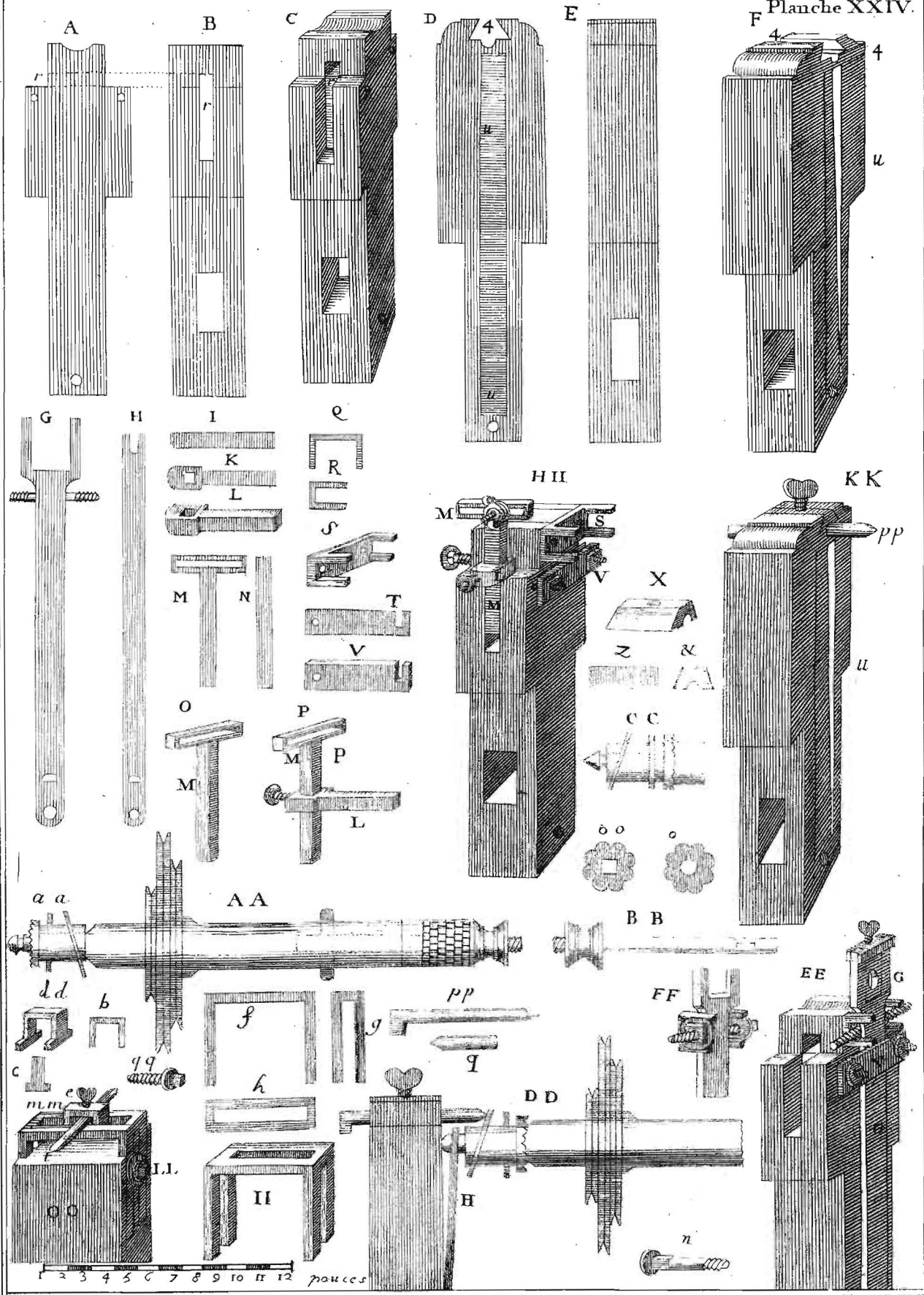
Echelle de 18 pouces.

1 2 3 4 5 6 7 8 9 10 11 12 13 14 15 16 17 18 pou

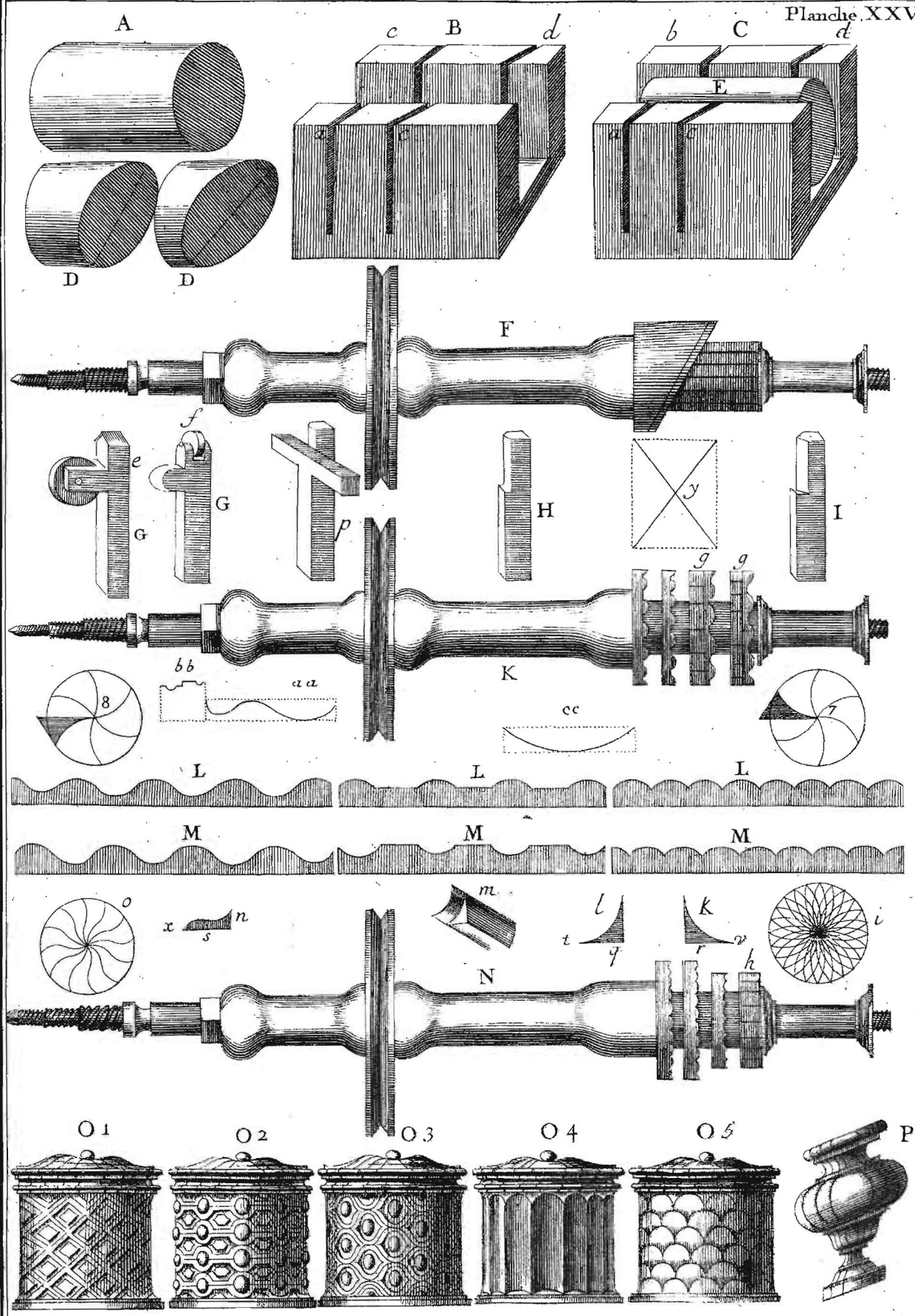


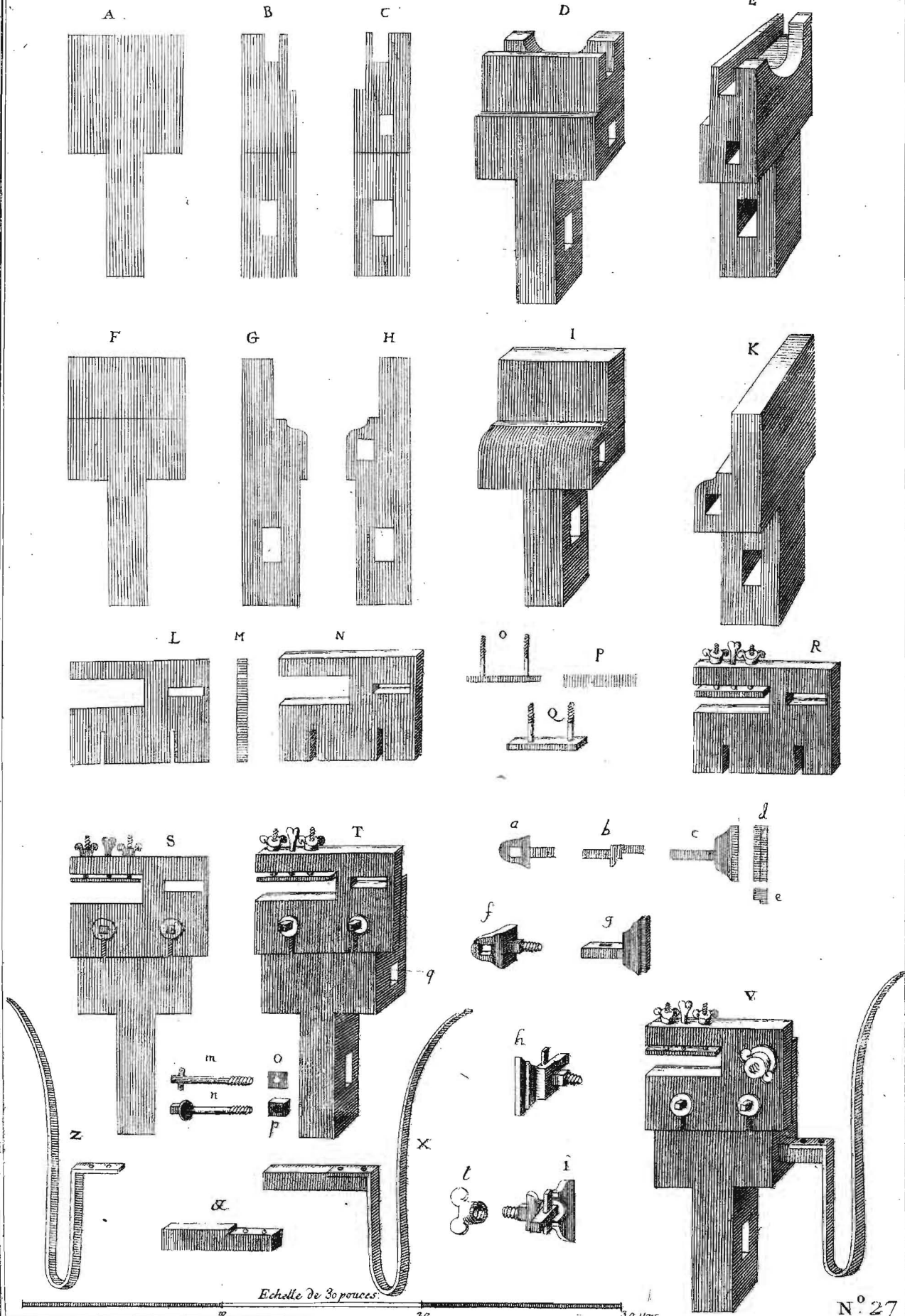


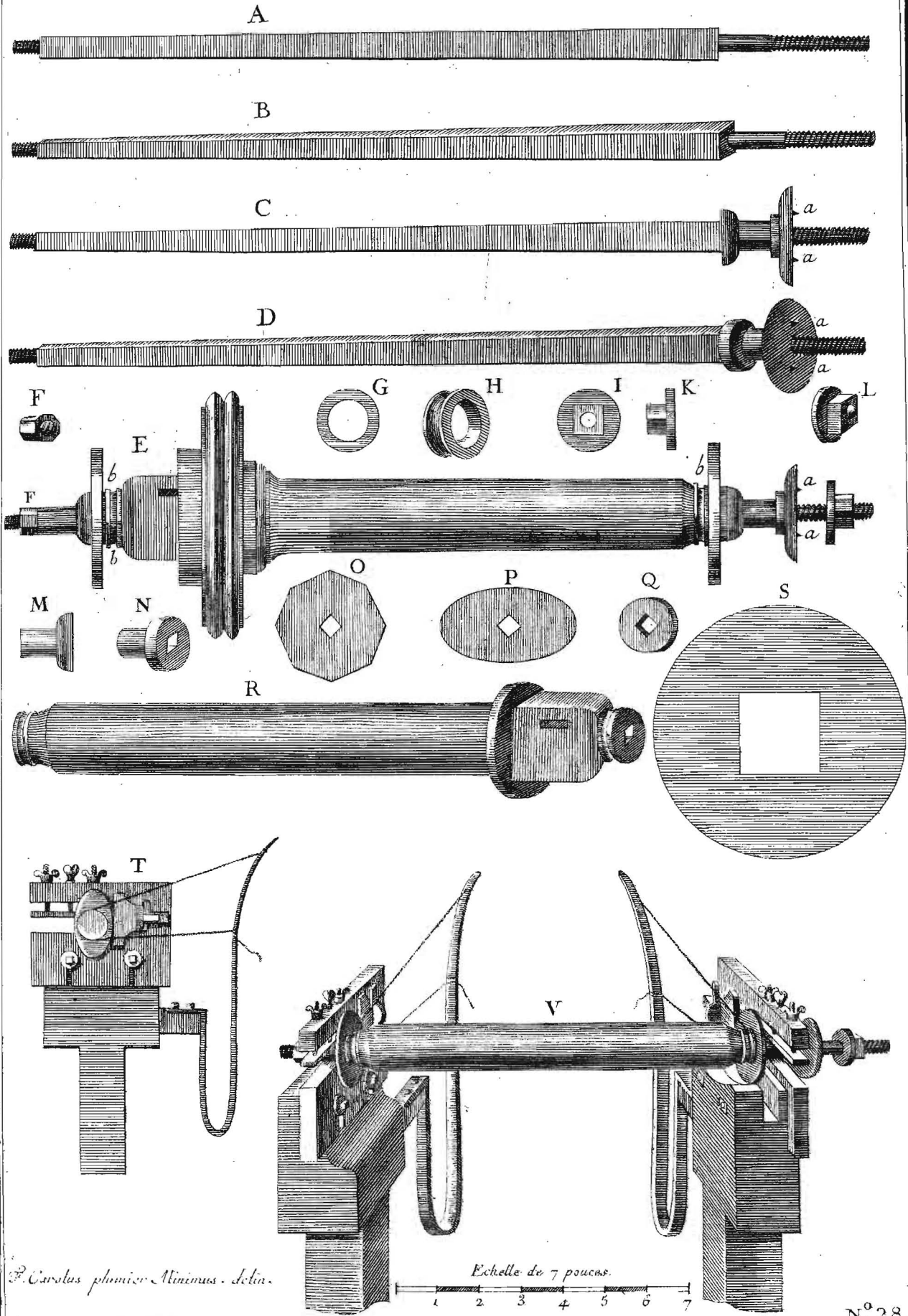
1. pied.  
 1 2 3 4 5 6 7 8 9 10 11 12. pouces  
 2. pieds.









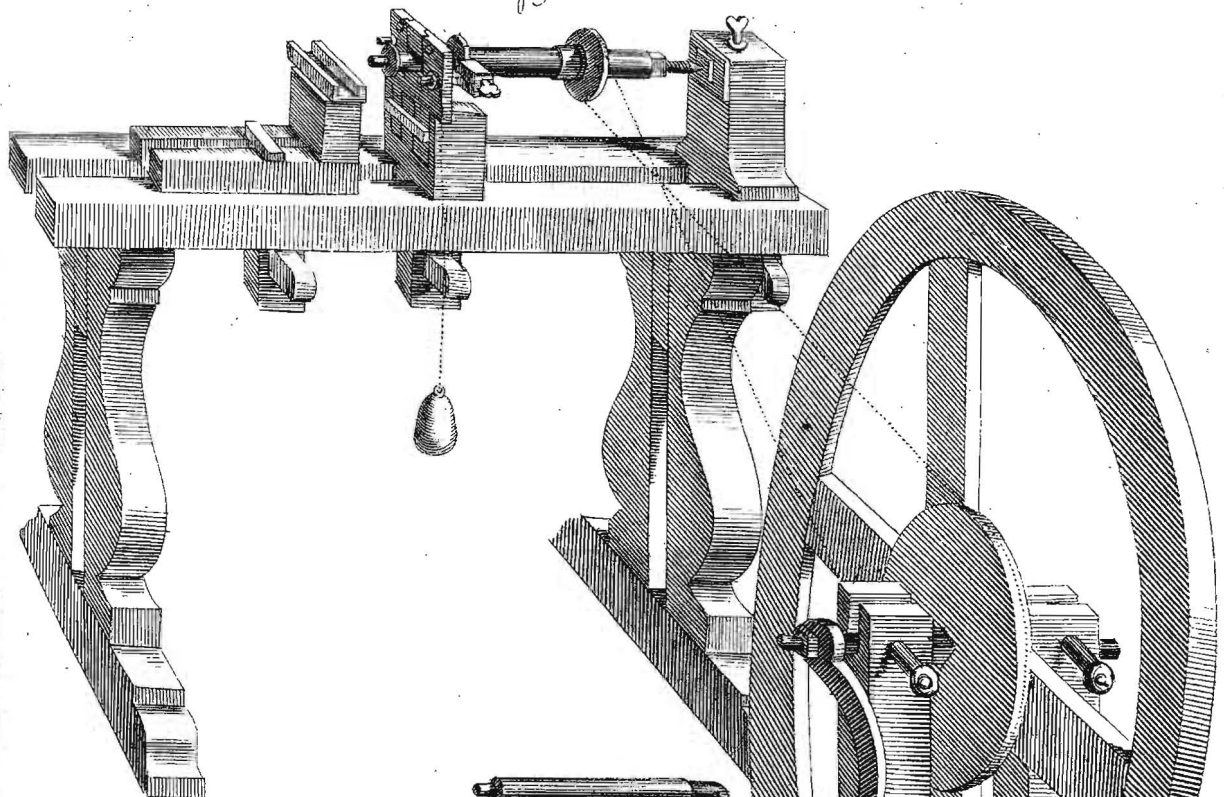


P. Carstus plumier Minimus. delin.

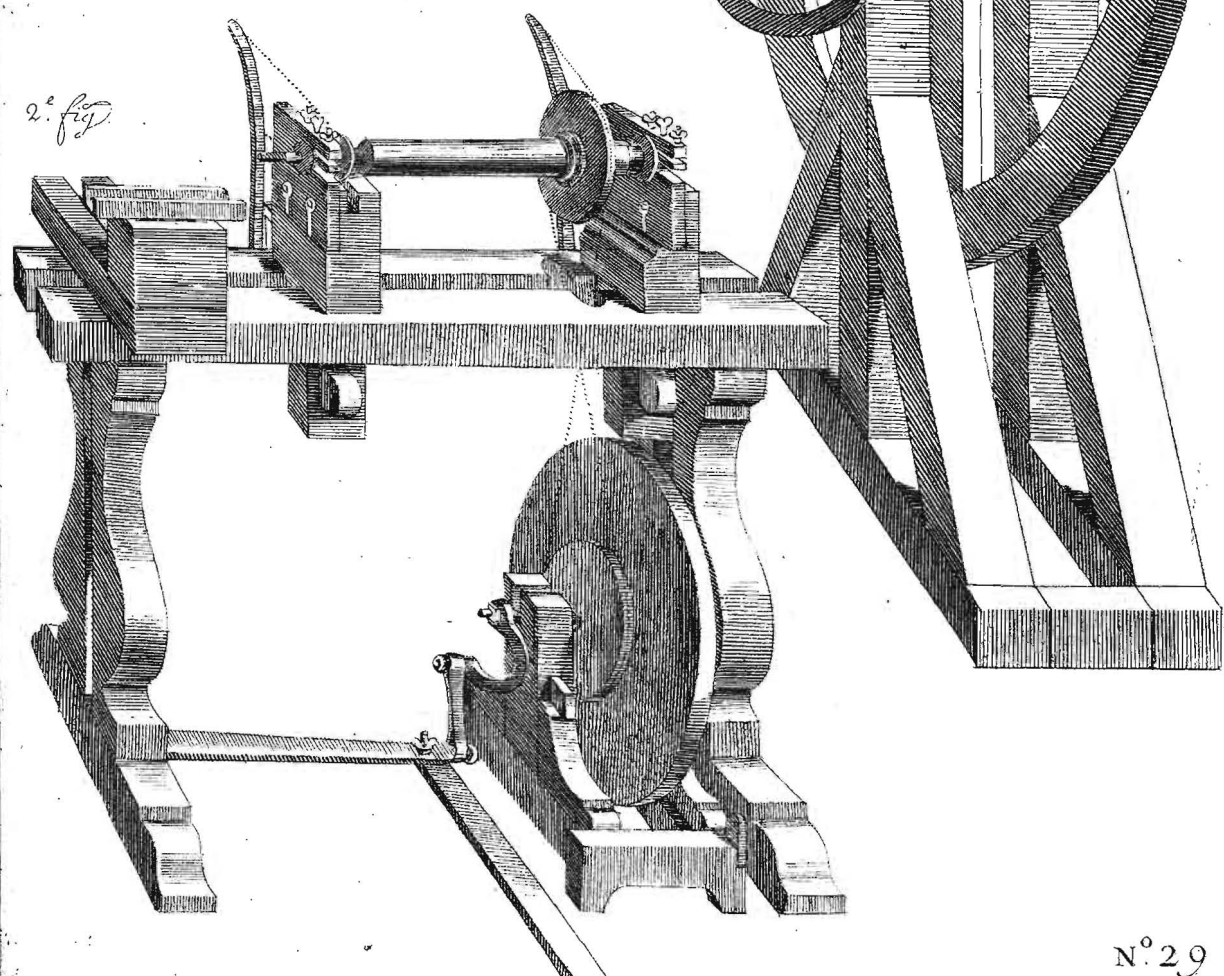
Echelle de 7 pouces.

1.<sup>e</sup> figure

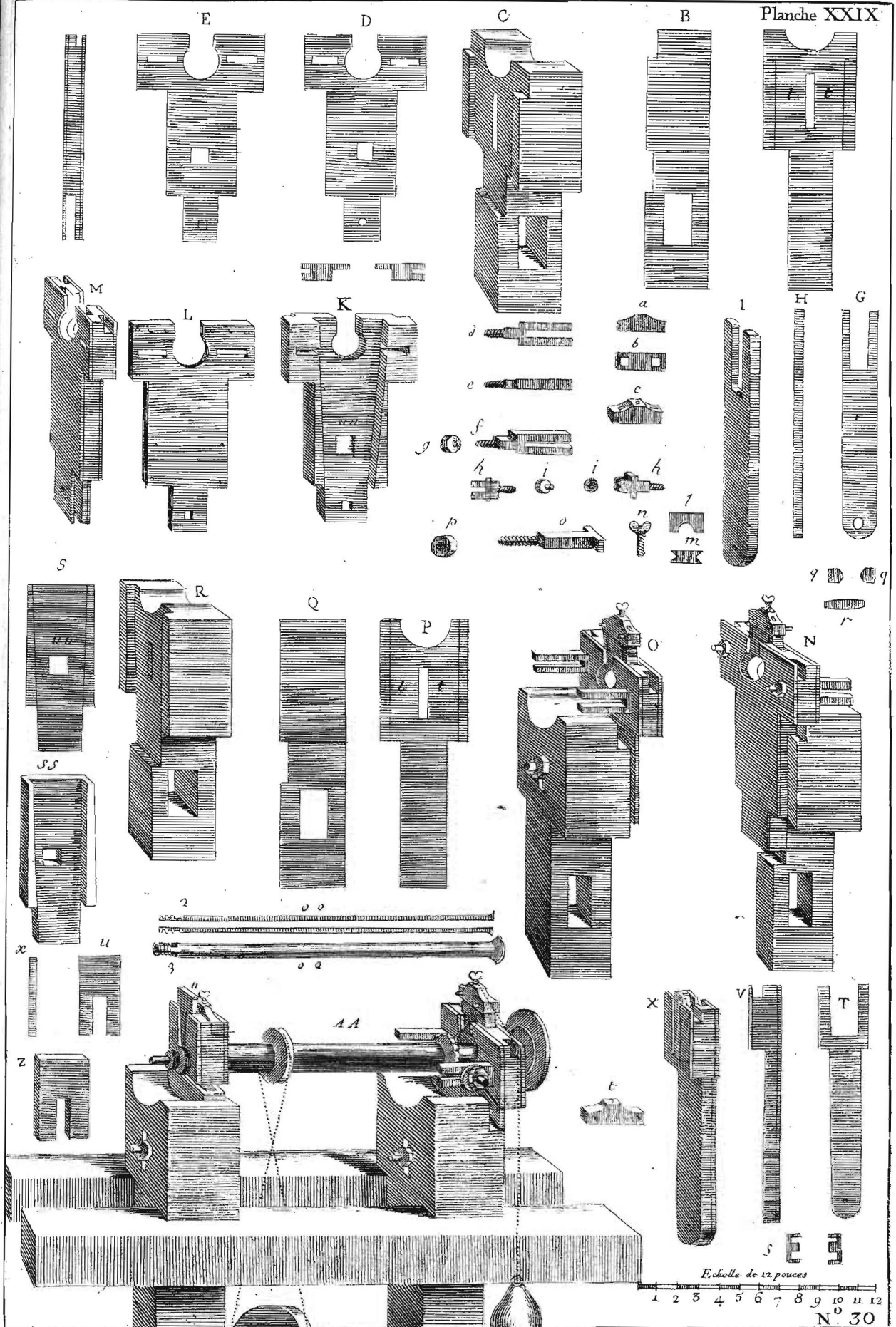
Planche XXVIII.

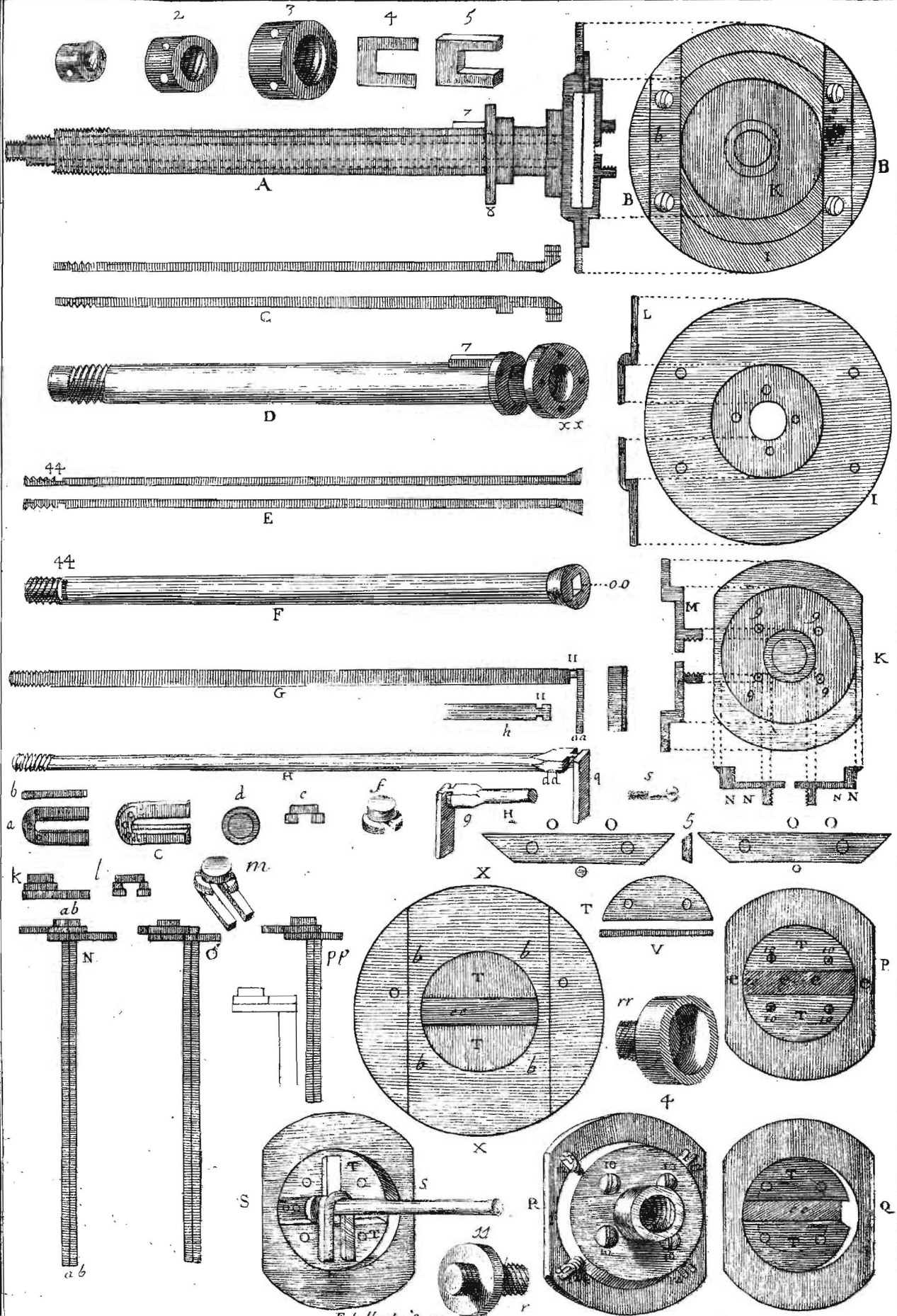


2.<sup>e</sup> fig.

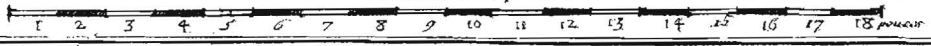


N<sup>o</sup> 29





Echelle de 18 pouces



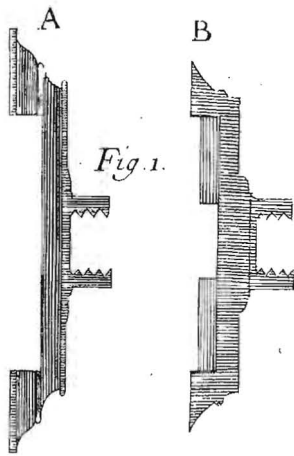


Fig. 1.

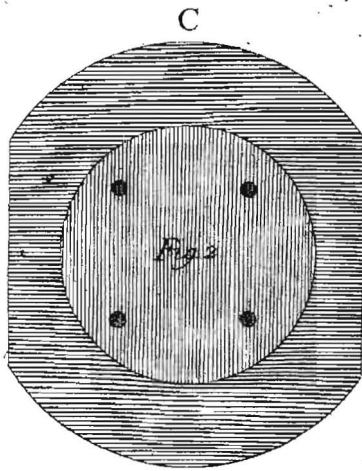


Fig. 2.

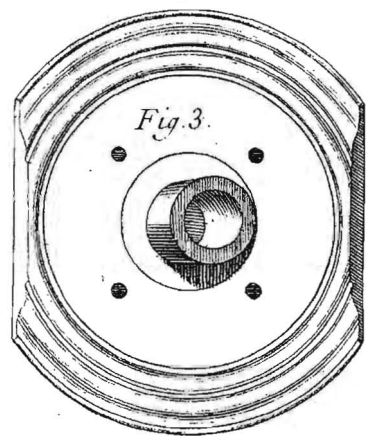


Fig. 3.

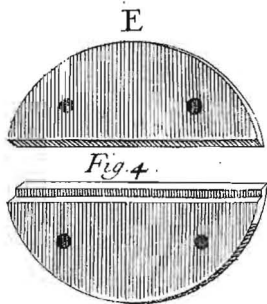


Fig. 4.

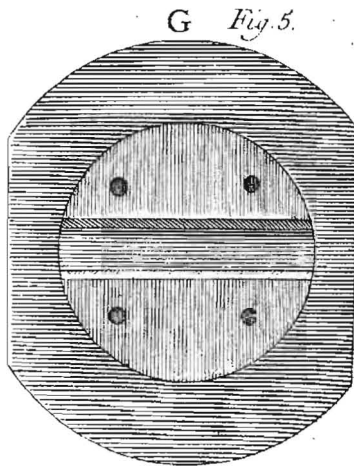


Fig. 5.

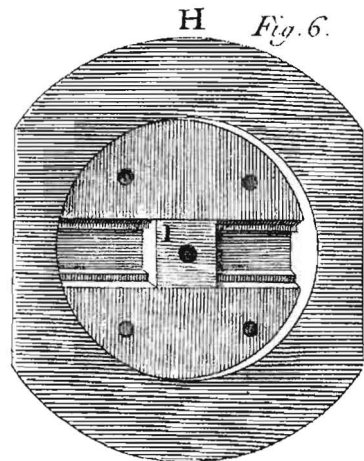


Fig. 6.

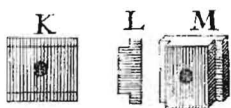


Fig. 7.

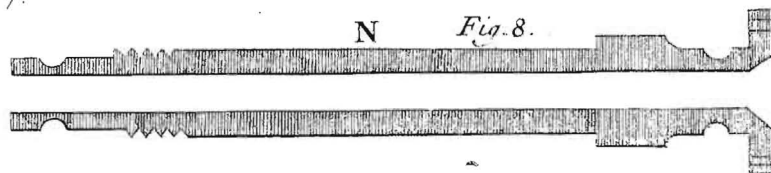


Fig. 8.

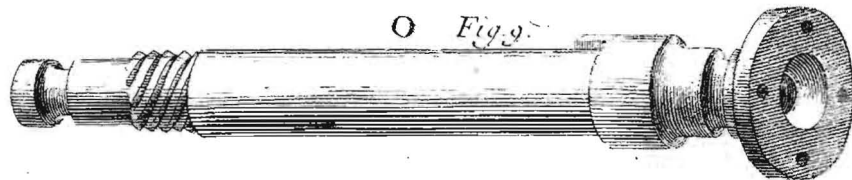


Fig. 9.

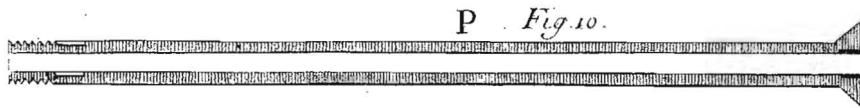


Fig. 10.

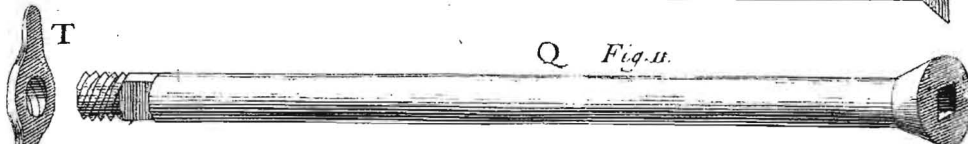


Fig. 11.



Fig. 12.

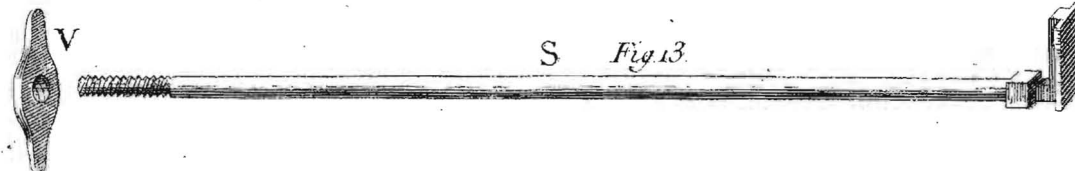
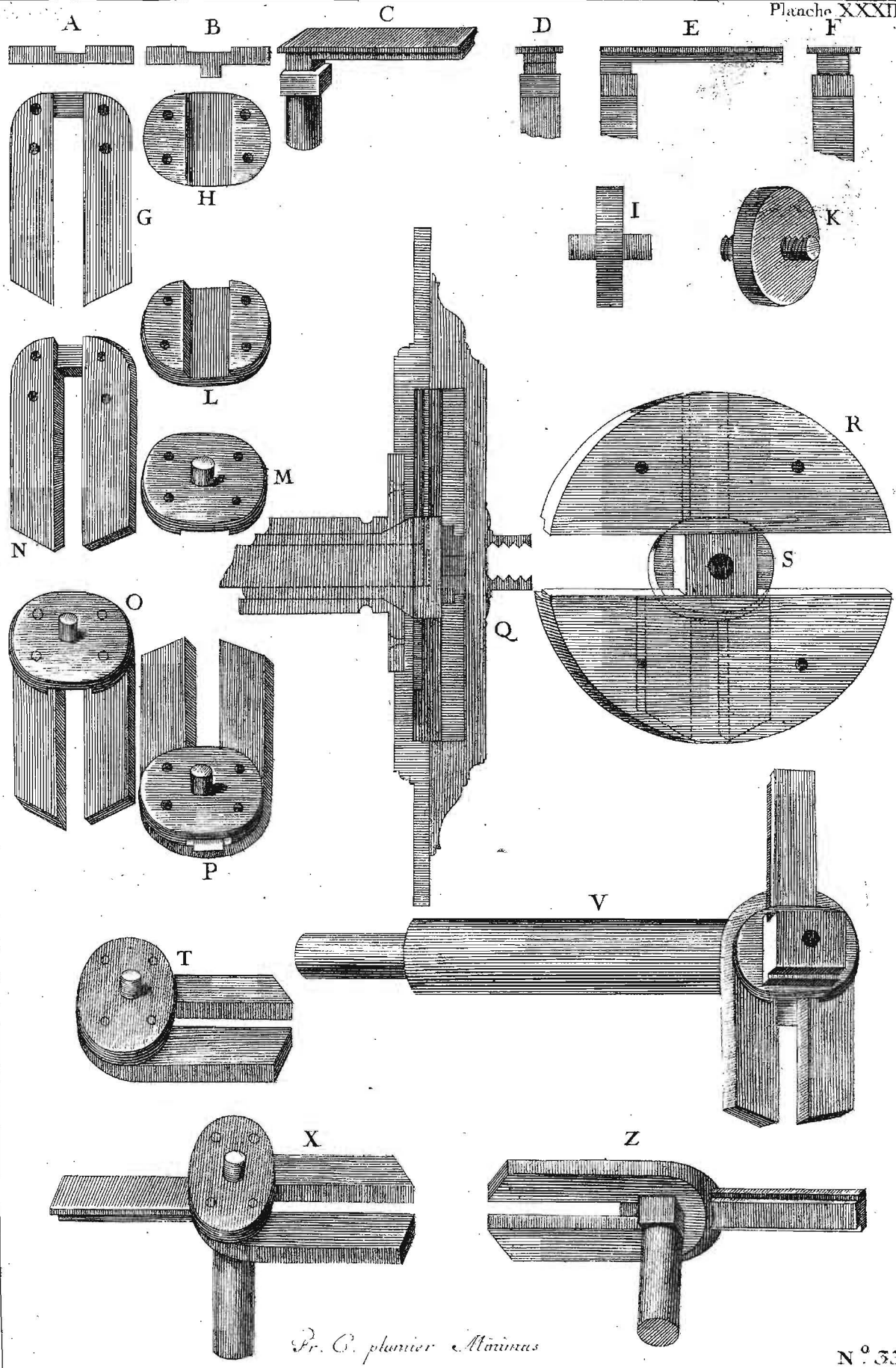


Fig. 13.



Pr. C. plumbier Minimus



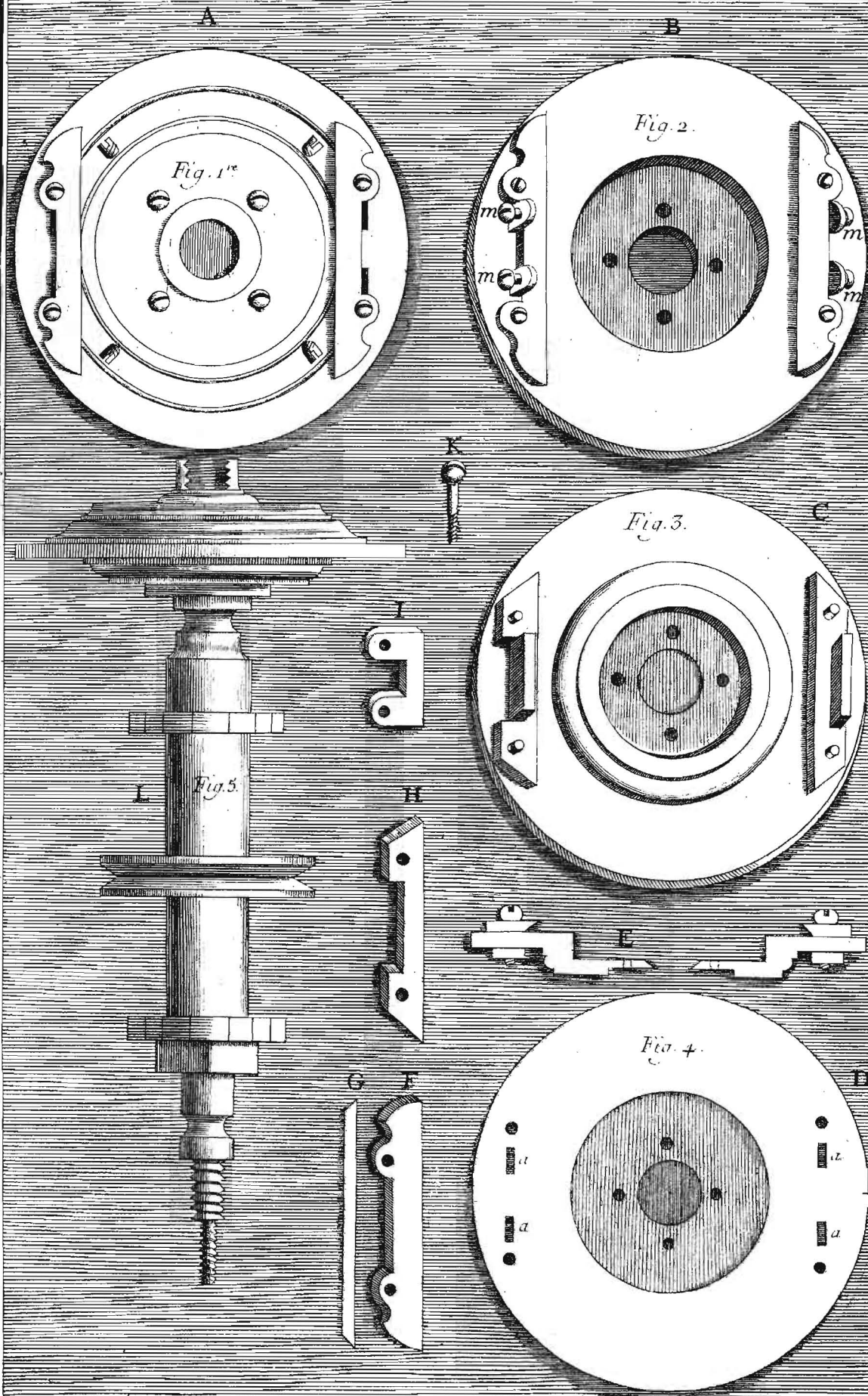


Figure première

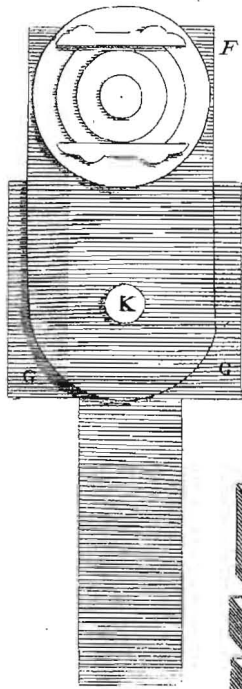


Figure Seconde

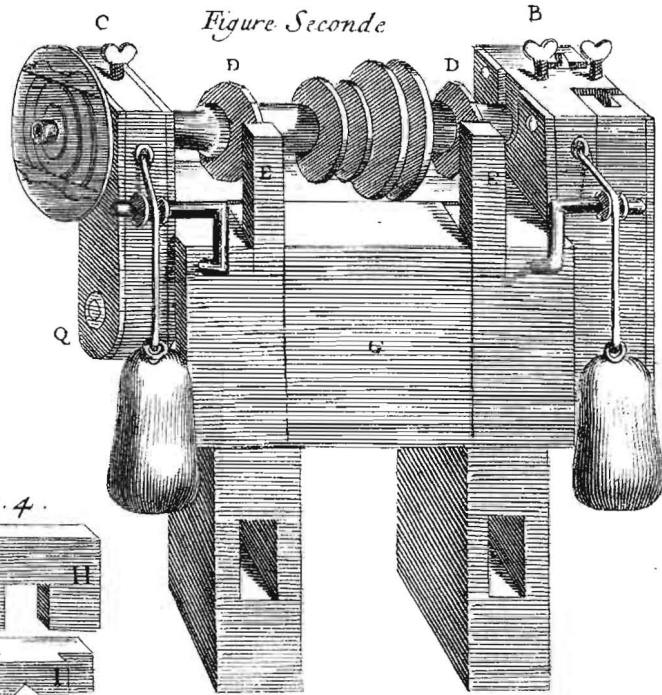


Figure troisieme

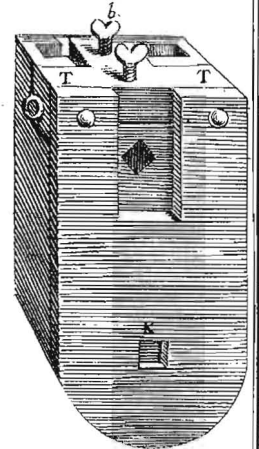


Fig. 4.

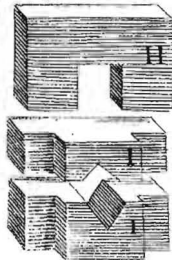


Figure 5.

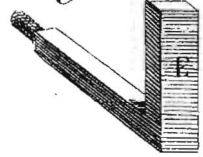


Fig. 6.

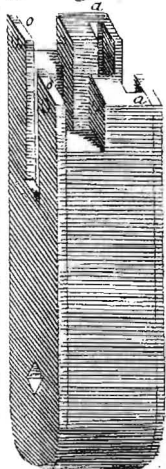


Fig. 8.



Fig. 7.

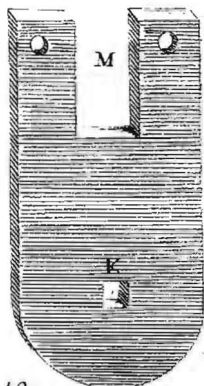


Fig. 9.

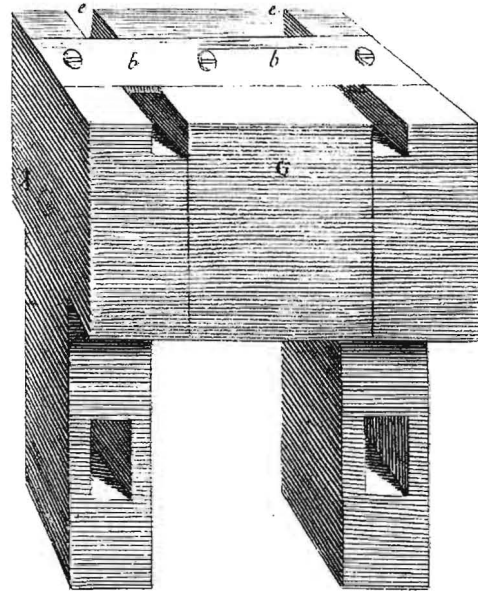


Fig. 10.

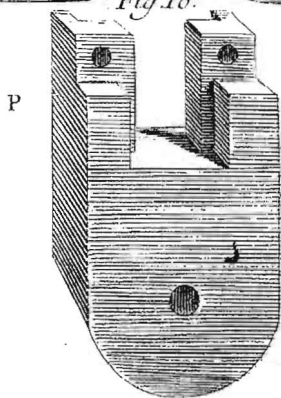


Fig. 11.



R

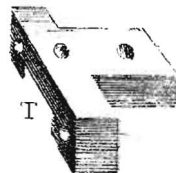


Fig. 12.

S



Q Fig. 13

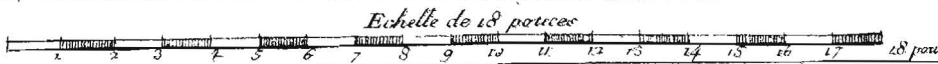
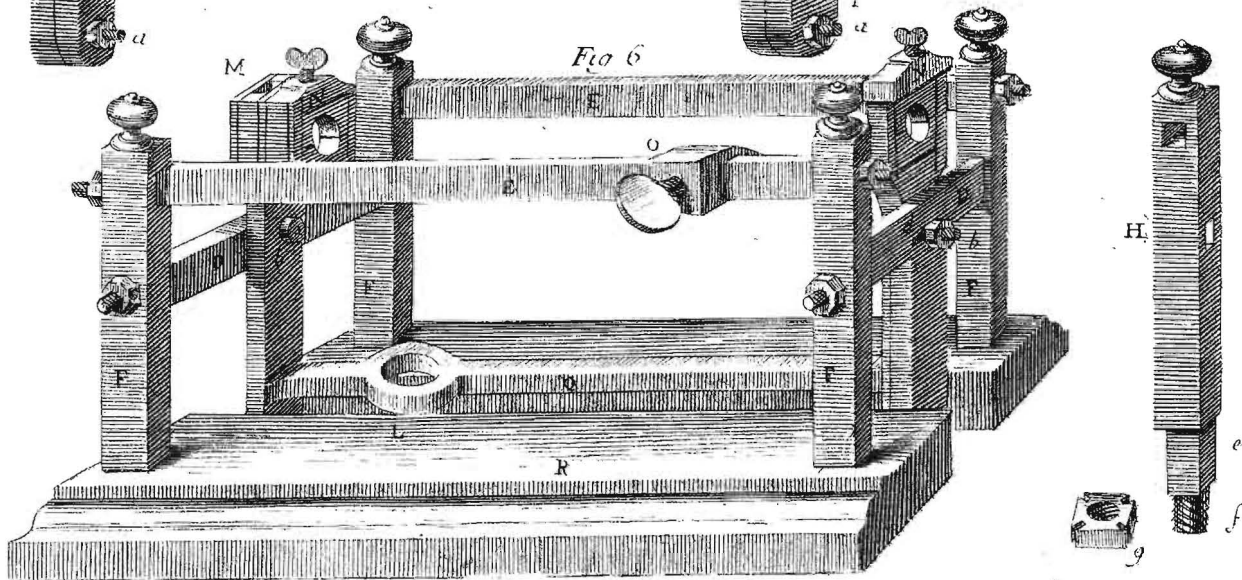
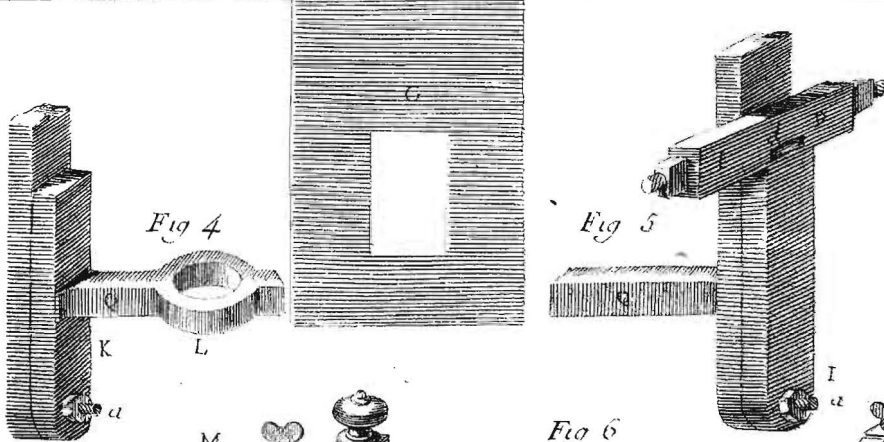
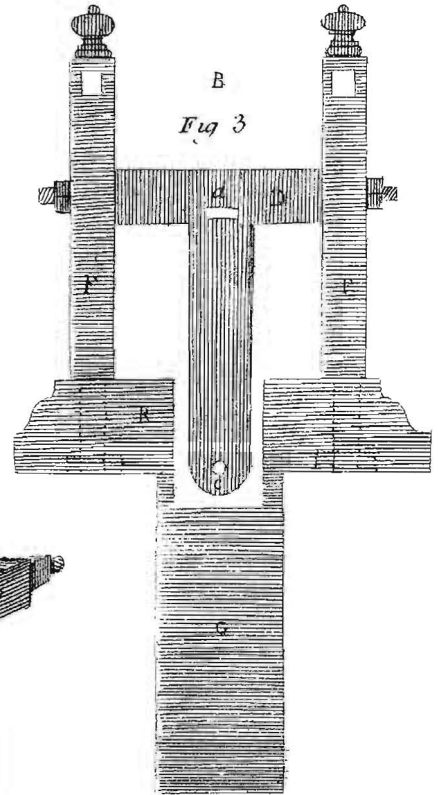
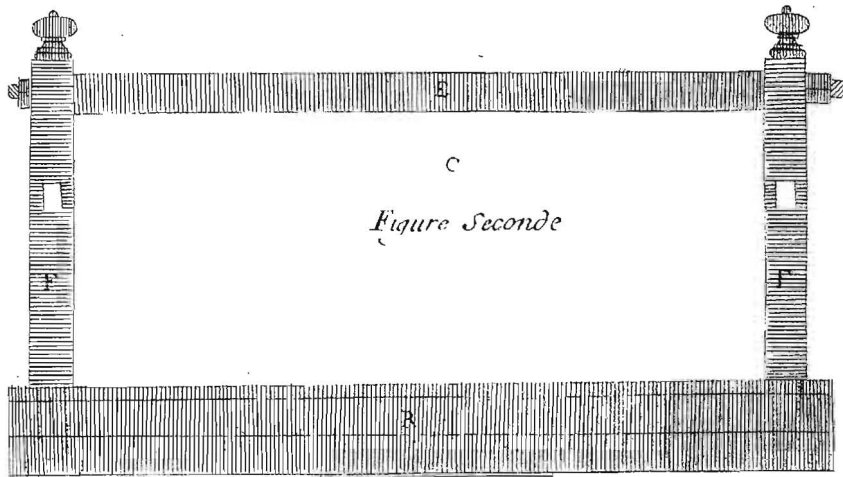
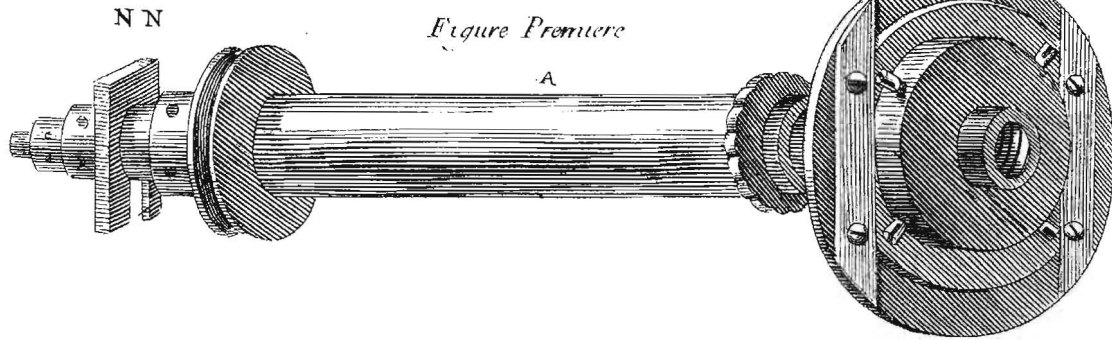


Figure premiere

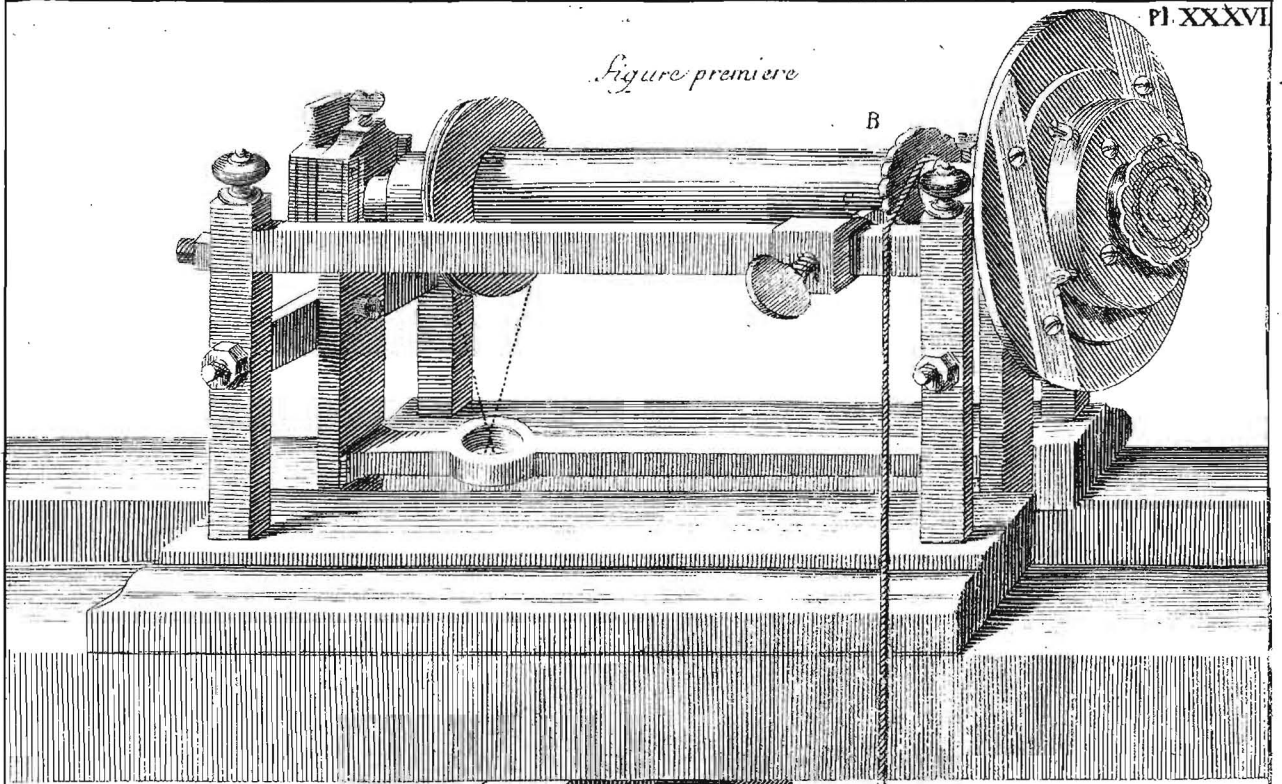
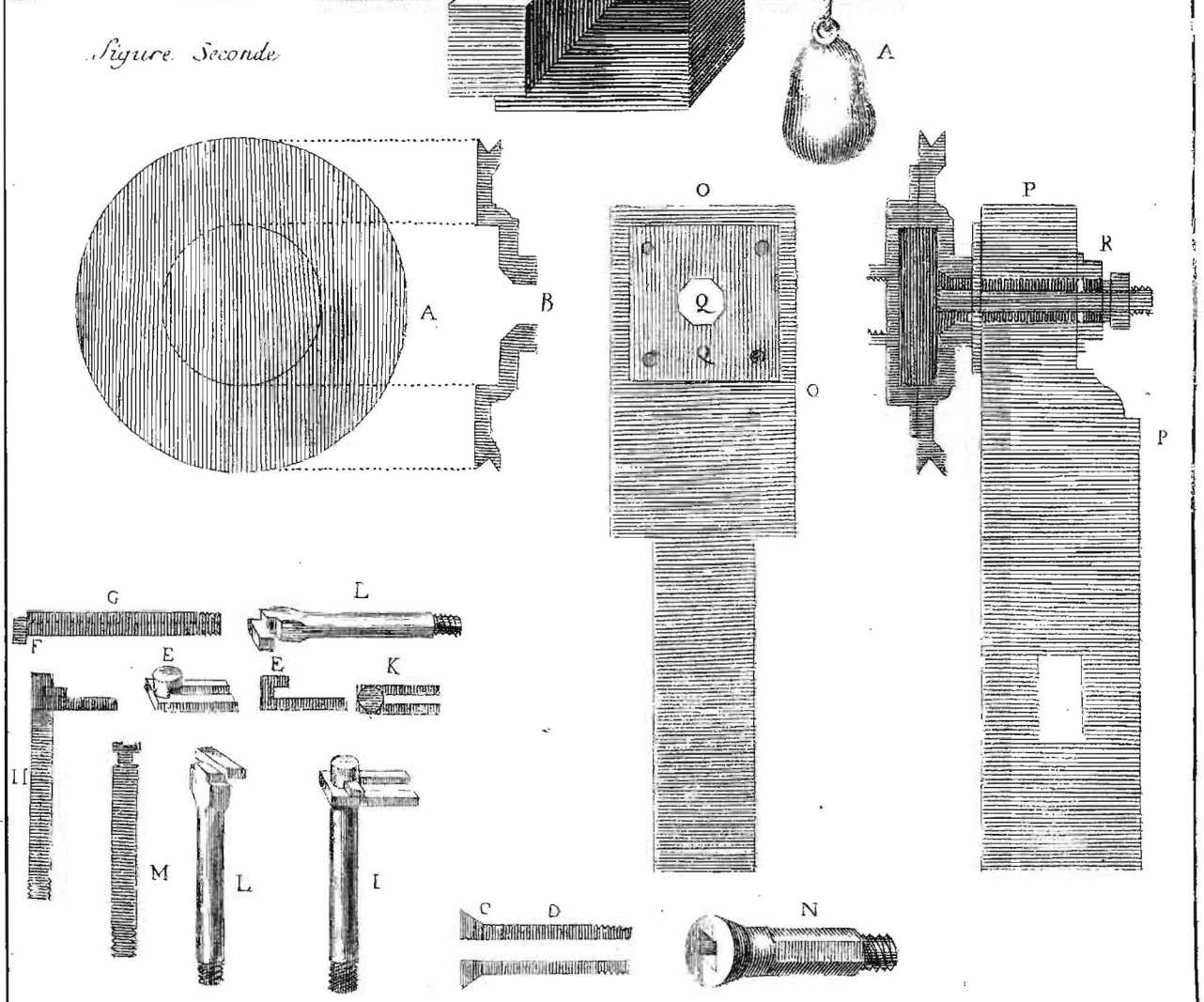


Figure Seconde



1 2 3 4 5 6 7 8 9 10 11 12 pouces.

A premiere figure.

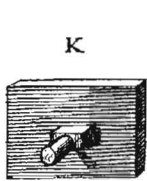
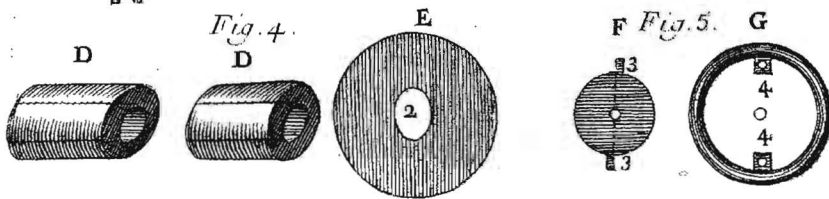
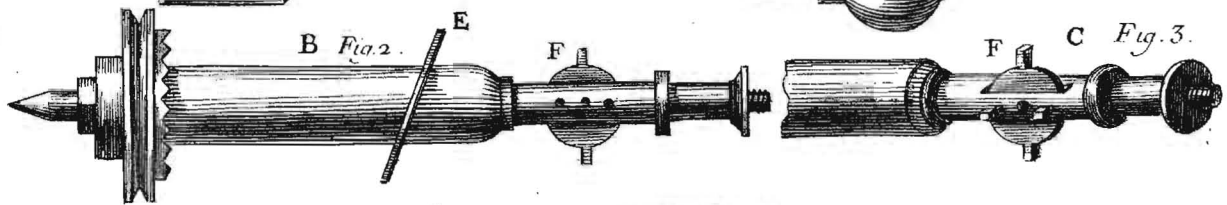
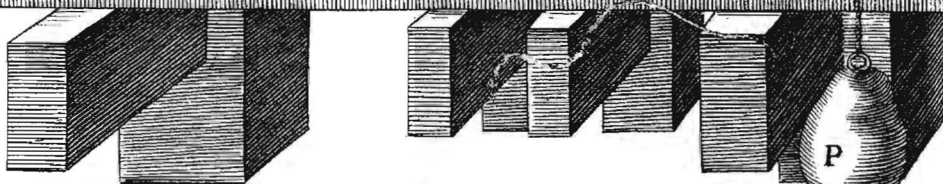
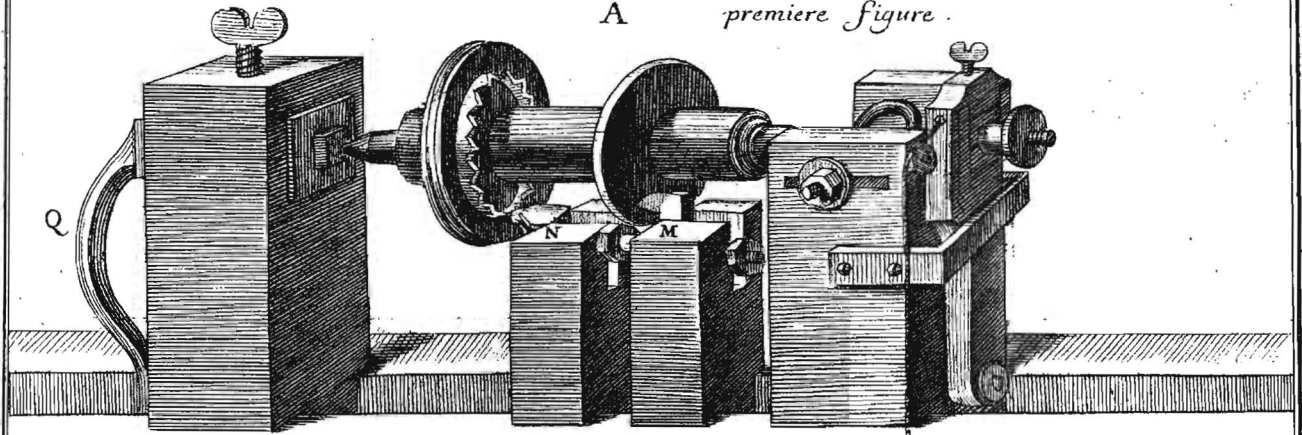


Fig. 6.

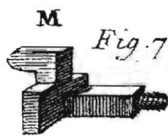
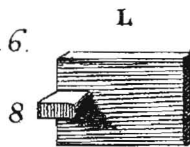


Fig. 7.

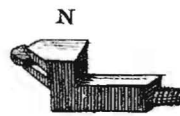


Fig. 8.

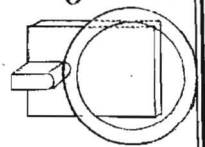


Fig. 9.

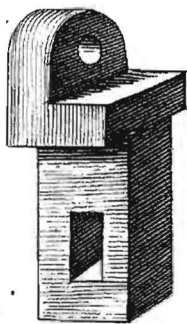


Fig. 10.

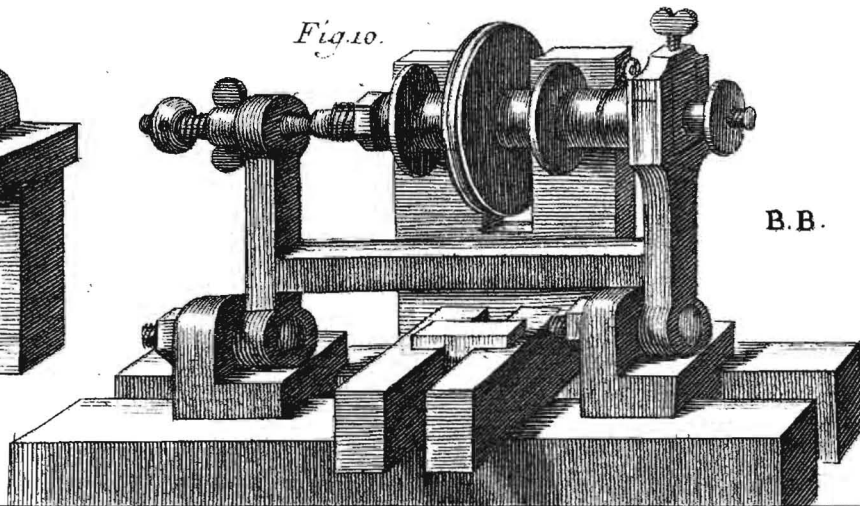


Fig. 1.

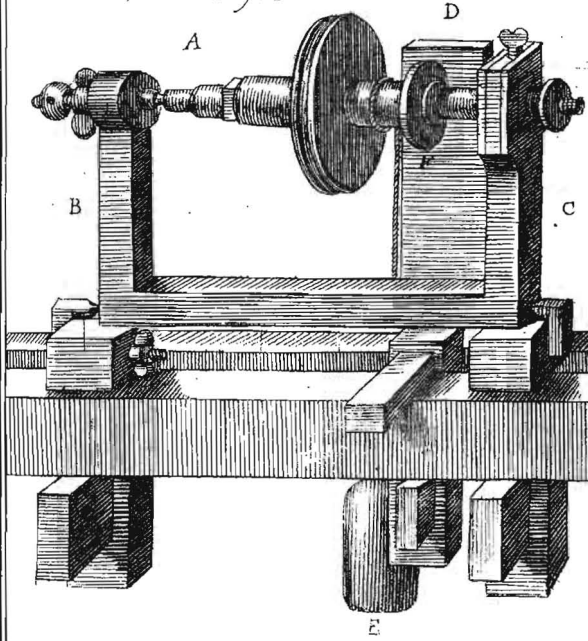


Fig. 2.

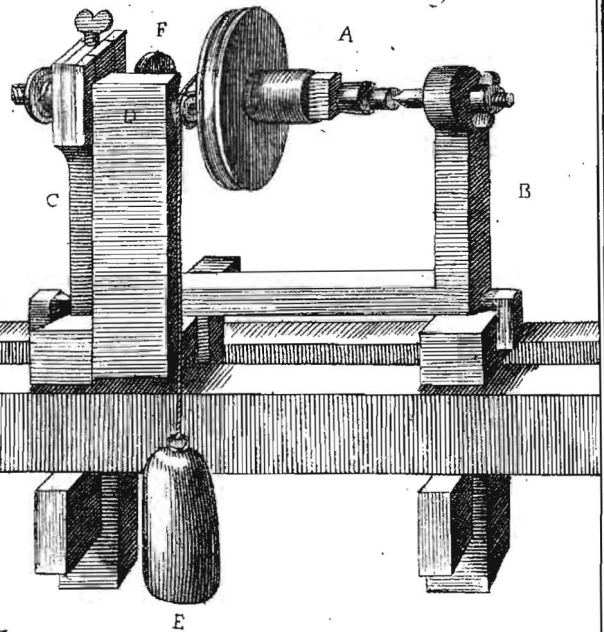


Fig. 3.

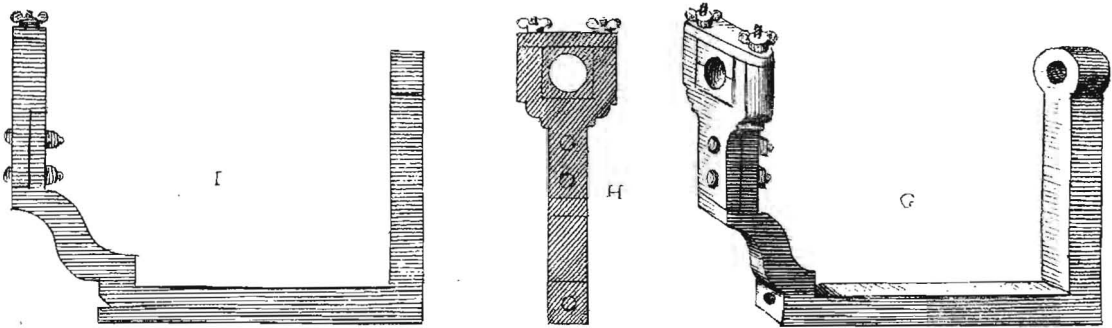


Fig. 3.

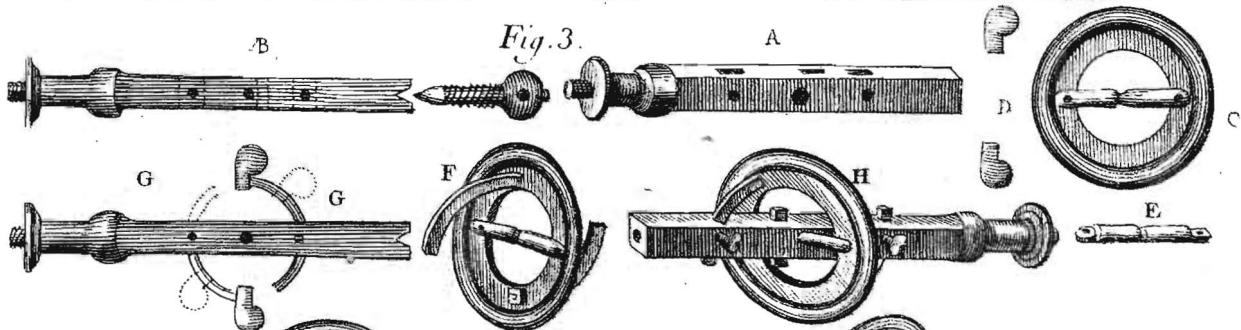


Fig. 4.

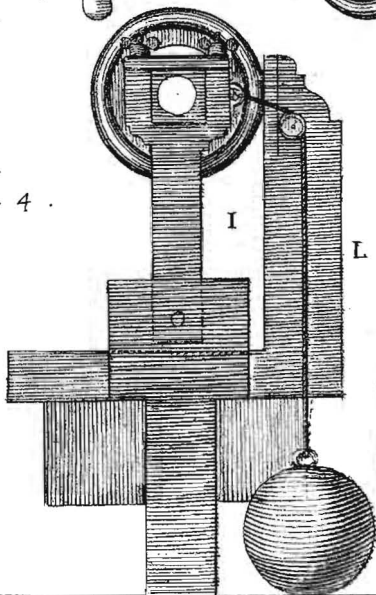
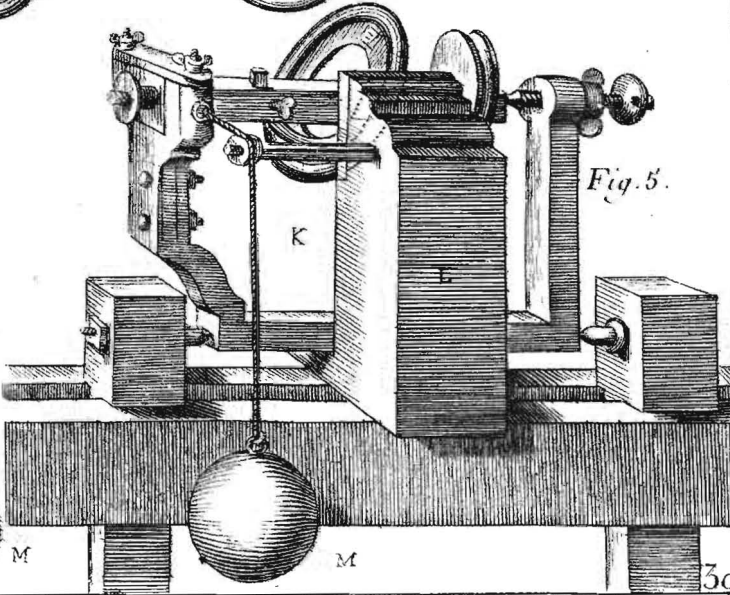
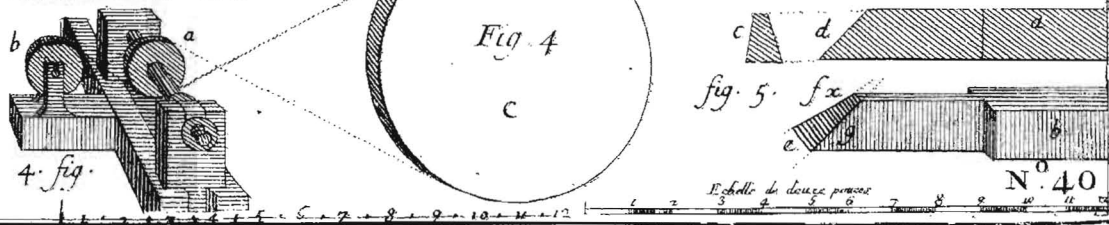
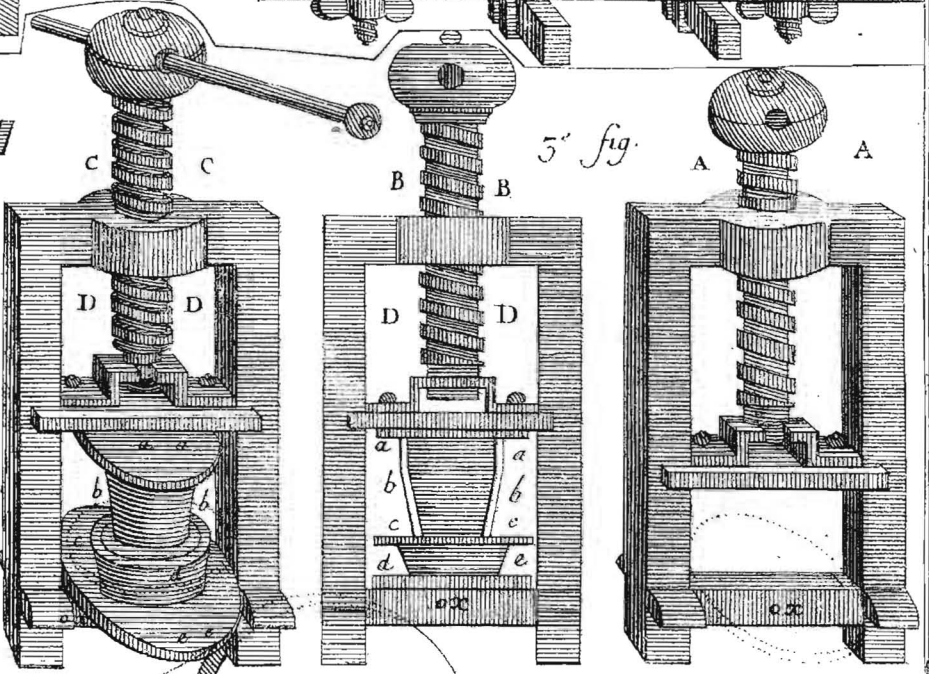
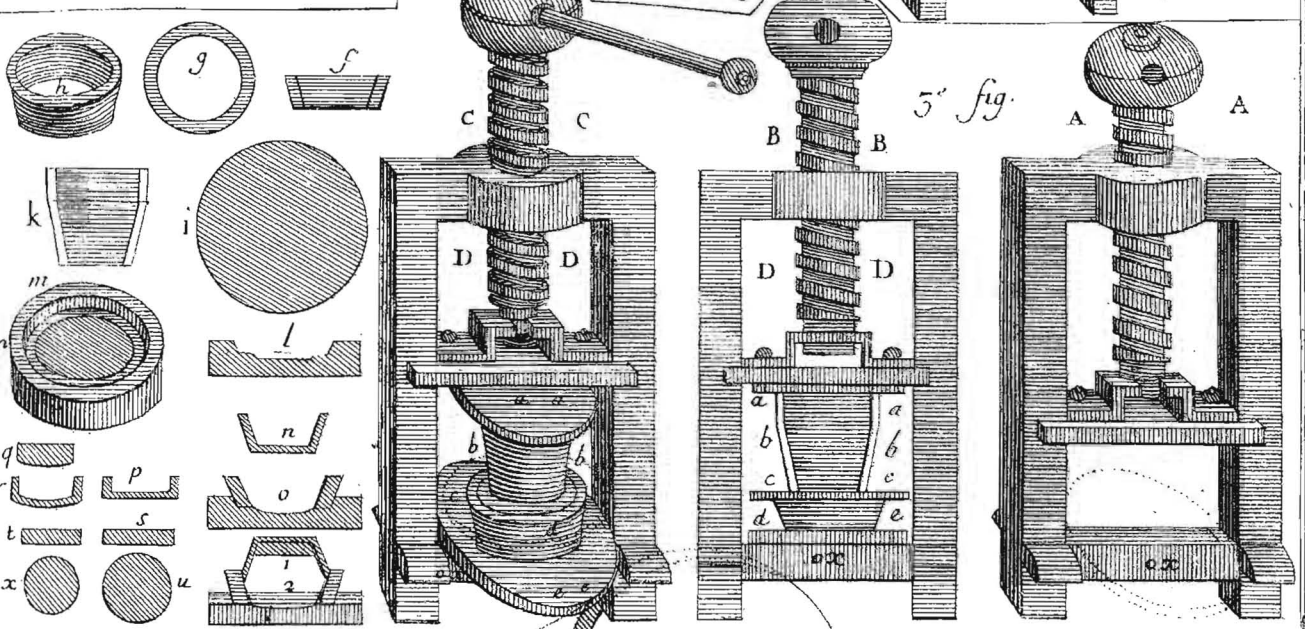
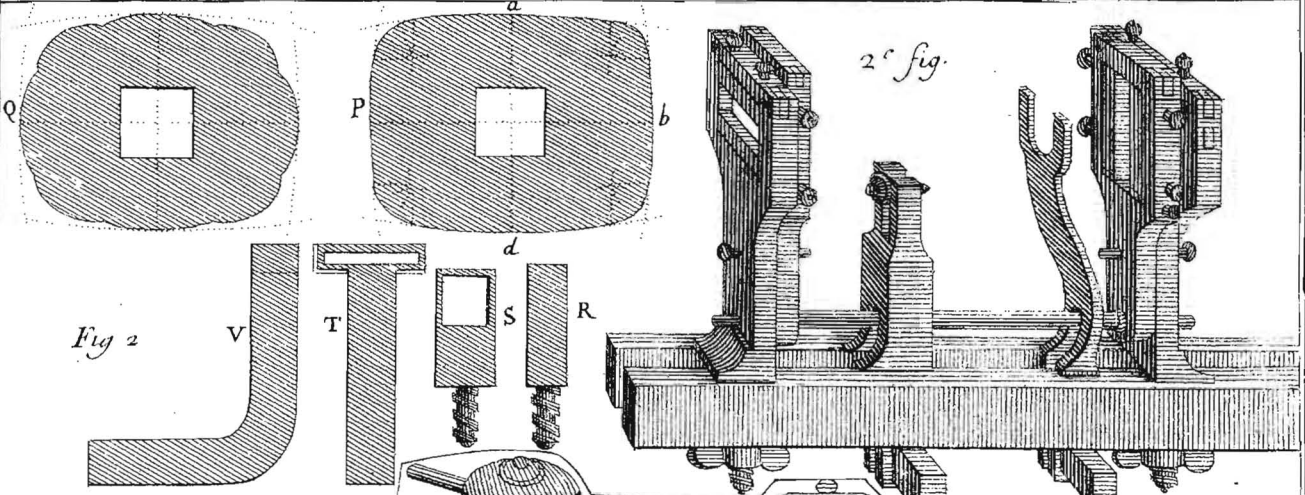
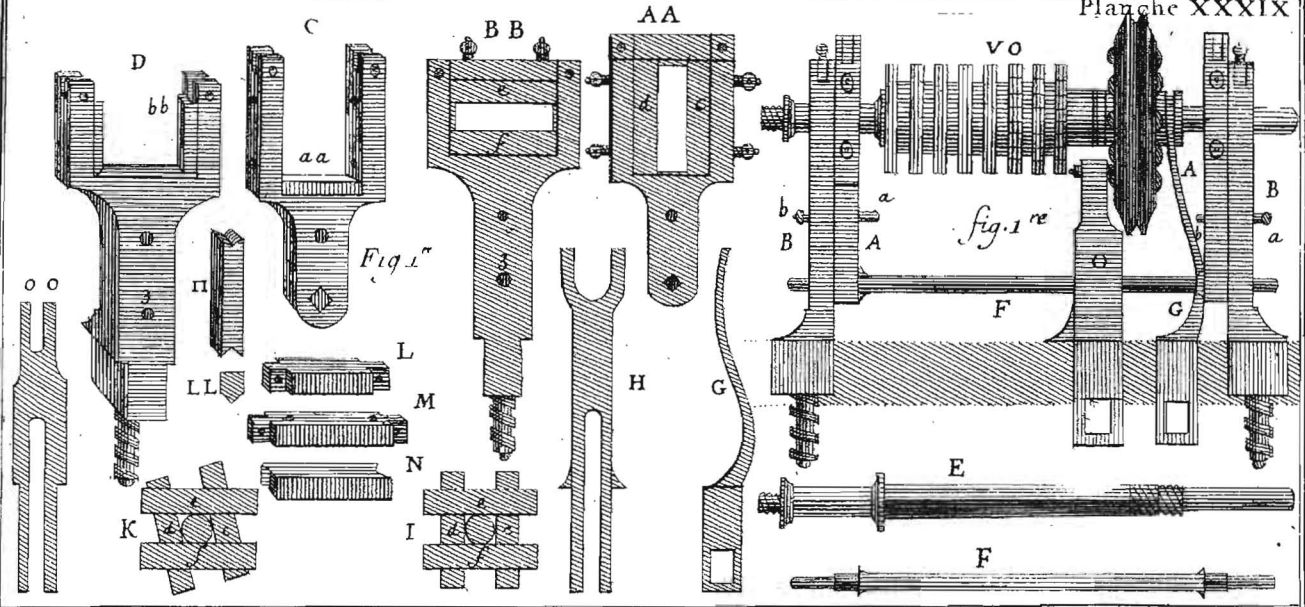


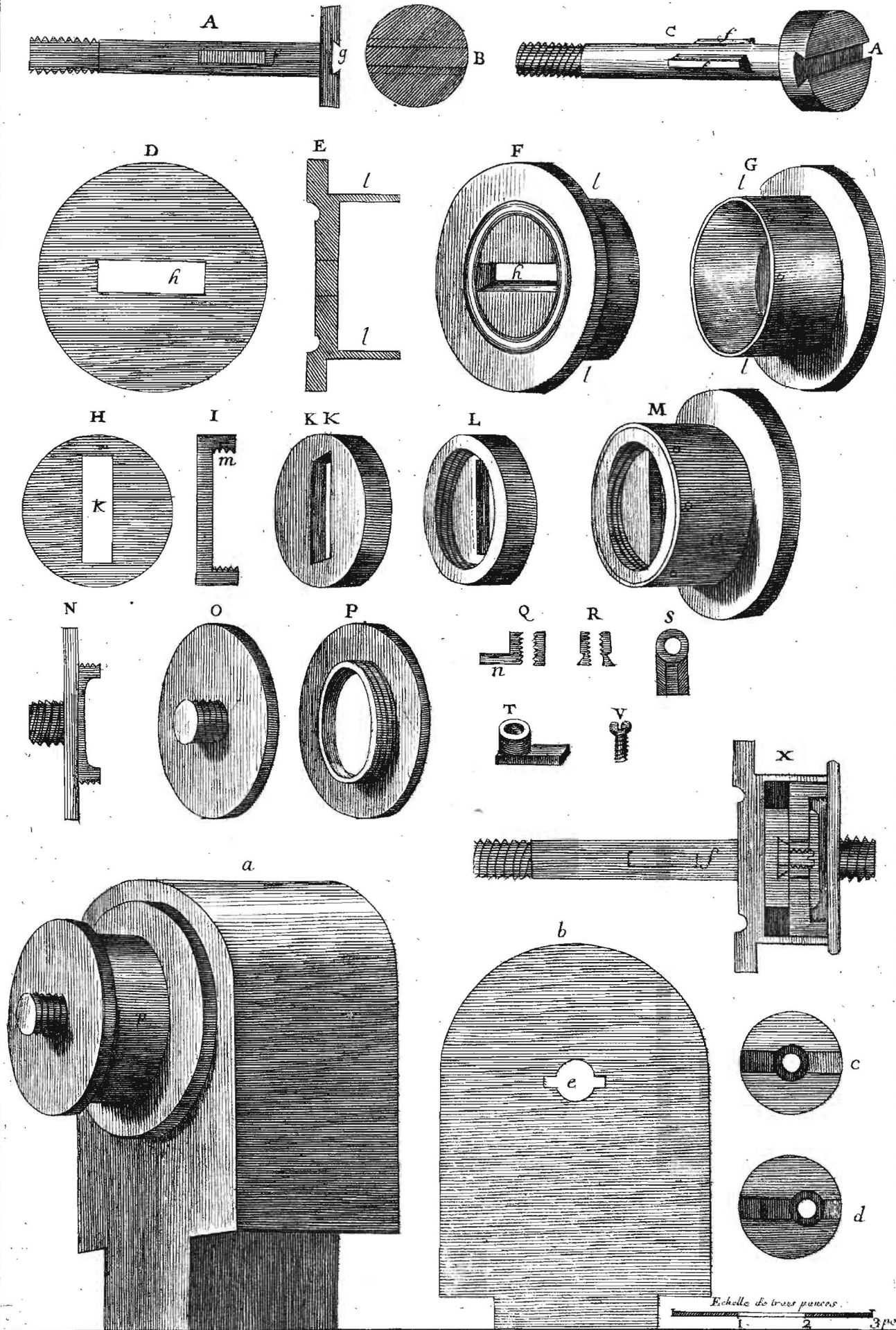
Fig. 5.

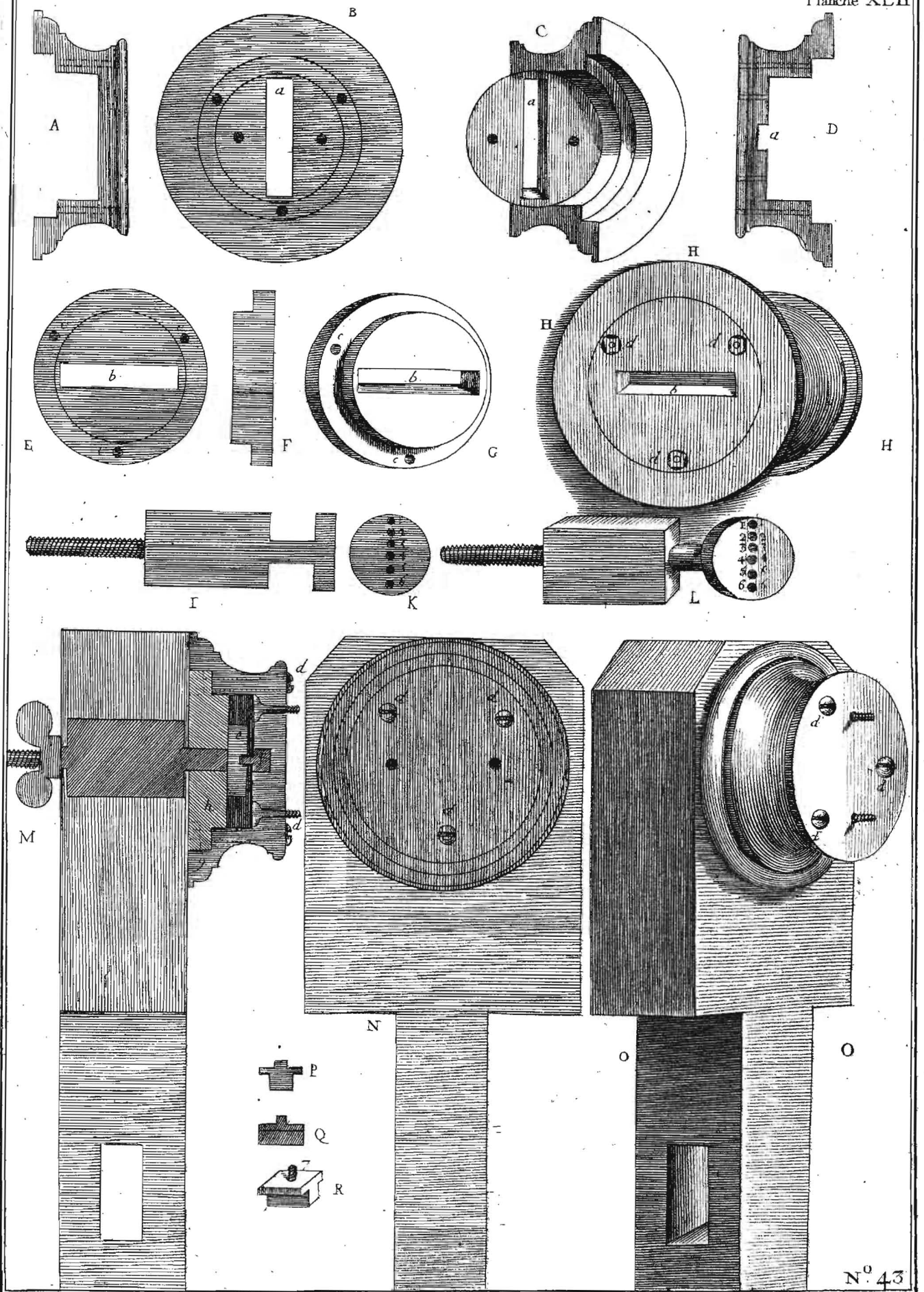


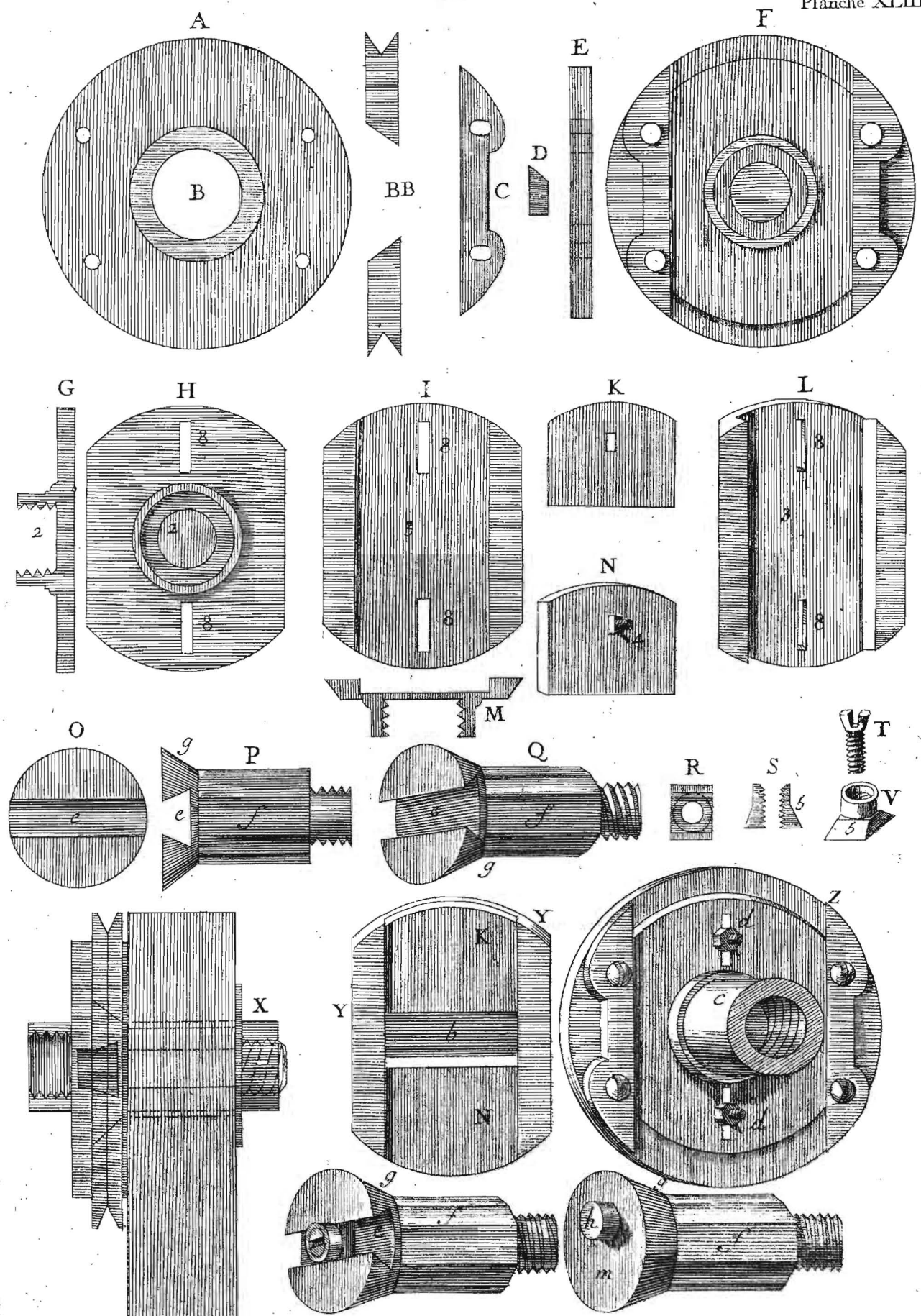




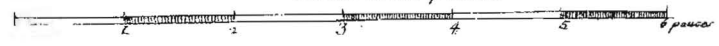


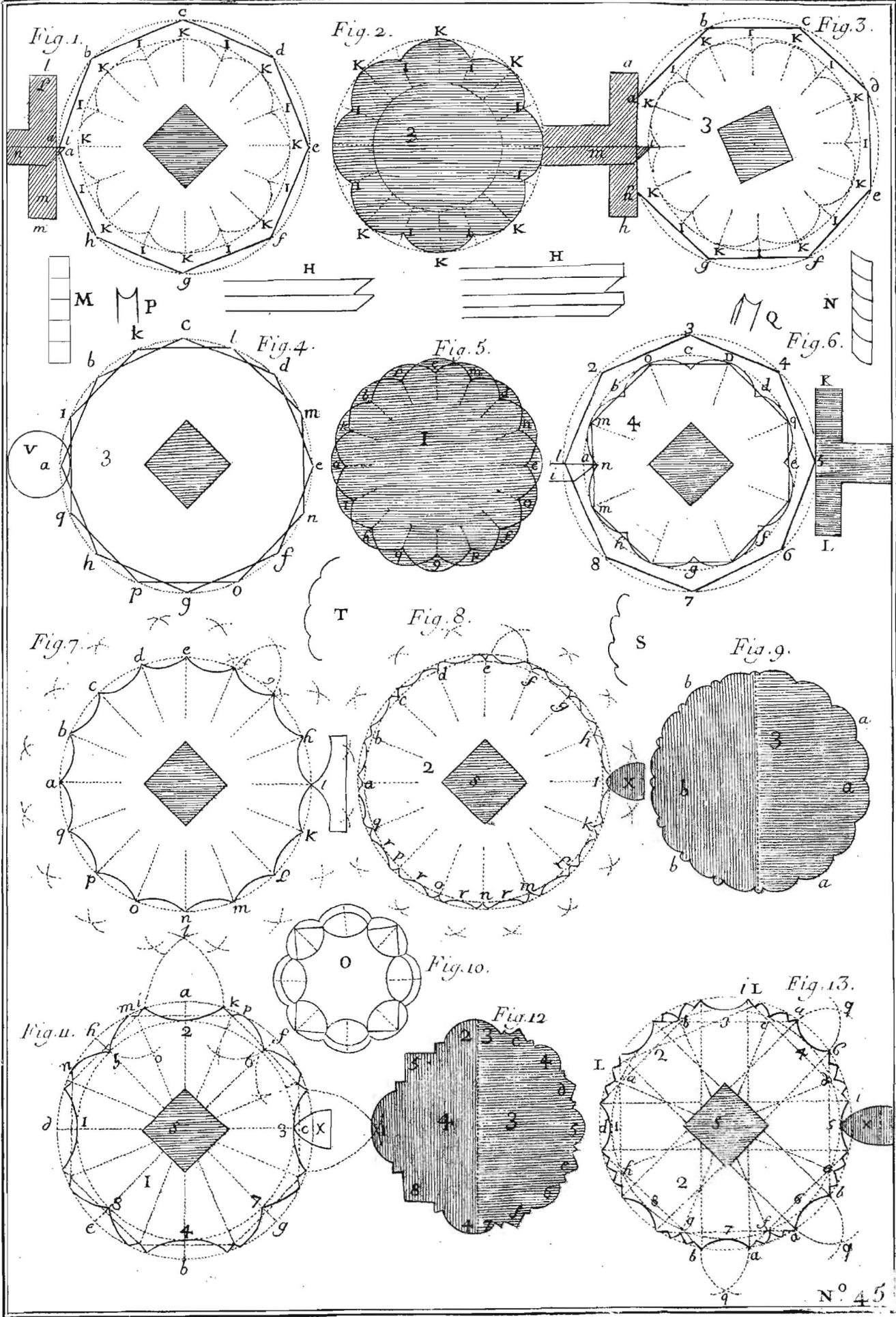






Echelle de six pouces





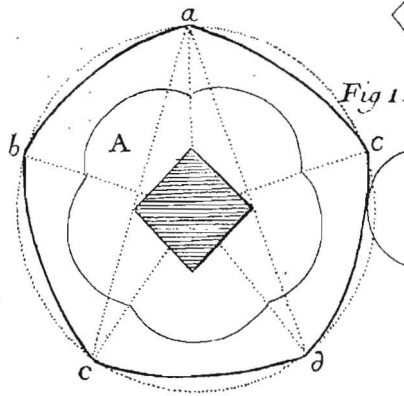


Fig. 1.

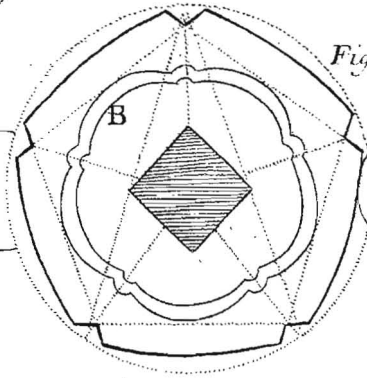


Fig. 2.

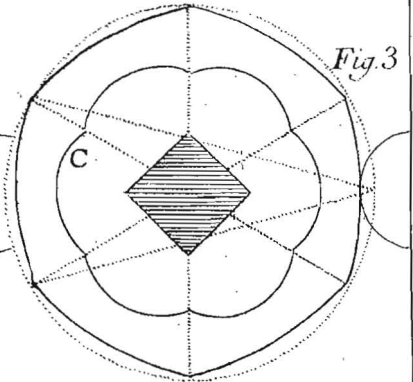


Fig. 3.

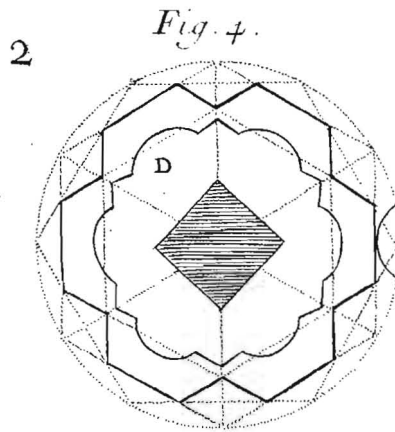


Fig. 4.

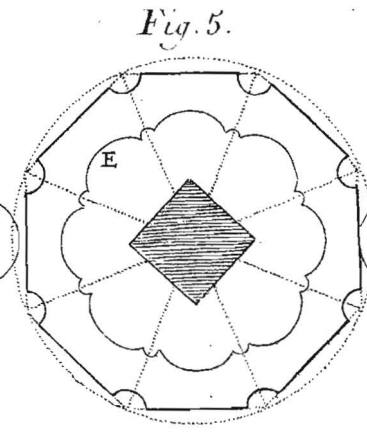


Fig. 5.

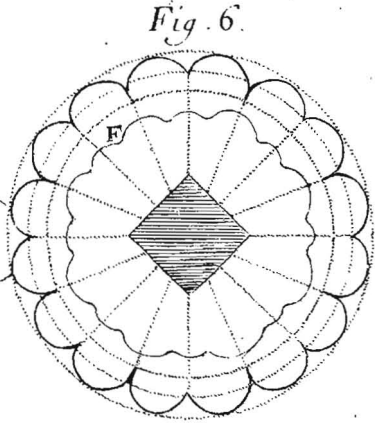


Fig. 6.

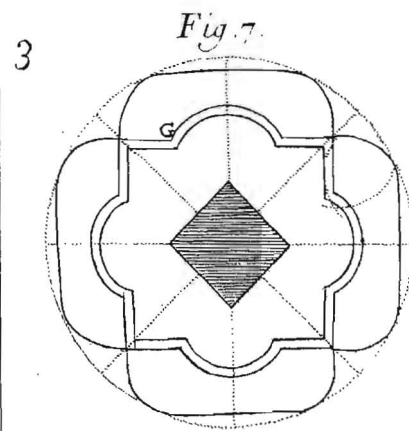


Fig. 7.

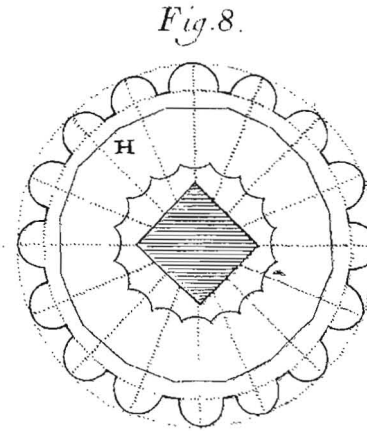


Fig. 8.

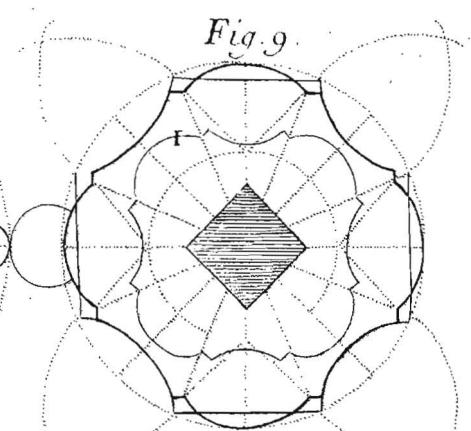


Fig. 9.

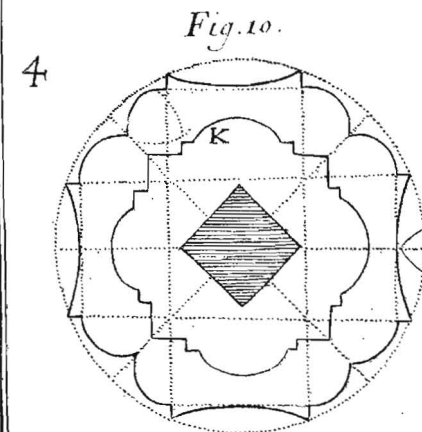


Fig. 10.

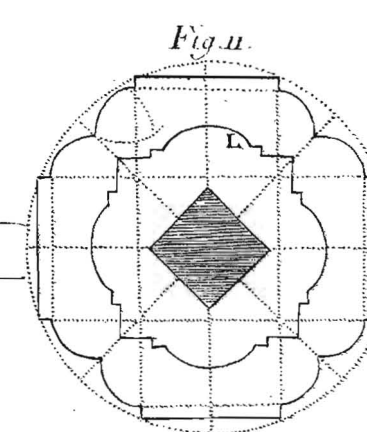


Fig. 11.

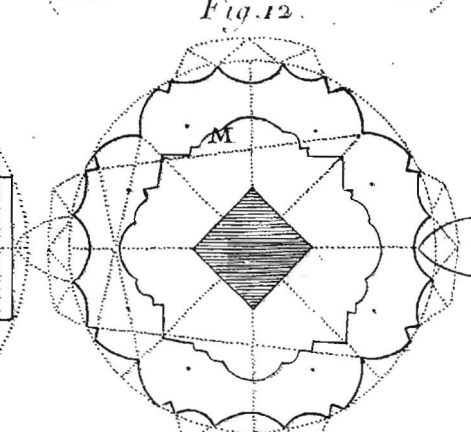
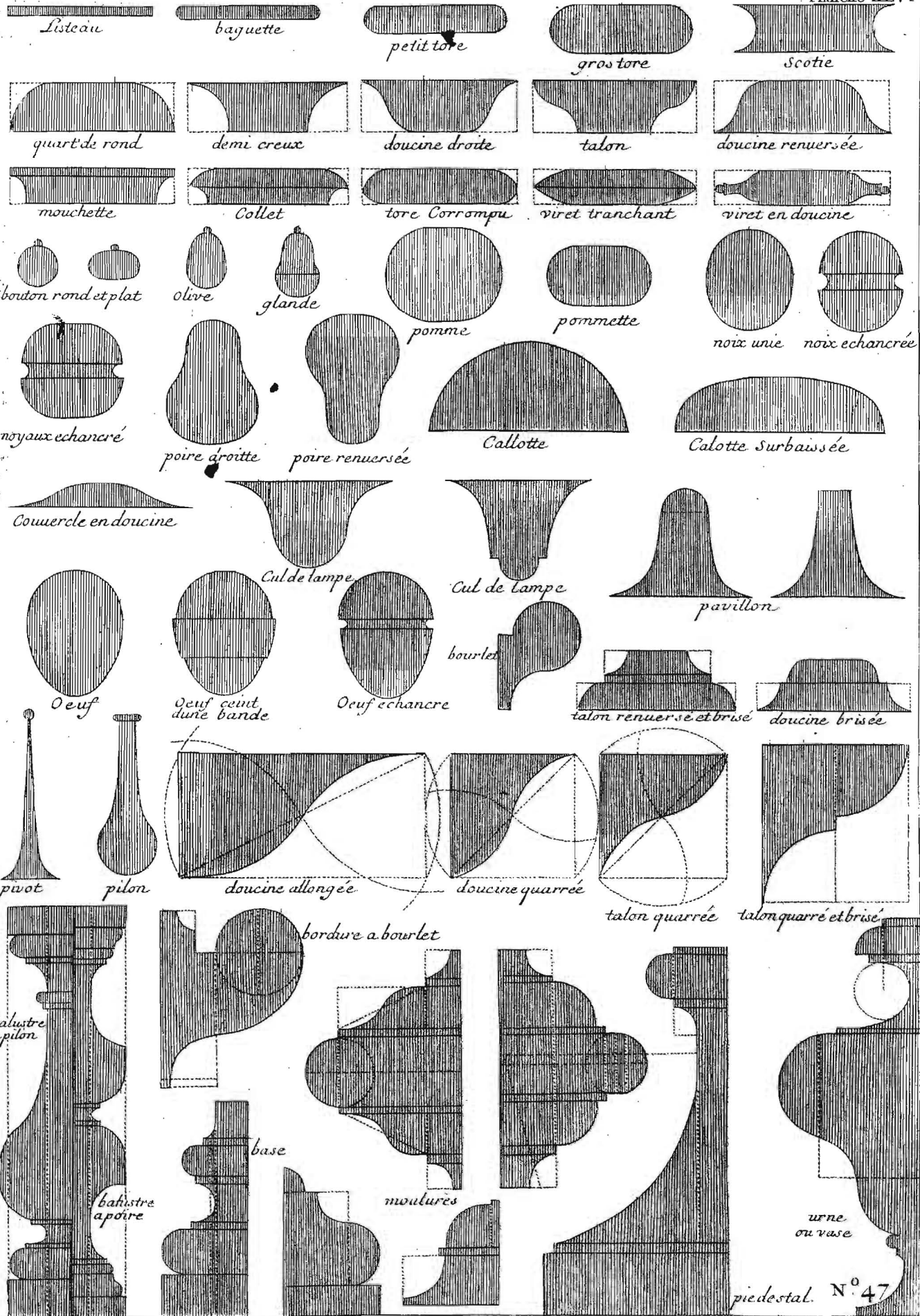


Fig. 12.



Listeau

baguette

petit tore

gros tore

scotie

quart de rond

demi creux

doucine droite

talon

doucine renversée

mouchette

Collet

tore Corrompu

viret tranchant

viret en doucine

bouton rond et plat

olive

glande

pomme

pommette

noix unie

noix échancrée

noyaux échancrés

poire droite

poire renversée

Calotte

Calotte surbaissée

Couverture en doucine

Cul de lampe

Cul de lampe

pavillon

Oeuf

Oeuf ceint d'une bande

Oeuf échancré

bourlet

talon renversé et brisé

doucine brisée

pivot

pilon

doucine allongée

doucine carrée

talon carrée

talon carré et brisé

bordure à bourlet

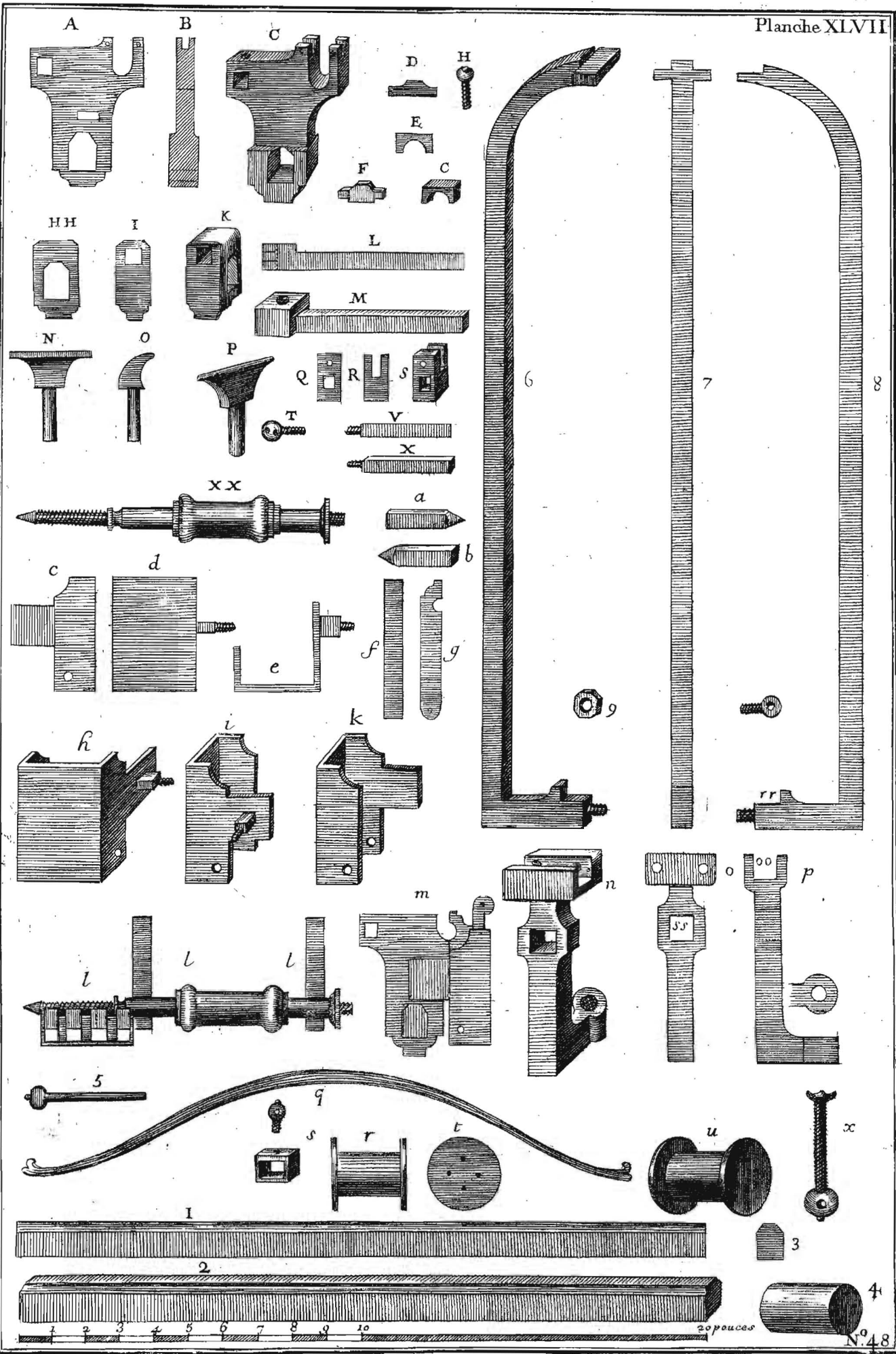
balustrade à pilon

base

moulures

balustrade à poire

urne ou vase



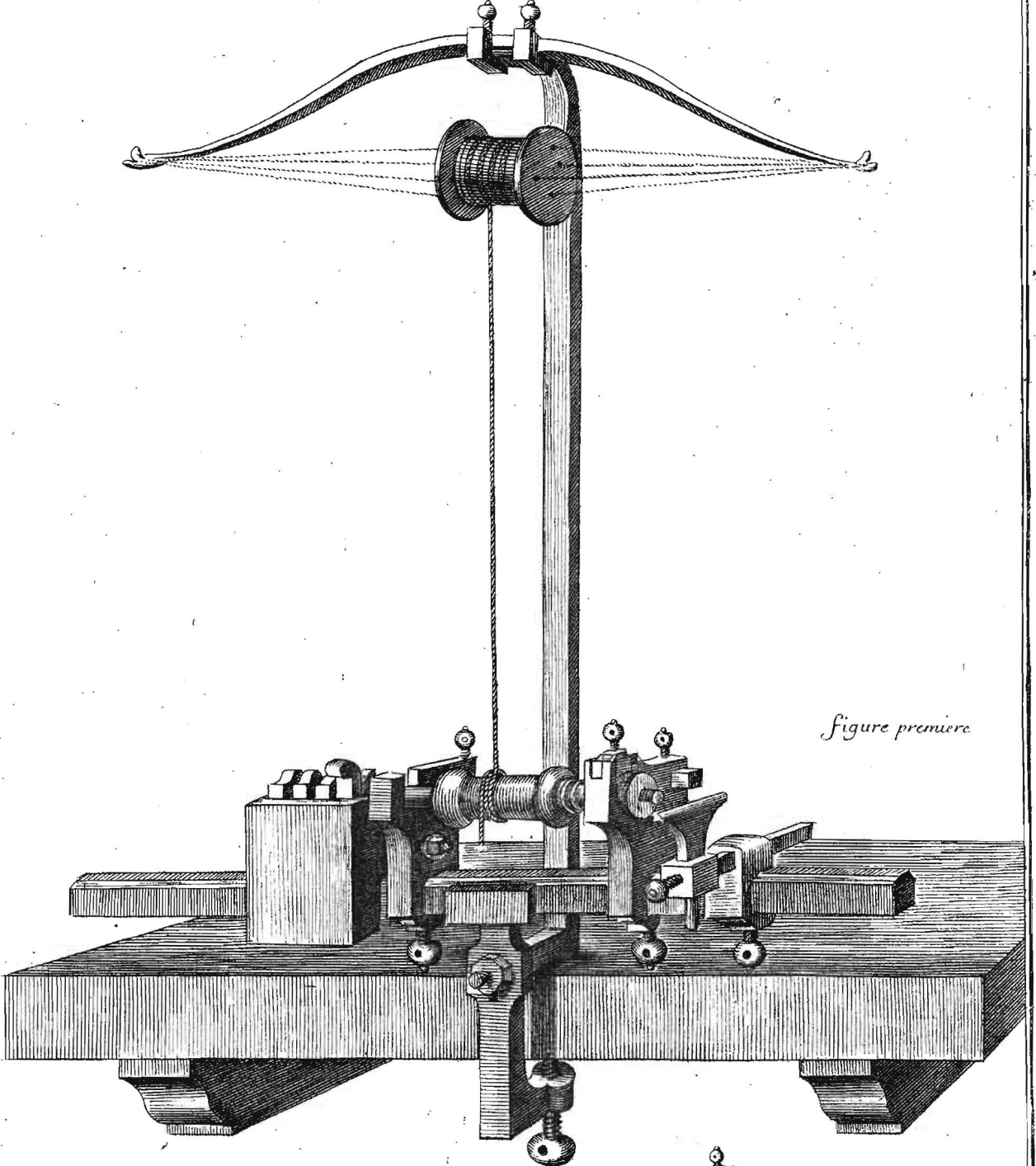


figure première

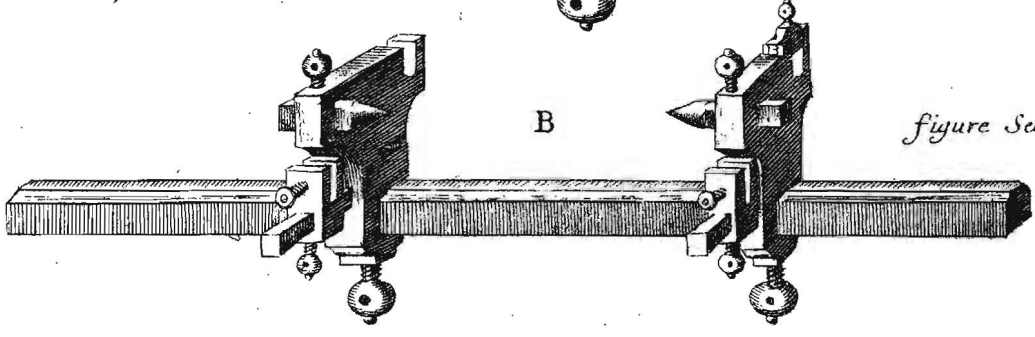
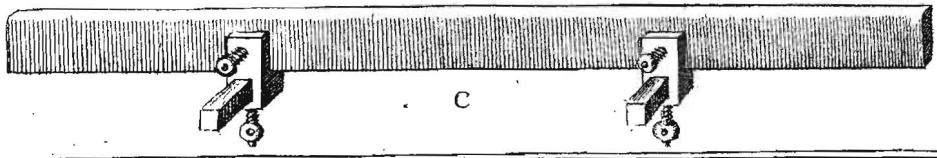
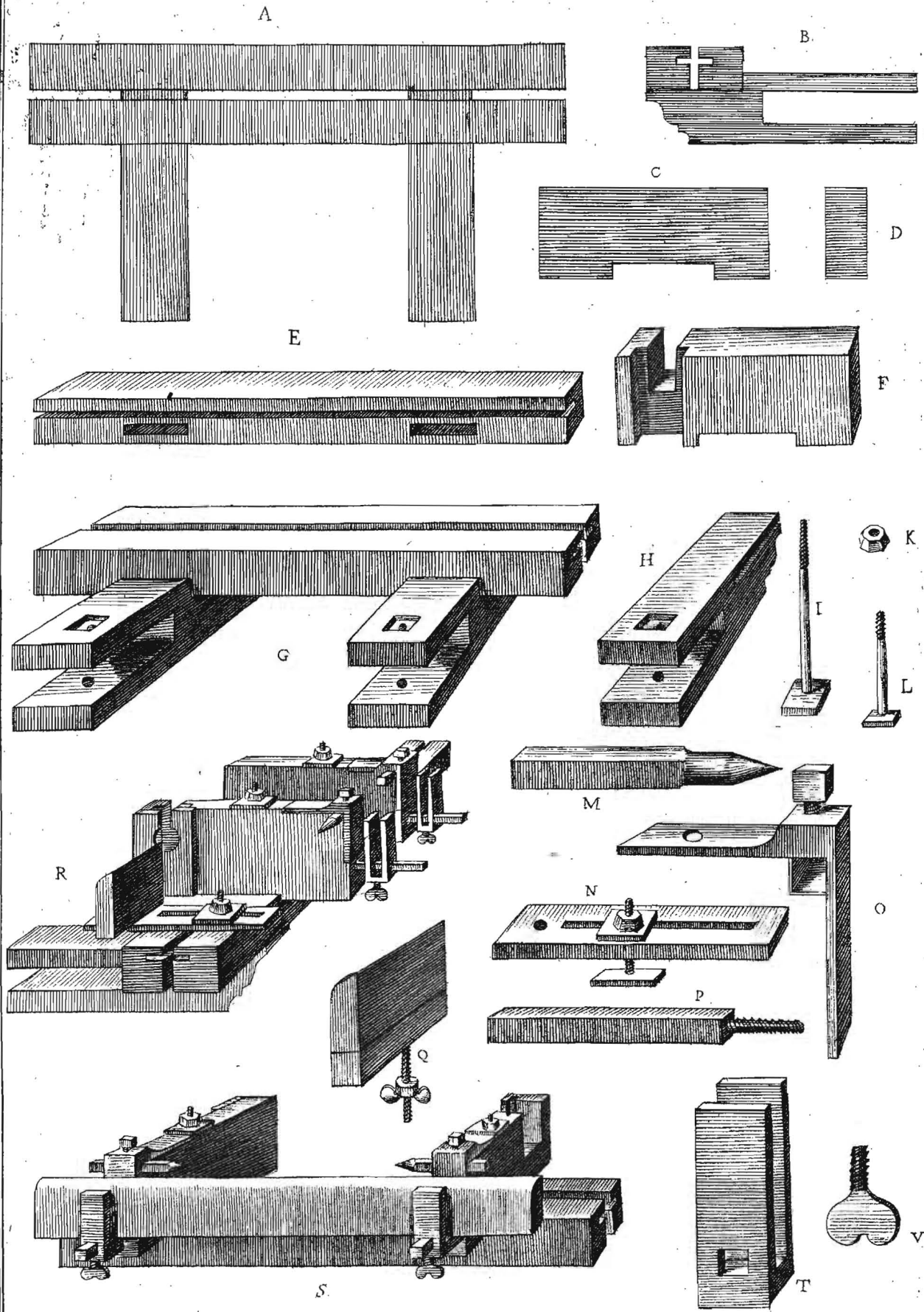


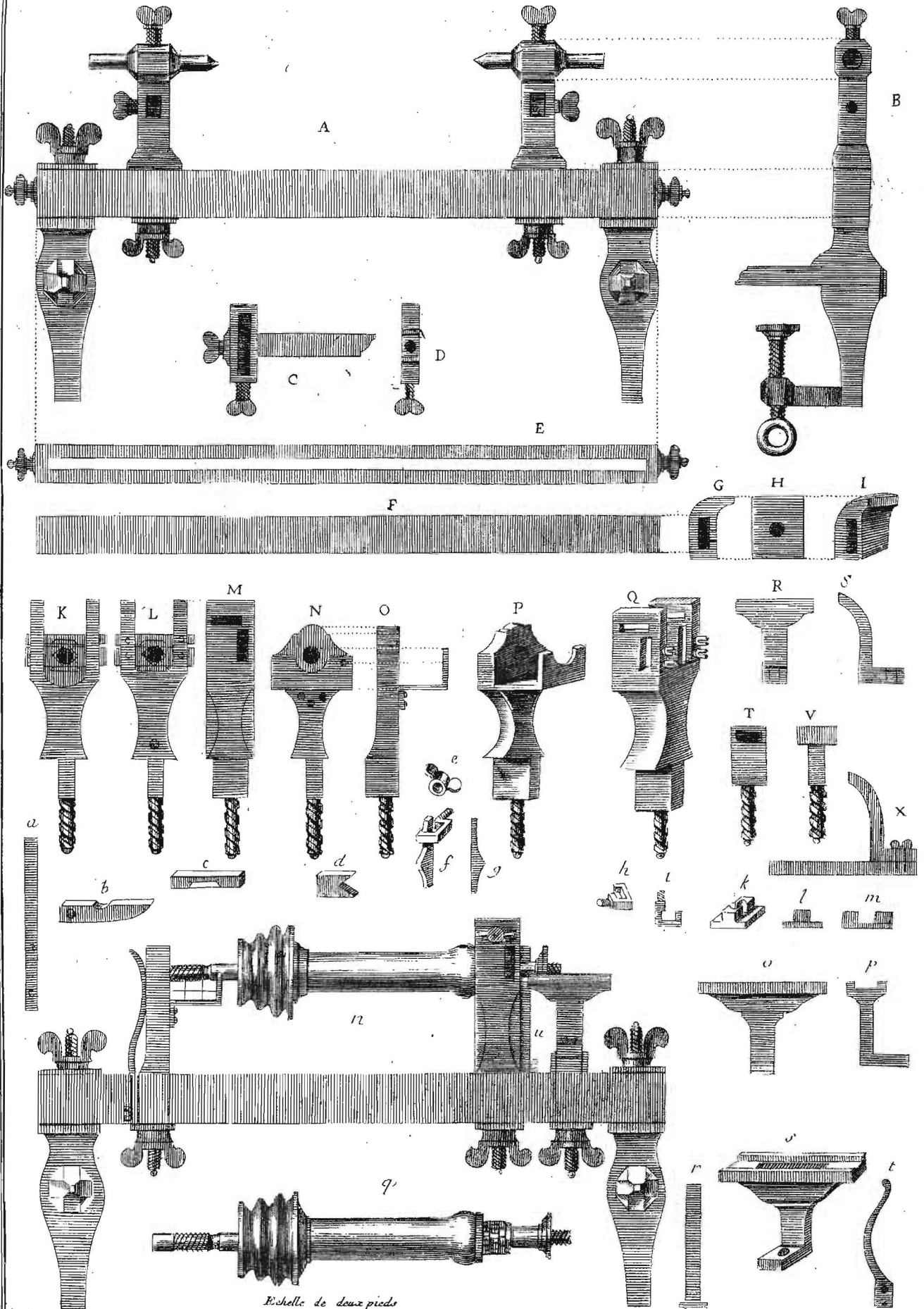
figure Seconde



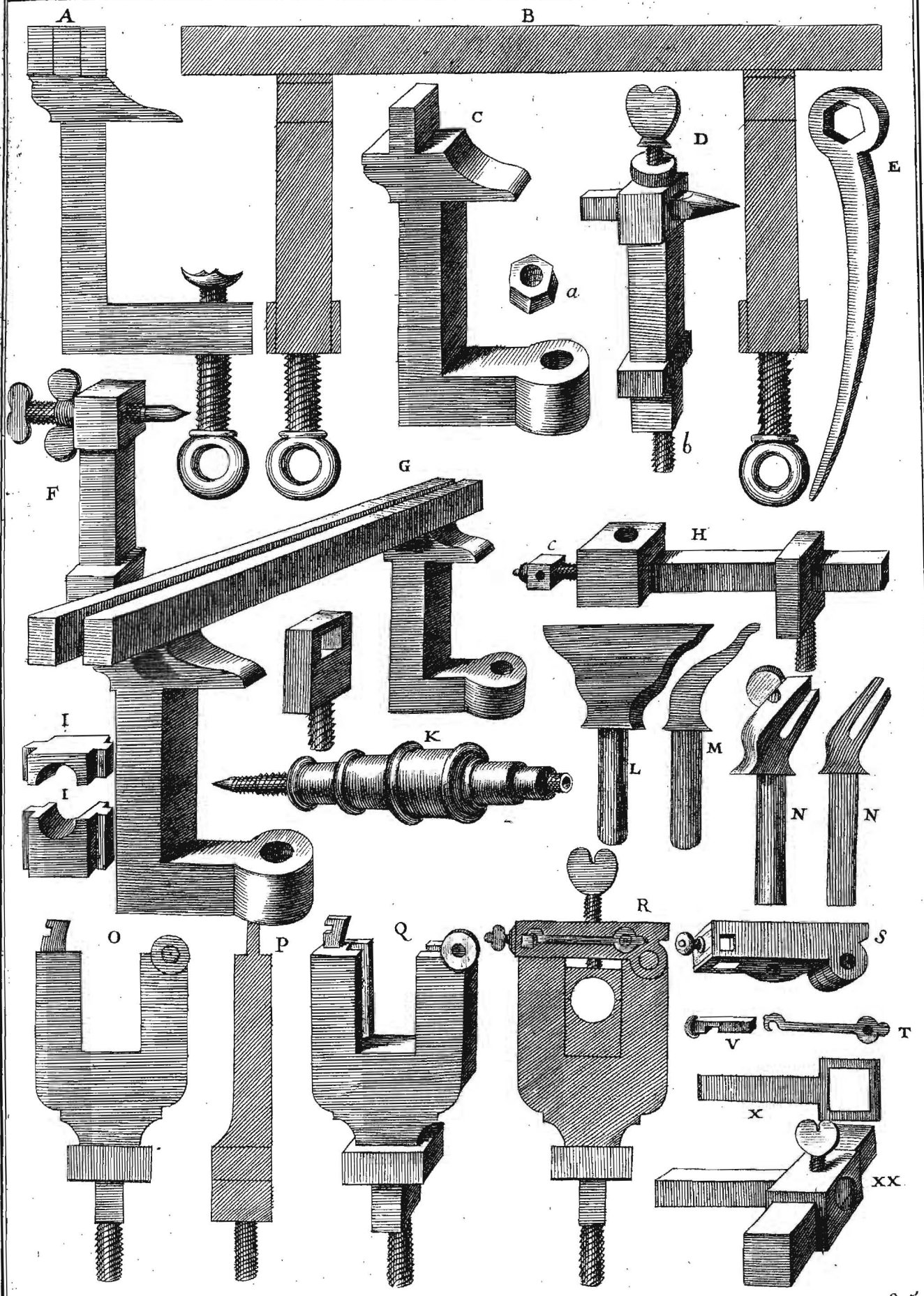
3e figure



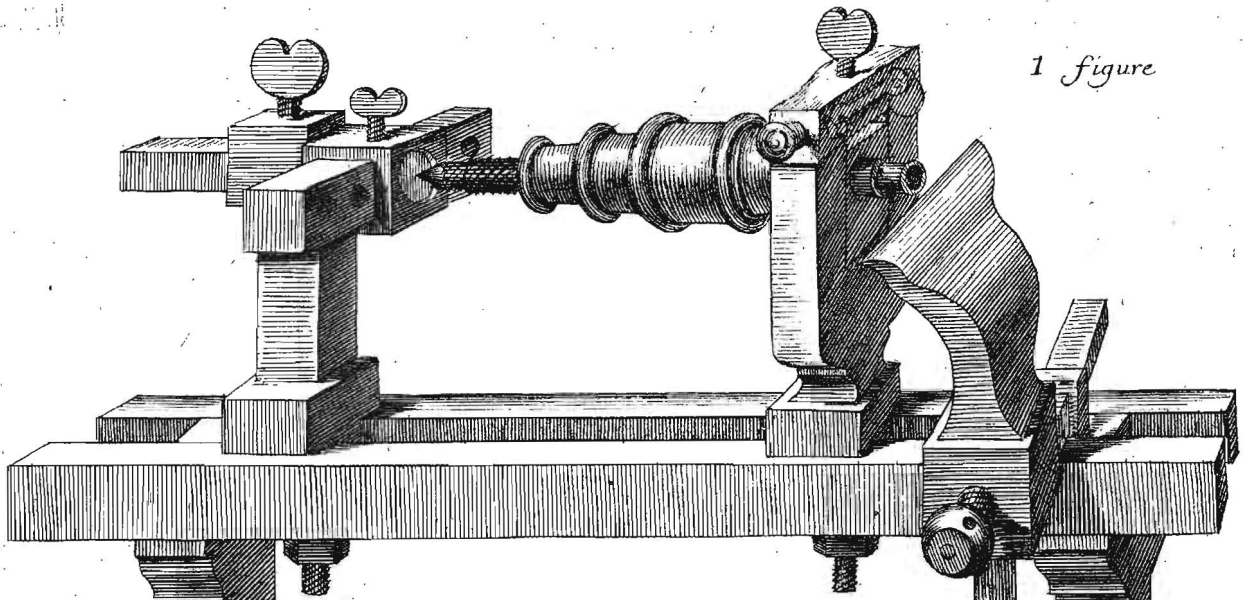




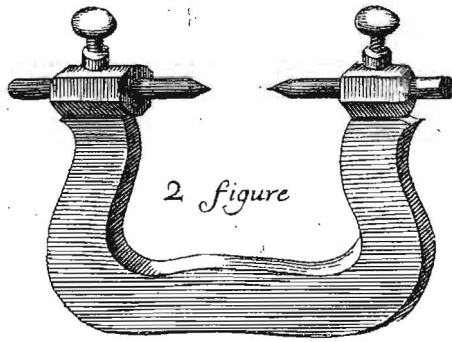
Echelle de deux pieds  
1 2 3 4 5 6 7 8 9 10 11 12 pouces



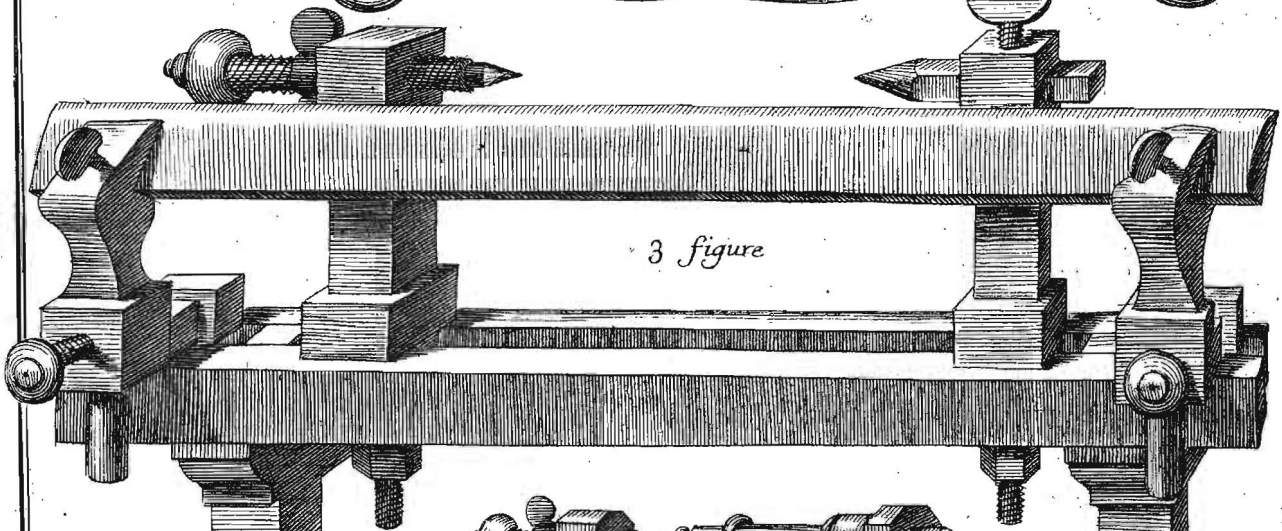
1 figure



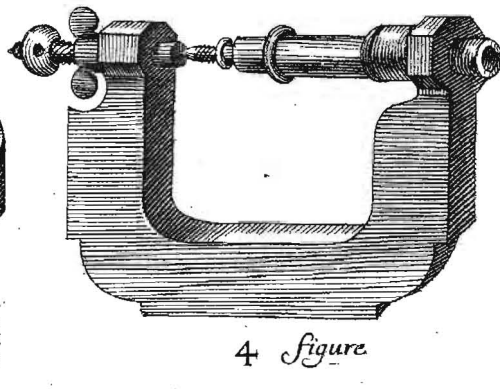
2 figure



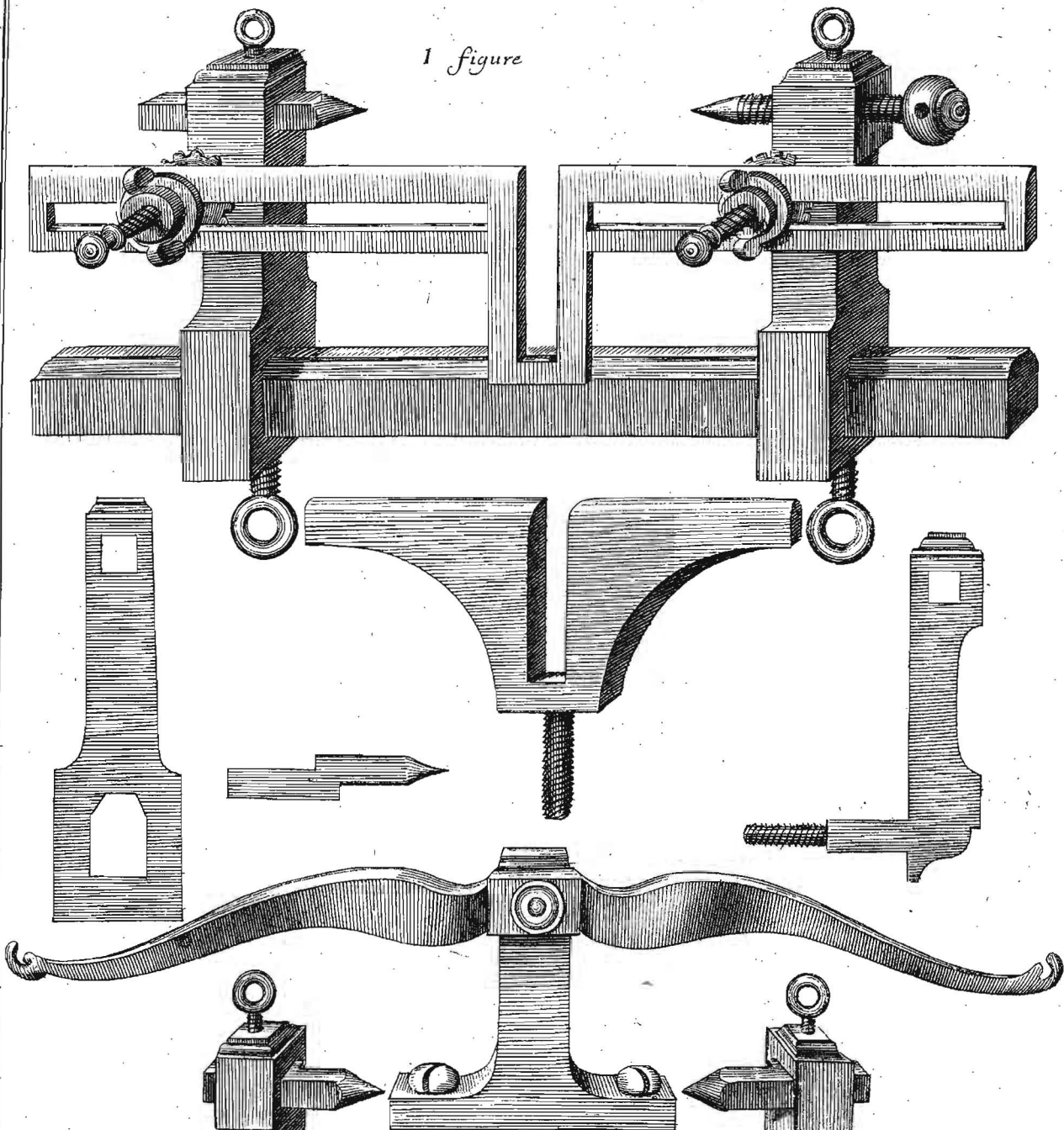
3 figure



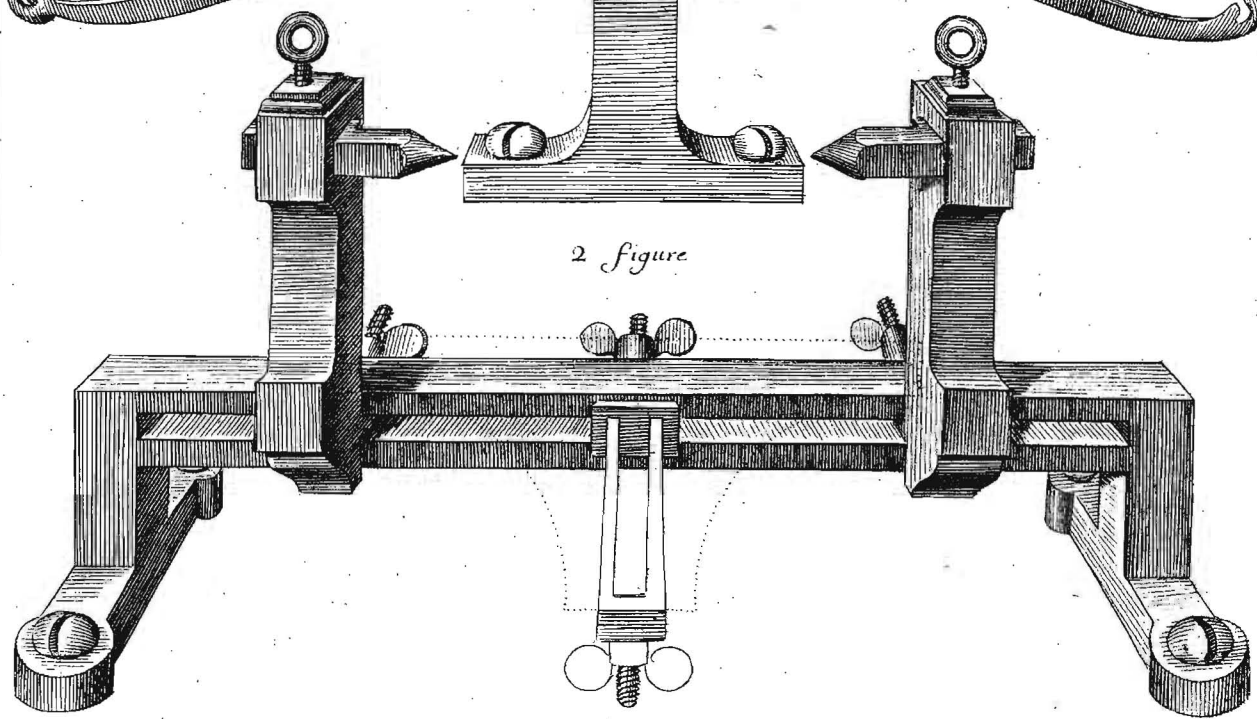
4 figure



1 figure

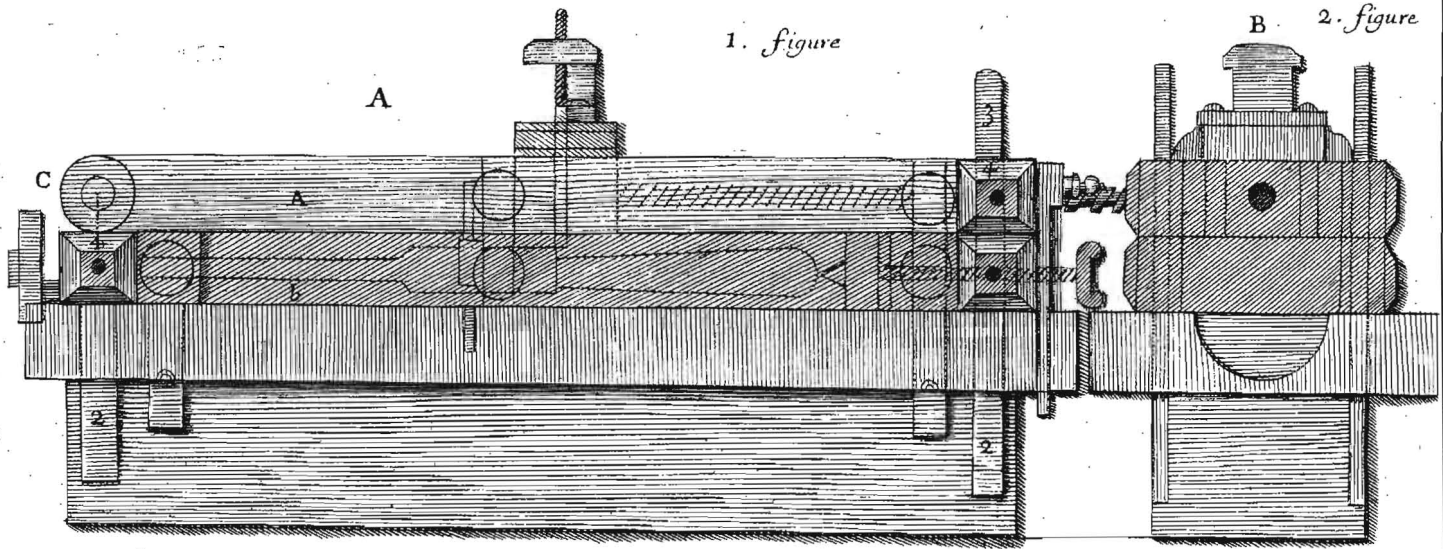


2 figure

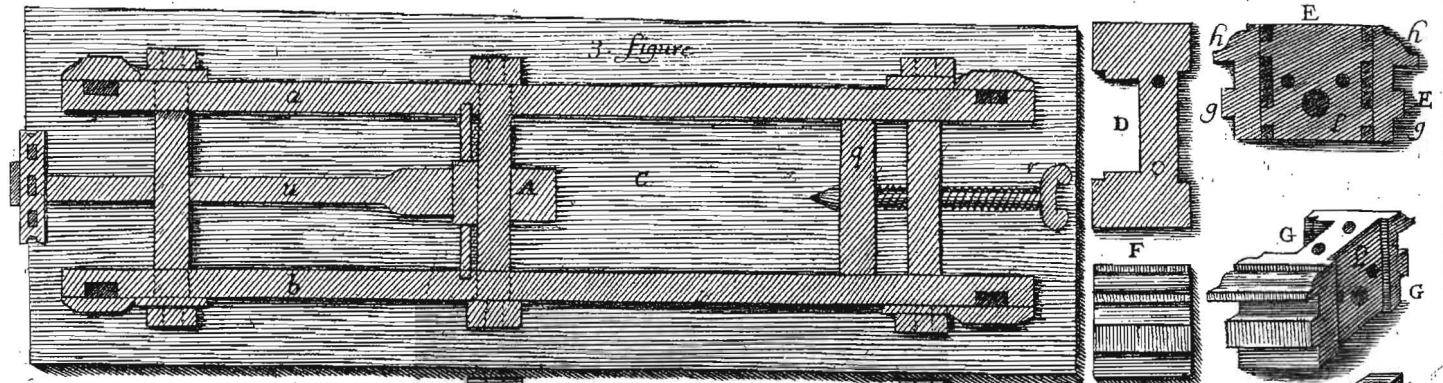


1. figure

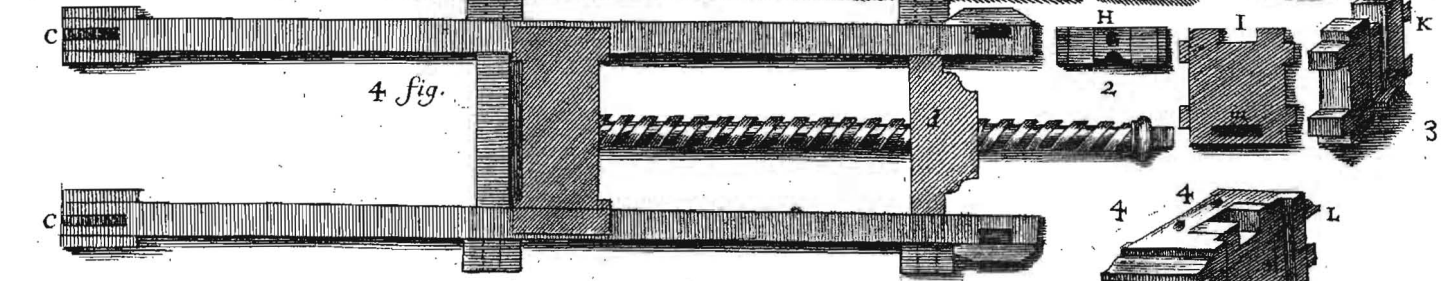
2. figure



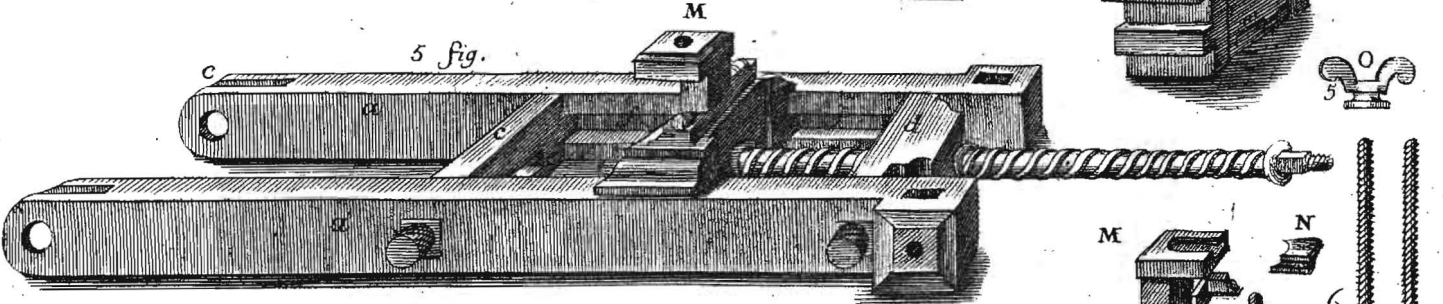
3. figure



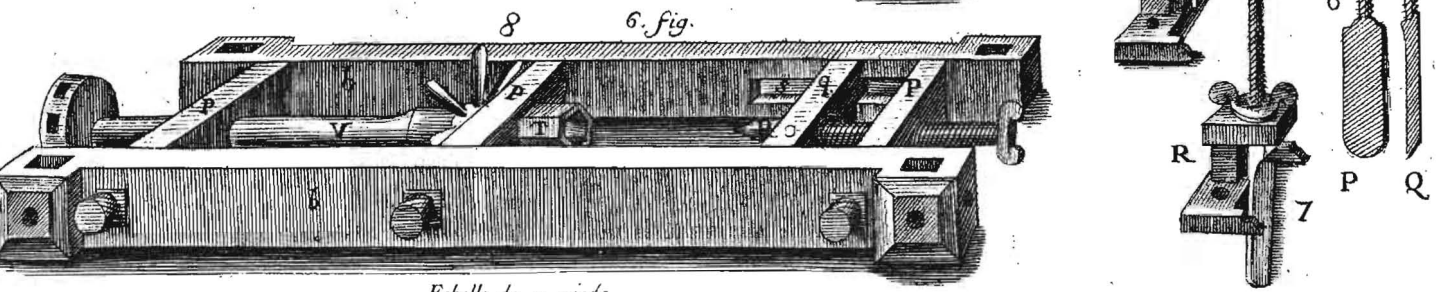
4 fig.



5 fig.



6. fig.



Echelle de 12 pieds

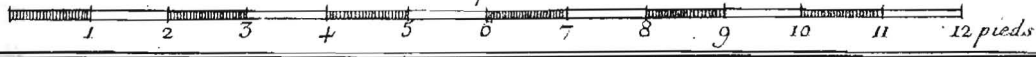


fig. premiere

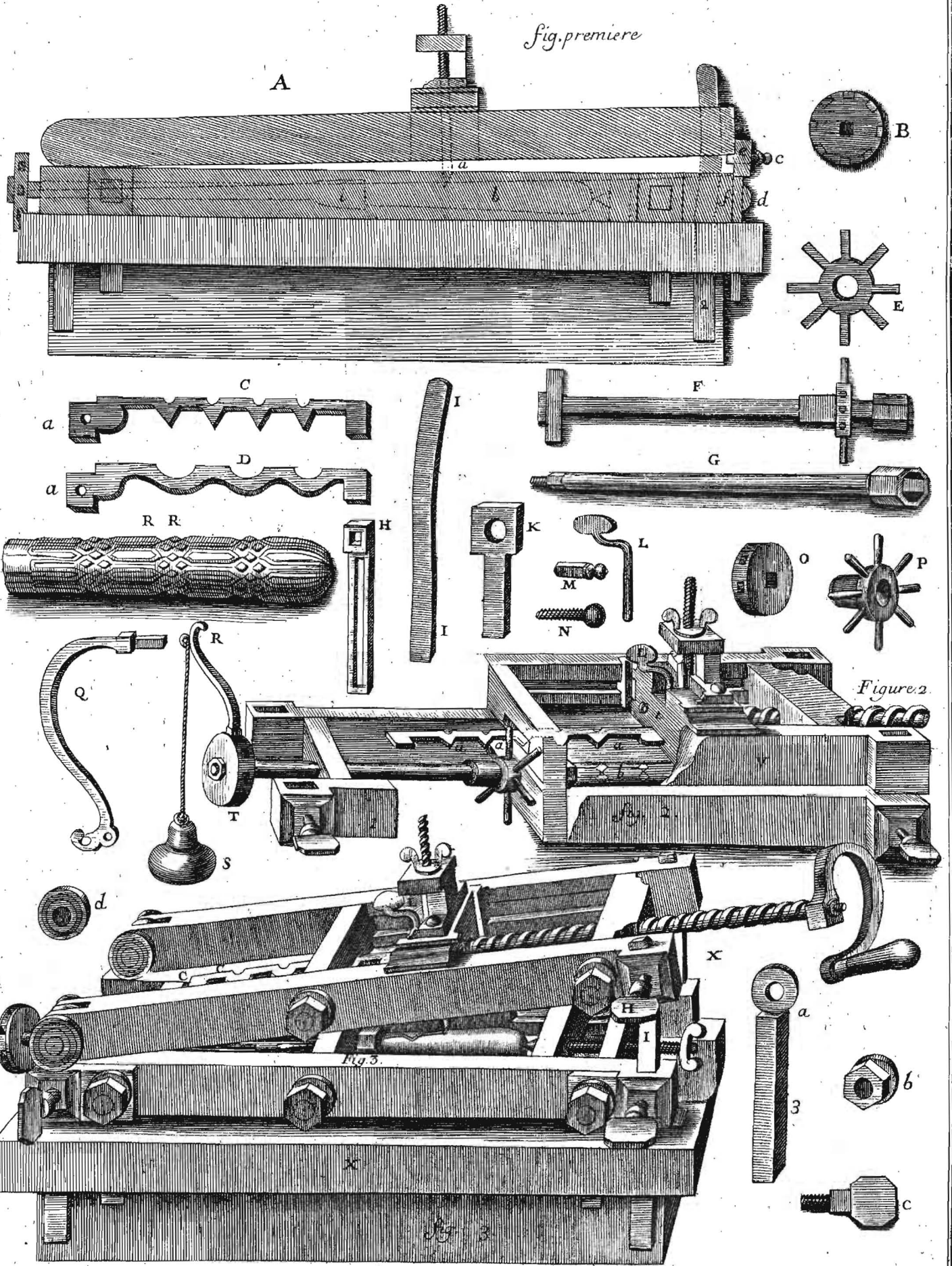
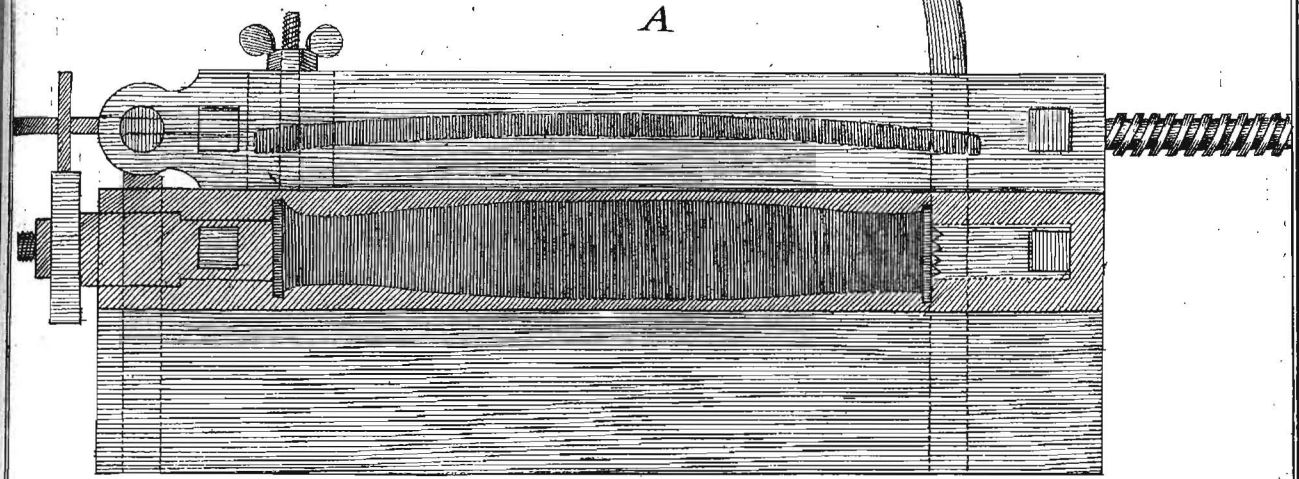
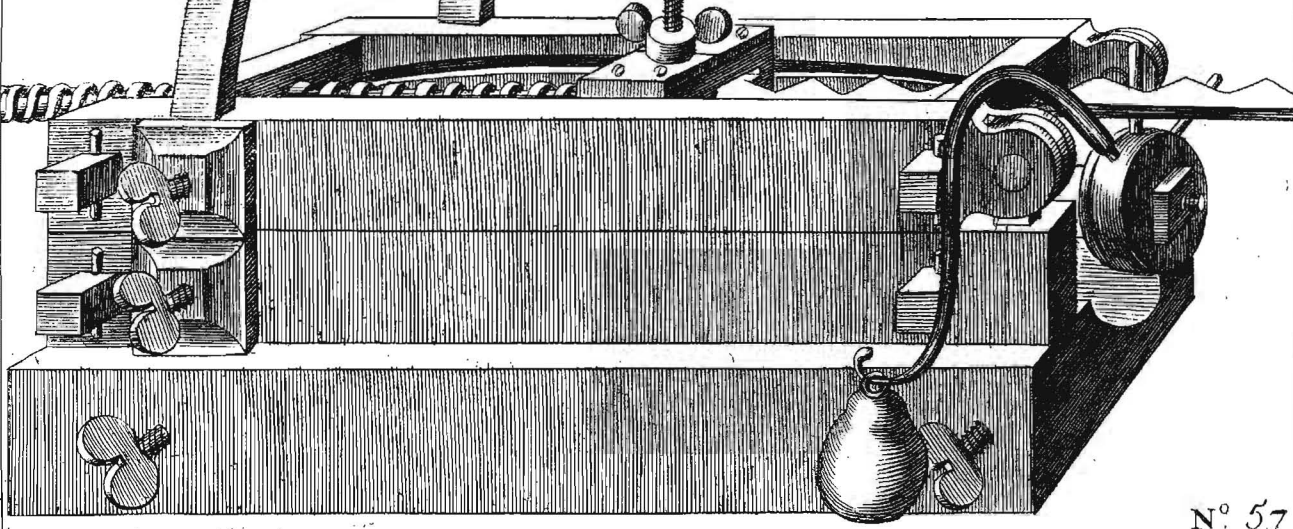
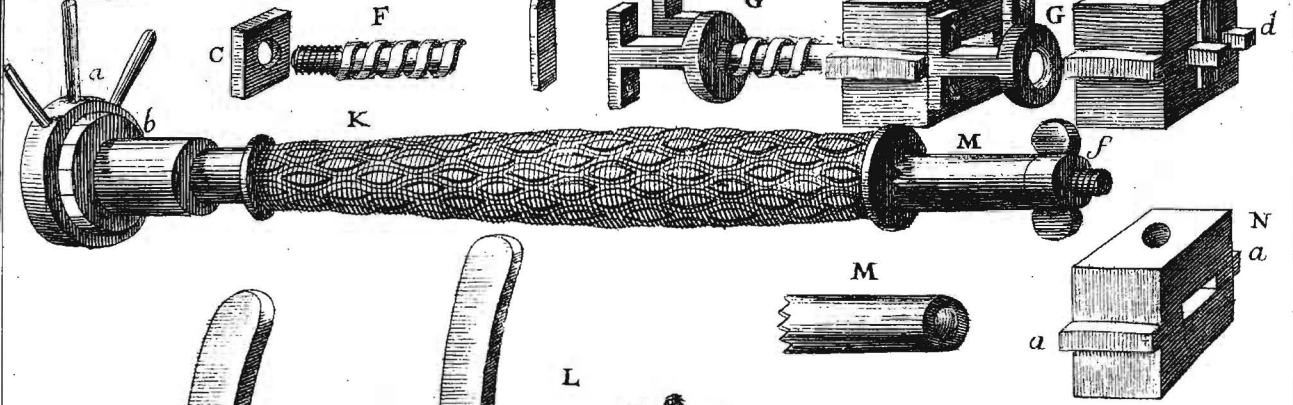
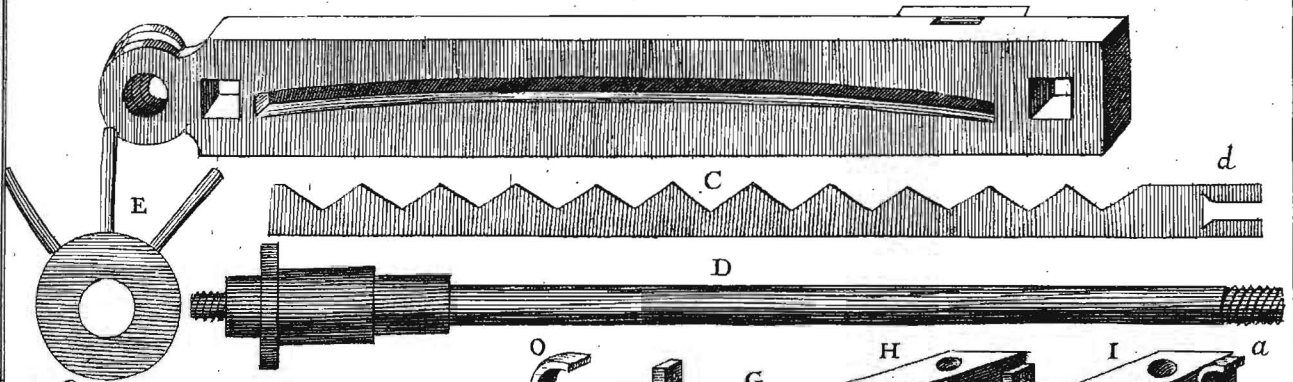


Figure.2

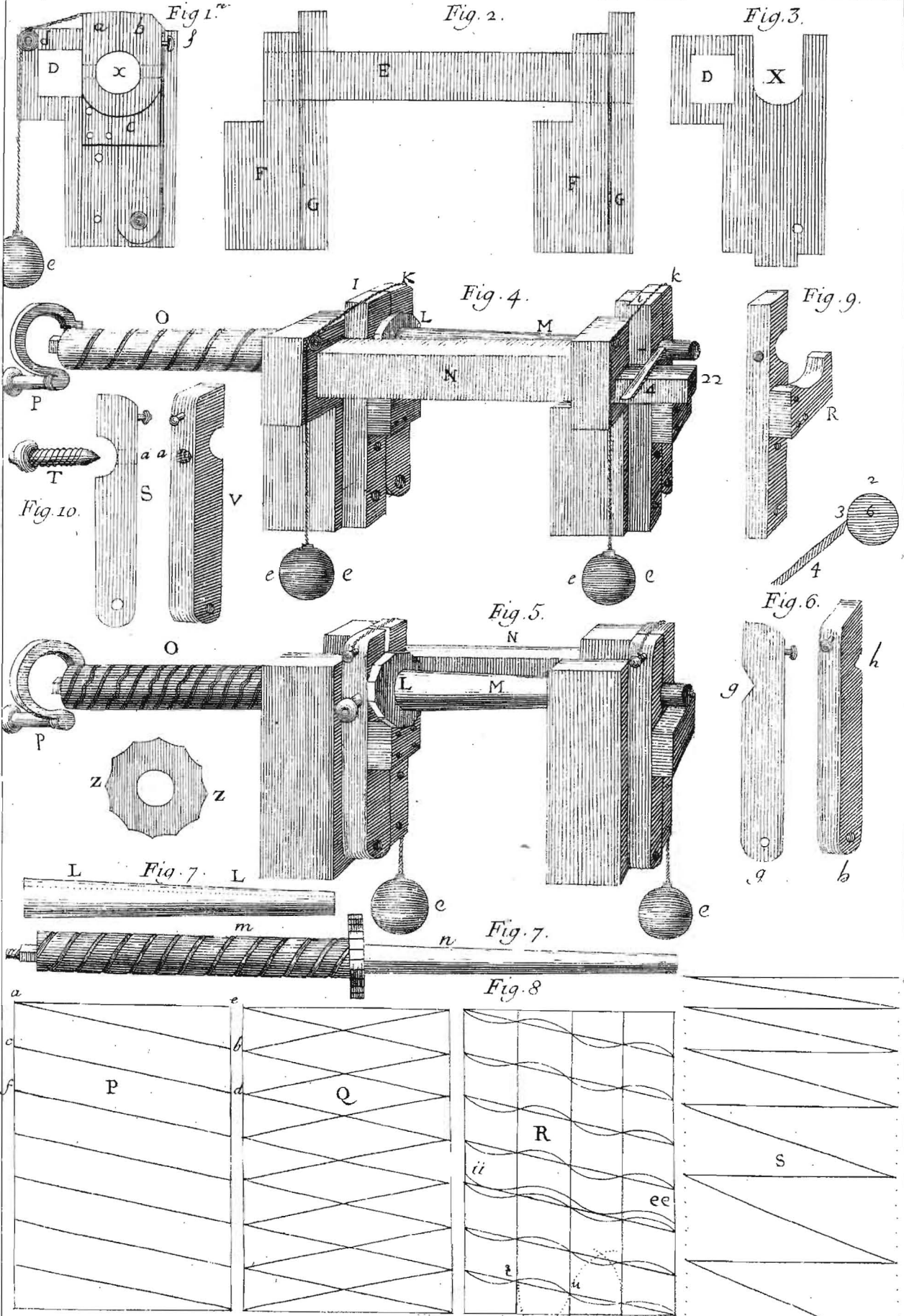
fig. 3.



B







1 2 3 4 5 6 7 8 9 10 11 12 polces

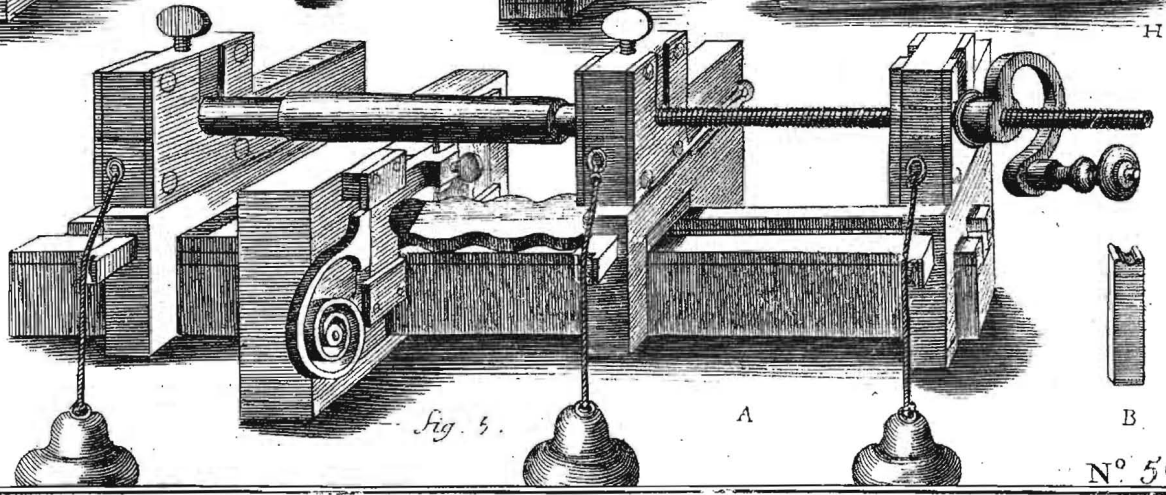
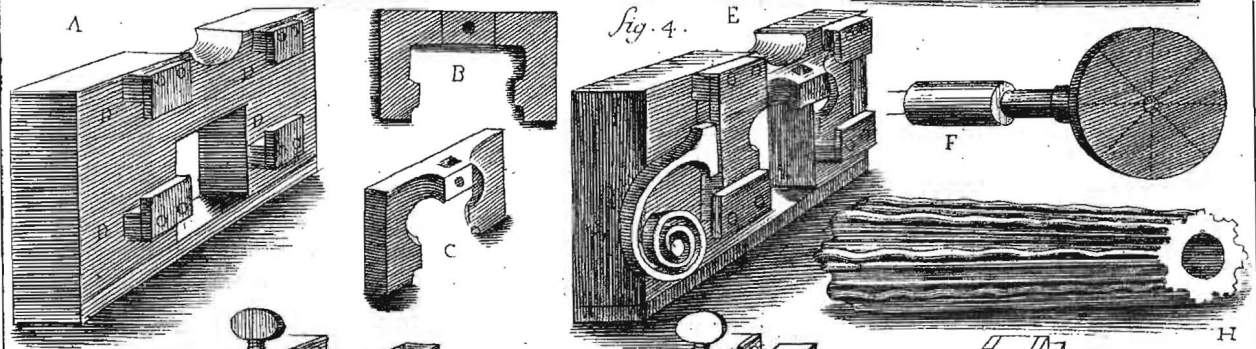
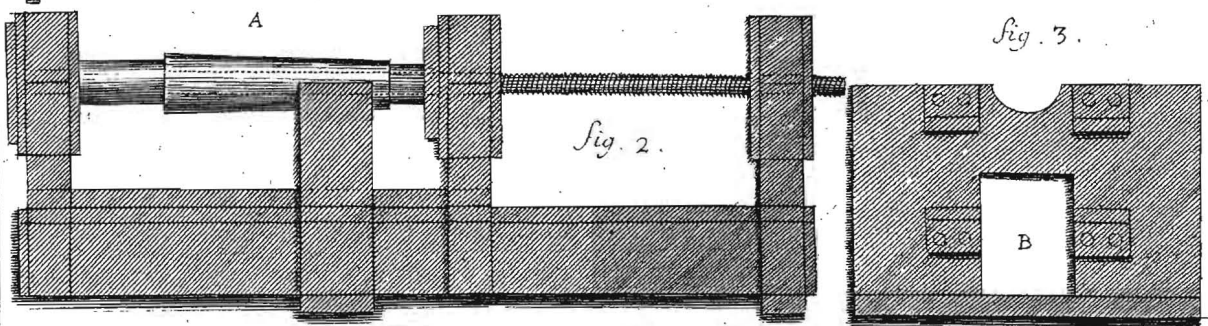
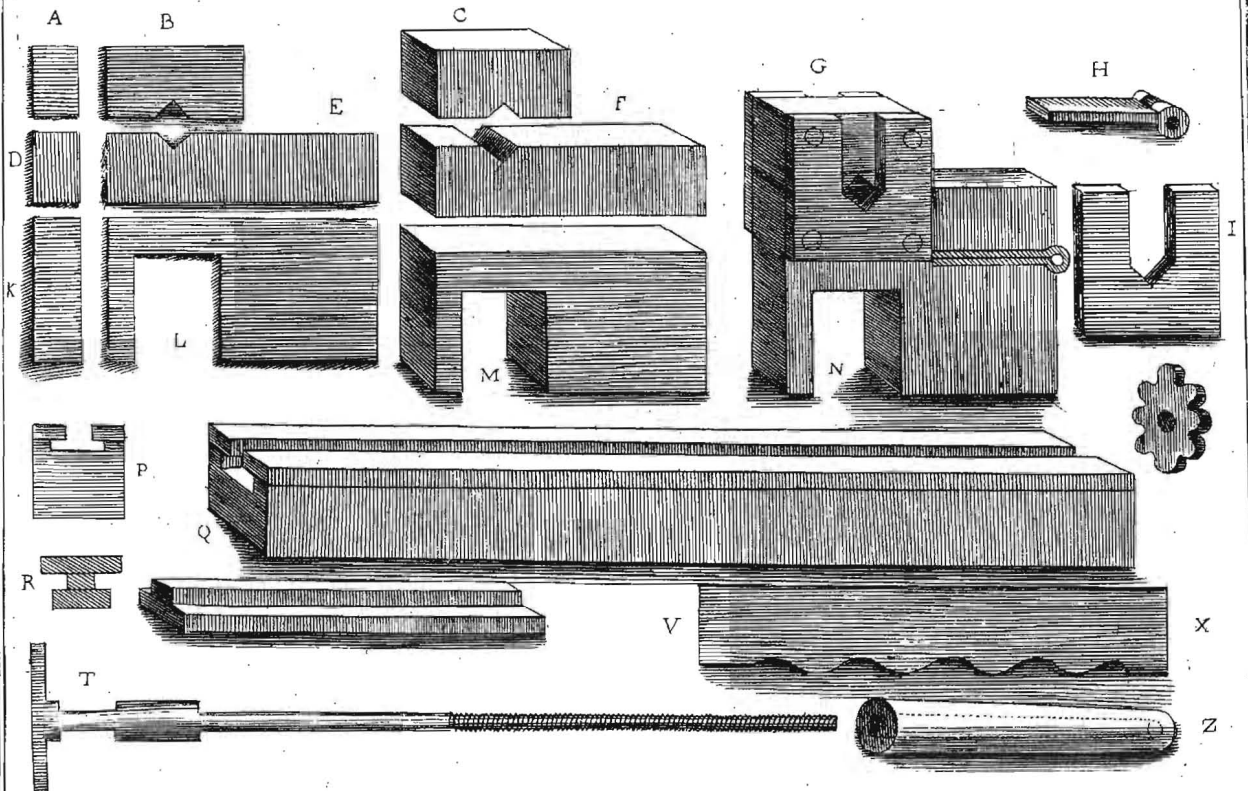


Figure premiere

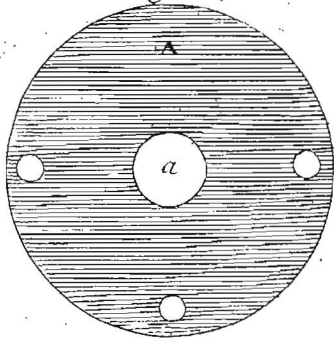


Fig 2



Fig 3 c

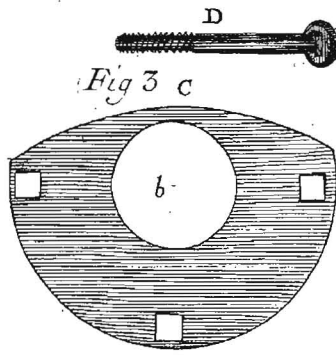


Fig 4

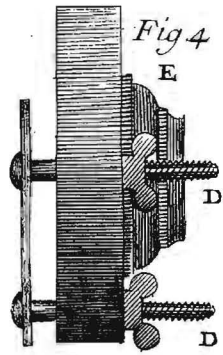


Fig 5

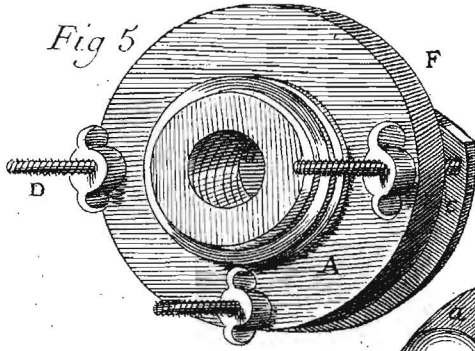
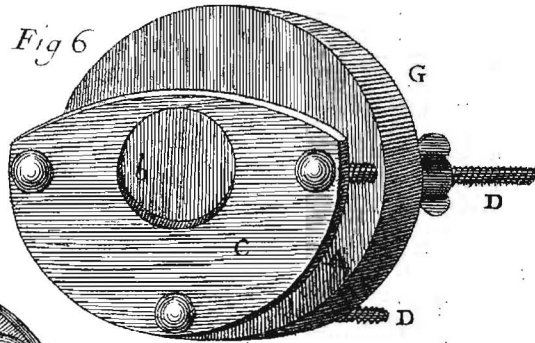


Fig 6



H Fig 7

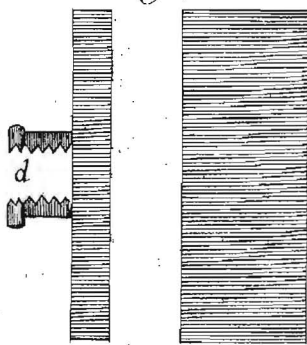


Fig 8.

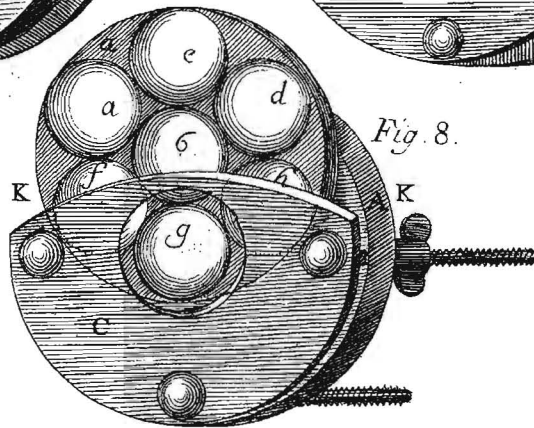


Fig 9

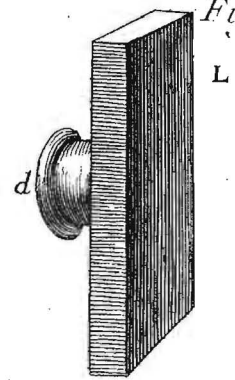


Fig 10.

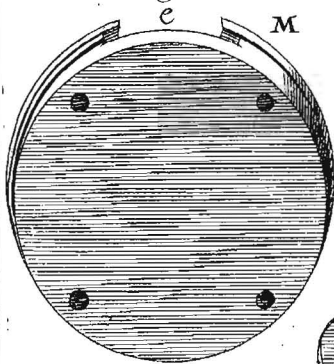


Fig 11

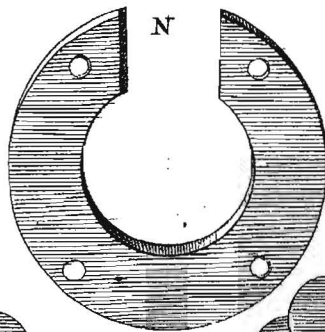


Fig 12

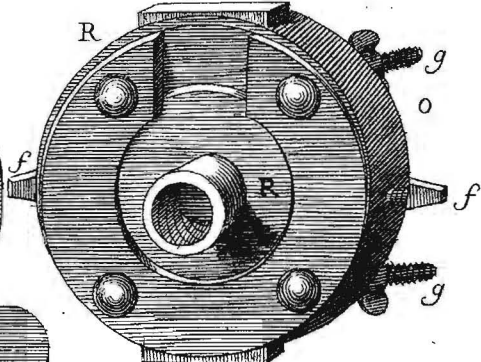


Fig 13



Fig 14

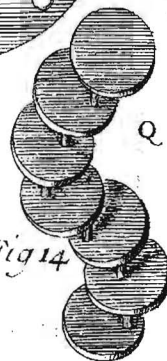
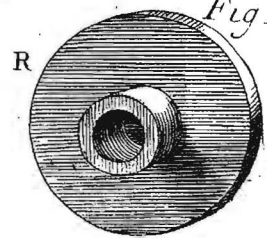
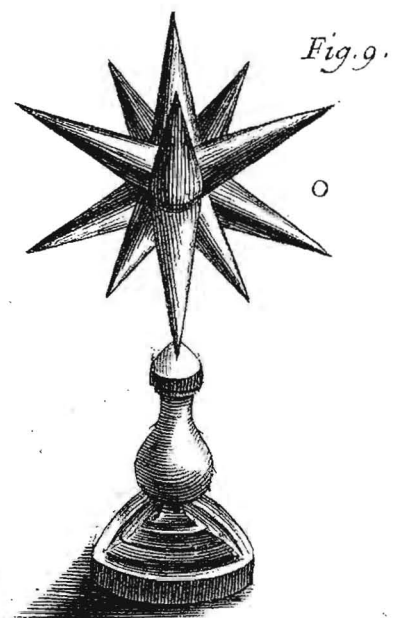
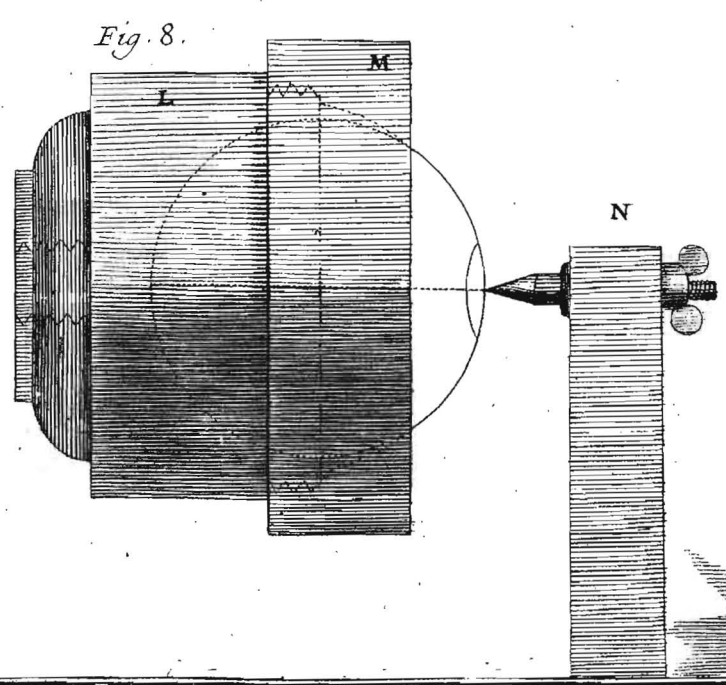
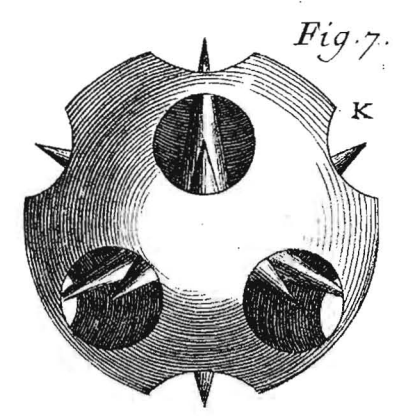
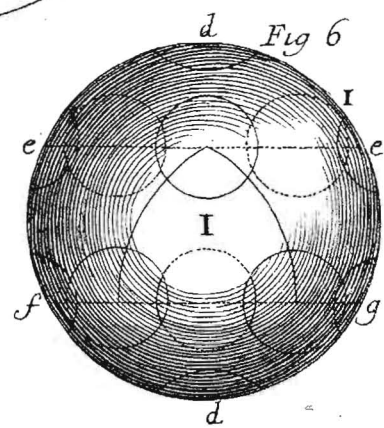
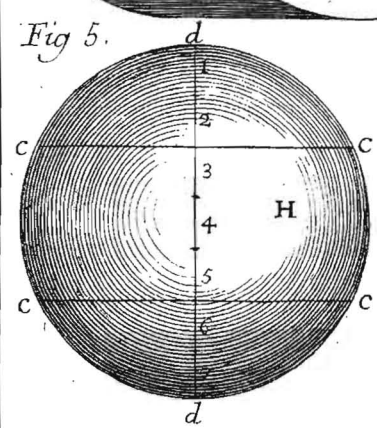
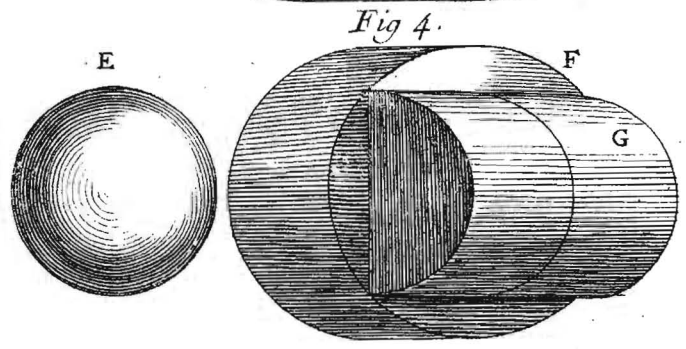
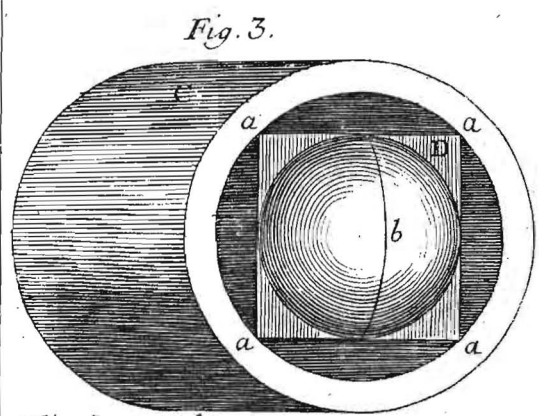
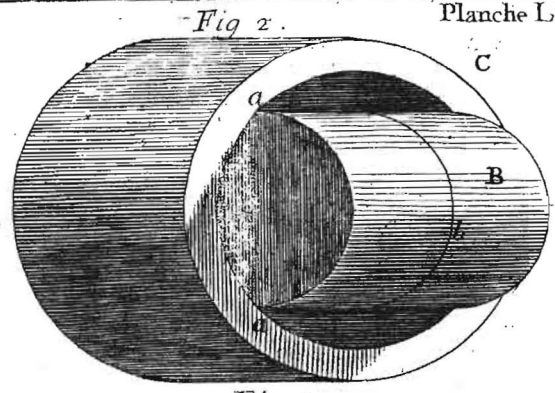
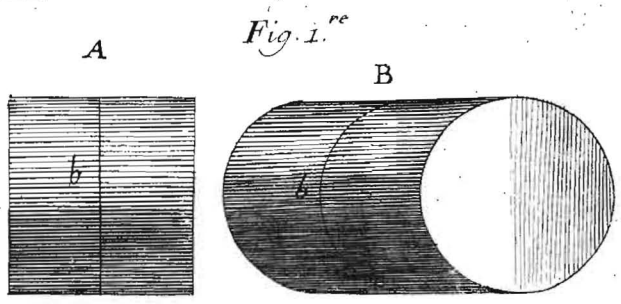
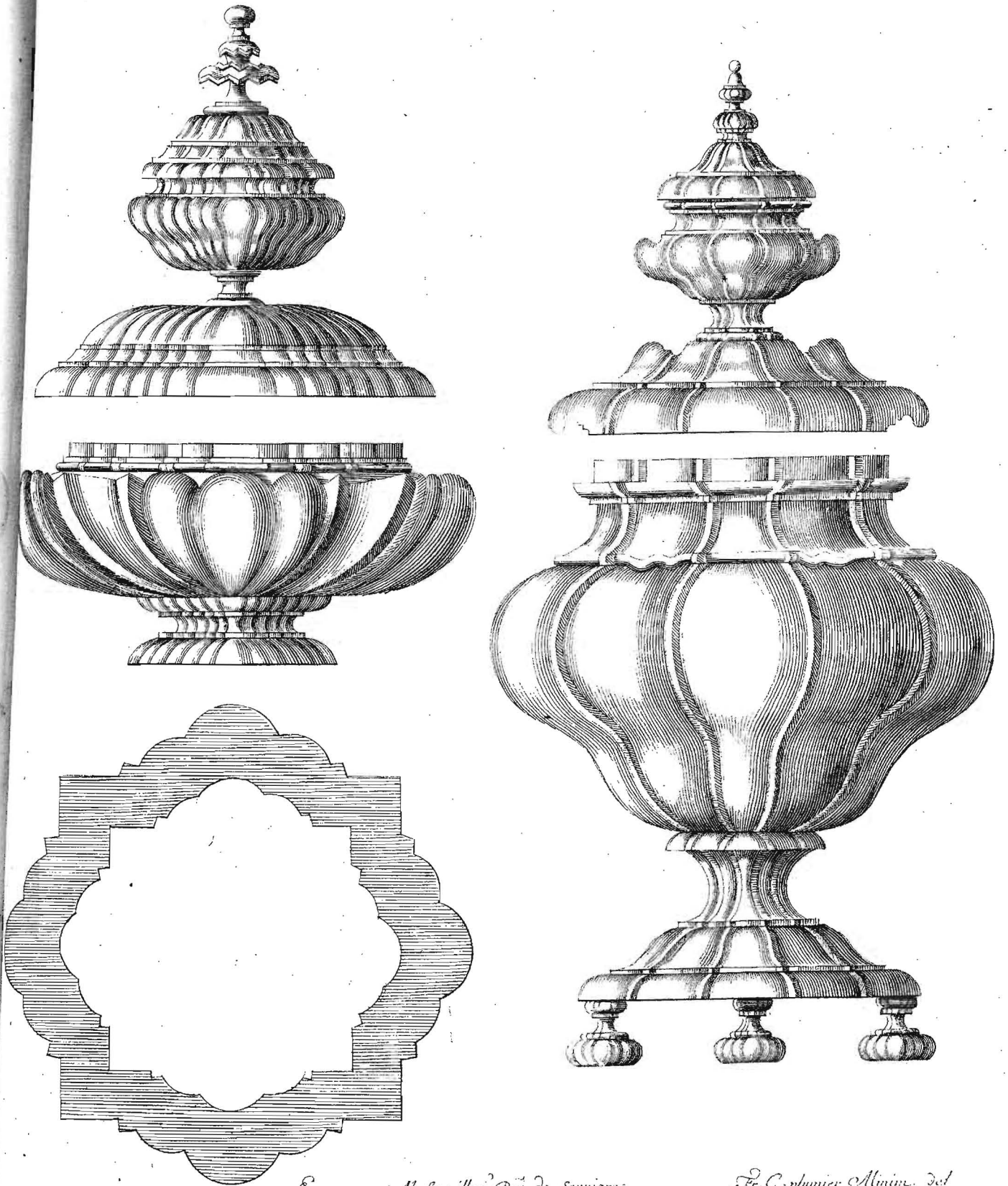


Fig 15

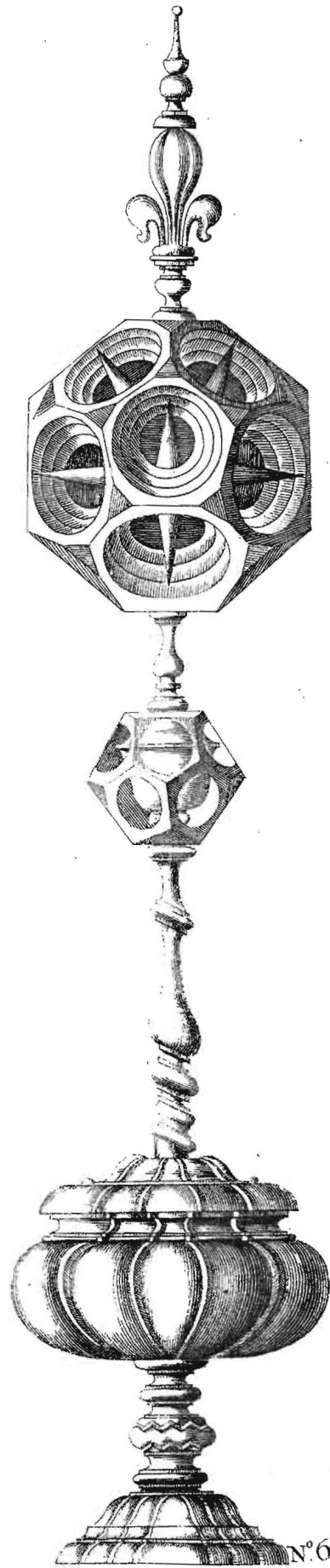


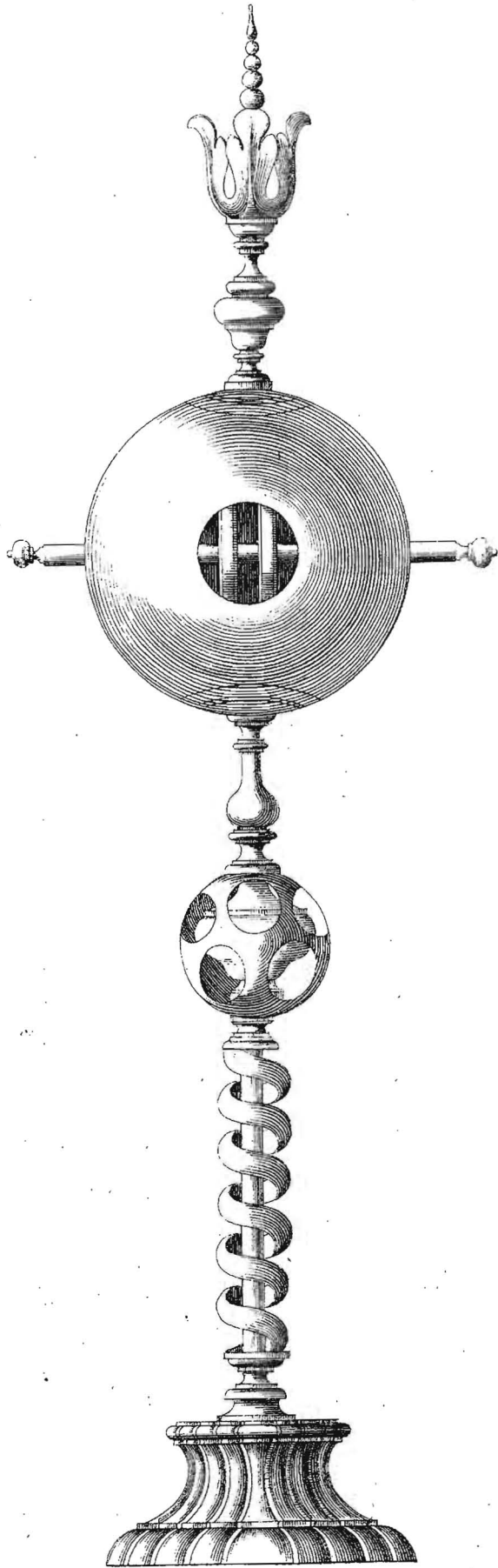




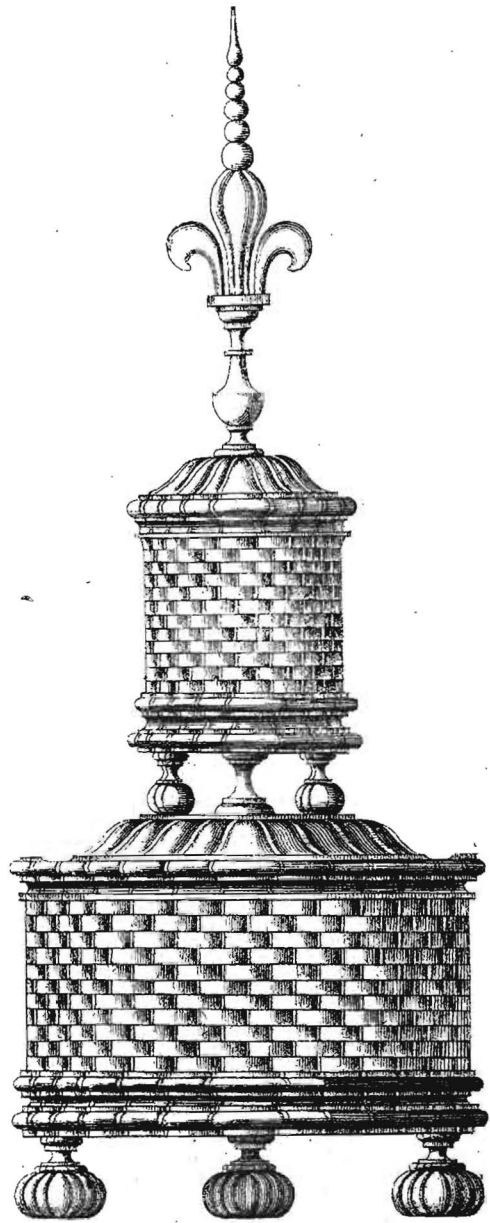
Ex manu et Museo illis Dni de Serruores

Fr. C. plancier Minim. del  
N° 62

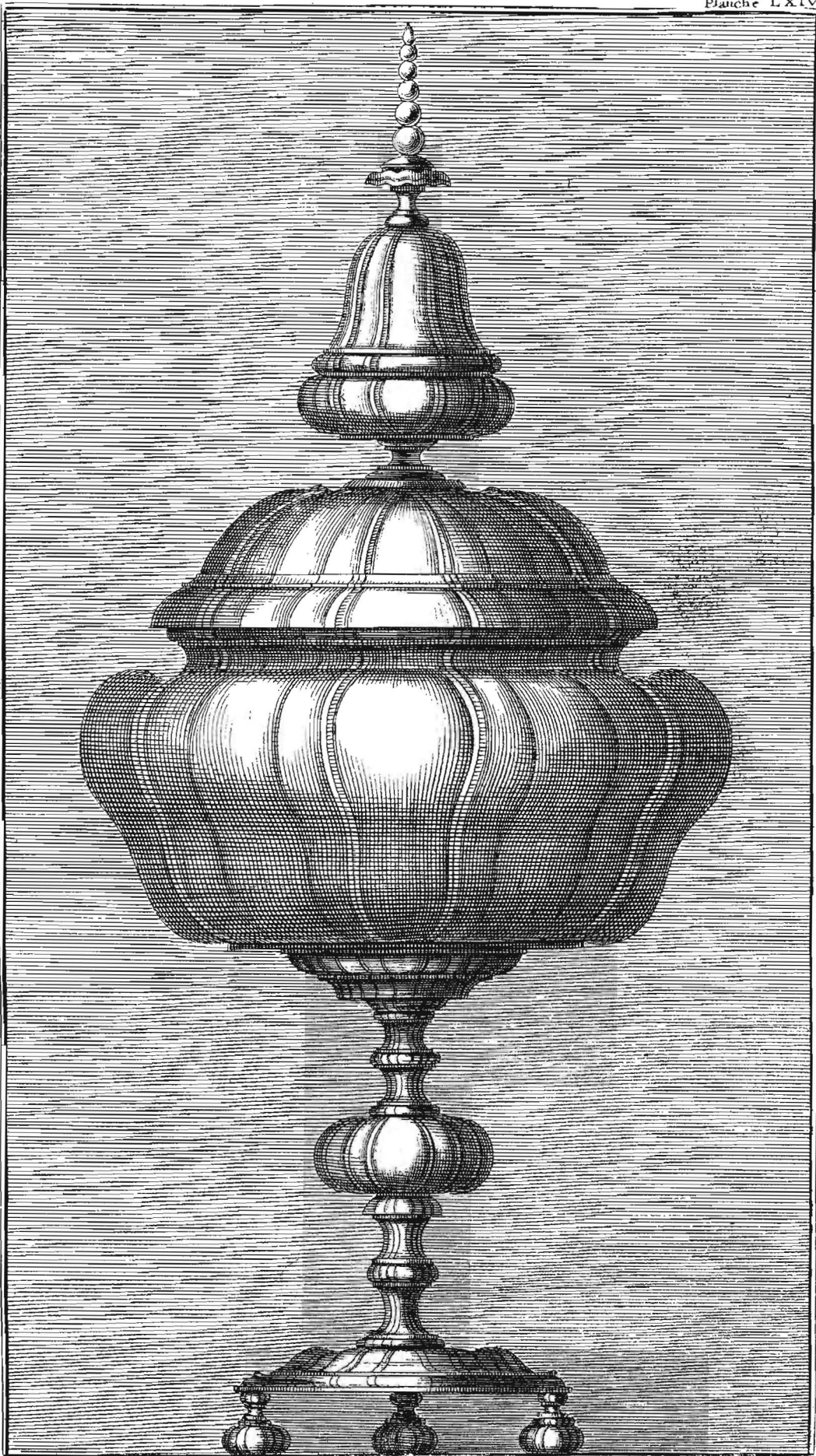




*Ex manu et musæo P. de Seruières*

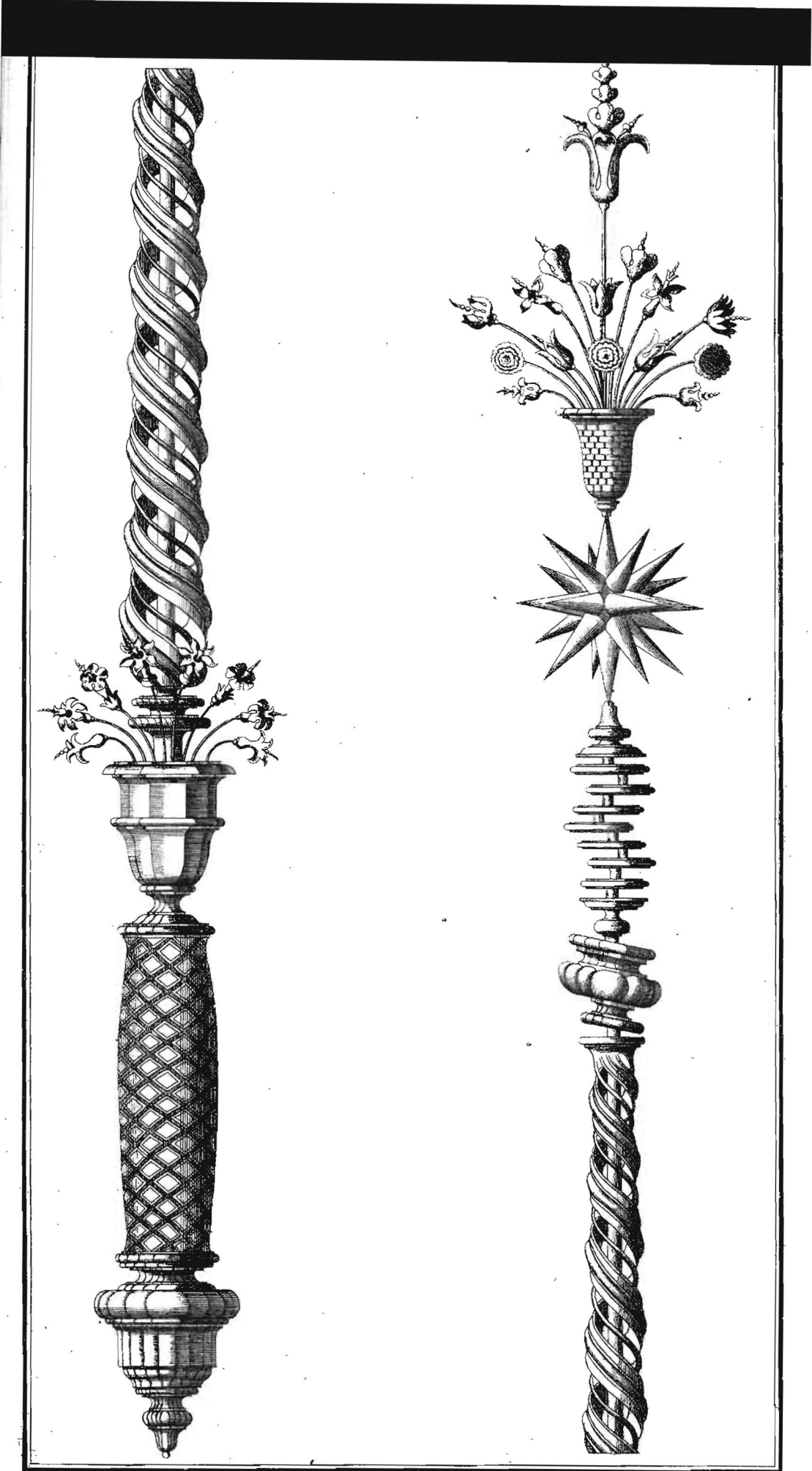


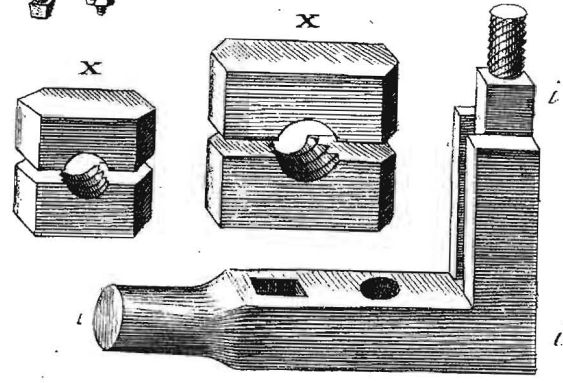
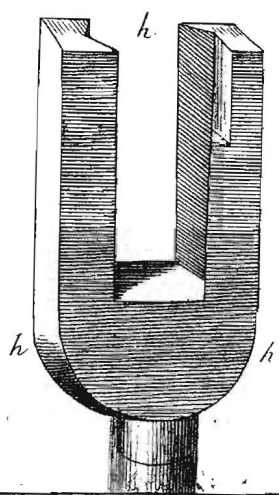
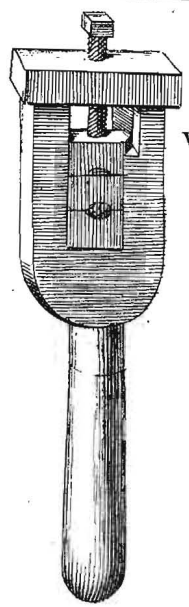
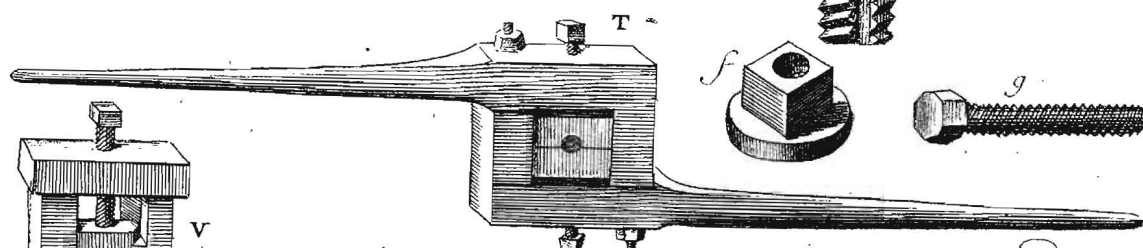
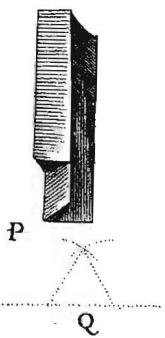
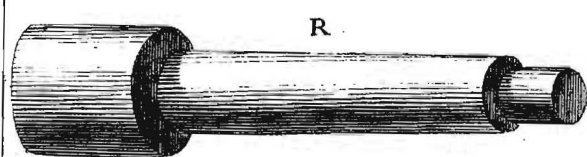
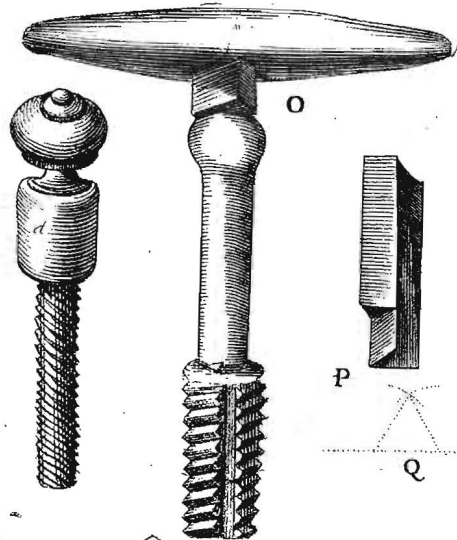
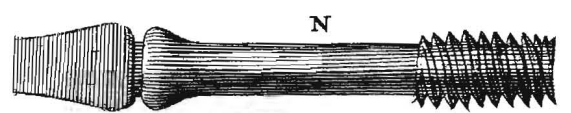
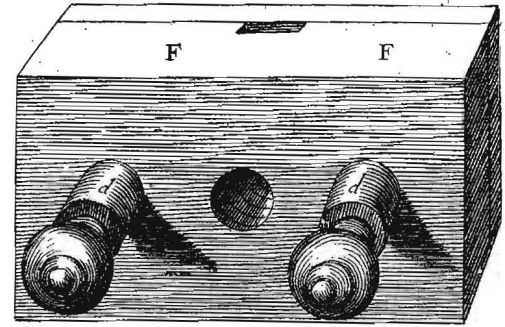
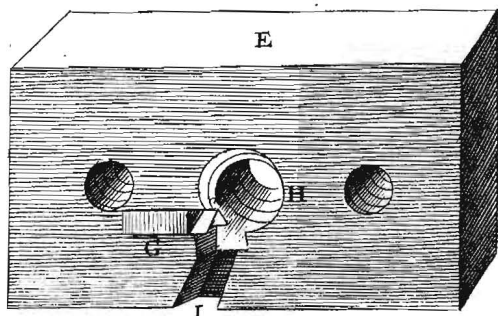
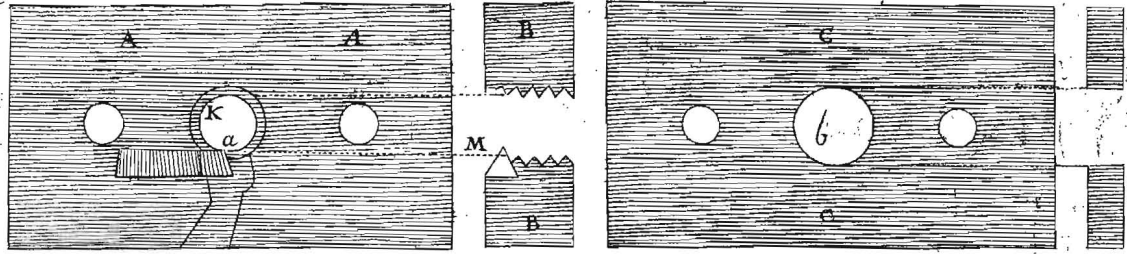
*Fr. C. plumier minimus delineavit  
N<sup>o</sup> 64*

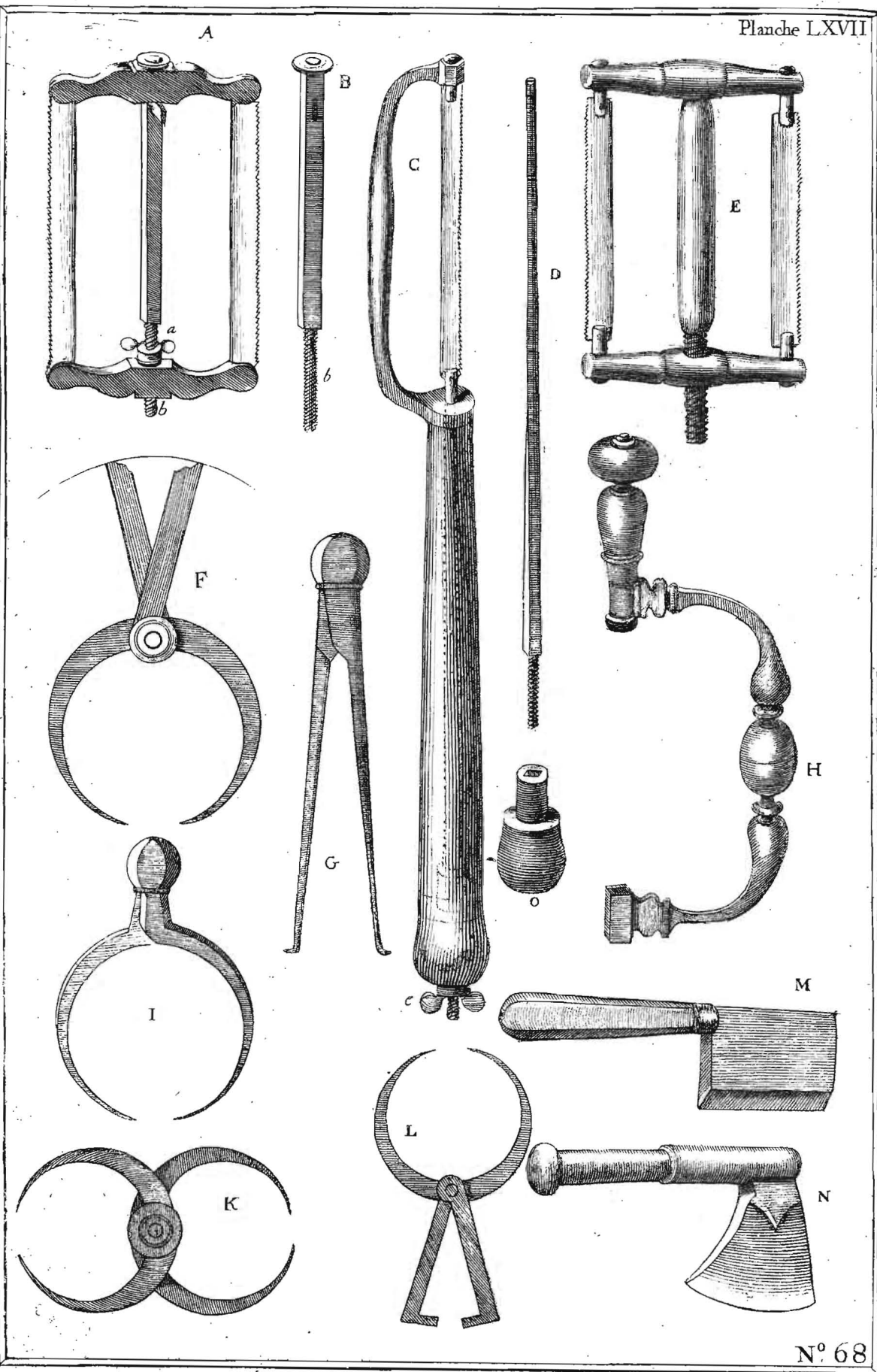


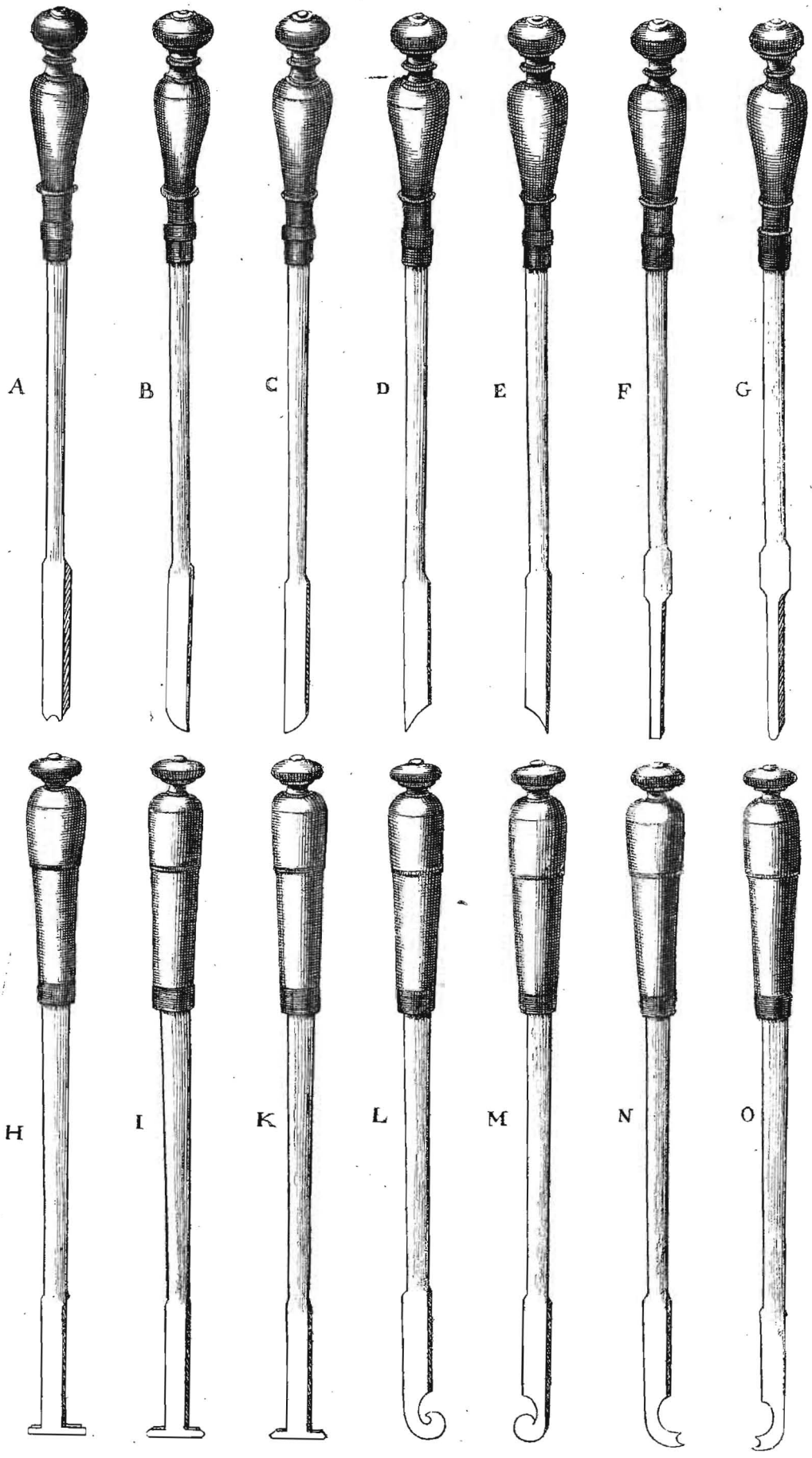
*J.C. Plumier miniaturus Masliensis delit? lugduni 1700.*

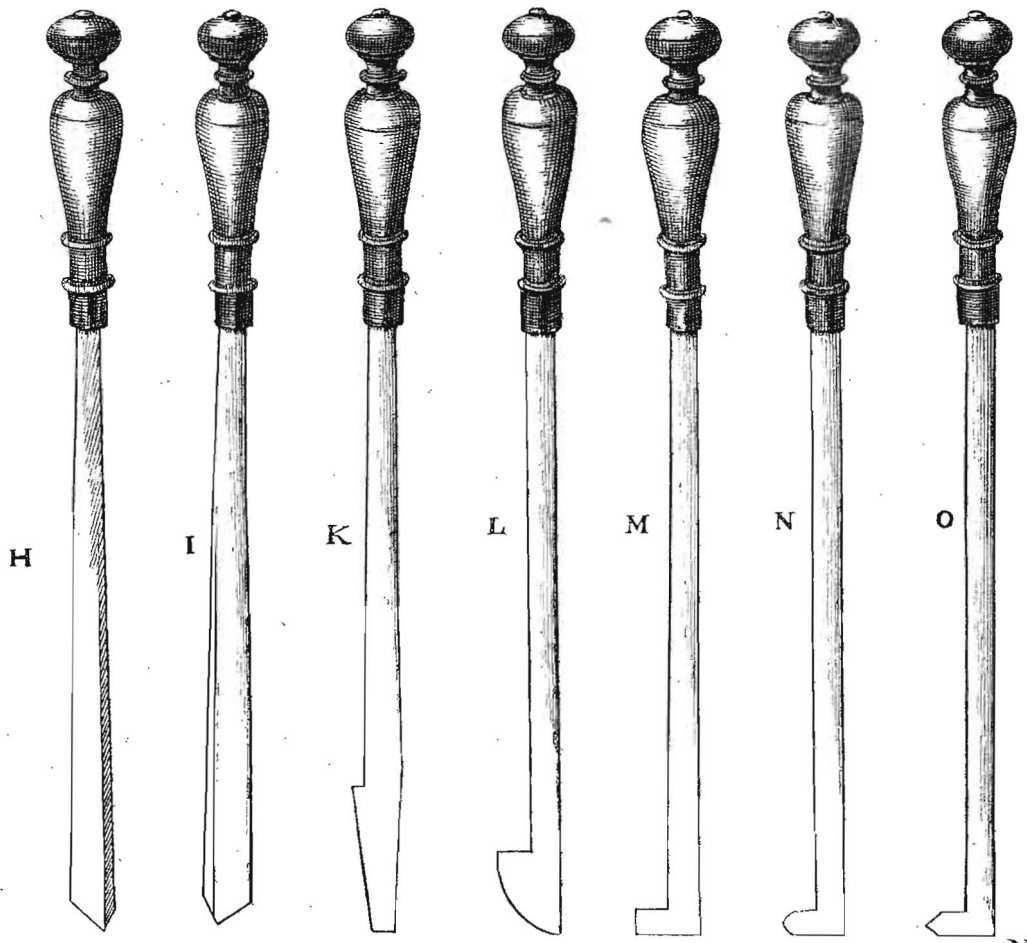
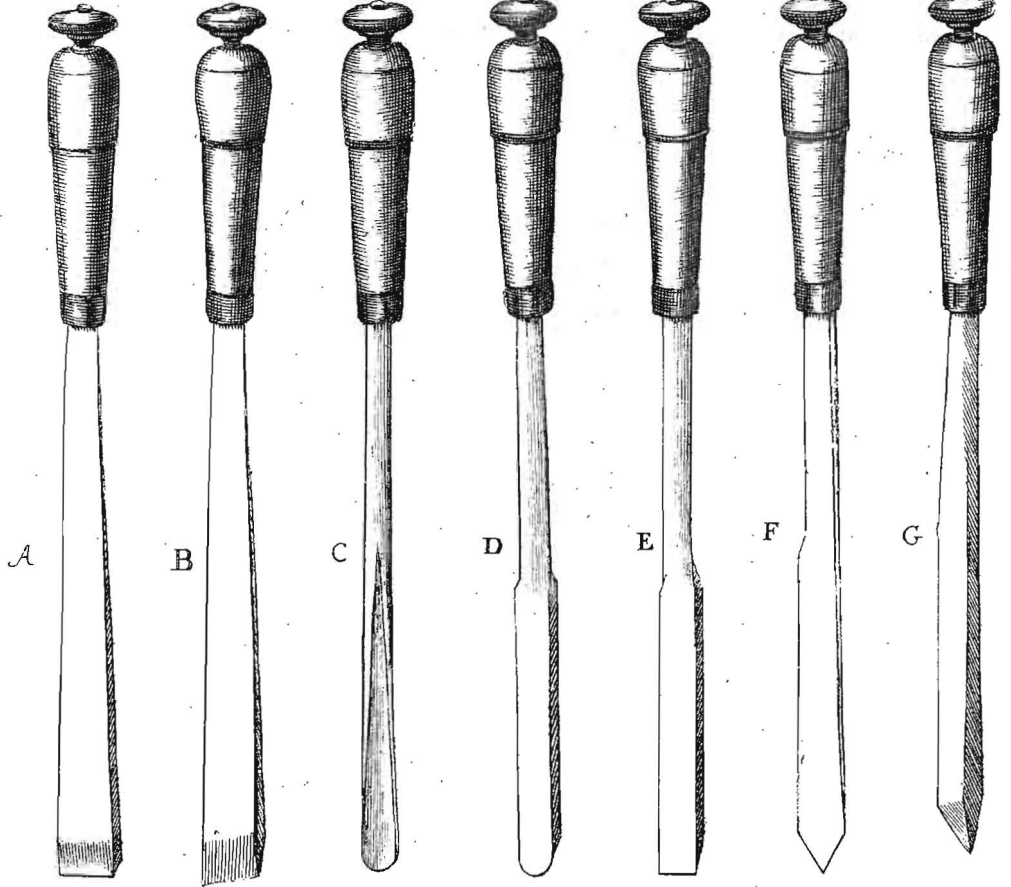


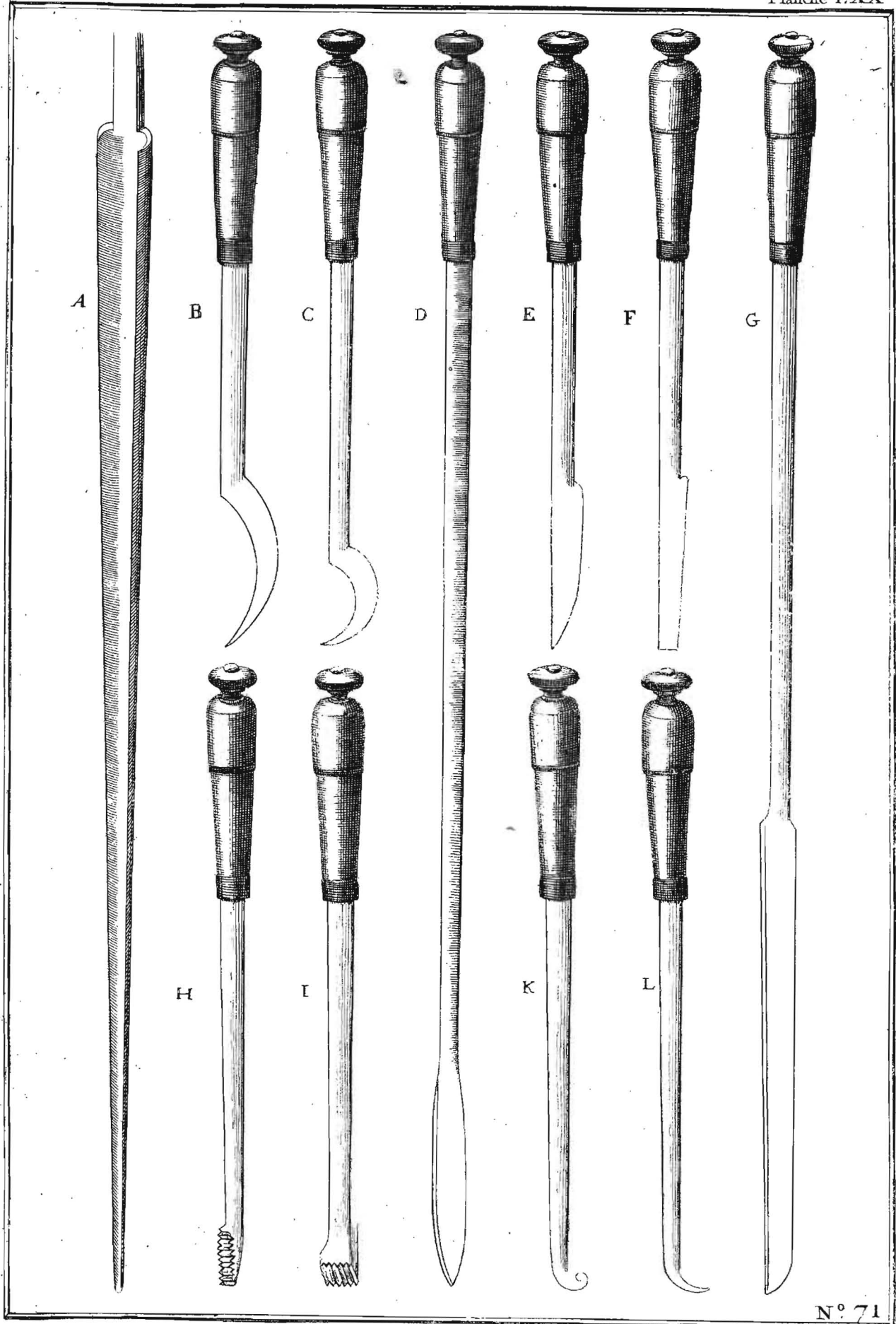


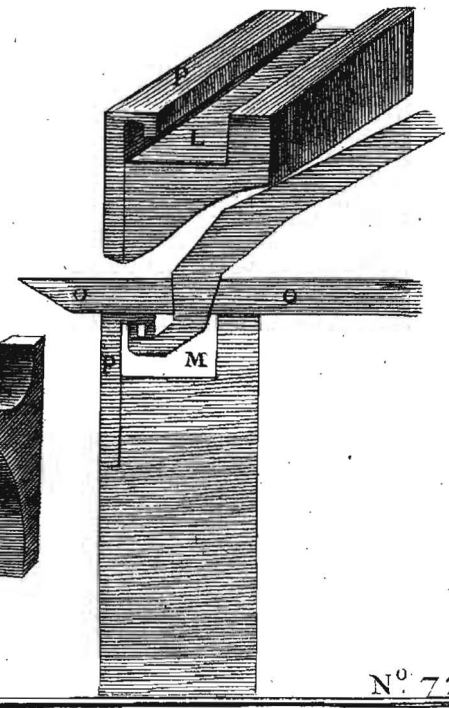
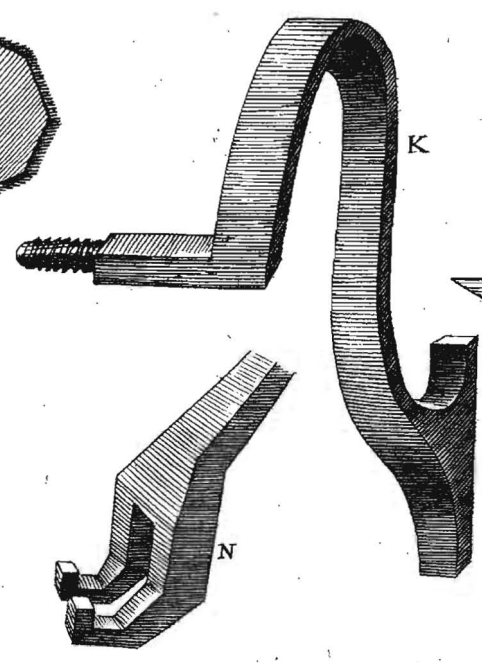
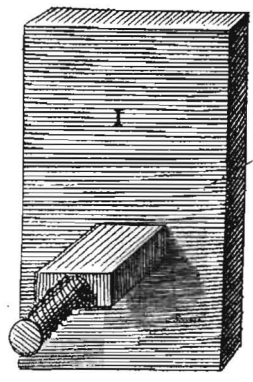
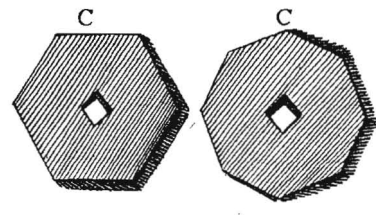
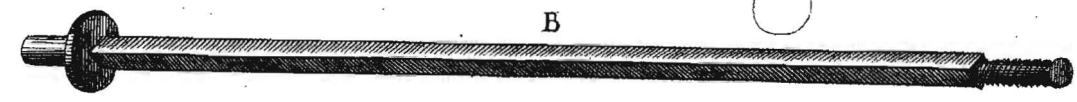
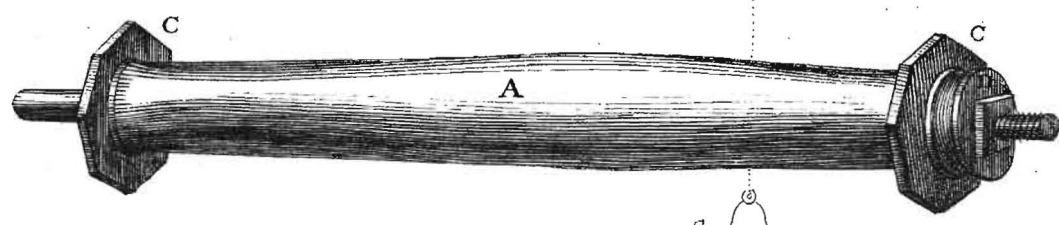
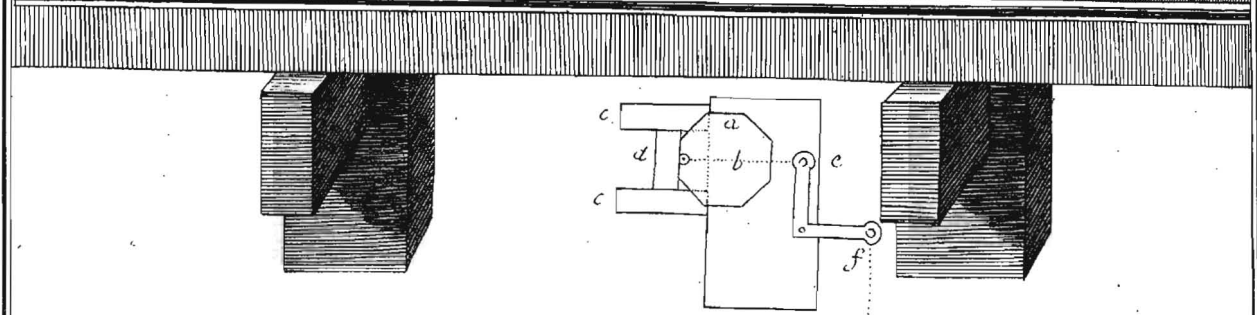
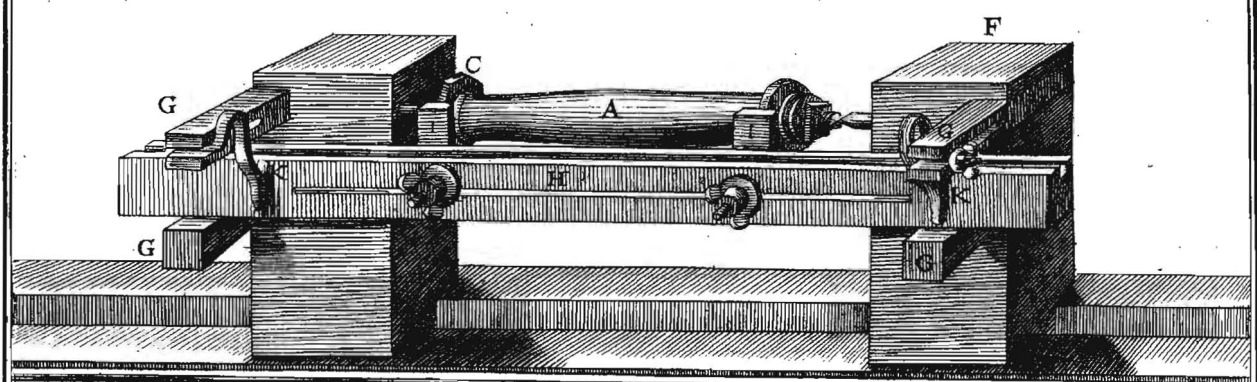


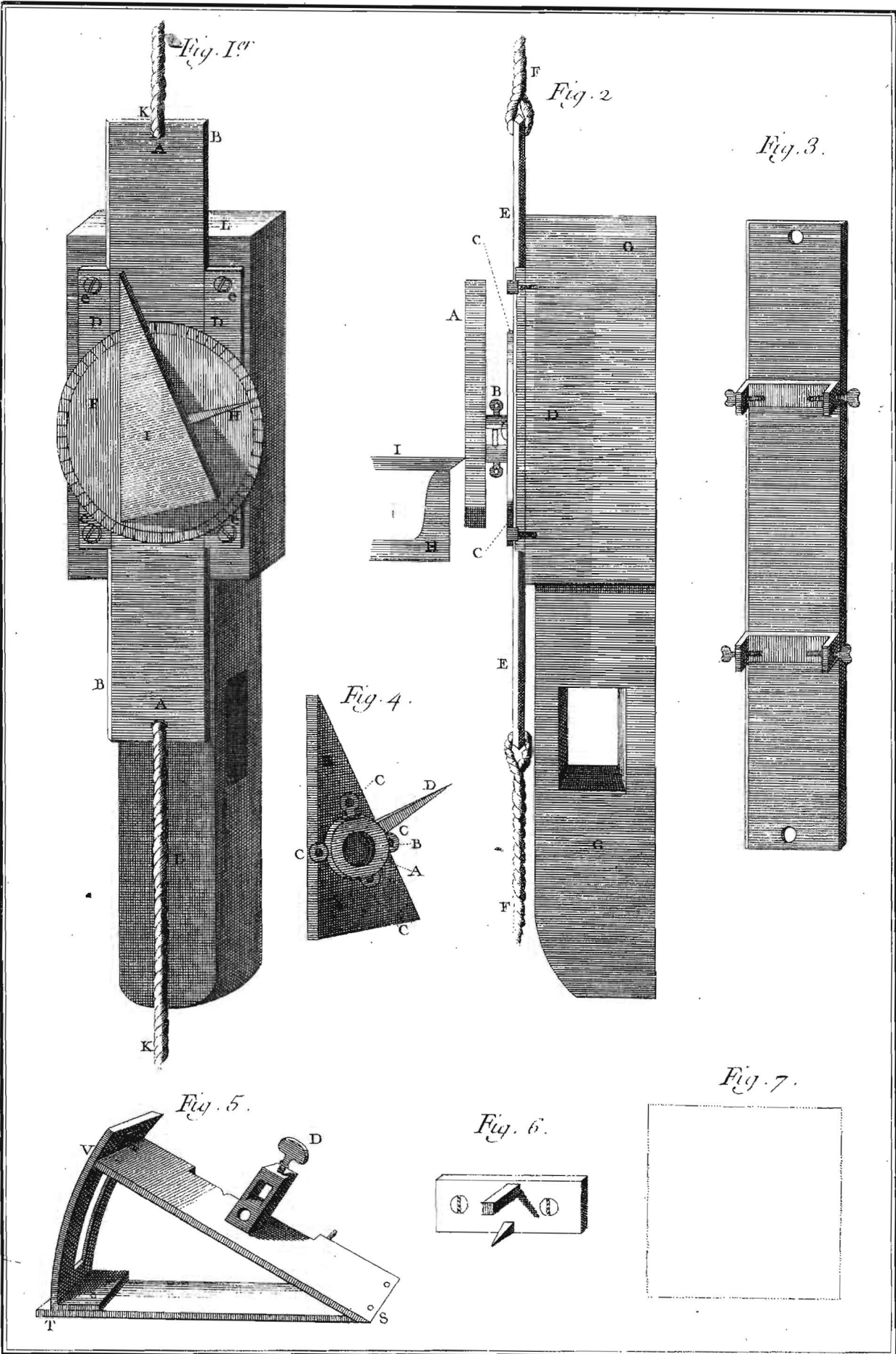














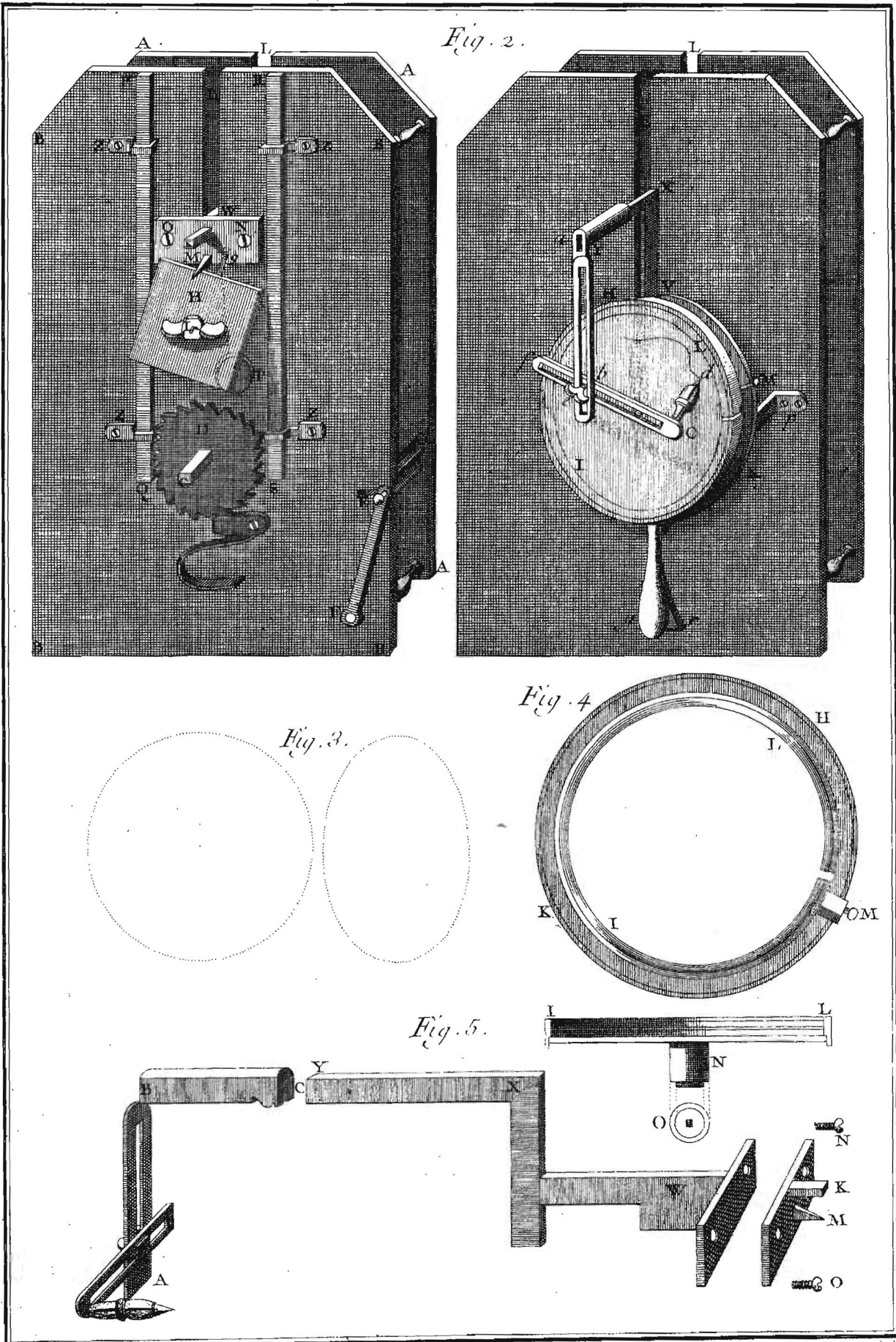


Fig. 2.

Fig. 3.

Fig. 4.

Fig. 5.

Fig. 1.<sup>arc</sup>

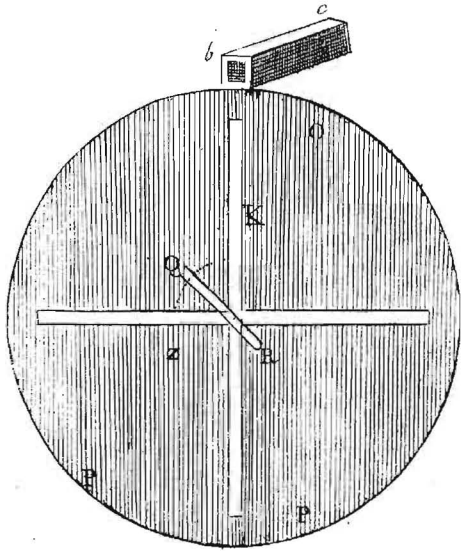


Fig. 2.

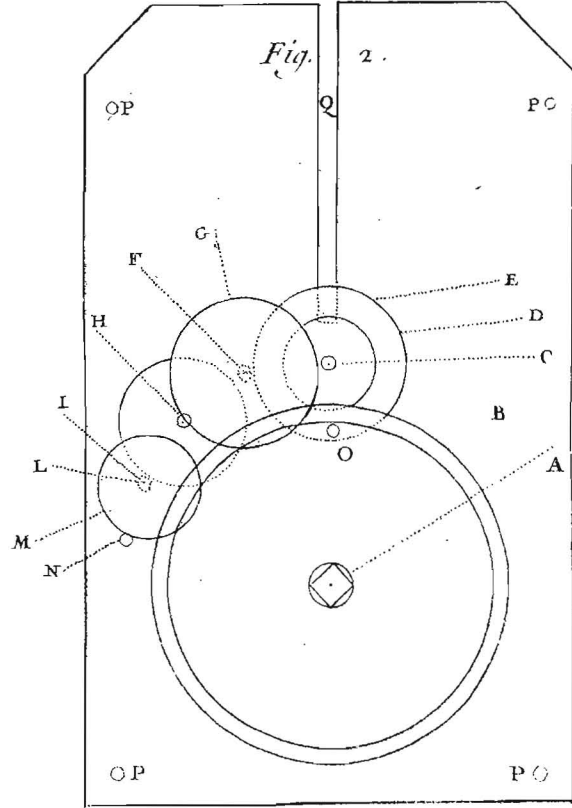


Fig. 3.

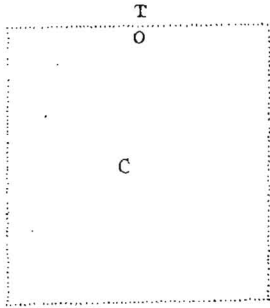


Fig. 4.

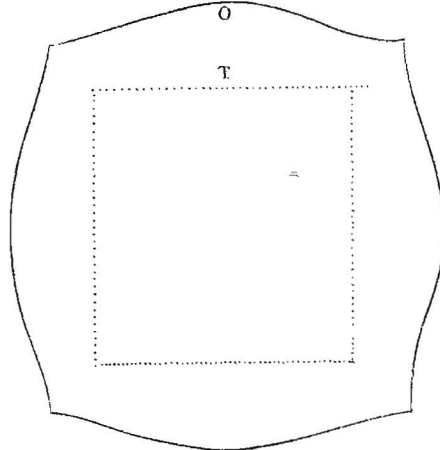


Fig. 5.

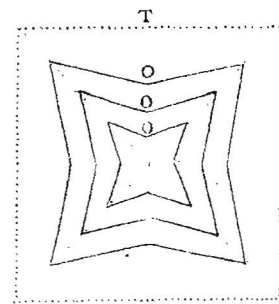


Fig. 6.

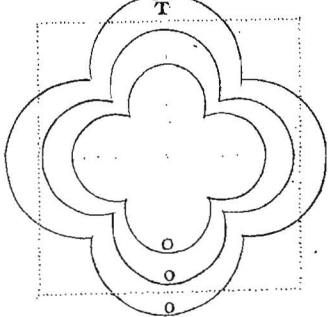


Fig. 7.

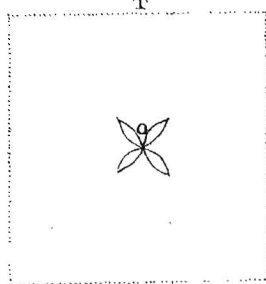


Fig. 8.

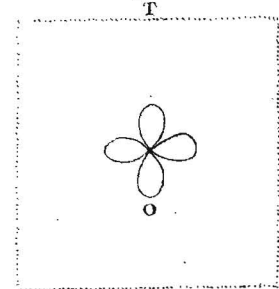


Figure 1

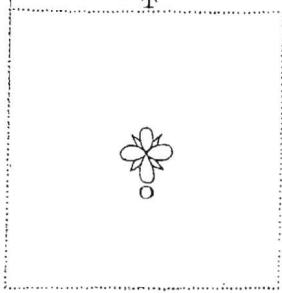


Fig 2

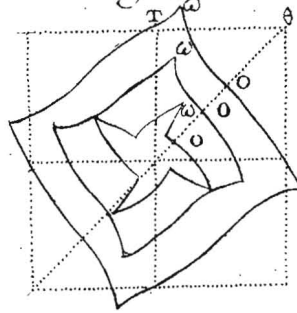


Fig 3

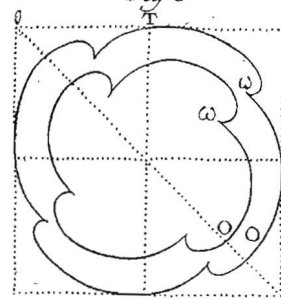


Fig 4

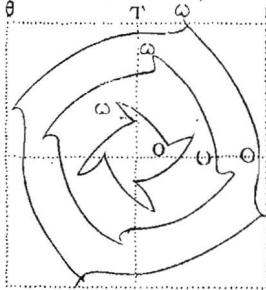


Fig 5

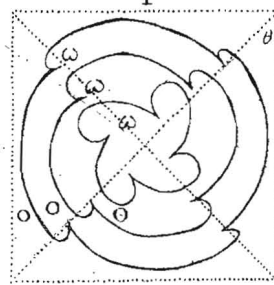


Fig 6

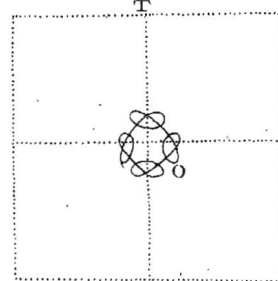


Fig 7



Fig 8

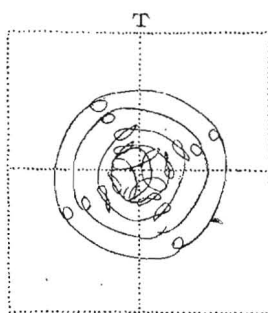


Fig 9

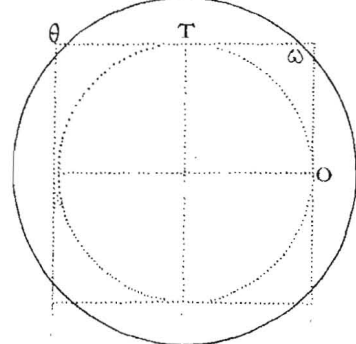


Fig 10

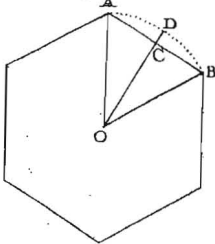


Fig 11

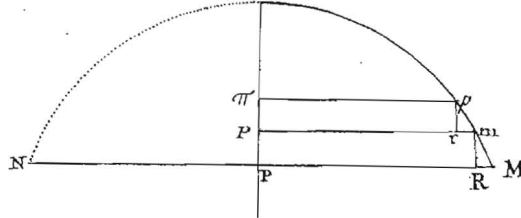


Fig 12

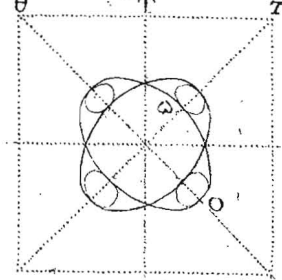


Fig 13

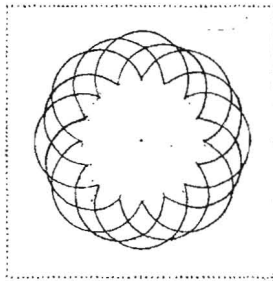
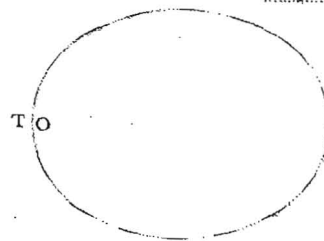
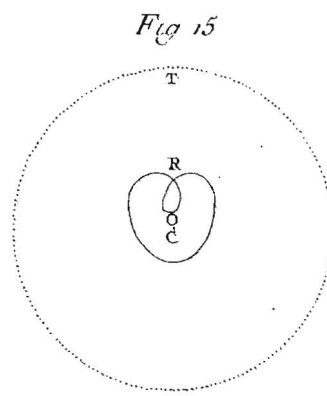
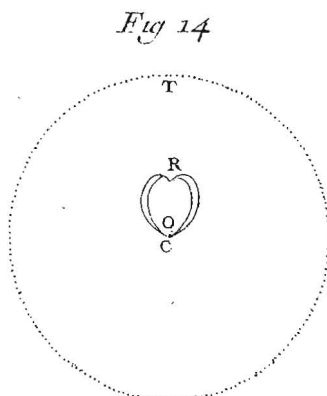
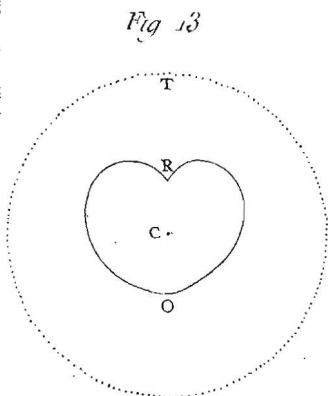
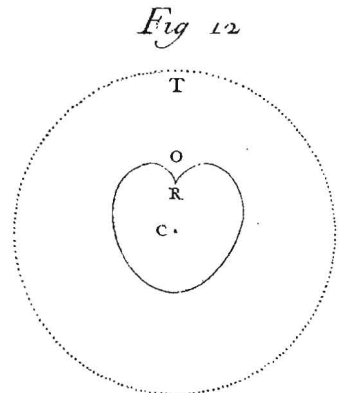
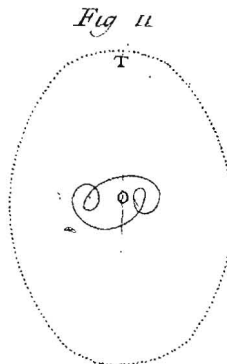
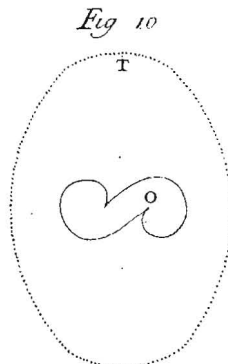
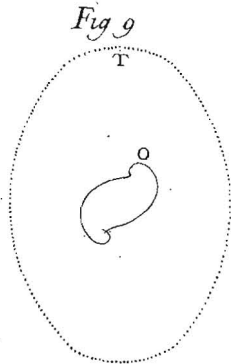
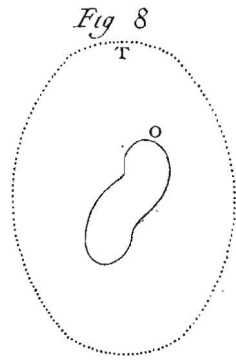
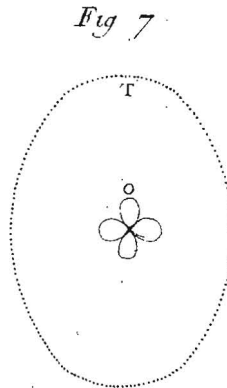
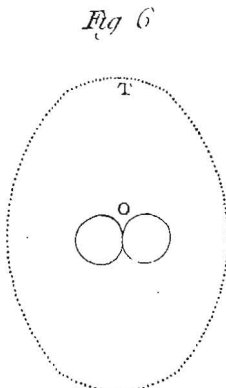
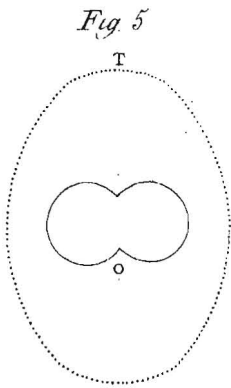
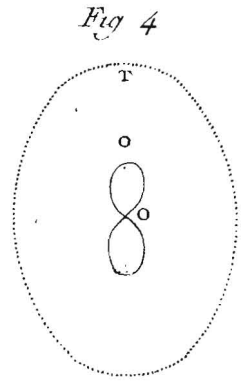
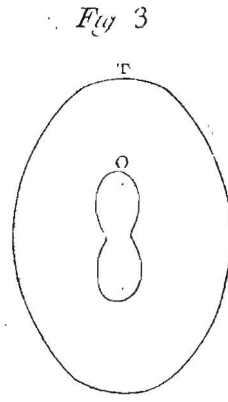
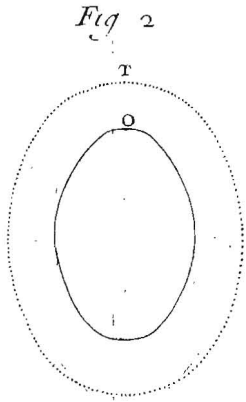
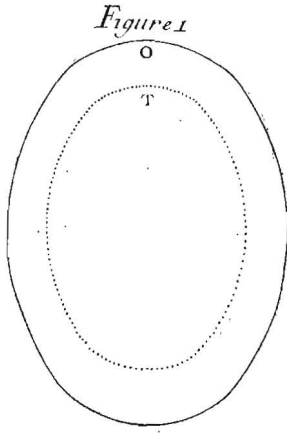


Fig 14





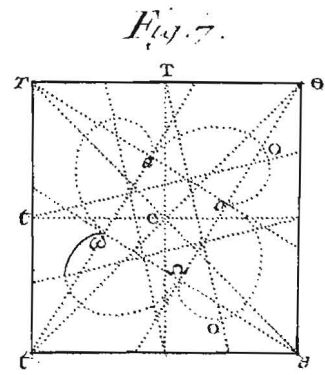
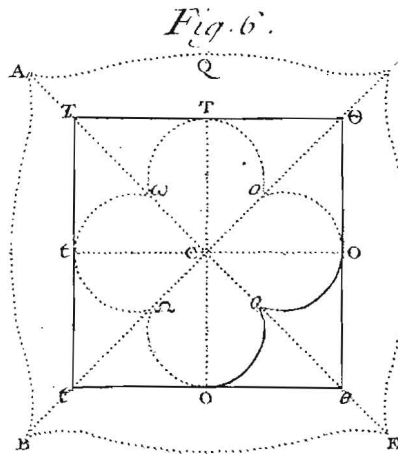
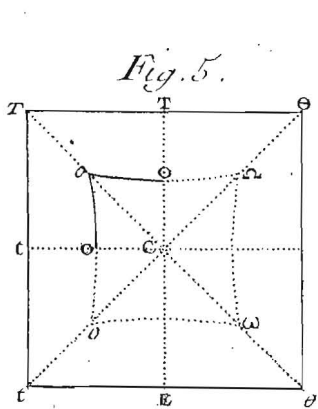
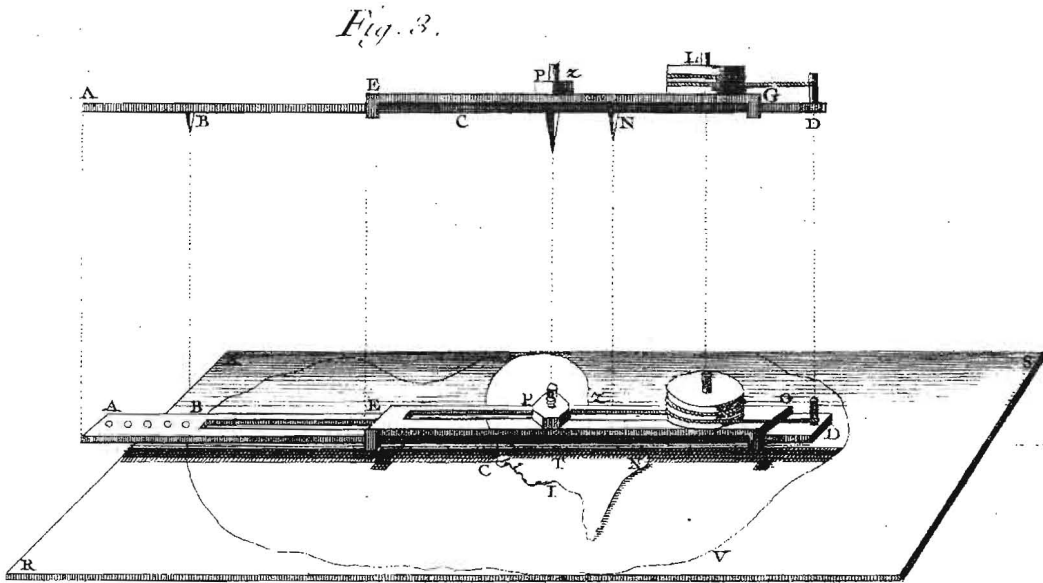
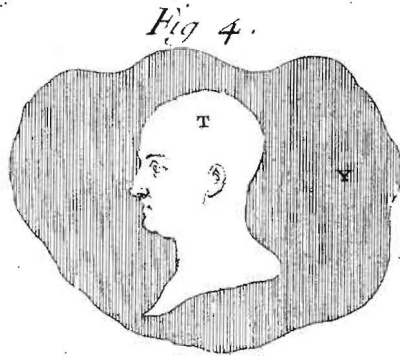
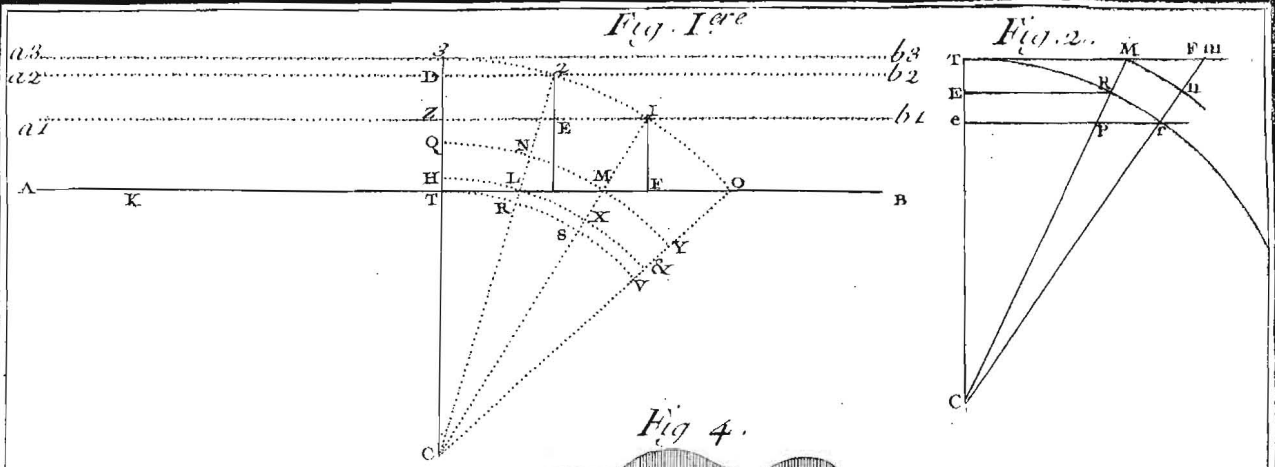


Fig. premiere

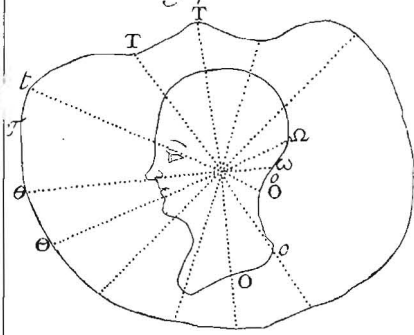


Figure . 2 .

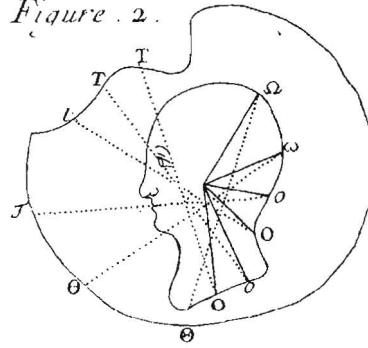


Fig. 3.

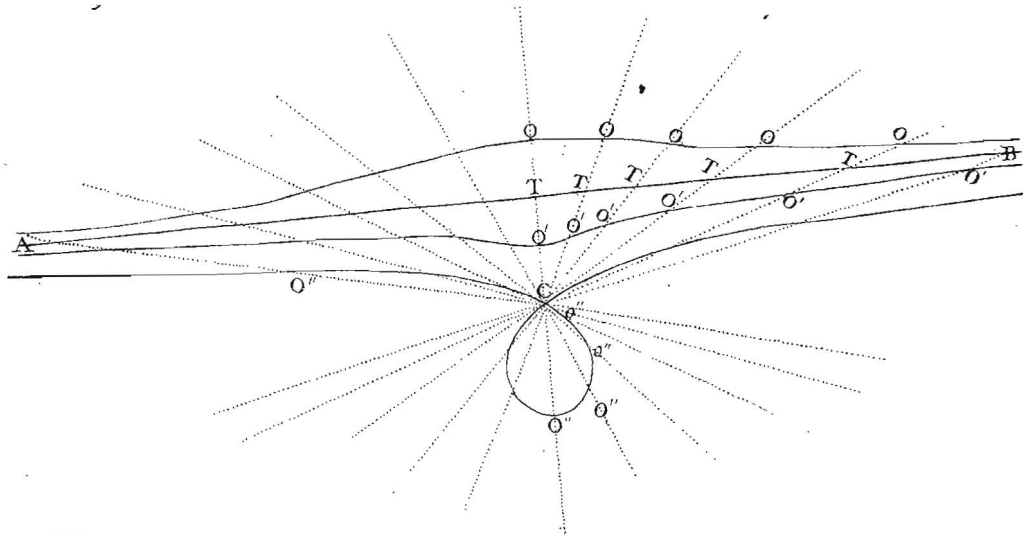


Fig. 4.

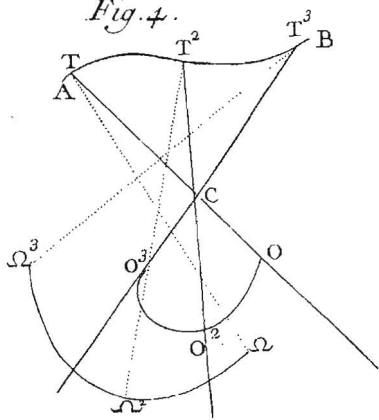


Fig. 5.

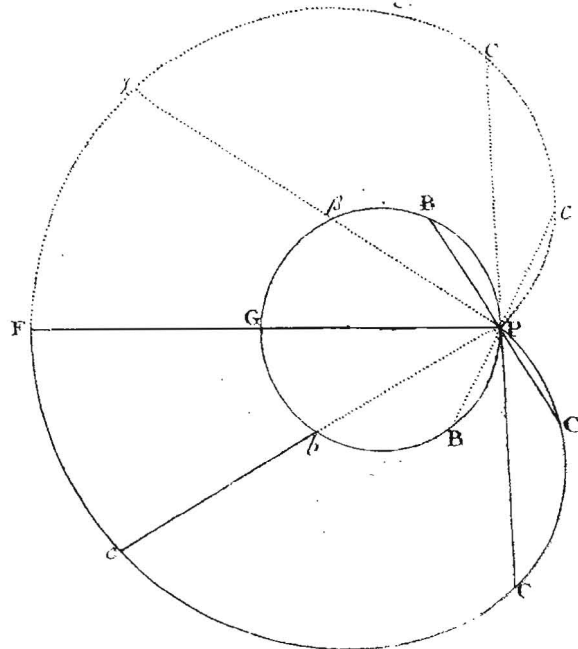
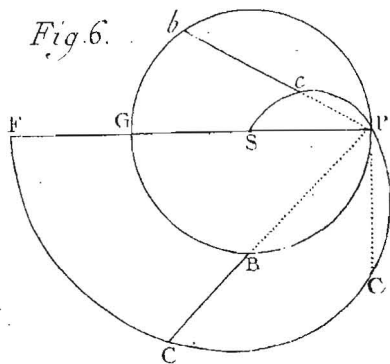
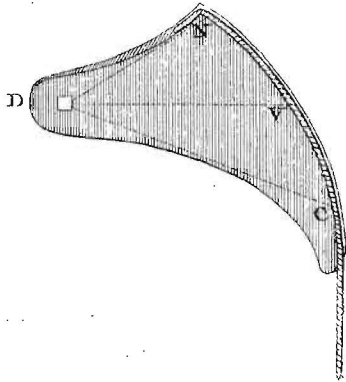


Fig. 6.



*Tour pour faire toutes sortes de Vis*

*Fig. 2.*



*Fig. 1<sup>re</sup>.*

