



**HAL**  
open science

# Supervised Output Regulation via Iterative Learning Control for Rejecting Unknown Periodic Disturbances

O Koçan, Daniele Astolfi, C. Poussot-Vassal, A Manecy

► **To cite this version:**

O Koçan, Daniele Astolfi, C. Poussot-Vassal, A Manecy. Supervised Output Regulation via Iterative Learning Control for Rejecting Unknown Periodic Disturbances. 21st IFAC World Congress, Jul 2020, Berlin, Germany. 10.1016/j.ifacol.2020.12.1913 . hal-02557323

**HAL Id: hal-02557323**

**<https://hal.science/hal-02557323v1>**

Submitted on 28 Apr 2020

**HAL** is a multi-disciplinary open access archive for the deposit and dissemination of scientific research documents, whether they are published or not. The documents may come from teaching and research institutions in France or abroad, or from public or private research centers.

L'archive ouverte pluridisciplinaire **HAL**, est destinée au dépôt et à la diffusion de documents scientifiques de niveau recherche, publiés ou non, émanant des établissements d'enseignement et de recherche français ou étrangers, des laboratoires publics ou privés.

# Supervised Output Regulation via Iterative Learning Control for Rejecting Unknown Periodic Disturbances<sup>\*</sup>

O. Koçan<sup>\*</sup> D. Astolfi<sup>\*\*</sup> C. Poussot-Vassal<sup>\*</sup> A. Manecy<sup>\*</sup>

<sup>\*</sup> ONERA - The French Aerospace Lab, F-31055 Toulouse, France

(e-mail: [oktay.kocan@onera.fr](mailto:oktay.kocan@onera.fr),

[charles.poussot-vassal@onera.fr](mailto:charles.poussot-vassal@onera.fr), [augustin.manecy@onera.fr](mailto:augustin.manecy@onera.fr)).

<sup>\*\*</sup> Univ Lyon, Université Claude Bernard Lyon 1, CNRS, LAGEPP  
UMR 5007, 43 boulevard du 11 novembre 1918, F-69100, Villeurbanne,  
France (e-mail: [daniele.astolfi@univ-lyon1.fr](mailto:daniele.astolfi@univ-lyon1.fr))

---

**Abstract:** The internal model principle (IMC) in linear robust output regulation theory states that a dynamical controller needs to incorporate a copy of the model generating the periodic signals in order to achieve perfect rejection/tracking, robustly with respect to plant's parameters. On the other hand Iterative Learning Control (ILC) is a data-based approach which not requires any *a priori* knowledge, and can be used to find the required control action for attenuating periodic disturbances or tracking periodic references. The control signal generated by ILC includes the frequency and amplitude information of the disturbance and can be used to build the internal model needed for a linear output regulator problem. The objective of this work is therefore that of trying to combine the two approaches, that is IMC and ILC, in order to retain the advantages of each methodology. The proposed methodology, denoted as Supervised Output Regulation via Iterative Learning Control (SOR-ILC), allows to address the problem of output regulation in presence of unknown frequencies. The performances of SOR-ILC are validated through numerical simulations in case of complex periodic disturbances and parameter uncertainties.

*Keywords:* Iterative learning control, robust output regulation, rejection, periodic disturbances.

---

## 1. INTRODUCTION

One can approach the problem of periodic disturbance rejection and/or periodic tracking either by applying a traditional control design or data-based control design. In the context of control feedback theory, the output regulation theory allows to handle both problems with a unifying point of view. In particular, it is supposed that both disturbances and references, denoted in the following as *exosignals*, are generated by an known autonomous systems, denoted as *exosystem*. The *internal model principle (IMC)* (Francis and Wonham (1976); Davison (1976)) states that by incorporating in the feedback loop a copy of the exosystem processing the output to be regulated, it is possible to achieve perfect asymptotic rejection or tracking. Furthermore, with such design, the above property is robust to (small) plant parameters perturbations. The drawback of such approach is that the model of the exosystem, that is the frequencies of the exosignals, needs to be perfectly known. In order to address this problem, adaptive solutions have been proposed in the contexts of linear and nonlinear output regulation, see, e.g. (Marino and Santosuosso (2007); Nikiforov (1998); Serrani et al. (2001); Ding (2003)) and references in Bin et al. (2019). A recent approach proposed a solution based on discrete-time identifiers Bin et al. (2019). Despite the efforts, all the proposed designs require a minimal information concerning the number of frequencies of the exosystems. Another

common approach, denoted as *repetitive control (RC)*, propose to use delays of the period of the exosignal in order to address the problem. Its use in continuous-time systems is limited by structural controllability properties Hara et al. (1988); Califano et al. (2018). Repetitive control has therefore mainly developed for discrete-time systems, see, for instance, Moore (1999) and references therein. Similar to RC, *iterative learning control (ILC)* has caught significant attention in the last decades thanks to its promising ability of dealing with periodicities in repetitive systems. ILC can simply reduce the effect of periodic disturbances and improve the system performance through iterative trials by means of modifying the current control based on the data obtained from previous system runs (Alsubaie et al. (2019)). Furthermore, ILC is a rather powerful concept for repeatedly operated systems since it allows to diminish the system errors way above the feedback bandwidth (Steinbuch and van de Molengraft (2000)). It is possible to see many ILC applications to accommodate the periodic disturbances in various areas. Rotary systems including robotics, printing, packing, semiconductor and fabrication (Chen (2016)); data storing systems (Ha and Park (2008)); twin-roll strip casting (Browne et al. (2018)); active flow control for compressor stators (Steinberg et al. (2015)) are some of these examples where ILC is used to tackle periodic disturbances.

Although both the traditional and data-based ILC approaches can be sufficient on their own depending on the application, they each have advantages and disadvantages.

---

<sup>\*</sup> This work was partially funded by French grant ANR Delicio (ANR-19-CE23-0006).

To begin, traditional methods tend to be more intuitive and easier to understand visually during modelling since their architectures can be represented by separate blocks, each of which carries out a specific task. However, their main disadvantage is that in order to be able to solve the problem one needs to do some mathematical assumptions about the unknown (or partially known) properties of periodic disturbance such as its period and eigenvalues. Yet, ILC being a data-based method can easily learn the required system input that will reject a periodic disturbance without needing to know any of its properties. Although this approach may seem a better solution, ILC can suffer from being 'blackbox-looking' and thus less intuitive and more difficult to use for traditional control engineers and researchers that comprise the majority of the control industry and literature. Hence, considering all these pro and cons mentioned above, we propose that a combination of both approaches can yield more satisfying results.

The outline of the paper is as follows: Sec. 2, 3 highlight the main notions on optimization-based ILC and robust output regulation, respectively; Sec. 4 develops the proposed SOR-ILC; Sec. 5 provides simulation examples; finally, Sec.6 draws a conclusion.

## 2. ITERATIVE LEARNING CONTROL HIGHLIGHT

Various ILCs had been proposed since the earliest version of ILC in Arimoto et al. (1984). Some of them can be seen as P-type, D-type, PD-type ILCs, fractional order ILC, model inversion-based ILC, optimisation-based ILC and so on. Recent ILC applications show that there is tendency towards optimisation-based ILC methods. Such trend is quite understandable considering the increased processing power of computers and the efficacy of optimisation applications in solving difficult design problems. Motivated by the same reason, in this work we utilise a popular optimisation-based ILC method, namely the norm-optimal ILC (NO-ILC). The main points of designing a NO-ILC are briefly introduced below and the reader is suggested to refer to Norrlöf (2000) for more details .

The fundamental idea of ILC is to iteratively find new system inputs by filtering the errors and the inputs from the previous system runs. This can easily be seen from the ILC update equation

$$u_{i+1}(t) = Qu_i(t) + QLe_i(t) \quad (1)$$

in which  $i$  is the iteration index of ILC,  $t$  is the time step with  $t = 1, \dots, N$ ,  $e_{i+1}(t) \in \mathbb{R}^N$  is the system's current tracking error,  $u_{i+1}(t) \in \mathbb{R}^N$  is the system's current input,  $u_i(t) \in \mathbb{R}^N$  is the system's previous input (assuming that  $N$  is a vector/matrix length/size parameter defined by the simulation time and the step size).

In NO-ILC the update equation (1) defines the current system input  $u_{i+1}$  which can be found by analytically solving for the  $u_{i+1}$  that minimises the cost function

$$J(u_{i+1}) = e_{i+1}^T W_e e_{i+1} + u_{i+1}^T W_u u_{i+1} + \lambda [(u_{i+1} - u_i)^T (u_{i+1} - u_i)], \quad (2)$$

where  $\lambda \in \mathbb{R}^1$  is the Lagrange multiplier;  $W_e = \rho I \in \mathbb{R}^{N \times N}$  and  $W_u = I \in \mathbb{R}^{N \times N}$  are the weighting matrices for the error and the input, respectively, with  $I$  being the identity matrix. Thus, the optimal solution of (2) gives the required  $Q \in \mathbb{R}^{N \times N}$  and  $L \in \mathbb{R}^{N \times N}$  filters (i.e. (3)

and (4), respectively) which constitute the core of NO-ILC. Here, the  $G$  matrix refers to the lifted-matrix of the internal system (Bristow et al. (2006)). Moreover, the convergence and robustness performance of NO-ILC depends on the heuristic selection of  $\lambda > 0$  and  $\rho > 0$  under the requirement of two criteria:  $\|Q\|_2 < 1$  and  $\|QL\|_2 \leq 0.5/\sqrt{\rho + \lambda}$ .

$$Q = ((\lambda + \rho)I + G^T G)^{-1}(\lambda I + G^T G) \quad (3)$$

$$L = (\lambda I + G^T G)^{-1} G^T \quad (4)$$

## 3. ROBUST OUTPUT REGULATION HIGHLIGHTS

### 3.1 Problem definition

Let us consider the following linear time invariant open-loop plant in continuous-time

$$\dot{x}(t) = Ax(t) + Bu(t) + W_x w(t), \quad (5)$$

$$e(t) = Cx(t) + Du(t) + W_y w(t). \quad (6)$$

where  $x \in \mathbb{R}^n$  is the state,  $u \in \mathbb{R}$  is the control input, and  $e \in \mathbb{R}$  is the output aimed to be regulated to zero without loss of generality. In the rest of the paper, for simplicity, we suppose that the full state  $x$  is available for feedback design, that  $e, u$  are scalar and that  $D = 0$ . Such assumptions are no restrictive since a straightforward extension to the multivariable and output feedback cases of all the forthcoming results can be formulated by following Byrnes et al. (1997); Astolfi (2016) or Steinbuch and van de Molengraft (2000). In (5), (6),  $w \in \mathbb{R}^{n_w}$  is a signal representing disturbances to be rejected or references to be tracked. In output regulation theory (see Francis and Wonham (1976); Davison (1976)),  $w$  is usually denoted as exosignal and is generated by an autonomous exosystem of the form

$$\dot{w} = Sw \quad (7)$$

where  $S$  is a neutrally stable matrix of the form  $S = \text{blkdiag}(0, \omega_1 J, \dots, \omega_\rho J)$ , where

$$J = \begin{bmatrix} 0 & 1 \\ -1 & 0 \end{bmatrix} \quad (8)$$

where the  $\omega_i, i = 1, \dots, \rho$ , are all different and characterize the frequencies of the signal  $w$ . The problem of regulating  $e$  to zero while maintaining bounded the state  $x$  for all positive times, denoted as output regulation, is solved under the following customary assumptions, see Byrnes et al. (1997).

*Assumption 1.* (Stabilisability). *The pair  $(A, B)$  is stabilisable.*

*Assumption 2.* (Non-resonance condition). *The matrix  $\begin{bmatrix} A - \lambda I & B \\ C & 0 \end{bmatrix}$  has independent rows for each  $\lambda \in i\mathbb{R}$ , where  $i$  denotes the imaginary number.*

Assumption 2 mainly states that the transfer function between  $u$  and  $y$  has no zeros with zero real part. Although the condition we stated is more stringent than standard output regulation framework (where the rank condition needs to hold only for each  $\lambda$  eigenvalue of  $S$ ), it is necessary in our scenario, in which an adaptive solution is sought.

The solution to the output regulation problem follows then the next two-step procedure.

S1) Extend the system (5)-(6), with an internal model unit (IMU) of the form

$$\dot{\eta}(t) = \hat{S}\eta(t) + \Gamma e(t) \quad (9)$$

where  $\eta = (\eta_0, \eta_1, \dots, \eta_\varrho)^T \in \mathbb{R}^{1+2\varrho}$  is the state of the IMU. The matrix  $\hat{S}$  is selected as  $S = \text{blkdiag}(0, \hat{\omega}_1 J, \dots, \hat{\omega}_\varrho J)$ , with  $J$  of the form (8) for some frequencies  $\hat{\omega}_i$ , while  $\Gamma$  has to be chosen so that  $\hat{S}, \Gamma$  is a controllable pair.

S2) Stabilize the extended system (5), (6), (9) with a controller of the form

$$u = K_1 x + K_2 \eta \quad (10)$$

such that the unforced (i.e. when  $w = 0$ ) closed loop system is asymptotically stable.

*Theorem 1.* Suppose  $\varrho = \rho, \hat{S} = S$  in (9), with  $\rho, S$  given by (7), and that  $K_1, K_2$  in (10) ensures asymptotic stability of the unforced closed loop system (5), (6), (9), (10). Then, the output regulation problem for system (5), (6), (9), (10), forced by (7), are bounded for all  $t \geq 0$  and satisfy  $\lim_{t \rightarrow \infty} e(t) = 0$ . Furthermore, the above properties are robust to any (small) parameter perturbations of the nominal matrices  $(A, B, C)$  that do not destroy the stability property of the (unforced) closed-loop system.

**Proof.** See Francis and Wonham (1976); Davison (1976); Byrnes et al. (1997).

In addition to previous result, note that the design of the dynamical regulator (9), (10), is independent from how the exosignal  $w$  affects the plant (5)-(6), namely from the matrices  $W_x$  and  $W_y$ .

### 3.2 Parametrisation of the controller via forwarding for ILC application

As one can see from Theorem 1, the main challenge of the internal model based approach is that for the design of (9), one needs to perfectly know  $S$ , that is the frequencies  $\omega_i$  of the exosignals (7), and such assumption remains unrealistic in a practical scenario. Furthermore, each time the matrix  $\hat{S}$  in (9) is aimed to be adapted, the matrices  $K_1, K_2$  of the controller (10) may need to be redesigned. Therefore, a pole-placement strategy is not well suited in such context. A possible solution could be parametrizing the dynamic (9) by following the parametrization of Nikiforov (1998). However, the extension to the nonlinear case is not trivial with this approach, see Astolfi et al. (2019). Therefore, in this work, we follow another route which is maintaining the structure of (9) and proposing a design of (10) based on forwarding techniques proposed in Astolfi (2016). The advantage of such approach is the self-re-parametrisation of the stabilizer unit each time  $\hat{S}$  in (9), that is the frequencies  $\hat{\omega}_i$ , is modified. Thus, following Astolfi (2016), we design (10) as

$$u = -\beta B^T R x + \sum_{i=1}^{\varrho} \mu_i B^T M_i^T (\eta_i - M_i x) \quad (11)$$

where the parameters  $\beta \geq 0$  and  $\mu_i > 0$  can be seen as free design parameters which can be utilized to put weight on specific frequencies as well as to increase rejection performance, and the matrices  $R, T$ , and  $M$  are computed respectively as solution to

$$R A + A^T R = -I, T \hat{S} + \hat{S}^T T = 0, M_i A = \hat{\omega}_i J M_i + \Gamma_i C. \quad (12)$$

with  $J$  defined in (8) and  $\Gamma = [\Gamma_0, \Gamma_1, \dots, \Gamma_\rho]^T$  with  $\Gamma_0 = 1$  and  $\Gamma_i = [0, 1]^T$  for all  $i = 1, \dots, \rho$ . Note that the skew-symmetry of the  $\hat{S}$  matrix allows  $T$  to be the identity matrix. Note that with respect to (10), we selected

$$K_1 = -\beta B^T R - \sum_{i=1}^{\rho} \mu_i B^T \quad (13)$$

$$K_2 = [\mu_1 B^T M_1^T, \mu_2 B^T M_2^T, \dots, \mu_\rho B^T M_\rho^T]. \quad (14)$$

Then, the following proposition can be stated.

*Proposition 2.* Under Assumptions 1, 2, for any  $\hat{S}$  designed as in S1, the unforced closed-loop system (5), (6), (9), (11) with  $R = R^T > 0, T = T^T$  and  $M$  designed as in (12), respectively, is asymptotically stable.

**Proof.** The proof can be found in Astolfi (2016) and it is based on the analysis of the derivative of the Lyapunov function  $V = x^T R x + (\eta - M x)^T T (\eta - M x)$ .

## 4. SUPERVISED OUTPUT REGULATION VIA ITERATIVE LEARNING CONTROL (SOR-ILC)

In this section, we explain how the iterative learning control and output regulation methods can be combined. The main idea behind our approach can be seen as utilising the capability of ILC to detect unknown periodic frequencies in a disturbance and then using this information for building an output regulator that will reject the periodic disturbance. In other words, ILC, when combined with an output regulator, can be seen as a supervisor for the output regulator's action on the periodic disturbance. Inspired from this, we call this approach the *Supervised Output Regulation via Iterative Learning Control (SOR-ILC)*. This approach can also be understood as representing the data-based ILC in terms of a classical feedback controller or as using ILC for automatically tuning a linear controller. The following steps give a stepwise explanation of how to apply the SOR-ILC on a generic system.

### 4.1 Inner model and disturbance

Let us consider (5)-(6) where now  $w(t) = d(t)$  is supposed to be a signal that can be expressed as Fourier series of unknown frequencies and number of Fourier coefficients. One has to make sure that the inner system is stable before applying ILC. This is due to the fact that ILC is an open-loop control which modifies the system input through iterations. Therefore, the system (5)-(6) can be assumed to be already in closed-loop giving the required stability as in Fig. 1.

### 4.2 Learning the disturbance via ILC

The first step of SOR-ILC is to learn the frequency content of the periodic disturbance via ILC. In other words, the challenge is to approximate the matrix  $S$  in (9) without knowing the exosystem. The required procedure for applying this step is provided in our previous work via a workflow called *Learning Based Controller Tuning (LBC T)* (Koçan et al. (2019)). This work-flow can be summarised as:

- (1) Set the initial ILC parameters (see Sec. 2) and iteratively run the system shown in Fig. 1 (switch at  $S.1$ ) until the desired rejection is obtained (i.e.  $\|e_i\| \leq \epsilon$ ). Note that theoretically under the conditions of ideal

plant and full repetitiveness, the converged error  $\epsilon$  can reach zero as  $i \rightarrow \infty$ . However, in practice  $i < \infty$  and in general due to the initial modelling error and the repetitiveness of system disturbances and measurement noise,  $\epsilon \rightarrow \epsilon^* \neq 0$  where the value of  $\epsilon^*$  depends on the iteration number and other tuning parameters of the ILC, e.g. see Table 1. For more details on  $\epsilon$  refer to 'Section 3.6' and 'Section 4.2' of Norrlöf (2000).

- (2) Having the desired rejection performance, obtain  $U_{ILC}(f)$  which is the frequency data (e.g. DFT/FFT) of the converged ILC signal  $u_{ILC}(t)$  (i.e. the ILC input at the last iteration,  $u_{i=M}(t)$ ), see Koçan et al. (2019).
- (3) By looking at the points where there are peaks of amplitude, detect the approximated values of dominant frequencies  $\bar{\omega}_i \in \mathbb{R}^+$  defining the unknown periodic disturbance  $\omega(t)$  in (5)-(6), see Koçan et al. (2019).

Note that this learning procedure is 'off-line' and it is finished before we begin to build the output regulator.

#### 4.3 Building an Output Regulator based on ILC data

After obtaining a good approximation for the unknown exosystem, the next step of SOR-ILC is to use this information to build a linear output regulator. The procedure provided in Sec. 3.2 is directly applicable for creating the required output regulator except that this time the matrix  $\hat{S}$  in (9) is approximated by ILC, i.e.  $\hat{\omega}_i = \bar{\omega}_i$  for all  $i$ .

### 5. EXAMPLES

This section demonstrates two simulation examples of SOR-ILC on a simple system. First example considers only a simple external periodic disturbance while the second example goes through a combination of complex effects such as internal and external periodic disturbances, parametric uncertainties and lack of frequency knowledge.

#### 5.1 Testing SOR-ILC with a simple periodic disturbance

Let us consider that (5)-(6) is a second-order open-loop system with

$$A = \begin{bmatrix} -3.5014 & -3.0003 \\ 1 & 0 \end{bmatrix}, B = \begin{bmatrix} 0 \\ 1 \end{bmatrix}, C = I_{2 \times 2}, D = 0_{2 \times 1}.$$

Then, we assume that we can access both of the states and that there is a sinusoidal disturbance acting on the second output only, i.e.  $W_x = [0, 0]$ ,  $W_y = [0, 1]$  and  $w(t) = d(t) = a \cdot \sin(\omega t)$  where  $a = 0.2$  and  $\omega = 1 \text{ rad/s} = 0.1591 \text{ Hz}$  are the amplitude and the pulsation of the signal, respectively. Since most systems have some already existing controllers in practice, we also suppose that our plant is in closed-loop with:  $K_0 = [-3.4728, 15.5866]$ . Hence, the inner system ( $G$ ) is defined by

$$\dot{x}(t) = A_{in}x(t) + B_{in}u(t), \quad (15)$$

$$y(t) = C_{in}x(t) + W_y d(t) \quad (16)$$

where  $A_{in} = A + BK$ ,  $B_{in} = B$  and  $C_{in} = [0, 1]$ . This system can be observed in Fig. 1. Since the model of the disturbance is not included in the state feedback, the gains given above are already incapable of dealing with the given disturbance. Thus, this architecture portrays a scenario in which the existing closed-loop system is insufficient of dealing with an external periodic disturbance.

Once the inner system is determined, one can follow the procedures given in Sec. 4.2 to learn the frequency content

Table 1. NO-ILC initialisation

|                                   |   |
|-----------------------------------|---|
| Sample time, $T_s$                | 0.01 sec.                               |
| Simulation time, $T_{sim}$        | 50 sec.                                 |
| Initial states, $x$               | $[0 \ 0]^T \in \mathbb{R}^{2 \times 1}$ |
| Initial ILC input, $u_{ILC}$      | 0                                       |
| Number of ILC iterations, $M$     | 1000                                    |
| Weight on the error, $W_e$        | $\rho I \in \mathbb{R}^{N \times N}$    |
| Weight on the system input, $W_e$ | $I \in \mathbb{R}^{N \times N}$         |
| $\rho$                            | 0.001                                   |
| $\lambda$                         | 0.1                                     |

of the periodic disturbance  $d(t)$ . The first step is if to properly initialise the ILC and iteratively run the system in Fig. 1 until a satisfying rejection level is achieved. If NO-ILC initialisation is carried out according to Table 1, the ILC inputs shown in Fig. 2 iteratively improve the rejection performance as in Fig. 3. The power of this optimisation-based approach can easily be understood by checking the output amplitude at the last iteration in Fig. 3. Then, the next step is to obtain the frequency data of the converged ILC signal that is the input at the last iteration in Fig. 2. Finally, by looking at the points where there are peaks, it is possible to detect the approximated values of dominant frequencies  $\bar{\omega}_i$  defining  $d(t)$ .

After detecting the approximate frequency content of the periodic disturbance, it is possible to build the output regulator part of the SOR-ILC following Sec. 4.3. The first step is to build the internal model unit (9) using the learned frequencies  $\bar{\omega}_i$ . For the given disturbance  $d(t)$ ,  $\hat{S} = \text{blkdiag}(\hat{S}_0, \hat{S}_1)$  and  $\Gamma = [\Gamma_0, \Gamma_1]^T$  where  $\hat{S}_0 = 0$ ,  $\hat{\omega}_1 = \bar{\omega}$ ,  $\Gamma_0 = 1$  and  $\Gamma_1 = [0, 1]^T$ . The second step is to build the stabiliser unit given by (11). Since  $d(t)$  is a single sine signal  $\rho = 2$  such that  $(\rho + 1)$  tuning parameters are needed for the output regulator. The values for these parameters can be set to following values:  $\beta = 0.1$ ,  $\mu_1 = 100$  and  $\mu_2 = 100$  (note that these values are chosen by trial-and-error for a sample demonstration and other choices that lead to better rejection performance are also possible). Additionally, for a better analysis, we consider a phase for the disturbance and set the initial states of the inner model to specific values, i.e.  $d(t) = 0.2 \sin(t + \pi/4)$  and  $x_0 = [0, 0.05]^T$ . Finally, we can test the performance of the SOR-ILC against  $d(t)$  by running the system in Fig. 1 while the switch is at  $S_2$ . One can observe in Fig. 4 that the disturbance amplitude appearing in the system output has been reduced by 99.6% after applying the output regulator of the SOR-ILC. The remaining small oscillations after 50sec are due to a small approximation error left from the ILC learning,  $\bar{\omega}_1 \approx 1 \text{ rad/s}$ .

#### 5.2 Testing SOR-ILC with Complex Disturbances

We now test the rejection performance of our SOR-ILC considering a lumped effect of complex disturbances and parameter uncertainty. The inner system has this time the following form:

$$\dot{x}(t) = \tilde{A}(t)x(t) + \tilde{B}u(t) + [\sin x_1(t), 0]^T, \quad (17)$$

$$y(t) = \tilde{C}x(t) + d(t). \quad (18)$$

Here,  $\tilde{A}$ ,  $\tilde{B}$ ,  $\tilde{C}$  are  $A$ ,  $B$ ,  $C$  matrices in (5)-(6) with 20% parameter uncertainty and  $x_0 = [0, 0]^T$ . The state disturbance is a sine function of the first system state and the output disturbance is in form of three non-linearly combined sine waves, i.e.  $d(t) = 0.25[0.7(0.15 -$

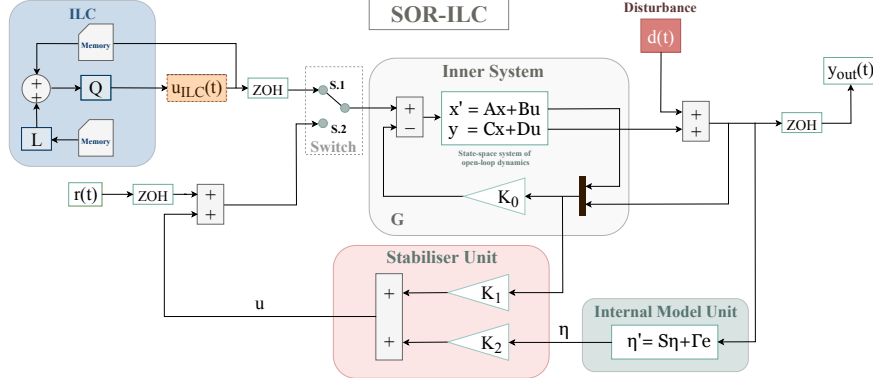

Fig. 1. SOR-ILC test model

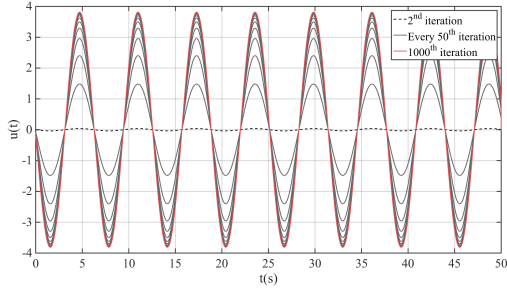

Fig. 2. ILC inputs

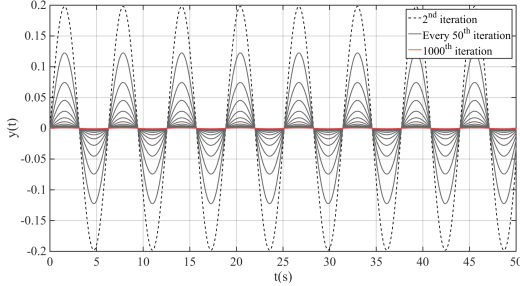

Fig. 3. System outputs

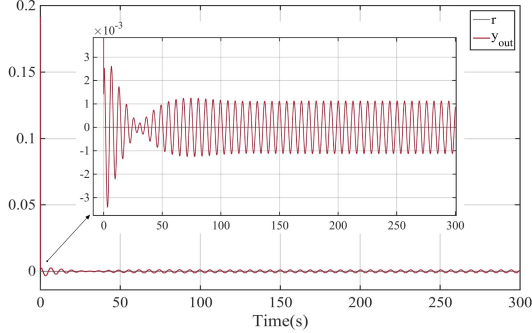

Fig. 4. System output with SOR-ILC

$0.8 \sin(\omega_1 t + \phi)^2 - 0.6 \sin(\omega_2 t + \phi)^3 - 0.35(\sin(\omega_3 t + \phi))^2]$  where  $\omega_1 = 0.27 \text{ rad/s}$ ,  $\omega_2 = 0.76 \text{ rad/s}$  and  $\omega_3 = 0.95 \text{ rad/s}$  are chosen to not have common divisors and  $\phi = 0$  for the first analysis. SOR-ILC is created by following the procedure given in Sec. 4. First, ILC learns the periodic frequencies of the disturbances under the varying uncertainty between iterations (see Fig. 5). This process allows to detect  $N_f = 18$  frequencies coming from the disturbances of which the maximum amplitude reduced by 86.8%. Next, these frequencies are used for building the internal model unit of the output regulator as shown in Sec. 4.3. Then, the remaining step is to tune the stabiliser unit parameters considering the equations (9), (11), (13), (14). It can be seen in (11) that the number

of needed tuning parameters become  $\rho + 1 = 37$ . For the simulation,  $\beta$  is set to 0.1 as before and all  $\mu_i$  values are chosen to be 100. In addition, we decide to analyse the effect of the number of disturbance frequencies used in creating the SOR-ILC. Therefore, the frequencies are put in the order of decreasing amplitude and then 18 tests are carried out by adding a new frequency into SOR-ILC before each test. The results of these tests are shown in Fig. 6. In the test 1, the amplitude of the disturbance is the highest since SOR-ILC uses only one frequency. In the remaining tests, the amplitude of the disturbance approaches a smaller value as we include new frequencies in SOR-ILC. Furthermore, the final system output obtained in the test 18 reaches the same form of the signal calculated by ILC alone and it is less in amplitude which can be attributed to the feedback gains inside the output regulator. The maximum amplitude of the disturbance is observed to be 92.9% smaller than that obtained through ILC only. Another demonstration is done in Fig. 7 by switching the SOR-ILC on and off (this time  $\phi = \pi/4$  in  $d(t)$ ,  $x_0 = [0, 0.2]^T$  in (17) and SOR-ILC uses all the learned frequencies). One can observe that when SOR-ILC is switched on, the amount of disturbance attenuation highly increases which proves once again the efficiency of SOR-ILC.

## 6. CONCLUSION

The results obtained through this work has demonstrated the feasibility of combining iterative learning control with traditional output regulation for accommodating periodic disturbances. The proposed SOR-ILC method has shown that ILC can be used to supervise an output regulator scheme. From another point, it has been shown that it is possible to transform the data-based ILC into an output regulator form by means of SOR-ILC. It has been figured out that through data-based iterative learning SOR-ILC can remove the necessity of making mathematical assumption for unknown disturbance frequencies when applying conventional output regulation. Moreover, the simulations has proven that by using SOR-ILC one can achieve a better rejection performance than the case of applying ILC alone. The residual error of the output regulation is related to frequency and model uncertainties whereas ILC's residual error is due to *iteration number* and model uncertainties. The variations in the disturbances between iterations has some impact on ILC learning due to their non-repetitiveness; however, ILC can still capture the average frequencies present in the disturbances. Thankfully, the residual uncertainty in the learned frequencies can be compensated by adjusting  $\mu_i$  values of the output



regulator. As a future work, the efficiency of SOR-ILC can be further tested for nonlinear systems, by following Astolfi et al. (2019), and with real-life problems where designers are confronted with unwanted periodicities such as periodic oscillations in fluid flows, rotary systems etc.

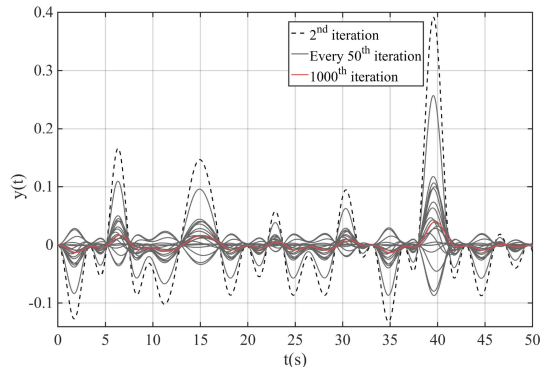

Fig. 5. System outputs with ILC only

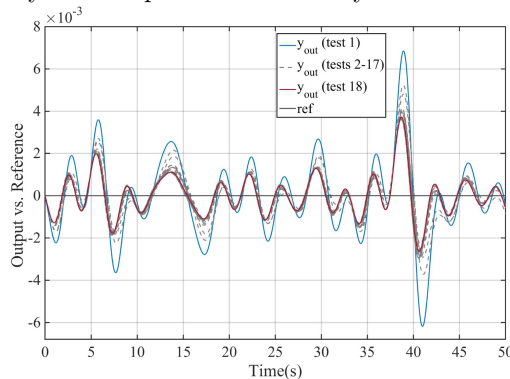

Fig. 6. System outputs with SOR-ILC

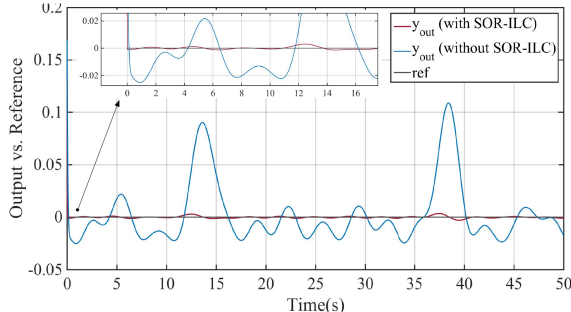

Fig. 7. System outputs with SOR-ILC (on/off)

## REFERENCES

- Alsubaie, M.A., Alhajri, M.K., Altowaim, T.S., and Salamah, S.H. (2019). Robust conditions for iterative learning control in state feedback and output injection paradigm. *Journal of Control Science and Engineering*, 2019.
- Arimoto, S., Kawamura, S., and Miyazaki, F. (1984). Bettering operation of robots by learning. *Journal of Robotic systems*, 1(2), 123–140.
- Astolfi, D. (2016). *Observers and robust output regulation for nonlinear systems*. Ph.D. thesis.
- Astolfi, D., Praly, L., and Marconi, L. (2019). Francis-wonham nonlinear viewpoint in output regulation of minimum phase systems. In *11th IFAC Symposium on Nonlinear Control Systems*. IFAC.
- Bin, M., Marconi, L., and Teel, A.R. (2019). Adaptive output regulation for linear systems via discrete-time identifiers. *Automatica*, 105, 422–432.
- Bristow, D.A., Tharayil, M., and Alleyne, A.G. (2006). A survey of iterative learning control. *IEEE control systems magazine*, 26(3), 96–114.
- Browne, F., Chiu, G., and Jain, N. (2018). Iterative learning control for periodic disturbances in twin-roll strip casting with measurement delay. In *2018 Annual American Control Conference (ACC)*, 4458–4463. IEEE.
- Byrnes, C.I., Priscoli, F.D., and Isidori, A. (1997). Output regulation of nonlinear systems. In *Output Regulation of Uncertain Nonlinear Systems*, 27–56. Springer.
- Califano, F., Bin, M., Macchelli, A., and Melchiorri, C. (2018). Stability analysis of nonlinear repetitive control schemes. *IEEE control systems letters*, 2(4), 773–778.
- Chen, C.L. (2016). Robust adaptive repetitive and iterative learning control for rotary systems subject to spatially periodic uncertainties. *Robust Control: Theoretical Models and Case Studies*, 99.
- Davison, E. (1976). The robust control of a servomechanism problem for linear time-invariant multivariable systems. *IEEE transactions on Automatic Control*, 21(1), 25–34.
- Ding, Z. (2003). Global stabilization and disturbance suppression of a class of nonlinear systems with uncertain internal model. *Automatica*, 39(3), 471–479.
- Francis, B.A. and Wonham, W.M. (1976). The internal model principle of control theory. *Automatica*, 12(5), 457–465.
- Ha, I.J. and Park, J.K.J.J.W. (2008). A fast iterative learning control approach to rejection of periodic disturbances. *IFAC Proceedings Volumes*, 41(2), 2844–2849.
- Hara, S., Yamamoto, Y., Omata, T., and Nakano, M. (1988). Repetitive control system: A new type servo system for periodic exogenous signals. *IEEE Transactions on automatic control*, 33(7), 659–668.
- Koçan, O., Poussot-Vassal, C., and Manecy, A. (2019). Towards the automatic tuning of linear controllers using iterative learning control under repeating disturbances. In *2019 18th European Control Conference (ECC)*, 3940–3945. IEEE.
- Marino, R. and Santosuosso, G.L. (2007). Regulation of linear systems with unknown exosystems of uncertain order. *IEEE Transactions on Automatic Control*, 52(2), 352–359.
- Moore, K.L. (1999). Iterative learning control: An expository overview. In *Applied and computational control, signals, and circuits*, 151–214. Springer.
- Nikiforov, V. (1998). Adaptive non-linear tracking with complete compensation of unknown disturbances. *European journal of control*, 4(2), 132–139.
- Norrlöf, M. (2000). Iterative learning control—analysis, design, and experiments.
- Serrani, A., Isidori, A., and Marconi, L. (2001). Semi-global nonlinear output regulation with adaptive internal model. *IEEE Transactions on Automatic Control*, 46(8), 1178–1194.
- Steinberg, S.J., Staats, M., Nitsche, W., and King, R. (2015). Iterative learning active flow control applied to a compressor stator cascade with periodic disturbances. *Journal of Turbomachinery*, 137(11), 111003.
- Steinbuch, M. and van de Molengraft, R. (2000). Iterative learning control of industrial motion systems. *IFAC Proceedings Volumes*, 33(26), 899–904.