



**HAL**  
open science

# INVESTIGATION OF ELECTROMAGNETIC FIELDS ON CARDIAC CELLS

M Cinato, Junwu Tao, S Keita, Serge Lefeuvre, O. Kunduzova

► **To cite this version:**

M Cinato, Junwu Tao, S Keita, Serge Lefeuvre, O. Kunduzova. INVESTIGATION OF ELECTROMAGNETIC FIELDS ON CARDIAC CELLS. 17th International Conference on Microwave and High Frequency Heating (AMPERE 2019), Sep 2019, Valence, Spain. hal-02552345

**HAL Id: hal-02552345**

**<https://hal.science/hal-02552345v1>**

Submitted on 23 Apr 2020

**HAL** is a multi-disciplinary open access archive for the deposit and dissemination of scientific research documents, whether they are published or not. The documents may come from teaching and research institutions in France or abroad, or from public or private research centers.

L'archive ouverte pluridisciplinaire **HAL**, est destinée au dépôt et à la diffusion de documents scientifiques de niveau recherche, publiés ou non, émanant des établissements d'enseignement et de recherche français ou étrangers, des laboratoires publics ou privés.

## INVESTIGATION OF ELECTROMAGNETIC FIELDS ON CARDIAC CELLS

M. Cinato<sup>1</sup>, J. Tao<sup>2</sup>, S. Keita<sup>1</sup>, S. Lefeuvre<sup>3</sup>, O. Kunduzova<sup>1</sup>

<sup>1</sup>IINSERM, UMR1048, 1 av. Jean Poulhès, 31432, Toulouse, France

<sup>2</sup>Toulouse University, INP-ENSEEIH, LAPLACE, Toulouse, France

<sup>3</sup>CREAWAVE, 16 all. Chantecaille, 31670 Labège, France

tao@laplace.univ-tlse.fr

**Keywords:** Electromagnetic field, cardiac cell, interaction, SAR

**Summary:** Exposure to electromagnetic fields (EMF) has become a sensitive topic for the public health. Despite accumulative exposure of humans to EMF, their effects on oxidative stress and cell death status in cardiac cells have not been studied. In the present study, the properties of transverse electromagnetic (TEM) cells were explored by varying the frequency and the power at first, then the temporal shape of the source EMF in a second time. In addition, we evaluated the effects of EMF on antioxidant and cell death/survival status of H9C2 cardiomyoblasts. Using reverse transcription quantitative PCR (RT-qPCR), we analyzed mRNA expression of antioxidant enzyme catalase, anti-apoptotic factor Bcl-2 and pro-apoptotic factor Bax in H9C2 cells subjected to 915 MHz for 24h, 48h and 72h. The exposure of H9C2 cells to EMF for 24h, 48h and 72h did not significantly change mRNA expression levels of catalase, Bcl-2 and Bax. Therefore, these results indicate that short-term exposure to EMF did not influence antioxidant and cell death status in cardiomyoblasts.

## I. INTRODUCTION

The use of electrical devices has gradually increased throughout the last century, and scientists have suggested that electromagnetic fields (EMF) generated by such devices may affect living systems. Lifetime exposure to EMF is becoming the subject of extensive scientific investigations since it has the potential to cause crucial changes and deleterious biological effects<sup>1-3</sup>. Studies in recent years have reported that EMF impact functional potentials of cells and organelles via affecting enzymes, membrane receptors and causes some disorders<sup>4</sup>. The adverse biological effects of EMF on tissues associated with oxidative stress reflecting an imbalance between the generation of reactive oxygen species (ROS) and the antioxidant capacity of the cell<sup>5</sup>. Oxidative stress plays an important role in DNA damage process, specific gene expression and cell apoptosis. Antioxidant defense systems have developed in organisms to control the formation of ROS and to prevent the harmful effects of these molecules<sup>6</sup>. Catalase is a crucial antioxidant enzyme in the protection of the cell against oxidative damage caused by ROS. Altered catalase expression has been associated with several diseases including diabetes, hypertension, Alzheimer disease<sup>7</sup>. If these antioxidant defense mechanisms are impaired through exposure to EMF that causes the overproduction of ROS, antioxidants may not be sufficient or ROS formation may increase to such an extent that it overpowers the defense capabilities of antioxidants<sup>8</sup>. Depending on the intensity, EMF could have direct or indirect effects on functional status of cells and physiological systems<sup>1,9,10</sup>. However, there is still much uncertainty on the EMF interactions with cellular antioxidant system and several questions remain to be answered.

In this study, we sought to determine whether EMF could affect cell death/survival and antioxidant system status in cardiomyoblasts.

## II. PRESENTATION OF THE IN VITRO EXPOSURE SYSTEM

### II.1. Radiofrequency equipments

A large number of studies have been conducted on the RF and microwave exposure of biological media. Among the equipment satisfying the criteria of broad frequency ranges and waveform modulation we find TEM and GTEM cells, as well as partially open transmission structures<sup>11</sup>. On our side we have opted for a TEM cell whose dimensions are compatible with the support of cells on one side, and easily integrated in a controlled temperature and hydrometry system.

The TEM cell is powered by a fixed frequency solid-state RF generator (915MHz) of variable power that can go up to 1kW.

### II.2. *In vitro* model

Rat cardiomyoblasts (H9C2 cell line) are cultured in DMEM (Dulbecco's Modified Eagle Medium) Glutamax supplemented with 10% fetal calf serum (FCS). The cells are cultured in a Petri dish (80-90% confluence) placed above the central conductor of the TEM cell. H9C2 cells were exposed to 915 MHz for 24h, 48h and 72h.

## III. NUMERICAL RESULTS

### III.1. Determination of the dielectric properties of the biological medium

In order to perform electromagnetic modeling of the recommended exposure system, knowledge of the dielectric property of the biological medium is essential<sup>12,13</sup>. For this, the technique of measuring samples reported on a microstrip transmission line was used<sup>14</sup>. Instead of a thin film of solid dielectric we used a rectangular container of very thin wall. The measuring cell with the presence of liquid DMEM Media - GlutaMAX<sup>TM</sup> is shown in Fig.1.

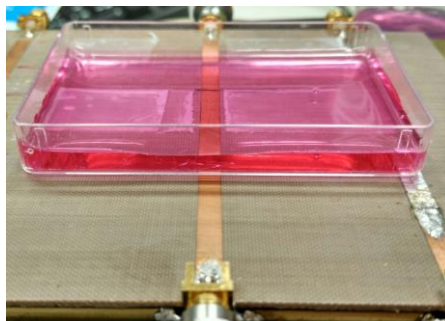

**Fig.1** Permittivity measurement cell.

The extraction of the complex permittivity as a function of the frequency is based on the comparison between measurements carried out using a vector network analyzer and an electromagnetic modeling of the cell using finite element software (HFSS). In order to validate the approach of the tests were performed on liquid samples references.

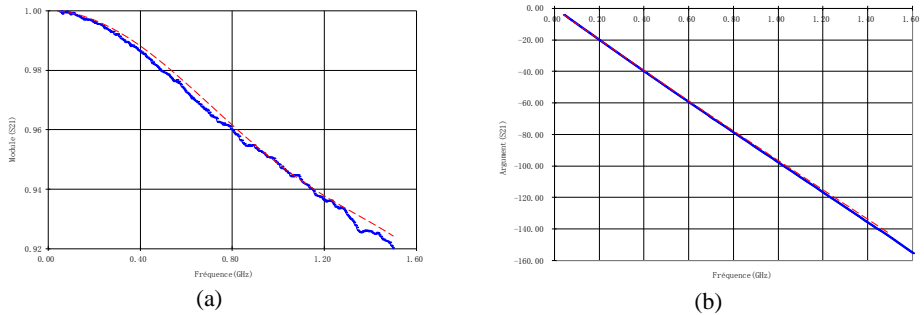

**Fig.2** Comparison between measured and calculated (a) Module and (b) Phase of the transmission coefficient of the cell with 95% ethanol.

Fig.2 shows comparisons between simulations and measurements on 95% ethanol. Modeling in HFSS uses a simple relaxation model with  $\epsilon_r(0)=25$ ,  $\epsilon_r(\infty)=4.78$ ,  $\tau_d=159$ ps. There is good agreement on the phase of the transmission coefficient, as well as comparable results on its module. Results were also obtained on tap water with a model at a relaxation frequency giving acceptable agreement up to 800MHz.

The extraction procedure was applied to the liquid DMEM Media - GlutaMAX™ whose first results are shown in Fig.3. The increase of the imaginary part as a function of the frequency shows its capacity of absorption of the electromagnetic energy in the range of radio frequency.

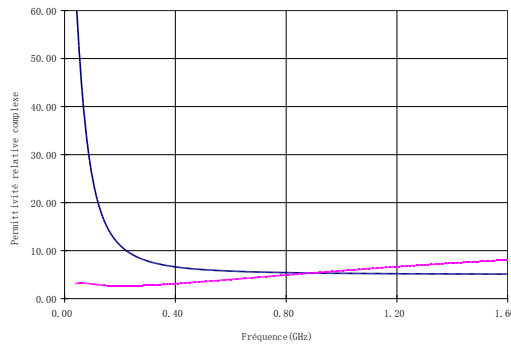

**Fig.3** Real (blue) and imaginary (pink) part of the complex relative permittivity of the DMEM Media - GlutaMAX™ liquid.

### III.2. EM fields in the TEM cell

The TEM cell used in our experiment was modeled in HFSS. Fig.4 gives an overview of the presence in the center of a kneaded box in the center of the cell.

Simulations have been performed for several scenarios between 100MHz and 915MHz for the following scenarios:

- ✓ Empty TEM cell
- ✓ TEM cell with empty Petri dish
- ✓ TEM cell with Petri dish filled with water of a certain thickness, from 2mm to 10mm.

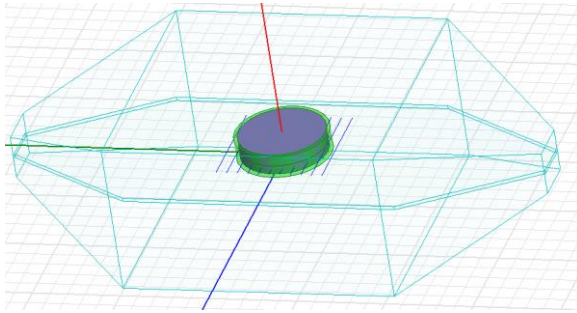

**Fig.4** TEM cell modeled in HFSS.

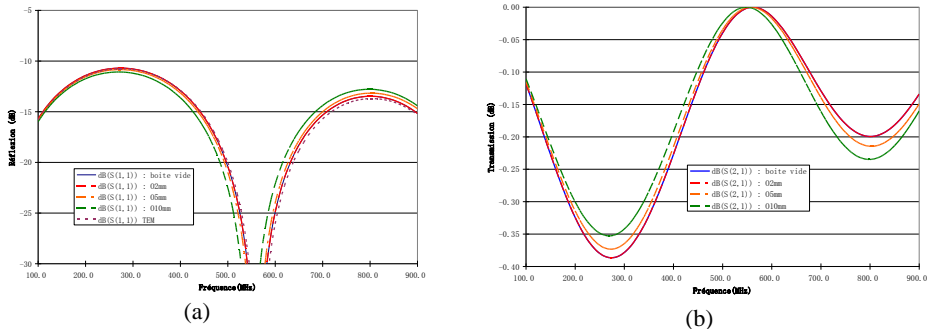

**Fig.5** Coefficients of reflection (a) and transmission (b) of the TEM cell for different scenarios.

As shown in Fig.5 we compared the reflection coefficients for the different conditions (Fig.5 (a)) and the transmission coefficients (Fig.5 (b)). Due to the relatively modest volume of the petri dish the influence on the reflection remains low. Even in the presence of a liquid thickness of 10mm the degradation of the reflection level is only 0.9dB passing from -15.3dB in an empty cell at -14.4dB.

The transmission coefficient records a difference of 0.03dB from -0.13dB to 2mm of liquid at -0.16dB to 10mm of liquid at 900MHz. There is therefore a greater absorption of electromagnetic energy with a larger amount of liquid. This increase is much more visible on the results of simulation of the specific absorption rate (SAR) as shown in Fig.6. Indeed with an excitation power of the default cell, the SAR in the liquid is almost 9 times higher with a liquid thickness of 10mm than the case of 2mm.

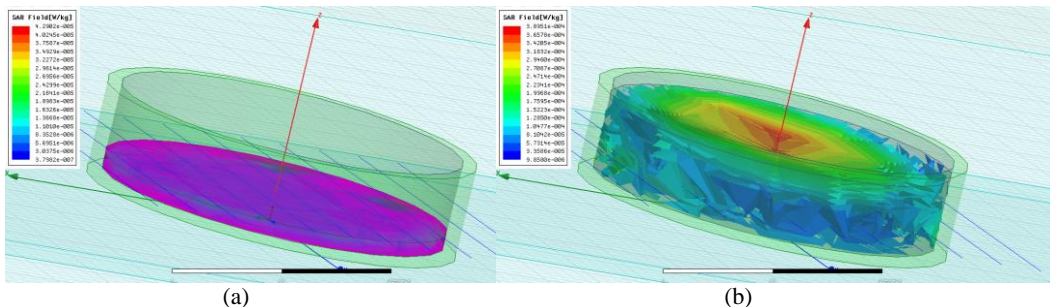

**Fig. 6** Specific Absorption Rate in the liquid. (a) 2mm thick water (b) 10mm thick water.

The same work must be continued under the following conditions:

- ✓ Replacement of water with DMEM Media - GlutaMAX™;
- ✓ The use of an effective medium with the presence of living cells;
- ✓ SAR optimization based on product quantity and location of the petri dish.

## IV. EXPERIMENTAL RESULTS

### IV.1. Reflection of TEM cell

The first experimental results concern measurements of S parameters of the TEM cell:

- ✓ Without the Petri dish;
- ✓ With the empty Petri dish;
- ✓ With a Petri dish partially filled with water.

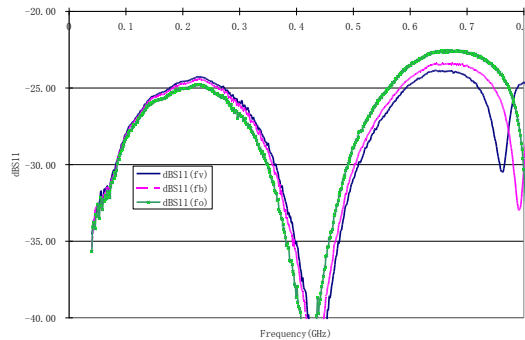
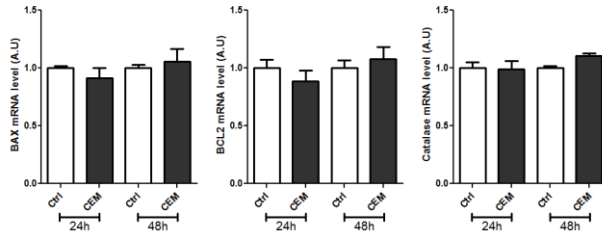

Fig.7 Measured reflection.

There is a similar appearance to the simulation results, but with a much lower reflection level which indicates a more favorable real operating condition than is suggested by the HFSS simulation in which all the details of the cell could not be modeled. As expected the presence of the Petri dish filled with liquid increases the level of reflection but remains negligible.

### IV.2. 1st exposure test *in vitro*

The first exposure tests on H9C2 cells were performed in an environment controlled temperature and hydrometry using a 915 MHz generator with a modest power of 13dBm. Expression patterns for pro-apoptotic factor (BAX), anti-apoptotic factor (BCL2) and antioxidant enzyme (catalase) in H9C2 cells exposed to EMF for 24h, 48h and 72h were determined by RT-PCR. As shown in Fig. 8, exposure of H9C2 cells to 915 MHz did not significantly change the mRNA expression of BAX, BCL2 and catalase as compared to control conditions. In H9C2 cells subjected to EMF for 72h, BCL2 and catalase mRNA levels showed a tendency to decrease, but this did not reach statistical significance (Fig.9) as compared to control. The exposure of H9C2 cells to EMF for 72h did not alter the expression of Bax protein, marker of intracellular pathway of apoptosis initiation. These results suggest an adaptive response of cells subjected to the 915 MHz frequency EMF. However, additional experiments are needed to determine the long-term effects of EMF on cell death/survival balance and antioxidant system in cardiac cells.



**Fig.8** Dynamics of expression of antioxidant enzyme catalase and pro- and anti-apoptotic factors in H9C2 cells exposed to EMF for 24h and 48h. The results present the mean  $\pm$  SEM of 3 independent experiments.

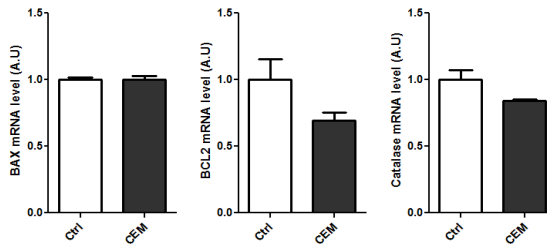

**Fig.9** Dynamics of expression of antioxidant enzyme catalase and pro- and anti-apoptotic factors in H9C2 cells exposed to EMF for 72h. The results present the mean  $\pm$  SEM of 3 independent experiments.

## V. DISCUSSION

Recently, public concern has been raised in relation to the possible health risks of EMFs emitted from mobile phones and Wi-Fi devices, since the use of such devices has increased exponentially in daily life. The molecular machinery regulating cell death has started becoming elucidated, and a number of studies have undertaken the task to determine the role of oxidative stress in cell fate determination within the context of human disease progression. Oxidative stress and stress-induced cell reprogramming are also largely involved in the pathophysiology of human diseases, where both survival and cell death signaling cascades have been reported to be modulated by ROS. Excessive ROS production is associated with elevated oxidative damage to DNA, proteins, and lipids as a result of unbalanced pro-oxidant and antioxidant activities<sup>5</sup>. A previous study showed that oxidative damage associated with neurodegenerative diseases has deleterious effects on brain tissue<sup>15</sup>. Another study reported that RF exposure at 1800 MHz slightly elevated the concentration of lipid peroxidation markers in the brain<sup>16</sup>. In the present study, to elucidate whether EMF affect cell death and antioxidant status in cardiac cells, we evaluated mRNA expression of BAX (pro-apoptotic factor), BCL2 (anti-apoptotic factor) and catalase (antioxidant enzyme) in H9C2 cells subjected to EMF 915 MHz for 24h, 48h and 72 h. We did not observe significant differences in BAX, BCL2 and catalase levels after EMF exposure for 24h-72h, indicating that short-term EMF exposure did not influence

antioxidant system and cell death status in cardiomyoblasts. However, further studies examining dynamic changes in oxidative stress and apoptosis after long-term exposure of cardiac cells EMFs are warranted.

## References

1. Guler, G., et al, *Bull. Vet. Inst. Pulawy*, 2011, **55**, pp. 127-134
2. Salaha, M. B., et al, *Toxicol. Pharmacol.*, 2013, **36**, pp. 826-834
3. Khalid, M., et al, *Prog. Biophys. Mol. Biol.*, 2011, **107**, pp. 412-420
4. Ghazizadeh, V., M. Nazırođlu, *Metab. Brain Dis.*, 2014, **29**, pp. 787-799
5. Moris, D. et al, A. Litwin, *Ann Transl Med*, 2017, **5**, 324
6. Altamura, G., et al, *PACE*, 1995, **18**, pp. 194-198
7. Goraca A, et al, *J Physiol Pharmacol*. 2010, **61**, pp. 333-338
8. Calcabrini C, et al, *Biotechnol Appl Biochem*. 2017,**64**, pp. 415-422
9. Glorieux C, et al, *Free Radic Biol Med*. 2015, **87**, pp. 84-97.
10. Gould, L., et al, *PACE*, 1981, **4**, pp. 575-577
11. Paffi, A. et al, *IEEE Trans. on MTT*, 2010, **10**, pp. 2702–2714.
12. Allal, D. A. Litwin, *Revue française de métrologie*, 2014, **1**, pp. 21-27
13. Wiart, J., *Private communication*.
14. Wang, J.Y. et al, *AMPERE Newsletter*, 2017, **94**, pp. 2702–2714
15. Finkel T., N.J. Holbrook, *Nature*, 2000, **408**, pp. 239-247
16. Bodera P., et al, *Int. J. Occup. Med. Environ. Health*. 2015, **28**, pp. 751–759