



**HAL**  
open science

## Brevia and Demonstrations Presentations

Anind Dey, Boicho Kokinov, David Leake, Roy Turner, Patrick Brézillon

► **To cite this version:**

Anind Dey, Boicho Kokinov, David Leake, Roy Turner, Patrick Brézillon. Brevia and Demonstrations Presentations. Anind DEY; Boicho KOKINOV; David LEAKE; Roy TURNER; Patrick BRÉZILLON. 5th International and Interdisciplinary Conference on Modeling and Using Context (CONTEXT-05), Jul 2005, Paris, France. lip6.2005.007, LIP6, 2005. hal-02549803

**HAL Id: hal-02549803**

**<https://hal.science/hal-02549803>**

Submitted on 21 Apr 2020

**HAL** is a multi-disciplinary open access archive for the deposit and dissemination of scientific research documents, whether they are published or not. The documents may come from teaching and research institutions in France or abroad, or from public or private research centers.

L'archive ouverte pluridisciplinaire **HAL**, est destinée au dépôt et à la diffusion de documents scientifiques de niveau recherche, publiés ou non, émanant des établissements d'enseignement et de recherche français ou étrangers, des laboratoires publics ou privés.



## **Brevia and Demonstrations Presentations**

**-- Proceedings --**

**Anind Dey, Carnegie Mellon University, USA**

**Boicho Kokinov, New Bulgarian University,  
Bulgaria**

**David Leake, Indiana University, USA**

**Roy Turner, University of Maine, USA**

**Patrick Brézillon, University of Paris 6, France**

Paris, France, July 5-8, 2005

**Managing Editors: Caroline Chéneau & Céline Manetta**

## Preface

Context is of crucial importance for research and applications in many disciplines, as evidenced by many workshops, symposia, seminars, and conferences on specific aspects of context. The International and Interdisciplinary Conference on Modeling and Using Context (CONTEXT), the oldest conference series focusing on context, provides a unique interdisciplinary emphasis, bringing together participants from a wide range of disciplines, including artificial intelligence, cognitive science, computer science, linguistics, organizational science, philosophy, psychology, ubiquitous computing, and application areas such as medicine and law, to discuss and report on context-related research and projects.

Previous CONTEXT conferences have been held in Rio de Janeiro, Brazil (1997), Trento, Italy (1999, LNCS 1688), Dundee, Scotland (2001, LNCS 2116), and Palo Alto, U.S.A. (2003, LNCS 2680). CONTEXT'05, was held in Paris, France, from July 5-8, 2005.

This proceedings contains the accepted Brevia and Demonstration submissions. We would like to thank the reviewers for both categories in assuring the quality of the technical program. We would like to thank the members of the program committee and all of our additional reviewers for their careful work in assuring the quality of the technical program. We would also like to thank the Organizing Committee, for their tireless efforts. Special thanks are due to Isabel Urdapilleta for her preparation of these proceedings and to Jean-Marc Meunier for his assistance in making sure that the technical needs of the demonstrations were met.

We hope that the contributions reported here will illustrate the rich range of current contributions to context, and will provide a foundation for drawing on the best work from many areas in the next generation of research on context.

July 2005

Anind Dey, Carnegie Mellon University, USA  
Boicho Kokinov, New Bulgarian University, Bulgaria  
David Leake, Indiana University, USA  
Roy Turner, University of Maine, USA  
Patrick Brezillon, University of Paris 6, France

## Table of Contents

### BREVIA

Rosa A. Alarcon, Luis A. Guerrero. Jose A. Pino - Groupware Components as Providers of Contextual Information

Gemma Bel-Enguix, M. Dolores Jiménez-López - Modelling context in formal language theory

Salete Bento, Maria de Fatima Simoes - Cognitive modifiability on brain injury: A case study

Aurélie Dommes, Marie-Louise Le Rouzo - Effects of context, familiarity and aging on the interpretation of ambiguous sentences

Angelique Ducreux-Fournier, Isabelle Tapiero - Emotional induction and valence of macrostructural information: the effect on the temporal course of the mental representation course of the mental representation

Michael Evans, David Leake, Donald F. McMullen, Steven Bogaerts – Ethnographic methods to study context: An illustration

Philippe Fauquet - Applied crossed confrontation for context evolution

Frédérique Fornier – The influence of bilingualism on story comprehension

Leslie Ganet, Charles Tijus, Patrick Brézillon - Context, categorization and explanation: A review

Frédérique Girard, Jeremy Goslin, Caroline Floccia – Influence of regional accents in speech perception

Anneli Heimbürger - Time Contexts in Distributed Projects: Towards an Interdisciplinary Temporal Framework

Nyssim Lefford, Johnny Wingstedt, Cecilia Sjömark - Context, individuality and music's affect on listeners

Fanny Lichtenstein, Fernando Gabucio - The contextualist perspective and the true/false judgement of utterances: literal truth and pragmatic truth

Céline Manetta, Isabel Urdapilleta - Influence of the olfactory category's homogeneity on the description of odors

Phivos Mylonas, Manolis Wallace, Yannis Avrithis - Context modeling for multimedia analysis

Georgi Petkov, Penka Hristova, Boicho Kokinov - How irrelevant information influences Judgment

Alfonso Santarpià, Alain Blanchet, Riccardo Venturini, Michele Cavallo - Perceptive-literary construction of the body in clinical psychology

### **DEMONSTRATIONS**

P. Benci, Patrick Brézillon, D. Potier - Acquiring and representing users' practices by contextual graphs

Mehdi El Jed, Bernard Pavard, Nico Pallamin - Towards rich context virtual worlds

Babak Hodjat, Siamak Hodjat, Nick Treadgold - A mobile context reactive natural language user interface

Oriana Riva, Tapio Pitkaranta, and Santtu Toivonen - Proactive context-aware service provisioning for a marine community

Aviv Segev - Automated context recognition: An algorithmic approach



# Groupware Components as Providers of Contextual Information

Rosa A. Alarcon<sup>1</sup>, Luis A. Guerrero<sup>2</sup>, José A. Pino<sup>2</sup>

<sup>1</sup> Department of Computer Science, Pontificia Universidad Católica de Chile  
Vicuña Mackenna 4860, Santiago 6904411, Chile.  
ralarcon@ing.puc.cl

<sup>2</sup> Department of Computer Science, Universidad de Chile  
Blanco Encalada 2120, Santiago 6511224, Chile.  
{lguerre, jpino}@dcc.uchile.cl

**Abstract.** Group work context involves many more elements than individual work context. Few researchers have tried to identify context for groupware systems. However, such models are limited to certain kind of contextual information such as location, while others more relevant for group-work are neglected. From a review of the work done in groupware, we discuss three main components for considering contextual information in groupware

## 1. Introduction

Although contextual information relevance has been recognized in the groupware community there have been very few attempts to characterize contextual information for groupware while most effort has been done on studying how to represent this information [6]. The Merriam Webster On Line dictionary defines context as “*the interrelated conditions in which an event, action, etc. takes place*”. This definition is too general: it is necessary to determine which is the situation at hand (e.g. group work) and which are its relevant conditions. Context has been analyzed at different grains of specificity: it could describe the project (documents, projects, and processes), the group (location and members’ status) or the individual (availability) [4]. Others [11] suggest the existence of three main components of the shared environment: content, team, and process structure. According to the previous works, the minimal common elements useful to determine the group context would be: people, tasks and resources, but again this approach is too general. In order to provide more insights into its definition, we have reviewed research done in the area in the last decade in order to identify the diverse contextual information that can be provided by the three main components of groupware: people, task, and resources. They are presented and briefly discussed below.



## 2. Groupware Components as Providers of contextual information

### 2.1. Group context

Some researches provide *structure* to groupware components (people, task and resources). The structure captures the work context and by being aware of it, group members can coordinate their actions smoothly. Group context can be also described through groupware elements states. Generally, a *state* describes a condition the element holds (e.g., a user *is* busy), a stage (e.g., a document *is* under revision) or an emotion (e.g., a user *is* angry). Users can determine the appropriate action to follow-up under the current circumstances or context by being aware of such states. Some researches focus on location: a user or a resource can be located inside or outside the virtual shared space. Other concepts strongly related with location are presence [13], co-presence [13], distance among group members, proximity, visibility, space and place. A *place* differs from a *space* because it is “invested with understandings of behavioral appropriateness, cultural expectations, and so forth”; hence, people context differs depending on whether they are at a theatre or in a park [12].

All these issues represent the static aspects of group context, while the dynamic aspects are represented by actions and activities. An action is an act performed by a purposeful agent, while an activity includes a series of actions that can be meaningful and is considered the minimal piece of contextual information [5]. We discuss these concerns further below.

### 2.2. Component 1: People

People organize themselves in various *organizational* structures (e.g. hierarchical, subgroups, communities, etc.) assigning roles and responsibilities to their members and defining control and responsibility relationships. By being aware of this structure group members regulate their interaction easing coordination, cooperation and collaboration by means of developing explicit or implicit *conventions* or protocols [15, 17, 7]. Users’ availability and presence (*status*) can be obtained by always-on audio or video connections [3], by public icons [9] or by determining patterns of presence, attendance or activity [2, 6]. By being aware of their availability, group members can engage in casual or informal (not pre-arranged) interaction (also known as informal awareness [3]). Users can also be in several emotional states. By being aware of other’s emotional states, group members can adjust their interaction and develop social strategies, such as approaching a colleague. Related research is also known as “emotional awareness” [8]. By being aware of *location*-related concepts (presence, distance, proximity, etc.), teammates can develop a sense of community, understand a person’s situation and adapt their actions according to it. *Actions* performed by other group members can allow a person to make informed decisions about his or her own work. Actions reflect the things done by a person, or an accomplishment over a period of time, in stages. By being aware of others’ actions a user can provide teammates timely help, avoid collisions or misunderstandings [10],

monitor the project progress and teammates' involvement in the global work. Research in this area is known as workspace-actions awareness [10], and active knowledge awareness [16].

### **2.3. Component 2: Task or Project**

Workflow is a very active area of research dealing with task structuring. Tasks are strongly related to the people performing it, but workflow main concern is the automation of processes where documents, information or tasks are directed to participants according to a defined set of rules to achieve, or contribute to, an overall business goal. By being aware of task structure, group members can regulate their interaction by means of understanding how their contributions fit into the whole picture, which actions could take place or who will be affected by performing it. In CSCL, interaction states occurring in a learning scenario are also modeled [14]. Under this approach group context is modeled by taking into consideration the tasks-network assigned and performed by group members. Again, this network contextualizes the events occurring during a collaborative interaction.

### **2.4. Component 3: Resources**

Resources can be expertise, concepts, information (e.g. documents, figures), software artifacts (e.g. a web portal), work artifacts (e.g. report templates), and representations of physical objects (a shared printer URL or a user ID). They are stored in a common repository, have a particular meaning and keep some *semantic relationships* among them. Resources can be also spatially arranged, or belong to abstract structures. Space can be a set of web pages, a geometric representation of the real world, modeled with location sensors or a graph of interconnected objects, holding semantic relationship among them, making possible to define a semantic distance. Finally, some researchers consider users' knowledge, expertise [16] or interest as a resource, and then their focus is to locate who is owner of the desired resource. The resources arrangement provides contextual information for users' actions. For instance, they can understand how the changes in a particular document impacts on others' work by knowing the documents semantically close.

## **3. Conclusions**

The context concept has been loosely applied to groupware systems. The work reported in this paper attempts to clarify and classify the context sources applicable to the development of such systems. The components help researchers to understand which can be considered contextual elements in groupware, e.g., roles, conventions. Finally, close examination of the discussion also provides research opportunities.

## Acknowledgments

This work was partially supported by grants No.1030959 and 1040952, Fondecyt (Chile).

## References

1. Alarcón, A., Fuller, D.A.: Intelligent Awareness in Support of Collaborative Virtual Work Groups. *LNCS*, 2440 (2002) 168-188.
2. Begole, J., Tang, J., Smith, R., Yankelovich, N.: Work Rhythms: Analyzing Visualizations Awareness Histories of Distributed Groups. Proc. of ACM Conference on CSCW (2002) 324-332
3. Botha, R.A., Eloff, J.H.P.: Designing Role Hierarchies for Access Control in Workflow Systems. Proc. of COMPSAC (2001) 117-122
4. Brézillon, P., Borges, M.R., Pino, J.A., Pomerol, J.Ch.: Context-Awareness in Group Work: Three Case Studies. Proc. of 2004 IFIP Int. Conf. on Decision Support Systems (DSS 2004), Prato, Italy, July (2004)
5. Carroll, J.M., Neale, D.C., Isenhour, P.L., Rosson, M.B., McCrickard, D.S.: Notification and Awareness: Synchronizing Task-Oriented Collaborative Activity. *IJHCS*. 8(5) (2003) 605-631
6. Dourish, P., Bellotti, V.: Awareness and Coordination in Shared Workspaces. Proc. of ACM Conference on Computer Supported Cooperative Work (CSCW'92), Toronto, (1992)
7. Endsley, M.R.: Theoretical underpinnings of situation awareness: a critical review. In: Endsley, M.R., Garland, D.J. (Eds.): *Situation Awareness Analysis and Measurement*. Lawrence Erlbaum, Mahwah, NJ (2000) 3-31
8. García, O., Favela, J., Machorro, R.: Emotional Awareness in Collaborative Systems. Proc. of International Workshop on Groupware (CRIWG'99) (1999) 286-293
9. Greenberg, S.: Peepholes: Low Cost Awareness of One's Community, ACM SIGCHI'96 Conf. on Human Factors in Computing System, Companion Proceedings (1996) 206-207
10. Gutwin, C., Greenberg, S.: A framework of Awareness for Small Groups in Shared Workspace Groupware. Tech. Rep. 99-1, Dep. of Comp. Science, Univ. of Saskatchewan, Canada (1999)
11. Haake, J.M.: Structural Computing in the Collaborative Work Domain? Lecture Notes in Computer Science, 1903 (2000) 108-119
12. Harrison, S., Dourish, P.: Re-Placing space: The roles of place and space in collaborative systems. Proc. of the ACM Conference on CSCW (1996) 67-76
13. Ijsselsteijn, W., Riva, G.: Being There: The experience of presence in mediated environments. In Riva, G., Davide, F., Ijsselsteijn, W.A (Eds.) *Being There: Concepts, effects and measurement of user presence in synthetic environments*. IOS Press, Amsterdam. Vol. 5 (2003) 4-16
14. Jermann, P., Soller, A., Muehlenbrock, M.: From Mirroring to Guiding: A Review of State of the Art Technology for Supporting Collaborative Learning.

- Proc. of 1st European Conference on CSCL, Maastricht, The Netherlands (2001)  
313-320
15. Mark, G.: Conventions and commitments in distributed groups. *Computer Supported Cooperative Work: The Journal of Collaborative Computing*, Vol. 11(3-4) (2002) 337-367
  16. Ogata, H., Matsura K., Yano, Y.: Combining knowledge awareness and information filtering in an open-ended collaborative learning environment. *Int. J. of AI-ED* Vol.11 (2000) 32-44
  17. Rodenstein, R., Donat, J.: Talking in Circles: A Spatially-grounded Social Environment. *Proceedings of ACM CHI* (2000) 81-88

# Modelling Context in Formal Language Theory. Extended Abstract

Gemma Bel Enguix and M. Dolores Jiménez López\*

Research Group on Mathematical Linguistics  
Universitat Rovira i Virgili  
Pl. Imperial Tarraco, 1, 43005 Tarragona, Spain  
{gemma.bel, mariadolores.jimenez}@urv.net

## 1. Introduction

In this paper we approach the notion of context from a formal-language-theoretic point of view. We show how non-classical formal languages have modelled context in the so-called grammar system theory. We are interested in context from a *conversational* point of view, since our last goal here is to provide a formal-language-theoretical model of conversation with the explicitness, formality and efficiency that are required for computer implementation. The essential characteristic of the model is the use of simple grammars in order to generate a dialogue structure. We intend to show that the essential structure in conversation can be well and easily formalized by using a formal language tool and to this end we need to formalize *context*. For formalizing context in our conversational model we will take as starting point *grammar systems theory*, a consolidated and active branch in the field of formal languages [1].

## 2. Context in Colonies

Colonies as well-formalized language generating devices have been proposed in [4], and developed during the nineties in several directions in many papers. Roughly, a colony consists of a finite number of simple modules (regular grammars) which generate finite languages and operate on a shared string of symbols –the *context* of the colony— without any explicitly predefined strategy of cooperation. Each component has its own reactive behaviour which consists in: 1) sensing some aspects of the *context* and 2) performing elementary tasks in it in order to achieve some local changes.

The notion of *context* in colonies is a very simple and (passive) one: 1) The colony behaves in a *symbolic context* and changes context's states only through acts performed by simple agents –the components of the colony; 2) The *context* of a

---

\* This research has been supported by a Marie Curie European Reintegration Grant (ERG) under contract number MERG-CT-2004-510644.

colony is formed by strings of symbols, and therefore each *state of the colony's context* is modelled by a (finite) string of symbols; 3) *Context's states* (strings) may change only as results of sequential acts performed by components of the colony; 4) The set of all possible *states of the context* will be considered the language generated by the agents that form the colony; 5) Because of the lack of any predefined strategy of cooperation, each component participates in the rewriting of the current string whenever it can do so. Conflicts are solved nondeterministically; 6) *Context* itself is quite passive –it does not change its state autonomously, but only through the activities of agents. A colony is outlined in Figure 1.

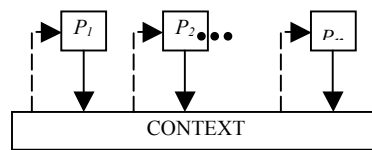

Figure 1. A colony.

### 3. Context in Eco-Grammar Systems

Even though interesting, the notion of context in colonies is too simple to fit the requirements of a conversational context. Colonies offer no possibilities to model environments own dynamics. Eco-grammar systems [2] are an extension of the formalism of colonies. They add to the strings which represent the states of the environment rules for changing themselves without any activity of the agents working with them. Additionally, the formalism enables also some kind of changes of the agents according to their previous 'life' in the (changing) environment.

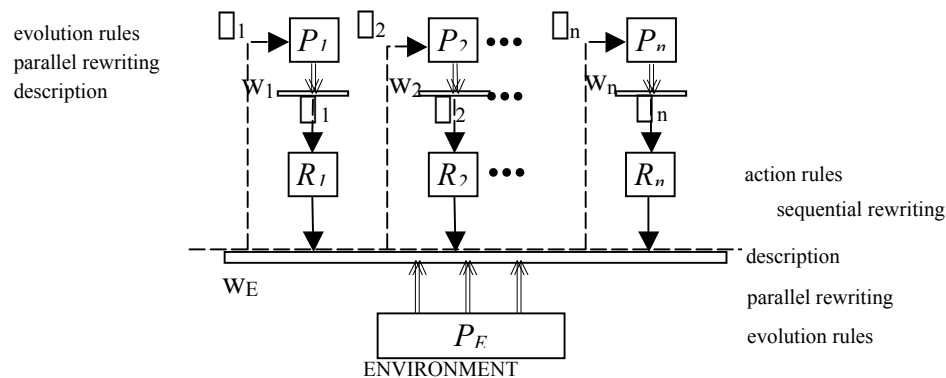

Figure 2. Eco-Grammar System.

Briefly, an eco-grammar system can be defined as a multi-agent system where different components, apart from interacting among themselves, interact with a special component called 'environment' –*context*. So, within an eco-grammar system we can distinguish two types of components *environment* and *agents*. Both are represented at any moment by a string of symbols that identifies current state of the component. These strings change according to sets of evolution rules (L systems). Interaction among agents and environment is carried out through agents' actions performed on the environmental state by the application of some productions (rewriting rules) from the set of action rules of agents. Main features of eco-grammar systems are captured in Figure 2.

The notion of context in eco-grammar systems is a little bit more complex than in colonies. Here, context is not passive, but active. Eco-grammar systems' context can change autonomously by means of its own evolution rules. It changes also due to agents' actions, but not only. So, definition of context in eco-grammar systems is closer to our idea of context for a dialogue model. However it still needing some additional features that will be introduced in the following section.

#### 4. Context in Conversational Grammar Systems

Let us start by a graphic view of conversational grammar systems (see figure 3).

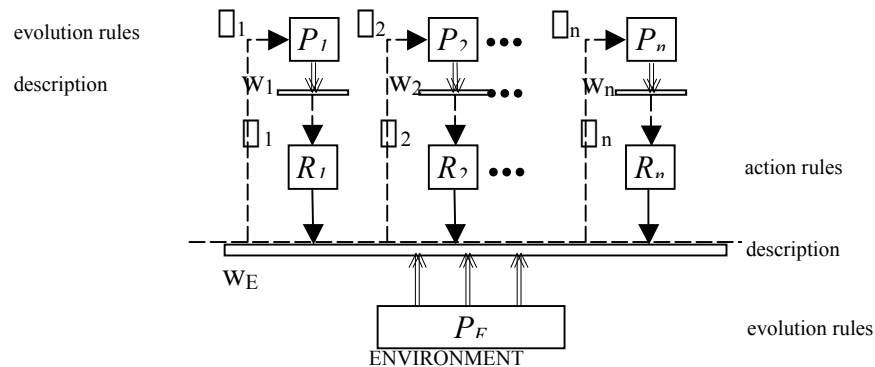

Figure 3. Conversational Grammar System

How do we formalize *context* in conversational grammar systems [3]? Any formalization implies, obviously, an abstraction, and therefore our definition of context will try to capture its essential idea, ignoring any specific characterization of such a notion. We will consider that context may be simply described as a string of symbols  $w_E$  over an alphabet  $V_E$ .  $w_E$  stands for whatever information we consider is necessary to carry out the conversational interchange, and it will be shared by every agent in the system, this is, every participant in the talk exchange will take into account the state of  $w_E$  whenever he will be to perform an action.

Context in a conversation determines speakers behaviour and, at the same time, it is the target of every speaker's action. According to this essential idea, we consider, in

our model, both that  $w_E$  constrains actions agents can perform at any moment and that it is changed during the conversational act through speakers' actions. However not every aspect of context changes due to speakers' utterances. If non-linguistic aspects of context such as time and place, for example, change throughout conversation, they do it independently of dialogue. In order to account for such circumstance, we think that it is worth to endow our *environment* with a set of rules that may be responsible for any change in the environmental string not *directly* produced by agents' actions. The environmental set of rules can account not only for evolution of physical circumstances such as time and place, but also for interpretation and further processing of agents' utterances that will update the context.

## 5. Final Remarks

In this paper we have approached *context* from a formal language point of view with the aim of finding out a formal definition of context suitable to be included in a formal-language-theoretic model of dialogue. An introduction of the notion of context in two subfields of grammar systems: *colonies* and *eco-grammar systems* have been presented. Since both definitions are quite simple to fit the requirements of dialogue we have added some additional features to the definition of context in *conversational grammar systems*. The main characteristic of conversational grammar systems' definition of context is its dynamicity: it changes during computation, determines what rules can or cannot be applied and how agents in the system evolve. So, in conversational grammar systems, the context controls the overall behaviour of the system, just like in real life conversation.

We claim that conversational grammar systems are able to model dialogue with a high degree of flexibility, what means that they are able to accept new concepts and modify rules, protocols and settings during the computation. Evolution and action are involved in a consistent way in environment/contexts, while interaction of agents with the medium is constant. Moreover, conversational grammar systems present the following advantages to account for conversation: 1) generation process is highly *modularized* by a distributed system of contributing agents; 2) it is *contextualized*, linguistic agents re-define their capabilities according to context conditions given by mappings; 3) and *emergent*, it emerges from current competence of the collection of active agents.

## References

1. Csuhaaj-Varjú, E., Dassow, J., Kelemen, J., P\_un, Gh.: Grammar Systems: A Grammatical Approach to Distribution and Cooperation, Gordon and Breach, London (1994)
2. Csuhaaj-Varjú, E., Kelemen, J., Kelemenová, A., P\_un, Gh.: Eco-Grammar Systems: A Grammatical Framework for Life-Like Interactions, *Artificial Life*, 3/1 (1996) 1-28
3. Jiménez-López, M.D.: Dialogue Modeling with Formal Languages, in Spoto, F., Scollo, G. & Nijholt, A. (Eds.): Algebraic Methods in Language Processing, TWT 21, University of Twente (2003) 207-221



4. Kelemen, J., Kelemenová, A.: A Grammar-Theoretic Treatment of Multiagent Systems, *Cybernetics and Systems*, 23 (1992) 621-633

## Cognitive Modifiability on Brain Injury: a Case Study

Salete Bento<sup>1</sup> and Maria de Fatima Simoes<sup>2</sup>

<sup>1</sup> Special Education Teacher at Deaf Students Support Unity – School EB3  
Guarda – PORTUGAL. Rua Vila da Meda, nº 14 – 6300 Guarda  
Email: lete@netvisão.pt; Phone: (+351)271083498

<sup>2</sup> Associate Professor at the Department of Psychology and Education -  
University of Beira Interior. Rua do Sineiro, s/n – 6200 Covilhã – PORTUGAL  
Email: fatima.simoes@mail.telepac.pt; Phone: (+351)275319600; Fax:  
(+351)319601

**Abstract.** The assumption underlying our work states that an individual's personal and social growth in educational context depends, essentially, on a multidisciplinary approach. In doing so, our study is based on the Reuven Feuerstein's cognitive modifiability concept as well as in neuropsychological theory and research and we present a contextual intervention case study with a brain injury child who was integrated in a regular classroom with a special need indication. The participant was assessed with Portuguese experimental version of Luria Neuropsychological Battery – DNI, Portuguese version of Raven Progressive Colour Matrices and Ray's Complex Figure. A base-line (A-B-A) methodology was performed with results pointing out to a significant increment of cognitive function, which was assessed as highly impaired in the baseline phase.

**Keywords:** Education, Information Retrieval, Learning, Memory, Representation and Access, Neuroscience Perception, Psychology, Situated and Distributed Cognition.

### 1. Justification

The main purpose of reading is to access an interpretation from the perceptual Severe brain damage causes neuropsychological problems as we can observe based on evidence provided from several studies, which emphasise alterations on some cognitive and emotional variables that will lead to impairments. Among cognitive impairments we usually observe in individuals with frontal lobes damage, as is the case of our participant, the following: reduction of attention, mental fatigue, difficult speech production and comprehension, memory alterations, slower motor action, weak conceptual organization, and less cognitive flexibility; in what concerns to emotional difficulties, these are often referred as somatic complaints, weak self-esteem, depressive humour, anxiety, irritability, hyperactivity, and self-regulation problems [2, 8]. In fact, as Damasio points out, individuals with prefrontal damage are not able to make decisions about simple things even if brain damage occurs in late adolescence and according to MHO as a consequence of medical support advances,

more and more individuals can survive brain strokes. Following this, we are being faced with the need to design multiple rehabilitation programs in order to provide those individuals effective reintegration within society and family.

The assumption underlying our work states that an individual's personal and social growth in educational context depends, essentially, on a multidisciplinary approach, which drives our attention to Reuven Feurstein's cognitive modifiability concept and to neuropsychological theory and research to sustain our contextual intervention case study with a brain injury child who was integrated in a regular classroom. According to Reuven Feurstein's cognitive modifiability concept basically there are groups of functions, which are important to the learning and rehabilitation processes. In the first group we have Cognitive Functions, which concerns: (1) the input level of information such as sensorial memory, perception, attention; (2) the elaboration level with information manipulation efficacy; and (3) the output level which deals with communication efficacy. On the second group we have the Affective and Emotional Processes: (1) motivation; (2) self-perception; (3) self-esteem; and (4) cognitive style, for example; The third group concerns the Cognitive Map that allows us to analyse individual's profiles and set learning difficulties. We are dealing with individual mental analysis to process information: (1) content; (2) language modality; (3) mental operations; (4) complexity; (5) abstraction, and so on. The last group stated by Feurstein is the Mediated Learning Experience that permits structuring of the individual's experience.

In what concerns neuropsychological theory and research we based our assumption on Luria studies about brain damage diagnosis that are responsible for specific sensorial and behavioural problems. In fact, the understanding of complex psychological functions is based on different operations, and the main neuropsychological assessment objective is to know how impaired the individual's analysers are [5]. This type of assessment takes in account the auditory, optical, kinaesthetic and motor analysis and synthesis capacity as well as sensorimotor direct reactions, mnesic organization activity and the complex operations linked with language system. Tasks permit the repetitive and spontaneous talk, writing and reading, text understanding and problem solving assessment. Some of the difficulties that the individuals experiment concern his specific impairment level [1, 3, 4].

**Problem.** Our study problem wants to understand how a victim of a road crash with a brain stroke child that reveals sensorial, motor, perception, attention, memory, language and logical reasoning problems can be integrated in an educational rehabilitation program. Clinical physician reports a Glasgow level five with a right tetraparesya and ataxia, oculomanual coordination and action planning problems, as well as poor verbal, calculation and writing skills. This indication together with cognitive and clinical neuropsychological assessment results supported our methods and procedures to perform our intervention.

## 2. Method and Procedures

The participant was assessed with Portuguese experimental version of Luria Neuropsychological Battery – LNI [6], Portuguese version of Raven Progressive

Colour Matrices [7], and Ray's Complex Figure. A baseline case study (A-B-A) methodology was performed. In face of the weaknesses revealed by pre-test assessment results we created an educational rehabilitation mediated intervention program based on Feurstein's structural cognitive modifiability theory. Actually, the main impaired areas were highlighted in this program as follows: (1) For the motor areas, sessions were planned on global, fine motricity, body knowledge/scheme), lateral spatial organization spatial relations understanding; (2) In what concerns perceptive areas, tasks were performed on visual perception, sensorial memory and auditory discrimination; (3) verbal areas consisted on written and oral messages understanding, written and oral communication skills development; (4) for the cognitive areas the tasks highlighted numeric basic concepts, calculation and abstract reasoning; and (5) in what concerns social-affective areas the child maintained a high level of interaction with peers and was asked to communicate her own experience.

**Table 1.** Luria Neuropsychological tests results on pre-test/ post-test comparison

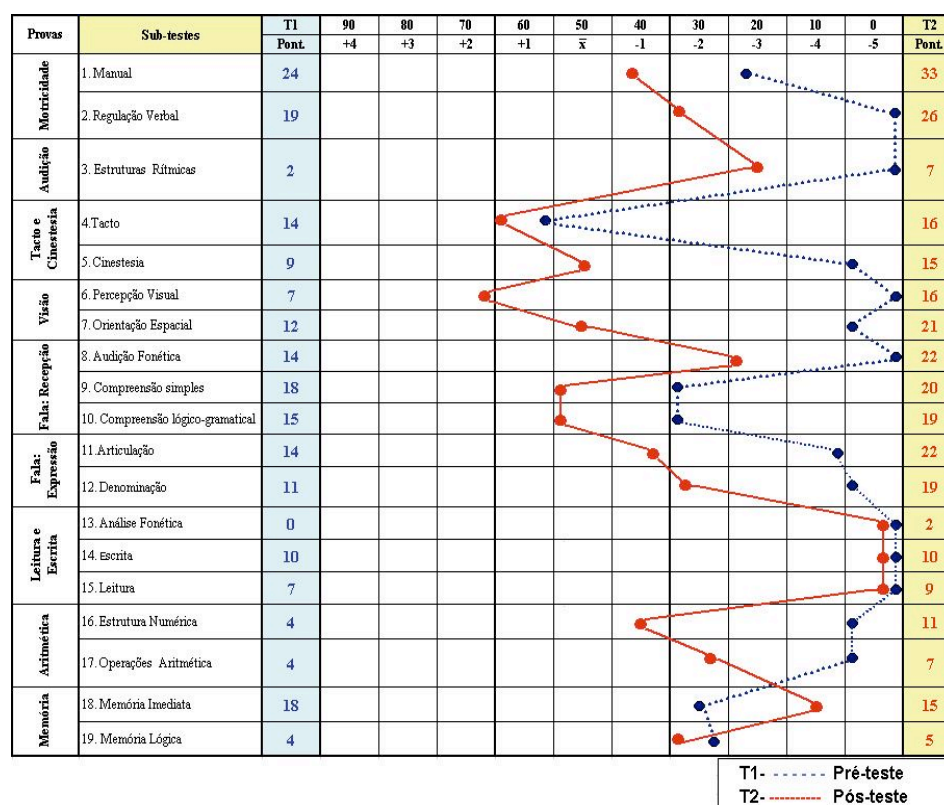

**Table 2.** Luria Neuropsychological Tests as appearing on table 1 (Portuguese Language)

Tests	Sub-tests	Tests	Sub-tests
Motricity	1. Hand (manual) 2. Verbal regulation	Expressive Speech	11. Articulation 12. Nomination
Audition	3. Rhythmic structures	Writing and Reading	13. Phonetic writing 14. Writing 15. Reading <input type="checkbox"/>
Tact / Kinaesthesia	4. Tact 5. Kinaesthesia		<input type="checkbox"/> <input type="checkbox"/>
Vision	6. Visual perception 7. Spatial Orientation	Arithmetic	16. Number structure 17. Arithmetic operations
Receptive Speech	8. Phonetic audition 9. Simple understanding 10. Logicogramatical understanding	Memory	18. Immediate memory 19. Logical memory <input type="checkbox"/>

### 3. Results

Our results point out to a significant increment of cognitive function, which was assessed as highly impaired in the baseline phase, in spite of having results from the other two tests (Raven Matrices and Ray Complex Figure, pre and post-test) for the purpose of this poster we will refer only Luria Neuropsychological results (for both pre and post-test). As we can see on table 1 (translation in table 2) the outcomes are very low in all the tests results in pre-test and, when we make a pre-test/post-test comparison most of the tests have improved and raised above means values for: (1) motricity sub-tests where we can observe a growth of 9 points after intervention for manual, and verbal regulation which meant a motor activity improvement by nearly the mean values for her age range with a good spatial and body organization; (2) audition sub-test scored a growth of around 3 points which implies an auditory perception, sound and rhythm discrimination improvement; (3) tact and kinaesthesia, respectively 1 point and 6 points more what accounts for movement control and stability; (4) vision sub-test values we can observe, for visual perception and spatial orientation, a showed a 9 points growth; (5) receptive speech sub-tests results demonstrate a growth of 8 (phonetic audition), 2 (simple understanding) and 4 (logico-grammatical understanding) points; (6) expressive speech sub-tests (articulation and nomination) 8 points growth between pre-test and post-test; (7) writing and lecture, with a 2 points growth for phonetic analysis and lecture and zero points for writing; (8) Arithmetic with 7 points growth for numeric structure and 3

points for arithmetic operations; and finally (9) in memory sub-tests we observed a 3 points decrease for immediate memory and 1 point growth for logical memory.

#### 4. Discussion

We can conclude that the participant has a greater capacity for discrimination and identification of the phonemes of a word. She also bettered her reading skills and simple text interpretation. In what writing skills are concerned no relevant modifications were observed, which demonstrates that the student still has difficulties in writing word and phrases. Despite this, we observed that the performance in this area improved when computer-based text processing was utilized. Error visualization on the computer screen allowed her an immediate correction. In fact she acquired a better numeric knowledge and a greater capacity to apply them. She also demonstrated better capacity to solve arithmetic operations, and use them comprehensively. One of the reasons pointed for the decrease is that this test was used when A. was still in holidays, and her physical and mental fatigue was visible.

#### References

1. Bradley, T.B. Remediation of cognitive deficits: A critical appraisal of the Feuerstein model. *Journal of Mental Deficiency Research*. 27 (1983) 79-92
2. Damasion, A. *O Erro De Descartes*. Lisboa Publicações Europa América (1994)
3. Feuerstein, R. Les differences de fonctionnement cognitif dans des groupes socio-ethniques différents. Leur nature, leur étiologie et les pronostics de modifiabilité. Thèse pour le Doctorat de 3 ème cycle, Sorbonne, Paris (1970)
4. Feuerstein, R. Mediated Learning Experience: A theoretical basis for cognitive modifiability during adolescence. In: Mittner, P. (eds): *Research to Practice in Mental Retardation and Training Vol. 2*. MD:University Park Press, Baltimore (1977)
5. Luria, R. La neuropsicologia y el estudio de las funciones corticales superiores. In: Christensen A.L. (ed): *El diagnostico neuropsicológico de Luria*. Aprendizage Visor, Madrid (1987)
6. Manga, D., Ramos, F. Neuropsicologia de la edad escolar- Aplicaciones de la teoria de A.R. Luria a niños através de la bateria LURIA-DNI, Visor Distb., Madrid (1991)
7. Simões, M. R. Teste das Matrizes Progressivas Coloridas de Raven. In Almeida, L.S., Gonçalves, M.M. (eds): *Provas Psicológicas em Portugal*. APPORT, Braga. (1995)
8. Simões, M. R. Avaliação Neuropsicológica: Esboço de um Programa. *Psychologica*. 17 (1997) 137-179

## Effects of context, familiarity and aging on the interpretation of ambiguous sentences

Aurélie DOMMES<sup>1</sup> and Marie Louise LE ROUZO<sup>1</sup>

<sup>1</sup> EA 1588 «Processus cognitifs et conduites interactives», Équipe de psychologie cognitive  
Université Paris X, 200, avenue de la République, 92001 Nanterre cedex, France.  
adommes@u-paris10.fr ; lerouzo@u-paris10.fr

**Abstract.** Interpretation and understanding of lexical ambiguities by young and elderly individuals were examined through a technique of contextual priming. Homographic nouns were inserted in ambiguous target sentences and were preceded by sentential contexts (neutral or orienting towards one of the meanings of the homograph). The understanding of ambiguous target sentences was measured with a technique of choice of drawings representing the two different meanings of the homograph. The results revealed a significant contextual priming effect, which was larger in the older population. Furthermore, in the neutral contextual condition, we noticed a robust familiarity effect in each population.

### 1. Introduction

The main purpose of reading is to access an interpretation from the perceptual analysis of the graphic information, a word for instance, which is associated to the corresponding representation stored in semantic memory. But sometimes, the same letter patterns are associated with more than one meaning, with for instance in English the noun *bug*, which refers at the same time to an insect and to a computer fault. This ambiguity is called homographic because the two words share the same orthography. Ambiguous words have been used in a wide variety of studies including different problems of research in cognitive science and in psycholinguistics. One of the major scientists' interests has been to understand the resolution of lexical ambiguity, in terms of time course of activation and interaction with context.

One of the first researches using homograph and dealing with context effect on semantic access was lead by Swinney, in 1979 [1], who attested that semantic-associative context didn't restrict the first stage of lexical access. After an automatic initial access, biasing context exerts an effect consisting in the activation of the meaning involved in this prior context. This finding has been repeatedly demonstrated across a large range of prior contexts [2]. Even in the absence of prior context, it has been shown that all the meanings associated with the ambiguous word are momentarily activated and made available for further processing. Furthermore, the frequency of the different meanings of the homograph has been demonstrated to determine their order of availability [3].

These context and frequency effects have also been investigated in interaction with the effects of “normal” aging. Several studies have demonstrated an aging influence on the utilization of context and, more precisely, on semantic priming. Amongst the first were Cohen and Faulkner in 1983 [4] whose results attested that semantic information derived from context could be utilized more effectively by elder people to facilitate the recognition of words. This result makes good sense when viewed as a compensatory device, increased utilization of contextual information being an adaptation to offset deterioration of sensory processes in old age. Moreover, several studies reported a greater effect of semantic priming in elder people compared to young subjects [5].

Beside comprehension as cognitive activities of information processing, another meaning of this notion subsists in terms of the result of these processes, i.e. the construction of an interpretation and therefore of a situation model. First, this interpretation could be influenced by a prior linguistic context introducing a particular situation. But, other factors could interact with the interpretation of a word like the extent of inferential activities, which are themselves linked to the semantic memory, this last being correlated with individual’s episodic memory... If between different individuals distinct features of a word are activated, then interpretation of this item would differ by dissimilar activation in semantic and episodic memory. Some divergences of meaning attributions could for instance take place between young and older individuals who have stored different features about words through out their own life experiences. Therefore, aging may both differentiate the content and the organization of the mental lexicon as well as the attributions of meaning to words because of increased lexical knowledge [6].

In the next section, we briefly present a study dealing with the interpretations of homographs by two generations confronted to a contextual priming paradigm. We didn’t use a chronometric method because our interest wasn’t in the time course of semantic activation but mostly in the contents of interpretations constructed by young and elderly subjects. Comprehension of homographs was so evaluated by a technique of choice of drawings representing the different meanings of the ambiguous items.

## **2. Contextual priming task**

### **2.1. Preliminary study**

Our preliminary study consisted of a judgment of familiarity task by two generations about the meanings of 40 French homographs. 20 young subjects (18-24 years old,  $M=20$ ), and 20 old participants (63-77 years old,  $M=71$ ) had to evaluate their personal utilization of the two meanings of each homograph through a questionnaire proposing three possible answers. Subjects could first specify that they didn’t know one or the two meanings of the pairs. Secondly, they could estimate that they used one of the two senses more than the other (a type of estimation called “hierarchical familiarity”). Finally, subjects could declare that they used equally the two meanings (called “equiprobable familiarity”).



Statistical analyses of these three choices revealed differences with age. In particular, significant differences of familiarity estimation types (hierarchical versus equiprobable) was observed between young and older subjects ( $F(2,76)=16,8$ ,  $p<.000$ ). Therefore, we composed the material of our contextual priming task with 18 pairs of homographs: 9 pairs for which the estimations disagreed between generations and 9 pairs for which the two generations agreed.

## 2.2. Methodology

For each homographic pair, an ambiguous target sentence was constructed which was likely to receive interpretations corresponding to the two meanings of the homograph. For each target ambiguous sentence, three contextual conditions were set up. Context refers here to a linguistic environment, a clausal context. A first control condition presented a "neutral" sentence, i.e. which did not bring any information for the interpretation of the homograph inserted in the target sentence. Two contextual priming conditions introduced sentences comprising a word or an expression synonymous with one or the other meaning of the homograph, thus orienting the semantic interpretation of the ambiguous target sentence. The subject had to read aloud the sentences and to choose between two drawings proposed to him. The drawings corresponded to the two possible meanings of the homograph and the choice of drawing measured the interpretation selected by the subject.

60 participants who did not participate in the preliminary study were recruited for this priming task. 30 young adults (17-25 years old,  $M=20$ ;  $SD=1,8$ ) were students at University of Paris X, in their early years of Social Sciences Course and had followed an average of 14 years of education ( $SD=1,2$ ). 30 autonomous old participants (62-79 years old,  $M=70$ ;  $SD=5,4$ ) were recruited in a course for Senior at the University of Paris X and had followed an average of 14,3 years of education ( $SD=2,5$ ).

## 2.3. Results

Results first showed that pairs for which there was an agreement between generations led to identical average choices of drawings. On the contrary, pairs for which the generations disagreed led to distinct average choices.

**Contextual priming effect.** When participants first read a contextual priming sentence biasing towards a particular meaning, they tend significantly to choose the drawing representing this meaning ( $F(1,58)=2829,4$ ;  $p=.000$ ). Thus, a significant contextual priming effect has been obtained. In terms of process, this effect could be interpreted as an automatic activation and a spread of activation of the meaning constrained by the prime to the semantic representations of related words. In terms of result of processes, the contextual prime context may have facilitated the construction of a situation model integrating this meaning.

**Aging effect.** Statistical analysis have revealed that this contextual priming effect was higher in the older population ( $F(1,58)=43,6$ ;  $p=,000$ ). The average percentage of choice of drawings representing the meaning biased by the context was higher for older than for younger adults. Among other possible assumptions, this age effect can be interpreted along the inhibition deficit hypothesis [7](Hasher and Zacks, 1988) which proposes that aging weakens inhibitory processes associated with task-irrelevant information. Thus, the situation model built by elder people after reading the prime sentence could not be as easily removed as by younger people.

**Familiarity effect.** The familiarity effect on the answers of selection was studied in the control condition introducing a neutral sentence. Since the generations disagreed about the familiarity of 9 homographic pairs, we analyzed this effect according to the type of familiarity (hierarchical versus equiprobable) in each population. Statistical analysis revealed a significant familiarity effect in a neutral context, i.e. different average choices per subject according the type of homograph familiarity ( $F(1,58)=6,1$ ;  $p=,02$ ). In each population, homographic pairs estimated as hierarchical led to a significant average choice of drawings representing the most familiar meaning ( $F(1,58)=27,8$ ,  $p=,000$ ). On the contrary, homographic pairs evaluated as equiprobable led to average choices of drawings divided between the two meanings of the homograph. These familiarity effects were similar in the two populations (non significant age effect  $F(1,58)=,19$ ;  $p=,67$ ).

### 3. Conclusion

We conclude that familiarity of homographic pairs but also clausal context of their presentation can influence their interpretation (as expressed here in terms of choices of drawing) and, therefore, their semantic and lexical accesses. These effects can vary in different ways according to the age of the population.

### References

1. Swinney, D., A.: Lexical access during sentence comprehension: (Re) Consideration of context effects. *Journal of Verbal Learning and Verbal Behavior*. 18 (1979) 645-659
2. Swinney, D., Love, T.: Context effects on lexical processing during auditory sentence comprehension in E; Witruck, A. D. Friederici & T. Lachman (Eds.), *Basic Functions of Language, Reading and Reading Disability*, Kluwer Academic Publisher. (2002) 25-40
3. Duffy, S. A., Morris, R. K., Rayner, K.: Lexical ambiguity and fixation times in reading. *Journal of Memory & Language*. 27 (1988) 429-446
4. Cohen, G., Faulkner, D.: Word recognition: Age differences in contextual facilitation effects. *British Journal of Psychology*. 74 (1983) 239-251
5. Laver, G., D., Burke, D., M.: Why do semantic priming effects increase in old age? A Meta – analysis. *Psychology and Aging*. 8 (1993) 34-43
6. Verhaeghen, P.: Aging and vocabulary scores: a meta-analysis. *Psychology and Aging*. 18 (2003) 332-339
7. Hasher, L., Zacks, R., T., Working memory, comprehension, and aging: A review and a new view, in G. H. Bower (Ed.): *The Psychology of Learning and Motivation* 22, NY: Academic Press (1988) 193-225

## **Emotional induction and valence of macrostructural information: the effect on the temporal course of the mental representation**

Angelique Ducreux-Fournier<sup>1</sup>, Isabelle Tapiero<sup>1</sup>

<sup>1</sup> Université Lumière Lyon2 - Institut de Psychologie  
Laboratoire d'Etude des Mécanismes Cognitifs  
Laboratoire Dynamique du Langage  
U.M.R. 5596, CNRS  
5, Avenue Pierre Mendès - France  
69676 BRON cedex (France)  
angelique.ducreux@univ-lyon2.fr  
isabelle.tapiero@univ-lyon2.fr

**Abstract.** The goal of this study was to investigate the effect of emotional macrostructural information (positive and negative) on readers' mental representation. Subjects read a « natural text » on boat races composed with positive or negative macrostructural information, each macrostructural text also included the same neutral information. To evaluate the temporal course of the representation the reading of the text was divided into three parts, each one followed by a recognition task. Prior to the reading, participants were induced in a specific state with positive, negative or neutral pictures. We expected a facilitating effect on the readers' mental representation for macrostructural information that was congruent with the emotional state induced. Moreover, we also predicted that this effect would be modulated as a function of the temporal course of the representation. Our main results are in agreement with our hypotheses and evidenced for the importance of emotional information in readers' mental representation.

Text comprehension requires the construction of two main levels of representation. The semantic level (the text base) and the situation model. This latter level results in the integration of readers' characteristics and textual information and needs to be coherent. Several authors defined the nature of the situation model as multidimensional. For instance, Zwaan, Langston and Graesser [7] proposed the event indexing model according to which situation models include at least five dimensions: temporality, spatiality, causality, intentionality and protagonist. Within this model, readers are assumed to index each event described in a story on each of these five dimensions. Recent studies have also underlined the crucial role of emotion in readers' mental representation and have considered emotions as being part of the readers' mental representation [4]. In agreement with these findings, we assume that examining cognitive processes and mechanisms implied in text comprehension requires identifying whether, how and when readers' emotions intervene in this cognitive activity. Two main ways for

studying the relation between emotions and text comprehension have emerged from literature. First, the situation where readers' emotions are about the fictional world of the story have been widely considered. Indeed, some of the emotions experienced by the readers are strongly related to those experienced by the main protagonist of the story. Overall, the set of data collected from several experiments indicated that 1) readers represent characters' emotional state, 2) readers activate knowledge about emotions during narratives comprehension and this activation relies on an automatic component of the reading process [3], 3) updating the emotion of a protagonist is a backward process [2]. Finally, the specificity of emotions have been discussed and some authors argued for a more global representation of emotions compared to a specific representation. The second situation that has been considered is when readers are induced in a specific emotional state before processing the text. In that case, the induced emotion is supposed to affect text processing. The study presented here will focus on this second aspect. Moreover, little is known about how emotion can be derived from textual characteristics, or more specifically, how textual components such as emotional words, valence, or intensity of emotional information may affect the comprehension process. Thus, another goal of this study will be to focus on these textual emotional characteristics and our intention is to highlight the importance of taking into account the valence of emotional information, alone and in relation with the levels of importance of textual information. This relation should indeed have a great influence on readers' performance. The interaction between emotional intensity and levels of importance of information on retrieval (i.e., recall) has been first studied by Martins in 1984 [6]. He showed that textual information with high emotional intensity was better recalled than low intense information. Also, Legros (1989) [5] demonstrated that highly connoted information promoted the recall of a text. More precisely, he showed that a text was better recalled when secondary information was highly connoted compared to weakly connoted. Thus, although primary information was always recalled, the recall of secondary information was function of its emotional intensity. However, further investigations have to be done, to measure the effect of the task demands alone and in relation with the temporal course of the representation. Indeed, performing a task during or at the end of the reading process, should influence readers performance. Thus, our study was aimed at investigating in more depth the relation between macrostructural information and emotion. More specifically, we compared the effect of an emotional induction (with negative, positive and neutral pictures) on macrostructural information, that was either negative or positive. First, and consistent with the mood-congruity effect showed by Bower, Guilligan and Monteiro [1], we predicted an emotional congruency effect between the subjects' emotional state and the valence of the macrostructural information (i.e., facilitation). Second, we made the assumption that to deepen our understanding of how readers process textual information (in our study, connoted information), it is necessary to account for the temporal course of the representation. Ninety students from the University of Lyon 2 (France), all volunteers, read a "natural text" dealing with a current event ("boat races"). Our material consisted of two versions of the text. The first version had positive macrostructural information whereas the second version contained

negative macrostructural information (neutral information were also present in both versions). The content of the text was extracted and revised from newspaper articles and three factors were controlled. First, all the text sentences were emotionally connoted but we kept the same number of positive (18) and negative (18) sentences in the two versions. Second, each sentence had approximately the same number of syllables. Finally, we controlled the relative importance of each sentences. For that purpose, we performed a preliminary experiment in which subjects (who did not participate in the main experiment) had to judge the relative importance of textual information using a three-points scale (high, medium and low importance). The results of this preliminary experiment allowed us to extract from the text the most important positive, negative and neutral information. We designed the proper experiment using Psyscope software and the procedure was as follows. After reading one version of the text, subjects had to perform a recognition task on macrostructural information with five different types of statements to be recognized (verbatim, surface variation, paraphrase, inference and distant distractor). The experimental text were presented sentence by sentence and reading times were automatically recorded. Recognition times and proportion of correct responses were also collected. Prior to the reading, subjects were induced with pictures and depending on their group assignment, they had to study 10 pictures either positive, negative or neutral. These pictures were displayed on a computer screen. After studying the 10 pictures, participants had to read the first part of the text (with the positive or negative macrostructure) and had to perform the recognition task (first part). This procedure was identical for the two other parts of the text (reading and recognition task). The interruption of the reading allowed us to study the temporal course of the representation. Thus, six groups of fifteen subjects read the experimental text, but differed in the nature of pictures they visualized (positive, negative or neutral) and in the valence of macrostructural information they read in the text (positive and negative). Although we performed analyses of variance (ANOVAs) on the reading times, and on the correct answers and response times (recognition task), we will only present here the results to the recognition task. We carried out two separated analyses, one for the subjects who were assigned to the positive macrostructural text and the other one for those assigned to the negative macrostructural text. Each subject was also assigned to only one type of induction (neutral, negative or positive) and was interrupted during reading twice to perform the recognition task.

**Results.** Proportion of correct responses and recognition times

*The analyses of the text with a positive macrostructure* indicated an effect of the temporal course of the representation:  $F(2, 84) = 24,098 \square p < .01$ . The recognition times were longer for positive macrostructural statements in Part 1 ( $M = 174, 029$  ms) than in parts 2 ( $M = 147,581$  ms) and 3 ( $M = 144, 568$  ms). Data on the correct responses showed that statements in Parts 1 ( $M = . 796$ ) and 3 ( $M = .827$ ) were better recognized than those in Part 2 ( $M = . 733$ ) ( $F(2, 84) = 7,780 \square p < .01$ ), the difference between parts 1 and 3 being no significant. We also observed a Part by Statements to be recognized interaction for the recognition times  $F(8, 336) = 27,075 \square p < .01$ . The recognition times

were longer at the beginning of the reading for Surface Variation statements: and for Paraphrase statements (in Part 1). It was longer for Inference at the middle of the reading (Part 2) whereas the reverse pattern was observed for Distant Variation (more rapidly recognized at the middle of the reading, Part 2). No difference occurs between the three parts for Verbatim statements. The Surface Variation, Paraphrase and Inference statements led to the lowest proportion of correct recognition when the task occurred in Part 2:  $F(8, 336) = 4,474$   $p < .01$ . There was no significant difference for Verbatim and Distant Variation between the three parts.

*The analyses of the text with a negative macrostructure* showed an effect of the emotional induction (a tendency) only for the proportion of correct responses:  $F(2, 42) = 2, 922$   $p < .06$ ). Subjects induced with negative pictures tended to have a lower proportion of correct responses ( $M = .836$ ) than subjects induced with positive ( $M = .862$ ) or neutral pictures ( $M = .889$ ). Moreover, although no difference was observed between the three parts for the recognition times, our data indicated that Part 2 statements were better recognized ( $M = .893$ ) than Parts 1 ( $M = .851$ ). and 3 ( $M = .842$ )  $F(2, 84) = 2,924$   $p = .05$ , these two latter being no significantly different. Finally, we observed a Part by Statements to be recognized interaction for the recognition times  $F(8, 336) = 2,089$   $p = .03$ . Verbatim statements were more rapidly recognized at the end of the reading (Part 3). Distant Variation statements were more rapidly recognized at the middle of the reading (Part 2). No difference occurred for Inference, Paraphrase and Surface Variation statements between the three parts. The proportion of correct answers indicated that Surface Variation and Paraphrase statements led to the lowest performances at the beginning and the end of the reading (Parts 1 & 3)  $F(8, 336) = 5,571$   $p < .01$ . No difference occurred for Inference, Verbatim and Distant Variation statements between the three parts.

**Conclusion and discussion.** Thus, according to our first assumption (H1), the congruency effect between the state induced and the valence of the macrostructure occurred only when the information was negative. Second, the temporal course of the representation is affected by the valence of the macrostructural information (H2). Indeed, for a positive macrostructure, the performance is the lowest in Part 2, whereas for a negative macrostructure, the beginning and the end of the text are more affected. Thus, it seems that comprehension is affected differentially by the connoted information, and this effect is function of when the tasks occurs. Finally, performance to the statements to be recognized varies as a function of the valence of the macrostructure. For a positive macrostructure, and for the proportion of correct responses, the surface statements (surface variation and paraphrase) seemed to be the most affected during Part 2. For the negative macrostructure, these statements led to the lowest performances in Parts 1 and 3. However, for the response times, different pattern of responses are observed for the inferences when the text has a positive macrostructure and for the Verbatim statements when the text is negative. This last result shows evidence for the fact that the semantic level and the situation model are affected and evolves in a separate way according to the connotation of the macrostructure and the temporal course of the representation. We are

currently carried out several studies to deepen our knowledge on the effect of emotional information on these two levels. Thus, this study permits to extend the research already done on “natural text” and emphasizes the relevance of the connoted and important information on the construction of the reader’s mental representation.

## References

1. Bower, G. H., Gilligan, S. G., & Monteiro, K.. Selectivity of learning caused by affective states. *Journal of Experimental Psychology : General* (1981) 110 451-473
- 2 de Vega, M., Diaz, J. M., & Leon, I. To know or not to know□ comprehending protagonists’ beliefs ad their emotional consequences. *Discourse Processes* (1997) 23 169-192
3. Gernsbacher, M. A., Hallada, B. M. and Robertson, R. R. W. How automatically do readers infer fictional character’s emotional States□ *Scientific Studies of Reading* (1992) 2(3) 271-300
4. Gygax, P., Garnham, A. & Oakhill, J. Emotion in text comprehension: Do readers infer specific emotions. *Cognition and Emotion* (2003) 17(3) 413-428
5. Legros, D. Etude de l’effet d’un procédé de dramatisation sur la mémorisation d’un récit□ Implications pour l’élaboration de matériels de diagnostic cognitif. *Questions de logopédie* (1989) 21 93-103
6. Martins, D. Influence de l’importance, de l’intensité affective des paragraphes et de l’émotion ressentie lors de leur lecture dans la compréhension de textes. [ effect of the importance, of the affective intensity of passages and of the emotion during reading in comprehension] *Bulletin of Cognitive Psychology* (1984) 4 (5) 495-510
- 7 Zwaan, R. A., Langston, M. C., & Graesser, A. C. The construction of situation models in narrative comprehension□ an event-indexing model. *Psychological. Science* (1995) 6 292-297

# Ethnographic Methods to Study Context: An Illustration<sup>1</sup>

Michael Evans,<sup>1</sup> David Leake,<sup>2</sup> Donald F. McMullen,<sup>1</sup> and Steven Bogaerts<sup>2</sup>

<sup>1</sup> Pervasive Technologies Labs, Indiana University  
501 N. Morton, Suite 224, Bloomington, IN 47404 USA  
{micaevan, mcmullen}@indiana.edu

<sup>2</sup> Computer Science Department, Indiana University,  
Lindley Hall 215 150 S. Woodlawn Avenue, Bloomington, IN 47405 USA  
{leake, sbogaert}@cs.indiana.edu

**Abstract.** The ability to reflect contextual factors is crucial to the success of computerized support systems. Consequently, identifying how context affects the supported processes is a prerequisite for developing such systems, and ethnographic studies can play an important role in shaping system design. We are developing methods for supporting distributed collaborative troubleshooting by aiding the transmission of useful contextual information between participants, based on a study of contextual influences in the existing troubleshooting process. This extended abstract summarizes methods, motivations and observations from our socio-technical analysis, based on a nine-month naturalistic study of real-world remote diagnosis of electronic devices by ad hoc teams. It illustrates how ethnographic tools can be brought to bear for such analysis, as well as illustrating the richness of the real-world contexts that such an analysis can reveal.

## 1 Introduction

Troubleshooting assistance must often be conducted remotely, as non-experts call upon “help desks” of geographically-separated experts to assist their diagnosis process. These service calls prompt the formation of ad hoc teams, whose members begin their interaction with little knowledge of each other’s situations. However, evidence shows that the task process can be strongly influenced by contextual factors (Albers 1999; Amann & Quirchmayr 2003). Consequently, enabling effective troubleshooting requires making team members’ contexts explicit, in order for participants to make appropriate decisions. This in turn requires understanding what constitutes the relevant context for the troubleshooting task. This extended abstract introduces a study analyzing the troubleshooting task and highlights some of the resulting observations.

The context in which a problem is placed can have a significant effect on a human problem-solver’s decision process (Albers 1999), making it important to provide decision-makers with contextual information. Ahn, et al. (2000) observe that ad hoc

---

<sup>1</sup> This work is supported in part by the U.S. Department of the Navy, NSWC Crane Division, under contracts N00164-04-C-6514 and N00164-04-C-6515.



virtual collaborative problem-solving presents special impediments to building up the needed knowledge, such as changing sets of participants, resulting in loss of knowledge and skills, limitations on the amount of context it is practical to convey, and the casual loss of information when virtual collaborations are intensive and non-routine. Our project aims to develop support systems to alleviate these difficulties. Our primary domain is the support of collaborative troubleshooting of complex shipboard electronic systems. In the current U.S. Navy troubleshooting process, non-expert shipboard sailors are paired with shore-based experts to assist their troubleshooting. Communication options are limited and often asynchronous, often relying on e-mail, with minimal support for information transmission. We aimed to understand the types of contextual knowledge needed for effective task performance, based on an ethnographic study (Evans 2004).

## 2 Design of the Study

Ethnographic studies can be conducted with a number of strategies, including controlled and quasi-experiments, surveys, histories, archival analyses, and case studies. According to Yin (Yin 1994, pp. 1–9), the unique advantages of each depends on three conditions: (a) the form of the research questions(s); (b) the control over actual behavioral events; and (c) the focus on contemporary as opposed to historical phenomena. In Yin's assessment, asking 'how' and 'why' questions about a contemporary phenomenon where control is minimal necessitates a case study design. This design requires a commitment to ongoing interpretation of the data from multiple sources, a concern for validation of assertions, an organization of the inquiry around initially etic (meaningful to the researcher) and later emic (meaningful to the participants) issues, the use of narrative to establish context and reveal pertinent details, and an aim toward promoting naturalistic generalization on the part of readers of the study. The commitment to interpretation and validation are integral to the process of the case study research, while organization, narrative style, and naturalistic generalization emphasize the importance of the product.

*Data Collection Sources of Evidence.* Interviews for this study were semi-structured with the intent of asking key respondents for the facts of a matter as well as for respondents' opinions about events (Yin, 1994, p.84). More specifically, attention was focused on current work and its context. Open-ended, or more conversational, questions were asked of respondents, particularly sailors, technicians, and engineers who were on the job and engaged in actual troubleshooting tasks. Over 50 hours of interviews were recorded digitally and then transcribed. Observations of troubleshooting sessions were conducted at naval installations, labs, and training facilities, focusing on the influence of contextual features on the generation, sharing, and use of knowledge and expertise. Observations were conducted on a weekly basis for six months, from December 2002 to August 2003. Documents related to the case were collected and analyzed to corroborate and augment evidence from the other sources (Yin, 1994, p.81). Sources included maintenance and repair manuals, error reports, meeting minutes, web pages, newspaper reports, training materials, departmental communications, job descriptions, procedural guidelines,

proposals, progress reports, published case studies of similar projects, and reports generated by the design team. Finally, a research journal was kept to capture reflections on the case process, methodological choices, and design choices, and to help to maintain a distinction between the role of the designer and the role of the researcher. Contents included notes from observations, conversations with case informants, reflections about potentially emerging themes and methodological directions.

*Case Study and Ethnographic Techniques.* The study applied a number of ethnographic techniques to assess observations. One of these, pattern-matching, derives empirically-based patterns from the descriptive case to compare with predicted patterns from theoretical propositions (Yin 1994), adding support for the results' internal validity when empirical and predicted patterns coincide. Patterns from this study include the contextual features that enabled or inhibited knowledge sharing and problem-solving. Another ethnographic technique applied, progressive focusing, guides attention by the unfolding of critical aspects of the case (Hammersley & Atkinson 1983). In our study focus shifted gradually from sailors to a broader unit including technicians and engineers.

### 3 Contextual Factors Shaping Remote Troubleshooting

In all remote troubleshooting, some explicit problem-solving information must be transmitted between participants. In our domain, this consists of (1) The specification of the device being diagnosed, (2) The symptoms of the fault to diagnose, (3) Official diagnostic resources, and (4) Reports on the actions (such as voltage tests, etc.) carried out by the sailor. However, our analysis identified a rich range of additional contextual factors:

1. **Characteristics of the Participants:** In our data, troubleshooters often infer information from the characteristics of the participants, including inferences based on likely access to knowledge updates (e.g., “these young third class guys would never know there was an advisory out’), and their training/experience.
2. **The Problem Setting:** Characteristics of the problem setting, both historical and current, play an important role in the expert’s situation assessment on the current problem, suggestion of possible diagnoses, and selection of diagnostic actions. This context includes factors such as the ship—different ships may configure the same equipment differently, environmental effects, and sailor pre-contact actions.
3. **Institutional, Social, and Cultural Factors:** What information is available to the expert and how to assess that information are shaped by local standards on when to seek help and how to proceed. For example, sailors may be reluctant to reveal that they have deviated from practice or to convey information that they expect to reflect badly on their ship.
4. **Capability Constraints:** The overall course of troubleshooting is also shaped by external limitations in capabilities such as availability of test equipment, schedule

constraints, and high-level goals.

Our full taxonomy of contextual factors, based on the study, provides a target set of types of contextual information to be provided by context transmission systems for remote troubleshooting. These are reported in (Leake *et al.* 2005a).

#### **4 Conclusion**

When relevant contextual information is difficult for participants to obtain, systems that help provide needed context may have important benefits—if user needs can be identified. We have sketched a case study illustrating how ethnographic methods can be applied to study the types of contextual factors shaping performance in remote collaborative troubleshooting, identifying opportunities for contextual support to aid remote distributed troubleshooting. Based on this study, we are developing a system for knowledge capture, transfer, and sharing as it provides a vehicle for communication between sailors and technicians (Leake *et al.* 2005b). The system captures and conveys information about previous diagnoses, integrating methods inspired by case-based reasoning into the task process to capture and connect contextual information.

## References

- Ahn, H. J.; Hong, J. L.; Kyeheun, C.; and Sung, J. P. 2000. Utilizing knowledge context in virtual collaborative work. *Decision Support Systems* 39:563–582.
- Albers, M. 1999. Information design considerations for improving situation awareness in complex problem-solving. In *Proceedings of the 17th Annual International Conference on Computer Documentation*, 154–158. New York: ACM Press.
- Amann, P., and Quirchmayr, G. 2003. Foundation of a framework to support knowledge management in the field of context-aware and pervasive computing. In *Proc. Australasian Info. Security Wksp. Conf. on ACSW Frontiers 2003*, vol. 21, 119–131.
- Evans, M. 2004. *Knowledge and Work in Context: A Case of Distributed Troubleshooting Across Ship and Shore*. Ph.D. Dissertation, Indiana University.
- Hammersley, M., and Atkinson, P. 1983. *Ethnography, principles in practice*. London: Tavistock.
- Leake, D.; Bogaerts, S.; Evans, M.; and McMullen, D. 2005a. Contextual support for remote cooperative troubleshooting: Lessons from a naturalistic study. In Soubie, J.-L., and Zarat'e, P., eds., *Proceedings of the International Workshop on Cooperative Systems and Context*. CEUR. In press.
- Leake, D.; Bogaerts, S.; Evans, M.; McMullen, D.; Oder, M.; and Valerio, A. 2005b. Using cases to support divergent roles in distributed collaboration. In *Proceedings of FLAIRS-2005*. AAAI Press.
- Yin, R. K. 1994. *Case study research: design and methods*. Thousand Oaks, CA: Sage.

## Applied Crossed Confrontation for Context Evolution

Philippe FAUQUET, Dr.  
Human Factors Consultant  
Chinon Nuclear Power Plant  
BP 80 – 37420 Avoine  
France  
Email ☐ [Philippe.Fauquet@edf.fr](mailto:Philippe.Fauquet@edf.fr)  
phone : +33 (0) 2 47 98 92 63  
fax : +33 (0) 2 47 98 92 75

**Abstract.** Safety management of French nuclear power plants implies the treatment of safety events in order to understand and reduce their occurrence. In this aim, a framework (which is described briefly here), to analyze parameters which led to the event, have been implemented and improved, but encounters difficulties.

Based on the conceptual approach proposed by one of the perspectives of the French psychology, the clinic of work activity, the paper develops the theoretical concepts which are necessary to achieve the goals of the event analysis, and points out one of the methodological means adopted : the cross confrontation in a co-analysis with actors of the event. It is shown how a psychological function appears upon each worker's activities through a transpersonal dimension which contributes to the development of the subjects, the group, and of the context.

### 1. Introduction

EDF Nuclear power plants are submitted to strict formalised rules. Respect of these rules, and especially functional parameters or configurations of materials, allows to guarantee, that the process and organization will manage to control the situation and the installations in case of technical problem. The aim is to protect Human beings and their environment from radioactive contamination by the containment of nuclear coil and derived products.

A deviation with regards to referential (a valve in a state not in accordance with requirements for example) can be treated as a significant safety event. Such a deviation must then be analysed and explained to National Safety Authority. It is clear that for EDF industrial firm, such deviations are not acceptable as they involve and discredit dispositions adopted to guarantee nuclear safety on power plants.

Consequently, all means are implemented to avoid their occurrence (see [1], [2] ,[3]). Nevertheless, deviations remain inevitable. A framework to analyze parameters which led to the event have been implemented and improved for years with the aim of transforming the configuration of occurrence at two levels. We shall examine how one of them can lose in effectiveness and we shall discuss why it is important to keep it on or find it back, discussion based on the conceptual approach proposed by one of the perspectives of the French psychology : the clinic of work activity. Then, we shall present the methodology built in the specific nuclear industry, at the nuclear power

plant of Chinon, and we shall consider how likely this methodology can help the work activity context to evolve.

## **2. Events Analysis and Lost in Effectiveness**

The treatment of the safety events falls under the logic of a framework which is declined, ideally, in several phases :

- a- the collection of the facts near the actors by the writer of the final report, in order to trace the chronology of the event as soon as possible, and to work out a first analysis,
- b- the meeting of the actors of the event in collective discussion with the Human Factors Consultant (HFC), to work out the tree of the causes, to identify the failing states and inappropriate actions, and to put under discussion the elements of comprehension,
- c- the outline, at the time of this meeting, of the corrective actions,
- d- the drafting of the report and its validation by the actors,
- e- the validation of the report by a collective authority specific to the trade (see its functional description and analysis in [3]),
- f- the validation of the report by the Management of the power plant,
- g- the diffusion of the teaching of the analysis report in the teams.

Items b and c are fundamental because they contribute to put under discussion, within the group of workers, the practices of work which possibly led to the event. This setting under discussion, which is articulated in particular around the elements of comprehension of inappropriate actions, makes it possible to the group of workers to make its individual and collective practices evolve, to decide this evolution together, in order to apprehend a similar situation in a different way, and thus, reduce the probability of renewal of the event. Thus, the context of the event is thought and discussed as if it were necessary to replay it differently in order to apprehend next similar situation differently.

In the same way, items e and g make it possible to share on these changes of practices with the peers, and other actors potentially concerned with these changes.

The fundamental difference between, on the one hand items b and c, and, on the other hand, items e and g, lies in the objective of transformation and sharing between workers associated with these transformations.

Transformation of work practices of the group of actors concerned with the event :

For the first items (b and c), the objective of transformation concerns the actors who were implied in the actions leading to the event. This objective is emergency, because a failure to transform the practices of these actors amounts a priori to allowing a new occurrence of the same event if the same actors had to revive a similar situation. One can think that, having experienced the event, the actors very quickly learn the lesson necessary to avoid this renewal. This is strongly probable, but to be effective and coordinated, this transformation requires to be deliberated, shared, and decided together. The effect of such learning is not as relevant as a collective work around the elements of comprehension of inappropriate actions.

Transformation of the organization of work beyond the group of actors concerned with the event :

For the second items (e and g), the objective of transformation concerns the colleagues of work likely to be placed in a similar configuration. By sharing the

conclusions of the event analysis, the actors concerned with the event seize the occasion to propose modifications of the context of work beyond the restricted circle of their group. The practices of the group are then confronted with those of other similar groups, confronted with the organization, and this, through the different hierarchical points of view. The considered transformations then undergo a second analysis of their robustness (the first having taken place between the actors of the event).

However, this ideal framework of analysis is not systematically possible in practice ; items b and c, concerning the transformation of the practices of the group of actors concerned with the event, encounter one main difficulty: collective meeting (item b) does not always take place because of the dispersion of the actors in different teams ; the writer of the report alone then makes a synthesis of the facts collected near each one, and subjects the produced report to them individually later for opinion. This tends to reduce the event analysis to individual talks to define the chronology of the event, with an individual validation of the tree of the causes and analysis of the elements of comprehension on proposal of the writer of the report, and with a setting in debate in the collective authority specific to the trade (item e). Only the second objective of transformation seems to be reached : "transformation of the organization of work beyond the group of actors concerned with the event", but it is only partially, since the quality of the analysis within the group of actors concerned with the event was not sufficiently pushed, and this limits necessarily the range of the second objective. The event analysis thus loses in effectiveness.

### **3. Conceptual Approach Proposed by the Clinic of Work Activity**

Using the conceptual approach proposed by one of the perspectives of the French psychology, the clinic of work activity, we will show the need for finding effective the prime objective of transformation described above, and we will identify the elements essential to the analysis in order to make the methodology more relevant as discussed further.

The bases of this clinical approach of the work activity are described in [4], [5]. This perspective seeks to understand the dynamics of action of the subjects. That is why it is based on co-analysis with group of workers, which aims at the development of the subjects, of the group, and of the context ; indeed, many studies [4] have shown the importance of the work group itself in inducing lasting transformations in their own work environment.

This approach suggests that the development of the activity is governed by conflicts between concurrent activities that could have been engaged for a given task but with other costs [5], [6]. Thus, the analysis must include activities that have been carried out, but also suspended, thwarted or hindered, and must even include counter-activities. The co-analysis with group of workers must then re-interrogate the professional genre, where "genre" is defined as a social body of shared values which tacitly regulate personal activities, and which is induced by formal prescriptions, informal obligations which come from the work group itself, history and manner of the group (including way of behaving, of talking). The common rules of the

professional genre both generate constraints and are an effective resource for the workers. Clot [5] suggests that the professional genre exerts a psychological function upon each worker's activities through a transpersonal dimension. To be effective in the whole of the situations met by the workers, the professional genre cannot be fixed; it must be revisited, permanently re-interrogated to be adapted to the working context that moves too. This process shapes by using the professional style of each one, and by confronting them between each other within the professional genre, redefining it via the transpersonal memory with the direction where Bannon [7] defines it. In order to help the workers to begin in this process, the co-analysis helps to put under discussion style and genre in a crossed confrontation, developing both personal and collective power to act. During this crossed confrontation, the elements of conversation passing usually unperceived in the professional daily life are maintained more manifest to allow their re-work. To seek these "dialogical residues" [8] is thus fundamental in the analytical step aiming at acting on the development of the subjects, the group, and of the context.

In conclusion, when the framework of analysis described in section 2 does not include collective meeting of the actors concerned by the event, all that has just been pointed out here cannot be reached.

#### **4. Cross Confrontation in Event Analysis**

As we explained in the previous section, one of the main points of the event analysis is the collective meeting of the actors concerned by the event. Then, the sequence of items presented in section 2 will result in putting under discussion personal and collective practices through elements of comprehension of inappropriate actions, making dialogical residues as defined in section 3 to emerge.

With this intention, the collective elaboration of the event chronology, and the work out of the tree of the causes, will bring the history of what have been done to the actors. Then, identifying the failing states and inappropriate actions will result in putting under discussion the elements of comprehension of what happened, among which appear activities that have been carried out, but also suspended, thwarted or hindered, and include counter-activities. During this phase of the collective discussion, the crossed confrontation which is necessary to confront personal styles between them within the professional genre to make it change is built. The context of work is reconsidered to ensure its transformation.

To be functional, the intervention of the HFC (or one initiated with this practice) is fundamental. On the one hand because it is necessary to know the conceptual bases of the methodology, and on the other hand because this person (not actor of the history of the event before its occurrence) will be able to seize the dialogical residues more easily in order to bring them under discussion and thus maintain more manifest the contents of these thoughts for each one. This contributes to a reflective activity on the work activity.

As a final remark, we must notice that the methodology proposed here is different from the one developed and applied by Clot *et al* ([4],[5]), despite the same theoretical background and the same aims ; the difference is in particular induced by the object of the analysis : for them, the object is a specific work activity, and for us,



the object is the work activity associated with a fortuitous event. Thus, while their intervention is based on video films, we must proceed differently because occurrence

of fortuitous events cannot be predicted. Video is replaced by collective meetings with the chronology of the event and the tree of the causes ; to rebuild the history by calling upon the memories is for us the only means of reaching what occurred. Then, Clot's analysis calls upon crossed self-confrontation, whereas we privilege co-analysis by cross-confrontation. The crossed self-confrontation is based on video film of the activity of one subject, which is followed by the analysis of this video by the subject himself, and then, by co-workers (see details in [5]). As we do not have videos, co-analysis by collective cross-confrontation is well adapted for the setting under discussion of the produced history. In both methodologies, the subjects are brought to reflect and say what they did, and to reflect what they said from what they did.

## 5. Concluding Remarks

The crossed confrontation proposed in this paper for event analysis is based on the conceptual approach developed by one of the perspectives of the French psychology : the clinic of work activity. The discussion of both theoretical concepts and methodology, shows the importance of putting under collective discussion the elements of comprehension of what happened, among which must appear activities that have been carried out by the actors of the event, but also those which were suspended, thwarted or hindered, and must include counter-activities. Then appears a psychological function upon each worker's activities through a transpersonal dimension which contributes to the development of the subjects, the group, and of the context. This degree of analysis must be necessarily reached in order to confer to it effectiveness sought in the double objective to understand and reduce the occurrence of safety events.

## References

1. Fauquet, Ph., Buessard, MJ. Impact de la prescription sur les activités de travail en centrale nucléaire. 37<sup>th</sup> SELF Congress, Aix-en-Provence, France (2002) 326-335
2. Fauquet, Ph. Analyse de risques des activités de travail en centrale nucléaire du contexte de l'apprentissage à l'application. 38<sup>th</sup> SELF Congress, Paris, France (2003) 636-646
3. Fauquet, Ph. : Importance of decentralized organization for safety sharing. 11<sup>th</sup> Int. Symp. Loss Prevention & Safety Promotion in Process Industries, Praha, CZ (2004) 1378-1380
4. Clot, Y. La fonction psychologique du travail. Ed. PUF, Paris, France (1999)
5. Clot, Y., Fernandez, G., Carles, L. Crossed self-confrontation in the clinic of activity. 11<sup>th</sup> Eur. Conf. On Cognitive ergonomics. Catalina, Italia (2002) 13-186. Vygotski, L. : Psychisme, conscient, inconscient. Société Française, 51 (1930/1995) 37-52
7. Bannon, L. Towards artificial memories ? Le Travail Humain 63 (2000) 277-285
8. Scheller, L. : Les résidus des dialogues professionnels. In Education Permanente, clinique de l'activité et pouvoir d'agir, Paris, France, 146 (2001) 51-58

# The Influence of Bilingualism on Story Comprehension

Frédérique Fornier and Daniel Martins  
EA 1588 Processus cognitifs et conduites interactives  
Département de Psychologie - UFR : SP SE  
Université de PARIS X - NANTERRE  
Avenue de la République n°200  
92001 NANTERRE  
Tel : 06 30 37 85 45  
frederique.fornier@free.fr

**Abstract.** The purpose of this exploratory research was to study how bilingual individuals can pass from one lexicon to another in a text comprehension task. The results indicate that our subjects only detected text incoherence in French monolingual conditions and that they used strategic processes to manage a task they misinterpreted as a French language test. We advocate to better control the population and to improve our material in order to clarify these results.

## 1. Introduction

The purpose of this exploratory research was to study how bilingual individuals who have the ability to speak two languages can pass from one lexicon to another using the text incoherence detection paradigm in a text comprehension task.

## 2. Theory

### 2.1. Major Issues

What characterizes best bilingualism is its multidimensional aspect as several parameters influence the way a certain type of bilingualism settles in a subject. On the cognitive processing in bilinguals, De Groot (1998) proposed a three store memory concept where bilinguals would have two lexical systems, one for each language, which in turn would be linked together via one common store of conceptual representations.

Several studies focused on the connections between these three stores. The concept mediation model (Potter et al, 1984) states that the only connections between the surface representations of words in two languages exist via a common conceptual system (no direct connections between lexical representations in L1-native language and L2-second language, not even between translation equivalents). The word association model (Kirsner et al, 1984) postulates that the lexical and conceptual cognitive organization of people in the early phase of L2 acquisition would rely on word association with L1 to understand L2 words (no direct link between the conceptual system and the surface representations of the foreign language).

After increased L2 proficiency, the subject would shift to direct conceptual processing. Kroll and Stewart (1994) gave evidence to the existence of the so-called asymmetry effect. In a task such as translation, a bilingual subject's performance is sometimes different according to the direction in which the task is carried out (faster translation of L2 words to L1 than from L1 words to L2). This imbalance tends to disappear only after increased L2 proficiency.

All these results performed mostly through semantic priming tasks on lexicon gave evidence to the existence of an amodal system where surface representation would be connected to a single concept independently of the language used by the bilingual subject. In other words, the conceptual representation would be identical for both lexicons. But overall research focused on lexical production giving very often controversial and opposite results. We decided to study comprehension in monolingual and bilingual conditions using the detection of text incoherence paradigm where subjects had to pass from one lexicon to another. As monolingual designs on text comprehension produced numerous data, we supposed that if a bilingual comprehension task would issue the same trends of results, it would confirm the idea of such amodal lexical organization.

## **2.2. The Detection of Text Incoherence**

Modern theories of text comprehension (Kintsch, 1988) assume that comprehension is a process whereby readers construct complex cognitive representations known as "situation models". The complete comprehension of written discourse results in a memory representation that contains explicitly stated information as well as inferences generated by the reader to "fill the gaps" between what has been explicitly stated and what the message is intended to convey from every angle. Indeed, failure to generate necessary or appropriate inferences can result in incomplete comprehension or miscomprehension. Consequently, it has been observed that readers who understood a text may discern if information written at the end of the text is inconsistent with the beginning of it. In that case, experimenters may notice an increase in the reading times of incoherent sentences as compared to a coherent condition.

The explanation of this result would be that the mental model of the situation which has been built up by the reader in earlier portions of the text is continuously connected to information that is being processed in working memory, while reading. This process may lead to the detection of incoherence.

Consequently, if the situation model has been built up in one language and if final information is given in a second language, will the incoherence be detected as easily as if the inconsistent information had been given in the language of the beginning of the text? No experimental works have been carried out so far on bilingual comprehension and the general hypothesis is that in bilingual conditions, as the situation model is amodal, the results should be globally similar in both conditions (unilingual and bilingual), with a little increase in the bilingual condition reading times due to the switch from one language to another. We tested this hypothesis in the experimental research we present now

### 3. Method

#### 3.1. Subjects

Fifteen native speakers of Portuguese highly skilled in French participated voluntarily in this experiment. They were students and teachers recruited in Paris X-Nanterre University Portuguese Department.

#### 3.2 Material

Sixteen experimental stories with seven sentences were created as follows: sentence 1 introduced a character; sentences 2, 3, 4 allowed to build up the situation model; sentence 5 allowed to bring the character into the action; sentences 6 and 7 were the target sentences for which the reading time was measured using a specific software. The number of letters of each sentence was controlled.

Four different language combinations were used in text elaboration: French-French; Portuguese-Portuguese; French-Portuguese; Portuguese-French (FF, PP, FP, PF). The target sentences either matched or mismatched the situation model. At the end of each text, the subject had to answer to a recognition assertion to ensure that he had understood the situation model.

##### 3.3.1. Procedure

The subjects were asked to read 24 texts (4 training, 4 fillers and 16 experimental texts) and to answer to the recognition sentences with no time limit.

### 4. Results and Discussion

#### 4.1. Results

An analysis of variance was conducted on target-sentences reading times for all sixteen experimental texts.

We observed a significant effect of language combination ( $F_{1/14} = 12,851$ ;  $p < 0.02$ ). In a 2x2 comparison of language combinations, it appeared that in the PP combination, the reading times of target sentences were lower than in the three other conditions.

The mean reading times in the coherent condition tended to be significantly lower than the mean reading times in the incoherent condition ( $F_{1/14} = 3,10$ ;  $p < 0.10$ ).

The target sentence x language combination interaction was significant ( $F_{3/42} = 7,24$ ;  $p < 0.000$ ). The reading times of target sentences were higher in the FF combination especially the reading times of the second target sentence.

The language combination x coherent/incoherent condition interaction result tended to be significant suggesting that the incoherent condition only appeared in the FF combination ( $p < 0.06$ ).

## 4.2. Discussion

The results indicate that our subjects (fifteen Portuguese balanced bilinguals) only detected text incoherence in French monolingual conditions (higher reading times) suggesting that they did not view the experiment as a neutral comprehension task. They may have used strategic processes to manage a task they misinterpreted as a French language test organized by a French experimenter. In the future, we will have to take this parameter into account by informing participants that the task is not a comprehension proficiency test. Moreover, our low population probably lacked homogeneity. We advocate to increase the number of subjects and to better control this variable thanks to a very precise proficiency questionnaire on the acquisition context of both languages.

## 5. Conclusion

This experiment paved the way for our future research. The design proved to be valid and adapted to our goal. We have now to improve our material and to better control the population. During our last experiment, we met a Portuguese teacher who decided to contribute to our work and who helped us to get in touch with French-Portuguese subjects from various Parisian universities, delivering them the questionnaire on bilinguality. We have now 80 potential subjects for our future experiments.

## References

- 1- De Groot, D.G., Frenck-Mestre, C., Gaonac'h, D.: L'Etude Psycholinguistique du Bilinguisme, in *Psychologie Française*, Tome 43, N°4 (1998)
- 2- Kirsner, K., Smith, M.C., Lockhart, R.S., King, M.L., Jain, M.: The Bilingual Lexicon: Language Specific Units in an Integrated Network, *Journal of Verbal Learning and Verbal Behavior*, 23 (1984) 519-539
- 3- Kroll, J.F., Stewart, E.: Category Interference in Translation and Picture Naming: Evidence for Asymmetric Connections between Bilingual Memory Representations. *Journal of Memory and Language* 33 (1994) 149-174
- 4- Potter, M.C., So, K.F., Von Eckardt, B., Feldman, L.B.: Lexical and Conceptual Representation in Beginning and more Proficient Bilinguals *Journal of Verbal Learning and Verbal Behaviour*, 23 (1984) 23-38

## **Context, Categorization and Explanation: A Review of our theory**

Leslie Ganet<sup>1</sup>, Charles Tijus<sup>1</sup>, Patrick Brézillon<sup>2</sup>,

<sup>1</sup> Laboratoire Cognition & Usages, Université Paris8, 2 rue de la liberté  
93512 Saint Denis Cedex, France

leslie.ganet@iedparis8.net, tijus@univ-paris8.fr  
<http://www.cognition-usages.org/>

<sup>2</sup> LIP6, Case 169, University Paris 6, 8 rue du Capitaine Scott,  
75015 Paris, France  
Patrick.Brezillon@lip6.fr

**Abstract.** The study of explanation presents a lot of importance on the understanding, learning and teaching processes. In the 80's, we noticed breathlessness of its study because of they did not consider context effects. Indeed, today, it is accepted that context is of paramount importance for the explanation. We propose here a new point of view based on contextual categorization. We obtained a delimitation of the role of the context and a new definition of explanation.

### **1. Introduction**

Explanations fill our days but they are not always clear and involve confusions, ambiguities and/or misunderstandings. These situations may be clarified when we have the possibility to ask for explanation. However, they become truly useless when it is impossible for us to intervene saying “I didn't understand”. This work started from two questions: (i) “how do we explain?” and (ii) “how to explain as well as possible?”, two questions to which we seek answers.

#### **1.1. Problems with current approaches**

The explanation was gradually recognized as being central to understand learning and understanding processes. To quote some authors, we can refer to Smith [1], Forbus [2], Lester [3] who have studied explanation based learning, Chi [4] concentrated on self-explanation in learning and DeJong [5] and Keller [6] on the improvement of explanation-based learning model. Moreover, more and more researchers in cognitive science fit explanation in paramount part, significant for artificial intelligence and human reasoning fields. However, we noticed, in the Eighties, breathlessness of the studies of explanation, particularly in Artificial Intelligence. Indeed, these ones did not consider yet that explanation is intrinsically linked to the context.

## 1.2. A New Point of view to study the Explanation

Explanation is considered by the great majority of the scientific literature as an activity, an interaction [7], a co-construction [8]. Indeed, studying explanation very quickly lead us to become aware that it is more a question of studying a system. In fact, a lot of components are necessary to product an explanation, the first being the context. In our point of view, we do not oppose against this established conclusion, however we will observe some components extracted from this explanatory system. Indeed, this study enters is in the field of cognitive psychology, applied science which performs controlled observations of the human behavior and our topic is to study explanation as a cognitive process. Consequently, our assumptions lead us towards specific methodological choices that permit us to observe a cognitive process independently of the others □ few methodology has employed until now but nevertheless common in cognitive science. We will never reject in our study the idea of co-construction and are agree with the proposal that “explanation [...] is a part of a broader dynamic process” [7]. The ultimate goal of our study is to understand the explanatory system as a whole. Moreover, we propose a new approach based on contextual categorization [9], that consider explanation as a constructive process and that offer a tool which reveal the context effects [10]. It is a restrictive but a new point of view on explanation. We present here an assessment on the state of our theory.

## 2. The Influence of Context on Explanation

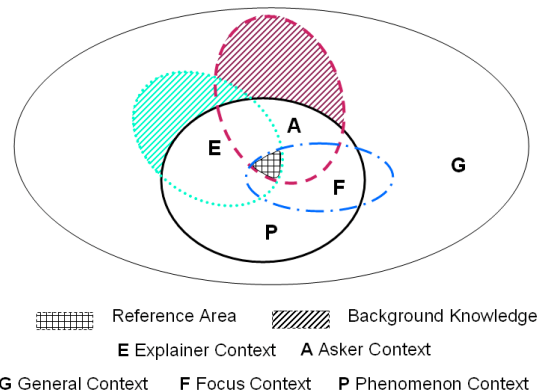

**Fig. 1.** The various contexts of a phenomenon and the reference area smaller than the shared context, the intersection of the explaine and explainer contexts.

The content of an explanation are variable. The major factor which influences it is the context. Since 1965, we know that the context is a key factor for explanation [11, 12]. However, the context is a complex notion that is difficult to define. We will not reconsider here this problem [13]. In our point of view, we consider context as a whole of constraint that influences the construction of a representation. Explanation is built compared to a reference frame (the context of the explainer) and it is interpreted



in another reference frame (context of the explainee). In other words, explanation is generated in a mental representation and is interpreted in another. The minimal condition to explanation be understood is that the two persons who discuss are placed in the same reference frame: the reference area. It is a zone which is the intersection of all the contexts of the phenomenon, a smaller zone than the shared context described by Brézillon [13].

### 3. The two Levels Explanation

Explanation is a term that covers a broad semantic field: to expose, describe, justify, convince, etc. Moreover, this term takes particular meaning according to the fields considered. For Grize [14] the term “to explain” means as much to communicate as to develop, to teach, to interpret or to justify. We proceed a semantic analysis of the lexemes “explain” and “explanation” using the semantic atlas of the CRISCO<sup>2</sup> [15, 16]. This atlas provides a chart of semantic space, i.e. a chart (multidimensional) of the various uses of a word according to its semantic vicinity. This chart directly present “the distance” of the various synonyms of a word. The results show that “explain” is divided into two semantic fields “to develop” and “to clear up” which fit with our two levels explanation theory:

1. A basic level, “the exposure”, which describes a process that is based on contextual categorization. The production of an explanation then corresponds to a top-down parsing of the network of categories [17];
2. A higher level, “the implication”, which is based on the exposure level to provide a link with the missing information of the ignorant person.

### 4. Discussion

The ultimate purpose of this research would be to integrate all the observations, to coordinate each element observed independently in a total explanatory system, “a whole being greater than the sum of their parts”. The ultimate goal of this work is to improve the compatibility in man-man or machine-man communication. Indeed, we imagine many possibilities of applications. Our work will produce new knowledge which will contribute to the development of technical devices: support systems, communication systems, intelligent systems, but also notes, school, works drafting, etc.

---

<sup>2</sup> Centre de Recherche Inter langues sur la Signification du Contexte, Claude Bernard University, Lyon 1, France.

## References

1. Smith, E.E. and D.L. Medin, *Categories and concepts*. 1981, Cambridge, ma: Harvard University Press.
2. Forbus, K.D., et al., *Self explanatory simulators: making computers partners in the modeling process*. *Qualitative reasoning and decision support systems*. Mathematics and computers in simulation, 1994. **36**(2): p. 91 101.
3. Lester, J., et al. *Animated pedagogical agents and problem solving effectiveness: A large scale empirical evaluation*. in *Proceedings of the Eighth World Conference on Artificial Intelligence in Education*. 1997. Kobe, Japan.
4. Chi, M.T.H., et al., *Self explanations: how students study and use examples in learning to solve problems*. *Cognitive science*, 1989. **13**(2): p. 145 182.
5. DeJong, G. and R. Mooney, *Explanation based learning: An alternative view*. *Machine Learning*, 1986. **1**(2): p. 145 176.
6. Keller, R.M., *Defining operationality for explanation based learning*. *Artificial intelligence*, 1988. **35**(2): p. 227 241.
7. Fréjus, M., *Analyser l'Activite d'explication Pour Concevoir en Terme D'aide. Application à la Formation et à la Negociation Commerciale*. 1999, Université Paris 5 - Thèse de doctorat de Psychologie SOUS LA DIR. DE JEAN CLAUDE SPERANDIO.
8. Karsenty, L. *Les explications spontanées dans des dialogues coopératifs de validation*. in *2èmes Journées Explication du PRC IA, Sophia Antipolis*. 1992.
9. Tijus, C.A., *Contextual Categorization and Cognitive Phenomena*, in *Modeling and Using Context. Third International and Interdisciplinary Conference, CONTEXT, 2001*, P.B. V. Arkman, R. Thomason, R.A. Young (Eds.), Editor. 2001: Dundee, UK.
10. Ganet, L., P. Brézillon, and C.A. Tijus. *Explanation as Contextual Categorization*. in *Modeling and Using Context. 4th Interdisciplinary Conference CONTEXT 2003, LNAI 2680*. 2003. Standford, CA, USA: Springer Verlag Berlin Heidelberg.
11. Mackie, J., *Causes and Conditions*. *American Philosophical Quaterly*, 1965. **2**: p. 245 264.
12. Leake, D.B., *Evaluating Explanations*. 1992: Lawrence Erlbaum Associates Inc.
13. Brézillon, P., *Modeling and Using Context: Past, Present and Future*. 2002.
14. Grize, J.-B., *Logique et langage*. 1990, Paris: Ophrys. 153 p.
15. Ji, H., S. Ploux, and E. Wehrli. *Lexical Knowledge Representation with Contexonyms*. in *the 9th MT summit*. 2003.
16. Ploux, S. and H. Ji, *A Model for Matching Semantic Maps Between Languages (French / English, English / French)*. *Computational Linguistics*, 2003.
17. Ganet, L. *Expliquer quelque chose à quelqu'un: format de l'interaction à visée didactique*. in *journées d'études "Interactions verbales" - Stratégies cognitives et discursives dans les interactions verbales*. 2005. 8 et 9 octobre, Université Paris 3, Paris: Presses de la Sorbonne Nouvelle.

## Influence of Regional Accents in Speech Perception

Frédérique Girard<sup>1</sup>, Jeremy Goslin<sup>2</sup> and Caroline Floccia<sup>1</sup>

<sup>1</sup> Laboratory of Psychology, EA3188, University of Franche-Comté, Besançon, France,  
e-mail : frederique.girard@univ-fcomte.fr

<sup>2</sup> Laboratory of Cognitive Psychology, CNRS & University of Provence, Marseille, France  
& Neurocognition Laboratory, Tufts University, Boston, USA

**Abstract.** In this study on regional accent perception we conducted two experiments to examine a hypothesis based on previous work on talker variability and on compressed speech, which predicts that accent-related variations would elicit a perceptual cost in the course of word recognition. In both experiments participants were asked for a lexical decision on the last item of sentences uttered in a familiar or an unfamiliar regional accent. On the one hand there was no main effect of the accent. The cost of accent variability does not seem propagated onto proceeding speech segments. In the second experiment, a significant interaction between accent and sentence length revealed that the effect of the accent increased in relation with sentence length. These findings suggest that unfamiliar regional accents elicit a cost in word recognition, possibly reflecting a normalisation process, emerging mainly after long utterances.

### 1. Introduction

A very common statement in the field of psycholinguistics is that speech is a highly variable signal. Depending on the noise context, the speaker voice, the rate, the surrounding phonetic segments, a given phoneme will have an infinite possible realizations, making it very difficult for phoneticians or computer scientists to extract any phonetic invariance. However, our speech perception device is remarkably efficient in ignoring these variations and extracting stable and abstract lexical representations. It is only recently that the role of extraneous variability has been incorporated in exemplar-based models of speech perception [1]. The two most widely studied sources of variation are the speaker voice [2, 3] and the speech rate [4, 5]. According to these studies, the introduction of several speaker changes or of an unusual speaking rate produce a processing cost in spoken word recognition. This cost can adapt after 5 to 10 sentences, and this type of adaptation results from the conjugate action of two mechanisms, a short-term adjustment to local parameters, and a long-term learning process that encodes phonological and lexical information on this new speech style [4].

Regional or foreign accents are another type of speaker variation which has been poorly studied until recently, at least from a psycholinguistics point of view. Contrary to other types of cross-speaker variability (such as voice quality), accent variations can be classified according to phonetic, phonological and prosodic features. Until

recently accent perception has been largely neglected, with most studies focussing upon production issues [6], or intelligibility [7].

We present two experiments designed to test for the existence of a perceptual cost in word recognition processes due to a regional accent in adults. These experiments used a lexical decision task in which the to-be-detected word (or non-word) was placed at the end of sentences uttered by speakers with different regional accents. Our first hypothesis was that an unfamiliar accent would elicit a global processing delay in word identification that would spread over the sentence until its last word. The other hypothesis was that, as in speaker normalisation, only a few syllables or phonemes would be necessary for the listener to become attuned to an unfamiliar accent ([2] for a review of similar effects in speaker-voice adaptation), and thus no perceptual cost should be observed on the last word of the sentence.

## **2. Experiment 1**

The first experiment was conducted to determine the existence of a processing cost due to the presence of an unfamiliar regional accent in an utterance. Lexical decision was to be performed on the last item of a sentence uttered in different regional French accents: familiar (Besançon) and unfamiliar (Toulouse).

### **2.1. Participants**

Forty two monolingual French-speaking participants were tested (aged 21;6). They were all representative of the Franche-Comté native population, as attested by a questionnaire asking about their regional linguistic origins, and about the amount of time spent outside this region during their lifetime.

### **2.2. Stimuli**

Ten disyllabic test items and six legal non-words were selected, all starting by an unvoiced plosive, to facilitate cross splicing. Each word appeared in 12 different sentences, split between two accents (familiar and unfamiliar), with two female speakers per accent. These four speakers, as well as a Parisian male speaker, were asked to produce all sentences. For instance, in the sentence “Claude joue avec son cartable” (Claude plays with his schoolbag), the part “Claude joue avec son” was uttered with an unfamiliar accented female voice, and the word “cartable” (schoolbag) was uttered with a Parisian accented male voice. They were presented in a pseudo-random order with an ISI of 3s and controlled through the software EPRIME.

### **2.3. Results**

Reaction times for word recognition were computed in an ANOVA. There was no main effect of accent ( $F_1(1, 40) < 1$ ;  $F_2(1, 9) < 1$ ). Mean reaction times were 515.3 ms for words produced after a sentence uttered in the familiar accent and 516.9 ms for those produced after a sentence uttered in the unfamiliar accent.

#### **2.4. Discussion**

The voice change at the end of the sentence (from female to male) is very perturbing for the subjects, as attested by their overall slower reaction times. It could be perturbing in two ways: first, they could adopt a strategy consisting of ignoring the first part of the sentence, and concentrate on the male voice. As recently shown by Dupoux, Kouider & Mehler (2003) [8], lexical access does not seem to occur outside the focus of attention. If our subjects develop an attentional shift towards the voice change, their level of lexical activation during sentence presentation would be poor, and prelexical activation would certainly not be fully efficient either. Whatever the locus of the accent adaptation process, this would lead to a decrease of the accent effect. Or the voice change could be simply disruptive for the accent adaptation process. If subjects are starting to adapt to the unfamiliar accent while listening to the sentence, a voice change could annihilate this effect and all the calibration mechanisms would be disrupted. There would be a sudden return to baseline level, that is, a familiar accent processing level.

It appeared necessary to replicate Experiment 1, with no replacement of the last word by a single token. Besides, we introduced a new variable: the sentence length. It was reasonably thought that accent adaptation process is sensitive to signal length: the more information it gets on the accent characteristics, the more adapted the subject.

### **3. Experiment 2**

In this second experiment material was identical to that used in Experiment 1, apart from the fact that the target item was not replaced by a token uttered by a different speaker.

#### **3.1. Participants**

Thirty five monolingual French-speaking participants were tested (aged 21:5), all selected from the Besançon region through a questionnaire as in Experiment 1.

#### **3.2. Stimuli**

Material is identical to that used in Experiment 1, apart from the fact that the target item was not replaced by a token uttered by a different speaker. Three blocks of 64 sentences were presented: short sentences (7/9 syllables), middle length ones (12/14 syllables) and long ones (17/19 syllables). The order of block presentation was counterbalanced across subjects (MSL or MLS groups). As in the previous experiments, the task was a lexical decision on the last item of each sentence.

#### **3.3. Results**

A main effect of accent (A) was observed ( $F_1(1, 33) = 18.8, p < .001$ ;  $F_2(1, 18) = 8.41, p = .0096$ ), due to the fact that subjects were faster to process familiar accent items than unfamiliar ones (558.9 ms versus 573.6 ms). Moreover, the longer the sentence, the stronger the effect, as attested by the significant A x L (sentence length) interaction by subject ( $F_1(2, 66) = 7.10, p = .0016$ ;  $F_2(2, 36) = 2.99, p = .06$ ). No

accent effect was observed on short sentences ( $F_1(1, 33) < 1$ ;  $F_2(1, 18) < 1$ ), but on middle length sentences ( $F_1(1, 33) = 8.86$ ,  $p = .0054$ ;  $F_2(1, 18) = 1.86$ ), and even more on long sentences ( $F_1(1, 33) = 22.94$ ,  $p < .001$ ;  $F_2(1, 18) = 11.93$ ,  $p = .0028$ ).

### 3.4. Discussion

These findings suggest that unfamiliar regional accents elicit a cost in word recognition, possibly reflecting a normalisation process, emerging mainly after long utterances. Added to another set of studies [9, 10], this research shows that the word recognition device is partly involved in the extraction of accent characteristics, and that this operation is time-consuming. At least two possibilities can be offered to explain the locus and the role of this variability processing: according to the first one, the speech perception system needs a few words or syllables to extract a pattern of a given accent, select the right corresponding pattern from a storage system, and apply it as a perceptual system for further processing. This would explain why the accent related cost in word recognition only occurs in long sentences. According to a second possibility, two distinct mechanisms are used: the first one, operating in parallel to the word recognition system, consists of identifying the accent for inferring extra linguistic knowledge. The second one is a bottom-up device at the core of the word recognition system, which simply retrieves phonological features from the speech signal. This device is sensitive to important phonological or prosodic mismatches, which would explain why it starts being resource-consuming only after a certain amount of unfamiliarly accented signal. That is, the longer the sentence, the most unusual prosodic or phonological information it carries.

In conclusion, this study demonstrates that the role of context in spoken word processing is highly useful to enrich our understanding of the architecture of this device.

### References

1. Pisoni, D.B.: Some thoughts on "normalization" in speech perception. In K. Johnson and J.W. Mullennix (Eds.), *Talker Variability in Speech Processing*. San Diego: Academic Press (1997) 9-32
2. Jusczyk, P. W. & Luce, P. A.: Speech perception and spoken word recognition : Past and present. *Ear and Hearing*, Vol. 23 (2002) 2-40
3. Bradlow, A. R., Nygaard, L. C., & Pisoni, D. B.: Effects of talker, rate, and amplitude variation on recognition memory for spoken words. *Perception & Psychophysics*, Vol. 61 (1999) 206-219
4. Dupoux, E., & Green, K.: Perceptual adjustment to highly compressed speech: Effects of talker and rate changes. *Journal of Experimental Psychology: Human Perception and Performance*, Vol. 23 (1997) 914-927
5. Sebastián-Gallés, N., Dupoux, E., Costa, A., & Mehler, J.: Adaptation to time-compressed speech: Phonological determinants. *Perception and Psychophysics*, Vol. 62(4) (2000) 834-842
6. Chambers, J. K.: Dialect acquisition. *Language*, Vol. 68 (1992) 673-705
7. Munro, M. J., & Derwing, T. G.: Processing time, accent and comprehensibility in the perception of native and foreign-accented speech. *Language and Speech*, Vol. 38 (1995) 289-306

8. Dupoux, E., Kouider, S. & Mehler, J.: Unattended Lexical Activation? Explorations using dichotic priming. *Journal of Experimental Psychology: Human Perception and Performance*, Vol. 29 (2003) 172-184
9. Girard, F., Goslin, J., & Floccia, C.: Un accent régional perturbe-t-il l'accès lexical? *Proceedings of the Workshop MIDL, Paris, (2004)*
10. Floccia, C., Goslin, J. & Girard, F.: Processing inter-speaker variability: the case of regional accents. *Proceedings of the JEL2004, University of Nantes (2004)*

### ***Acknowledgements***

This research is part of a Cognitique project entitled « Ecole et Sciences Cognitives. Apprentissage des langues : dysfonctionnements et remédiations » (2002-2004), directed by Pr. Gabrielle Konopczynski and the third Author. Many thanks to Anne Bardin.

## Time Contexts in Distributed Projects: Towards an Interdisciplinary Temporal Framework

Anneli Heimbürger, Jari Multisilta and Kai Ojansuu

Tampere University of Technology, Pori, Advanced Multimedia Center  
P.O. Box 300, FI – 28101 Pori, Finland  
anneli.heimburger@tut.fi, jari.multisilta@tut.fi, kai.ojansuu@tut.fi  
<http://amc.pori.tut.fi/>

**Abstract.** Time is an essential resource in distributed project environments. In our paper we discuss temporal issues related to project management in distributed environments, especially from a project manager's point of view. We present an in-depth analysis of the granularity levels of the time statuses and temporal rules related to project documents. We introduce a time-sensitive linking structure, XLinkTime, that is activated when a context dependent temporal rule or a set of rules is valid. Our focus is on document-centric projects rather than on concrete artifact oriented projects. We elaborate on the discussion of time contexts and introduce a general framework for different time contexts in distributed project environments from the viewpoint of project managers.

### 1. Introduction

Distributed project management systems (DPMS) on the Web have an important role in project execution between different organizations - particularly when inter- and intra-organizational projects involve geographically dispersed teams in different time zones. From the vantage points of project managers several context classes can be identified such as users, project teams and tasks, geographical dispersion and time. Effective time-based project management can decrease project lead-times and thus results in economical benefits with increased competitiveness. In order to develop time-sensitive monitoring services for project managers, a deeper understanding of the time contexts is needed.

The contribution of our paper is a presentation of an in-depth analysis of granularity levels of time contexts related to management of project documents. We describe a proof-of-concept implementation which supports time-based linking and navigation. The implementation is based on a time-sensitive hypertext linking structure XLinkTime [5, 6]. The basic idea is that time-sensitive project documents are only presented to a user when the right time context is given to the system. Furthermore, we elaborate on the discussion of time contexts and introduce a general framework for different time contexts in distributed project environments from the viewpoint of project managers.



## 2. Time Contexts in Project Documents

A project can be defined as a combination of human and non-human resources pulled together into a temporary organization for achieving a specified purpose [4, 8]. The project manager is the chief executive of this temporary organization. The project tasks and related documents can have several temporal characteristics [2]. Document status - new, in work, for approval, released, and obsolete - describes the stage reached in the document's life cycle, and is used to control the publication process by means of limiting user access privileges in each status. Granularity levels of temporal rules related to project documents is presented in Table 1. The terminology is corresponding to Allen's relations between two time intervals [1, 3].

**Table 1.** Granularity levels of temporal rules related to project documents

Name	Definition
Ready before	A document must be ready before a given time interval.
Ready right-before	A document must be ready just before a given time interval.
Ready after	A document must be ready after a given time interval.
Ready right-after	A document must be ready just after a given time interval.
Ready equal	A document must be ready at a given time instant.
Overlap	Two documents share the same status during a given time interval.
Within	Documents with a certain status totally inside a given interval are chosen.
Start	Documents whose life cycles start at a given time instant.
Finish	Documents whose life cycles finish at a given time instant.

Time-sensitive project documents are only presented to a user when the right time context is given. The time-sensitive context structure can be constructed by means of XLinkTime which is a time-sensitive linking mechanism [5, 6]. In XLinkTime each participating link is activated only when the appropriate temporal rule is valid. The formalism of XLinkTime is based on a multi-ended link structure which is defined in XML Linking Language (XLink) recommendation specified by the World Wide Web Consortium (W3C), and on Allen's relationships between two time intervals [1, 9, 10]. In XLinkTime, we extended the attribute space of XLink's multi-ended link with a timerule attribute. The timerule attribute in our implementation can have the values of status, start and end. We have demonstrated time-sensitive linking and navigation support for a dynamic project workflow chart. The application area of our

demonstration is a software engineering project. We have applied the Rational Unified Process (RUP) as the framework for the software engineering process [7]. When the user activates a certain block in the flowchart he/she can give a temporal rule and/or document status to retrieve the appropriate documents. He/she can navigate in a flowchart according to different temporal views. An example of a view is given in Figure 1.

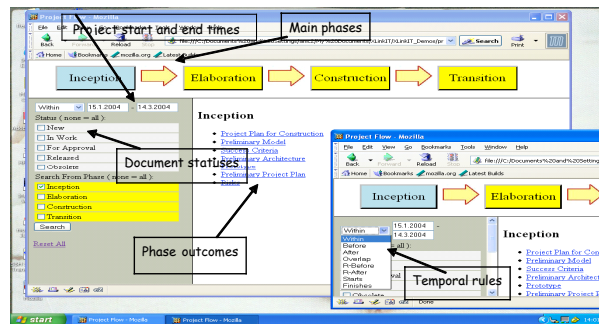

**Fig. 1.** A dynamic project workflow chart with time-sensitive linking and navigation support

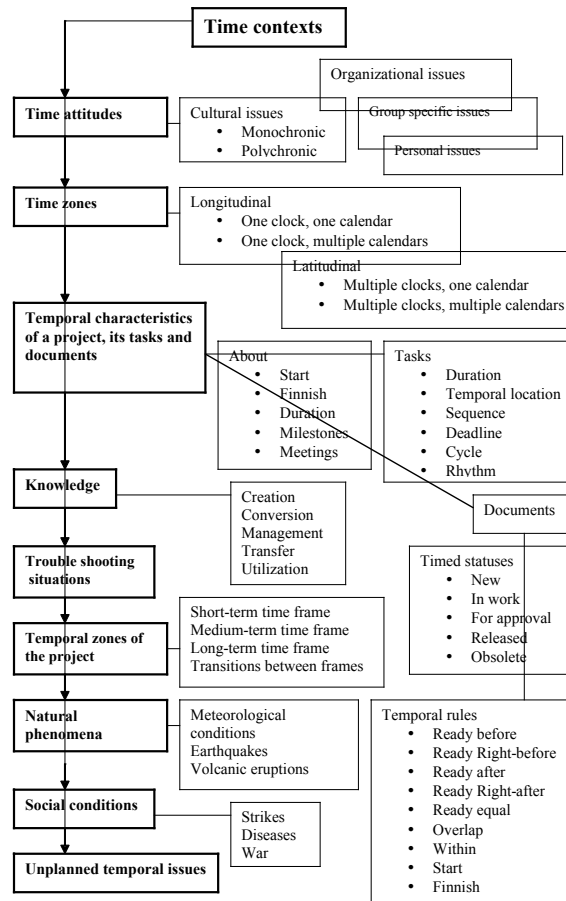

**Fig. 2.** A temporal framework for time contexts in distributed project management environments

### 3. Towards an Interdisciplinary Temporal Framework

In addition to temporal rules related to project documents, there are other time contexts which a project manager has to face. This leads us towards a more general framework for time contexts in distributed project management (Figure 2). Most of the time contexts in Figure 2 are qualitative. If to be used as query items in multidatabase project environments, qualitative time contexts should be mapped to quantitative space, and express them as temporal attributes. Time contexts can be regarded as temporal metadata of the project.

We can approach the problem of describing time-sensitive hypertext linking structures in two ways: with a top-down and a bottom-up approach. The top-down

approach can be applied to describe both application specific and generic temporal rules whereas the bottom-up approach concentrates on describing application specific temporal rules. The focus of our paper has been on the bottom-up approach which embeds temporal rules into the XLink syntax. The top-down approach could especially be applied to distributed multi-project management where several time rule sets are applied simultaneously.

## References

1. Allen, J. F.: Time and Time Again: The Many Ways to Represent Time. *International Journal of Intelligent Systems*. 6/ 4 (1991) 341-355
2. Ancona, D. G., Okhuysen, G. A., Perlow, L. A: Taking Time to Integrate Temporal Research. *Academy of Management Review*. 26/4 (2001) 512-529
3. Berztiss, A. T.: Time in Modelling. In: Kangassalo, H., Jaakkola, H., Kawaguchi, E., Welzer, T. (eds.): *Information Modelling and Knowledge Bases XIII*. IOS Press, Amsterdam (2002) 184-200
4. Chen, C.-H., Ling, S. F., Chen, W.: Project Scheduling for Collaborative Product Development Using DSM. *International Journal of Project Management*. 21/ 4 (2003) 291-299
5. Heimbürger, A.: Modelling Time-Sensitive Linking Mechanisms. In: Jaakkola, H., Kangassalo, H., Kawaguchi, E., Thalheim, B. (eds.): *Frontiers in Artificial Intelligence and Applications, Vol. 94, Information Modelling and Knowledge Bases XIV*. IOS Press, Amsterdam (2003) 26-42
6. Heimbürger, A. Time-Sensitive Relationship Management in Technical Manuals. Case: Maintenance Schedules. In: Kangassalo, H., Wangler, B., Kiyoki, Y., Jaakkola, H. (eds.): *Frontiers in Artificial Intelligence and Applications, Information Modelling and Knowledge Bases XVI*. IOS Press, Amsterdam (2005) 152-169
7. Jacobson, I., Booch, G., Rumbaugh, J.: *The Unified Software Development Process*. Addison-Wesley, Boston (1999) 463 p.
8. Turner, J. R., Müller, R.: On the Nature of the Project as a Temporary Organisation. *International Journal of Project Management*, 21/1 (2003) 1-8
9. W3C.: The World Wide Web Consortium: Date and Time Formats (referred 19.1.2005) <URL: <http://www.w3.org/TR/NOTE-datetime/>> (1998)
10. W3C.: The World Wide Web Consortium: XML Linking Language (XLink) Version 1.0 W3C Recommendation 27 June 2001, (referred 19.1.2005) <URL: <http://www.w3.org/TR/xlink/>> (2001)

## Context, Individuality and Music's Affect on Listeners

Nysson Lefford<sup>1</sup>, Johnny Wingstedt<sup>1</sup>, and Cecilia Sjömark<sup>1</sup>

<sup>1</sup> Interactive Institute, Sonic Studio, Acusticum 4, 941 28 Båteå, Sweden  
{nysson.lefford, johnny.wingstedt, cecilia.sjomark}@tii.se  
<http://www.tii.se/sonic>

**Abstract.** Individual experience is a central theme in many emerging forms of music technology particularly in interactive scenarios. The need to make these experiences more engaging and meaningful has forced us to look more closely at listeners' definitions of context and how personal and shared knowledge shapes contextual constraints. While listening, perceptions of context change quickly. Perceptions also vary significantly between listeners making the listeners' perspective of context a crucial part of the personalized musical experience. We contrast context in music and games, and investigate the contextual constraints of emotions, associations and narratives to deepen our understanding of context's affect on the perception of individual listeners.

### 1. Introduction

Personalization has become a central theme in many emerging forms of computer-mediated, musical interaction. Personalizing the musical experience necessitates individuating listeners. No two listeners hear a piece of music exactly the same way. Those differences have many origins, some physical, some based on experience, and some influenced by vague, personal preferences. Individualistic and subjective factors effect not only the interpretation of music, but also the contexts constraining those perceptions.

### 2. Context and Music Listening

Unlike other context sensitive tasks, music listening requires that listeners attend to many different aspects of musical structure. Therefore, a listener constantly redefines the context, attends to different features and different types of musical structures, and engages different sensory and cognitive processes while listening and interpreting. Meaning in music is inseparably linked to the ability to perceive the same sound object or musical structure through numerous contexts. Listeners with comparable auditory systems listening to the same piece of music will formulate numerous, equally valid perceptions of musical structure, interpretations, meanings, and definitions of context through which those interpretations and meanings are derived. Musical interpretations possess many possible outcomes. In this way, context's relationship to music is similar to the role of context in any sort of game in that the

outcome is inherently flexible, and some strategy consistent with the outcome is required to reach that end.

Context has a distinctive role in games, and also in the interpretation of music. Games have goals. Reaching those goals is dependant upon acting within a set of pre-defined constraints. Game players formulate strategies for achieving those goals through the game constraints and relative to the context of every action taken. Constraints may include elements (physical or imagined) that are acted upon like chess pieces or a ball. There are also well-defined constraints governing how the elements or players change or function, or what are commonly referred to as “rules”. In games, players and spectators usually know the rules a priori. There is transparency in how the strategies function in a specific context to achieve the goal. For example, achieving the goal of an American football game requires scoring touchdowns. The strength and strategy of players varies, but the end goal of every football game is always comparable and the means available to the players for achieving the end goal are pre-specified. When a quarterback makes a great pass, the other players and the viewers understand the strategy and the efficacy of the play because they perceive that pass through an immediate context defined by the position of the players.

Listening and interpreting music is like a game in that musical structure is perceived through a context that includes what the listener imagines to be the goal, the strategy of the composer for achieving those goals, and related musical structures. The context is crucial for interpreting the meaning of musical structure just like an effective football pass is linked to the positions of surrounding players and the goal of scoring a touchdown. However, unlike conventional games, in music each listener defines the goals and constraints. The listener cannot be certain of the composer’s goals. Game rules are consistent from game to game, but the constraints limiting what constitutes musical structure are different in every piece and potentially for every listener. Some constraints or conventions may occur in many pieces. For example, an artist may choose to compose in a particular style. These musical conventions are nonetheless far more flexible than the rules of any standard game.

In creating or experiencing a game one wants transparency between the constraints, the rules, the strategies and the goals. But in music, complete transparency is not always desirable. The more a musical experience minimizes the personal, subjective aspects of interpretation, the more game-like the processes of listening and interpreting will be for the listener. That is not to say that game experiences are less significant than those involving artistic expression, but rather to emphasize the distinction between each. Games greatly utilize a shared context. The artistic experience can be highly personal, and this is precisely why the role of context, particularly individualistic constraints, is so significant in shaping the listeners’ perceptions.

The subjective traits brought by listeners to musical interpretation are often associated with experience, learning and long-term memory, and are therefore, often hard cognitive processes to observe and compare across listeners. However, comparisons across contexts become more feasible when we artificially restrict possible contextual constraints, just as we can compare games with relative ease because the constraints are pre-defined. These restrictions need not be unnatural if they mimic constraints often applied by listeners in natural settings. In one recent experiment, the context is constrained by linking music listening to mental state, emotions and associations.

Similarly, connecting musical interpretation to narrative provides another way to add constraints. Both of these examples provide insight into the role of context in music interpretation.

### **3. Music, Context, Emotions and Associations**

By asking listeners to correlate a mental state such as relaxation with musical features we can better isolate the relationship between music, perception and context. Music can induce emotions in listeners, and there is evidence to suggest it may also impact other mental processes and physiology. [1][3] However, the musical affect is not the same for every listener. In a recent study, we gave subjects the target mental state “relaxed,” and asked them to select music that for them induced relaxation. Certain surface features of the selected pieces varied significantly (i.e. various genres, instrumentation, levels of complexity, etc. were represented.) Some aspects of musical structure may be common amongst all the pieces and be responsible for triggering the relaxation response, but it is also likely that listener specific, subjective factors are influencing these decisions. Both of these possibilities are currently under investigation. Regardless, for each explanation the context enables the subject to isolate and hear a set of qualities that induces the relaxed mental state.

When assigned the task of selecting relaxing music, every listener formulated a set of constraints conforming to some personal definition of “relaxed” and brought that context to the listening process. Preliminary findings suggest that several factors contributed to constraints in the relaxed context although these factors varied for different subjects. Associations (or the lack of associations) with generic emotions, mental states, events or scenarios and the selected music were a source of constraints for some; as were memories of specific persons, events, physical sensations or previously experienced emotional states. Additionally, how subjects felt physically while framing the context weighted certain constraints over others and/or affected listeners’ attention to some musical features in some instances. Lastly, listening to music is perceptually demanding. The shift in listener attention or listeners’ desire to shift away from non-focused listening may also contribute to the features and attributes that receive the most attention. While listeners’ interpretations of relaxing music were highly personal, some similarities in interpretive strategy did emerge in this experiment.

### **4. Music, Context and Narrative**

Different listeners often attribute similar emotional content to music regardless of the piece’s affect on them personally. Composers use this musical affect to advantage in many multimedia scenarios. In contexts where music underscores multimodal experiences, musical function is tied directly to interpretations of the non-musical material. The meaning and function of a musical performance is defined by the context. As the context becomes less ambiguous, the musical functions become more visible and clearly defined. Marshall and Cohen [2] have shown that when music is

combined with other media and performed as a part of a narrative, such as in film, the roles and functions of the musical expression become clearer and more explicit – the perceived meaning of music takes on a concrete and unambiguous quality. The multimedial microcosm of film offers a distinct context that gives convenient opportunity to explore in detail some of the many different expressive and narrative aspects of music.

The immediate context in film is the narrative, as communicated by the multimodal combination of moving image, dialogue, sound effects, music etc. Of course there are also other contextual dimensions that concern the film experience, such as the viewing context of the audience (e.g. in a movie theatre, at home, in company with others or alone), the context resulting from the personal situation, history and preferences, the larger societal and historical contexts, etc. – but the time-space world of the film diegesis offers its own distinct narrative conditions within these other dimensions of context.

In film the constant interplay between the parts and the whole becomes highly visible. Here it is obvious how music is not just affected by the context, but also how it is instrumental in contributing to the constant and ongoing redefinition of the context. For example, if the music of a certain scene is replaced with some other music, the story will change – just as it will change if we replace the visuals or the dialogue. In the light of the growing importance of multimedial means of expression in new media, it is becoming increasingly important to study music's narrative mechanisms as they appear in interplay with other media, and to understand musical functions in relationship to expanding definitions of context.

## 5. Conclusions

Musical meaning is linked to the varied contexts through which we listen. This variation is subject to a set of highly personalized preferences and knowledge. The challenge in designing interactive music scenarios is to balance operational transparency in system and the ambiguous, personal biases of each listener/user. The experiences of active listeners should differ, each deriving different meaning and interpretations in music. In this way, we can move towards more engaging and musically meaningful interactive, music scenarios.

## References

1. Chiu P., Kumar A.: Music therapy: loud noise or soothing notes? *International Pediatrics*, Vol. 18, (2003) 204-208
2. Marshall, S., Cohen, A.: Effects of Musical Soundtracks on Attitudes toward Animated Geometric Figures. *Music Perception*, Vol. 6, No. 1, Fall (1988), 95-112
3. Thayer, J., Faith, M.: A Dynamic Systems Model of Musically Induced Emotions Physiological and Self-Report Evidence *Annals of the New York Academy of Science*. Vol. 930 June (2001), 452-456



## **The Contextualist Perspective and the True/False Judgement of Utterances: Literal Truth and Pragmatic Truth**

Fanny Lichtenstein and Fernando Gabucio

Departamento de Psicología Basica, University of Barcelona  
Passeig de la Vall d'Hebrón, 171. 08035 Barcelona. Spain  
Fanny Lichtenstein (Lecture and a PHd Student).  
E-mail: lichtenstein@ub.edu. Tel: 00-34-93-3125149  
Fernando Gabucio (Professor).  
E-mail: fgabucio@ub.edu. Tel: 00-34-93-3125147

There is an old distinction between literal meaning and metaphorical meaning that in the last decades has raised interesting arguments among philosophers, historians, linguists and psychologists. Within the psycholinguistic discussion, the relationship between utterance<sup>3</sup> meaning and its truth conditions has been essential. Traditionally, within the cognitive psychology arena, the truth of an utterance and its propositional-linguistic content are usually put on the same level. From this point of view, the less an utterance's linguistic content reflects its propositional meaning, the less truth it contains.

An alternative to the standard position about utterance comprehension (and the alleged priority of literal interpretation, as Récánati pointed, 1995) is the contextualist point of view, according to which the truth conditions of any utterance are contextually determined. Therefore, utterances do not have a propositional content which is compared with their contextual information. Instead, the propositional content is defined in terms of its context. In a radical sense, this means that the truth of an utterance is a function of the utterance's components saturation in a specific context (Récánati, 2003).

Considering the confrontation of both points of view (the standard one and the contextualist one), we could distinguish two conceptions of truth about utterances:

- literal truth: the correspondence between the linguistic content of the utterance and the context to which it refers
- pragmatic truth: the correspondence between the meaning of a statement and the context to which it refers

From the contextualist view, the truth conditional interpretation of utterances is pragmatic to a large extent, in a sense that meaning is a function of context.

---

<sup>3</sup> We will use "utterance" in a general sense to mean encompass both spoken and written language. However, our experiment was in the written mode and in reference to it we will use "sentence".

In the present study our focus will be what repercussions the distinction between the standard and contextualist point of view have on the literal/metaphorical distinction. An important consequence of the “literally true” notion of true is that psychological explanation of utterance comprehension must assume the literal-metaphorical distinction as a truthfulness difference. That means that in cognitive psychology metaphorical utterances tends to be considered as less truthful than literal ones.

Let’s consider the case of literal-metaphorical distinction focussing on people’s judgement about the truthfulness of utterances. A consequence of putting on the same level the truth of an utterance and its literal truth is that any deviation from literality might be considered as a deviation from the propositional truth. Thus, metaphorical utterances would be less truthful than literal ones. But if we could understand truth conditions as pragmatic truth conditions, most metaphorical utterances might be considered true regardless of their non-literal features.

Under what conditions do people consider a sentence true? The goal our work is to present some data which question the notion that literal truth is equivalent to the truth of an utterance. The standard point of view predicts that a sentence will be considered as true depending on its literal truth conditions. Our general hypothesis is that a sentence will be considered as true depending on context.

The first step in Keysar’s research about the understanding of sentences (Keysar, 1989) was asking participants about different sentences in terms of a previous context. The participants had to rate each of the 12 sentences in a 1-7 scale on three aspects: literal truth, consistency with context and how much it made sense in context. Keysar created four different contexts for each sentence. These contexts were presented before each sentence. Depending on each context, the propositional content might be literally true, literally false, metaphorically true or metaphorically false. Each subject rated each sentence in a single condition.

In the current work we are going to focus on the obtained literal truth scores. In Keysar’s instructions, participants were asked to rate each statement in terms of its literal meaning. The average scores for this scale was:

- literally true condition: 6.17
- literally false condition: 1.67
- metaphorically true condition: 3.66
- metaphorically false condition: 3.42

Keysar’s results showed that participants put on the same level metaphorically true conditions and metaphorically false conditions, and that the literally true condition was the one with a higher score. However, what would happen if we ask about the truth of the statement instead of the literal truth? Would that serve to give evidence for a contextualistic point of view about the relation between the meaning of an utterance and its truth conditions?

Our hypothesis is that scores for literally true and metaphorically true sentences scores will be similar, i.e. that metaphorically true sentences will score higher (compared to those in Keysar’s study) in a truthfulness scale. On the other hand, scores in literally false and metaphorically false conditions will be similar depending on context. Therefore, context and not literal or metaphorical meaning determines the accomplishment of any truth condition.

In order to challenge our hypothesis, we have designed a preliminary research which includes a modification of Keysar's task. We took 16 sentences with both metaphorical and literal meaning. For each sentence we designed 4 short stories as a way to turn its meaning in literally true, literally false, metaphorically true and metaphorically false. Each participant had to rate the whole set of statements in one of the possible four conditions. The introduced modification was about asking the participants to rate each sentence in terms of its truth, instead of its literal truth. Our preliminary results seem to confirm our hypothesis. Metaphorically true sentences show higher scores in the truthfulness scale than those obtained in Keysar's research (mean: 5.47) being at the same level as the literally true sentences (5.56). On the other hand, metaphorically false sentences' scores are closer to the scores of literally false sentences, and are considered as "less true" than the sentences rated in Keysar's experiment in the same condition.

The present data seem to support a contextualistic view of utterances truth conditions: i.e. when literal truth is not specified to participants, the truth conditions of sentences are the same in both metaphorical and literal contexts. Therefore, data would support that when people give truth values to a sentence, they use the notion of pragmatic truth, and not the notion of literal truth. Although being preliminary work we expect that further research will provide more data to support the contextualistic position.

## References

- Keysar, B.: On the functional equivalence of literal and metaphorical interpretation in discourse. *Journal of memory and language*. 28 (1989) 375- 385
- Rècanati, F.: The alleged priority of literal interpretation. *Cognitive Science*. 19 (1995) 207-232
- Rècanati, F.: Literal Meaning. *Jean Nicod Online Papers* (2003)

## Influence of the Olfactory Category's Homogeneity on the Description of Odors

Céline Manetta and Isabel Urdapilleta

University Paris VIII,  
Laboratoire Cognition & Usages  
93526 St Denis Cedex 02, France  
manettaceline@hotmail.com, isabel.urda@univ-paris8.fr

**Abstract.** We examine the effects of context on the description of odors, particularly the influence of the category's homogeneity on the description of olfactory stimuli. Forty-eight subjects described 12 olfactory stimuli belonging to two groups: a group of olfactorally similar odors – Hesperidia [citrus oils]; and a group of less olfactorally similar odors – Fruits. The results show the category's homogeneity has an effect on the number of single properties, i.e. the properties of an odor named by a single subject.

### 1. Introduction

This study focuses on the naming of olfactory properties as a function of context. Research on odor perception stresses that it is largely dependent on the context in which the odors are presented. Three contextual levels are involved:

- neurophysiological [1]
- descriptive: several contextual effects on the perception of the intensity [2,3] and characteristics [4] of odors have been demonstrated
- cognitive: research on odor memory shows that the encoding context plays an important role in the memorization and recall of odors [5, 6]

We examine the effects of context, which consists of the homogeneity of the category to which the objects belong.

Sjoberg [7] and Tversky [8] studied the influence of the environmental context on judgments of similarity. They showed, for example, that the similarity between “*a falcon*” and “*a chicken*” increases when the word “*wasp*” is included in the set of items to be compared, which is not the case when the word “*sparrow*” is included. It thus appears that the properties' salience is related to categorical proximity [9]. With regard to the number of objects present in the environment, Vignaud [10] showed that this number has an influence on the number of properties generated. Subjects utter a larger number of properties when the objects are presented in pairs than when they are presented one at a time. Objects that are simultaneously present in the environment thus influence the evaluation of a target object.

With respect to odors, some authors have analyzed the vocabulary used in the description of odors [11, 12]. They have demonstrated that this vocabulary is based on several factors, such as the source and intensity of the odor, but that it is also strongly related to individual experience. It should also be noted that some studies have shown that the context influences the description of odors [13], such as the description of objects belonging to natural categories.

We analyze the homogeneity effect of the category to which the olfactory stimuli belong on the description of odors. We compare two experimental conditions: in the first, the odors belong to a homogeneous olfactory category, Hesperidia (H), which is comprised of similar odors, and in the second, the odors belong to a non-homogeneous category, Fruits (F), which are comprised of less similar odors.

We hypothesize that the total number of properties generated is not modified by the similarity of odors that comprise the olfactory category. However, the number of single properties, i.e. the properties of an odor named by a single subject, is larger for non-homogeneous categories. In this situation, the subject refers to knowledge in his/her memory, i.e. to his/her mental context, because the environmental context is not very restrictive and the similarities between odors are not easily perceived.

## **2. Study of the Effect of the Category's Homogeneity on the Number of Properties Uttered**

### **2.1. Participants**

Forty-eight subjects – 24 men (mean age: 28.37; standard deviation: 4.72) and 24 women (mean age: 25.42; standard deviation: 5.28) – participated in this experiment.

### **2.2. Materials and Protocol**

Twelve olfactory stimuli, divided into two groups, were presented: 1) Hesperidia (homogeneous category: citrus odors, relatively similar but distinguishable), including *bergamot orange*, *lemon*, *tangerine*, *lime*, *orange* and *grapefruit* and 2) Fruits (non-homogeneous category: dissimilar odors), including *banana*, *strawberry*, *kiwi*, *melon*, *pear* and *apple*. Each odor (essential oils) was presented in the form of an odor pen and the concentration of the odorants was determined in order to assure equivalent perceived intensities.

The experimental protocol took place during three sessions of 30 to 45 minutes each. During sessions 1 and 2, the subjects performed an odor-description task. Each subject smelled the two odor's groups. In half the cases, the subjects began by the Hesperidia group, then the Fruit group and in the other half of the cases; the subjects began by the Fruit group, then the Hesperida group. They smelled the odors as many times as necessary. The instructions were as follows: *How would you*

*describe this odor? What does it bring to mind? What terms would you use to characterize it?* Verbalizations were noted in full.

During session 3, the subjects evaluated the similarity of the stimuli presented in pairs. The aim of this task was to determine whether the difference in homogeneity between the groups of odors was actually perceived.

### 2.3. Results

With respect to the homogeneity of odor groups, odors in the Hesperidia group (H) were perceived as more similar than odors in the Fruit group (F). A Student's *t* test conducted on the two groups shows that the probability of erroneously rejecting the null hypothesis is 0.003.

With respect to the homogeneity of the olfactory category (H and F) and its influence on the total number of properties generated and the number of single properties (Table 1): the category's homogeneity had no influence on the total number of properties generated. A Student's *t* test conducted on the two conditions shows that the probability of erroneously rejecting the null hypothesis is 0.89. Presenting odors that were olfactorally similar or dissimilar had no effect on the description of these odors; in both cases, the subjects were equally prolific.

**Table 1.** Total and mean number of properties generated per subject and per condition; total and mean number of single properties generated per subject and per condition (H: Hesperidia; F: Fruit)

	H	F
No. of subjects (S)	48	48
Total no. of properties (P)	5225	5206
Mean no. of properties per subject (P/S)	108.85	108.45
Total no. of single properties (SP)	1373	1625
Mean no. of properties per subject (SP/S)	28.6	33.85

The category's homogeneity had an influence on the number of single properties that is, properties of an odor named by a single subject (i.e. *mint*, *orange cakes*, *sweet and mealy apple*, *creamy*): there were more single properties generated for the Fruit category than for the Hesperidia category. A Student's *t* test conducted on the two conditions shows that the probability of erroneously rejecting the null hypothesis is 0.001. Thus, when the category presented is not homogeneous, a larger number of single properties is generated.

### 3. Discussion and Conclusion

This experiment demonstrates a presentation context effect on the description of odors: when the olfactory category is comprised of dissimilar odors, subjects generate a significantly larger number of single properties. It seems that in this case, subjects are referring to semantic knowledge in memory, to their mental context. These experimental results underscore the importance of the effects of mental context and open new possibilities for research into the effects of context on intra-personal variability, given that the number of single properties specific to a subject is an indicator of such variability. As a result, the homogeneity of the category encompassing the objects studied should be taken into account when one wishes to control for such effects. It should be noted that other contextual effects have been demonstrated for sensory categories [13].

It would be interesting to study in greater depth the types of properties generated in a non-homogeneous context: Which semantic categories do single properties refer to? Do they describe the source of the object? Its intensity? Are they hedonic in nature?

### References

1. Stevens, D.A., O'Connell, R.J.O.: Individual thresholds and quality reports of human subjects to various odors. *Chem. Sens.* 16 (1991) 57-67
2. Risky, D.R., Parducci, A., Beauchamp, G.K.: Effects of context in judgments of sweetness and pleasantness. *Perc. and Psych.* 26/3 (1979) 171-176
3. Cain, W.S., Gent, J.S.: Olfactory sensitivity: reliability, generality and association with aging. *J. of Exp. Psych.: Hum., Perc., Perf.* 17 (1991) 382-391
4. Lawless, H.T.: A sequential contrast effect in odor perception, *Bull. of the Psycho. Soc.* 29/4 (1991) 317-319
5. Sulmont-Rossé, C., Issanchou, S., Köster, E. □Caractéristiques de la mémoire des aliments □ conséquences sur la perception des aliments, *Psych. Fran.* 48/4 (2003) 9-21
6. Chu, S., Downes, J.: Long live Proust: the odour-cued autobiographical memory bump, *Cogn.*, 75 (2000) 41-50
7. Sjöberg, L.: A cognitive theory of similarity. *Goteborg: Psych. Rep.*, 2/10 (1972)
8. Tversky, A.: Features of similarity, *Psych. Rev.* 84 (1977) 327-352.
9. Richard, J.F. □ Les activités mentales. De l'interprétation de l'information à l'action. Armand Colin, Paris (2004)
10. Vrignaud P. □ Approche différentielle de la typicalité, Thèse de Doctorat de l'Université de Paris V (1998)
11. Godinot, N. □ Perception et catégorisation des odeurs par l'Homme, Mémoire de DEA de Neurosciences, Université C. Bernard Lyon I (1994)
12. Boisson, C. □ La dénomination des odeurs □ variations et régularités linguistiques, *Intell.* 24/1 (1997) 29-49
13. Giboreau, A., Urdapilleta, I. & Richard, J.F.: Effects of context on the description of olfactory properties. In Blackbum, P. and al. (eds.): *CONTEXT 2003 □ NAI 2680*. Springer- Verlag Berlin Heidelberg New York (2003) 154-163

## Context modelling for multimedia analysis<sup>4</sup>

Phivos Mylonas and Yannis Avrithis

Image, Video and Multimedia Laboratory,  
National Technical University of Athens  
157 73 Athens, Greece  
{fmylonas, iavr}@image.ntua.gr  
<http://www.image.ntua.gr/~fmylonas>

**Abstract.** Context is of great importance in a wide range of computing applications and has become a major topic in multimedia content search and retrieval systems. In this paper we focus our research efforts on visual context, a part of context suitable for multimedia analysis and usage. We introduce our efforts towards the scope of clarifying context in the fields of object detection and scene classification during multimedia analysis. We also present a method for visual context modelling, based on spatial object and region-based relations, to use in content-based multimedia search and retrieval systems.

### 1. Introduction

Unquestionably, the term context can take on many meanings and there is no definition that is felt to be satisfactory; the term has a long history in artificial intelligence, information retrieval and image and video analysis [1]. The use of context is especially important in applications dominated by rapid changes in the user's context, such as handheld and ubiquitous computing [4]. Researchers commonly emphasize distinctions between different types of context and illustrate how little each type has to do with the others [2].

This paper provides an integrated view on the contextual aspect exploited within multimedia systems and applications, namely the aspect of context summarized in the term *visual context*. Its efforts are directed to the fields of scene classification and object detection in multimedia analysis in the framework of aceMedia [3], which focuses on knowledge discovery embedded into media content. The notion of visual context is used as the vehicle towards the achievement of this goal, as it forms the basic framework used for the next steps of our work in multimedia analysis, namely segmentation, object detection and scene classification. In particular, in section 2, a definition for visual context utilized within the scope of multimedia content-based systems is provided, as well as novel ideas are presented regarding visual context exploitation in multimedia analysis. Section 3 tackles visual context modelling issues, whereas conclusions and future work initiatives are drawn in section 4.

---

<sup>4</sup> This work was supported by the European Commission under contract FP6-001765 aceMedia (URL: <http://www.acemedia.org>).



## 2. Visual context in multimedia analysis

Visual context forms a rather classical approach to context, tackling it from the scope of environmental or physical parameters in multimedia applications. The discussed context representation supports audiovisual information (e.g. lighting conditions, environmental information, etc) and is separately handled by visual context models. Research objectives in the field include visual context analysis, i.e. to take into account the extracted/recognized concepts during content analysis in order to find the specific context, express it in a structural description form, and use it for improving or continuing the content analysis, indexing and searching procedures, as well as personalization aspects.

By visual context in the sequel we will refer to all information related to the visual scene content of a still image or video sequence that may be useful for its analysis. Visual context is related to two problems in image analysis. *Scene classification*, which forms a top-down approach where low-level visual features are employed to globally analyse the scene content and classify it in one of a number of pre-defined categories, e.g. indoor/outdoor, city/landscape and on the other hand, *object detection/recognition*, which is a bottom-up approach that focuses on local analysis to detect and recognise specific objects in limited regions of an image, without explicit knowledge of the surrounding context, e.g. recognise a building or a tree. The above two major fields of image analysis actually comprise a chicken-and-egg problem, as, for instance, detection of a building in the middle of an image might imply a picture of a city with a high probability, whereas pre-classification of the picture as “city” would favour the recognition of a building vs. a tree.

In *content-based image search and retrieval*, more and more researchers are looking beyond low-level colour, texture, and shape features in pursuit of more effective searching methods. Natural object detection in indoor or outdoor scenes, i.e. identifying key object types such as sky, grass, foliage, water and snow, can facilitate content-based applications, ranging from image enhancement to coding or other multimedia applications. However, a significant number of misclassifications usually occur because of the similarities in colour and texture characteristics of various object types and the lack of context information, which is a major limitation of individual object detectors.

So far, none of the above methods and techniques utilize context in any form, which tends to be their main drawback, since they only examine isolated strips of pure object materials, without taking into consideration the context of the scene or individual objects. The notion of visual context is able to aid in the direction of natural object detection methodologies, simulating the human approach to similar problems. Many object materials can have the same appearance in terms of colour and texture, while the same object may have different appearances under different imaging conditions (e.g. lighting, magnification). However, one important trait of humans is that they examine all the objects in the scene before making a final decision on the identity of individual objects. The use of visual context forms the key for this unambiguous recognition process, as it refers to the relationships among the location of different objects in the scene. It may be either spatial or temporal; *spatial context* is associated to spatial relationships between objects or regions in a still image or video sequence,

while *temporal context* to temporal relationships between objects, regions or scenes in video sequences. In the sequel, discussion will be restricted to spatial context analysis.

### 3. Visual context modelling

Focusing our efforts in providing a robust context model capable of handling both local and global information in image analysis, resulted in the ascertainment that the only way to achieve this is to model the relationships between the information and not the information themselves, with respect to the level of the details present in each relationship. In this manner, at least two types of meaningful visual (spatial) contextual relationships are identified in natural images. First, relationships exist between *co-occurrence* of certain objects in natural images. For example, detection of snow with high probability would imply low grass probability. Second, relationships exist between *spatial locations* of certain objects within an image: grass tends to occur below sky, sky above snow, etc. The ultimate goal is to develop a non-scene specific method for generating spatial context models useful for general scene understanding problems. Subsequently, spatial context constraints are used to reduce the number of false positives by constraining the initial beliefs to conform to the spatial context models.

In general, spatial context modelling refers to the process of building relationship models that define the spatial arrangement and distribution of the objects of interest in a scene. Depending on the requirements of the application, the set of spatial relationships can be rich (many spatial relationships with minor differences between each) or sparse (fewer distinct relationships). The spatial relations define the absolute or relative spatial information between objects. Various spatial arrangements for two regions can be defined and the mapping of these spatial arrangements to semantic spatial relationships can also be constructed. For example, a rather complete set of spatial relationships in such an application can be modeled as: *above, far\_above, below, far\_below, beside, enclosed, enclosing*. Suitable thresholds are used to discriminate between *above/below* and *far\_above/far\_below*. Consequently, numerous relationships between two objects can be defined, such as: *Connectivity, Position, Depth, Partonomic, Size and Shape relations*.

In the case of scene classification, for instance, where information is not available in the form of objects, but in the form of regions, a top-down technique is necessary. Towards fulfilling the ultimate goal of this task, i.e., classification of images or video sequences based on their content, contextual information can be taken into advantage in the form of the spatial layout of regions in an image. For example (**Figure 1**), a class of images representing a sunny beach seaside may be described as having three perceptually salient regions: (i) a blue region representing the sea, (ii) a yellow region representing the sand and (iii) a lighter blue region representing the cloudless sky. In all cases, regions (i) and (ii) are always below region (iii), whereas in the first four, region (ii) lies below region (i) and in the fifth image, region (i) lies below region (ii); regions (i) and (ii) may exchange their spatial positions in some shots, according to the perspective used. The above example suggests that the desirable classification of a scene may remain valid as long as the relative spatial contextual interregional relationships between the image regions remain the same, even though absolute

region values may change. Again, numerous relationships between two regions in the scene can be defined, in the same manner as between objects.

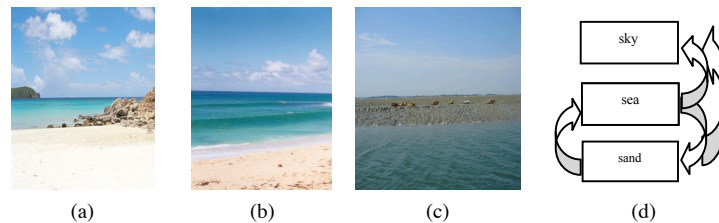

**Figure 1.** (a) – (c) Examples of images representing a sunny beach.  
(d) Interregional spatial-contextual relationships

#### 4. Conclusions and future work

This work introduced a novel type of context and context model suitable for use in image analysis and retrieval in the form of visual context. Specifically, it has introduced an approach dealing with visual context in the task of knowledge-assisted image and video analysis, adopted for use within the aceMedia system. Its efforts concluded that visual context information significantly aids in knowledge extraction, when handling scene classification and object detection problems. The latter are also gaining benefit from available visual contextual information, in order to provide information about indoor/outdoor and city/landscape scenery problems.

Finally, the herein presented effort forms a small piece of work at the beginning of a research on knowledge-assisted image/video analysis. It places itself in the process, as it relates to object identification and image classification and will be utilized in the form of driving the analysis process of our work by selecting suitable algorithms, detectors and classifiers. Future work will include all above mentioned issues, along with experimental results indicating its benefits and contributing to the overall usage of context in multimedia analysis.

#### References

1. Davis, M., Good, N., Sarvas, R.: From Context to Content: Leveraging Context for Mobile Media Metadata (2004)
2. Edmonds, B.: The Pragmatic Roots of Context, Proceedings of the 2nd International and Interdisciplinary Conference on Modeling and Using Context (CONTEXT-99). LNAI, Vol. 1688, Springer-Verlag, Berlin Heidelberg New York (1999)
3. Kompatsiaris, I., Avrithis, Y., Hobson, P., Strinzis, M.G.: Integrating Knowledge, Semantics and Content for User-Centred Intelligent Media Services: the aceMedia Project, Workshop on Image Analysis for Multimedia Interactive Services (WIAMIS'04), Lisboa, Portugal, April 21-23, 2004.
4. Weiser, M.: Some computer science issues in ubiquitous computing, Special Issue, Computer-Augmented Environments, CACM, 36/7 (1993) 74–83.

## How Irrelevant Information Influences Judgment

Georgi Petkov (gpetkov@cogs.nbu.bg)<sup>1</sup>  
 Penka Hristova (phristova@cogs.nbu.bg)<sup>1</sup>  
 Boicho Kokinov (bkokinov@nbu.bg)<sup>2</sup>

<sup>1</sup>Central and East European Center for Cognitive Science,  
 Department of Cognitive Science and Psychology,  
 New Bulgarian University, 21 Montevideo Street, Sofia 1635, Bulgaria  
<sup>2</sup>Institute of Mathematics and Informatics, Bulgarian Academy of Sciences,  
 Acad. G. Bonchev Street, bl.8, Sofia 1113, Bulgaria

**Abstract.** This paper presents JUDGE MAP2 model for judgment based on DUAL cognitive architecture. Context is considered like the content of WM that comprises both some external elements from the surrounding environment and some internal memories elicited from the LTM. The paper focuses on the mechanisms of construction of the dynamic content of the WM. In JUDGE MAP2, the mechanism responsible for building the content of the WM (e.g. context) is a spreading activation mechanism. It leads to an unusual prediction – that irrelevant dimensions take part in judgment. The data, obtained by the simulations are tested and confirmed in a psychological experiment.

### 1. Introduction

Suppose that a person has to judge the height of a particular target person. His/hers judgment will be affected from the extra knowledge about the target. If the target person were a teacher, the stimuli, which would be elicited in the WM during the process of judgment, would be prevailing teachers. Moreover, if the target is blond, more blond teachers could be retrieved from memory and hence could take part in judgment.

Most of the theories for judgment neglect such contextual characteristics of the judgment process as adding noise but not causing any systematic differences in judgment. On the contrary, we assume that *context might insure both flexibility and effectiveness* of the system by providing a number of *relevant* alternatives.

As far as DUAL architecture [4,5] was explicitly design to model context sensitivity of human cognition, it turns to be a natural groundwork for designing the model JUDGE MAP2 that describes relative judgments. DUAL takes the advantage of decentralized representations of concepts, objects and events, and parallel emergent computations. According to JUDGE MAP2, judgment is a process of *mapping* between a set of retrieved and perceived stimuli and the set of scale ratings. During this mapping, the main pressure is to keep as much as possible the order relations – higher magnitudes to receive higher ratings and vice versa. In this respect, JUDGE MAP2 is strongly interconnected with AMBR model for analogy-making, since it describes the process of judgment as involving memory (construction of the comparison set in working memory) and mapping (which is a central mechanism in analogy-making).

Existing theories that try to explain the relativism in human judgment stress on different characteristic of context and usually do not describe the process of judgment but rather its result. Part of them look at judgment as a process of *measuring the similarity/dissimilarity to a standard*. People calculate the distance between the stimulus and their “ideal points” for the target category kept in memory [1,8]. Some theories support contextually sensitive standards (adaptation level) that dynamically vary with context [2]. Others propose an online construction of such standards (norm) through contextually sensitive retrieval [3].

Another part of the theories explains judgment as a sort of classification. People classify each stimulus toward a particular subcategory for each rating of the required scale. The Range-Frequency Theory [6] proposes two principles for such classification: the range of value variation within all subcategories should be about the same, and the number of examples in all subcategories should be about the same. The ANCOR model [7] shares similar point of view. It focuses on learning of the prototypes of these subcategories, the mechanisms of their dynamic updates, and the process of classification of the target stimulus into one of them.

JUDGEMAP2 assumes a third point of view. It is based on the idea for mapping between the comparison set and the set of rating labels. Thus, the target stimulus is included in the comparison set, and the response emerges as a result of this global mapping. The mapping should satisfy as much as possible the specified (sometimes implicitly) in the instruction structural constraints – higher stimulus magnitudes should receive higher ratings, and almost equal differences between magnitudes should correspond to almost equal differences between the corresponding ratings.

JUDGEMAP2 starts to judge by constructing the so called comparison set in the WM. It comprises the target as well as some contextual stimuli perceived in the environment and also some exemplars retrieved from long-term memory (familiar or recently presented exemplars as well as generalized prototypes, if such exist in LTM). The mechanism responsible for that construction is spreading activation. The sources of activation are INPUT and GOAL nodes, i.e. the perceived target (and possibly context) stimuli and the goal to judge the stimuli on a required scale (e.g. a scale from 1 to 7). Thus the representations of the target and the scale elements become sources of activation which is then spread through the network of micro-agents. Naturally, concepts related to the representation of the target become active, e.g. various features of the target – these include both relevant and irrelevant features (of course, relevant features receive more activation than irrelevant ones).

The instance-agents that enter WM emit *markers*, which spread upward to the class hierarchy and cross in nodes, called *comparison-relations*. The latter can compare two magnitudes and are able to create new agents, responsible for the specific relation between the instances. *Correspond-relations* are another type of agents that construct *hypotheses* for mapping. Their task is to seek for local similarities in the structure of the stimuli and ratings. Number of new hypotheses for correspondence between the target stimulus and the ratings might emerge. In this way, in parallel with the other processes, a constrain satisfaction network is formed. When a certain hypothesis wins its competitors, the system is ready to give response.

## 2. Psychological Experiment

In this experiment participants rate the length of red and green lines of various sizes. The interesting question is whether the color as irrelevant characteristics of the lines will differentiate the ratings of the red and green lines of the same size.

### Method

*Design:* The experiment has a 14x2 within-subject factorial design. The independent variables are length (varying at 14 levels) and color (varying at 2 levels: green and red) of the lines. The dependent variable is the rating of the length of the lines on a 7-point-scale. The experimental question is whether there will be a main effect of color, which is supposedly an irrelevant factor in judging length.

*Material:* A set of 14 color lines has been presented horizontally against a gray background on a 17-inch monitor. The shortest line was 12 pixels; the longest one was 727 pixels and the increment was 55 pixels. Each particular line length has been shown eight times in red or green color. The short lines were predominantly green while the long ones were predominantly red. The lines with lengths 1 and 2 were presented 7 times in green and one time in red. The lines with lengths 3 and 4 - 6 times in green and two times in red and so on.

*Procedure:* The participants were tested individually in front of a computer screen where all 112 stimuli were shown sequentially and in random order. They were instructed to judge the length of each line presented on the screen on a seven-point scale: 1-“it is not long at all”, ..., 7-“it is very long”. No feedback was provided to the participants and no time restrictions have been imposed on them. The whole experiment typically lasted about 15 minutes.

*Participants:* 18 undergraduate students from the introductory classes in psychology at NBU who participated in order to satisfy a course requirement.

*Results and Discussion:* We had 14x2=28 data points for each participant. The repeated measurements analysis showed that the difference (0.046) between the mean judgment of the green lines (4.239) and the mean judgment of the red lines (4.193) is significant ( $F(1, 17)=5.966, p=0.026$ ). Because the possibility for size-illusion due to the color of the lines was excluded by an additional control experiment, we interpret this result as being in favor of our hypothesis.

## 3. Simulation

The simulation replicates the experimental design. Each line was represented with three agents – one for the agent itself, one for its length, and one for its color. The scale was represented with seven different agents, each one standing for a certain rating. The neighbor ratings was interconnected each other with associative links. All they are instances of one more general concept – ‘seven-rate-scale’. This concept stayed on INPUT during all the time. The correspond relation ‘longer<->higher rating’ was attached to GOAL during all the time. The other relations were in the long-term memory and were activated due the spreading activation. All stimuli in the set were given to the model (attaching them to INPUT node) in a random order, each line - immediately after judgment of the previous one.

*Results and Discussion:* The mean of the mean ratings of all red categories is 3.996, while the mean of the mean ratings of all green categories is 4.022, which makes a difference of 0.026 which turns out to be significant tested with ANOVA analysis ( $p=0.033$ ). The simulation confirms the experimental results. Both demonstrate a contrastive shift, according to the irrelevant dimension, and outline the size of shift.

#### 4. Conclusion

JUDGEMAP2 models a distinctive point of view about human judgment. Unlike all existing theories JUDGEMAP2 does not rely on direct comparisons between the target stimulus and the current context but rather it includes the target stimulus into the set of relevant exemplars and establishes mapping between this set and the set of scale elements. Both retrieval and mapping are dynamic processes that depend on current context and thus are able dynamically to modulate the output of the system. Unlike all other models JUDGEMAP does not ignore the irrelevant features of the targets but rather use them in the retrieval of useful information. This is part from the spreading activation mechanism that determines the information that is relevant to the current task and the surrounding environment.

JUDGEMAP2 like Norm Theory underlie the need for active, contextually sensitive construction of the so-called comparison set. Like computational model, however, JUDGEMAP2 provides an opportunity for testing this idea.

JUDGEMAP2 makes a strange prediction that the color of the target line may play a role in the rating of its length and thus predicts a shift of the mean rating (although a small one) with the change of color. This prediction has been tested in a psychological experiment and has been confirmed.

#### References

1. Coombs, C.: A Theory of Data. Wiley, New York (1964)
2. Helson, H.: Adaptation-Level Theory: An Experimental and Systematic Approach to Behavior. Harper and Row, New York (1964)
3. Kahneman, D., Miller, D.: Norm Theory: Comparing Reality to Its Alternatives. *Psychological Review*. 93 (2) (1986) 136-153
4. Kokinov, B.: The DUAL cognitive architecture: A hybrid multi-agent approach. Proceedings of the Eleventh European Conference of Artificial Intelligence. John Wiley & Sons, Ltd, London (1994)
5. Kokinov, B.: The context-sensitive cognitive architecture DUAL. Proceedings of the Sixteenth Annual Conference of the Cognitive Science Society. Hillsdale, NJ: Lawrence Erlbaum Associates (1994)
6. Parducci, A.: Category Judgment: A Range-Frequency Model. *Psychological Review*, 72 (6) (1965) 407-418
7. Petrov, A., Anderson, J.: ANCHOR: A Memory-Based Model of Category Rating. In: Gleitman, L., Joshi, A. (Eds.): Proceedings of the 22nd Annual Conference of the Cognitive Science Society. Hillsdale, NJ: Erlbaum (2000)
8. Wedell, D., Pettibone, J.: Preference and the Contextual Basis of Ideals in Judgment and Choice. *Journal of Experimental Psychology: General*, 128 (1999) 346-361

## Perceptive-Literary Construction of the Body in Clinical Psychology

Alfonso Santarpia<sup>1</sup>, Alain Blanchet<sup>1</sup>, Riccardo Venturini<sup>2</sup>, Michele Cavallo<sup>3</sup>

<sup>1</sup> Equipe de Recherche en Psychologie Clinique. University Paris VIII,  
93526 Saint-Denis Cedex 02, Paris, France.

[asantarpia@yahoo.it](mailto:asantarpia@yahoo.it), [www.lesmetaphoresducorps.net](http://www.lesmetaphoresducorps.net)

<sup>2</sup> University *La Sapienza di Roma*, Cattedra di Psicofisiologia clinica, Facoltà di Psicologia,  
via dei Marsi 78, 00185, Roma, Italie.

<sup>3</sup> University *La Sapienza di Roma*, Piazzale Aldo Moro 5, 00185, Facoltà di Scienze  
Umanistiche, Arti e Scienze dello spettacolo, Roma, Italie.

**Abstract.** Firstly, the objective of our study is to organize these conceptualizations into categories of conceptual metaphors based on a model inspired by the research of Lakoff and Johnson. Secondly, the objective of our study is to identify different types of bodily metaphors on various organs and bodily substances expressed in psychoanalytic and psychiatric practice and in poetic works selected. We wanted to understand the distribution of these metaphors. The analysis of psychiatric and psychoanalytic manuals and works of poetic literature show differences in the use of conceptual metaphors in these respective discourses. Our categorization provides an alternative to the anatomical description of the body; we call this alternative a *perceptive-literary construction of the body*.

### 1. Introduction

In the field of clinical psychology and psychotherapeutic techniques, patient and therapist utterances frequently include linguistic metaphors of the body: a) *Variable-induction relaxation* [1] is based on therapeutic suggestions concerning sensations and images. b) *La décentration* [2] is based on figurative utterances about the body. During his or her initial instructions, the therapists says, “*Imagine that you are at the tips of your toes; imagine that you are a small bubble and that, starting at your toes, you’re going to slowly move up inside your body*”. c) *Ericksonian hypnosis*, is characterized in part by the use of indirect suggestions based on linguistic metaphors of the body [3]. Firstly, the objective of our study is to organize these conceptualizations into categories of conceptual metaphors based on a model inspired by the research of Lakoff and Johnson [4]. Secondly, the objective of our study is to identify different types of bodily metaphors on various organs and bodily substances expressed in psychoanalytic and psychiatric practice and in poetic works selected. We have found [5]: - 7 main categories of conceptual metaphors; BODY-CONTAINER, BODY-SUBSTANTIAL, BODY-BIOLOGICAL, BODY-METONYMICAL, BODY-METAMORPHIC, BODY-DIVINE, BODY-ABSTRACT. - 1 simple



*subcategories* (without visual mental imagery); Body-Spatiality - 9 *complex subcategory* (first-degree and second-degree visual mental imagery) [6]; Metaphors of objects with container functions, Body-Architectonic, Body-Animal, Body-Plants, Body-Element, Body-Object, Body-Natural Clothing, Body-Supernatural, Body-Sacred object. Our categorization provides an alternative to the anatomical description of the body; we call this alternative a *perceptive-literary construction of the body* [5]. It is characterized by a bodily narrative based on figurative utterances concerning anatomical and physiological features and conceptual metaphors of reference.

## 2. Methodology

We chose Italian poetic literature, which frequently refers to the body. We selected anthologized poets from various historical periods as our representative sample. To ensure that clinical psychopathology was represented, we included professional manuals and classic works (Italian and French). We searched for 178 words and their occurrence in manuals and poetic works regarding the concept of corporality and the symbolic parts of the body: *body, bodies, corporal, limb(s), flesh, incorporation, somatic, vaginal, oral, genital, penis, penises, phallus, clitoris, vagina, uterus, organ(s), organic, organism(s), physical, conversion, excitement, anus(es), anal, capillaries, arteries, libido, libidinal, muscles, skin, mouth(s), blood, head, face(s), foot/feet, heart(s), hand(s), ear(s), hair, body hair, nipple(s), lip(s), labial, eye, eyes, excrement, feces, fecal matter, urine, saliva, sperm, orifice(s), tear(s), nose(s), vein(s), forehead(s)/brow(s), sigh(s), tongue(s), eyelash(es), stomach(s), tooth/teeth, finger(s), nail(s), breast(s), neck(s), arm(s), skeleton(s), chest(s), throat(s), liver(s), cheek(s), shoulder(s), beard(s), knee(s), leg(s), side(s), kidney(s), lung(s), back(s), intestine(s), intestinal, calf/calves, back of knee, ankle(s), abdomen*. We also looked for the verbs, *incorporate* and *embody*, and their various forms. *Research corpus for poetry*: nine poets (one poet representing each century); overall, we searched nine works of Italian poetry (579,469 words) from the years 1200 to 2000 using LIZ 3.0 software with textual analysis capabilities [7]. *Research corpus for psychoanalysis*: Sections entitled “anorexia nervosa” or “eating disorders”<sup>5</sup> in the most recent manual of Italian psychoanalysis (8,640 words) [8]; one traditional French psychoanalytic glossary (195,320 words) [9]; and one French thematic index (760,480 words) of Freud’s works [10]. *Research corpus for psychiatry*: one well-known Italian manual of psychiatry and psychotherapy [11]; sections entitled “anorexia nervosa” or “eating disorders” in five psychiatric manuals (51,840 words) [12-16]; and the entire corpus (563,953 words) of DSM-IV [17].

---

<sup>5</sup> This psychiatric category, characterized by a difficult relationship between the body and its basic needs, can evoke different linguistic metaphors of the body.

### 3. Results

Table 1. Frequency and categories of conceptual metaphors of the body

<i>Catégories</i>	<b>Psychoanalysis</b>	<b>Psychiatry</b>	<b>Poetry</b>
B-Container	f 81; 23typ (12a, 11b)	f 40; 10typ (10a)	f 384; 31typ (25a, 6b)
B-Substantial	f 123; 76typ (12a, 60b, 4c)	f 3; 2typ (1a, 1b)	f 121; 95typ (51a, 44b)
B-Biological	f 29; 14typ (1a, 13b)	0	f 28; 25typ (6a, 12b, 7c)
B-Metonymical	f 37; 10typ (10a)	0	f 35; 16typ (16a)
B-Metamorphic	f 58; 11typ (7a, 4b)	0	f 40, 29typ (6a, 18b, 5c)
B-Divine	f 7; 7typ (7a)	f 2; 1typ (1a)	f 10; 9typ (4a, 4b, 1c)
B-Abstract	f 190; 67typ (67a)	f 8; 5typ (5a)	f 80; 65typ (65a)

Table 2. Frequency and types of metaphors focus on various organs and bodily substances

<i>Organs</i>	<b>Psychoanalysis</b>	<b>Psychiatry</b>	<b>Poetry</b>
generic   body	f 188; 79typ (59a, 20 b)	f 52, 10typ (9a, 1b)	f 176; 55 typ (22a, 30b, 3c)
vagina	f 62; 31typ (7a, 23b, 1c)	0	0
genital organs	f 26; 11typ (6a, 5b)	0	0
mouth	f 39; 10typ (10a)	0	f 27; 3typ (2a, 1b)
bodily orifice	f 11; 8typ (6a, 2b)	0	0
uterus	f 10; 4typ (4b)	0	0
penis	f 91; 43typ (16a, 24b, 3c)	0	0
phallus	f 23; 6typ (5a, 1b)	0	0
anus	f 38; 7typ (7a)	0	0

Table 3. Frequency and types of metaphors focus on various organs and bodily substances

<i>Organs</i>	<b>Psychoanalysis</b>	<b>Psychiatry</b>	<b>Poetry</b>
blood	0	0	f 19; 10 typ (7a, 3b)
chest	0	0	f 21; 5 typ (4a, 1b)
eye/s	0	0	f 39; 25typ (13a, 12b)
breast/s	f 1; 1typ (1a)	0	f 14; 5typ (5a)
face	0	0	f 47; 7typ (3a, 3b, 1c)
head	0	f 1; 1typ (1a)	f 16; 4typ (2a, 2b)
heart	0	0	f 158; 58typ (41a, 14b, 3c)
skin	0	0	f 11; 8typ (6a, 1b, 1c)
hand/s	f 1; 1typ (1a)	0	f 87; 5typ (4a, 1b)
tongue	0	0	f 15; 14typ (14a)
flesh	0	0	f 21; 14typ (9a, 5b)

#### 4. Discussion and conclusion

In psychiatric manuals, the conceptualization of the body centers on the idea of the BODY AS CONTAINER, with neither stereotyped mental images nor specific mental images about body organs. In psychoanalysis, linguistic metaphors of the body focus on the following terms: *genital organs, mouth, uterus, penis, phallus, anus, vagina, and body orifice*. Linguistic metaphors of the body in the selected works of poetic literature tend to conceptualize the body as an integrated system of experiences. These metaphors focus on various organs and bodily substances, such as *heart, blood, chest, eye(s), breast(s), face, head, flesh, skin, hand(s) and tongue*. Poetry offers us the opportunity to create, deepen and reconstruct emotional experiences through the richness of metaphorical thought. Poetic thought could serve as an important resource in the conceptualization of the body.

#### References

1. Sapir, M.: La relaxation à inductions variables. La Pensée sauvage, Grenoble (1993)
2. Virel, A., Lambert, J., Dorkel, O.: LA DECENTRATION. Colloque International de Relaxation de l'I.F.E.R.T. Tome I. L'Harmattan, Paris (1987)
3. Erickson, M., Rossi, E., Rossi, S.: Tecniche di Suggestione Ipnologica. Astrolabio, Roma (1979)
4. Lakoff G.: The Contemporary Theory of Metaphor. In: Ortony, A., (Ed.): 2°ed. Metaphor and Thought. Cambridge University Press, Cambridge (1993) 202-251
5. Santarpia, A., Blanchet, A., Venturini, R., Cavallo, M., Reynaud, S.: La catégorisation des métaphores conceptuelles du corps. Annales Medico-Psychologiques (in press)
6. Mervis, C., Rosch, E.: Categorization of Natural Objects. Annual Review of Psychology 32 (1981) 89-115
7. Letteratura Italiana Zanichelli in 6 CD-ROM. Zanichelli, Bologna (1999)
8. Semi, A.: Trattato di Psicoanalisi. Vol. 1-2. Raffaele Cortina Editore, Milano (1988)
9. Laplanche, J., Pontalis, J.: Vocabulaire de la Psychanalyse. 2° éd. Presses Universitaires de France, Paris (1998)
10. Delrieu, A.: Sigmund Freud Index Thématique. Anthropos 2° ed., Paris (2001)
11. Lalli, N.: Manuale di Psichiatria e Psicoterapia. Liguori Editore, Napoli (1991)
12. Brusset, B.: Encyclopédie Médico-Chirurgicale. Valeur sémiologique des anomalies des conduites alimentaires. Psychiatrie. Elsevier, Paris (1987) 37-144-A: 4
13. Vindreau, C., Hardy, P.: Encyclopédie Médico-Chirurgicale. Les conduites boulimiques. Psychiatrie. Elsevier, Paris (1981) 37-105- D-10: 5-6
14. Gabbard, G.: Psichiatria Psicodinamica. Raffaele Cortina Editore, Milano (1995)
15. Lebovici, S., Diatkine, R., Soulè, M.: Trattato di Psichiatria dell'infanzia e dell'adolescenza. Vol. 2 Borla, Roma (1990)
16. Trattato Italiano di Psichiatria.: Vol. 1, 2, 3. Masson, Milano-Parigi-Bonn (1992)
17. DSM-IV.: Trad.it. Masson, Milano (1995)

## Acquiring and representing user's practices by contextual graphs

Benci, P., Brézillon, P., Guittard, G. Potier, D.

pierre.benci@wanadoo.fr  
Patrick.Brezillon@lip6.fr  
guittardgaelle@free.fr  
Damien.Potier@etu.upmc.fr

**Abstract.** Enterprises develop procedures to address focuses in any case. However, actors develop practices to address a focus in a given context. Practice modeling is a difficult task because there are as many practices as contexts of occurrence. Contextual-graph formalism proposes a way to deal practically with practices by representing at the same level elements of reasoning and contextual elements. An important consequence is the natural integration of the incremental acquisition of knowledge, the learning and explanation of practices. The use of contextual graphs is discussed on applications in several domains. **Keywords.** Procedures, Practices. Contextual Knowledge, user modeling, contextual graph.

### Extended abstract

Contextual graphs are used in several domains such as medicine, ergonomics, psychology, army, information retrieval, computer security, road safety, etc. The common factor is that reasoning is described by procedures established by the enterprise but adapted by actors that take into account the context in which they have to deal with the procedures. Practices thus developed are contextualizations of the procedures. A practice corresponds to a practical reasoning, which is not a logical and theoretical reasoning for which the action leads to a conclusion. The practical reasoning has more a status of inductive probabilistic reasoning: the conclusion cannot be detached (i.e. take a meaning) from the premises.

Thus, the modeling of actors' reasoning is a difficult task because they use a number of contextual elements. These pieces of knowledge, which are not necessarily expressed, result in more or less proceduralized actions that are compiled in comprehensive knowledge about actions.

If it is relatively easy to model procedures, the modeling of practices is not an easy task because they are as many practices as contexts of occurrence of a given focus. Moreover, procedures cannot catch the high interaction between the task at hand and the related tasks that are generated by the task itself.

A contextual graph is a context-based representation of a task execution. Contextual graphs are oriented without circuits, with exactly one input and one output, and a

general structure of spindle. A path (from the input to the output of the graph) represents a practice (or a procedure), a type of execution of the task with the application of selected methods.

Elements of a contextual graph are: actions, contextual elements, sub-graphs, activities and parallel action groupings.

- An **action** is the building block of contextual graphs. We call it an action but it would be better to consider as an elementary task.
- A **contextual element** is a couple of nodes, a contextual node and a recombination node; A contextual node has one input and N outputs (branches) corresponding to N instantiations of the contextual element already considered. The recombination node is [N, 1] and shows that once the part of the practice on the branch between the contextual and recombination nodes has been executed, it does not matter to know this instantiation.
- A **sub-graph** is itself a contextual graph. They are mainly used for obtaining different displays of the contextual graph on the graphical interface by some mechanisms of aggregation and expansion.
- An **activity** is a particular sub-graph (and thus also a contextual graph by itself) that is identified by actors because appearing in several contextual graphs. This recurring sub-structure is generally considered as a complex action.
- A **parallel action grouping** expresses the fact (and reduce the complexity of the representation) that several groups of actions must be accomplished but that the order in which action groups must be considered is not important, or even could be done in parallel, but all actions must be accomplished before to continue.

Example: Exploration of a link target

Contextual element	
CE3	Is the page interesting?
CE4	Are there figures to retrieve?
CE8	Duration of the download?
CE9	Explore the whole site?
CE11	Is the whole page interesting?
CE12	Which type of search is it?

Action	Definition
A5	Close the window
A6	Save the page at the html format
A7	Copy and paste the text in a Word document
A13	Search where are keywords in the page
A14	Go the home page of the site

A15	Go to the next slide
A16	Look for new stuffs
A17	Select the interesting part of the text on the page
A18	Look for searched item (e.g. reference of a read paper)
A20	Select the text of the whole page

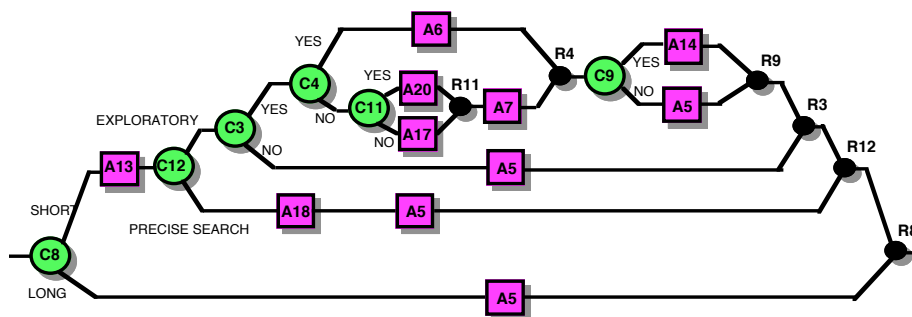

## References

Brézillon, P.: Task-realization models in Contextual Graphs. Modeling and Using Context (CONTEXT-05), Dey, A., Kokinov, B., Leake, D., Turner, R. (Eds.), Springer Verlag, LNCS (To appear) (2005)

Brézillon, P.: Representation of procedures and practices in contextual graphs. The Knowledge Engineering Review, 18/2 (2003) 147-174

Brézillon, P.: Focusing on context in human-centered computing IEEE Intelligent Systems, 18/3 (2003)62-66

## Towards rich context virtual worlds

Mehdi El Jed, Bernard Pavard, and Nico Pallamin.

IRIT-GRIC

Groupe de Recherche en Ingénierie Cognitive,  
118 route de Narbonne, 31062 Toulouse Cedex.

{eljed, pavard, pallamin}@irit.fr  
<http://www.irit.fr/GRIC/VR/>

### 1. Introduction

The aim of this demo is to present a software platform that allows multi user cooperation in a virtual world. This platform has been used to train professional people to interact in complex cooperative environments (firemen, control room, etc.). Our approach provides the user with ‘rich’ contextual information immersing him in a ‘situated’ interaction (cognitive, social and cultural).

As in a multi-user video game, virtual characters (avatars) are animated by ‘real’ humans but their gestures, facial expressions and emotional behaviours are generated by an emotional and social model. This model tries to identify the right context of the interaction according to the user’s decisions to animate the avatar (ex: walk, speak, etc.) and produce the most meaningful social interaction (ex: gaze direction towards others avatars, gesture related to speech production, etc.). The user is thus supposed to be “cognitively and socially situated” in his interaction with others actors (cf. Figure1).



**Fig. 1.** Overview of virtual interaction between several avatars in the virtual world. Rich context simulation is expected to generate reflexive behavior between users as in a real situation.

Our strategy is twofold. On one side, we allow users to build up their context by themselves taking into account all their social and cultural knowledge. On the other

side, we designed our game engine in order to generate avatar animations according to the context of the situation.

## 2. Situated virtual interaction

From a pragmatic point of view, the aim of this application is to develop a game engine able to reproduce a close to reality human-to-human interaction in a virtual space. As our final goal is to use this game engine to train professional people to interact in a complex cooperative world (firemen, control room, etc.), we have emphasised the fact that gestures as well as body movements and emotional expressions are cognitively, socially and culturally meaningful for the accomplishment of the task (what we called situated virtual interaction).

### **Indexicality and reflexivity in human communication**

Indexicality and reflexivity of human behaviour are two important dimensions of situated virtual interaction: they contribute to the realism of the interactions and to the immersion of the user in the virtual world.

- **Indexicality:** This concept refers to the fact that human language, to be understood, is strongly dependant on the context of the situation. Indeed, the meaning given by a user to a linguistic expression is often related to several contextual elements such as the identity of the speaker, the form of the statement, the intonation of the voice, etc. Removing these contextual elements may drastically limit the comprehension of the expression and the attribution of a precise meaning to the interaction. Deictic (gestures with reference to external objects in the environment) are good examples of non verbal indexical behaviour and are permanently used by speakers in order to structure their discourse and to refer to a particular context.
- **Reflexivity:** This concept is based on the idea that any human action will modify the environment and then the context shared by all actors. Reflexively, this modified context will change the decision process for all other users. It is the dynamicity of this endless feedback loop between action and shared context that is supposed to give social consistency to human interaction (as it is stated in the situated cognitive paradigm). As the situation changes, all actors (avatars in co-presence and objects) take into account these changes and modify their own behaviour. As consequence, interaction between users gives place to an always different comprehension of the situation since each one operates according to its personal experience. Indeed, the interpretation of a particular action is dependant on the culture, beliefs or the assumptions of each social actor.

### **Emotional and social model**

The feeling of presence in a virtual environment is supposed to arise only if the emotional and social dimensions are taken into account. For that, we propose to enrich the avatar behaviour by an emotional and social model. By expressing emotional and social abilities, the avatar will be able to produce on the user a better feeling of social and cultural immersion. For this purpose, we developed an emotional model (El Jed et al., 2004) to evaluate and update the emotional states of each avatar (emotions, stress and mood) according to its interpretation of the virtual world events.



A behavioural model for the social interaction was also developed for the selection of the most adapted gestures and body expressions according to the decisions taken by the user.

In the next section, we present an overview of our model of context perception. This model tries to identify the context of the situation to produce a social and emotional behaviour on the avatar. Finally, we discuss in section 4 our approach to model context and its role in the construction of situated virtual interaction in virtual worlds.

### 3. Context perception

In our model we make a distinction between the context of the user and the one of the avatar. The user's context is defined as all contextual elements of the situation which let the user make a decision and modify the virtual world. These elements can be implicit (beliefs, assumptions, practices, etc.) or explicit (types of the objects, localizations, emotional states, etc).

Avatar context refers to all information accessible in the virtual world that can be used by the software (our model) to produce a non intentional action (complementary to the user intentional action). Unfortunately, these two kinds of context cannot be matched. Many implicit contextual elements relevant to cognitive mechanisms cannot be identified by the software (like user's intention). To avoid this difficulty, we will only focus on the explicit contextual elements (observable ones) to represent the avatar context (cf Figure 2). Although this solution is a simplification of the user's context, we think that such representation is still rich enough to catch the contextual elements necessary to allow the avatar to produce meaningful body expressions (gestures, facial expressions, etc) adapted to the situation.

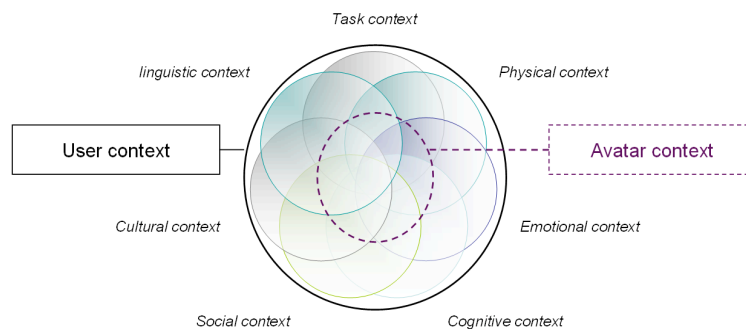

**Fig. 2.** User context versus avatar context

In order to produce meaningful gestures, our model tries to identify the context of the situation which is (at best) a subset of the real user's context. The contextual elements making possible to constitute the avatar context change from a situation to another. To produce a meaningful behaviour, an avatar considers different contextual elements according to its current situation (for example the elements relevant during a dialogue between several actors are different from the ones relevant when taking care of a

victim). The context so constructed strongly depends on the situation (what we call in our model the task context). The avatar context is constituted by various elements chosen according to their relevance to the task context.

In our model, we define a set of task contexts (situations) that happen in the scenario and the relative contextual elements to be identified. Although the contextual elements characterizing a given situation are predefined, the human user is still able to catch other contextual elements in the environment (in particular the implicit ones) and to exploit them for the decision-making.

As an example, an avatar during a dialogue, identifies its context of communication with 3 interlocutors and decides to distribute alternatively his gaze between his listeners. The meaning of the discussion is not taken into account by the avatar in the construction of its context but the user remains free to control his avatar according to the meaning of the dialogue. He can thus intervene on his avatar to look towards a direction indicated in the discourse or fix gaze on a particular listener.

Such action will have a double consequence: First, the other avatars will simply update their context taking into account the performed action to produce a consistent response (looking towards the pointed direction). Second, the others users will use this gesture as a supplementary cue to get a better interpretation of the situation.

#### **4. Discussion**

In this research, our aim is to reproduce close to reality social interaction and to minimise the fact that context in real situations is often too rich to be listed or predetermined (even inside a very specific scenario). It is well-known that contextual dependence phenomena is difficult if not impossible to formalise in close to reality situation due to the richness of all possible indexical references as well as the reflexivity between actions and context modification.

This difficulty was mainly due to the fact that traditional AI as well as cognitive sciences are based on a representational paradigm. We tried to escape this paradigm putting the users in open and rich virtual worlds. The game engine we designed in order to produce socially and emotionally meaningful gestures had nevertheless to identify the right context (related to the task, personality of the user, social status of interacting characters, etc.). At this point, we were not able to fully avoid the qualification problem because our model tries to simplify the context by categorising the situation (based on the nature of the scenario, the different phases of the task, etc).

With this approach we tried to identify the context from a combination of parameters. Thus, gestures as well as emotional behaviour calculated from our model may induce wrong reflexive interactions between users. Nevertheless, users may also adjust their own behaviour in order to produce coherent and meaningful interactions. At this point of the research, we cannot give answers to this question because we need more experiments in order to analyse if such regulation mechanism arise. Future multi-users sessions with professional actors (firemen) will probably give more insight on this point.

## References

El Jed, M., Pallamin, N., Dugdale, J., Pavard, B. (2004) "Modelling character emotion in an interactive virtual environment". In proceedings of AISB 2004 Symposium: Motion, Emotion and Cognition. 29 March – 1 April 2004, Leeds, UK.

# A Mobile Context Reactive Natural Language User Interface

Babak Hodjat, Siamak Hodjat, Nick Treadgold

iAnywhere Solutions  
{bhodjat, shodjat, ntreadgold}@iAnywhere.com

**Abstract.** The user interfaces for mobile devices generally have space and entry restrictions, which limit usability of mobile applications. The Context Reactive User Experience (CRUSE) is a framework enabling delivery of applications and services to mobile users in a usable form. At any given time CRUSE takes available context, user preferences and user behavior to present options that have the most likelihood of being selected. Such a prediction cannot be foolproof at all times therefore it is augmented by a natural language text box.

## Introduction

The relatively small form factor and entry limitations of mobile devices call for a different approach to user interface design. The most successful mobile device operating systems have been the ones that have managed to integrate more applications and services better. There are, however, many more applications that are not yet popular and in wide use on mobile devices in spite of their availability (e.g., Location Based Services, infotainment, enterprise applications). This is due, in large part, to lack of access to a relevant function in one application from a certain point in the other.

There is a wealth of contextual clues available for a mobile user interface, which may be used to enhance the user experience, including user's location, time, and personal profile (e.g., calendar, contacts, credit and Permissions [6]).

Any effective mobile user interface will have to take such contextual elements into account in order to optimize and enhance the user experience. There is, however, a balance to be struck between taking control away from the user, always predicting the user's next step, and presenting the user with all the available options to choose from. In this paper, we present a mobile user interface paradigm that can achieve such a balance.

Context awareness is a topic explored both in Natural Language Processing (NLP) [1][5], and in Human Computer Interaction (HCI) research [2][7][3].

## A Unified NL and GUI Framework

The Context Reactive User Experience (CRUSE) is a user interface framework enabling the delivery of applications and services to mobile users in a usable form. The fundamental idea behind CRUSE is: If you see it, click it. If you don't, ask for it. At any given time CRUSE takes available context, user preferences and user behavior to present options that have the most likelihood of being selected by the user. Such a prediction cannot be foolproof at all times, and therefore it is augmented by a natural language text box which allows the user to express their intended functionality from the system in their own words.

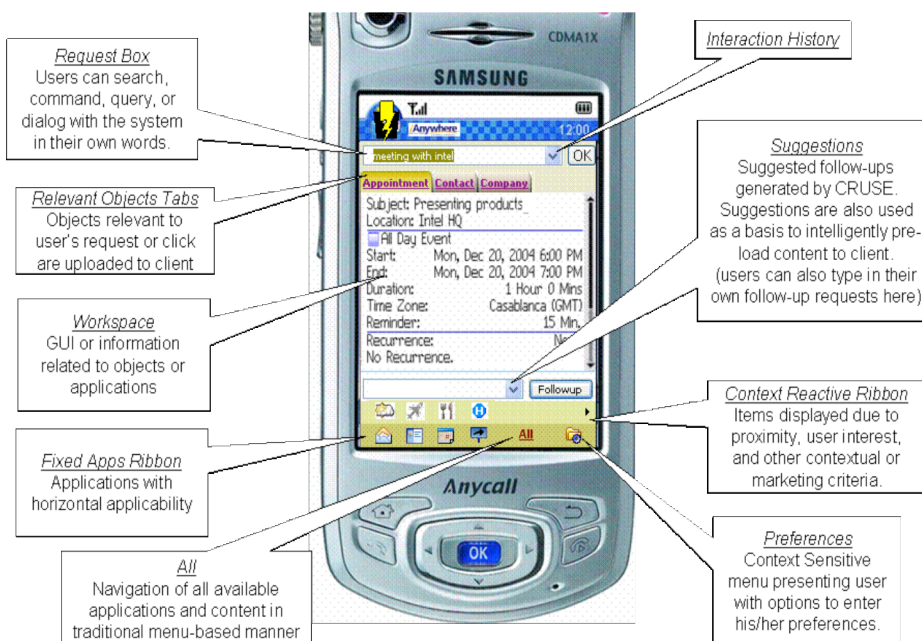

**Fig. 3.** The CRUSE Layout.

The CRUSE layout is comprised of 6 different sections (see Figure 1):

**Request Box:** For natural language requests as well as other expressions such as web site URLs or keyword searches.

**Tabs:** The main topic of interest is displayed in the main tab. The other tabs are objects directly related to the user query or click.

**Suggestions drop-down:** CRUSE generates a number of relevant possible next steps based on the dialog history and topic of interest. (see Figure 2).

**Context Reactive Ribbon:** At any given point in time, applications and content ranked most relevant are presentation in the context ribbon.

**Fixed Ribbon:** Applications that are useful in most situations are accessible from the fixed ribbon.

**Preferences:** Serves as a repository of user preferences acquired explicitly from the user through interactions and dialogs, or implicitly through user behavior.

## CRUSE Architecture

CRUSE drives both GUI and NLI dialogs intermittently, and. CRUSE is built using the Adaptive Agent-Oriented Software Architecture (AAOSA) [4], which captures the semantic relationships as well as contextual relevance of different topics in its application model.

In AAOSA an agent processes requests directly, or by combining its processing with results produced by other agents. Agents are wired in a network, which defines the communication paths between agents (Figure 3).

The AAOSA agent network operates by passing requests from agent to agent. A request begins at the root of the hierarchy and flows

down to other agents. Agents examine the request and decide for themselves (i.e., claim) whether they have anything to contribute. Responses flow back upchain using the same message paths as the request.

In the case of CRUSE, other than the text input from the request box, which is entered into the agent network for interpretation, clicks on icons are also mapped into textual natural language commands and submitted to the agent network. Thus agents are able to keep track of the history of a dialog, explain the chain of requests that led to a particular behavior, and remember certain “slots” filled by users as the dialog progresses.

Agents make claims on contextual events as well. For instance, slots can be filled by default based on the current location of the user, or entries in the user’s calendar.

In AAOSA, suggestions are pieces of information that have an association with the action taken by the user. Suggestions are derived from the inter-agent relationships in the agent network. For example a suggestion is given when the user requests a command on an object, and gives a list of all other commands that can be applied to that object, and all commands that can be applied to relevant objects. Relevant command and object suggestions directly related to the tab object are placed in the suggestions drop-down for that tab, and all objects in the same group as the tab’s object are placed in the context reactive ribbon for that tab.

## Conclusions

Preliminary user studies on a CRUSE prototype that includes 20 applications and content sources have been encouraging. Test subjects perceived CRUSE as being

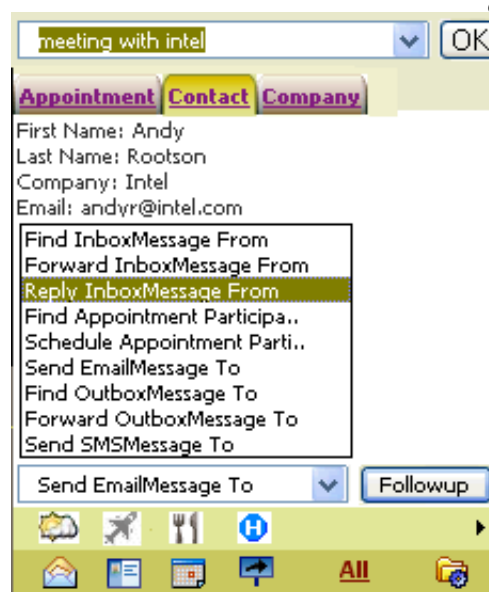
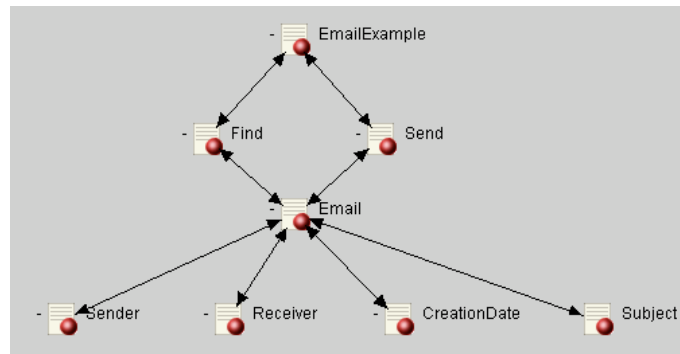

Fig. 4. The suggestions drop-down after user query “meeting with intel”.

faster, more efficient, easier to use, and more helpful than existing interfaces. CRUSE faired better in all categories tested and measured.

For future work, we are currently looking into adding automatic rank ordering of suggestions based on usage his-tory through reinforcement learning.



**Fig. 5.** An example AAOSA agent network

## References

1. Barros, F.A., DeRoeck, A.: Resolving anaphora in a portable natural language front end to databases, in Proceedings of the fourth conference on Applied natural language processing, ACM Press, Stuttgart, Germany (1994) 119-124
2. Bohnenberger, T., Jameson, A., Krüger, A., Butz, A.: Location-Aware Shopping Assistance: Evaluation of a Decision-Theoretic Approach, Proceedings of the Fourth International Symposium on Human Computer Interaction with Mobile Devices (Mobile-HCI-02), Pisa, Italy (2002)
3. Hertzog, P., Torrens, M.: Short Papers: Context-aware mobile assistants for optimal interaction: a prototype for supporting the business traveler, in Proceedings of the 9th international conference on Intelligent user interface, ACM Press, (2004) 256-258
4. Hodjat, B., Amamiya, M.: Introducing the Adaptive Agent Oriented Software Architecture and its Application in Natural Language User Interfaces, Proceedings of the first workshop on Agent Oriented Software Engineering (AOSE) (2000) 194-205, also published in a book by the same name by Springer-Verlag LNCS (2001) 285-306
5. Lambert, L., Carberry, S.: Discourse and dialogue: Using linguistic, world, and contextual knowledge in a plan recognition model of dialogue, in Proceedings of the 14th conference on Computational linguistics, Vol. 1, ACM Press (1992) 310-316
6. Shelfer, K.M., Procaccino, J.D.: Evolution of the Smart Card, Communications of the ACM, Volume 45(7) (2002)
7. Wen, J., Lao, N., Ma, W.: Probabilistic model for contextual retrieval, in Proceedings of the 27th annual international conference on Research and development in information retrieval, Sheffield, United Kingdom (2004) 57 – 63

# Proactive Context-aware Service Provisioning for a Marine Community

Oriana Riva<sup>1</sup>, Tapio Pitkäranta<sup>2</sup>, and Santtu Toivonen<sup>2</sup>

<sup>1</sup> Helsinki Institute for Information Technology  
P.O. Box 9800, FIN-02015 HUT, Finland  
oriana.riva@hiit.fi

<sup>2</sup> VTT Technical Research Centre of Finland  
P.O. Box 1203, FIN-02044 VTT, Finland  
{tapio.pitkaranta, **santtu.toivoneng**}@vtt.fi

**Abstract.** Our work demonstrates how proactive context-aware service provisioning has been deployed in the DYNAMOS System to address the needs of typical recreational boaters. We show by means of several usage scenarios how our system constantly provides mobile users with services that fit them in their current context. Furthermore, the system enables users to create and to share with peers user-generated content of different types and for different purposes.

## 1. Introduction

Context-aware service provisioning aims to make the service provisioning model centered on user needs, current context, and resources [1]. Specifically, mobile users go through several contextual changes as they move around the physical and social surroundings and those contextual changes can be effectively exploited in the task of service selection, provision, and presentation. Nevertheless, typically the service content comes from commercial content providers such as institutions and organizations. This makes the content officially expressed, serious impersonal, and utility-oriented. The service space easily becomes static and out of date because updating information implies a cost and is time consuming. As opposite, the information space should let be free to expand and reflect the lives, concerns, and social reality of the users in that space [2]. In response to these observations, we have designed and implemented the DYNAMOS System<sup>6</sup> aimed to proactively provide recreational boaters with services that are relevant to their current context and profile. In addition, users can also generate and share content not directly supplied by service providers.

---

<sup>6</sup> Dynamic Composition and Sharing of Context-Aware Mobile Services. URL: <http://www.vtt.fi/te/proj/dynamos/>.



## 2. DYNAMOS System Overview

In the DYNAMOS System, users are characterized by profile and context information. Profile includes personal information (e.g., name, profession, age, address) and preferences (e.g., interests). Context consists of several context items. Each context item is either provided by context providers, which exploit sensors and external services to collect context information, or manually entered by the user. Specifically, context consists of many aspects such as user activity and behaviour; location-related information such as physical coordinates, speed, and direction of movement; environmental and social situation.

Content available in the DYNAMOS System is offered to the user after being matched with user context and profile information. This content can be of three different types: service descriptions, service annotations, and user notes.

Service providers supply original *service descriptions*. Service descriptions capture the most essential semantics of the services. The services are categorized according to their business branches. Additionally, a textual description of the service characteristics, along with location, opening times, and contact information are given.

Users can access services and attach to them *service annotations*. A service annotation consists of text (e.g., “50% discount on gasoline”), a rating for the service, the signature of the author (e.g., “Pekka, Turku sailor”), the location where the annotation is created, the time, and finally one or multiple recipients to whom the annotation is directed.

In addition to annotating services and sharing annotations with each other, users can generate and share other content, namely *user notes*. This type of content does not refer to any specific service description. User notes are pieces of digital information attached by users to the environment and later accessed by other peers. For instance, users can create public notes in the form of warning messages (e.g., “On NE wind, be careful on this narrow passage and watch out for the shoals on SW shore”) to notify other users of accidental situations that occur in a certain location and time. In a marine setting, such messages can be sorted as emergency, urgency, safety, and routine events. Along with the carried information and the category to which the message belongs, a user note contains the signature of the author, location and time of creation, and the designated recipient(s).

## 3. System Implementation

The DYNAMOS System has been implemented in Java. The overall architecture consists of Clients, Content Servers, and Distribution Servers. The client can be a regular Web browser or a stand-alone application. The current web interface is designed for devices with large screens, while for mobile users often equipped with devices of limited capabilities, we have implemented a prototype application using J2ME Mobile Information Device Profile 2.0 (MIDP2). This application constantly notifies the system about relevant context changes. The actual content of the system is stored in the Content Servers and can be accessed by means of Distribution Servers. Two types of Distribution Servers are currently supported: Web Servers and Event

Servers. In particular, Event Servers provide a standard event-based platform and allow the client application to accessing and updating context data in an event-based manner. Furthermore, user generated content is added and shared among users in an event-based manner thus to support an efficient and real-time sharing of information.

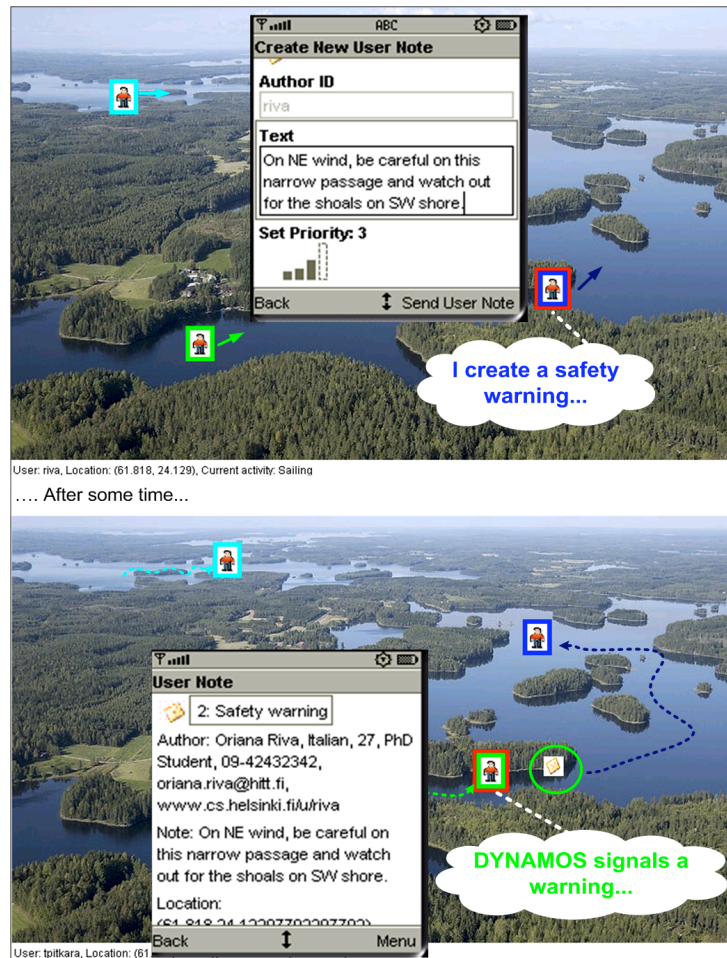

Fig. 1. Sharing of user notes and location simulation

#### 4. Demo Application

The DYNAMOS demo application is designed for usage in a marine community scenario. In the reality, the boater's location is acquired by using GPS. But, in the actual demonstration, in order to simulate the movement of users, we show on a screen a map of the Turku archipelago, located in Finland's south-western sea area.

As Fig. 1 shows, each user can be moved around the map by dragging and dropping on the screen. The current activity is manually entered by the user. We demonstrate the system's functionality by means of three use cases:

1. The boater moves around the archipelago and is constantly provided with a list of services that match his current context and interests. For each service category, contact information, location, opening times are provided. The user can also receive information about services in the form of service annotations, depending on her preferences. Fig.2 shows the respective DYNAMOS phone interfaces that support these operations.
2. A boater creates an annotation after using a service and stores it into the system. Subsequently, other boaters are provided with such annotations if the associated service matches their preferences and current context information. The service annotation provided in Fig.2 is created as Fig. 3 illustrates.
3. Finally, as Fig. 1 shows, the boater creates a user note, in this case containing a safety warning, and adds it to the system. Later a second boater who passes nearby where the message was left he is provided with it.

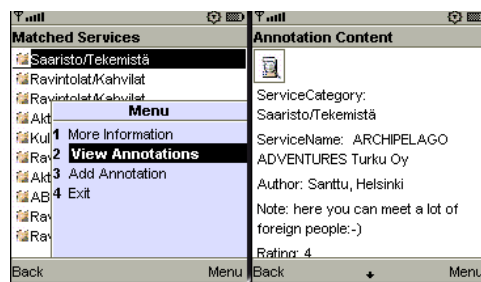

**Fig. 2.** Service provisioning as service descriptions or annotated services

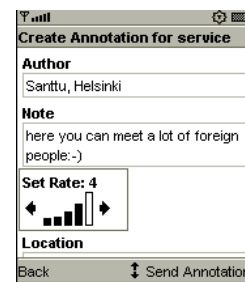

**Fig. 3.** Creation of service annotation

## 5. Future Work

In the future development of the system, special attention will be given to designing means for managing user- and community-generated content. The usefulness of the system will highly depend on the type and quality of available information, how up-to-date the stored content is, how much control the system is able to guarantee against spam, and consequently how much users can trust the system and other people using it. Furthermore, our future work will focus on designing more advanced context-based matching algorithms and a more flexible support for the provisioning of context information.

## References

1. Arbanowski, S., Ballon, P., David, K., Droegehorn, O., Eertink, H., Kellerer, W., van Kranenburg, H., Raatikainen, K., and Popescu-Zeletin, R.: I-centric communications: personalization, ambient awareness, and adaptability for future mobile services. *IEEE Communication Magazine* 42 (2004) 63-69
2. Espinoza, F., Persson, P., Sandin, A., Nyström, H., Cacciatore, and E., Bylund, M.: GeoNotes: Social and Navigational Aspects of Location-Based Information Systems. *UbiComp 2001: Ubiquitous Computing, International Conference (2001)* 2-17

# Automated Context Recognition: An Algorithmic Approach

Aviv Segev

Faculty of Industrial Engineering and Management, Technion, Haifa 32000, Israel  
asegev@technion.ac.il

**Abstract.** A context recognition algorithm based on the streaming of textual information from diverse fields of knowledge is presented. Different applications of this algorithm are reviewed. The algorithm yields consistently good results when applied in different information domains.

## 1. Introduction

The question of context recognition is defined as one of the main questions addressed by the interdisciplinary international context community [2]. The effective recognition of context is essential in the common sense knowledge problem, considered to be one of the primary research areas in Artificial Intelligence (AI) [3].

Context is required in practically every application of AI. The application domain itself constitutes an important context for reasoning, and AI applications can be more effective and efficient if they utilize this contextual information. Context and contextual knowledge must be represented explicitly so that applications can take their context into consideration and benefit from contextual knowledge. Many existing approaches in AI, both theoretical and applied, take the context into account implicitly: contextual knowledge may be present but it is not explicitly identified [1]. The application implements a model of context recognition using the Internet as a knowledge base. The use of the Internet as a database gives a context recognition algorithm immediate access to a nearly infinite amount of data in a multiplicity of fields. Context is represented here as a textual description of a given situation by a set of words.

The algorithm has been implemented in a variety of different fields on diverse textual input. The performance of the algorithm was analyzed using internet chats, article abstracts, and Shakespeare plays. The algorithm was further implemented on medical case studies to extract information relating to patients' symptoms and diagnoses. The integration of computer vision techniques with the context recognition algorithm is being examined to improve the achievement of context from sources that contain images as well as text. The algorithm is currently being used to route emails to assist Local Governments improve their responses to the concerns of Citizens. The algorithm obtains consistently good results.

## 2. The Context Recognition Algorithm

### 2.1. Theoretical Definition

McCarthy [5] formalized context as follows: Let  $P_1, \dots, P_m$  be a series of textual propositions representing a document, when  $\exists P_i$  there exists a collection of sets of contexts  $C_{ij}$  so that: For each  $i$ ,  $\text{ist}(C_{ij}, P_i) \forall j$  meaning that the textual proposition  $P_i$  is true in each of the set of contexts  $C_{ij}$ .

The context recognition algorithm [6] identifies the outer context set  $C$  defined by

$$\text{ist}(C, \bigvee_{i=1}^m \text{ist}(C_{ij}, P_i)) \forall j \quad (1)$$

### 2.2. The Algorithm

The context recognition algorithm is based on the streaming, in text format, of information that represents input from different sources. The output of the context recognition algorithm is a set of contexts that attempt to describe the current scenario most accurately. The set of contexts is a list of words or phrases, each describing an aspect of the scenario. The algorithm attempts to reach results similar to those achieved by the human process of determining the set of contexts that describe the current scenario.

The context recognition algorithm consists of four major processes: collecting data, selecting contexts for each text, ranking the contexts, and declaring the current contexts.

The process of data collection implements blackboard architecture [4], namely different text sources can be added in turn to the blackboard and serve as input for the context recognition algorithm. The data collection includes parsing the text and checking it against a stop list, words that do not add to the understanding. The result is a list of keywords obtained from the text. To improve the process, the text can be checked against a domain-specific dictionary.

The selection of the current context is based on searching the Internet for all relevant documents according to these keywords and on clustering the results into possible contexts. Each context is represented by a set of words that characterize the cluster of documents.

In the ranking stage, the set of contexts is ranked according to both the number of references in the text and the number of references in the documents. These two metrics were selected since the number of appearances in the text represents how many times each preliminary context was mentioned in the situation and the number of references in the Internet represents how important the preliminary context is to the general population that uses the Internet. The output of the ranking stage is the current context or a set of highest ranking contexts.

The set of preliminary contexts that has the top number of references, both in number of Internet pages and in number of appearances in all the texts, is declared to be the current contexts.

### **3. Analysis and Implementations**

The algorithm has been implemented and analyzed in multiple scenarios. The following sections present the different areas in which the algorithm was analyzed and implemented.

#### **3.1. Analysis of the Algorithm Performance**

The context recognition algorithm [6] was tested by the streaming in text format of information that represents situations – Internet chats, Shakespeare plays, or article abstracts. The comparison of the results of the algorithm with the results of human subjects yielded a very high agreement and correlation. The results showed there was no significant difference in the determination of context between the algorithm and the human subjects.

#### **3.2. Context Recognition in Medical Case Studies**

The context recognition algorithm was used to extract information from actual medical cases. The goal was to examine a method for encapsulating a patient's medical history and current situation into keywords for the physician performing the analysis. The algorithm yielded good results in the analysis of the medical case studies, presenting words that characterized the actual diagnosis or led to it, and was able to determine the correct diagnosis in some of the cases. The algorithm can serve as a decision support system for a physician presented with a patient's medical record. It can assist in identifying some of the key issues in a patient's medical records or can suggest a possible diagnosis. The algorithm can therefore assist the physician in his review of a patient's medical records.

#### **3.3. Computer Vision and Context Recognition**

To improve context recognition in the analysis of medical case studies, the context recognition algorithm is currently being integrated with computer vision, since images provide a rich source of information that can support the context recognition process. The textual part of the medical records is fed into the context recognition application and a list of possible contexts, which can include possible diagnoses and main symptoms, is obtained.

Next the results of the context recognition and of a separate computer vision algorithm are compared. If the results match, they are checked against the medical information lists. Then, according to the medical information, the results represent main symptoms or possible diagnoses. If the results of the computer vision and the context recognition do not match, a search is performed on the case study text for words that match the results of the computer vision. If no match is found, the results of the two processes are weighted.

### 3.4. Routing Local Government Email according to Context

The context recognition algorithm is currently being implemented in a European Commission STREP project. The QUALEG (Quality of Service and Legitimacy in eGovernment) project aims at enabling Local Governments to manage their policies in a transparent and trustable way, implying that Local Governments should be able to measure the performance of the services they offer, to assess the satisfaction of Citizens, and to re-formulate policy orientations on such elements with the participation of Citizens.

The object of the Local Government is to analyze the quantities of incoming information that cannot be handled using its human resources. The information is examined to see if the correct context can be identified and mapped to the right ontology concept representing Local Government infrastructure and fields of interest. Since the project involves different countries and different languages, a multilingual ontology system is used. According to the context recognition algorithm, different sets of words, representing the same concept, can be mapped to the multilingual ontology.

To analyze the context recognition and the mapping of contexts to ontologies, data from a Local Government, in the form of email messages from Citizens, was used. The context recognition algorithm extracted possible contexts of the emails. These emails were mapped to the ontology concepts according to the possible contexts.

## 4. Conclusions and Further Research

The context recognition application employs an algorithm that analyzes textual input using the Internet as a knowledge base and obtains a list of words, a set of contexts describing the original textual input. The algorithm yields consistently good results when applied in different fields of knowledge.

Directions of further research include extending the present algorithm to analyze additional fields of image and text, such as newspaper articles and web pages. The algorithm can also be implemented in applications requiring context awareness.

## References

1. AAAI'99 Workshop on Reasoning in Context for AI Applications, Orlando, USA (1999)
2. Proceedings for CONTEXT'01: Third International and Interdisciplinary Conference on Modeling and Using Context (2001)
3. Ein-Dor P., Artificial Intelligence: A Short History and the Next Forty Years, Invited chapter in Kenneth E. Kendall (ed.) *Emerging Information Technologies*. Thousand Oaks, CA: Sage Publications. (1999)
4. Erman L., Hayes-Roth F., Lesser V., and Reddy D. R., The Hearsay II Speech Understanding System: Integrating Knowledge to Resolve Uncertainty, *Computing Surveys*, Vol. 12(2) (1980) 213-253
5. McCarthy J., Buvac S., Formalizing Context, *Computing Natural Language*, Stanford University (1997) 13-50



6. Segev A., Identifying the Multiple Contexts of a Situation, Proceedings of Modeling and Retrieval of Context, IJCAI Workshop (2005)