



Open Archive TOULOUSE Archive Ouverte (OATAO)

OATAO is an open access repository that collects the work of Toulouse researchers and makes it freely available over the web where possible.

This is an author-deposited version published in: <http://oatao.univ-toulouse.fr/>
Eprints ID: 16135

To link to this article: DOI: 10.1016/j.comnet.2016.09.008
URL: <http://dx.doi.org/10.1016/j.comnet.2016.09.008>

To cite this version: Trang, Si Quoc Viet and Lochin, Emmanuel *FLOWER, an Innovative Fuzzy Lower-than-Best-Effort Transport Protocol*. (In Press: 2016) *Computer Networks*, vol. 110. pp. 18-30. ISSN 1389-1286

Any correspondence concerning this service should be sent to the repository administrator: staff-oatao@listes-diff.inp-toulouse.fr

FLOWER, an Innovative Fuzzy Lower-than-Best-Effort Transport Protocol

Si Quoc Viet Trang^{a,b}, Emmanuel Lochin^{a,b,*}

^a *Université de Toulouse; ISAE-SUPAERO; Toulouse, France*

^b *TéSA, Toulouse, France*

Abstract

We present a new delay-based transport protocol named FLOWER, that aims at providing a Lower-than-Best-Effort (LBE) service. The objective is to propose an alternative to the Low Extra Delay Background Transport (LEDBAT) widely deployed within the official BitTorrent client. Indeed, besides its intra-fairness problem, known as latecomer unfairness, LEDBAT can be too aggressive against TCP, making it ill suited for providing LBE services over certain networks such as constrained wireless networks. By using a fuzzy controller to modulate the sending rate, FLOWER aims to solve LEDBAT issues while fulfilling the role of a LBE protocol. FLOWER operates to a modification of the standard LEDBAT protocol implementation by replacing its proportional controller by a fuzzy controller. Thanks to this modification, our simulation results show that FLOWER can carry LBE traffic in network scenarios where LEDBAT cannot while solving the latecomer unfairness problem. The presented algorithm is simple to implement and does not require complex computation that would prevent its deployment. Finally, we show that FLOWER remains compliant when used over an AQM-based network and remains LBE while not increasing the bufferbloat.

Keywords: Congestion Control, Lower-than-Best-Effort, LEDBAT, Fuzzy Logic

1. Introduction

While standard TCP and its variants endeavor to achieve a fair share of the network bottleneck capacity between flows, the service provided by the network remains best-effort. There exists another service named Lower-than-Best-Effort (LBE) which aims at providing a second priority class inside the network traffic. The rationale is to propose a service for background traffic (e.g. peer-to-peer file transfers, data backup, software updates, ...) or non delay sensitive signaling traffic. This kind of traffic might tolerate a high latency and should not disturb the traffic carried out by the best-effort service itself or other services that would propose advanced QoS architecture for time-constrained application such as DiffServ [1]. Today, the LBE service, also called “scavenger” service, is perceived as a potential solution to fetch the unused, sometimes wasted capacity in public network. One of the objective is, for instance, to provide a free Internet access based on this LBE principle, as illustrated by the objectives of GAIA¹ or PAWS² project. Last but not least, the LBE service should not exacerbate the bufferbloat issue [2].

Among the different transport protocols providing a LBE service [3], Low Extra Delay Background Transport (LEDBAT) [4] is the most used. LEDBAT is a delay-based congestion control protocol that has been standardized by the Internet Engineering Task Force (IETF). LEDBAT aims to exploit the remaining capacity while limiting the queuing delay around a predefined target τ , which may be set up to $\tau = 100$ ms according to RFC 6817 [4]. Consequently, LEDBAT flows limits the amount of queuing delay introduced in the network and thus lower their impact on best-effort flows such as TCP. As an example of application, the official BitTorrent client is using LEDBAT for data transfer [4].

Despite being a widely deployed protocol, the two main LEDBAT parameters (i.e., target and gain) have been revealed to be complex to determine [5, 6] as their tuning highly depends on the network conditions and not dynamically configurable. Indeed, LEDBAT may become more aggressive than TCP in case of misconfiguration [5, 6]. As an illustration, in a recent study, the authors of [7] conclude that the LEDBAT target parameter should not be higher than 5 ms in a large bandwidth-delay product (*BDP*) network. At last, the authors of [8] show that LEDBAT can greatly increase the network latency making its impact on the network not transparent anymore.

Our protocol, FLOWER (**F**uzzy **L**ower-than-Best-Effo**R**t Transport Protocol), is a promising alternative to LEDBAT. FLOWER overcomes LEDBAT shortcomings and provides an LBE service that is more transparent to the network. The principal difference with LEDBAT is

*Corresponding author. Address: ISAE-SUPAERO, 10 avenue Edouard Belin, BP 54032, 31055 Toulouse Cedex 5

Part of these results has been presented at IEEE LCN 2015.

Email addresses: si-quoc-viet.trang@isae.fr (Si Quoc Viet Trang), emmanuel.lochin@isae.fr (Emmanuel Lochin)

¹Global Access to the Internet for All (<https://sites.google.com/site/irtfgaia>).

²Public Access WiFi Service (<http://publicaccesswifi.org>).

that FLOWER replaces the linear P-type controller (proportional controller) of LEDBAT by a fuzzy controller to modulate the congestion window. Compared to a recent solution named fLEDBAT [9] that proposes to solve the latecomer issue and to the best of our knowledge, there is no universal scheme allowing intra-fair LEDBAT flows to remain LBE compliant, that is, non-aggressive when competing with TCP flows.

We first review in Section II the LEDBAT algorithm and its problems that motivate our work. Section III details the design of FLOWER, while Section IV clearly explains its core component, that is the fuzzy controller. Section V evaluates our new protocol and gives a side-by-side comparison with LEDBAT using the network simulator ns-2.35. We also demonstrated that FLOWER is more LBE-compliant than LEDBAT in the presence of AQM schemes in Section VI. We finally conclude our work in Section VII.

2. Contextual background and motivation

While many transport protocols that have been designed to carry LBE traffic, such as NICE [10] or TCP-LP [11], only LEDBAT has been reported to be actually deployed [12]. Our work therefore focus on LEDBAT and its design issues that are described in this section.

2.1. LEDBAT in a nutshell

LEDBAT congestion control is based on queuing delay variations (i.e., the queuing delay is used as a primary congestion notification). LEDBAT is characterized by several parameters: target queuing delay τ , gain γ , minimum one-way delay owd_{min} (also called base delay), and current one-way delay owd_{ack} . The target queuing delay τ embodies the maximum queuing time that a LEDBAT connection is allowed to introduce in the network. The gain γ corresponds to the reactivity of LEDBAT to queuing delay variations. The bigger γ is, the faster LEDBAT congestion control increases or decreases its congestion window. LEDBAT infers the queuing delay q by calculating $(owd_{ack} - owd_{min})$ obtained from one-way delays measured by exploiting the ongoing data transfer. To keep the queuing delay around the predefined target, LEDBAT uses a linear P-type controller to modulate the congestion window according to the derived queuing delay. For each ACK received at discrete time k , the new congestion window size $cwnd$ is updated as follows:

$$\Delta cwnd(k) = \frac{\gamma(\tau - (owd_{ack}(k) - owd_{min}(k)))}{cwnd(k-1)} \quad (1)$$

$$cwnd(k) = cwnd(k-1) + \Delta cwnd(k) \quad (2)$$

where $\Delta cwnd(k)$ is the change of the congestion window size.

2.2. Two main LEDBAT issues

2.2.1. Aggressiveness of LEDBAT

RFC 6817 [4] states that, if a compromised target is set to infinity, “the algorithm is fundamentally limited in the worst case to be as aggressive as standard TCP”. Actually, it corresponds to the case where the buffer size is too small in comparison to the target. Thus, the queuing delay sensed by LEDBAT never reaches the target. Therefore, LEDBAT always increases its sending rate until a loss event is reported.

However, there are circumstances “worse than the worst case mentioned in RFC 6817” in which hostile LEDBAT makes TCP back off, even in an unfavorable situation for LEDBAT when it starts after TCP. The issue occurs when the buffer size is around the target. In this case, LEDBAT does not have enough time to react to queuing delay before TCP causes a buffer overflow. After that, TCP halves its congestion window, resulting in a reduction of the queuing delay. Since the queuing delay is now below the target, LEDBAT raises again its congestion window conjointly with TCP. Consequently, after several cycles, LEDBAT exploits more capacity than TCP.

To illustrate why the problem is important and the impact of the aggressiveness of LEDBAT on TCP flows, Fig. 1a shows an ns-2 simulation of 5 TCP NewReno and 5 LEDBAT flows sharing the same bottleneck with a capacity of 10 Mb/s. The buffer size is 84 packets (about 100 ms of delay) and the LEDBAT target is set to 100 ms. The result is unequivocal and demonstrates the aggressiveness of LEDBAT flows against TCP flows. Although we present measurements with TCP NewReno, the problem remains the same with Cubic as shown later in the paper.

2.2.2. Latecomer unfairness

When LEDBAT flows start at different times, they may suffer from the latecomer unfairness problem. This problem arises because latecomer flows may sense different minimum one-way delays. In the worst case, when the buffer size is large enough, latecomer flows can starve ongoing flows.

Fig. 1b demonstrates the latecomer unfairness problem. In this case, three LEDBAT flows start consecutively every 50s and share the same bottleneck with a capacity of 10 Mb/s. The buffer size is 167 packets (about 200 ms of delay). The LEDBAT target is set to 100 ms. As can be observed in Fig. 1b, latecomer flows gradually take all the capacity of ongoing flows.

2.3. Motivation of FLOWER

Up to this point, we have recalled and illustrated two important LEDBAT issues. We now present our motivation to develop the new congestion control named FLOWER.

Both LEDBAT key parameters — target and gain — are fixed and do not cope with the diversity of network configurations. Consequently, LEDBAT becomes more aggressive than TCP under some circumstances. One possible solution is to adapt the target/gain to the change of

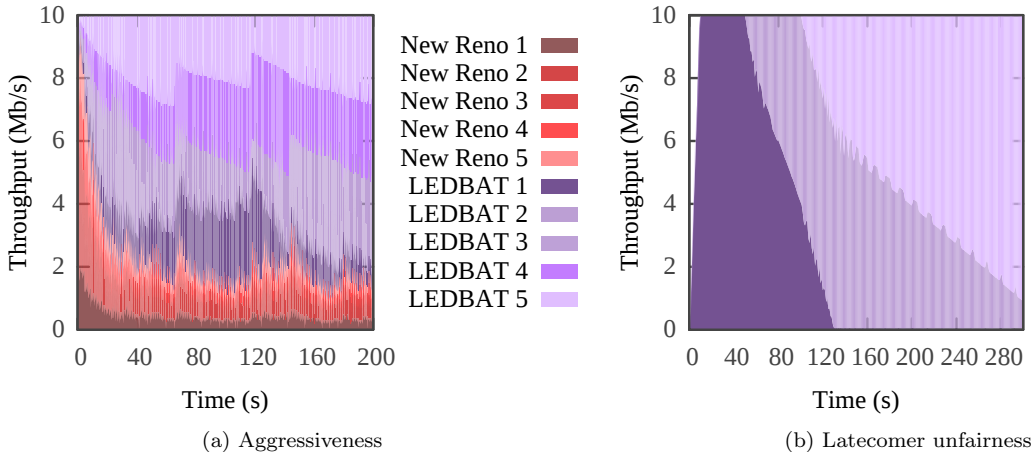

Figure 1: LEDBAT problems.

network conditions [7, 13]. However, such adaptive control scheme requires a fine-grained mathematical network model. To prevent the use of such too complex model, we design a new congestion protocol based on the fuzzy logic. Two main advantages of this approach are:

1. a fuzzy control system is a solution that prevents the use of a mathematical model. Such approach is particularly interesting when the model is not trivial, difficult to derive or too complex to be implemented;
2. the fuzzy logic allows to incorporate our heuristic knowledge about how to control the system. In other words, we can use our previous findings [6] as an entry for the fuzzy controller.

An in-depth analysis [6] gives us an insight to overcome the LEDBAT problems, or more specifically, to control the queuing delay. Hence, by means of the fuzzy logic, we integrate our understanding gathered into the fuzzy controller of FLOWER. We also point out that, by using a fuzzy control system, we seek a generic solution that works in several and various network conditions. It means that we are seeking an average use-case and not the “optimal” one.

3. Design and implementation

3.1. FLOWER overview

FLOWER is a novel delay-based transport protocol which aims at providing an effective LBE service. So, as a potential LEDBAT alternative, FLOWER must tackle its issues while keeping the same goals in terms of LBE service as listed in [4]:

1. to utilize end-to-end available bandwidth and to maintain low queuing delay when no other traffic is present;
2. to add limited queuing delay to that induced by concurrent flows, and;

3. to yield quickly to standard TCP flows that share the same bottleneck link.

To achieve these goals, FLOWER implements a fuzzy controller to manage the target queuing delay algorithm instead of the P-type controller as proposed in [4]. This non-zero target queuing delay allows FLOWER to fetch the available capacity, and thus to saturate the bottleneck link, when no other traffic is present. Meanwhile, the queuing delay needs to be kept as low as possible to make FLOWER non-intrusive to standard TCP traffic.

We can represent FLOWER congestion control as a feedback control system depicted in Fig. 2a. The essential components of FLOWER are:

1. *Fuzzy controller*, which is an artificial decision maker that operates based on a set of “If-Then” rules. By using the fuzzy logic, the fuzzy controller determines the congestion window size $cwnd$ such that the future estimated queuing delay eventually matches the target queuing delay τ . The fuzzy controller takes two inputs: queuing delay error e and change of queuing delay error Δe ;
2. *Queuing delay estimator*, which exploits measured one-way delays to estimate the current queuing delay q ;
3. *Peak-valley detector*, which keeps track of the maximum queuing delay q_{max} observed in the network. This maximum queuing delay is then used to normalize the queuing delay error.

Basically, FLOWER operates as follows: after each round-trip time (RTT), FLOWER uses the minimum queuing delay observed during the RTT as the current queuing delay. Queuing delays in an RTT are obtained using the queuing delay estimator. Then, the fuzzy controller compares the target queuing delay with the current queuing

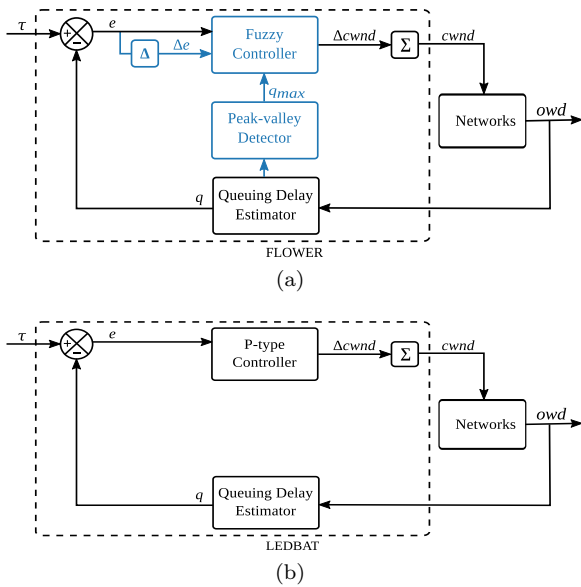

Figure 2: Block diagram of FLOWER and LEDBAT as feedback control systems.

delay. The error is positive when the current queuing delay is below the target. In this case, the fuzzy controller increases the congestion window, and thus the sending rate until the queuing delay reaches the target. When the error is negative, meaning that the current queuing delay is beyond the target, the fuzzy controller slows down its sending rate.

In the rest of this section, we give a brief comparison of LEDBAT and FLOWER, then describe the peak-valley detector component. Finally, we discuss about the slow-start mechanism which is part of FLOWER. The main FLOWER component, i.e., the fuzzy controller, is described in detail in Section 4.

3.2. Comparison of FLOWER and LEDBAT

Fig. 2 shows in blue the differences between FLOWER and LEDBAT. Notably in FLOWER, we replace the P-type controller with the fuzzy controller that, besides the queuing delay error e , also utilizes the error trend Δe . We highlight the fact that while being more robust, the implementation of a fuzzy controller is simple and adds a little complexity to computation compared to the P-type controller of LEDBAT.

Another feature added to FLOWER is the peak-valley detector. This detector determines the maximum queuing delay, which is important for the operation of the fuzzy controller. Note that FLOWER uses the same LEDBAT queuing delay estimator, which is fully described in RFC 6817 [4].

3.3. Peak-valley detection algorithm

To effectively react to congestion events, FLOWER needs to determine the maximum queuing delay q_{\max} . For

On initialization:

$findingPeak \leftarrow \mathbf{true}$
 $n \leftarrow 5; \alpha \leftarrow \frac{1}{8}; S \leftarrow 0$

After the RTT k :

if we have enough $(n + 1)$ samples **then**

$slidingWnd = \{q_{k-n}, q_{k-n+1}, q_{k-n+2}, \dots, q_{k-1}, q_k\}$

$currentValue \leftarrow q_{k-n}$

$rightMax \leftarrow \max(q_{k-n+1}, q_{k-n+2}, \dots, q_{k-1}, q_k)$

$rightMin \leftarrow \min(q_{k-n+1}, q_{k-n+2}, \dots, q_{k-1}, q_k)$

if $findingPeak$ **then**

if $currentValue > rightMax$ **then**

A peak is found: $findingPeak \leftarrow \mathbf{false}$

Calculate the new threshold S :

$S \leftarrow (1 - \alpha) \times S + \alpha \times currentValue$

if $currentValue > S$ **then**

A new q_{\max} is found:

$q_{\max} \leftarrow currentValue$

else

if $currentValue < rightMin$ **then**

A valley is found: $findingPeak \leftarrow \mathbf{true}$

Figure 3: Peak-valley detection algorithm.

this purpose, we must identify the peaks of queuing delays (local maximum) and filter out the maximum queuing delay (global maximum) using a threshold S , which is computed following an exponentially weighted moving average (EWMA) of peaks. For the sake of remaining as simple as possible and not complexifying our implementation, we develop a simple on-line peak-valley detection algorithm as shown in Fig. 3.

Let us consider a time series of estimated queuing delays $q = \{q_k\}$ where k represents the discrete time in RTT. Basically, an element q_k is a peak/valley if it is greater/smaller than its neighbors, respectively. As our algorithm works in an on-line manner, at the current time k , we only need to consider a sliding window consisting of q_{k-n} and its n right neighbors, i.e.,

$$\{q_{k-n}, q_{k-n+1}, q_{k-n+2}, \dots, q_{k-1}, q_k\}.$$

The bigger is n , the more robust is the algorithm. We stress that there is a delay of $(n + 1)$ RTT in the detection process of q_{\max} because the algorithm needs to collect enough queuing delay samples.

The algorithm alternatively identifies the peaks and valleys of queuing delays. Indeed, we have a peak/valley if q_{k-n} is greater/smaller than the maximum/minimum of its n right neighbors, respectively. Each time a peak is detected, it is then used to calculate a new threshold to filter out q_{\max} . Finally, when a new q_{\max} is found, FLOWER discards the old value.

In our implementation, we let $n = 5$ to keep a small delay while still having a robust maximum queuing delay detection. The EWMA parameter α is set to $1/8$, which is

the value typically used for computing the smoothed RTT for TCP.

3.4. Slow-start: to do or not to do?

Similarly to LEDBAT, FLOWER might suffer from the latecomer unfairness problem. During our experiments, we notice that the use of the slow-start helps to mitigate the latecomer issue (without solving it for LEDBAT). This has also been noted by [14]. FLOWER uses slow-start as a synchronization signal which also allows to get a first measure of the maximum queuing delay refined afterwards with the peak-valley algorithm. The purpose of slow-start is to create a spike in the queuing delay since in the slow-start phase, the congestion window increases exponentially until causing a loss event. If other FLOWER connections also experience a loss, they reset their congestion window. As a consequence, the queuing delay is reduced allowing all flows to sense almost the same base delay. All flows will then raise again at the same time and share the capacity equally. We highlight that slow-start of the newcomer flow does not necessarily cause loss to other ongoing flows. However, in this situation, the congestion detection functionality of the FLOWER fuzzy controller helps ongoing flows to detect the slow-start signal of the latecomer flow, and hence to resynchronize all flows.

4. FLOWER fuzzy controller

At the core of FLOWER congestion control is the fuzzy controller composed by the following modules [15]:

1. *A rule base*, which contains a set of “If-Then” rules that describes how to achieve good control;
2. *An inference mechanism*, which emulates the human expert’s decision making about how best to control the system based on the information stored in the rule base;
3. *A fuzzification interface*, which converts controller inputs, e and Δe , into fuzzy values that the inference mechanism can use for its fuzzy reasoning process;
4. *A defuzzification interface*, which converts the conclusions of the inference mechanism into numerical output $\Delta cwnd$.

In the remainder of this section, we briefly introduce these modules and illustrate their operation.

4.1. Choosing the controller inputs and output

To make a decision at the sampling instance k , the controller uses as inputs the queuing delay error:

$$e(k) = \tau - q(k) \quad (3)$$

and the change of queuing delay error:

$$\Delta e(k) = -(q(k) - q(k-1)) = -\Delta q(k) \quad (4)$$

The queuing delay error is the difference between the target queuing delay and the estimated queuing delay. If the error is big, the control action must be large to quickly drive the error to zero. In contrast, if the error is small, the control action must be small to prevent oscillation. Therefore, the controller modulates its actions with the queuing delay error.

The change of queuing delay error is the error trend. For a same degree of error, the control actions should differ depending on whether the error trend is increasing or decreasing. If the error trend is increasing, the controller needs to take stronger action to correct the error, but when the error trend is decreasing, the controller must reduce the control action to avoid over-reaction. Thus, the error trend is used to amplify or dampen the actions of the controller.

The controller output is the change of congestion window $\Delta cwnd(k)$, that is, the pace at which the controller must increase/decrease the congestion window to match the queuing delay to the target queuing delay. The congestion window size $cwnd(k)$ is then calculated by:

$$cwnd(k) = cwnd(k-1) + \Delta cwnd(k) \quad (5)$$

4.2. The rule base

The rule base models the relationship between inputs and outputs of the system. It serves as *a repository* to store the available knowledge about how to solve the problem in the form of linguistic “If-Then” rules. To establish a rule, we use *linguistic variables* and their *linguistic values* [15].

The linguistic variables describe each of the fuzzy controller inputs and outputs, so they usually are the names of inputs and outputs. For FLOWER, the linguistic variables are:

- “queuing delay error” or “ $e(k)$ ”;
- “change of queuing delay error” or “ $\Delta e(k)$ ”;
- “change of congestion window” or “ $\Delta cwnd(k)$ ”.

Each linguistic variable assumes different linguistic values to give *informative description about a numerical (real) value*. The linguistic variables of FLOWER take on the following linguistic values:

{NVVL, NVL, NL, NM, NS, NVS, Z, PVS, PS, PM, PL, PVL}

where the meaning is: N: negative; P: positive; V: very; Z: zero; S: small; M: medium; L: large.

Hence, the linguistic value PVS stands for *positive very small* and so forth.

To clarify how this controller operates, let’s take for example the following linguistic rules:

If $e(k)$ is PVL and $\Delta e(k)$ is Z Then $\Delta cwnd(k)$ is PVL

This rule describes the situation where the queuing delay is *very small* and *does not raise*. In consequence, we must increase the congestion window by a *very large* value.

		The queuing delay										
		Increasing					Decreasing					
Above the target	$\Delta cwnd$	Δe										
	e	-5	-4	-3	-2	-1	0	1	2	3	4	5
Above the target	-5	-5	-5	-5	-5	-5	-5	-4	-3	-2	-1	-6
	-4	-5	-5	-5	-5	-5	-4	-3	-2	-1	0	-6
	-3	-5	-5	-5	-5	-4	-3	-2	-1	0	1	-6
	-2	-5	-5	-5	-4	-3	-2	-1	0	1	2	-6
	-1	-5	-5	-4	-3	-2	-1	0	1	2	3	-6
Below the target	0	-5	-4	-3	-2	-1	0	1	2	3	4	-6
	1	-4	-3	-2	-1	0	1	2	3	4	5	-6
	2	-3	-2	-1	0	1	2	3	4	5	5	-6
	3	-2	-1	0	1	2	3	4	5	5	5	-6
	4	-1	0	1	2	3	4	5	5	5	5	-6
	5	0	1	2	3	4	5	5	5	5	5	-6

Zone 1
Zone 2
Zone 3
Zone 4
Zone 5
Zone 6

Legend

-6 = NVVL, -5 = NVL, -4 = NL, -3 = NM, -2 = NS, -1 = NVS, 0 = Z, 1 = PVS, 2 = PS, 3 = PM, 4 = PL, 5 = PVL

(P: Positive, N: Negative, V: Very, Z: Zero, S: Small, M: Medium, L: Large)

Figure 4: The rule base of the FLOWER fuzzy controller.

If $e(k)$ is NVS and $\Delta e(k)$ is NVS Then $\Delta cwnd(k)$ is NS

This rule describes the situation where the queuing delay is *slightly beyond* the target delay and raises *very slowly*. In consequence, we must decrease the congestion window by a *small* value to counteract the movement.

For a system with two inputs and one output like FLOWER, we can list all rules using tabular representation as shown in Fig. 4. Note that in the rule table in Fig. 4, we use *linguistic-numeric values* to shorten the description of linguistic values [15] (e.g., -5 represents NVS; 0 represents Z; 3 represents PM; ...).

To better understand the fuzzy controller dynamics, we divide the rule table into six zones as follows:

Zone 1: Rules of this zone maintain the steady-state queuing delay around the target. Both $e(k)$ and $\Delta e(k)$ remains very close to zero. In consequence, the fuzzy controller must slightly increase or decrease the congestion window (denoted $\Delta cwnd$ in Fig. 4) to rectify small deviations from the target.

Zone 2: In this zone, $e(k)$ is positive or zero, which means that the queuing delay is respectively either *below* or *equal* to the target. In addition, since $\Delta e(k)$ is negative or zero, the queuing delay tends to *raise* and thus *moves in the direction* of the target. Therefore, based on the increase trend magnitude of the queuing delay, the fuzzy controller must either increase (i.e. $\Delta cwnd > 0$) or decrease (i.e. $\Delta cwnd < 0$) the congestion window to accelerate or decelerate the queuing delay motion to match the target.

Zone 3: In this zone, since $e(k)$ is negative, the queuing delay is *above* the target. On the other hand, $\Delta e(k)$

is negative or zero, which means that the queuing delay tends to *increase* and hence, in this case, *moves away* from the target. Consequently, the fuzzy controller must decrease the congestion window to compensate the increase of the queuing delay.

Zone 4: For this zone, $e(k)$ is negative and $\Delta e(k)$ positive, which corresponds to the situation where the queuing delay is *above* and is *decreasing towards* the target. As a result, to match the queuing delay to the target, the fuzzy controller needs to accelerate or decelerate the queuing delay motion based on the magnitude of its decrease trend.

Zone 5: Rules of this zone represent the situation where the queuing delay is either *below* or *equal* to the target. Moreover, the queuing delay is *decreasing away* from the target. Thus, $e(k)$ is either positive or zero and $\Delta e(k)$ is positive. The fuzzy controller must therefore increase the congestion window to reverse the decrease trend of the queuing delay.

Zone 6 — Congestion Detection Zone: An important feature of FLOWER is its capability to react quickly to congestion events caused by TCP. This feature is integrated in the rule base and can be observed in the last column of the rule table called the *congestion detection zone* (see Fig. 4). Concretely, when FLOWER detects a very large decrease in the queuing delay ($\Delta e(k)$ is 5 or PVL), it must immediately reduce to its minimum congestion window (e.g, set to one packet). This case corresponds to the following output: $\Delta cwnd(k)$ is -6 or NVVL.

4.3. Membership functions

A membership function defines the semantic of a linguistic value. Let's A denote a linguistic value and X be a universe of discourse for an input or output of a fuzzy system, i.e., the range of numerical values that the inputs and outputs can take as values. Each linguistic value A is associated with a membership function. This membership function quantifies the certainty or membership degree that a numerical value $x \in X$ can be classified linguistically as A . The set of numerical values of X that a membership function describes as being a linguistic value A is called a fuzzy set.

In this paper, we use the most common triangle membership function defined by the three parameters $\{a, b, c\}$ as follows:

$$\mu_A(x) : X \mapsto [0, 1]$$

$$\mu_A(x) = \begin{cases} 0 & \text{if } x \leq a, \\ \frac{x-a}{b-a} & \text{if } a < x \leq b, \\ \frac{c-x}{c-b} & \text{if } b < x < c, \\ 0 & \text{if } x \geq c \end{cases} \quad (6)$$

where $a < b < c$ and b is the center of the triangle membership function (i.e., where it reaches its peak) [15].

Consider, for example, the membership function μ_{PVS} that quantifies the meaning of the linguistic value *positive very small* for any numerical value $x \in X$:

- if $\mu_{PVS}(x) = 0$ then we are certain that x is not PVS;
- if $\mu_{PVS}(x) = 0.5$ then we are only half certain that x is PVS. It could also be Z with some degree of certainty;
- if $\mu_{PVS}(x) = 1$ then we are absolutely certain that x is PVS.

Fig. 5 shows all the membership functions for the inputs and the output of the FLOWER fuzzy controller.

4.3.1. Membership functions of $e(k)$

Since the queue size varies continuously as a function of the network traffic, we need to make the input error $e(k)$ independent of the network state. For this purpose, before introducing $e(k)$ into the fuzzy controller, we express it as follows:

$$e(k) = \begin{cases} \frac{e(k)}{\tau} \times 100 & \text{if } q(k) \leq \tau, \\ \frac{e(k)}{q_{\max} - \tau} \times 100 & \text{if } q(k) > \tau \end{cases} \quad (7)$$

where q_{\max} is the maximum queuing delay observed on the network. Consequently, the membership functions of $e(k)$ is linearly distributed on the universe of discourse $[-100, 100]\%$.

4.3.2. Membership functions of $\Delta e(k)$

The queuing delay is ranging from 0 to the maximum value q_{\max} . Thus, we have

$$\Delta e(k) = -(q(k) - q(k-1)) = -\Delta q(k) \quad (8)$$

where

$$q(k) \in [0, q_{\max}]$$

Then, the universe of discourse for $\Delta e(k)$ is $[-q_{\max}, q_{\max}]$ ms.

The variation of the queuing delay, and thus $\Delta e(k)$, highly depends on the network state. Hence, we need to dynamically adapt the distribution for the membership functions of $\Delta e(k)$. In addition, as seen in the rule table in Fig. 6, the congestion detection zone of FLOWER relies only on $\Delta e(k)$. Therefore, we must determine a threshold to define this zone. To this end, we use the exponentially weighted moving average (EWMA) of values of $\Delta e(k)$. As EWMA has higher weights on recent data than on older data, sudden network condition changes are further taken into account in this average. Consequently, the distribution for the membership functions of $\Delta e(k)$ is as follows:

$$-q_{\max}, sde_-, -3, -2, -1, 0, 1, 2, 3, sde_+, q_{\max}$$

where sde_- and sde_+ are the EWMA of the negative and positive values of $\Delta e(k)$, respectively. $\{-q_{\max}, sde_-, sde_+, q_{\max}\}$ are respectively initialized with $\{-5, -4, 4, 5\}$. These values are updated only when the absolute value of a new value is greater than the absolute value of the initial value.

Finally, we underline that, as an effect of the congestion detection zone, when $\Delta e(k) > sde_+$, even if the certainty $\mu_{PVL}(\Delta e(k))$ is small, FLOWER reduces the congestion window to its initial value.

4.3.3. Membership functions of $\Delta cwnd(k)$

Outside the congestion detection zone, the distribution of $\Delta cwnd(k)$ is linear on the universe of discourse $[-1, 1]$ packet. As a consequence, the maximum ramp-up speed of FLOWER is the same as TCP, i.e., one packet per RTT. When operating in the congestion detection zone, $\Delta cwnd(k)$ is set to negative infinity to signal FLOWER to reduce to minimum its sending rate. Otherwise, FLOWER will ramp-down at maximum one packet per RTT.

4.4. Fuzzification

Fuzzification is the process of making a numerical value fuzzy so that it can be used by the fuzzy system. Whenever the fuzzification module receives a numerical value x , it converts this value into a corresponding linguistic value by associating a certainty that is quantified by the membership function $\mu_A(x)$.

4.5. Inference mechanism

The inference mechanism derives the fuzzy outputs from the fuzzy inputs obtained by fuzzification, according to the relation defined through fuzzy rules. The main matter is how to interpret the meaning of each rule, i.e., how to

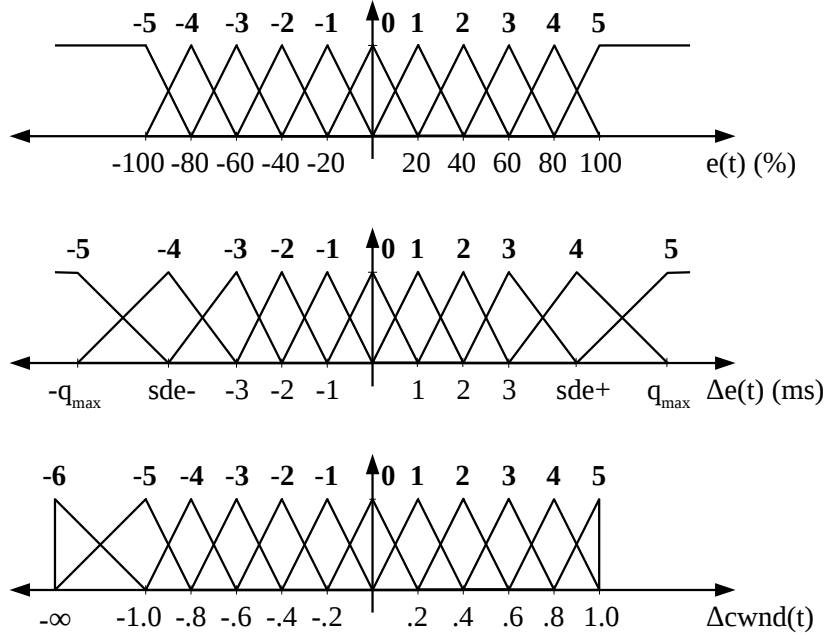

Figure 5: The membership functions of the FLOWER fuzzy controller.

determine the influence produced by the premise on the conclusion of the fuzzy rule. To assess this influence, the inference process generally involves in two steps:

1. The certainty of the premise is determined using the fuzzy conjunctive operator (AND);
2. The certainty of the conclusion, influenced by the premise, is determined using the fuzzy implication operator.

To illustrate the general idea of the inference mechanism, we consider a simple fuzzy system with two inputs x_1 and x_2 and one output y . The system is described by the following rule base of the form:

$$R_i : \text{If } x_1 \text{ is } A_1^i \text{ and } x_2 \text{ is } A_2^i \text{ Then } y \text{ is } B^i, \\ \text{for } i = 1, 2, \dots, r$$

where A_1^i , A_2^i , and B^i are the linguistic values of the linguistic variables x_1 , x_2 , and y in the i -th rule R_i . We use the minimum operator to represent both fuzzy conjunctive and implication operators. Therefore, the certainty of the premise of rule R_i is determined as follows:

$$\begin{aligned} \mu_{A^i}(x_0) &= \mu_{(A_1^i \text{ AND } A_2^i)}(x_1, x_2) \\ &= \min(\mu_{A_1^i}(x_1), \mu_{A_2^i}(x_2)) \end{aligned} \quad (9)$$

where $x_0 = (x_1, x_2)$. Then, the certainty of rule R_i is determined as follows:

$$\mu_{R_i}(y) = \min(\mu_{A^i}(x_0), \mu_{B^i}(y)) \quad (10)$$

where $\mu_{B^i}(y)$ is the membership function of the consequent of rule R_i . The membership function $\mu_{R_i}(y)$ quantifies how certain rule R_i is when the output y should take on certain values. In Eq. 10, the minimum operation truncates the membership function of the consequent $\mu_{B^i}(y)$ to produce the membership function $\mu_{R_i}(y)$ (for graphical representation, see example in Section 4.7).

4.6. Defuzzification

Defuzzification is the process of combining results of the inference mechanism to obtain a numerical output value y . We use the “center-average” defuzzification method which calculates the weighted average of the output membership function centers b_i :

$$y = \frac{\sum_i b_i \sup_y \{\mu_{R_i}(y)\}}{\sum_i \sup_y \{\mu_{R_i}(y)\}} \quad (11)$$

where $\sup_y \{\mu_{R_i}(y)\}$ is the highest value of $\mu_{R_i}(y)$.

We have finished the description of the three processes fuzzification, inference and defuzzification in a general context. For FLOWER, we have $x_1 = e(k)$, $x_2 = \Delta e(k)$ and $y = \Delta cwnd(k)$.

4.7. Example of fuzzy controller operations

Consider the example in Fig. 6. Suppose that $e(k) = 35$ after being converted to the percentage form and $\Delta e(k) = 1$. The fuzzification process using Eq. 6 gives $\mu_{PVS}(e(k)) = 0.25$ and $\mu_{PS}(e(k)) = 0.75$, whereas $\mu_{PVS}(\Delta e(k)) = 1$.

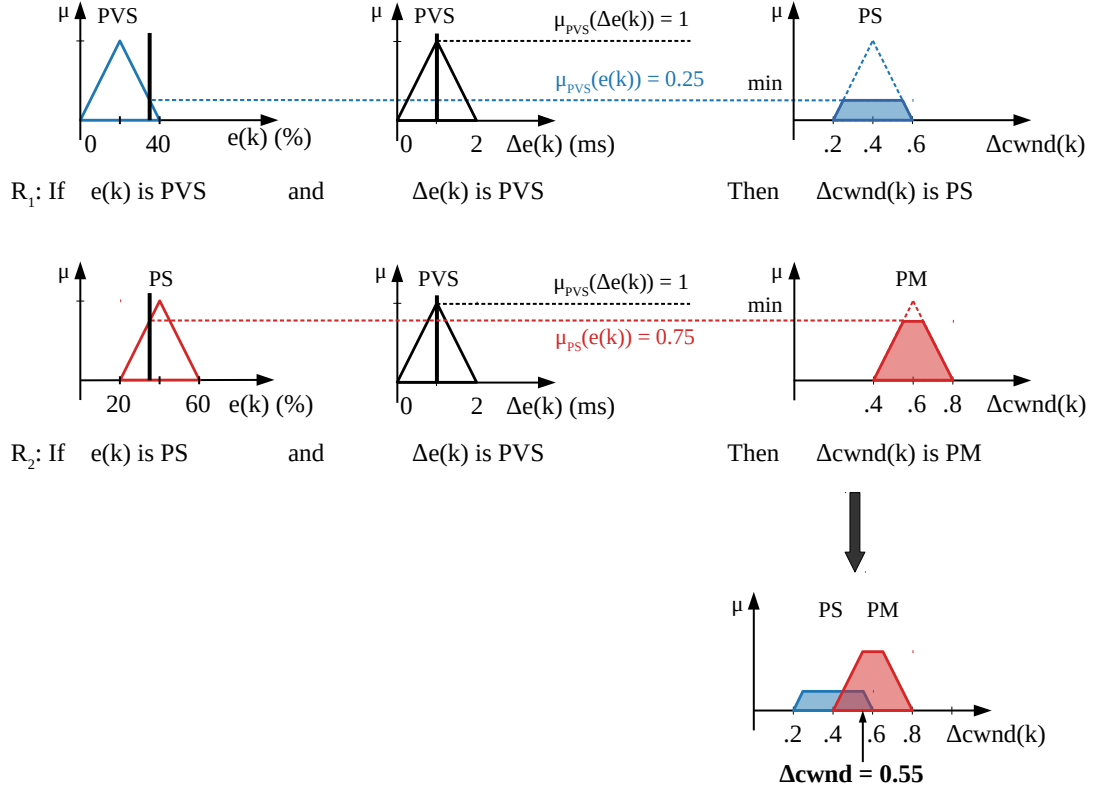

Figure 6: Graphical representation of fuzzy controller operations.

Fig. 6 shows the certainties of the membership functions for the inputs and indicates with black vertical lines the numerical values of $e(k)$ and $\Delta e(k)$. In this case, by consulting the rule table in Fig. 4, we have the following corresponding rules:

R_1 : If $e(k)$ is PVS and $\Delta e(k)$ is PVS Then $\Delta cwnd(k)$ is PS

R_2 : If $e(k)$ is PS and $\Delta e(k)$ is PVS Then $\Delta cwnd(k)$ is PM

Now, consider the first rule R_1 . Let $x_0 = (e(k), \Delta e(k))$, and thus, using Eq. 9 of the inference mechanism, the certainty of the premise of the rule R_1 is:

$$\begin{aligned} \mu_{A^1}(x_0) &= \min(\mu_{PVS}(e(k)), \mu_{PVS}(\Delta e(k))) \\ &= \min(0.25, 1) = 0.25 \end{aligned}$$

and then, according to Eq. 10, we have:

$$\mu_{R_1}(\Delta cwnd(k)) = \min(0.25, \mu_{PS}(\Delta cwnd(k)))$$

The membership function $\mu_{R_1}(\Delta cwnd(k))$, which is the conclusion reached by rule R_1 , is shown in Fig. 6 as the blue region of the output membership function $\mu_{PS}(\Delta cwnd(k))$ defining the linguistic value PS. As mentioned in Section 4.5, this blue region is a result from the truncation of the membership function $\mu_{PS}(\Delta cwnd(k))$ by the minimum opera-

tor. As a conclusion for rule R_1 , we are at most 25% certain that the output $\Delta cwnd(k)$ should be a positive small value.

In the same way, for the second rule R_2 , we have:

$$\begin{aligned} \mu_{A^2}(x_0) &= \min(\mu_{PS}(e(k)), \mu_{PVS}(\Delta e(k))) \\ &= \min(0.75, 1) = 0.75 \end{aligned}$$

and

$$\mu_{R_2}(\Delta cwnd(k)) = \min(0.75, \mu_{PM}(\Delta cwnd(k)))$$

The membership function $\mu_{R_2}(\Delta cwnd(k))$ is shown as the red region of the output membership function $\mu_{PM}(\Delta cwnd(k))$ defining the linguistic value PM in Fig. 6. Here, we are at most 75% certain that the output $\Delta cwnd(k)$ should be a positive medium value. Therefore, we are more certain of the conclusion reach by rule R_2 than the conclusion reach by rule R_1 .

To convert the conclusions of the inference process to a numerical output, we use Eq. 11 of the defuzzification process. As shown in Fig. 6, the highest values of $\mu_{R_1}(\Delta cwnd(k))$ and $\mu_{R_2}(\Delta cwnd(k))$ is 0.25 and 0.75, respectively. Thus, we have:

$$\sup_{\Delta cwnd} \{\mu_{R_1}(\Delta cwnd(k))\} = 0.25$$

and

$$\sup_{\Delta cwnd} \{\mu_{R_2}(\Delta cwnd(k))\} = 0.75$$

Then, with the output membership function centers $b_1 = 0.4$ and $b_2 = 0.6$, we have:

$$\Delta cwnd(k) = \frac{0.4 \times 0.25 + 0.6 \times 0.75}{0.25 + 0.75} = 0.55$$

5. Evaluation of FLOWER

We use the network simulator ns-2.35 to validate our new protocol. For this purpose, we have implemented an ns-2 prototype of FLOWER based on LEDBAT module developed by Valenti et al. [16]. The prototype is implemented as a Linux congestion control module on top of the TCP-Linux framework [17]. Therefore, simulation results are much closer to a real implementation in the Linux kernel and would allow to easily port our implementation inside the Linux kernel (this also been the case for the LEDBAT module [16]).

We specifically focus on the FLOWER performance in terms of respect to a LBE traffic and latecomer unfairness which are the two major drawbacks of LEDBAT.

5.1. Simulation setup

We use a dumbbell topology where a TCP flow shares a single bottleneck link with a LBE flow (either FLOWER or LEDBAT). Note that to test our protocol, we follow the scenario used in [12] for the sake of comparison. All sources send packets with a size of $P = 1500$ B. The bottleneck link has a capacity set to $C = 10$ Mb/s and a one-way propagation delay $owd \in [10, 50, 100, 150, 200, 250]$ ms. The bottleneck router is a FIFO drop-tail queue with a size of B packets. For convenience, we express the bottleneck buffer B as a ratio to the bandwidth-delay product BDP in terms of packets. Hence, we have $B = \lceil n \cdot BDP \rceil = \lceil n \cdot C \cdot 2 \cdot owd / (8 \cdot P) \rceil$, where the ratio $n \in [0.2, 0.4, 0.6, 0.8, 1.0]$ and $\lceil x \rceil$ is the ceiling function. Since B must be an integer, we use the ceiling function to get the smallest integer not less than B . We also convert the target τ from milliseconds to packets as follows: $\tau(\text{packets}) = \tau(\text{ms}) \cdot C / (8 \cdot P)$. In this paper, we use the target queuing delay $\tau = 100$ ms for all simulations. Therefore, $\tau = 100$ ms corresponds to 83.3 packets and is rounded to 84 packets.

5.2. Interaction with TCP

In this section, we study the behavior of FLOWER in the presence of TCP and more specifically, the interaction between the FLOWER fuzzy controller and the TCP AIMD (Additive Increase/Multiplicative Decrease) algorithm.

5.2.1. Scenario and metrics

Two TCP and LBE flows start at $t = 0$ s and stop at $t = 75$ s. In this scenario, $owd = 50$ ms and $B = BDP$. To investigate the behavior of one LBE flow in coexistence with one TCP flow, we consider their congestion windows and the queue length of the bottleneck buffer.

5.2.2. Results

Fig. 7 shows both congestion windows (top) as a function of time conjointly with the queue length and the target queuing delay expressed in packets (bottom). The interaction between TCP and FLOWER is shown in Fig. 7a. In the slow-start phase, TCP and FLOWER increase exponentially their congestion window. Thus, the bottleneck queue fills up quickly until loss. Unlike TCP, FLOWER reduces its congestion window to its initial value which equals to one packet in our implementation. After the slow-start phase, approximately before $t = 3$ s, as the bottleneck queue is half-filled but the resulting queuing delay is small compared to the target, FLOWER and TCP congestion windows conjointly grow. As the queue still increases because TCP keeps sending packets, FLOWER reduces its sending rate (the target is almost reached) and finally stabilizes its congestion window. After $t = 7.5$ s, when the queuing delay is close to the target, FLOWER reacts by decreasing its sending rate. Finally, FLOWER reaches the minimum sending rate of one packet per RTT at $t = 9.3$ s. Slightly afterwards, TCP gets losses and enters in its recovery phase. As a consequence, TCP halves its congestion window and the bottleneck queue is drained.

TCP re-enters in the congestion avoidance phase at $t = 10$ s while FLOWER grows at its maximum speed as the queue is not fully filled. FLOWER prevents bottleneck overflow by reducing its sending rate before the knee phase [18] (i.e. when the rate increases gradually but slower than the delay). When TCP halves its congestion window at $t = 21.8$ s, we observe an abrupt decrease of the queuing delay. Shortly afterwards, FLOWER detects this decrease with the help of the congestion detection scheme, hence it drops to the minimum its congestion window. Therefore, the queue is drained and FLOWER enters in a new cycle. Henceforth, both FLOWER and TCP are in steady state.

This first experiment illustrates the good LBE behavior of FLOWER in the presence of TCP. Clearly, the fuzzy controller with the congestion detection scheme allows FLOWER to be LBE compliant. In this standard configuration (we recall that $B = BDP$), LEDBAT does not behave as a LBE protocol and is too aggressive as shown in Fig. 7b. This figure also illustrates that the LEDBAT P-type controller does not react correctly to congestion events. We refer the reader to previous studies [6, 14] for further details on the LEDBAT defective behavior.

In the next section, we extend these measurements to several general networking use-cases in order to exhaustively illustrate the good performance of our fuzzy controller scheme.

5.3. FLOWER versus LEDBAT performance in coexistence with TCP NewReno and TCP Cubic

In this section, we evaluate the impact of FLOWER flows on TCP flows (either NewReno or Cubic) in different network conditions.

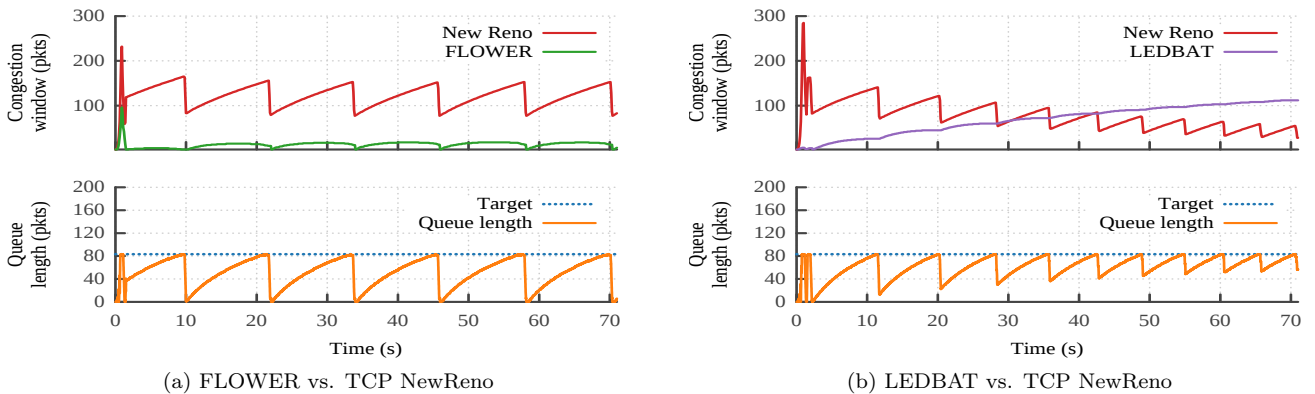

Figure 7: TCP and LBE congestion windows and bottleneck queue length as a function of time.

5.3.1. Scenario and metric

We consider x long-lived TCP flows with x LBE flows where $x \in \{2, 5, 10\}$. The simulation lasts 1200s where TCP flows start consecutively every 10s from $t = 0$ s and keep sending data until the end of simulation. LBE flows start randomly between $t = 350$ s and $t = 450$ s in order for TCP to reach the full capacity.

To assess the impact of LBE on TCP, we define the metric *rate distribution* (X) as the total throughput achieved by all flows F_k where $k \in \{TCP, LBE\}$ over the total throughput of all flows on the link:

$$X_k = \frac{F_k}{F_{TCP} + F_{LBE}} \quad (12)$$

For each combination of network configuration $\{owd, B\}$, we run the simulation 10 times. After each run, we calculate the *rate distribution* over the last 600 seconds. Then, the mean of the 10 metric values is taken as the measured value.

5.3.2. Results

In Fig. 8, using histogram, we group the simulation results into different categories of one-way delay (denoted owd in Fig. 8), and then into subclasses of buffer size given as a ratio to the BDP . For information purpose, note that at the top of the histogram, the equivalent ratio to the BDP is converted as the ratio to the target value given in packets as explained in Section 5.1. This means we express B as the ratio to the target τ in the same way as with the BDP . For instance, looking at Fig. 8, a buffer sized 0.4 of the BDP at $owd = 100$ ms corresponds to 0.7 of target value in packets. For each buffer size, each stacked column gives the sum of the normalized rates obtained by both TCP and LBE flows. Then, each slice inside a column represents the part obtained by x TCP and x LBE flows given by (12).

Fig. 8a, 8c and 8e show the performance of LEDBAT and FLOWER in the presence of TCP NewReno. We have

selected a set of network configurations following our previous study on the LEDBAT performance issues [6]. These network configurations illustrate a large number of use-cases where LEDBAT performs (in Fig. 8a, 8c and 8e, when the ratio of the bottleneck buffer size to the target τ is largely greater than 1) or does not perform correctly (resp. the reverse). As shown in Fig. 8a, 8c and 8e, LEDBAT obtains sometimes more than TCP NewReno and crosses the fair-share line represented by a dotted line. We then compare the results obtained by FLOWER in these configuration. Fig. 8a, 8c and 8e allow to easily compare the performance of both protocols in identical situation. The results are unequivocal and illustrate that FLOWER behaves as a LBE protocol where LEDBAT fails in realistic cases.

Using the same network configurations as above, we now study the performance of LEDBAT and FLOWER in coexistence with TCP Cubic in Fig. 8b, 8d and 8f. TCP Cubic is more aggressive than TCP NewReno but in those cases, the performance of FLOWER is better than LEDBAT in respect of the LBE principle.

5.4. Intra-protocol fairness

We finally study the interaction between two FLOWER flows to assess their intra-fairness and determine whether FLOWER is not impacted by the latecomer issue.

5.4.1. Scenario and metric

In this scenario, the buffer size B is set to twice the BDP . This configuration is favorable to get the LEDBAT latecomer unfairness phenomenon. The bottleneck link has a one-way delay $owd = 50$ ms. The first LBE flow starts at $t = 0$ s and the second starts at $t = 20$ s. Both flows last 150s. As in 5.2, we draw their congestion windows and the queue length of the bottleneck buffer.

5.4.2. Results

Fig. 9b shows the LEDBAT latecomer issue [16]. The first LEDBAT flow starts when the bottleneck queue is

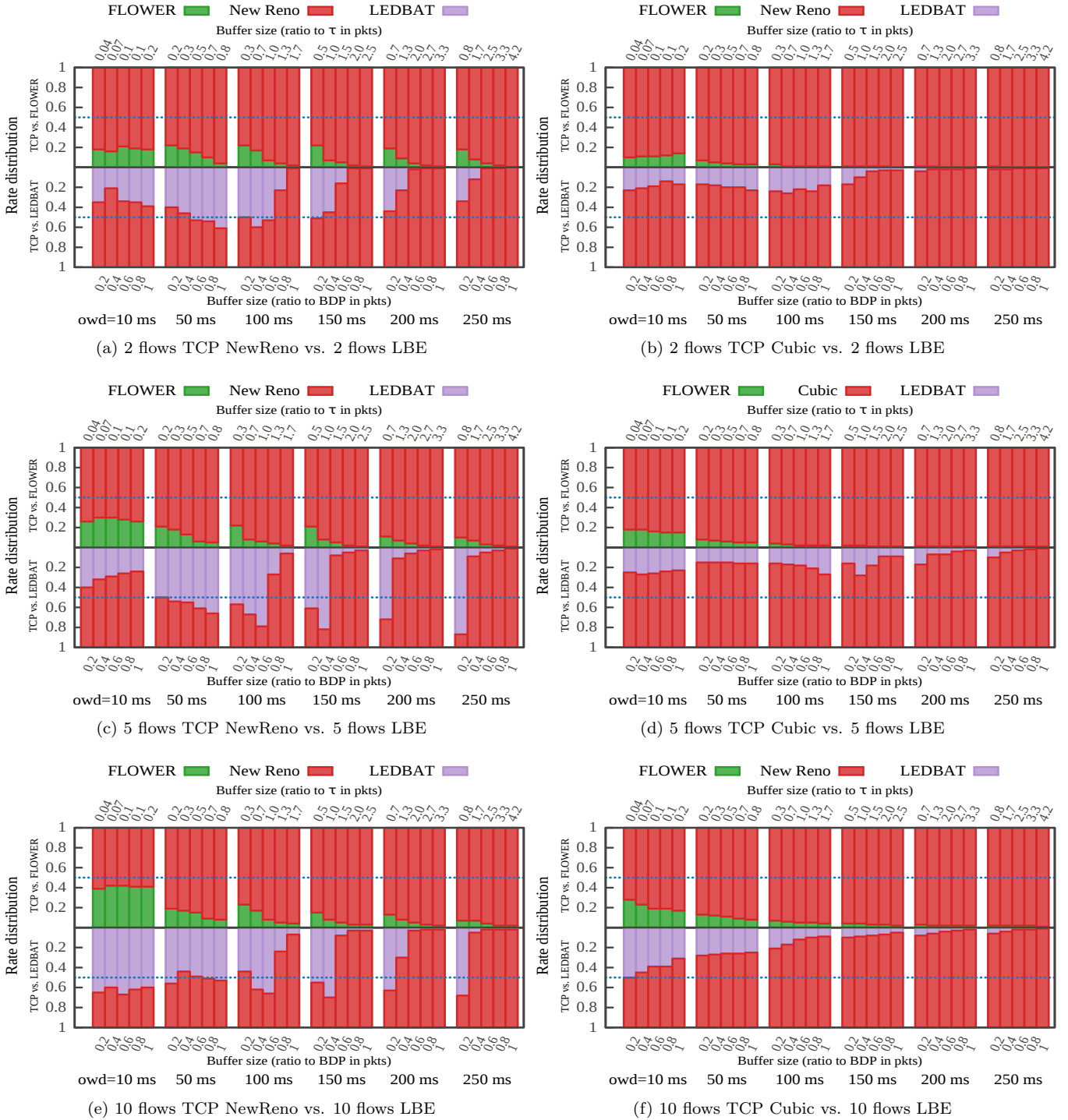

Figure 8: Rate distribution of TCP and LBE flows.

empty, and as a result, senses a base delay. When the second LEBBAT flow starts at $t = 20$ s, the queue is filled with ≈ 50 packets. Consequently, the second flow estimates a higher base delay including the queuing delay of the first one. Since its estimated queuing delays are below the target delay, the second flow raises its sending rate. As a result, the first one senses an increasing queuing delay

and begins to decelerate. Finally, it reaches its minimum rate at $t = 131$ s as shown in Fig. 9b. On the contrary, FLOWER does not inherit this latecomer issue thanks to the congestion detection scheme described in Section 4 as shown in Fig. 9a. This experiment demonstrates that two FLOWER flows can now share fairly the link capacity.

To better understand this experiment, we recall that

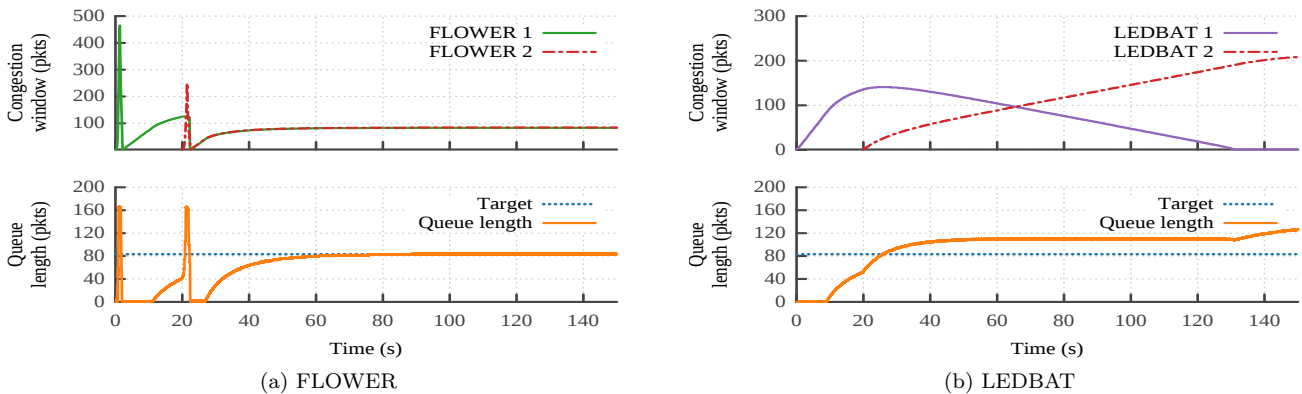

Figure 9: LBE congestion windows and bottleneck queue length as a function of time.

the goal of slow-start is to create a spike in queuing delay when a new FLOWER flow enters in the network. This queuing delay spike should be detected by other ongoing FLOWER flows with the help of the congestion detection zone in the rule table of the fuzzy controller. However, when the bottleneck buffer size is not large enough or when the bottleneck is heavily congested, this queuing delay spike (caused by the slow-start) might be too small to be detected by FLOWER. In general and in this context (i.e. bottleneck heavily congested or small buffer size), the performance of delay-based congestion control protocols heavily suffer from the inaccuracy of the estimated delay as discussed [3].

6. Coexistence of FLOWER and AQM

Active Queue Management (AQM) has been an active research field starting from the QoS epoch. While many schemes have been proposed, their deployment seems very limited although many of them are available in the GNU/Linux kernel. However, recent concern about the excessive network end-to-end delay makes AQM an up to date and hot topic at the IETF today. AQM is usually considered as the best solution to solve this bufferbloat problem [19, 20]. Unfortunately, LBE transport protocols are designed to work mainly under a DropTail queuing discipline.

In the presence of AQM, LEDBAT loses its LBE characteristic and behaves like standard TCP as shown by the authors of [21] and of [22, 12]. LEDBAT RFC also admits this fact [4]: “If Active Queue Management is configured to drop or ECN-mark packets before the LEDBAT flow starts reacting to persistent queue buildup, LEDBAT reverts to standard TCP behavior rather than yielding to other TCP flows”. Therefore, when designing a new LBE protocol (or any kind of novel transport protocol), it is important to study its coexistence with AQM schemes.

In this section, we evaluate the impact of AQM such as RED [23], CoDel [24] and PIE [25] on the LBE-compliance of FLOWER in the presence of standard TCP connections.

We chose to limit our study to these three AQMs as they currently compete at the IETF as a potential solution for the bufferbloat problem [20, 19]. To ease the comparison, we directly employ the scripts used by the authors of this excellent study [12], which are available at [26].

6.1. Active Queue Management Schemes

Before diving into the results, we briefly review and recall the principle behind each AQM tested.

6.1.1. Random Early Detection (RED)

RED randomly dropped packets with a probability p , calculated based on the Exponential Weighted Moving Average (EWMA) q_{avg} of the instantaneous queue length as follows:

$$p(q_{avg}) = \begin{cases} 0 & 0 \leq q_{avg} \leq min_{th}, \\ \frac{q_{avg} - min_{th}}{max_{th} - min_{th}} p_{max} & min_{th} < q_{avg} \leq max_{th}, \\ 1 & q_{avg} > max_{th} \end{cases} \quad (13)$$

where

min_{th} : the minimum threshold,

max_{th} : the maximum threshold,

p_{max} : the maximum probability for packet dropping at the maximum threshold.

In this study, we use the default version of RED in ns-2. In this version, the *gentle_* mode is enabled to make RED more robust; the min_{th} and max_{th} are automatically configured as a function of the target average delay $targetdelay_$, which has a default value of 5 ms.

6.1.2. Controlled Delay (CoDel)

The goal of CoDel is to keep the minimum queuing delay (or sojourn delay) experienced by packets in a fixed interval (100 ms by default) below a target delay (5 ms by default). Therefore, CoDel starts to drop selected packets

when the minimum queuing delay is higher than the target delay. Each time CoDel drops a packet, it sets the next dropping time based on the number of drops since the beginning of the dropping state, as follows:

$$nextDropTime = lastDropTime + \frac{interval}{\sqrt{numOfDrops}} \quad (14)$$

For our test, we use the ns-2 CoDel implementation provided by the scripts of [12].

6.1.3. Proportional Integral Controller Enhanced (PIE)

Similar to CoDel, PIE keeps the queuing delay around a target delay, which has a default value of 20 ms. However, instead of monitoring the real delay for each packet like CoDel, PIE estimates the current queuing delay based on the queue draining rate using Little's law. To determine the dropping probability every t_{update} time units, PIE employs a PI-type controller that takes into account both the current queuing delay and its trend:

$$p = p + \alpha \cdot (queuingDelay - targetDelay) + \beta \cdot (queuingDelay - lastQueuingDelay) \quad (15)$$

where the factors α and β are respectively set to 0.125 and 1.25 by default. The ns-2 implementation of PIE used can be found at [27].

6.2. Scenario and Metrics

We consider five long-lived standard TCP flows jointly with five LBE flows. All flows start at time $t = 0$. In this scenario, $owd = 50$ ms and $B = 250$ pkts = $3 \times BDP$ to reproduce the bufferbloat.

To evaluate the interaction between LBE protocols (LEDBAT, FLOWER) and AQM schemes (RED, CoDel, PIE), we measure the rate distribution of TCP X_{TCP} , the average queue length $E[Q]$ in terms of packet, and the bufferbloat intensity defined as $E[Q]/B$. Note that in [12], the authors denote X_{TCP} as $TCP\%$.

For each combination of LBE protocols and AQM schemes, we run the simulation ten times and each run lasts for 60 s. The mean of the metric values is then taken as the measured values.

6.3. Impact of AQM Schemes on LBE Protocols

We present the simulation results in Figure 10 using a parallel coordinate plot. The left and right y-axes correspond to the bufferbloat intensity $E[Q]/B$ and the rate distribution of TCP, respectively. In the parallel coordinate plot, a line connecting these two metrics represents the interaction of each combination of AQM schemes and LBE protocols. The ideal interaction is illustrated by the green oblique region in Figure 10, in which the queuing delay is low while the LBE traffic remains low-priority.

Under DropTail (denoted DT in Fig. 10), TCP continuously fills up the buffer until loss and therefore maximizes the bufferbloat intensity, as shown in Figure 10. As

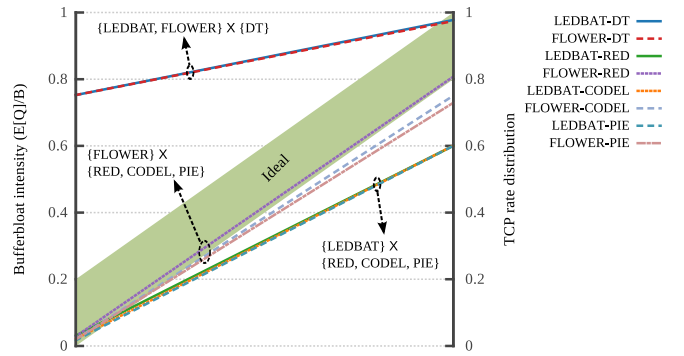

Figure 10: Impact of AQM on LBE protocols.

for LEDBAT and FLOWER, in this case, they are both LBE-compliant, which are represented by TCP shares approaching one. We recall that the goal of LEDBAT and FLOWER is to keep the queuing delay around a fixed target. Nevertheless, this choice of design only limits the exacerbation of bufferbloat but does not solve it.

Figure 10 clearly shows that employing an AQM scheme solves the bufferbloat issue. However, such an AQM scheme also compromises the low-priority characteristic of LBE protocols and raises their aggressiveness towards TCP. In this case, LEDBAT competes quite fairly with TCP. The results for LEDBAT are actually in accordance with the study in [12]. Regarding the new protocol, in all cases, FLOWER is always more LBE-compliant than LEDBAT and tends towards the ideal region. There are two reasons behind this outcome. First, FLOWER has a congestion detection zone in its fuzzy rule base that allows it to react better than LEDBAT in front of congestion. Second, FLOWER resets its congestion window to minimum in case of loss to alleviate its impact on higher priority flows. Both allows to make FLOWER compliant to perform with AQM schemes.

7. Conclusion

We propose FLOWER, a new delay-based congestion control protocol designed to provide a LBE service using results from the fuzzy logic area. The main goal of FLOWER is to overcome both major LEDBAT drawbacks: aggressiveness and latecomer unfairness, while being LBE compliant. Our simulation study over a wide range of network use-cases shows that FLOWER performs better than LEDBAT in case where it usually fails. To the best of our knowledge, FLOWER is the first solution that solves both the aggressiveness issue inherent to LEDBAT protocol and the fairness issue. Last but not least, we finally showed that FLOWER remains compliant with AQM schemes that aim to mitigate the bufferbloat issue.

Acknowledgements

The authors wish to thank CNES and Thales Alenia Space for funding and Cédric Baudoin, Emmanuel Dubois, Patrick Gélard for numerous discussions on this study.

References

- [1] S. Blake, D. Black, M. Carlson, E. Davies, Z. Wang, W. Weiss, An Architecture for Differentiated Services, RFC 2475 (Dec. 1998).
- [2] V. Cerf, V. Jacobson, N. Weaver, J. Gettys, BufferBloat: What's Wrong with the Internet?, *Queue*, ACM 9 (12) (2011) 10–20.
- [3] D. Ros, M. Welzl, Less-than-Best-Effort Service: A Survey of End-to-End Approaches, *Commun. Surveys Tutorials*, IEEE 15 (2) (2013) 898–908.
- [4] S. Shalunov, G. Hazel, J. Iyengar, M. Kuehlewind, Low Extra Delay Background Transport (LEDBAT), RFC 6817 (Dec. 2012).
- [5] G. Carofiglio, L. Muscariello, D. Rossi, C. Testa, A hands-on Assessment of Transport Protocols with Lower than Best Effort Priority, in: *IEEE LCN*, 2010.
- [6] S. Q. V. Trang, N. Kuhn, E. Lochin, C. Baudoin, E. Dubois, P. Gelard, On the existence of optimal LEDBAT parameters, in: *IEEE ICC*, 2014.
- [7] N. Kuhn, O. Mehani, A. Sathiseelan, E. Lochin, Less-than-Best-Effort Capacity Sharing over High BDP Networks with LEDBAT, in: *IEEE VTC Fall*, 2013.
- [8] D. Ros, M. Welzl, Assessing LEDBAT's Delay Impact, *Commun. Lett.*, IEEE 17 (5) (2013) 1044–1047.
- [9] G. Carofiglio, L. Muscariello, D. Rossi, C. Testa, S. Valenti, Rethinking the Low Extra Delay Background Transport (LEDBAT) Protocol, *Comput. Netw.* 57 (8) (2013) 1838–1852.
- [10] A. Venkataramani, R. Kokku, M. Dahlin, TCP Nice: a mechanism for background transfers, *SIGOPS Oper. Syst. Rev.* 36 (SI) (2002) 329–343.
- [11] A. Kuzmanovic, E. W. Knightly, TCP-LP: low-priority service via end-point congestion control, *IEEE/ACM Trans. Netw.* 14 (4) (2006) 739–752.
- [12] Y. Gong, D. Rossi, C. Testa, S. Valenti, M. Täht, Fighting the bufferbloat: on the coexistence of AQM and low priority congestion control, *Comput. Netw.* 65 (2014) 255–267.
- [13] A. Abu, S. Gordon, A Dynamic Algorithm for Stabilising LEDBAT Congestion Window, in: *ICCNT*, 2010.
- [14] D. R. Giovanna Carofiglio, Luca Muscariello, S. Valenti, The Quest for LEDBAT Fairness, in: *IEEE GLOBECOM*, 2010.
- [15] K. Passino, S. Yurkovich, *Fuzzy Control*, Addison-Wesley, 1998.
- [16] D. Rossi, C. Testa, S. Valenti, L. Muscariello, LEDBAT: The New BitTorrent Congestion Control Protocol, in: *ICCCN*, 2010.
- [17] D. X. Wei, P. Cao, NS-2 TCP-Linux: An NS-2 TCP Implementation with Congestion Control Algorithms from Linux, in: *Proc. Workshop Ns-2: The IP Network Simulator*, 2006.
- [18] D.-M. Chiu, R. Jain, Analysis of the Increase and Decrease Algorithms for Congestion Avoidance in Computer Networks, *Comput. Netw. ISDN Syst.* 17 (1) (1989) 1–14.
- [19] N. Khademi, D. Ros, M. Welzl, The new aqm kids on the block: An experimental evaluation of codel and pie, in: *IEEE Conference on Computer Communications Workshops (INFOCOM WKSHPS)*, 2014, pp. 85–90.
- [20] N. Kuhn, E. Lochin, O. Mehani, Revisiting old friends: Is codel really achieving what red cannot?, in: *Proceedings of the 2014 ACM SIGCOMM Workshop on Capacity Sharing Workshop, CSWS '14*, ACM, New York, NY, USA, 2014, pp. 3–8. doi:10.1145/2630088.2630094.
URL <http://doi.acm.org/10.1145/2630088.2630094>
- [21] J. Schneider, J. Wagner, R. Winter, H. Kolbe, Out of my way - evaluating Low Extra Delay Background Transport in an ADSL access network, in: *Teletraffic Congress (ITC)*, 2010 22nd International, 2010, pp. 1–8.
- [22] Y. Gong, D. Rossi, E. Leonardi, Modeling the interdependency of low-priority congestion control and active queue management, in: *2013 25th International Teletraffic Congress (ITC)*, 2013, pp. 1–9.
- [23] S. Floyd, V. Jacobson, Random early detection gateways for congestion avoidance, *IEEE/ACM Transactions on Networking* 1 (4) (1993) 397–413. doi:10.1109/90.251892.
- [24] K. Nichols, V. Jacobson, Controlling queue delay, *Communications of the ACM* 55 (7) (2012) 42–50.
- [25] R. Pan, P. Natarajan, C. Piglione, M. Prabhu, V. Subramanian, F. Baker, B. VerSteeg, PIE: A lightweight control scheme to address the bufferbloat problem, in: *IEEE 14th International Conference on High Performance Switching and Routing (HPSR)*, 2013, pp. 148–155.
- [26] <http://perso.telecom-paristech.fr/drossi/index.php?n=Dataset.LE>
- [27] <https://heim.ifi.uio.no/naeemk/research/PIE/ns-2/>.