



HAL
open science

Influence of hybridisation on eco-driving habits using realistic driving cycles

Daniela Chrenko

► **To cite this version:**

Daniela Chrenko. Influence of hybridisation on eco-driving habits using realistic driving cycles. IET Intelligent Transport Systems, 2015, 9 (5), pp.498-504. <10.1049/iet-its.2015.0005>. <hal-02539742>

HAL Id: hal-02539742

<https://hal.science/hal-02539742v1>

Submitted on 3 Mar 2022

HAL is a multi-disciplinary open access archive for the deposit and dissemination of scientific research documents, whether they are published or not. The documents may come from teaching and research institutions in France or abroad, or from public or private research centers.

L'archive ouverte pluridisciplinaire **HAL**, est destinée au dépôt et à la diffusion de documents scientifiques de niveau recherche, publiés ou non, émanant des établissements d'enseignement et de recherche français ou étrangers, des laboratoires publics ou privés.



Distributed under a Creative Commons CC BY-NC 4.0 - Attribution - Non-commercial use - International License

Influence of hybridisation on eco-driving habits using realistic driving cycles

Daniela Chrenko^{1,2} ✉

¹DRIVE ID-MOTION, EA 1859, Institut Supérieur de l'Automobile et des Transports, University of Burgundy, 49 rue Mille Bourgeois, 58027 Nevers, France

²Transport and Systems Laboratory (IRTES-SeT) – EA 3317/UTBM, University of Technology of Belfort-Montbéliard, Rue Mieg, 90000 Belfort, France

✉ E-mail: daniela.chrenko@u-bourgogne.fr

Abstract: This study covers three main aspects. First, it presents a way to create driving cycles using only driver behaviour (acceleration, deceleration and maximum speed) and route data as input parameters. Second, a power-based approach to describe different vehicle architectures from internal combustion engine vehicle, over stop and start to series and parallel hybrid solutions is presented and respective component modelling approaches are introduced. Finally, the fuel consumption on a given cycle in function of eco-driving parameters is evaluated. It can be seen that hybrid solutions show minimum fuel consumption of about 3 L/100 km, whereas eco-driving habits do change slightly when applied to hybrid architectures because of new technologies such as braking energy recovery.

1 Introduction

Major problems of personal transport are linked to increased fuel consumption and harmful emissions. One goal to make mobility more sustainable is to reduce fuel consumption. Two approaches towards the reduction of fuel consumption are studied, in general; the improvement of vehicle fuel economy by improving the internal combustion engine (ICE) [1, 2] or hybridisation [3–5] and the adaptation of driver attitude towards eco-driving behaviour [6–9].

Until now, fixed driving cycles such as the New European Driving Cycle or United States Environmental Protection Agency Federal Test Procedure city driving cycle (FTP-75) are used. They are well adapted for their initial goals, namely, to provide well defined, repeatable driving cycles to evaluate fuel consumption and emissions for ICE vehicles. As they are available, they are also used in order to predict the performance of hybrid vehicles [10], but as they are not representative of real-world driving, the results might not be realistic. Recent efforts try to harmonise the driving cycles while making them representative such as the worldwide harmonised light vehicles test procedures proposed under the guidance of the United Nations Economic Commission World Forum for Harmonisation of Vehicle Regulations [11, 12] or the Artemis driving cycle, outcome of a large measurement campaign in Europe [13]. Studies on drive patterns in regions such as England [14], UK [15], Sweden [16, 17], China [18, 19] and India [20] have been done and show a strong regional variation. Perceived usefulness of eco-driving assistance systems within 11 European Countries is evaluated by Trommer and Hörtl [21].

Moreover, every driver behaves differently with regard to parameters such as acceleration, braking and top speed, and those parameters might change because of weather and/or traffic conditions. Eco-driving is linked to these driver behaviour parameters. Schiessl *et al.* [22] provide interesting aspects of how to motivate eco-friendly driving. It was shown that eco-driving habits can lead to average fuel economy of 5.8% for personal transport [6] and 7.6% for fleets [15]. Studies were conducted on fleet vehicles [9, 15] and buses [7]. Theoretical studies are often based on dynamic programming and aim to achieve the same drive time for initial and eco-driving approaches [23]. For real-world driving, different studies have been applied, for example, with regard to the influence on following an eco-driving vehicle [24, 25] or the influence of traffic lights [23].

Eco-driving guidelines can be summarised in five principal characteristics [6]:

Acceleration: Moderate acceleration allows to attain the cruising velocity rapidly and is to be preferred over extreme high and extreme low accelerations.

Deceleration: Low deceleration leads to minimum losses during deceleration.

Anticipation: Avoids losses because of unnecessary accelerations or decelerations [26].

Maximum speed: Limitation of the maximum speed leads to limited consumption.

Motor stop: At longer stops the shutdown of the motor reduces idle losses.

Shifting: Low motor speed shifting at about 2000–2500 rpm is advantageous.

Nevertheless, those habits are not only linked to the fuel consumption, but also to drive time – the time needed to cover the distance between two points of the cycle – and a trade-off has to be made between fuel consumption and drive time.

Those eco-driving guidelines have been developed for conventional ICE vehicles [6]. Rutty *et al.* [9] studied hybrid vehicles without focusing on the different potentials; some studies address electric vehicles without exploring the differences [14, 23]. Nowadays, more and more hybrid and electric vehicles are available and vehicles with stop and start have become widely spread [4]. The energy management of those vehicles will be linked to drivers behaviour as well as chosen driving cycle as has been shown for one special case by Liaw *et al.* [27] and Marc *et al.* [28]. Studies of route choice in function of energy consumption and emission is presented by Ahn and Rakha [29].

The goal of this paper contains three aspects: first, the influence of driving parameters on the driving cycle is considered; second, the influence of different hybrid architectures on fuel consumption is evaluated. Third, both aspects are used to evaluate minimum fuel consumption in function of vehicle architecture as well as eco-driving parameters as presented in Fig. 1.

The adaption of the driving cycle with regard to driving parameters is done by introducing a map-based approach of driving cycle generation, which is presented in the next section.

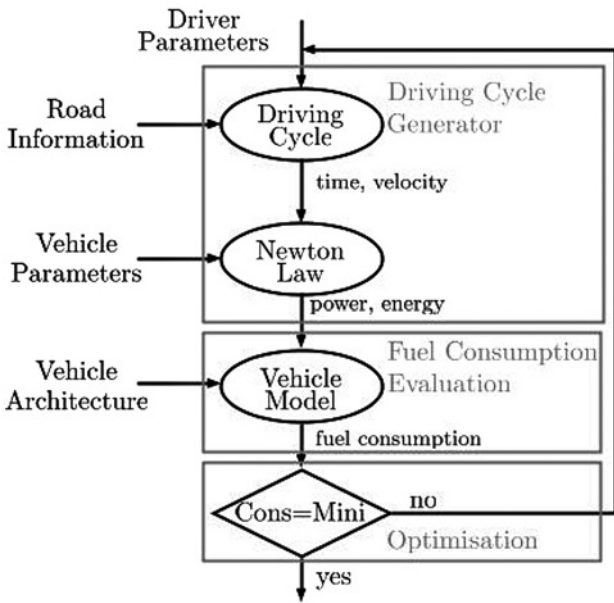

Fig. 1 Illustration of three-fold modelling approach

This approach integrates driver behaviour parameters such as acceleration and deceleration and provides a driving cycle represented by a velocity profile over time; furthermore, it presents the required power and energy to fulfil the evaluated driving cycle.

Section 3 presents how the energy and power demands can be met using different propulsion architectures. This approach is applied on a representative driving cycle and vehicle at the end of the section. The results discussed in Section 4 show possible compromises between fuel consumption and drive time with respect to the different propulsion architectures. The paper ends with conclusions and perspectives.

2 Driving cycle generation

2.1 Construction of a driving cycle section

Other than in conventional driving cycles, which impose a vector of velocity over time, the driving cycles used in this case is based on segments. Each segment is described by its length (d in metres), the average duration to pass through this segment (t in seconds) and the velocity at the end of segment (v_{end} in metre(s)/second). Additionally, the acceleration (acc) and deceleration value (dec) of the vehicle have to be known. On the basis of this information the time-speed-profile in this segment can be evaluated with a

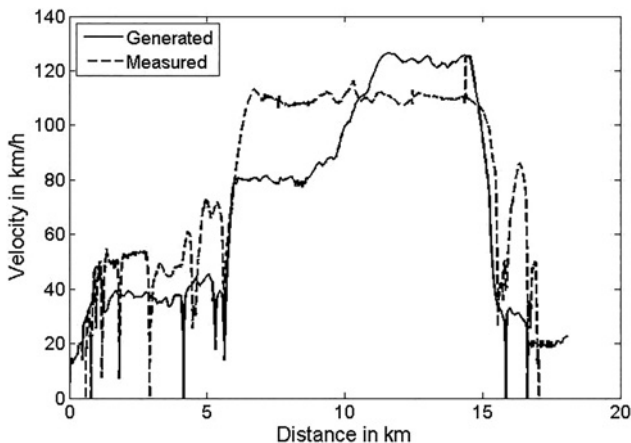

Fig. 2 One segment of a driving cycle

precision of 1 Hz. At the beginning of the segment, the vehicle accelerates according to its constant acceleration value until maximum speed (v_{max}). This maximum speed is defined taking into account the time needed for acceleration and deceleration. At every time step, the distance needed to brake the vehicle is anticipated. As soon as the anticipated distance of braking is reached, the braking process starts.

Each segment contains thus an acceleration phase, a constant velocity phase and a deceleration phase, Fig. 2. The result of this observation leads to a classical driving cycle described by speed over time, with the difference that this driving cycle (velocity and drive time) will vary according to the driver behaviour.

2.2 Using trip planning applications to extract geographic data

The benefit of this approach is revealed if combined with modern route planning software. Multiple sources for route planning exist and deliver segment instructions such as 'Turn left onto ... 800 m'. Furthermore, it is possible to access more detailed data including the duration to pass through the segment and global positioning system (GPS) coordinates of start and end point including altitude.

Hence, most information required to predict the driving cycle are available. The only parameter that is defined by the user is the driver behaviour, represented by three major parameters: acceleration, deceleration and maximum velocity factor, indicating if the driver complies to maximum velocity.

2.3 Comparison of artificial and measured driving cycles

As example a measured driving cycle is compared with the artificial driving cycle. Therefore the same segment information as presented in Table 1 is used. The measurements used for the study are obtained using a C-segment vehicle in off peak hours on a cycle containing urban, extra-urban and motorway segments, with a total length of 18 km. The results are obtained using a Qstarz BT-Q1000EX GPS tracking system with an acquisition frequency of 5 Hz. The measurements were repeated more than ten times in order to evaluate the repeatability of the data acquisition. More details on the approach and comparison with artificial driving cycle evaluation can be found in [30].

The results are presented in Fig. 3. When observing carefully, it can be seen in the middle of the driving cycle that there is a section that has been predicted with a velocity of 90 km/h, whereas the real driving cycle shows a velocity of 110 km/h, this can be explained by the fact that at the moment the directions of the road planning software were evaluated, there was a road construction in this sector limiting the maximum speed to 90 km/h and the software complies to this limitation. This shows that the presented approach is capable to introduce a representative driving cycle, but its limitations are that it does neither comply to environmental conditions such as red lights, construction zones and weather nor to the influence of traffic density, which might impose additional limitations.

2.4 Evaluation of power and energy needs

On the basis of the driving cycle described by the time and velocity vectors as well as the vehicle parameters, it is possible to evaluate the power and energy needs of the vehicle over the given driving cycle. This is done using Newton's second law of motion, considering the acceleration, aerodynamic and rolling resistance as well as hill climbing force.

3 Energy management of different mean of propulsion

To evaluate the fuel consumption required to fulfil the driving cycle, different vehicle architectures use different vehicle components. The description of those different components is given hereafter, before the different vehicle architectures are introduced.

Table 1 Sequences of a representative driving cycle

Instruction	Distance	Duration	Position	Altitude, m
start			46.9908437	3.1631041
head south on...	33 m	3 s	46.990556	3.163045
take the first right onto...	88 m	18 s	46.9903959	3.161906
turn left onto...	366 m	100 s	46.9871853	3.1614299
continue onto...	356 m	36 s	46.9850647	3.1579276
at the roundabout, take the second exit onto...	3295 m	334 s	46.9562528	3.1573258
at the roundabout, take the fourth exit onto...	1154 m	97 s	46.9574643	3.1711748
at the roundabout, take the first exit onto...	344 m	34 s	46.9545404	3.17075
merge onto...	9211 m	313 s	46.876649	3.156799
take exit 38 towards...	393 m	21 s	46.874163	3.153409
at the roundabout, take the fourth exit, go through one roundabout	594 m	84 s	46.8705417	3.1553836
continue straight onto...	489 m	30 s	46.867454	3.159943
at the roundabout, take the first exit and stay on...	307 m	38 s	46.8655422	3.1571464

3.1 Vehicle components

3.1.1 Transmission and electric motor: The transmission links the ICE to the tires. In this case, a six gear transmission system with a differential is chosen. The gear ratio is the same as in comparable vehicles and the regions of gear change are constant. A constant transmission efficiency of 98% is taken into account.

The electric motor is represented by a constant efficiency.

3.1.2 Internal combustion engine: The evaluation of the ICE fuel consumption is based on the work by Asus *et al.* [31]. Using (1), it is possible to evaluate the instantaneous fuel consumption of an ICE. The only required architectural parameter is the cylindrical volume (V_d in cubic metres); the working point is described by rotational speed (N in revolutions per minute) and usable power (P_e in kilowatts)

$$\dot{m}_f = \frac{P_e + (f + f_p N)(V_d N / R_c 60)}{\eta_{f,i}(\eta_{c0} - (A/(B + N)))LHV} \quad (1)$$

with mass flow of fuel (\dot{m}_f in kilogram per second). The friction factor f is assumed to be 100 kPa, the friction factor f_p of 20, the factor R_c equal to 1 for two stroke motors and 2 for four stroke motors, $\eta_{f,i}$ is the fuel indicated efficiency – a factor that is assumed to be constant with 0.4, in reality this factor is varying because of operating point –, the combustion efficiency evaluated using the constant term η_{c0} assumed to be 0.98 and $A/(B + N)$ with A equal to 300 and B equal to 2000 and the lower heating value (LHV) of the fuel used. The internal losses of the ICE are taken into account using a constant value of 300 W. This generic approach is applicable for a large range of ICEs, as there is a linear relation between engine power and cylindrical volume, as

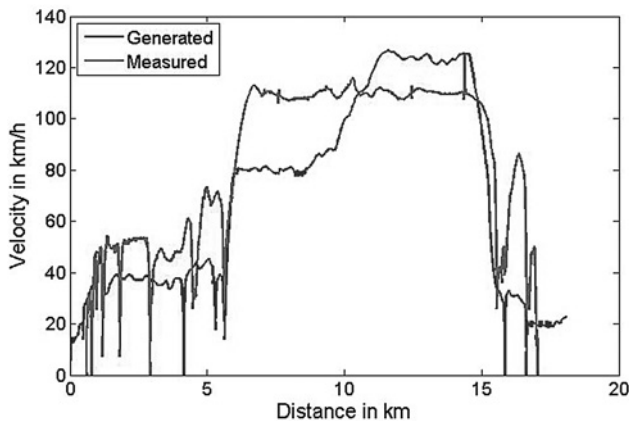
**Fig. 3** Real and artificial driving cycle

well as weight and volume [31] (2)

$$\begin{aligned} P_{\max} &= 0.0446V_d + 5.87, \quad M_{\text{ICE}} = P_{\max}/0.84 \\ L &= 0.0307V_d + 498.92 \end{aligned} \quad (2)$$

with maximum power (P_{\max} in kilowatts), engine weight (M_{ICE} in kilograms) and engine length L in millimetres. Moreover, the maximum torque can be found by $T_{\max} = 0.0879V_d$.

3.1.3 Battery: The lithium-ion battery is modelled using a simple energetic approach containing the power delivered and its current state of charge (SOC). The SOC is evaluated by power integration as is presented in (3)

$$\text{SOC} = \text{SOC}_{\text{init}} - \frac{\int P dt}{C} \quad (3)$$

with SOC_{init} the initial SOC, P is the power demanded from the system in watts and C is the current capacity in joules.

3.2 Different vehicle architectures

The three-fold goal of this paper includes in a second step the evaluation of fuel consumption for a given driving cycle, using different vehicle architectures. In the third step, it will be analysed how the driving parameters have to be adapted in order to find a driving cycle that leads to the best compromise between drive time and fuel consumption. To meet this goal, different vehicle architectures are defined below.

In the case of hybrid vehicles, the ICE will be preferably used around its maximum efficiency working points, in order to minimise the fuel consumption of the overall system.

3.2.1 Conventional ICE vehicle: In a conventional combustion engine vehicle, the energy is supplied by the ICE only. To assure a good working behaviour of the ICE, the engine idle speed is set to be 900 rpm imposing a minimum fuel consumption. No energy can be recovered during braking.

3.2.2 ICE with stop and start: In an ICE with stop and start, the ICE responds to all working points occurring during the cycle. When the vehicle is at rest, the ICE is switched off instead to idle. This engine stop requires more frequent engine starting, therefore starter motor and battery have to be more powerful. Moreover, auxiliaries such as climate control, lighting and entertainment continue to be required at rest, increasing thus the required battery capacity [30]. No energy recovery takes place during braking.

3.2.3 Series hybrid vehicle with ICE and batteries: In a series hybrid vehicle, the energy is supplied by two separate sources, the ICE and a traction battery. The vehicle is propelled by an electric motor on one axle mostly. The energy can be supplied either by the battery or the ICE in combination with a generator, Fig. 4. Therefore the ICE is mechanically decoupled from the

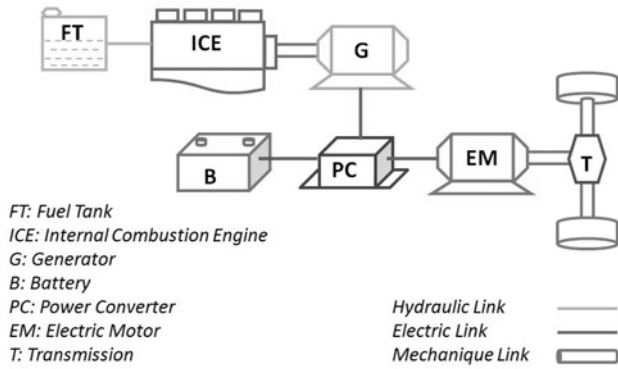

Fig. 4 Architecture of series hybrid vehicle

wheel and can work on every possible working point defined by the rotational speed imposed by the generator and the torque delivered by the ICE [31].

Different control approaches for series hybrid vehicles are available. They can be split in rule-based control approaches and heuristic control approaches [31]. In this case a rule-based thermostat ON-OFF approach is used, Fig. 5 [32]. The working point of the ICE is chosen to be the best efficiency point.

As one part of the propulsion chain consists of an electric motor and a battery and both of those components are reversible, it is possible to recover energy while braking. For reasons of stability and redundancy, there must be a split of braking power between axles for high braking power above 10 kW [33].

3.2.4 Parallel hybrid vehicle with ICE and batteries: In a parallel hybrid vehicle, the energy is also supplied by two separate sources, the ICE and the traction battery (Fig. 6). Different to the series hybrid architecture, the ICE conserves its mechanical link to the wheels thus imposing the use of a gear box. However, the electric motor in combination with the battery can supply energy during acceleration and recover energy while braking in the limits of stability presented above [4].

A multitude of approaches towards parallel hybrid architectures and control are available [32, 34]. They can be rule based or optimisation-based; within optimisation-based approaches especially predictive approaches are currently studied [35]. In our case, a rule-based approach is used, imposing the use of the electric motor and battery at low-power demands without ICE; at high power demands both battery and ICE are used to supply the energy, Fig. 7.

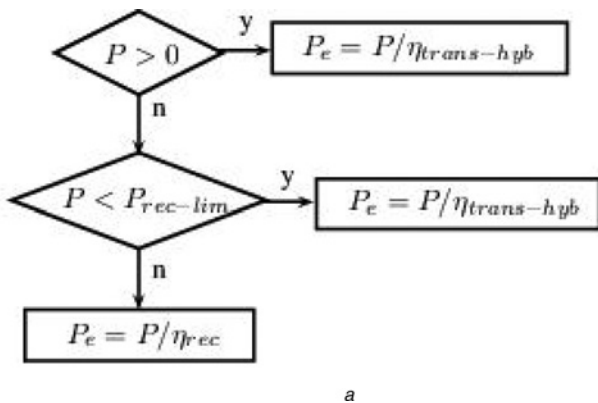

Fig. 5 Control approach of a series hybrid vehicle

a Power
b SOC

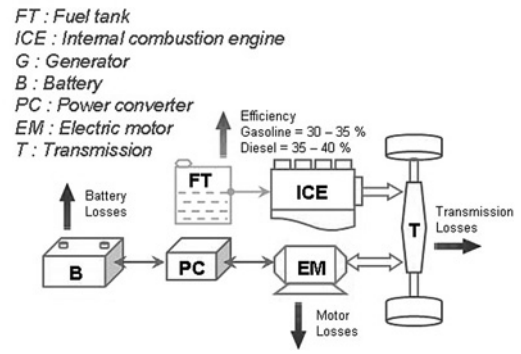

Fig. 6 Architecture of parallel hybrid vehicle

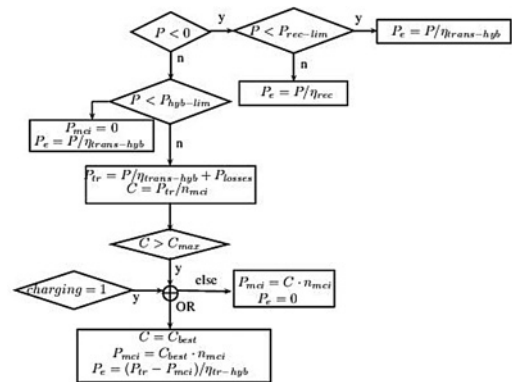

Fig. 7 Control approach of a parallel hybrid vehicle

4 Results and discussion

Goal of this paper is to study the influence of both driver behaviour and vehicle architecture on fuel consumption and drive time. The parameters that influence the driver behaviour are acceleration (acc), deceleration (dec) and maximum velocity factor (f_{v-max}). Therefore a multi-objective optimisation with three input parameters and two output parameters is required. It is solved using a multi-objective genetic algorithm.

4.1 Choice of vehicle and driving cycle

For this paper, a C-segment car (also named 'compact car' in North America) is chosen. A number of generic parameters are chosen for

Table 2 Approximative parameters of a C-segment car

mass	m	1660	kg
frontal surface	S	3.01	m^2
wheel diameter	d	0.6578	m
drag coefficient	C_d	0.31	-
rolling resistance	μ	0.01	-
drive train efficiency		0.9	
ICE best efficiency power	P_{best}	62	kW
ICE maximum power	P_{best}	95	kW
cylindric volume	V_d	2000	cm^3
battery capacity (CA)	CA	1.1	kWh

the modelling, those parameters are introduced in Table 2. The driving cycle presented in Section 2 has been used.

As further parameters minimum SOC (SOC_{min}) is considered to be 30% and maximum SOC (SOC_{max}) to be 80%. At the beginning of the cycle, the battery is charged to SOC_{max} . For hybrid solutions, the battery is recharged by the ICE to its initial value at the end of the cycle in order to obtain comparable fuel consumption values.

The results of the multi-objective function are obtained using a controlled elitist genetic algorithm (a variant of NSGA-II [36]). The different points in the Pareto front (Fig. 8) show combinations of driver behaviour which leads to the best combination of fuel consumption and drive time. The Pareto front incorporates the combined objective to reduce fuel consumption and to decrease drive time. It is because of the consumer to choose a combination of results that fits best to the given demand.

4.2 Influence of vehicle architecture

The ICE is taken as reference in this case, as most of current vehicles are conventional ICE vehicles. It can be seen in Fig. 8 that a minimum drive time of an ICE vehicle is 1115 s. This result would be linked to a relative high fuel consumption of 9.81 L/100 km, whereas a minimum fuel consumption of 8.15 L/100 km would be linked to a relative long drive time of 1646 s. Moreover, Fig. 8 shows the results for the same vehicle including stop and start architectures. It can be seen that the fuel saving potential of a stop and start systems is limited as the analysed cycle shows a limited number of stops.

For a series hybrid architecture, the fuel consumption can be cut down to 4.16 L/100 km for a drive time of 1880 s, whereas at a minimised drive time of 1128 s the total consumption would be 6.71 L/100 km. The parallel hybrid architecture shows results in the same range as the series hybrid architecture with some small advantages at low drive time. Namely, the fuel consumption can be 6.79 L/100 km for a drive time of 1114 s. The minimum fuel consumption that can be achieved by a parallel hybrid on this cycle is 3.95 L/100 km for a drive time of 1782 s.

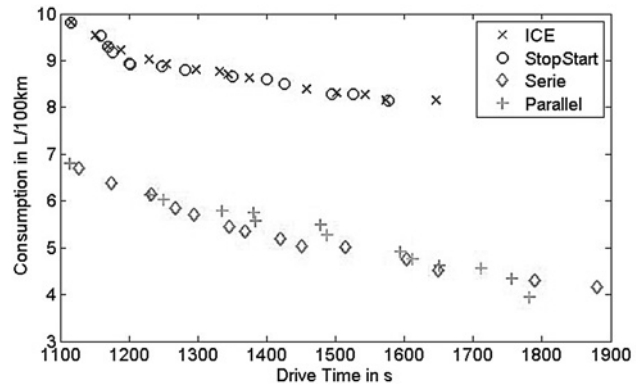

Fig. 8 Pareto front of minimum drive time and fuel consumption

The use of a hybrid architecture shows thus considerable fuel saving potential of about 3 L/100 km over the entire Pareto front, pointing out the interest of hybrid architectures on a realistic driving cycle.

4.3 Influence of driver behaviour

The influence of the different driver behaviour parameters is evaluated in this section. For the acceleration over consumption (Fig. 9a), it can be seen that moderate acceleration is required for ICE and stop/start solution and the best acceleration is about $0.6 m/s^2$, whereas a linear link between acceleration and consumption is less pronounced for the hybrid architectures. With regard to the drive time, a linear link with the acceleration might be detected, even though the tendency is not really clear (Fig. 9b).

For deceleration, the best results of consumption (Fig. 10a) and drive time (Fig. 10b) can be found around minimum value of deceleration about $-0.4 m/s^2$. This can be explained for ICE and stop/start by the limitation of losses. Surprisingly, this link is less evident for hybrid solutions, even though full energy recovery at low deceleration is taken into account in the model.

A nearly linear link between the maximum velocity factor and fuel consumption can be seen (Fig. 11a). It has to be pointed out that the hybrid solution provides fuel economy of about 3 L/100 km, whereas the drive time is as expected not influenced by hybridisation (Fig. 11b).

In conclusion it can be stated that low maximum velocity and acceleration leads to low fuel consumption in combination with long drive time, whereas the deceleration seems to have less influence on fuel consumption, even though regenerative braking is modelled for in hybrid architectures.

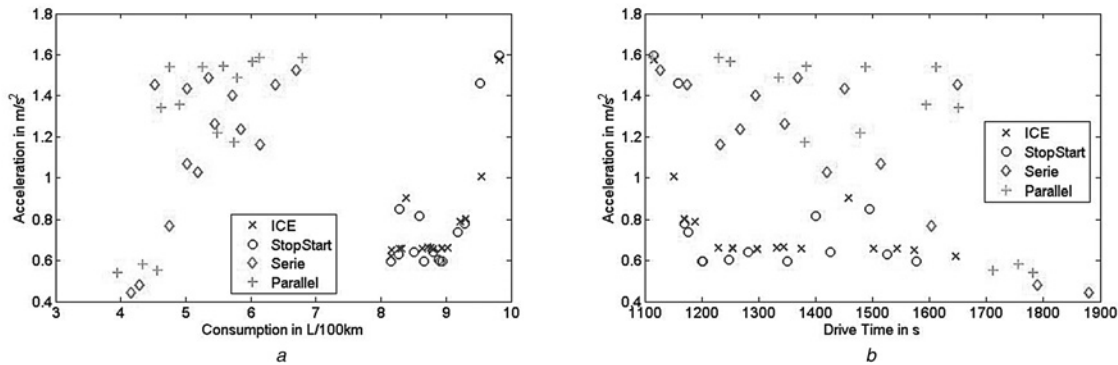

Fig. 9 Influence of acceleration on fuel consumption and drive time

a Consumption
b Drive time

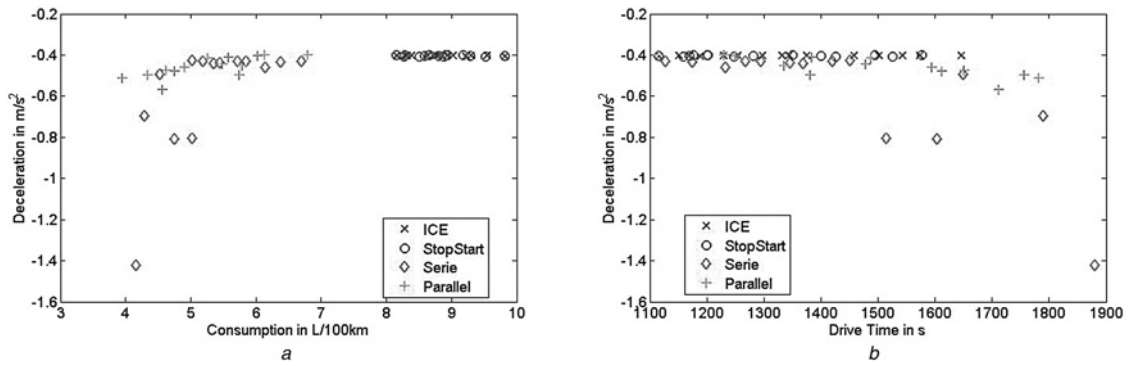

Fig. 10 Influence of deceleration on fuel consumption and drive time
a Consumption
b Drive time

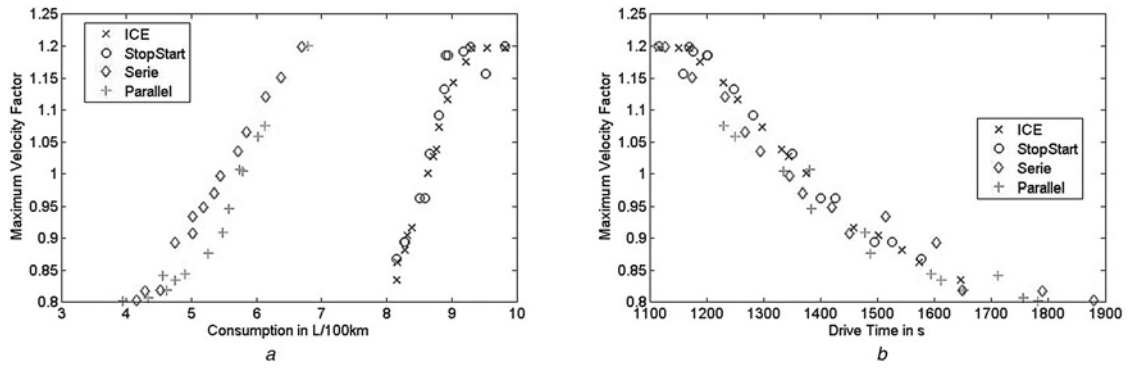

Fig. 11 Influence of velocity factor on fuel consumption and drive time
a Consumption
b Drive time

4.4 Combination of hybrid solutions and eco-driving behaviour

Fig. 8 shows that the minimum fuel consumption of the ICE vehicle is 8.15 L/100 km with a drive time of 1646 s. This value is linked to an acceleration of $0.62 m/s^2$, a deceleration of $-0.40 m/s^2$ and a velocity factor of 0.83. If the same drive parameters are applied to parallel hybrid architecture, this leads to 4.71 L/100 km in 1646 s, which presents – as expected – no improvement in drive time, but an improvement of fuel economy of 42%, whereas the minimum fuel consumption of the hybrid architecture of 3.95 L/100 km is linked to an acceleration of $0.54 m/s^2$, a deceleration of $-0.51 m/s^2$ and a velocity factor of 0.8. It can thus be seen that a further decrease in acceleration and increase in deceleration show an additional fuel economy potential, up to a total improvement of fuel economy by 51%. Therefore it can be concluded that the driving parameters for eco-driving are slightly influenced by vehicle architecture.

5 Conclusions and perspectives

In this paper, three main aspects are covered. First, a novel approach to design driving cycles based on the road informations and driver behaviour is presented opposing to predefined velocity over time profiles that are usually used. It is shown that available data from road planning software can be used to create a driving cycle for virtually any road. A comparison between measured and generated data for the same road showed the interest in this approach.

In a second step C-segment car in different architectures, such as conventional ICE, stop and start as well as series and parallel hybrid

architecture is presented. On the basis of a unique driving cycle the fuel consumption of those different vehicle architectures is evaluated and compared.

Finally, all aspects are combined in order to analyse the fuel economy potential and drive time in function of driver behaviour. It can be seen that hybridisation shows considerable fuel reduction potential of about 3 L/100 km over the entire range of drive times. The analysis of driver behaviour – namely, acceleration, deceleration and maximum velocity factor – shows a linear influence of the maximum velocity factor on fuel consumption and drive time. There is also a linear link between acceleration and fuel consumption that can be remarked mainly for hybrid architecture. Finally, the deceleration shows less influence even though braking energy recovery has been modelled for hybrid architectures. It is furthermore shown that the driver parameters that lead to minimum fuel consumption for the ICE architecture are not the same as the minimum fuel consumption driver parameters for hybrid architectures. In comparison, the acceleration is lower, the deceleration is higher, which leads to an additional fuel economy potential of 16%. It can thus be concluded that the vehicle architecture has an influence of eco-driving behaviour.

In the future, the approach should be refined and improved, and therefore the driving cycle generator might be refined. The description of the vehicle architectures should include more detailed models of different components such as the electric motor and battery. Furthermore, it would be interesting to include aspects of system weight. In addition, eco-driving parameters should be tested in a wider range and for different cycles, moreover additional eco-driving aspects such as coasting or the difference between braking and anticipating should be integrated.

6 References

- 1 Heywood, J.: 'Internal combustion engine fundamentals' (McGraw-Hill, New York, USA, 1988)
- 2 Keromnes, A., Delaporte, B., Schmitz, G., Le Moyne, L.: 'Development and validation of 5 stroke engine for range extenders application', *Energy Convers. Manage.*, 2014, **82**, pp. 259–267
- 3 Mi, C., Masrur, M.A., Gao, D.W.: 'Hybrid electric vehicles – principles and applications with practical perspectives' (Wiley, Hoboken, NJ, USA, 2011)
- 4 Khaligh, A., Li, Z.: 'Battery, ultracapacitor, fuel cell, and hybrid energy storage systems for electric, hybrid electric, fuel cell, and plug-in hybrid electric vehicles: state of the art', *IEEE Trans. Veh. Technol.*, 2010, **59**, (6), pp. 2806–2814
- 5 Hodgkinson, R., Fenton, J.: 'Lightweight electric/hybrid vehicle design' (Butterworth/Heinemann, Oxford, UK, 2001)
- 6 Beusen, B., Broekx, S., Denys, T., *et al.*: 'Using on-board logging devices to study the longer-term impact of an eco-driving course', *Transp. Res. D*, 2009, **14**, pp. 515–520
- 7 Strömberg, H.K., Karlsson, I.M.: 'Comparative effects of eco-driving initiatives aimed at urban bus drivers – results from a field trial', *Transp. Res. D, Transp. Environ.*, 2013, **22**, pp. 28–33
- 8 Saboohi, Y., Farzaneh, H.: 'Model for developing an eco-driving strategy of a passenger vehicle based on the least fuel consumption', *Appl. Energy*, 2009, **86**, pp. 1925–1932
- 9 Ruddy, M., Matthews, L., Andrey, J., Matto, T.D.: 'Eco-driver training within the city of Calgary municipal fleet: monitoring the impact', *Transp. Res. D, Transp. Environ.*, 2013, **24**, pp. 44–51
- 10 Li, C.-Y., Liu, G.-P.: 'Optimal fuzzy power control and management of fuel cell/battery hybrid vehicles', *J. Power Sources*, 2009, **192**, pp. 525–533
- 11 UNECE (United Nations Economic Commission): 'Draft methodology to develop WLTP drive cycle (wltp-dhc-02-05)', September 2009. Available at URL <http://www.unece.org/>
- 12 Demuyneck, J., Bosteels, D., Paepé, M.D., Favre, C., May, J., Verhelst, S.: 'Recommendations for the new WLTP cycle based on an analysis of vehicle emission measurements on NEDC and CADC', *Energy Policy*, 2012, **49**, pp. 234–242, special Section: Fuel Poverty Comes of Age: Commemorating 21 Years of Research and Policy
- 13 André, M.: 'Real-world driving cycles for measuring cars pollutant emissions – part a: the Artemis European driving cycles'. INRETS-LTE 0411, June 2004
- 14 Neaimeh, M., Hill, G., Huübner, Y., Blythe, P.: 'Routing systems to extend the driving range of electric vehicles', *IET Intell. Transp. Syst.*, 2013, **7**, (3), pp. 327–336
- 15 Vagg, C., Brace, C., Hari, D., Akehurst, S., Poxon, J., Ash, L.: 'Development and field trial of a driver assistance system to encourage eco-driving in light commercial vehicle fleets', *IEEE Trans. Intell. Transp. Syst.*, 2013, **14**, (2), pp. 796–805
- 16 Ericsson, E.: 'Variability in urban driving patterns', *Transp. Res. D*, 2000, **5**, pp. 337–354
- 17 Ericsson, E.: 'Independent driving pattern factors and their influence on fuel-use and exhaust emission factors', *Transp. Res. D*, 2001, **6**, pp. 325–345
- 18 Wang, R., Lukic, S.M.: 'Review of driving conditions prediction and driving style recognition based control algorithm for hybrid electric vehicles'. Vehicular Power and Propulsion Conf., Chicago, IL, 2011
- 19 Wang, Q., Huo, H.b., He, K., Yao, Z., Zhang, Q.: 'Characterization of vehicle driving patterns and development of driving cycles in Chinese cities', *Transp. Res. D, Transp. Environ.*, 2008, **13**, (5), pp. 289–297
- 20 Kamble, S.H., Mathew, T.V., Sharma, G.: 'Development of real-world driving cycle: case study of Pune, India', *Transp. Res. D*, 2009, **14**, pp. 132–140
- 21 Trommer, S., Höfl, A.: 'Perceived usefulness of eco-driving assistance systems in Europe', *IET Intell. Transp. Syst.*, 2012, **6**, (2), pp. 145–152
- 22 Schiessl, C., Fricke, N., Staubach, M.: 'Identification and analysis of motives for eco-friendly driving within the eco-move project', *IET Intell. Transp. Syst.*, 2013, **7**, (1), pp. 46–54
- 23 Miyatake, M., Kuriyama, M., Takeda, Y.: 'Theoretical study on eco-driving technique for an electric vehicle considering traffic signals'. 2011 IEEE Ninth Int. Conf. on Power Electronics and Drive Systems (PEDS), 2011, pp. 733–738
- 24 Ando, R., Nishihori, Y.: 'How does driving behavior change when following an eco-driving car?', *Procedia, Soc. Behav. Sci.*, 2011, **20**, (0), pp. 577–587
- 25 Ando, R., Nishihori, Y.: 'A study on factors affecting the effective eco-driving', *Procedia, Soc. Behav. Sci.*, 2012, **54**, pp. 27–36
- 26 Rommerskirchen, C., Helmbrecht, M., Bengler, K.: 'The impact of an anticipatory eco-driver assistant system in different complex driving situations on the driver behavior', *IEEE Intell. Transp. Syst. Mag.*, 2014, **6**, (2), pp. 45–56
- 27 Liaw, B.Y., Jungst, R.G., Nagasubramanian, G., Case, H.L., Doughty, D.H.: 'Modeling capacity fade in lithium-ion cells', *J. Power Sources*, 2005, **140**, (1), pp. 157–161
- 28 Marc, N., Prada, E., Sciarretta, A., *et al.*: 'Sizing and fuel consumption evaluation methodology for hybrid light duty vehicles'. 25th World Battery, Hybrid and Fuel Cell Electric Symp. and Exhibition (EVS), Shenzhen, China, 2010
- 29 Ahn, K., Rakha, H.: 'The effects of route choice decisions on vehicle energy consumption and emissions', *Transp. Res. D, Transp. Environ.*, 2008, **13**, (3), pp. 151–167
- 30 Chrenko, D., Garcia Diez, I., Le Moyne, L.: 'Artificial driving cycles for the evaluation of energetic needs for electric vehicles'. iTEC, 2012
- 31 Asus, Z., Chrenko, D., Aglizim, E.-H., Keromnes, A., Le Moyne, L.: 'Simple method of estimating consumption of internal combustion engine for hybrid application'. iTEC, 2012
- 32 Wirasingha, S.G., Emadi, A.: 'Classification and review of control strategies for plug-in hybrid electric vehicles', *IEEE Trans. Veh. Technol.*, 2011, **60**, (1), pp. 111–122
- 33 Cikanek, S.R., Bailey, K.: 'Regenerative braking system for a hybrid electric vehicle'. Proc. American Control Conf., 2002, vol. 4, pp. 3129–3134
- 34 Schouten, N.J., Salman, M.A., Kheir, N.A.: 'Energy management strategies for parallel hybrid vehicles using fuzzy logic', *Control Eng. Pract.*, 2003, **11**, pp. 171–177
- 35 Mariethoz, S., Bethoux, O., Hilairet, M.: 'A distributed model predictive control scheme for reducing consumption of hybrid fuel cell systems'. IECON 2012 – 38th Annual Conf. on IEEE Industrial Electronics Society, 2012, pp. 868–873
- 36 Deb, K.: 'Multi-objective optimization using evolutionary algorithms' (John Wiley & Sons, Hoboken, NJ, USA, 2001)