



HAL
open science

Large Eddy Simulation of transitional flows in an elliptical finned-tube heat exchanger

Ephraïm Toubiana, Rémi Gautier, Daniel Bougeard, Serge Russeil

► **To cite this version:**

Ephraïm Toubiana, Rémi Gautier, Daniel Bougeard, Serge Russeil. Large Eddy Simulation of transitional flows in an elliptical finned-tube heat exchanger. *International Journal of Thermal Sciences*, 2019, 144, pp.158-172. 10.1016/j.ijthermalsci.2019.05.002 . hal-02538905

HAL Id: hal-02538905

<https://hal.science/hal-02538905v1>

Submitted on 25 Oct 2021

HAL is a multi-disciplinary open access archive for the deposit and dissemination of scientific research documents, whether they are published or not. The documents may come from teaching and research institutions in France or abroad, or from public or private research centers.

L'archive ouverte pluridisciplinaire **HAL**, est destinée au dépôt et à la diffusion de documents scientifiques de niveau recherche, publiés ou non, émanant des établissements d'enseignement et de recherche français ou étrangers, des laboratoires publics ou privés.



Distributed under a Creative Commons Attribution - NonCommercial 4.0 International License

Large Eddy Simulation of transitional flows in an elliptical finned-tube heat exchanger

Ephraïm Toubiana^{a,b}, Rémi Gautier^{a,b}, Daniel Bougeard^{a,b}, Serge Russeil^{a,b,*}

^a*IMT Lille Douai, Institut Mines-Télécom, Energy Engineering Department, F-59508 Douai, France*

^b*Université de Lille, F-59000 Lille, France*

Abstract

Three-dimensional numerical simulations of four rows elliptical finned-tube heat exchanger are performed within a Reynolds numbers range usually used in many applications including the laminar-turbulence transition. A highly-resolved Large Eddy Simulation (LES) approach is chosen in order to get reliable transition-to-turbulence data. This paper presents an analysis of the row-by-row evolution of flow topology and unsteadiness of the complex vortical structure throughout the heat exchanger for various Reynolds numbers. The simulations show several important unsteady and turbulence transition fluid flow features that impact heat transfer. It is found that the topology of the horseshoe vortex system is highly dependent on the row considered. Moreover the unsteadiness of the flow occurs sooner upstream from the trailing edge of the heat exchanger when the Reynolds number increases. At last an important increase of global Nusselt number value is correlated with the vortical turbulent structures and unsteadiness.

Keywords: Horseshoe vortex, LES, Finned-tube heat exchanger, Turbulence

*Corresponding author.

Email address: serge.russeil@mines-douai.fr (Serge Russeil)

1. Introduction

Finned-tube heat exchangers are widely used in several areas such as industrial, transportation, heating and air conditioning systems applications [1, 2]. Various geometrical configurations of finned-tube heat exchangers may be encountered. The tubes shape can be circular, elliptic or flat. Moreover, the tubes arrangement can be in-line or staggered. Due to its widespread utilization, this kind of heat exchangers has been extensively studied experimentally, see Tahseen et al. review [3] and even numerically using laminar [4] or Reynolds-averaged Navier-Stokes models [1]. The laminar-turbulent transition flow condition is commonly encountered in industrial applications of this kind of heat exchangers. However unsteady studies regarding laminar-turbulent transition flow over finned-tube heat exchangers are mainly limited to some unsteady Reynolds-averaged Navier-Stokes turbulence models, see for example Ref. [5].

Regarding the flow topology, several studies have shown that the tubes create a three-dimensional separation, due to adverse pressure gradient generated upstream which causes a reorganization of the boundary layer into a three-dimensional vortical structure called a horseshoe vortex system wrapping around the tube. As early shown by Baker et al. [6] in the case of a single tube mounted perpendicular to flat plate the horseshoe vortex system created is mainly composed of primary and secondary counter-rotating vortices which number, size and stability are linked to geometrical and flow parameters. Sahin et al. [7] investigated experimentally the characteristics of the turbulent flow field in the flow passage of a heat exchanger model comprised of two parallel plates and a cylinder located between the plates. They reported that the flow topology, the size of wake-flow region, the locations of singular points and values of turbulence quantities are strongly affected by the variation of the Reynolds number. Moreover they also studied the horseshoe vortex system in the passage of a plate-fin-and-tube heat exchanger model [8]. They analyzed how the vortices magnify the entrainment process which occurs between the main flow and the wake-flow regions and enhances the heat transfer rate. Simo Tala et al. [9] studied experimentally the flow characteristics in a multi-row plain fin-and-tube heat exchanger and highlighted that vortical system structure have both row-by-row and angular evolutions. Bougeard [10] showed that most of the heat transfer that occurs in the vicinity of the tube is strongly linked to the vortex juncture flow topology.

Nomenclature

a	Semi- major axis of the tube section	(m)
b	Semi- minor axis of the tube section	(m)
F_p	Fin pitch	(m)
F_t	Fin thickness	(m)
P_t	Transversal tube pitch	(m)
P_l	Longitudinal tube pitch	(m)
x, y, z	Coordinates	(m)
u, v, w	Velocity components	$(m \cdot s^{-1})$
u', v', w'	Velocity fluctuations components	$(m \cdot s^{-1})$
u_τ	Wall friction velocity $(= \sqrt{\frac{ \tau }{\rho}})$	$(m \cdot s^{-1})$
u^+	Dimensionless velocity $(= u/u_\tau)$	$(-)$
y^+	Wall distance $(= u_\tau y/\nu)$	$(-)$
k	Turbulent kinetic energy per unit mass $(= \frac{\langle u'^2 \rangle + \langle v'^2 \rangle + \langle w'^2 \rangle}{2})$	$(J \cdot kg^{-1})$
$\Delta x^+, \Delta y^+, \Delta z^+$	Dimensionless grid spacing in x, y, z direction	$(-)$
D_h	Hydraulic diameter $(= 2 \cdot F_p)$	(m)
Nu	Nusselt number	$(-)$
Re_{2b}	Reynolds number based on minor axis $(= U_{in} \cdot 2 \cdot b/\nu)$	$(-)$
St_{2b}	Strouhal number $(= f \cdot 2b/U_{in})$	$(-)$
U_{in}	Inlet velocity (averaged)	$(m \cdot s^{-1})$
T	Temperature	(K)
τ	Wall shear stress	(Pa)
ρ	Density	$(kg \cdot m^{-3})$
q''	Heat flux density	$(W \cdot m^{-2})$
C_p	Specific heat	$(J \cdot kg^{-1} \cdot K^{-1})$
μ	Dynamic viscosity	$(Pa \cdot s)$
ν	Kinematic viscosity	$(m^2 \cdot s^{-1})$
λ	Thermal conductivity	$(W \cdot m^{-1} \cdot K^{-1})$
\mathbf{u}	Velocity vector	$(m \cdot s^{-1})$
$\boldsymbol{\omega}$	Vorticity vector	(s^{-1})
H	Helicity $(= \mathbf{u} \cdot \boldsymbol{\omega})$	$(m \cdot s^{-2})$
σ	Standard deviation	
Σ	Standard deviation divided by the mean value of a quantity	$(-)$
Subscript		
i, j, k	Vector component in x, y, z direction	
$tube$	Tubes	
in	Inlet	
out	Outlet	
Superscript		
$\langle \rangle$	Temporal averaging operator	
$ $	Norm	
Abbreviation		
TKE	Turbulent Kinetic Energy	
LES	Large Eddy Simulation	
$RANS$	Reynolds-averaged Navier-Stokes	

38 Moreover, one of the important phenomenon that occurs when a fluid
39 flows across multiple bluff bodies as in those kind of heat exchangers is the
40 generation of a complex three-dimensional flow structure as a consequence of
41 the mutual interactions among the wakes behind the bodies [11]. These wake
42 interactions subsequently lead to some complex vortex shedding phenomena.
43 Thus, the forced convection heat transfer and then the resulting thermal field
44 are driven by this complex flow structure. Therefore, in order to improve the
45 development of those heat exchangers it is essential to understand the vortex
46 shedding mechanism.

47 As pointed out by Sahin et al. [7] the flow structures in separated flows or
48 wake flows are extremely unsteady. Therefore flows of this type require spa-
49 tial and temporal information of the entire flow fields to allow a quantitative
50 detection of spatial structures. A significant proportion of publications even
51 recent ones does not consider this phenomenon because the simulations are
52 performed with a stationary model see [12, 13] for example. However, a few
53 unsteady simulations carried out on different types of plate fin heat exchang-
54 ers or tube banks heat exchangers show that the vortex shedding phenomena
55 occur. Simo Tala et al. [5] studied with unsteady-RANS model the tube pat-
56 tern effect on thermalhydraulic characteristics in a two-row finned-tube heat
57 exchanger. They pointed out that vortex shedding appearing in the tubes
58 wake under specific conditions. Delibra et al. [14] studied by unsteady-RANS
59 model the flow through a matrix of round pins in staggered arrangement con-
60 necting heated walls of a plane channel. They underline that in contrast to
61 LES, the unsteady-RANS shows some deficiencies in predicting the wakes
62 behind pins, their structure, size and recirculation strength.

63 According to Kritikos et al. [15] the flow field development inside the heat
64 exchanger core is being significantly affected by the main flow surrounding
65 the tubes and an 'X-type' flow is developed. According to them, this type
66 of flow that is surrounding the tubes and their wake regions, remain almost
67 completely stabilized near the trailing edge region of the tubes. However,
68 at the last row of tubes the development of the wake region is not being
69 limited by the 'X-type' flow. This explains that a vortex shedding appears
70 and the flow field develops an unsteady nature. Delibra et al. [14] explain the
71 different behaviour in the last row by the fact that there are no downstream
72 obstructions to feedback the pressure effects upstream.

73 Several authors have investigated unsteady flow in pin fin matrix geome-
74 tries. Such matrix geometries are close to finned-tube heat exchanger geome-
75 tries. The main differences occurs in the number of tubes rows (much larger

76 for pin fins) and channel height (fin pitch for finned-tube heat exchanger
77 which represent a fraction of tube diameter for heat exchanger and several
78 tube (pin) diameter for pin fin matrix). Such numerical investigations in pin
79 fin matrix give insights of hydraulic phenomena that could occur in finned-
80 tube heat exchanger and particularly regarding laminar-turbulent transition
81 phenomena. Delibra et al. underline, that the flow around the first row,
82 impinged by non-turbulent or low free-stream turbulence incoming flow, is
83 laminar with possible separation-induced transition in the wake. That influ-
84 ences the flow structure and heat transfer to a large degree around the sub-
85 sequent two to three pin rows. They add that further downstream, typically
86 beyond the fifth pin row, for Re_{2b} numbers which correspond closely to those
87 usually encountered in practical application, the flow is fully turbulent and
88 almost periodic. Given those complex three-dimensional unsteady phenom-
89 ena, with the turbulent transition problematic depending on the Reynolds
90 some authors use more advanced simulations than stationary RANS. Delibra
91 et al. [16] studied by means of unsteady RANS and by LES simulations
92 the vortex structures and heat transfer in a wall-bounded pin matrix. They
93 found that flow details reveals discrepancies, particularly around the first
94 three pin rows, where the unsteadiness predicted by unsteady-RANS model
95 shows much weaker amplitudes compared with LES. Then only further down-
96 stream, the successive series of pins produced unsteadiness which is captured
97 with unsteady-RANS model similarly to those captured by LES. Regarding
98 Large Eddy Simulations even if becoming more and more used, still very few
99 simulations have been performed on finned-tube heat exchanger. Wen et al.
100 [17] studied by Large Eddy Simulation the flow and heat transfer in a finned
101 tube in direct air-cooled condensers. They also carried out a brief qualitative
102 comparison between the LES and RANS simulations results. They found
103 that unsteady flow fields in the wake region were predicted more precisely by
104 LES method. They also estimated that LES calculations of transient fluid
105 flow and heat transfer behavior, because they take into account wake inter-
106 action and vortex-shedding, provide a foundation for a better design of such
107 heat exchangers.

108 Zhang et al. [20] studied unsteady behaviors of fluid flow and heat trans-
109 fer in plain plate-fin and tube heat exchangers by a Large Eddy Simulation.
110 Their study shows by using comparison with well-known experimental corre-
111 lations, that LES has a better prediction of overall performance plate-fin and
112 tube HX than RANS model. Moreover they point out that LES shows inter-
113 esting unsteady phenomena of vortex shedding behind the tube. It is shown

114 that for small fin pitches the vortex shedding phenomenon development is
115 avoided due to a confinement effect (viscous drag force from the two fins).
116 For larger fin pitches vortex shedding phenomenon happens at dominant fre-
117 quency close to bare tube bank. Unfortunately in their study, they assumed
118 a symmetry plane on mid-plane (50% of the tube height) between two suc-
119 cessive fins which is not a judicious choice in the framework of a Large Eddy
120 Simulation. Even if this boundary condition can allow the development of
121 vortex shedding phenomenon behind the tube it cannot simulate asymmetric
122 vortex shedding in the vertical direction (along fin pitches), increasing the
123 confinement effect. Baker [18] and Sahin [7] show experimentally that such
124 unsteady vortex development occurs in front of the tubes in the horseshoe
125 vortex system. The HSV system is found to be strongly unsteady for range of
126 Reynolds number and for certain fin spacing. In other words the mid-plane
127 symmetry of the horseshoe vortex system could be found only in time aver-
128 age. That is to say that a more rigorous way to capture all the unsteady
129 phenomena that occur in platefin and tube geometry need to avoid the mid-
130 plane assumption. In this article the midplane assumption is not retain to
131 precisely simulate unsteady phenomena of HSV system and vortex shedding
132 in tube wake.

133 Lai et al. [19] performed similar Large Eddy Simulation on plate-fin and
134 tube heat exchangers with small diameter tubes. However in this case they
135 assumed a symmetry plane in the span-wise direction which divide computa-
136 tional domain in the transverse direction to the half of transverse tube pitch.
137 A serious weakness with this assumption, however, is that this symmetry
138 condition does clearly not enable to predict the real instantaneous unsteady
139 behaviour of the well-known vortex shedding phenomenon which is noted by
140 many authors. Setting this symmetry on the topology of the instantaneous
141 flow has a clear influence on the vortex shedding (inhibiting the growth) and
142 also on the separation point on the tube. These two restrictive assumption
143 are not made in the present paper.

144 Regarding the tube shape, some studies have shown that elliptic tube ge-
145 ometry has a better aerodynamic shape than the circular one [21, 22]. In fact,
146 they lead to a lower pressure drop due to the smaller wake region on the fin
147 behind the tube. Simo Tala et al. [5], also studied the effect of the tube shape
148 modification (from circular to elliptic) on the air-side thermallyhydraulic char-
149 acteristics and entropy production rate using Unsteady-RANS simulations.
150 They found an increase of thermal-hydraulic performance of above 80% with
151 the reduction in the tube ellipticity compared with a circular shaped tube.

152 The purpose of this article is to study by Large Eddy Simulation a four
153 rows elliptical finned-tube heat exchanger for four Reynolds numbers in the
154 transitional regime with a particular focus on tubes aero-thermal characteris-
155 tics. This study analyzes both the row-by-row evolution and Reynolds num-
156 ber influence of the complex three-dimensional vortical structure throughout
157 the heat exchanger. Moreover in this study we use wall-resolved LES to char-
158 acterize precisely the influence of turbulence spot and turbulence transition
159 phenomena. An evaluation of the evolution of the unsteadiness, which is
160 related to the transition to turbulence within the heat exchanger, and of its
161 impact to the heat transfer rates is then performed.

162 2. Large Eddy Simulation

163 The Large Eddy Simulation (LES) methodology is used in this paper on
164 a very fine mesh in order to ensure highly resolved simulations together with
165 a subgrid model. This allows to accurately characterizing the unsteadiness
166 and transition phenomena encountered in this kind of flow. This approach,
167 by means of a filtering operation applied to the Navier-Stokes equations,
168 resolves explicitly the dynamics of the unsteady large scales of turbulence
169 while modeling the small scale motions.

170 Three-dimensional CFD calculations are carried out using the finite-volume-
171 based CFD commercial code Starccm+ 10.02. In the present LES simula-
172 tions, the Wall-Adapting Local Eddy-viscosity (WALE) [23] model is used for
173 the modeling of the subgrid scale viscosity and a constant turbulent Prandtl
174 number ($Pr_t = 0.9$) was employed. The WALE model is based on the square
175 of the velocity gradient tensor and takes into account the effects of both
176 strain and rotation rates to obtain the local eddy viscosity. It is specifically
177 designed to return the correct wall-asymptotic y^{+3} behavior of the subgrid
178 scale viscosity. For more accuracy a second order central differencing scheme
179 is used for spatial discretization of the momentum equations. A second or-
180 der formulation is also employed for temporal discretization and the phys-
181 ical time-step is carefully chosen for each simulation in order to produce a
182 maximum local Courant number value of around 1, while the volume aver-
183 aged Courant number is below 0.06 over the whole computational domain.
184 Moreover regarding the fins, the heat diffusion equation is used to solve the
185 temperature distribution.

186
187

The following assumptions are made:

- 188 • the working fluid is air with thermo-physical properties constant except
189 for ρ (ideal gas law)
- 190 • natural convection and radiation are neglected

191 The thermo-physical properties of the air and the aluminum which are
192 used for the heat exchanger fin are tabulated in Table 1.

193 Regarding the data provided by the simulations, before carrying out the
194 data analysis, the achievement of statistical steady state was checked by mon-
195 itoring the volume-averaged turbulent kinetic energy (time-averaged), and
196 the pressure drop (temporal evolution). After waiting for the LES simula-
197 tions to become statistically converged, the LES results are then statistically
198 averaged for an additional time period of more than six flow-through times,
199 while achieving a converged solution at each time-step [34].

200 *2.1. Geometry and computational domain*

201 A staggered fin-and-tube heat exchanger is studied in this paper. It is
202 composed of four elliptical tube rows which ellipticity e is given by $e =$
203 $a/b = 1.5$ (with a the semi-major axis and b the semi-minor axis). The
204 computational domain of the elliptical finned-tube heat exchanger model
205 studied is shown in Figure 1a. The fin pitch chosen is $F_p = 4.3mm$, the
206 transversal pitch $P_t = 21mm$ and the longitudinal pitch $P_l = 20mm$ which
207 are values typically encountered in such finned-tube heat exchangers.

208 The domain is, in the streamwise direction, extended to P_l upstream the
209 heat exchanger and $5 \cdot P_l$ downstream in order to allow the boundary limit
210 condition development on fin leading edge and to let the wake development
211 downstream [24]. In the transversal directions the entire transversal pitch is
212 considered in order to correctly take on consideration the vortex shedding and
213 the entire fin pitch in order to correctly take on consideration the unsteady
214 horseshoes vortices.

215 *2.2. Boundary conditions*

216 Boundary conditions are presented in Figure 1b. It is worth to note that
217 for the problem considered in this paper, we focus on the transition through-
218 out the heat exchanger, so regarding the incoming flow there is no periodicity
219 in the flow direction. Therefore it is necessary to specify turbulence charac-
220 teristics of the incoming flow at the inlet of the computational domain. The
221 Synthetic Eddy Method (SEM) of Jarrin et al. (2006) [25] was chosen to

222 generate a turbulent inlet condition. This method is often used for engineer-
 223 ing application see Ref [26, 27] for example. The inlet turbulence intensity
 224 I_{in} was set to 0.1 and the turbulent length scale was set to 0.3 mm which
 225 corresponds 7% of D_h [28, 29]. A constant inlet velocity is imposed with
 226 four Reynolds numbers $Re_b = 500, 1,000, 1,500, 2,500$ which corresponds
 227 respectively to $U_{in} = 1, 2, 3, 5$ m/s. The air inlet bulk temperature is fixed
 228 to $T_{in} = 300K$ for all the simulations.

229 At the outlet of the heat exchanger the air pressure is fixed to the refer-
 230 ence pressure $1.013 \cdot 10^5 Pa$. Moreover, tubes wall temperature are supposed
 231 constant $T_{tube} = 340K$. Heat conduction is taken into account in conductive
 232 fin (aluminium).

233 2.3. Mesh

234 Concerning the meshing issue, a fully hexahedral mesh is used for all the
 235 simulations. Regarding meshes spacing in wall units, the analysis of the wall
 236 distribution of y^+ shows that the condition of $y^+ < 1$ is achieved for all
 237 the simulations presented in the paper and the surface averaged y^+ value is
 238 less than 0.3. Moreover on core cells (out of the near-wall refinement zone)
 239 each cell is cubic, and grid size was chosen to ensure $x^+ < 18$ and $z^+ < 18$
 240 which are more rigorous than usual recommendations for LES calculations,
 241 see Piomelli et al. [30] for example. Furthermore to quantify the quality
 242 of the mesh resolution, in an a posteriori check, the volume of the cells V
 243 were compared to the Kolmogorov scale $\eta = \left(\frac{\nu^3}{\epsilon}\right)^{1/4}$. To that aim the ratio
 244 $V^{1/3}/\eta$, which represents the ratio between the cell size and the Kolmogorov
 245 scale was estimated by using the time-averaged energy dissipation rate within
 246 each cell $\epsilon = \epsilon_{res} + \epsilon_{SGS}$, where ϵ_{res} is the resolved dissipation rate and
 247 ϵ_{SGS} the modeled dissipation rate. For all the simulations performed and
 248 presented in this paper this ratio was found below 10 over the whole domain
 249 ensuring very precise estimation of turbulent quantity. This very fine grid,
 250 in the entire computational domain and not only in near walls region, is an
 251 important feature. Indeed as shown by Ref. [31], the motions responsible
 252 for the dissipation of turbulent kinetic energy are in the range of 8 to 60
 253 times the Kolmogorov length scale, with a peak of the dissipation at about
 254 24. Thus, considering the ratios that we obtain, the grid density used in
 255 the present simulations is undoubtedly capable of solving a large part of the
 256 dissipation spectrum and ensuring a good prediction of transitional flow. As
 257 an indication, a grid of approximately $6 \cdot 10^6$ cells is used in order to get those

258 well-resolved LES.

259 *2.4. Numerical model validation*

260 To validate the accuracy of the present LES solver the simulation of a
261 flat plate channel flow is performed and compared with Moser et al. [32]
262 DNS data for friction Reynolds number $Re_\tau = 180$. The mesh resolution is
263 similar to that one adopted for LES simulations performed in our geometry
264 and same choices about the numerical model (second order) as well as same
265 analysis procedure. As it can be observed on Figure 2 the present LES results
266 fit very well with the reference DNS data for the the production of turbulent
267 kinetic energy (2a) as well as for the first component of the Reynolds stress
268 tensor (2b).

269 **3. Results and discussion**

270 The results presented here under are divided into three paragraphs. The
271 first paragraph gives a brief overview and analysis of the flow and heat trans-
272 fer characteristics for a basic case of tube-fin junction flow which character-
273 istics remain mainly steady and laminar to introduce the phenomena and
274 terminology. Then it is followed by a second paragraph which analyzes the
275 influence of the tube's row number on the flow and heat transfer character-
276 istics. In the third and main paragraph, the Reynolds number influence on
277 instabilities and turbulent structures formation are investigated.

278 The Nusselt number used in the following paragraphs is defined as follows:

$$Nu = \frac{q'' \cdot D_h}{\Delta T_{lm} \cdot \lambda} \quad (1)$$

279 with

$$\Delta T_{lm} = \frac{(T_{tube} - T_{in}) - (T_{tube} - T_{out})}{\ln[(T_{tube} - T_{in})/(T_{tube} - T_{out})]} \quad (2)$$

280 and q'' the local instantaneous wall heat flux density.

281 *3.1. Basic case analysis: first tube row at $Re_{2b} = 500$*

282 As mention earlier, in the vicinity of each fin/tube junction, several vorti-
283 cal structures may develop due to adverse pressure gradients. The resulting
284 horseshoe vortical systems is then composed of several counter-rotating vor-
285 tices which interact with the fins and tubes walls. In order to introduce
286 this basic flow topology and the corresponding usual terminology, Figure 3

287 presents an illustration of such typical horseshoe vortical structures encoun-
 288 tered upstream a tube in the plane of symmetry of the tube perpendicular
 289 to the fin. We can observe in particular the vortices named primary vortices,
 290 secondary vortices and corner vortex. Figure 4 show the vortical structures
 291 together with the corresponding wall Nusselt distribution on the fin and tubes
 292 wall in order to demonstrate their strong relation. The vortical structures
 293 are highlighted by the vortical Q-criterion [33] and by the helicity $H = \mathbf{u} \cdot \boldsymbol{\omega}$
 294 (with \mathbf{u} the velocity vector and $\boldsymbol{\omega}$ the vorticity vector) in several successive
 295 radial planes around the tubes. For the case presented in this figure we can
 296 find only a single primary vortex and a corner vortex at each fin/tube junc-
 297 tion. It can be observed for $\theta = 0^\circ$ (plane of normal y-axis upstream the tube,
 298 see figure 1c for the definition of θ) a single primary vortex at each junction
 299 (top/bottom fins). For increasing θ angle, it can be noticed that, in the very
 300 near tube area, a counter rotating corner vortex appears and develops as the
 301 primary vortex disappears. Regarding the Nusselt wall distribution, a U-
 302 shape zone of local maximum value of Nu wrapping around the tube can be
 303 noticed on the fins, see letter m_1 on figure 4. It corresponds to the primary
 304 horseshoe vortex imprint. Moreover, on the tube surface, there is also an
 305 area of local maximum Nu values on upstream part of the tube, see letter
 306 m_2 , which is also directly linked to the primary horseshoe vortex. To analyze
 307 more deeply the impact of those vortices on the tube wall, the z-component
 308 of the wall shear stress (τ_k) on the tube is presented in Figure 5 as well as two
 309 radial planes ($\theta = 0^\circ$ and $\theta = 90^\circ$) with tangential velocity vectors to high-
 310 light the flow direction. The red color represents positive value of τ_k whereas
 311 negative values are represented by the blue color. As shown on this figure,
 312 the z-component of the wall shear stress (τ_k) allows to identify the influence
 313 of the near-wall horseshoe vortices on the tubes. Moreover we note that this
 314 figure can be linked with Figure 4. A negative value of τ_k is directly linked
 315 to a positive value of the helicity and vice versa. First of all it can be noticed
 316 that several counter-rotative vortices are present on the tube near-wall area.
 317 Between each near-wall counter-rotative vortices, we notice on the tube wall
 318 a zone where $\tau_k = 0$ (in the junction between $\tau_k > 0$ and $\tau_k < 0$, zones colored
 319 by grey color). In this zone, the tangential velocity vector is normal to the
 320 wall. We refer to an upwash region if velocity vectors are upward-directed
 321 and to a downwash region if velocity vectors are downward-directed towards
 322 the tube wall. As it will be discussed further in the next paragraphs, the con-
 323 figuration of the flow between two counter-rotative vortices has an impact
 324 on heat transfer. Upstream the tube for small angle θ , the downwash zone,

325 is identified by the D_1 letter. This zone is located between the two primary
 326 horseshoe vortices developing upstream. When the θ angle increases from
 327 the stagnation point ($\theta = 0^\circ$), this zone become an upwash zone, identified
 328 in the figure by the letter U_1 . This upwash zone that is located between a
 329 pair of counter-rotative vortices (corresponds to corner vortices) which have
 330 respectively an inverse direction of rotation from the main primary vortices
 331 that they follow. In addition, the corner vortex development with θ angle
 332 from the fin/tube junction for $\theta = 0^\circ$ lead to another upwash zone identified
 333 in the figure by the letter U_2 . Those observations explain the high value of
 334 Nu distribution observed in Figure 4 in the mid-plane area. In fact, in the
 335 downwash zone the velocity configuration lead to the bringing of cold fluid
 336 toward the hot tubes which leads to an increase of the heat exchange. Thus
 337 we observe that the heat transfer on both the tubes and plate-fins is strongly
 338 related to the surrounding flow structure and configuration.

339 3.2. Row impact: row by row evolution for $Re_{2b} = 500$

340 After the presentation, on a basic case, of the flow developing at a fin/tube
 341 junction, the row by row evolution is analyzed here for the four rows heat
 342 exchanger and for one value of the Reynolds number ($Re_{2b} = 500$). The
 343 other simulations for the other Reynolds numbers will be discussed in the
 344 following section.

345 To analyze the flow impact on the tubes near-wall area the z-component of
 346 the time-averaged wall shear stress τ_k distribution are reported on Figure 6a.
 347 Two kinds of topology behavior can be identified. The first one corresponds
 348 to the two first rows of tubes (R_1 and R_2) and the second one corresponds to
 349 the two other ones (R_3 and R_4). For the two first rows of tubes, the topology
 350 had been already described on the basic case. For the two last tubes rows,
 351 the distribution of τ_k is quite different. On half-height of the tube there is
 352 an upwash zone since $\theta = 0^\circ$ (instead of the downwash zone identified on the
 353 same location for the two first rows), which is identified by U'_1 on the figure.
 354 Moreover there is still downwash zones, see D'_1 zone on the figure. Those
 355 downwash zones are not located in the half-height of the tube but on both
 356 sides of it.

357 Regarding the heat transfer the local time-averaged Nusselt number $\langle Nu \rangle$
 358 distribution on the heat exchanger is presented on Figure 7a. First of all we
 359 can observe that $\langle Nu \rangle$ is globally higher for the two first rows. Moreover $\langle Nu \rangle$
 360 has a low value on each tubes wake. Furthermore we can also distinguish
 361 imprints of the horseshoe vortex system on fin $\langle Nu \rangle$ distribution, see letters

362 M_2 , M_3 and M'_5 on the figure. For the two first tube rows, it can be observed
 363 a high value of $\langle Nu \rangle$ close to the half-height zone for small θ angle values,
 364 see letter M_2 on Figure 7a, which corresponds to the downwash zone (see
 365 D_1 letter on Figure 6a). On the contrary for the two last rows, it can be
 366 found a local minimum value of $\langle Nu \rangle$ near to the half-height for small value
 367 of θ angle, which corresponds to upwash zone (see U_1 letter on Figure 6a).
 368 Moreover, the local maximum value of $\langle Nu \rangle$ highlighted on the figure by the
 369 letter M_4 corresponds to the downwash zone observed on Figure 6a, letter
 370 D'_1 .

371 Regarding the angular evolution of the heat exchange over the tubes,
 372 similarly to the flow structure, we can also decompose the four tubes into two
 373 part: the two inlet tubes (two first rows) and the other rows. For the two inlet
 374 tubes it can be noticed that the maximum value of $\langle Nu \rangle$ is reached for $\theta = 0^\circ$
 375 (stagnation line), and with the increase of θ there is an important decrease
 376 of $\langle Nu \rangle$ until $\theta = 158^\circ$ (value taken from results analysis not explained in
 377 details) for the first row and $\theta = 150^\circ$ for the second row. Then there is a very
 378 slight increases of $\langle Nu \rangle$ with θ , where $\langle Nu \rangle$ value nevertheless remains low.
 379 For the two other rows, the behaviour of $\langle Nu \rangle$ according to θ is quite different.
 380 In fact, the maximum value of $\langle Nu \rangle$ is not located near to $\theta = 0^\circ$ ($\theta = 32^\circ$
 381 for R_3 and $\theta = 34^\circ$ for R_4). Moreover this maximum value is significantly
 382 below the maximum value of $\langle Nu \rangle$ for R_1 and R_2 . This can be explained
 383 by the fact that R_3 and R_4 tubes are located in the wake of respectively R_1
 384 and R_2 tubes. This is due to that around $\theta = 0^\circ$ area (upstream face) the
 385 impinging velocity is significantly lower than in the same area for R_1 and R_2
 386 as it can be observed in Figure 10a which is further discussed later. Then
 387 the trend is similar to R_1 and R_2 when θ increases, there is an important
 388 decrease of $\langle Nu \rangle$ with a minimum value at $\theta = 152^\circ$ for R_3 and at $\theta = 132^\circ$
 389 for R_4 . The minimum values of $\langle Nu \rangle$ are located in the recirculation zone
 390 and a low value area of the velocity.

391 Moreover it is interesting to note that the maximum value of $\langle Nu \rangle$ has
 392 been reached by the second row's tube. This could be explained by the
 393 velocity increase around the tube, in comparison to the first row tube, see
 394 Figure 10a. Furthermore the stronger primary horseshoe vortex in the second
 395 tube row lead to the higher peak of $\langle Nu \rangle$ in this zone.

396 3.3. Reynolds influence and unsteadiness

397 The aim of this paragraph is to examine qualitatively the Reynolds num-
 398 ber influence on the flow structure and instabilities, and on the heat transfer

399 throughout the heat exchanger. To this purpose, four Re_{2b} are analyzed here:
 400 $Re_{2b} = 500/1, 1000/1, 500/2, 500$ which include the laminar-turbulence tran-
 401 sition, where RANS models are particularly not reputed to be accurate [34].
 402 The present LES simulations allow identifying precisely the evolution of the
 403 unsteadiness according to each row for each Reynolds number.

404 3.3.1. Flow topology and turbulence

405 Regarding the Reynolds number impact on flow topology near tubes walls,
 406 Figure 6 compare the z-component of the time-averaged wall shear stress τ_k
 407 distribution. It can be noticed that compared to the basic Reynolds number
 408 $Re_{2b} = 500$, when Re_{2b} increase ($Re_{2b} \geq 1, 500$), the near-wall vortices which
 409 are revealed by τ_k are quite similar. However, for the two last tubes rows,
 410 a new pair of counter-rotative vortices appears. This leads to a downwash
 411 zone, identified by D_2 on Figure 6b and 6c which follows the U'_1 upwash zone
 412 and a new significant upwash zone, identified by U_3 .

413 In figure 8, the λ_2 vortex criterion [35] is used to identify instantaneous
 414 vortical structures in the flow passage for three of the Reynold numbers
 415 studied here. Those vortical structures are colored by the time-averaged
 416 turbulent kinetic energy (TKE) with a logarithmic scale. Moreover, in order
 417 to quantify the transition to turbulence inside the heat exchanger, the row-
 418 by-row volume averaged and time averaged TKE k (normalized with the
 419 kinetic energy associated with the inlet velocity $U_{in}^2/2$) is shown on Figure 9
 420 in both linear (9a) and logarithmic scales (9b). The considered volume for
 421 the calculation of each row corresponds to the longitudinal tube pitch (see
 422 the area highlighted by red dotted line for the second tube row in Figure 1c).

423 We observe inside the heat exchanger flow passage that for $Re_{2b} = 500$,
 424 U-shaped vortical structures are symmetrically distributed around each fin-
 425 tube junction. These vortical structures correspond to the horseshoe vortical
 426 systems that are, for this Reynolds number, steady. Indeed, inside the heat
 427 exchanger, the averaged value of normalized TKE (figure 9b) remains at low
 428 values ($k/(U_{in}^2/2) < 0.01\%$) for $Re_{2b} = 500$. For $Re_{2b} = 1000$ the normal-
 429 ized TKE remains low ($< 0.01\%$) but a significant increase (more than one
 430 order of magnitude) is observed from the first row ($\approx 0.01\%$) to the last
 431 row ($\approx 0.2\%$). This indicates that, for $Re_{2b} \leq 1,000$, the horseshoe vortex
 432 system is more and more unsteady as both the Reynolds number and tube
 433 row increase, even if the regime remains laminar inside the heat exchanger.
 434 However, for both $Re_{2b} = 500$ and $Re_{2b} = 1,000$, downstream the heat ex-
 435 changer, Von Karman-like asymmetric vortex shedding is found which shows

436 the unsteadiness of the flow. In this area the flow is significantly more tur-
 437 bulent than in the heat exchanger even if values remain lower than for other
 438 Reynolds numbers. $Re_{2b} = 1,500$ can be viewed as the start of the transi-
 439 tion to turbulence inside the heat exchanger. We notice around the fourth
 440 tube some asymmetric turbulent vortical structures in addition to unsteady
 441 horseshoe vortices. Those vortical structures are responsible to the increase
 442 of TKE (figure 9a) in the vicinity of the fourth tube row ($k/(U_{in}^2/2) \approx 5\%$),
 443 while more than two order of magnitude of TKE is found between the first
 444 ($\approx 0.02\%$) and the fourth tube (figure 9b). It can also be noticed than the
 445 normalized TKE reaches approximately 1% for the third tube. Downstream
 446 the heat exchanger, the vortex shedding is more three dimensional with a
 447 wider range of vortex scale and the maximum value of TKE is closer to the
 448 last tube of the heat exchanger. For $Re_{2b} = 2,500$, it is interesting to note
 449 that the instantaneous turbulent structures are observed already around the
 450 third tube (figure 8), and lead to a global increase of the TKE which reach
 451 6% in this area (figure 9a). Fully turbulent regime is found around the fourth
 452 tube row where the TKE increases up to nearly 20% of the inlet kinetic en-
 453 ergy. Thus, with the increase of Re_{2b} , the unsteadiness, which is developing
 454 downstream the heat exchanger from the last row, moves toward opposite
 455 direction to the flow direction and inner tubes are more impacted as TKE
 456 globally increases within the heat exchanger. The increase of turbulent in-
 457 tensity for the second tubes row is then expected for higher flow regimes
 458 ($Re_{2b} > 2500$).

459 To further illustrate this evolution, Figure 10 shows the instantaneous
 460 velocity magnitude in the mid-plane in-between the fins for the same three
 461 Reynolds numbers. The influence of the evolution of the turbulence accord-
 462 ing to the tube rank and Re_{2b} on the velocity field can be observed. Indeed,
 463 we notice that for $Re_{2b} = 500$, downstream each tube the wake zone is char-
 464 acterized by very low values of velocity. For the fourth tube this zone extends
 465 over a relative large distance until the vortex shedding starts to develop. The
 466 reason lies in the fact that the last tube wake region is not being confined
 467 by the 'X-type flow' (confinement effect due to staggered tubes rows) as this
 468 was named by Kritikos [15]. However when the turbulence increases with the
 469 increase of Re_{2b} , this low velocity area downstream the fourth tube decreases
 470 and almost disappears for $Re_{2b} = 1,500$. Similarly, for $Re_{2b} = 2,500$, down-
 471 stream the third tube, this low velocity zone is significantly reduced with a
 472 more important homogenization of the velocity value.

473 The laminar to turbulence variation can also be assessed by analyzing

474 the row-by-row unsteadiness which can be characterized by the local vari-
 475 ation of velocity's y-component v at several locations within the heat ex-
 476 changer. Here, the adimensional parameter Σ_v , the standard deviation σ_v
 477 divided by the time-averaged value $\langle v \rangle$, is considered. The probes are lo-
 478 cated on the mid-plane inbetween the fins, upstream (named P_{U1} to P_{U4})
 479 and downstream each tube (named P_{D1} to P_{D4}), see Figure 1c. Figure 11a
 480 shows the row-by-row evolution of Σ_v for $Re_{2b} = 2500$ and highlights the
 481 difference of unsteadiness between upstream and downstream of each tube.
 482 Results for the other Reynolds numbers are quite similar: the maximum val-
 483 ues is located downstream the last row and weaker values are found for the
 484 other tube rows. Moreover, for all Reynolds numbers and for each row of
 485 tubes, the upstream values (P_{U_i}) of Σ_v are always greater than the down-
 486 stream ones (P_{D_i}). Then, it is important to point out that the row-by-row
 487 volume-averaged of TKE plotted in Figure 9 mainly depends on fluctuations
 488 occuring in the near wake of each tube. This remark has been confirmed by
 489 the temporal capture of λ_2 criterion where the unsteadiness of the horseshoe
 490 vortices is clearly higher downstream than in the front of the tube. A video
 491 presenting the time-evolution of instantaneous turbulent structures can also
 492 be seen in appendix.

493 A detailed spectral analysis has been done on velocity y-component v for
 494 all tube row at different P_{U_i} and P_{D_i} locations. This analysis shows that
 495 the unsteadiness can be characterized by one or multiple peaks with various
 496 amplitudes depending on tube row and flow regime. Figure 11b shows the
 497 power spectral density of velocity y-component v downstream of the fourth
 498 tube (P_{D4}) at $Re_{2b} = 2500$. A distinct peak is found at $St_{2b} = 0.32$. This
 499 peak is typical of such configuration of plate fin heat exchanger that produces
 500 vortex shedding phenomenon downstream the last tube row, as previously
 501 reported by Zhang et al.[20] on a similar heat exchanger configuration that
 502 the present paper. Moreover, classical turbulence decay of inertial frequencies
 503 at the slope of "-5/3" is also observed for more than one decade downstream
 504 the heat exchanger showing that the energy transfer from the largest to the
 505 smallest turbulence scales is well ensured by the subgrid scale model.

506 In order to understand the vortex shedding phenomenon inside the plate-
 507 fin heat exchanger and its attenuation by the damping phenomenon due
 508 to ducting effect, we present on Figure 11c the presence of the two dom-
 509 inant Strouhal numbers (corresponding of peaks of significant amplitudes)
 510 for $Re_{2b} = 1500$ and $Re_{2b} = 2500$. On this figure, Reynolds and Strouhal
 511 numbers are based on inlet (or bulk) velocity U_{in} and the tube diameter (val-

ues from literature were converted if needed). Results from previous articles [37, 38] are shown as well, where vortex shedding phenomenon in tube bundles were studied. For this configuration, results from [37, 38] shows clearly that specific Strouhal number of $St_D = 0.35$ is found associated with a secondary frequency [37], in that kind of configuration with no fin confinement effect (tube bundle). For plate-fin configuration Zhang et al. [20] reported also the same value outside the coil (after the fourth tube row). Hence, our study confirms the presence of a vortex shedding with $St_{2b} = 0.35$ at the last row of tube showing clearly that the confinement effect does not have any influence on the unsteadiness downstream the last row of tubes (i.e. outside the coil).

The present analysis of unsteadiness for each tube row also confirms on Figure 11c that the fin pitch has a major influence on dominant and secondary frequencies occurring downstream the first three rows inside the coil. In the present study where fin pitch is $F_p = 0.54D$, a primary peak is observed at $St_{2b} = 0.73$ at the third row and a secondary peak is also found at $St_{2b} = 0.49$. For tube bundle (without confinement effect) [37] also reported the Strouhal value of $St_D = 0.49$ as the secondary peak. In the case of confinement effect, but with higher fin pitch than ours (i.e. lower confinement effect), [20] found also this value as the primary peak for the third tube row. Hence, our results tend to confirm the result of Zhang et al. [20] claiming that vortex shedding phenomenon development is avoided due to the confinement effect depending on fin pitches values (see introduction of present article).

The present LES also detected the birth of unsteadiness at the first two rows with very low normalized TKE values (lower than 1%) without the presence of a clear vortex shedding phenomenon (as seen in video and in figure 8). As the tube row increases, there is a drastic increase of turbulence intensity (figure 9) where the vortex shedding phenomena occurs.

3.3.2. Heat transfer

In Figure 7 the time-averaged distribution of the Nusselt number Nu on fin and tubes wall is presented for $Re_{2b} = 500$ (already analyzed in the previous section) and $Re_{2b} = 2,500$. For $Re_{2b} = 500$ very low $\langle Nu \rangle$ values zones are observed downstream each tube. Those zones correspond to the recirculation zones and low values of the velocity. However we can clearly observe that for $Re_{2b} = 2,500$ downstream the third tube row, this relative low $\langle Nu \rangle$ values zone is significantly reduced due to the turbulent unsteady structures. Furthermore downstream the last tube row the zone of low $\langle Nu \rangle$

549 values completely disappeared, see letter M_6 on Figure 7b. We also note that
 550 for the last tube row, the value of $\langle Nu \rangle$ for $\theta \geq 104^\circ$ increases significantly
 551 with a mean (z-direction averaged) maximal value of about $\langle Nu \rangle = 33$ for
 552 $\theta = 180^\circ$ which is about eight time higher than for the first row. In fact
 553 the augmentation of the instabilities leads to a better mixing of the flow
 554 downstream the time-averaged separation point, and then it brings cold fluid
 555 toward the hot fin and tubes wall. In addition, backward facing downstream
 556 part of tube is impacted by backflow coming from outside of heat exchanger
 557 [36]. Moreover, we can note that for $Re_{2b} = 2,500$, unlike for $Re_{2b} = 500$,
 558 the value of $\langle Nu \rangle$ for $\theta = 0^\circ$ of the two last tube rows is of the same order of
 559 magnitude of two first ones. This means that the turbulence increase reduces
 560 the impact of the two first tube rows wake on the two last tube rows leading
 561 edge.

562 We can also notice that the impact of the horseshoe vortices on fin's
 563 time-averaged Nusselt number distribution is clearly visible with a significant
 564 increase noticed at each fin-tube junction. In particular on downwash zones
 565 between two counter-rotative horseshoe vortices, see the zone identified by
 566 M_1 letter. The impact of those tubes near-wall counter-rotative vortices
 567 for each value of Re_{2b} are clearly observable on Nu distribution, see letters
 568 M_2 and M_4 on Figure 7b for $Re_{2b} = 2,500$. Thus the sequence of upwash-
 569 downwash zones due to the counter-rotative vortices systems which leads to
 570 sequences of increases and decreases of $\langle Nu \rangle$ highlights the variety of vortices
 571 on the plate-fin and tube $\langle Nu \rangle$ distribution.

572 In order to analyze quantitatively the impact of the vortices and instabil-
 573 ity on the heat exchanger, we present firstly in Figure 12a the time-averaged
 574 mean value of the Nusselt number on each tube wall according to the row
 575 number. We note that, there is an increase between the first and the sec-
 576 ond tube, then a significant decrease between the second and the third row
 577 and then again an increase between the third and the last row. Moreover
 578 it is interesting to note that the highest time-averaged mean value of Nu is
 579 located on the second-row for the two lower values of Re_{2b} whereas for the
 580 highest value of Re_{2b} it is located on the last row. This shows the impact of
 581 the increase of turbulence on the last tubes row.

582 Secondly, in order to evaluate the impact of the flow unsteadiness on the
 583 global fluctuations of the heat exchange, Figure 12b presents the value of the
 584 standard deviation divided by the time-averaged of the surface averaged Nus-
 585 selt number $\Sigma_{Nu} = \sigma_{Nu}/\langle Nu \rangle$ over each tube. It is found that for $Re_{2b} = 500$,
 586 the value of Σ_{Nu} is almost constant according to the tube row, with a very

587 low value i.e. $\Sigma_{Nu} = 0.6\%$. Thus the instabilities of the tubes Nusselt num-
 588 ber are negligible whatever the row position. For $Re_{2b} = 1,000$ though that
 589 Σ_{Nu} has a low value for each tube's row, it can be observed a slight increase
 590 of Σ_{Nu} for the two last rows which reflects an increase of Nu unsteadiness.
 591 For $Re_{2b} = 1,500$ the increase of Σ_{Nu} for the two last rows is even more
 592 significant with $\Sigma_{Nu} = 1.5\%$ for the last tube row. Finally, for $Re_{2b} = 2,500$,
 593 the value of Σ_{Nu} reaches about 2% for the third tube and nearly 5% for the
 594 last row. Those relative high values of Σ_{Nu} can be correlated with the mean
 595 value of $\langle Nu \rangle$ observed on the two last tubes presented on Figure 12a. In
 596 fact the value of $\langle Nu \rangle$ of the last tube rows for $Re_{2b} = 2,500$ are the highest
 597 values compared to the two first tube rows $\langle Nu \rangle$ values (unlike for the lower
 598 values of Re_{2b}). For comparison we can notice that for $Re_{2b} = 500$ between
 599 the first tube row and the last tube row there is an important decrease of
 600 about 50% whereas for $Re_{2b} = 2,500$ there is an increase of about 30%.

601 The comparison between Figure 12b and Figure 9 also shows that devi-
 602 ations of Nusselt numbers are globally in correlation with turbulent fluctua-
 603 tions suggesting that the row-by-row heat transfer fluctuations can be linked
 604 to the TKE budget. Thus, this analysis highlights how the unsteadiness and
 605 turbulence evolve according to the Reynolds number and the tube rows, and
 606 the correlation between the unsteadiness and the increase of the tubes heat
 607 exchange.

608 4. Conclusion

609 Numerical simulations have been carried out in a multi-rows elliptical
 610 finned-tube heat exchanger for four Reynolds numbers in the transitional
 611 regime by means of highly resolved Large Eddy Simulations. The evolution
 612 of the three-dimensional flow and its impact on heat transfer was studied
 613 throughout the heat exchanger (row by row). In a first part, a focus on a ba-
 614 sic case (i.e the first row at the lower Reynolds number) has been presented in
 615 order to highlight the strong interactions between the flow topology includ-
 616 ing the horseshoe vortex system and the wall heat transfer, with a particular
 617 focus on the tubes.

618 In a second part, the influence of the tube row position of this four rows
 619 finned-tube heat exchanger was studied. It was found mainly that the topol-
 620 ogy of the near tube area counter-rotative vortices is highly dependent on the
 621 row considered. The variation of the counter-rotative vortices configurations
 622 leads to several upwash or downwash near wall flow configurations. Those

623 flow configurations lead to a clear variation on Nu distribution according to
624 the row position. Thus it was possible to distinguish the flow configuration
625 and heat transfer around the tubes rows into two parts i.e the two first rows
626 and the two last rows.

627 In a third part, the influence of the Reynolds number was studied. The LES
628 approach used in this study allowed analyzing how the transition to turbu-
629 lence occurs within the heat exchanger as well as the unsteadiness and its
630 impact on heat transfer. It was found that for the two lower Re_{2b} studied
631 ($Re_{2b} = 500$ and $Re_{2b} = 1,000$), the unsteadiness was mainly located on the
632 last tube row wake with Von Karman-like vortices developing outside down-
633 stream the heat exchanger. However when the Reynolds number increases the
634 unsteadiness becomes very significant within the heat exchanger. Thus, for
635 $Re_{2b} = 1,500$, more three-dimensional turbulent vortical structures appears
636 in the vicinity of the last tube row, and for $Re_{2b} = 2,500$ the unsteadiness
637 appears even more upstream with important turbulent vortical structures
638 around the third tube row. Then it was found that the unsteadiness of the
639 flow occurs sooner upstream from the trailing edge of the heat exchanger
640 when the Reynolds number increases. Moreover regarding the tubes surface
641 averaged Nu unsteadiness, for $Re_{2b} = 500$ no particular unsteadiness was
642 observed even on the last tube. For $Re_{2b} = 1,000$ the unsteadiness was also
643 very low but a slight increase of the unsteadiness was observed for the two
644 last tube rows. For $Re_{2b} = 1,500$ and $Re_{2b} = 2,500$ a significant more im-
645 portant increase of the unsteadiness was found for the two last rows. This
646 behaviour is shown to be in correlation with the TKE production determined
647 by tube rows versus Reynolds Number. Finally an important increases of Nu
648 value correlated with the vortical turbulent structures and unsteadiness was
649 highlighted.

650 Further development would be to assess the performance of more simpli-
651 fied turbulence models such as unsteady-RANS models or even RANS model
652 that are still used in evaluating the unsteadiness, and the laminar-turbulent
653 transition. Are they correctly revealing the main vortical structures together
654 with its interaction in those kind of heat exchanger.

655 **Acknowledgments**

656 The present work was supported by OSEO [grant contract number F1012001
657 R, OSEO] within the framework of a French joint programme: FUI-AAP10
658 Project CAFEE.

659 **References**

- 660 [1] L. Tian, Y. He, Y. Tao, W. Tao, A comparative study on the air-side
661 performance of wavy fin-and-tube heat exchanger with punched delta
662 winglets in staggered and in-line arrangements, *International Journal of*
663 *Thermal Sciences* 48 (9) (2009) 1765 – 1776.
- 664 [2] Z. Wu, G. Ding, K. Wang, M. Fukaya, Application of a genetic algo-
665 rithm to optimize the refrigerant circuit of fin-and-tube heat exchangers
666 for maximum heat transfer or shortest tube, *International Journal of*
667 *Thermal Sciences* 47 (8) (2008) 985 – 997.
- 668 [3] T. A. Tahseen, M. Ishak, M. Rahman, An overview on thermal and fluid
669 flow characteristics in a plain plate finned and un-finned tube banks heat
670 exchanger, *Renewable and Sustainable Energy Reviews* 43 (2015) 363 –
671 380.
- 672 [4] J. Herpe, D. Bougeard, S. Russeil, M. Stanciu Numerical investigation
673 of local entropy production rate of a finned oval tube with vortex gen-
674 erators, *International Journal of Thermal Sciences* 48 (5) (2009) 922 –
675 935
- 676 [5] J. Simo Tala, D. Bougeard, S. Russeil, J.-L. Harion, Tube pattern ef-
677 fect on thermalhydraulic characteristics in a two-row finned-tube heat
678 exchanger, *International Journal of Thermal Sciences* 60 (2012) 225 –
679 235.
- 680 [6] C. Baker, The laminar horseshoe vortex, *Journal of Fluid Mechanics*
681 95 (02) (1979) 347–367.
- 682 [7] B. Sahin, A. Akkoca, N. Öztürk, H. Akilli, Investigations of flow charac-
683 teristics in a plate fin and tube heat exchanger model composed of single
684 cylinder, *International Journal of Heat and Fluid Flow* 27 (3) (2006) 522
685 – 530.
- 686 [8] B. Sahin, A. Demir, Thermal performance analysis and optimum de-
687 sign parameters of heat exchanger having perforated pin fins, *Energy*
688 *Conversion and Management* 49 (6) (2008) 1684 – 1695.
- 689 [9] J. Simo Tala, S. Russeil, D. Bougeard, J.-L. Harion, Investigation of the
690 flow characteristics in a multirow finned-tube heat exchanger model by

- 691 means of PIV measurements, *Experimental Thermal and Fluid Science*
692 50 (2013) 45 – 53.
- 693 [10] D. Bougeard, Infrared thermography investigation of local heat transfer
694 in a plate fin and two-tube rows assembly, *International Journal of Heat*
695 *and Fluid Flow* 28 (5) (2007) 988 – 1002.
- 696 [11] D. Chatterjee, G. Biswas, S. Amiroudine, Numerical investigation of
697 forced convection heat transfer in unsteady flow past a row of square
698 cylinders, *International Journal of Heat and Fluid Flow* 30 (6) (2009)
699 1114 – 1128.
- 700 [12] L. Li, X. Du, Y. Zhang, L. Yang, Y. Yang, Numerical simulation on
701 flow and heat transfer of fin-and-tube heat exchanger with longitudinal
702 vortex generators, *International Journal of Thermal Sciences* 92 (2015)
703 85 – 96.
- 704 [13] L. Sun, C.-L. Zhang, Evaluation of elliptical finned-tube heat exchanger
705 performance using CFD and response surface methodology, *International*
706 *Journal of Thermal Sciences* 75 (2014) 45 – 53.
- 707 [14] G. Delibra, D. Borello, K. Hanjalić, F. Rispoli, URANS of flow and
708 endwall heat transfer in a pinned passage relevant to gas-turbine blade
709 cooling, *International Journal of Heat and Fluid Flow* 30 (3) (2009) 549
710 – 560
- 711 [15] K. Kritikos, C. Albanakis, D. Missirlis, Z. Vlahostergios, A. Goulas,
712 P. Storm, Investigation of the thermal efficiency of a staggered elliptic-
713 tube heat exchanger for aeroengine applications, *Applied Thermal En-*
714 *gineering* 30 (23) (2010) 134 – 142.
- 715 [16] G. Delibra, K. Hanjalić, D. Borello, F. Rispoli, Vortex structures and
716 heat transfer in a wall-bounded pin matrix: LES with a RANS wall-
717 treatment, *International Journal of Heat and Fluid Flow* 31 (5) (2010)
718 740 – 753
- 719 [17] J. Wen, D. Tang, Z. Wang, J. Zhang, Y. Li, Large eddy simulation of flow
720 and heat transfer of the flat finned tube in direct air-cooled condensers,
721 *Applied Thermal Engineering* 61 (2) (2013) 75–85.

- 722 [18] C. Baker, The turbulent horseshoe vortex, *Journal of Wind Engineering*
723 and *Industrial Aerodynamics* 6 (12) (1980) 9 – 23.
- 724 [19] Y. Lai, M. Lu, Q. Wang, A large eddy simulation of plate-fin and tube
725 heat exchangers with small diameter tubes, *Heat Transfer Engineering*
726 35 (11-12) (2014) 1137–1143.
- 727 [20] L.-Z. Zhang, W.-C. Zhong, J.-M. Chen, J.-R. Zhou, Fluid flow and heat
728 transfer in plate-fin and tube heat exchangers in a transitional flow
729 regime, *Numerical Heat Transfer, Part A: Applications* 60 (9) (2011)
730 766–784.
- 731 [21] S. A. N. Bordalo, F. E. M. A. Saboya, Pressure drop coefficients for
732 elliptic and circular sections in one, two and three-row arrangements of
733 plate fin and tube heat exchangers, *Journal of the Brazilian Society of*
734 *Mechanical Sciences* 21 (1999) 600 – 610.
- 735 [22] J.-Y. Jang, J.-Y. Yang, Experimental and 3-d numerical analysis of the
736 thermal-hydraulic characteristics of elliptic finned-tube heat exchangers,
737 *Heat Transfer Engineering* 19 (4) (1998) 55–67.
- 738 [23] F. Nicoud, F. Ducros, Subgrid-scale stress modelling based on the square
739 of the velocity gradient tensor, *Flow, Turbulence and Combustion* 62 (3)
740 (1999) 183–200.
- 741 [24] C.-W. Lu, J.-M. Huang, W. Nien, C.-C. Wang, A numerical investigation
742 of the geometric effects on the performance of plate finned-tube heat
743 exchanger, *Energy Conversion and Management* 52 (3) (2011) 1638 –
744 1643.
- 745 [25] N. Jarrin, S. Benhamadouche, D. Laurence, R. Prosser, A synthetic-
746 eddy-method for generating inflow conditions for large-eddy simulations,
747 *International Journal of Heat and Fluid Flow* 27 (4) (2006) 585 – 593
- 748 [26] N. Gourdain, Prediction of the unsteady turbulent flow in an axial com-
749 pressor stage. part 1: Comparison of unsteady RANS and LES with
750 experiments, *Computers & Fluids* 106 (2015) 119 – 129.
- 751 [27] A. Colleoni, A. Toutant, G. Olalde, Simulation of an innovative internal
752 design of a plate solar receiver: Comparison between RANS and LES
753 results, *Solar Energy* 105 (2014) 732 – 741.

- 754 [28] O. Zikanov, Essential computational fluid dynamics, John Wiley & Sons,
755 2010.
- 756 [29] J. V. Simo Tala, S. Russeil, D. Bougeard, J.-L. Harion, Numerical analy-
757 sis of the fin spacing effect on the horseshoe vortex system evolution in a
758 two-row finned-tube heat exchanger, International Journal of Numerical
759 Methods for Heat & Fluid Flow 23 (7) (2013) 1136–1154.
- 760 [30] U. Piomelli, E. Balaras, Wall-layer models for large-eddy simulations,
761 Annual Review of Fluid Mechanics 34 (1) (2002) 349–374.
- 762 [31] O. Lehmkuhl, I. Rodríguez, A. Baez, A. Oliva, C. Pérez-Segarra, On the
763 large-eddy simulations for the flow around aerodynamic profiles using
764 unstructured grids, Computers & Fluids 84 (0) (2013) 176 – 189.
- 765 [32] R. D. Moser, J. Kim, N. N. Mansour, Direct numerical simulation of
766 turbulent channel flow up to $Re = 590$, Physics of Fluids 11 (4) (1999)
767 943–945.
- 768 [33] W. A. A. Hunt, J. C. R., P. Moin, Eddies, stream, and convergence
769 zones in turbulent flows, Center for Turbulence Research Report CTR-
770 S88 (1988) pp. 193–208.
- 771 [34] E. Toubiana, S. Russeil, D. Bougeard, N. François, Large eddy simula-
772 tion and Reynolds-Averaged Navier-Stokes modeling of flow in staggered
773 plate arrays: Comparison at various flow regimes, Applied Thermal En-
774 gineering 89 (2015) 405 – 420.
- 775 [35] J. Jeong, F. Hussain, On the identification of a vortex, Journal of Fluid
776 Mechanics 285 (1995) 69–94.
- 777 [36] R. Romero-Méndez, M. Sen, K. T. Yang, R. McClain, Effect of fin spac-
778 ing on convection in a plate fin and tube heat exchanger, International
779 Journal of Heat and Mass Transfer 43 (1) (2000) 39 – 51.
- 780 [37] S. Balabani, M. Yianneskis, Vortex shedding and turbulence scales in
781 staggered tube bundle flows, The Canadian Journal of Chemical Engi-
782 neering 75 (5) (1997) 823–831
- 783 [38] C. Liang, G. Papadakis Large eddy simulation of cross-flow through a
784 staggered tube bundle at subcritical Reynolds number, Journal of Fluids
785 and Structures 23 (8) (2007) 1215–1230

Table 1: Thermo-physical properties of the air and fin

	C_p ($J \cdot kg^{-1} \cdot K^{-1}$)	λ ($W \cdot m^{-1} \cdot K^{-1}$)	ρ ($kg \cdot m^{-3}$)	μ ($Pa \cdot s$)
Air	1003.62	0.026	$353.02/T$	$1.86 \cdot 10^{-5}$
Fin	903	237	2702	

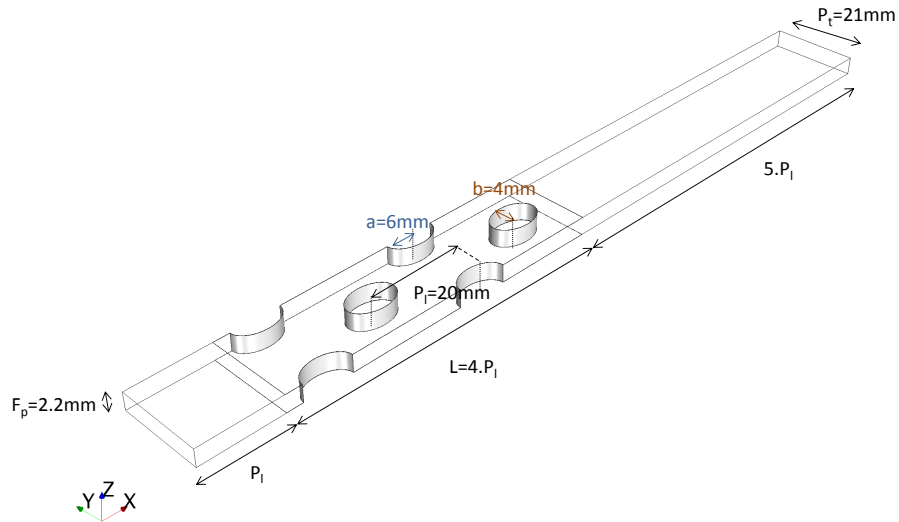

(a) Computational domain

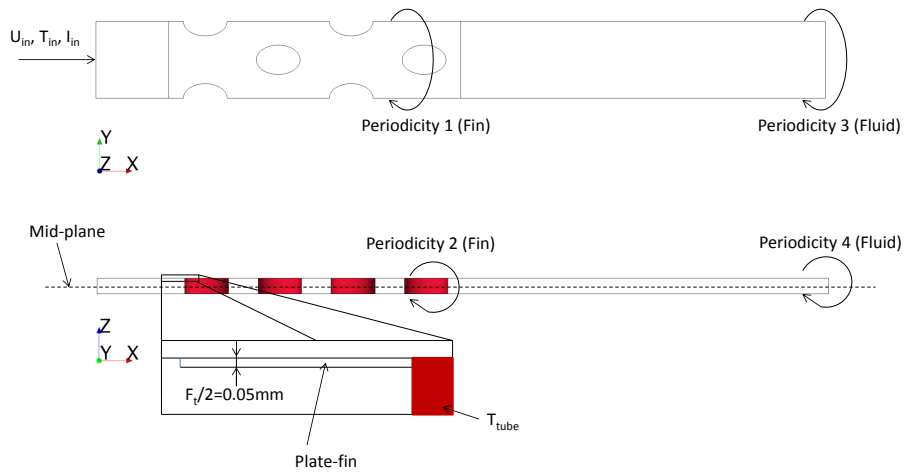

(b) Boundary conditions

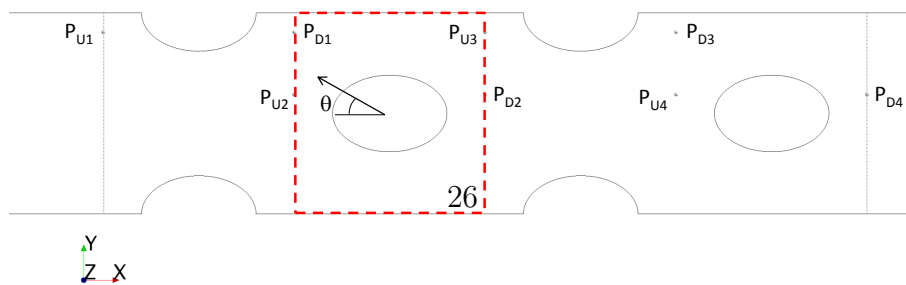

(c) Probes and tube row averaging-zone

Figure 1: Computational domain, boundary conditions and postprocessing features

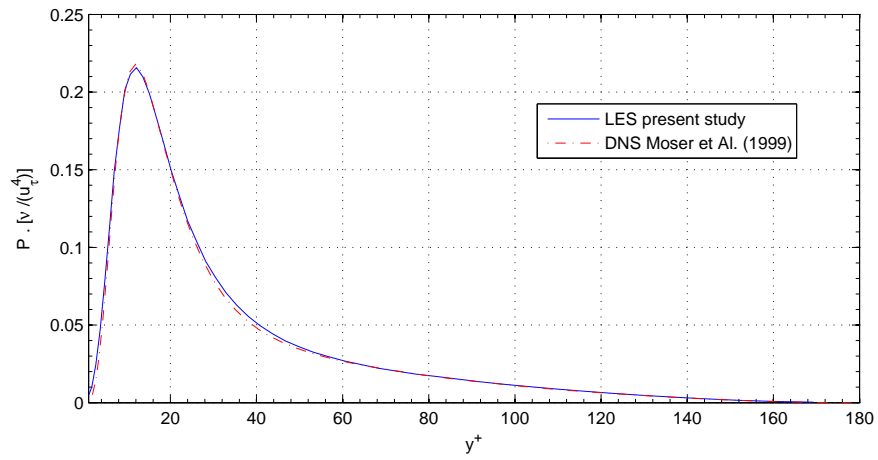

(a) Production of turbulent kinetic energy

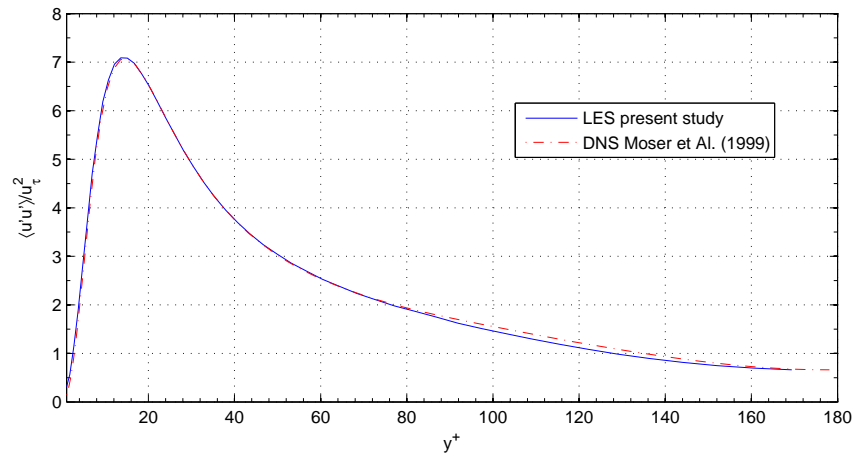

(b) R_{uu}

Figure 2: Comparison between LES calculation and DNS results for plate channel flow [32]

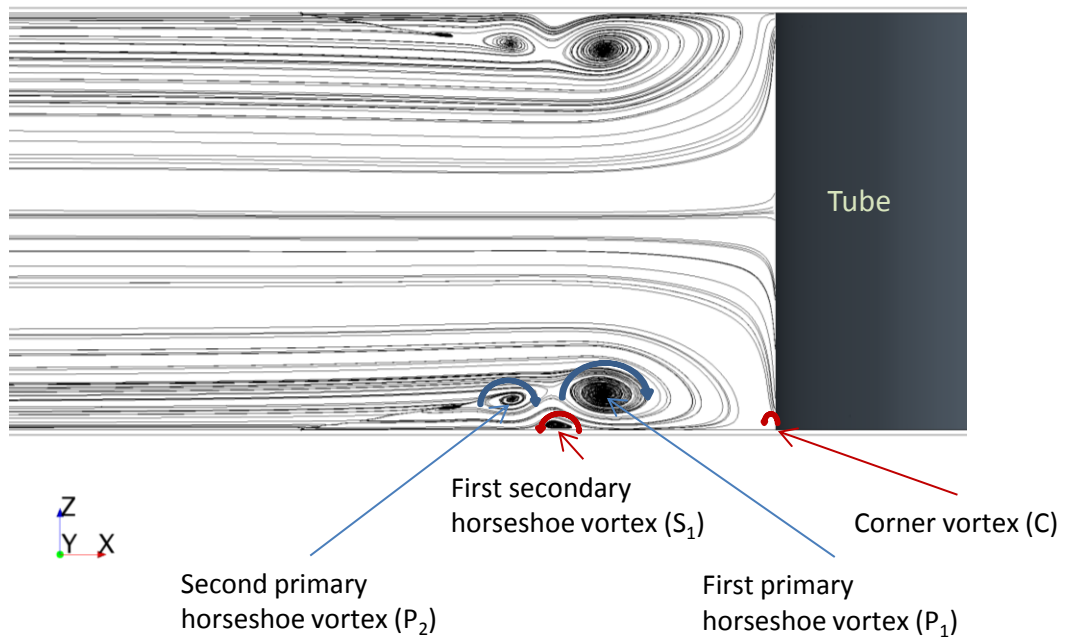

Figure 3: Illustration of a typical horseshoe vortex system upstream a tube-fin junction in the mid-plane of symmetry perpendicular to the fin (second tube row, $Re_{2b} = 1,500$)

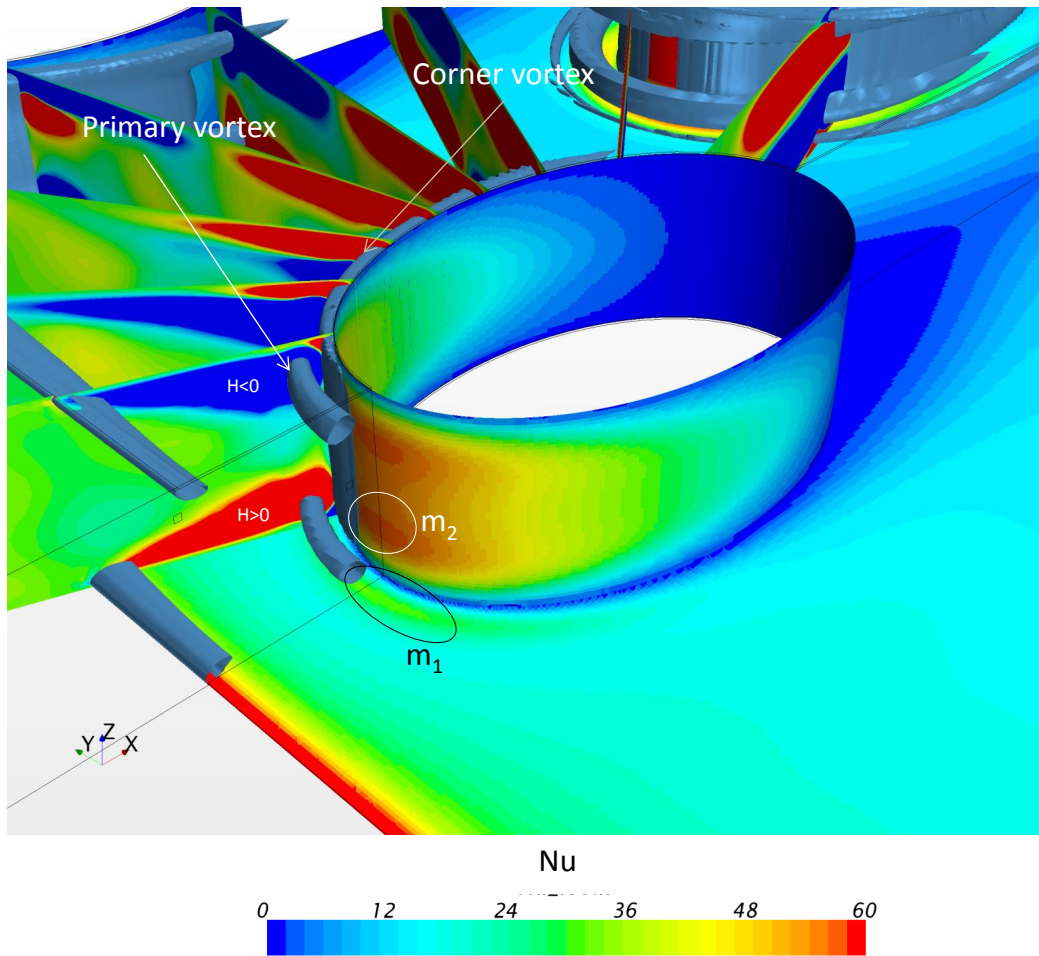

Figure 4: Illustration of the impact of horseshoe vortical structures on heat transfer, first row of the heat exchanger, $Re_{2b} = 500$

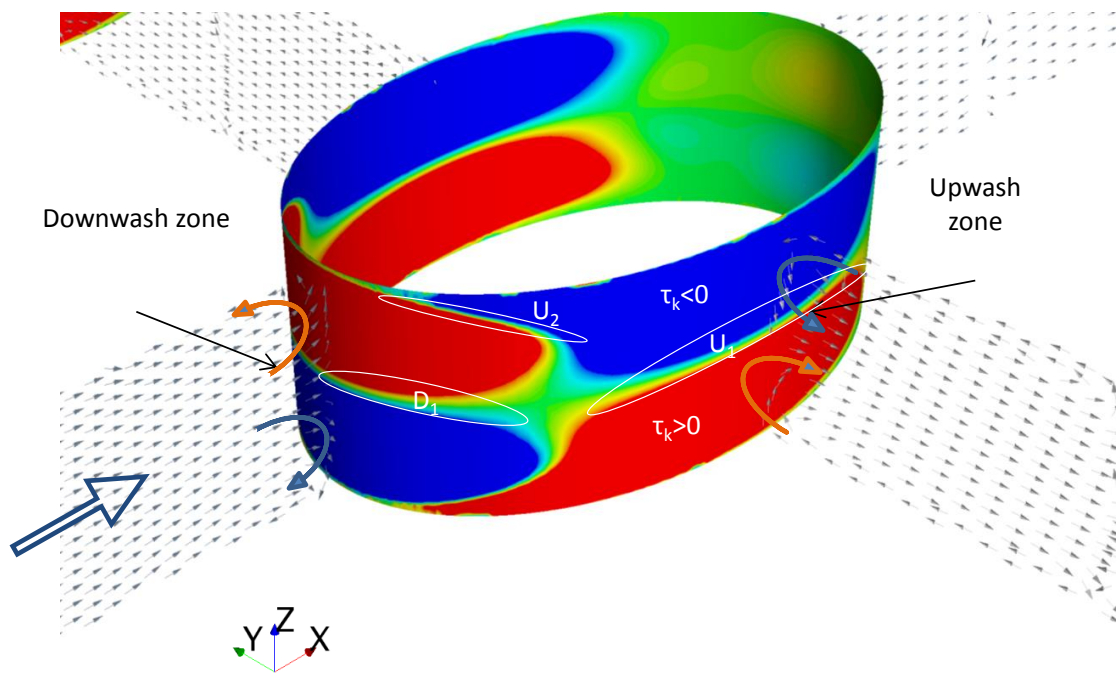

Figure 5: Distribution of the z-component of wall shear stress of the tube wall and tangential velocity vector distribution over two radial planes ($\theta = 0^\circ$ and $\theta = 90^\circ$)

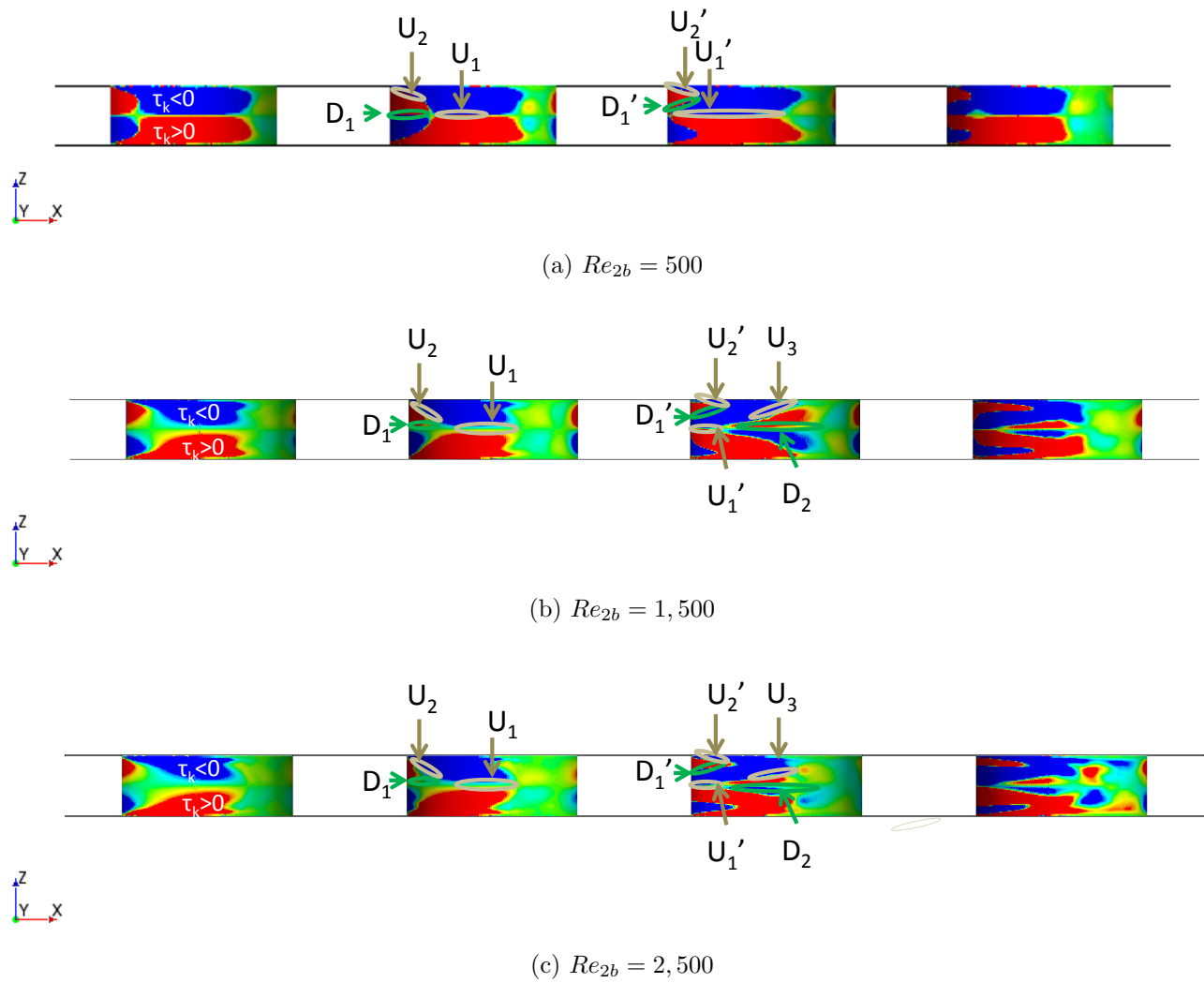
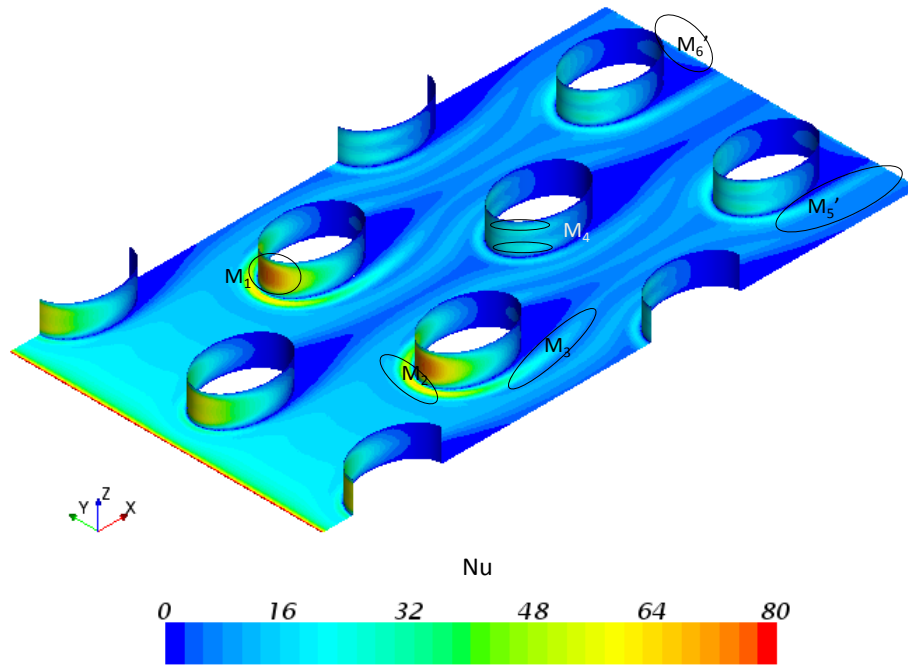
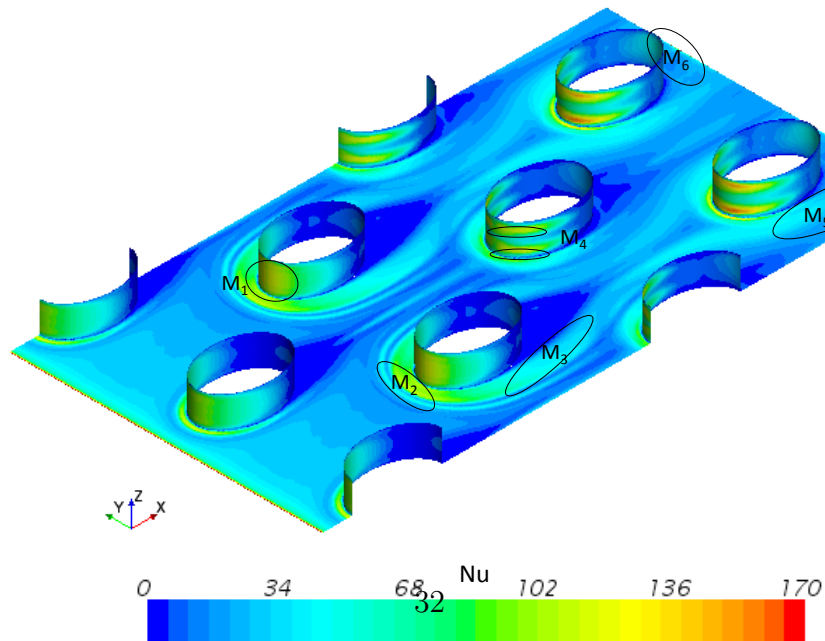

Figure 6: Wall shear stress ($\langle \tau_k \rangle$ component) distribution on tube wall for each row, side view, (incoming flow is from left to right)



(a) $Re_{2b} = 500$



(b) $Re_{2b} = 2,500$

Figure 7: Local time-averaged Nu distribution on the heat exchanger walls (tubes and fin), for $Re_{2b} = 500$ and $Re_{2b} = 2,500$

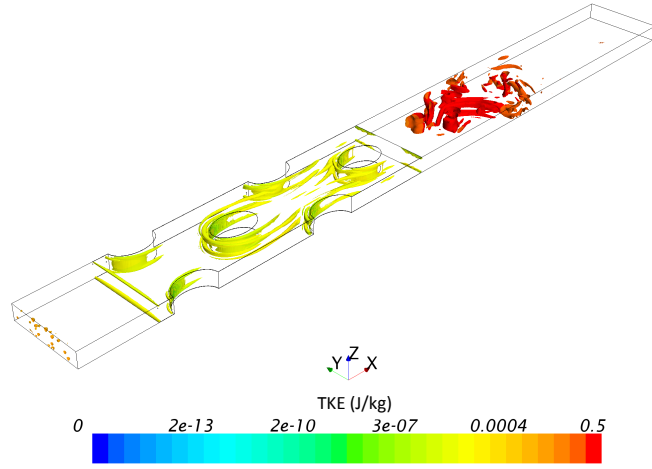

(a) $Re_{2b} = 500$

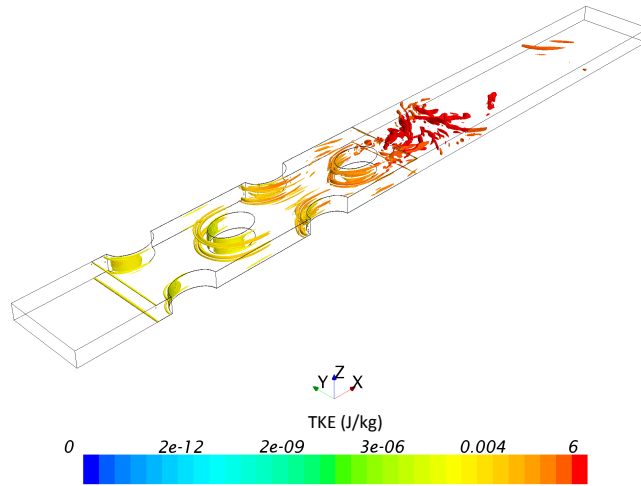

(b) $Re_{2b} = 1,500$

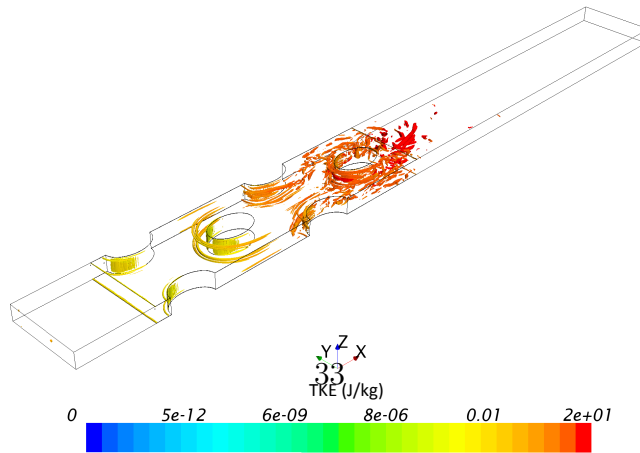

(c) $Re_{2b} = 2,500$

Figure 8: Instantaneous vortices identified by λ_2 vortex criterion

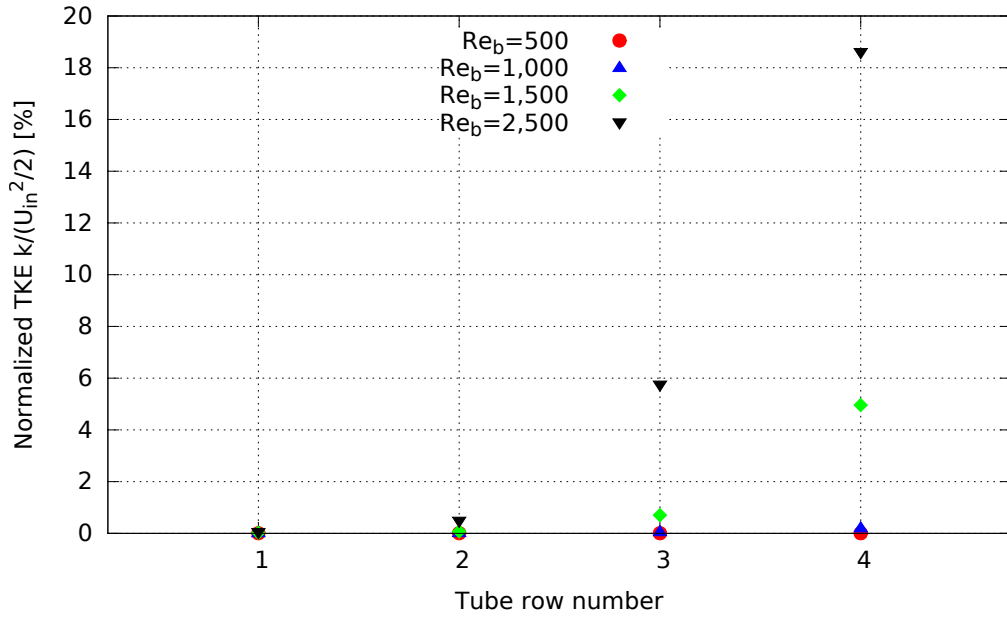

(a) Linear scale

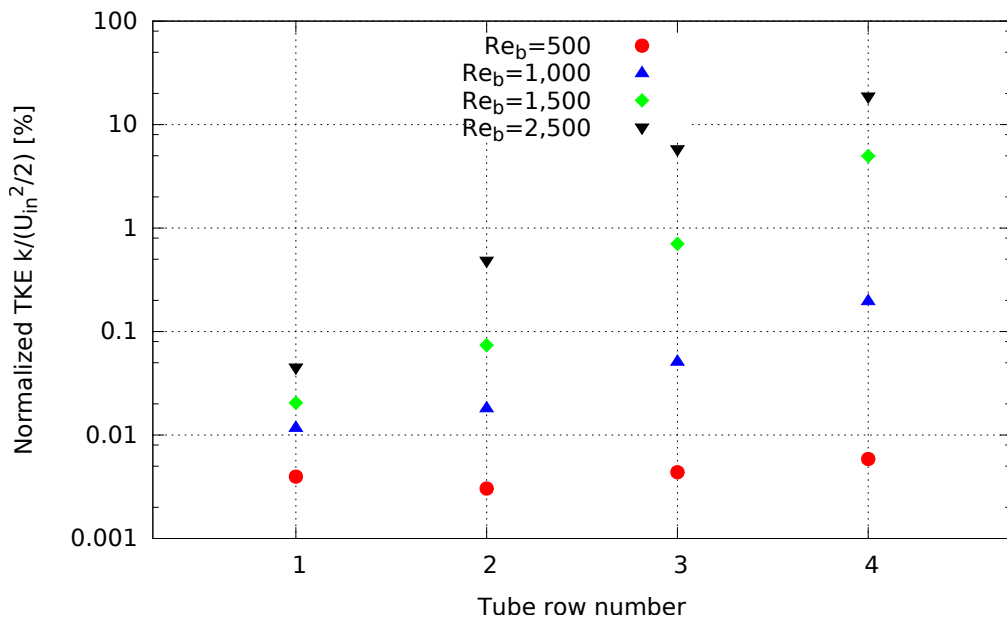

(b) Logarithmic scale

Figure 9: Normalized time averaged and volume-averaged turbulent kinetic energy

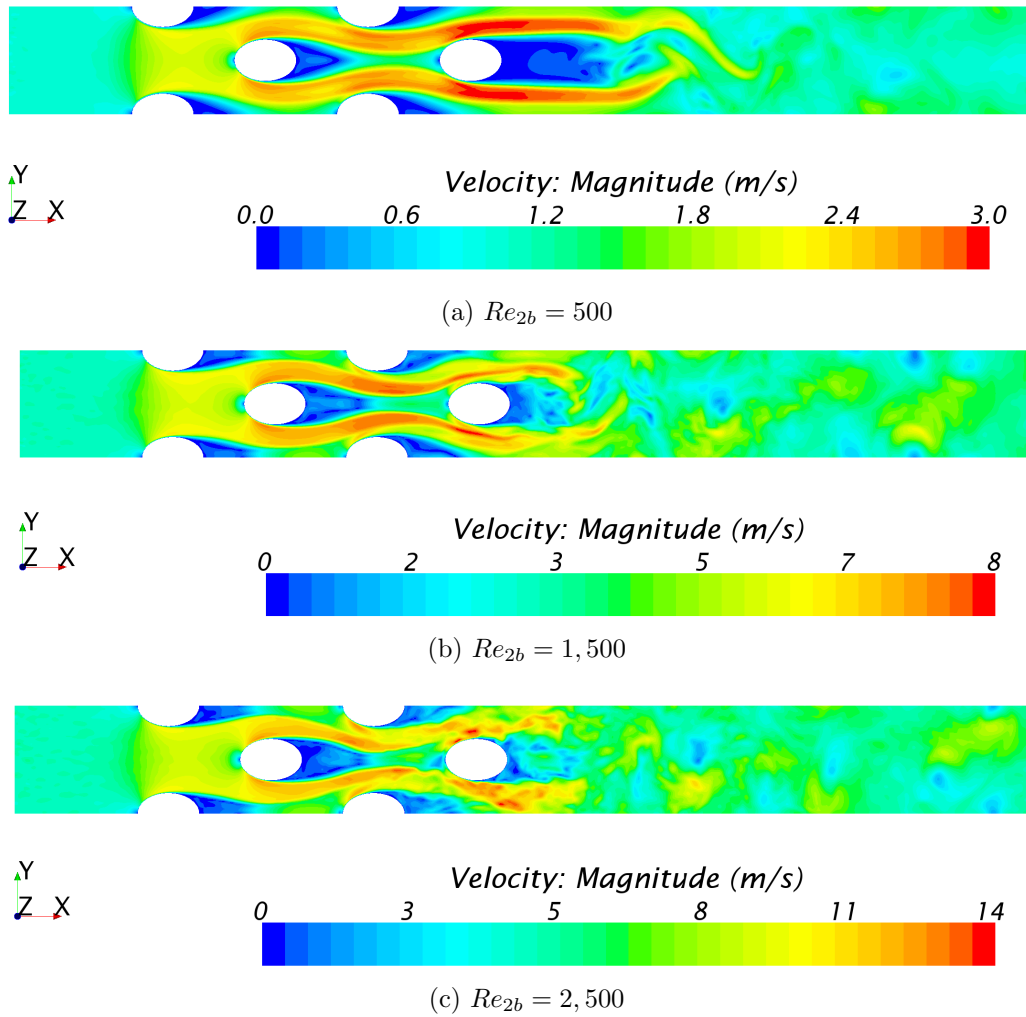
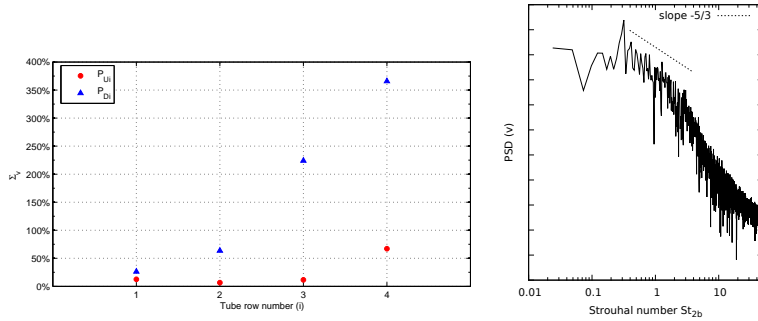
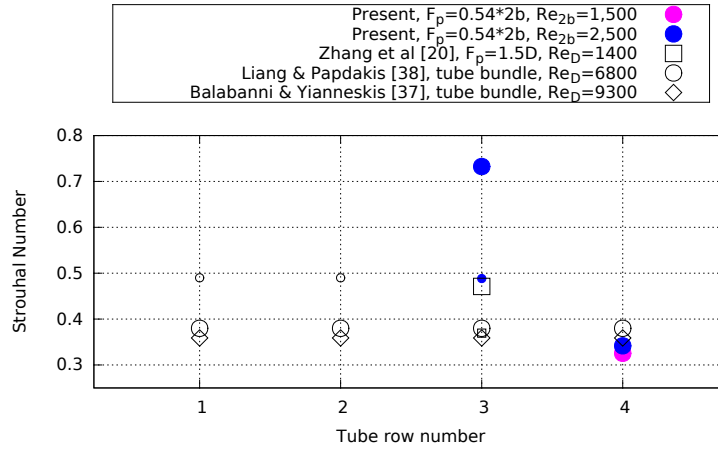

Figure 10: Instantaneous velocity magnitude in the midplane (50% of the tube height)



(a) Normalized standard deviation Σ_v values for probes temporal variation located upstream and downstream each tube (b) Power spectral density of v at location P_{D4}



(c) Row-by-row distribution of Strouhal numbers ($St_{2b} = f2b/U_{in}$ or $St_D = fD/U_{in}$). Big and small items are primary and secondary frequencies respectively

Figure 11: Flow unsteadiness based on the analysis of the y-component velocity v for $Re_{2b} = 2,500$.

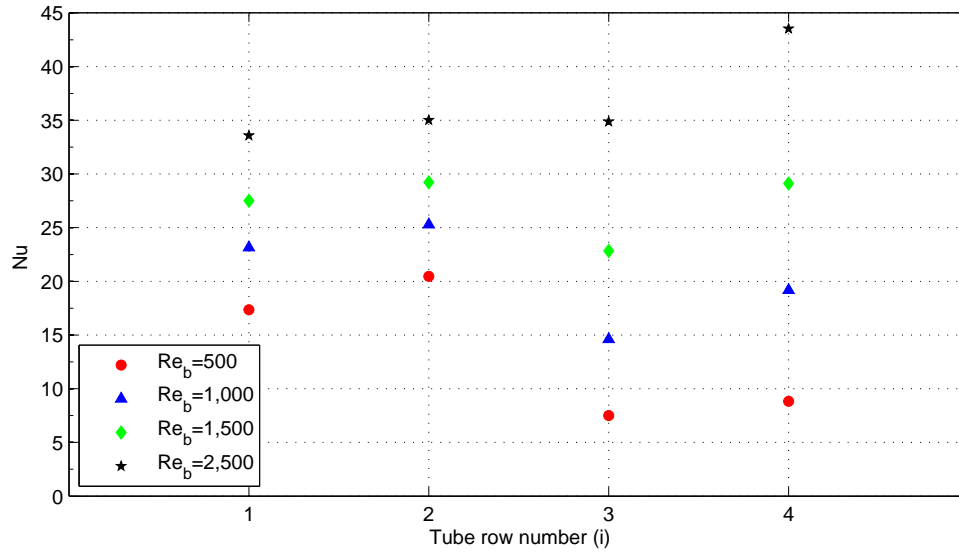

(a) Tube surface mean value of $\langle Nu \rangle$

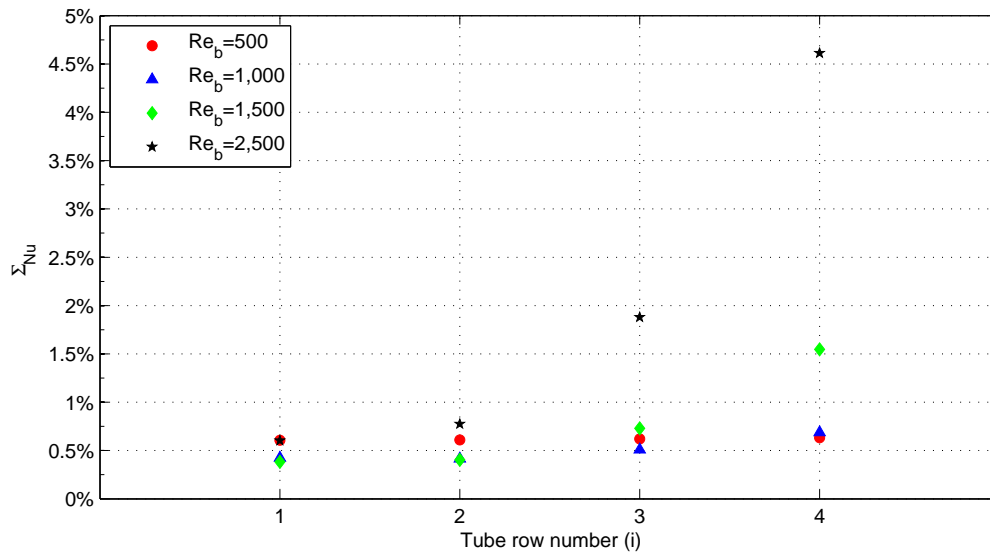

(b) Σ_{Nu}

Figure 12: Tube surface mean value of $\langle Nu \rangle$ and normalized standard deviation Σ_{Nu} values for surface mean value of Nu temporal variation