



HAL
open science

Dossier: MAT for the VIAMAP Maqām Analysis Tools for the Video- Animated Music Analysis Project

Amine Beyhom

► **To cite this version:**

Amine Beyhom. Dossier: MAT for the VIAMAP Maqām Analysis Tools for the Video- Animated Music Analysis Project. NEMO-Online, 2018. hal-02536449

HAL Id: hal-02536449

<https://hal.science/hal-02536449v1>

Submitted on 26 Apr 2020

HAL is a multi-disciplinary open access archive for the deposit and dissemination of scientific research documents, whether they are published or not. The documents may come from teaching and research institutions in France or abroad, or from public or private research centers.

L'archive ouverte pluridisciplinaire **HAL**, est destinée au dépôt et à la diffusion de documents scientifiques de niveau recherche, publiés ou non, émanant des établissements d'enseignement et de recherche français ou étrangers, des laboratoires publics ou privés.

Dossier: MAT for the VIAMAP

Maqām Analysis Tools for the Video-Animated Music Analysis Project

Amine Beyhom*

“The Pythagorean’s opinion that the planets and the stars, while following their course, produce sounds which combine harmonically is erroneous. In Physics, it is proven that their hypothesis is impossible, that the movement of heavenly bodies can generate no sound at all. Nearly everything that concerns music theory is a product of the Art, and foreign to Nature”

[Shaykh Abū-n-Naṣr Muḥammad ibn Muḥammad ibn Tarkhān al-Fārābī, *The Great Book of Music*]¹

“There is a tradition – which could even be taken as central to Occidental culture – according to which rational music would only be the reflection of a more intellectual reality, expressible by means of numbers.

This is what one would construe as Pythagorean tradition”

[Jean Molino, “Expérience et savoir”]²

* Amine Beyhom is Chief Editor of NEMO-Online and director of the CERMAA (Centre de Recherche sur les Musiques Arabes et Apparentées), a research center affiliated to the FOREDOFICO foundation in Lebanon. The author wishes to express his heartfelt thanks to François Picard and Wim van der Meer who reviewed this dossier and made critical remarks and suggestions. Additionally, Meer’s insightful propositions helped enlarging the scope of the dossier and complementing it.

¹ (Al-) Fārābī in [Erlanger, 1930, p. 28]. Fārābī’s influence on “Middle-Age” European scholars is not to be underestimated (see for instance [Carpenter, 1954, p. 128–129] on Johannes de Grocheo’s *Theoria*), although Pythagorean thought predominated in the study of music in Europe.

² [Molino, 1995, p. 112].

³ This dossier expounds some of the latest achievements in graphical Computer-aided Pitch analysis of melodic contours. It would have not been possible to establish these tools were it not for the pioneering work of Wim Van der Meer whose web publications (see

INTRODUCTION³

“Neo-Pythagoreans aside, music is man-made. Music is a product of culture, not of nature”
[George List, “The Musical Significance of Transcription”]⁴

Musical notation has been reputed as disqualified for the analysis of “Foreign” musics since – at least – the experiments of Charles Seeger with the Melograph. It is nevertheless still used as the main analytic – and teaching – tool for these musics in most researches in musicology, and today in the teaching of these musics in autochthonous conservatories.⁵

Seeger’s experiments brought at his time cutting-edge solutions – and alternatives – to score notation but, surprisingly enough, these solutions seem to have not worked out very well in the long run.

Not surprisingly, however, the explanation of such a persisting situation could be found in the Orientalist foundation of ethnomusicology, while musicology as such was borne to Western music – and score notation.⁶

This dossier relies on the pioneering works of Seeger and other ethnomusicologists and on the improvements of his method that we have witnessed in the last decades. It is accompanied by a short power point show (PPS) and 41 video-animated analyses⁷. It describes, *in fine*, the author’s work and propositions for the implementation of video-animated analyses in the teaching of ethnomusicology – as one major basis for this teaching.

notably [Meer ; Meer, 2015 ; Meer, 2018a], based originally on Seeger’s work with the Melograph – see Part I of this dossier) inspired the author for his work on pitch analysis of *maqām* music. Likewise, Meer would not have achieved all the developments proposed in the abovementioned references were it not for the existence of the program Praat, a computer program developed by Paul Boersma and David Weenink for speech analysis (see <http://www.fon.hum.uva.nl/praat/>) – which was first used by Meer, to the knowledge of the author, for music (melodic) analysis.

⁴ [List, 1963, p. 196].

⁵ This was also the observation of Bruno Nettl back in 1983 – see [Nettl, 1983, p. 80–81].

⁶ This is mainly tangible in the discussions on the use of score notation for the analysis of extra-western musics referenced – and partly cited – in Part I of this dossier, and in the aforementioned book (previous footnote) of Bruno Nettl.

⁷ Of which 9 previously published (in February 2018), and the rest for this dossier.

The first part consists of a retrospective on the “virtues” of score notation applied to “foreign” musics and the problems raised and discussed by this notation – mainly in the 20th century.

The second part is mostly based on previously published material⁸ and is a relatively short retrospective on the different notations used in autochthonous musicology of the *maqām*, from the known⁹ beginnings (al-Kindī) till today.

The third part outlines some of the improvements brought to the “Seeger Solution”¹⁰ – from rudimentary analyses that can be found in the “literature”¹¹ to the *Music in Motion*¹² website resulting from research by Wim van der Meer and Suvarnalata Rao, and expounds the further developments¹³ undertaken in the CERMAA¹⁴ in Lebanon.

The most important part of this dossier, however, lies not in the written text – or in the accompanying figures, but in the videos themselves – which are (intended, eventually, as) self-explanatory.¹⁵

* * *

PART I. ABOUT THE TRANSCRIPTION OF “FOREIGN” MUSICS AND THE VIRTUES OF NOTATION

“The new art of music is derived from the old signs – and these now stand for the musical art itself”

[Ferruccio Busoni, “Sketch Of A New Esthetic Of Music”]¹⁶

“Notation [...] serves the theorist as a medium by which to demonstrate musical [...] laws”

[Bent et al. in the entry “Notation” of the *New Grove*]¹⁷

“[S]cience [...] is supposed to be cumulative, explicit, predictive, and empirically testable”

[Daniel Hirst, “The analysis by synthesis of speech melody: from data to models”]¹⁸

“The important thing is to recognize the falsification for what it is, and not to confuse the imaginary objects of music with the temporal experiences for which they stand [...]. [T]he score conceals as much as it reveals”

[Nicholas Cook, *Music: a very short introduction*]¹⁹

“The map is not the territory”

[Alfred Korzybski, “A Non-Aristotelian System and its Necessity for Rigour in Mathematics and Physics”]²⁰

⁸ But which was never put together, and even less in one single language.

⁹ And extant.

¹⁰ As it was named by Mantle Hood – cited in Part I of this dossier.

¹¹ Are audio-visual products and the internet still to be called as such?

¹² <https://autrimncpa.wordpress.com/>.

¹³ Which take the lion’s share in this third – written – part.

¹⁴ Reminder: the CERMAA (Centre de Recherche sur les Musiques Arabes et Apparentées) is the research center on music under the Lebanese FOREDOFICO foundation for the arts.

¹⁵ The reader can watch the videos in parallel to the text, or watch them then come back to the text, or even read the text then watch

them – whatever order he chooses, this is not a classical musicological discourse, so the author’s plea is: “please watch the videos”.

¹⁶ [Busoni, 1911, p. 16].

¹⁷ [Bent et al., 2001].

¹⁸ [Hirst, 2012, p. 57]. Or: “It is crucial, in order to avoid misunderstandings, that the word ‘scientific’ [...] be understood [...] as ‘investigations aimed at acquiring accurate knowledge of factual matters relating to any aspect of the world by using rational empirical methods analogous to those employed in the natural sciences’. Alternatively, one could use the phrase evidence-based worldview” – [Sokal, 2008, p. 14].

¹⁹ [Cook, 2000, p. 71, 81].

²⁰ [Korzybski, 1931].

About notations of music²¹

The author firmly believes that music is an art, which may be structured by rules – of composition, of performance, of social behavior – but never by “laws”.²² Musicology, on the other side, is supposed to be a science, which means that it should use scientific tools for the research of music. The major “scientific tool” of classical musicology – and of ethnomusicology – for the analysis of music is – still – score notation.

Molino²³ clearly places written languages, and the process of writing music as such, at the center of Max Weber’s reflection on (the superiority of Western) music. Let us however remember that musical notation²⁴ is

²¹ This section does not aim to supplement major articles and books about the notation of music readily available to musicologists, but to serve as a reminder to the reader about the goals and the different forms of notation.

²² Colleague and friend Richard Dumbrell rightly here raised the question of the overlapping meanings of “law” and “rule” in English (but also in most other languages). “Rule” is multiply defined in the Merriam-Webster dictionary (see <https://www.merriam-webster.com/dictionary/rule>), notably as:

“1 a: a prescribed guide for conduct or action

b: the laws or regulations prescribed by the founder of a religious order for observance by its members

c: an accepted procedure, custom, or habit

d (1): a usually written order or direction made by a court regulating court practice or the action of parties

(2): a legal precept or doctrine

e: a regulation or bylaw governing procedure or controlling conduct”.

I use here the term “rule” as in 1a and 1c in the definition above, and partly as 1e. I would like to remind also that, while acoustic laws may play the role of a *guide* for musicians and composers (see notably the Synthesis of [Beyhom, 2017]), this role is limited and is frequently superseded by the role of heterophony and by the inharmonism which is intrinsic to most instruments of the world (see here notably the role of timbre in the perception of pitch and how harmonics influence it in [Plomp, 2002]). The western evolution towards the use of “harmonic” instruments, together with the use of electronic instruments with near-perfect sound spectrum, precipitates today a similar evolution for instruments of music in the world – with notable exceptions that I shall not cite here. Let’s remember also that while rules can be broken, laws cannot (or should not) be breached; laws can however always be circumvented, especially in the Arts, especially in music. I would even add that circumventing the laws of acoustics is a sport which suits well modal – and particularly *maqām* – music, as I explain in the aforementioned “Synthesis”.

²³ [Molino, 2008].

²⁴ A general theory on Symbol Systems is expounded in Nelson Goodman’s *Languages of Art*, and more specifically for notational systems in [Goodman, 1968, p. 127–173] – as for Goodman’s theories and thought, see [Giovannelli, 2017]. Notation is defined in the *New Grove* – [Bent et al., 2001] – as “a visual analogue of musical

not a western exclusivity: many non-European, non-Western notations have been invented throughout history and are still being used throughout the world, be it for pitch (or beat, or interval) and duration or instrumental – such as tablatures and other instrument-specific oriented notations.²⁵

Musical notation can further be absolute or relative, normative or indicative. Its usefulness seems, at first sight, obvious: it allows for a visual (sometimes graphical) consignment of a music piece – or of one possible, specific or standardized version of it – and for sharing it with other musicians or musicologists who can decipher it.²⁶

sound, either as a record of sound heard or imagined, or as a set of visual instructions for performers”.

²⁵ One reference book on (Western) Early notations is [Apel, 1961], while [Atkinson, 2008] explains the interaction(s) between Early notation(s) and the modal system of European music in practice. Short – and useful – general retrospectives on musical notation(s) are available in [Cook, 2000, p. 51–63], in <https://www.mfiles.co.uk/music-notation-history.htm>, and in [Wikipedia Contributors, 2018b] in which, however, Byzantine notation as such is disregarded to the benefit of the Russian *znamenny* notation (FHT 1: 207 – “FHT” stands for “Figure Hors Texte” or “Plate”) which derives from it (see <https://churchmotherofgod.org/orthodox-terminology/glossary-z/918-znamenny-notation.html> – accessed 07/01/2018, notably: “[w]hile in its initial form it was borrowed from Byzantium, *Znamenny Notation* underwent an evolutionary process in Ancient Rus’, and towards the 15th-16th centuries lost its connection with Byzantine notations”) – see also for the *znamenny* notation and its history <https://web.archive.org/web/20130613084202/http://www.churchoftheneativity.net/old-rite/znamenny> and subdivisions and links shown on this archived page. In Walter Kaufmann’s *Musical notations of the Orient* [Kaufmann, 1967] different Chinese (for these notations see [Picard, 1999] – in French), Indian and Korean notations and tablatures are also described; a special *tanbur* tablature (see [Matyakubov and Powers, 1990]) was devised in the 19th century Khorezm (also “Khwarezm”, an oasis region today belonging partly to Uzbekistan, partly to Kazakhstan and partly to Turkmenistan – see [Wikipedia Contributors, 2018a]) and is expounded in Part II of this dossier; there even exists “turntablatures” for DJs as explained in [Miyakawa, 2007]; see also [Lee, 1988] for the changes induced in the *honkyoku* (*shakuhachi*) repertoire in Japan by the use of Western notation and principles, [Lependorf, 1989] for the inclusion of the techniques of the *shakuhachi* in Western notation and [Deschênes, 2017] for a contradictory view; a short description of Japanese notations is also available in [Berger, 1969, p. 33–34].

²⁶ Here is the complete definition in the *New Grove* of the use (fullness) of notation – with which I do not agree completely: “Broadly speaking, there are two motivations behind the use of notation: the need for a memory aid and the need to communicate. As a memory aid, it enables the performer to encompass a far greater repertory than he or she could otherwise retain and realize. It may assist the performer’s memory in music that is already basically known but

It also allows musicians (and performers) to work together on the basis of a written document shared by all, or for a specific musician/composer to consign in written form subtleties of interpretations, or (notably for a composer) whole music pieces which he would reluctantly entrust to his memory alone, etc.²⁷

Western musical notation, in its mainstream use today – I mean by that as employed in Common-practice Western (or today World) music – is specifically based on (absolute) pitch and duration. Its usefulness – even when modified and adapted – for other types of music is debatable (and debated) as can be inferred from the quotes reproduced in the next section.²⁸ Moreover, this notation has been used, along with the forged Hellenistic legacy and the theories of the scale in western music(ology), as a privileged tool for Occidentism.²⁹

not necessarily remembered perfectly; it may provide a framework for improvisation; or it may enable the reading of music at sight (this last concept is a predominantly Western one). A written notation provides the means to sketch and draft musical ideas during the composing process. As a means of communication, it preserves music over a long period; it facilitates performance by those not in contact with the composer; it equips the conductor with a set of spatial symbols by which to obtain certain responses during performance; it presents music as a ‘text’ for study and analysis, and offers the student the means of bringing it to life in his or her mind when no performance is possible; and it serves the theorist as a **medium by which to demonstrate musical or acoustical laws**” – [Bent et al., 2001]. (Bold font is mine: note that music has “laws” – and not “rules” – in this widely consulted reference.)

²⁷ “[S]igns of [music] are everywhere – in scores, books, instruments – and yet they aren’t the music. You can’t point to the music, or grasp hold of it, because as soon as it has come into being it has already disappeared, swallowed up into silence, leaving no trace. [...] And what are [scores] for, what work do they do within our musical culture? You might say that they serve three distinct functions. One, the most obvious, is conservation: like photographs, they stop time in its tracks and give a stable, visible form to the evanescent. The second is almost equally obvious: they are a means for the communication of music from one person to another, for example (but it is only an example) from composer to performer. The third is less obvious but at least as important as the other two: in many traditions, notation is integral to the conception of music, to the ways in which composers, performers, and others who work with music, imagine or think about it” – [Cook, 2000, p. 51].

²⁸ “[M]usical notations are highly specific about what they will or will not record; they are more like filters or prisms than DAT recorders or samplers. And ethnomusicologists, who use essentially Western techniques to study non-Western music, are more aware of this than anyone. Some ethnomusicologists are prepared to use staff notation to transcribe the music they study, as a means both of understanding it and of communicating that understanding to their readers. But they are painfully conscious that in doing this they are shoe-horning Indian or Chinese music, or whatever it might be, into a system that was never designed for it. For instance, staff notation treats all music as if it were made up of separate notes each a set

In the next section, different approaches to the transcription of non-western music are expounded, with a focus on the 1960s and 1970s in which this question was hotly debated – notably in the United States.

Prescriptive or Descriptive?

Two main milestones for notating “exotic” musics from the beginnings of the 20th century³⁰ consist in the works of Abraham and Hornbostel, then Béla Bartók.

These authors thought – as many after them – that the use of additional accidentals and indications in the score (Fig. 1) could suffice for a correct reproduction of the music they heard.³¹

distance apart; in effect it assumes that all instruments work on the same principle as the piano, which has a separate sound-producing mechanism for each of the eighty-eight notes it can play. But many instruments are not like this; on the violin you can play any number of pitches between a B and a C, say, or you can slide continuously from the one note to the other so that there is no way in which you can say exactly where the B ended and the C started. The same applies to the human voice, or the electric guitar if you bend the note. And the point is that in Indian and Chinese music it is often the notes between the notes, so to speak, that are responsible for the effect of the music. Similarly in florid singing (and again Indian music is a good example) trying to say where one note starts and another stops, as ‘note’ would be defined in terms of staff notation, becomes a completely arbitrary exercise; the music just doesn’t work that way. There is a collision between music and notation”.

As a conclusion: “Predictably, this situation has resulted in endless controversies between those ethnomusicologists who see staff notation as a blunt but necessary instrument for conveying something of the music to readers unfamiliar with the notational system (if any) of the musical culture in question, and those who regard its use as a kind of neo-colonial exercise in which Western notation is set up as a universal standard” – [Cook, 2000, p. 58–59].

²⁹ See [Beyhom, 2016a]: Occidentism is – in short – Western ethnocentrism; see [Sachs, 1976] for “Europocentrism” (which is much the same thing, but goes back in time somewhat farther).

³⁰ The author will evidently not examine here simple transnotation of “Foreign” – and in particular – *maqām* music in Western notation (see for example fn. 252 in [Beyhom, 2016a] with the quote from [Pasler, 2012]), which fully neglects the intonations of the transcribed musics to conform them to Western – unaltered – staff notation. I shall also pass on early attempts such as Villotteau’s and Kiesewetter’s in [Villotteau, 1826; Kiesewetter, 1842], etc., and concentrate on the more general problematic of the notation of non-western (or non-conventional – i.e. “popular”, “traditional”, if not the even more unflattering “Folk”) musics.

³¹ See the various recommendations in [Abraham and Hornbostel, 1909, p. 6], translated as [Abraham and Hornbostel, 1994]. As for Béla Bartók, he started by using quarter-tone accidentals such as ^{#/2} and ^{b/2}, with ↑ and ↓ to raise or lower less than a quarter-tone, then

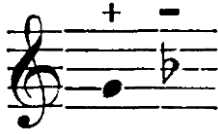

Fig. 1 Recommended use of the plus and minus signs in the key signature of a score for raising or lowering all corresponding notes in “exotic” melodies – [Abraham and Hornbostel, 1909, p. 6].

Hornbostel further embraced Ellis’ division of the (tempered) semi-tone in cents,³² and warned against the “natural” western bias towards the interpretation of foreign melodic musics through the western looking glass but,³³ as meticulous and comprehensive as he and Abraham may have been in their “*Vorschläge für die Transkription exotischer Melodien*”³⁴ the two authors, by promoting western notation³⁵ – even by modifying and supplementing it – for the comprehension and analysis of music(s) from “other cultures”, strengthened the analytical biases of Orientalist musicology.

came back to the \uparrow and \downarrow applied, this time, to quarter-tone accidentals while using literal indications for other divisions of the tone – as can be inferred from [Somfai, 1996, p. 269].

³² [Hornbostel, 1927].

³³ “By overwhelming habit we have become unable to assess a melody purely melodically without reinterpreting it according to our tonal system and an assumed harmonic accompaniment” – [Hornbostel, 2017, p. 11].

³⁴ [Abraham and Hornbostel, 1909]: these authors had previously explored methods for transcribing “exotic” music in voluminous articles such as [Abraham and Hornbostel, 1903; Abraham and Hornbostel, 1904]. In the latter article, examples of Indian music in plain western notation are found on almost every page, while the authors undertake [p. 380-388] a long discussion the purpose of which is to deny the existence of the “21-steps scale” (theoretically, if not practically, 22-steps = *śrutis* – see for example the second part of [Beyhom, 2012]) in Indian music, the main scale of which would have been identical to the western “diatonic” scale [p. 383] and based on a twelve-semi-tones division of the octave. In a later article [Abraham and Hornbostel, 1905] both authors acknowledge a possible western influence on Indian music, while Hornbostel wrote one year later an article on Tunisian music entitled “*Phonographierte tunesische Melodien*” [Hornbostel, 1906] in which he also used western notation but acknowledged that the intonations in the analyzed melodies did not correspond to the Western tempered (or even “harmonic”) scale. This is also the conclusion of a recent Ph.D. thesis [Zouari, 2014] about Tunisian music conforming gradually – at least since the beginning of the 20th century – with the equal-tempered western scale.

³⁵ In their “Suggested Methods for the Transcription of Exotic Music”, namely: “[T]he peculiarities of musical expression of differing cultures can be reproduced more or less faithfully only by European notation which is appropriately modified and supplemented. It is

Abraham and Hornbostel were intellectual and academic representatives of their century and their culture.³⁶

“The increasing interest of ethnologists and musicologists in the music of non-European cultures has stimulated more and more field workers, missionaries, and colonial officials to make acoustical recordings of the songs and instrumental music of natives and to turn over the results of these activities to scientific institutions for study”.³⁷

Even more interesting in this article is the translators³⁸ comment, in the review *Ethnomusicology*, stating:

“[this] article contains a number of penetrating observations whose value time has not diminished”,³⁹

while, however:

“[t]he authors also included materials concerning the development of scales and the classification of musical genres which many would not now consider part of the transcription process as such”.⁴⁰

indispensable to notate the melodies whether the purpose is to study them or to convey them to others” – [Abraham and Hornbostel, 1994, p. 427].

³⁶ And they were near-contemporaries to writings such as Baker’s Ph.D. thesis [Baker, 1882] on the “Music of the North-American Savages” which they cite in [Abraham and Hornbostel, 1903, p. 342], and the introduction of which begins [p. 1]: “Through music, as well among savages as among cultivated folk, the expression of feelings gain in intensity, which they can not share with words and gestures alone. The Savage, however, instead of the variety of feelings, which is vivid in the civilized world, feels relatively few spiritual and sensual drives, in which his language, as well as his music – the language of feelings – remains simple and limited”. This appreciation remains far more “open” to the “music of the savages” than the quote of Hofmann by Hornbostel reproduced farther. It shows however a persistent need to distinguish between “Art” music and other musics. It could also be compared, by its occicentrism, with the conclusion of another “Anthropologist” at the same period: “when savage man makes music spontaneously he obeys the universal law of all activity and follows the line of least resistance, and that in every instance this line is found to be a chord line, a harmonic line. Folk-melody, so far as now appears, is always and everywhere harmonic melody, however dim the perception of harmonic relations, and however untrained and inexperienced as regards music the untaught savage may be” – [Fillmore, 1899, p. 318]. Note that this belief in the universality of Western canons in music persists today with some authors, as in Schenkerian analysis applied in [Stock, 1993] to “Foreign” musics.

³⁷ [Abraham and Hornbostel, 1994, p. 426].

³⁸ George and Eve List.

³⁹ [Abraham and Hornbostel, 1994, p. 425].

⁴⁰ [Abraham and Hornbostel, 1994, p. 426].

In the case of Hornbostel, openness to other cultures can at least not be denied as he states in a later (if not next⁴¹) article:

“the scholarly potential offered by non-European tonal art has been badly underestimated. To some extent, misled by melodies notated merely by ear and therefore often unwittingly translated into European ones, one believed the musical language of all peoples to be a natural universal language. Further, the analysis of dialectal differences, which were discernible after all to be a narrowly confined special field of musicology, was considered completely extraneous to psychology. These conclusions occurred precisely because the psychic fundamentals of all music were regarded as universally human. To some extent one believed what the ‘savages’ produce to be nothing but noise and nasty sounds, at the most comparable to the utterances of animals, but not to our tonal art”,⁴²

adding here a footnote:

“Thus, as recently as 1908 an author writes: ‘Many peoples have hardly reached the first step of musical development so that their musical achievements are considerably surpassed by those of certain birds. Many still do not have a pronounced tonal system, many perform a completely non-rhythmic music which either sounds appallingly monotonous or constitutes a raving chaos of tones.’ (B. Hofmann, *Kunst und Vogelgesang* [Art and Bird Song]. Leipzig 1908, p. 164.)”⁴³

Today, the use of adapted accidentals for non-conventional – and not only “Foreign” – musics⁴⁴ has probably reached its climax⁴⁵ but it should be not forgotten that staff notation

“is a systemically conditioned mnemonic aid and not a scientifically valid, intrinsically logical, fully objective or universally applicable communications code”,⁴⁶

and that the memory of a regular musician is mostly unable to embrace dozens of accidentals, which, furthermore, are – generally – not created in the aim of describing the music, but of prescribing it.

⁴¹ The original article “‘Über vergleichende akustische und musikpsychologische Untersuchungen.’ *Beiträge zur Akustik und Musikwissenschaft* 5, 1910, 143–167” was published one year after the “*Vorschläge ...*”. It is here quoted from the translated version [Hornbostel, 2017].

⁴² [Hornbostel, 2017, p. 1–2].

⁴³ [Hornbostel, 2017, p. 2].

⁴⁴ But in conventional Western notation.

⁴⁵ See for example the document entitled “The Extended Helmholtz-Ellis JI Pitch Notation – microtonal accidentals designed by Marc Sabat and Wolfgang von Schweinitz, 2004” [Sabat and Schweinitz, 2004] (see also <http://www.marcsabat.com/> – accessed 29/12/2017) with dozens (more than 75) accidentals and combined accidentals to describe Pythagorean intervals.

Beyond the pioneering writings of the historical ethnomusicologists (till the 1930s?), the use of western notation to describe non-western music has been seriously questioned, as soon as after WWII, for example by Curt Sachs and Charles Seeger.⁴⁷

In Curt Sachs’ *The Wellsprings of Music* we find:

“Only he who knows the pitfalls of western habits and has learned to escape them is up to such intricate, delicate work and can hope to do justice to eastern and primitive music. And even such a man is far from being infallible. When we compare an original phonogram with a transcription made by another person, we will more often than not disagree. This is not necessarily a question of keener ears, but rather of the analytical apparatus in the brain – just as two painters of equal ability (and even photographers) might be at variance in seizing the likeness of a model. Indeed, our own transcriptions will often be unsatisfactory when we resume and revise the work of yesterday. One cannot too earnestly warn the student against accepting printed transcriptions as gospel truth”,⁴⁸

while in his “Prescriptive and descriptive music writing” Charles Seeger (Fig. 2) explains:

“[A]s we find it today, our conventional notation is still a mixed symbolic-linear music-writing in which the symbolic element is the more highly organized and therefore dominates. [...] It does not tell us as much about how music sounds as how to make it sound. Yet no one can make it sound as the writer of the notation intended unless in addition to a knowledge of the tradition of writing he has also a knowledge of the oral (or, better, aural) tradition associated with it – i.e., a tradition learned by the ear of the student, partly from his elders in general but especially from the precepts of his teachers. For to this aural tradition is customarily left most of the knowledge of ‘what happens between the notes’ – i.e., between the links in the chain and the comparatively stable levels in the stream. In employing this mainly prescriptive notation as a descriptive sound-writing of any music other than the Occidental fine and popular arts of music we do two things, both thoroughly unscientific. First, we single out what appear to us to be structures in the other music that resemble structures familiar to us in the

⁴⁶ [Cazden, 1961, p. 117].

⁴⁷ Sachs’ *Wellsprings of Music* was edited by Jaap Kunst and published posthumously (both Sachs and Kunst had passed away at the time of publication, Sachs on the 5th of February 1959 – see [Kunst, 1959] – and Kunst on the 7th of December 1960 – see [Wikipedia Contributors, 2017d]) in 1962. It may have been completed (well) before the publication of Seeger’s seminal article in 1958.

⁴⁸ [Sachs, 1962, p. 22–23]: part of this quote and the following quote (by Seeger) are the initial (epigraph) quotes for the article of Udo Will “La baguette magique de l’ethnomusicologue. Repenser la notation et l’analyse de la musique” [Will, 1999b], translated into English in [Will, 1999a].

notation of the Occidental art and write these down, ignoring everything else for which we have no symbols. Second, we expect the resulting notation to be read by people who do not carry the tradition of the other music. The result, as read, can only be a conglomeration of structures part European, part non-European, connected by a movement 100% European. To such a riot of subjectivity it is presumptuous indeed to ascribe the designation ‘scientific’.⁴⁹



Fig. 2 Photograph of Charles Seeger, philosopher, musicologist, ethnomusicologist, political activist.⁵⁰

The use of western notation to describe non-western musics was further criticized by ethnomusicologists such as Mantle Hood and James Reid, thus in the first’s “Musical significance”:

“The constant and justifiable complaint about the inadequacies of musical notation indicate a great reservoir of energy which could be more profitably applied to the task of finding some constructive solution. Personally, I would rather attempt interplanetary flight in a Wright Brothers’ plane than to continue doctoring the five-line staff with the mystical signs of diacritical annotation”,⁵¹

and in Reid’s “Transcription in a New Mode”:

“The case for Western notation rests essentially on three points:

- 1) ‘Universality,’ that is, the assertion that Western notation is the best medium for transcription of non-Western music because ‘all’ trained musicians can already read it. They are thus spared the time-consuming trauma of learning some

other system, and their time can be fully devoted to the unimpeded examination of their material.

2) ‘Adaptability,’ the assertion that Western notation can be altered (in Hood’s word ‘doctored’) with various symbols to represent the many elements of non-Western music that resist normal transcription.

3) ‘Accuracy,’ the notion that Western notation is ‘accurate and reliable enough’ for ethnomusicological purposes, and in any case allows for a consensus of scholars to decide what is meant by a given transcription [...].

None of these arguments will stand close examination”.⁵²

The continued use of this same Western notation for the analysis of *maqām* music⁵³ – among other non-Western musics – is but one additional symptom of the persistence of Orientalist musicology: the more when this notation is used by autochthonous *maqām* musicologists and musicians as the basis for their teaching.

Whenever Abraham and Hornbostel stated in 1909 that it was

“indispensable to notate the [exotic] melodies whether the purpose is to study them or to convey them to others”,

the question that remains asked is, “why did these intelligent and highly educated academics which believed in progress not realize that the best way of ‘conveying’ melodies was to simply provide recorded examples (or copies) of those?”.

As for the western notation system as the only (reliable?) method of analysis [“study”] for such melodies...

PROBLEMS RAISED BY TRANSCRIPTION (AND NOTATION) AS FURTHER ANALYZED BY WESTERN ETHNOMUSICOLOGISTS

Seeger’s “Prescriptive and Descriptive Music-Writing” – quoted above – triggered numerous responses.

In Mantle Hood’s 1971 *The Ethnomusicologist*,⁵⁴ a complete chapter is dedicated to “Transcription and Notation” with a presentation of the problems and, under the subtitle “The Chronic Problem of 1893”, of three “solutions” respectively entitled “The Hipkins Solution”, “The Seeger Solution” and “The Laban Solution”.

⁴⁹ [Seeger, 1958, p. 187]. Note that, apart from being one of the founders of the Society for Ethnomusicology in 1953 (as noted in https://www.ethnomusicology.org/page/History_Founding? accessed 15/07/2018), Seeger was also one of the founders of the American Musicological Society in 1934 as explained in [Crawford, 1984, p. 1] (and before that – also in 1934 as concluded from [Crawford, 1984, p. 9] – of the American Association for Comparative Musicology). {See also [Fraser, 1979] and, about the legacy of Charles Seeger [Anon. “How Can I Keep From Singing? A Seeger Family Tribute (The American Folklife Center, Library of Congress)”; Anon. “Seeger Family Concert”].}

⁵⁰ Downloaded 23/01/2018 from https://upload.wikimedia.org/wikipedia/commons/0/0f/Charles_Seeger.jpg.

⁵¹ [Hood, 1963, p. 190–191].

⁵² [Reid, 1977, p. 416].

⁵³ Notably in most dissertations and research in the French academic system – not to single it out, but as an example with which I am most familiar.

⁵⁴ I am using here a further edition [Hood, 1982].

“The Problem of 1893” was stated about Japanese music by Francis Taylor Piggott⁵⁵:

“To the many beauties, and to the great merits, of the structure which has been raised upon [the rudiments of this music]⁵⁶, only my own ears can bear witness. The difficulties which stand in the way of reducing the music into Western written forms are so great, that, unless Japanese musicians will come and play to us here in England [for the English], accurate knowledge of their art, due appreciation of their craft, can only come into being in the West very gradually... Much of the charm of the music, all its individuality, nearly, depend upon its graceful and delicate phrasing: and although I think that Western notation is capable of expressing these phrases to one who has already heard them, I feel a little uncertain whether their more complicated forms could be set down in it with sufficient accuracy to enable a stranger to interpret them satisfactorily.”⁵⁷

Hood comments:

“As an essayist, I am not sure whether it is reassuring or discouraging to point out that almost a century later we are still concerned with the same chronic problem.”⁵⁸

While pinpointing the persistence of Occidentism (“ethnocentric prejudice”) in matters of scales and tunings,⁵⁹ Hood begins unfolding his “Solutions” with a quote from Alfred Hipkins’⁶⁰ Introduction to Charles Russel Day’s *The music and musical instruments of southern India and the Deccan*:

⁵⁵ Here quoted by Hood.

⁵⁶ Inclusions between brackets are by Mantle Hood.

⁵⁷ Original quote in [Piggott and Southgate, 1893, p. 5]; Hood’s reproduction in [Hood, 1982, p. 85]. Note that Seeger’s formulation quoted above conveys the same questioning as Piggott’s.

⁵⁸ [Hood, 1982, p. 85].

⁵⁹ [Hood, 1982, p. 87].

⁶⁰ Hipkins collaborated notably with Ellis as in [Ellis and Hipkins, 1884] in which they noted, [p. 372] among others, the correspondence between the “Highland Bagpipe scale” and the “Damascus form of Zalzal’s scale”. (Manṣūr a-ḍ-Ḍārib Zalzal – or Zulzul? – was a famous *ūd* player in the Golden Age of Arabian civilization who has supposedly introduced the “neutral” intervals in performance.) As he himself states in [Hipkins, 1903, p. 372–373], he also “had some share” in Ellis’ lecture “On the Musical Scales ...” [Ellis, 1885].

⁶¹ In [Day, 1891, p. xii], [Hood, 1982, p. 90].

⁶² [Hood, 1982, p. 92].

⁶³ Note also the works of Edith Gerson-Kiwi in this field, notably [Gerson-Kiwi, 1953]. Note that [Hood, 1979, p. 78] describes the pros and cons of Melograph Model C: “A vital core of twenty-five years of friendship was the eleven years of our association in the famous Wednesday seminars at UCLA. Charles dubbed me the ‘orchestrator’ of those weekly meetings of twenty-five to thirty graduate students, Seeger himself, Klaus Wachsmann, Leon Knopoff, Jozef Pacholczyk, Bill Hutchinson and colleagues on sabbatical

[Day] shows us the existence of a really intimate expressive melodic music, capable of the greatest refinement of treatment, and altogether outside the experience of the Western musician. What we learn from such inquiries is that the debated opinions of musical theorists, the cherished beliefs of those who devote themselves to the practice of the art, the deductions we evolve from historic studies—all have to be submitted to larger conceptions, based upon a recognition of humanity as evolved from the teachings of ethnology. We must forget what is merely European, national, or conventional, and submit the whole of the phenomena to a philosophical as well as a sympathetic consideration, such as, in this century, is conceded to language, but has not yet found its way to music.”⁶¹

Hood deems performance (learning the music) a first approach to music(s) along with – as a second approach – the search for written descriptions of the tunings and scale systems and – as a third approach – the implementation of the “Hipkins Solution” by ethnomusicologists.

While noting that

“The usage of some form of modified Western notation for transcription purposes, in spite of the fact that its limitations are generally understood, tends to be self-perpetuating,”⁶²

he reminds of the “Seeger Solution” which tries to take into account the subjectivity of the hearing of the ethnomusicologist who is conditioned by his culture and must try to “hear beyond” it, notably with the use of electronic devices, namely the Melograph Model C.⁶³

from round the world who, at first, were usually shocked by unabashed equality in discussion held among students and professors. In a lecture given much later at UCLA, Klaus Wachsmann referred to those years as the Golden Age of ethnomusicology.

Out of this period came the Seeger Melograph Model C. He and I made an exhaustive search for funds at such likely places as the National Science Foundation in Washington, D.C., where we were told that if we needed a fleet of automobiles, air conditioning, an added wing on an existing building, there would be no problem. But a laboratory instrument? In the name of music research? Impossible! We heard the word ‘no’ from many sources, until one day an impassioned plea to Chancellor Franklin Murphy prevailed. He immediately understood (being an M.D.) the importance of this development when we compared the existing tools of music research to the magnifying glass and Model C to an electron microscope. Subsequently, in the discovery of research, development and testing of Model C, we even began plans for [Melograph] Model D. Of course, they were never realized. **On the contrary, a few years ago, even Seeger Melograph Model C was dismantled.** Sent to the Physics Department for an estimate needed for repair, it was cannibalized instead. Seeger talked to one of the physicists who praised its unique camera developed for Model C which, today, is part of some unrelated research tool in physics. Professorial ignorance of our field and administrative indifference have forced us back to the crudities of the magnifying glass in music research. Notwithstanding Metfessel’s indisputable demonstration and Seeger’s

As for the “Laban Solution”, to the future of which the “Hipkins Solution” and the “Seeger Solution” – because of the international orientation of the first and of the descriptive accuracy of the second – are important, it is expected to be based on the Labanotation system⁶⁴ used for dance, in which various characteristics (such as pitch, dynamics, density, etc.) would be notated graphically. No concrete example of this “future” notation is, however, provided by Mantle Hood in the closing pages of this chapter on transcription and notation.⁶⁵

Fifteen years after Seeger’s “Prescriptive and Descriptive Music-Writing” Simha Arom explained⁶⁶ his use of field-recording technology with the sole aim of establishing [p. 166] a “score”, which in his view is a “synthesis” of the music he studied.⁶⁷ This seems a reversal of his previous views on notation as, few years before this article – and two years before the publication of Mantle Hood’s *The Ethnomusicologist* – Arom proposed in his “*Méthodes d’analyse en musicologie*”⁶⁸ an elaborated “new” transcription method for melodies (only), based partly on Jean-Jacques Rousseau’s numeral notation expounded in the latter’s “*Dissertation sur la musique moderne*”⁶⁹ and partly on Nicolas Ruwet’s propositions

internationally hailed developments of an automatic music writer, we have turned back the clock more than fifty years. For shame! After the brief period of revelations realized on Model C, we know there can be no ‘scientific’ research in music without its equivalent or better”. (Bold font is mine in all quotes of this dossier except otherwise stated.)

⁶⁴ See for example [Wikipedia Contributors, 2017a] or the writings of Ann Hutchinson-Guest, Albrecht Knust or of the main developer of the notation, Rudolf Laban.

⁶⁵ Hood’s three “solutions” are also summarized in [Reid, 1977, p. 418–419]: “The first of these solutions [...] we should provide the original, indigenous notation where such a notation exists and teach our colleagues how to read it. [...] The use of mechanical transcription to unravel the detail of the musical performance. [...] The need still remains for Hood’s projected third solution, a universal system of manual music notation. Hood suggests that the solution may be found in an adaptation for music of the admirable Labanotation now in use for dance”. Reid himself proposes a mixed solution using graphical (tonograms of pitches) and numbered notation.

⁶⁶ In [Arom, 1973].

⁶⁷ In the emended English translation of this article [Arom, 1976, p. 483] Arom’s position is even more clearly stated: “[T]he sum of the parts [of the polyphonic or the polyrhythmic music] in their respective combinations displays all the relevant features that distinguish a given piece from all others. Transcription of this sum produces a **score which alone allows a musical analysis**”.

⁶⁸ “Methods of Analysis in musicology” – [Arom, 1969].

⁶⁹ “Dissertation on Modern music”: explanations about this method are to be found mainly in [Rousseau, 1782, v. XVI, p. 69–92]: the

for a “paradigmatic analysis”⁷⁰ of melodies.⁷¹ The essence of this method is the use of successive numbers which are substituted to the notes of the score on the basis of a tonic note (numbered 1) with equivalences of the notes to the (upper or lower) octaves, differentiated by upper or lower (simple or double – for double octaves) lines.⁷² The basis scale (1 2 3 4 5 6 7) is, obviously for Arom, the major scale with accidentals – when they exist – expressed with oblique bars crossing the numbers.

Arom explains this choice through the comparison of the use of the notation system for the purposes of composition in western music, on one side – which is to convey the idea of the composer to the performer(s) in such a way as they would be able to reproduce the music he composed, whenever for an ethnomusicologist the aim is the opposite: transcribing live music in order to be able to understand the underlying “code” which rules it.⁷³

Arom further explains that he rejected from the outset the possibility of an intervallic transcription⁷⁴ because:

method was used by Constantin Brăiloiu for his (secondary according to Arom – as a complement to western classical notation) transcriptions, notably in [Brăiloiu, 1953].

⁷⁰ The term “paradigmatic” has been challenged for this type of analysis, with “sequencing” proposed as a replacement. (See the document for the doctoral course of François Picard at the university of Sorbonne – 2010-2011 – http://seem.paris-sorbonne.fr/IMG/pdf/analyse_paradigmatique_et_se_quenc_age.pdf.)

⁷¹ [Ruwet, 1966], translated two decades later (and preceded by a critical introduction) in [Ruwet and Everist, 1987].

⁷² Octave equivalences are explicitly stated by Arom who reproduces in [Arom, 1969, p. 179] Rousseau’s argumentation based on the “keyboard”.

⁷³ [Arom, 1969, p. 174].

⁷⁴ Already in use – according to Arom – in western music(ology), notably by Nanie Bridgman, and assigning 12 numbers to the intervals of the chromatic scale. For the latter, Arom cites “L’établissement d’un catalogue par incipit musicaux”, in *Musica disciplina*, vol. IV, 1950, pp. 65-68”, and “Le classement par incipit musicaux, Histoire d’un catalogue”, in *Bulletin des Bibliothèques de France*, 4^e année, no 6, 1959, pp. 303-308”; another system would have been used by the SACEM, the French Society of Authors, Composers and Publishers of Music (see <https://www.sacem.fr/en>). Reid cites Willi Apel [p. 149] in the 1969 “*The Harvard Dictionary of Music*. Cambridge: Harvard University Press” explaining that numerical notation was first developed in the West by Chev  for music education in France – see also [Wikipedia Contributors, 2017c; 2017e] (the first being in French and explaining that the first numerical notation could be by Juan Bermudo in the 16th century – see mainly aforementioned [Picard, 1999], notably p. 46). See also [Bent et al,

“it is easier to draw on degrees [of the scale] than intervals;⁷⁵ moreover, for the consignment of rhythmic values, it is clearly evident that the duration of the sound – or of the degree which symbolizes it – takes precedence over the duration of the interval which separates it from another [degree]”.⁷⁶

While it is difficult to understand this subtlety in the reasoning of Arom,⁷⁷ let us note that later on, in an article entitled “*Nouvelles perspectives dans la description des musiques de tradition orale*”⁷⁸ Arom includes, as the opening section of his explanations on “Analysis Methodology”, a sub-section on “*Transcription*”⁷⁹ in which he draws on Seeger’s *prescriptive* and *descriptive* “writing(s)” of music.

He further explains that the representation of the (to be analyzed) music must necessarily be graphical (written?) and that two choices are offered to the researcher for a descriptive notation which are: (1) notating with

2001, §I: General], notably: “Number notations are far later developments [than alphabetical, ideographic, tablature and neumatic notations]: apart from the use of numbers in Chinese *qin* tablature of the 10th century and Japanese *koto* tablature by the 12th, they arose in Korea in the 15th century, in Western tablatures in the 16th and thereafter with increasing popularity in the 19th and 20th centuries”.

⁷⁵ This depends, however, on the musician’s (singer’s) background: it is typically much easier for a trained cantor of Byzantine chant to read intervallic notation than to read pitch notation.

⁷⁶ [Arom, 1969, p. 176, footnote 2 continued on p. 177].

⁷⁷ Why should the duration of an interval (between two notes or degrees of the scale) be different from the duration of the note with which the interval begins? Unless this pitch is changing (*portamento* for example), in which case no effective pitch duration seems possible unless graphical – such as with computer analyses with Praat shown farther in this article, or as a *portamento* sign in the score in which case the duration of the pitch in the score is irrelevant for the pitch as such, but shows the duration of the *portamento* process. Or unless Arom’s restriction concerns chronology: a pitch which is maintained is heard “before” the interval it defines with the following pitch (but not with a simultaneous one). Note that in the case of (more or less) stable pitches and with graphical analyses such as with Praat expounded farther, intervals between pitches are well defined and constitute a better marker for scale(s) used in a particular music piece.

⁷⁸ “New perspectives for the description of traditional musics based on oral transmission”: [Arom, 1982], an emended translation of the “Symposium’80 – On Methodology”, *The World of Music*, XXIII/2 (1981), p. 40-62”.

⁷⁹ [Arom, 1982, p. 202–203].

⁸⁰ The first years of my working life were dedicated, concurrently with a thesis for Doctor in Sciences I was preparing at the *École Nationale des Ponts et Chaussées* in Paris, to the conception and programming of models of material stress under load in the conditions of fire. This implied the use of complex non-linear algorithms coupled with the method of finite elements, a procedure which allowed to break up a plane structure (a concrete slab for example) into a small number of elements with finite dimensions and on the nodes

the utmost precision the details of the audio material and (2) a preliminary determination of the relevant – for the members of the given community whose music is researched – aspects of the musical language.

The author discards the first option on the basis that precision in sonic details is limitless and impractical, thus his preference for the second choice based on a “preliminary analysis of the elementary constituents of the sonic material”. While the latter choice corresponds, however, to a “reduction” imposed through a model – which implies simplification,⁸⁰ Arom does not explain how to undertake this preliminary analysis and which analytical tools (Western? Preliminary scores?) must be used for the determination of these “elementary constituents”.⁸¹

(the end points of the three or four sided finite elements used in the model) of which were calculated the stress and other characteristics of the material. One of the critical parameters at that time, because of the load on the computers we used, was the size of these finite elements: the smaller they were, the more precise the results were, but computing time augmented exponentially with the reduction of these sizes. At some point too, further reduction of the sizes of the finite elements gave no substantial additional information about the behavior of the (general) studied structure.

The same would apply for a model on music as described by Arom, if there was one unique component of the music which was under scrutiny. When ignoring which of the characteristics of the studied music is (more) important (than others), the remaining “skeleton” may however give irrelevant information on the operation and progress of the studied process (this corresponds to what Mantle Hood entitled “The Horns of the Dilemma” in [Hood, 1982, p. 54]). In the case of the concrete slab the laws of physics and the characteristics of the material are previously known (data), whenever in a “foreign” music the “code” – as Arom calls it and which corresponds to the laws of physics in the concrete slab example – must still be determined, which means that the model interacts with vacuum, or at least with a series of unknowns (“variables”) which interact together, when you change one parameter, in a non-linear way. This makes it very unlikely that such a model would “simplify” the analysis of music whenever it is somewhat complex, and likely that (at least) some of the important aspects of the studied phenomenon (here music) would be overlooked by the analyst. In the case of *maqām* music and as explained in the next footnote, the heart of the music lies in the small details and in heterophony, both phenomena being irreducible to usual “model” analyses used in Western (ethno-) musicology.

⁸¹ This is a vicious circle indeed. Note also that the “reductive” procedure, as for example Schenkerian analysis applied in [Stock, 1993], is suitable to musics in which local instant variations (and modulations) do not play a major – and structural – role. In *maqām* music these aspects are most important as well as the heterophonic – constant – procedure at work, which makes most reduction procedures irrelevant.

Answers to this question were given, before Arom's analytical approach, by various ethnomusicologists including Merriam's (very) anthropological explanations⁸², here reported by William Poland:

"The Basongye people who live in the Republic of the Congo 'conceptualize music as a uniquely human phenomenon'. They make distinctions between noise and music with statements like these: 'When you are content, you sing; when you are angry, you make noise. When one shouts, he is not thinking; when he sings, he is thinking'. Merriam concluded: The Basongye 'theory' of music [...] seems to involve three essential features [...] first, the fact that music always involves human beings, and that those sounds emanating from non-human sources are not music. Second, the musical sounds that humans produce are organized [...] And third, there must be continuity in time",⁸³

or in a (much) broader manner by Ki Mantel Hood who writes (in "Musical significance"):

"I want to repeat the overriding question [at a Symposium of the Royal Anthropological Institute of Great Britain and Ireland held in London in March 1962] 'What is musically significant [sic:]?' Not 'What is symbolically significant?' The latter question is more the concern of the anthropologists. I am reminded of an example of symbolic meaning given by a student of anthropology who was impatient with some of his colleagues because of their expectations of ethnomusicology. 'The anthropologist,' he said, 'wants to know that when F-sharp is played on the flute used in initiation rites, that all male members of the tribe will urinate blue.' Before the anthropologist can understand what some aspects of music symbolize, we ethnomusicologists will have to discover what is musically significant. This question must be applied to three equally important and interdependent considerations. Given a musical tradition, 1) What is its significance in relation to the world of music? 2) What is its significance within the context of its own society? 3) What, in terms of the tradition itself, has significance?"⁸⁴

while explaining further:

"I have chosen to present six broad headings for discussion in the knowledge that there could be more and aware of the fact that each merits greater detail than we can afford here. The

first is concerned with sources and informants, the second with recording, the third with notation and transcription, the fourth with physical measurements, such as tuning, scale and tone quality, the fifth what I have chosen to call purely musical factors such as mode, melody, form, etc., the sixth text and speech associations",⁸⁵

and concluding:

"I wish to stress two points which should temper the latent fires of discussion on our subject. We must constantly bear in mind 1) that there are different degrees of musical significance and 2) that the musical significance of a given factor may vary in degree, depending on the context of its application".⁸⁶

George List's response to Mantel Hood's "Musical significance", in his "The Musical significance of transcription", is very instructive:

"[Transcription] is a prerequisite when it is desired to make detailed comparisons of certain aspects of musical events. Among these aspects are those listed under the fifth topic suggested by Mantel Hood, musical factors: mode, melody, form, etc."⁸⁷

adding:

"Notation by ear of vocal music usually omits much detail. The notes indicated on the staff admittedly often represent points in continuums rather than stable pitches. The same omissions are made in transcriptions by ear of singing in the Western European art tradition. In the latter case, however, we know that the concept of a scale of stable pitches is operative in the culture. We know that the composer was also governed by this concept. We are therefore in a position to make reasonably valid judgments concerning which details are musically significant in the culture and which are not",⁸⁸

and concluding:

"First: Neo-Pythagoreans aside, music is man-made. Music is a product of culture, not of nature.⁸⁹ Our perceptions are limited. We cannot overstep the thresholds of audibility or feeling nor can we react to frequencies outside a certain gamut. Past this what is music is determined by the culture, not by the harmonic series. Since music is man made, what is musically significant must be

⁸² Alan Merriam was a strong supporter of the "Anthropological" trend of ethnomusicology. Mantel Hood (quoted next in the text) highlights this attitude at the beginning of his "Musical significance" [Hood, 1963, p. 187]: "In 1961 at Princeton I met with Alan Merriam, David McAllester and Nicholas England, to discuss some of the problems of ethnomusicology. In one of these discussions, Merriam questioned the importance of precise measurements of tuning systems. He went on to ask whether tuning and scale were really significant".

⁸³ [Poland, 1963, p. 153] quoting "Alan P. Merriam, *A Prologue to the Study of the African Arts* (Antioch Press, Yellow Springs, Ohio, 1961) 27-28".

⁸⁴ [Hood, 1963, p. 188].

⁸⁵ [Hood, 1963, p. 189]: we can notice that, in this latter definition by Hood, the anthropological aspect is reduced to the first and sixth headings.

⁸⁶ [Hood, 1963, p. 192].

⁸⁷ [List, 1963, p. 193]. Note that "George List, [is] the Julliard-trained flutist and composer who represented the older, formal, approach to the study of folk and non-Western musics—the kind of scholarship that grew out of musicology" – in [Ivey, 2009, p. 20]; George List was still alive (and ninety-six years old) in 2007 (see [Walker, 2007], accessed 21/01/2018).

⁸⁸ [List, 1963, p. 195].

⁸⁹ This – with which I totally agree – was already said, one millennium ago, by Fārābī (see the epigraph to this dossier).

phenomena which man can hear, not phenomena which he cannot hear. There is therefore no value in considering in analysis aspects of a musical event which man cannot distinguish, whether these details are secured by decreasing the speed of a tape player or turntable or by means of electronic apparatus.

Second: The human ear is fallible. The two means mentioned are therefore extremely useful in checking on the accuracy of the ear. Our ears have been trained primarily to discriminate stable pitches, not pitches that are unstable. Until the time this lack of training is rectified we must depend upon electronic apparatus to assist us in plotting the melody of speech and of forms intermediate to speech and song, in graphically describing the vibrato and the effect of breath accent in vocal production. In producing melographs it will probably facilitate analysis if they are 'smoothed' until they represent as closely as possible what a properly oriented and trained ear can distinguish.

Third: When a hierarchy of musical values for a culture cannot be developed through work with informants from the culture, the researcher must determine the musical significance of the various style elements by reference to their frequency of occurrence and their stability versus their variability. Those which occur the most frequently and are the most stable are declared the most musically significant. Frequency or stability cannot be assessed until many transcriptions have been made and compared. It is thus necessary to indicate all detail possible that the ear can distinguish since there is as yet no means of determining which details are musically significant and which are not".⁹⁰

This would have been an interesting step towards the recognition of different musical cultures, different ways of hearing and listening to music. However, a year later, in "Transcription III", one of four transcriptions published in 1964 in *Ethnomusicology* after a session held at the meeting of SEM at Middletown on November 1 - 1963,⁹¹ List explains that in his analysis:

"The tonal aspects [...] are based upon theories advanced by Paul Hindemith.⁹² The differential tones utilized in determining the roots of harmonic and melodic intervals are a type of combination tones. However, the differential tones are physiological rather than acoustical phenomena",⁹³

concluding:

"Since the inner ear of all men is similar in construction, differential tones are audible to some extent to all men. Theories based upon their effect may therefore be justifiably employed

in the analysis of the music of either the Bushman or of the German Romantic movement".⁹⁴

The roots of this (very) occentric remark are to be found in Hindemith's theories. In his "Theories of Music and Musical Behavior", William Poland explains:

"The standard work in English on theories of music is by Shirlaw⁹⁵. It is a curious and unsatisfactory work but it does represent the point of view which may be called the main stream of theories of music in western civilization. This stream is commonly considered to have its source in the mathematical mystic, Pythagoras. Those who hold this point of view believe that the object of the music theorist is to discover eternal, unchanging, laws of nature 'derived' in the words of Hindemith, 'from the natural characteristics of tones, and consequently valid for all periods'⁹⁶. Hindemith is the most important contemporary theorist who has tried to generate a universally applicable theory of music based on "natural laws". Hindemith characterized this main stream of thought in his description of the views of those he called 'the ancients': 'Intervals spoke to them of the first days of creation of the world; mysterious as Number, of the same stuff as the basic concepts of time and space, the very dimensions of the audible world, building stones of the universe, which, in their minds, was constructed in the same proportions as the overtone series, so that measure, music, and the cosmos inseparably merged'⁹⁷. In his own theory Hindemith finds 'the intervals imbedded in the tonal raw material which Nature has made ready for musical use, consisting of an infinite number of tones [...]. Into this inchoate tonal mass we can introduce a certain order by the use of the immutable measures of the octave and the fifth'⁹⁸. Hindemith is at one with Zarlino, Mersenne, Rameau, and Helmholtz in his use of the first six harmonic partials of a tone as the basis for his theory. He asserts that partials one through six outline an extended major triad, and that 'Music, as long as it exists, will always take its departure from the major triad and return to it'⁹⁹,¹⁰⁰

adding that

"Natural-law theorists still hold the position that explanations may be found in immutable measures – whatever they may be – related to supposed physical characteristics of that limited set of sounds which have harmonic partials. They are also most vehement in their assertion that music is a universal language which expresses our innermost feelings, and in the denial of the study of musical behavior as a source of information which

⁹⁰ [List, 1963, p. 196].

⁹¹ This was a symposium on the transcription and analysis of one song as explained in [Anon. "From the Editor (Vol. 8, issue 3)", 1964].

⁹² List makes here a reference to [Hindemith, 1945, p. 57 sq.] in which the author expounds "Combination tones" and, most probably, to the next sections in Hindemith's entitled "Inversion" and "Interval roots".

⁹³ [List, 1964, p. 255].

⁹⁴ [List, 1964, p. 259].

⁹⁵ Poland refers here to *The Theory of Harmony* [Shirlaw, 1955].

⁹⁶ Poland makes here a reference to the 1941 edition of "P. Hindemith, *The Craft of Musical Composition*, Bk. 1. A. Mendel, trans. (Associated Music Pub., New York, 1942) 9", corresponding to [Hindemith, 1945, p. 9].

⁹⁷ [Hindemith, 1945, p. 12–13].

⁹⁸ [Hindemith, 1945, p. 15].

⁹⁹ [Hindemith, 1945, p. 22].

¹⁰⁰ [Poland, 1963, p. 152–153].

might effectively contribute to more adequate theories of music".¹⁰¹

All is said here as Hindemith's theoretical thought is the basis for the "evolutionary" theories of music, based on the Resonance theory and the cycle of fifths.¹⁰²

A decade later, the same George List explains in "The reliability of Transcription":

"[T]here are two principal methods by which [...] visual representations [of performances] can be secured. They can be made by ear and hand or produced by an electronic device. In the first case the result is usually a transcription in musical notation; in the second it may take the form of a graph of the fundamental pitches. To the latter may be added a graph of intensity or amplitude. Other possible methods of visual representation are the making of hand graphs or the measurement of individual tones by the monochord¹⁰³ or an electronic device.¹⁰⁴ Our purpose here is to assess the reliability of transcription in the form of musical notation made by ear and hand. Only transcriptions made of a single melodic line will be considered and only two aspects of melody, pitch and duration".¹⁰⁵

A comparison between hand (ear) transcription (notation) and electronic graphs is undertaken further by List in this article, for a Rumanian carol and for two (Yiddish and Thai) lullabies (an example for the Thai lullaby is reproduced in Fig. 3):

"[T]he two methods of producing transcriptions are not comparable. The hand notation is a product of the human mind which attempts to synthesize the data heard and to offer an intelligible description of the whole in symbolic guise. The electronic device, on the other hand, makes no judgments. [...] Finally, to make the desired comparisons we must first interpret the electronically produced graphs".¹⁰⁶

In his endeavor to exclude events not fitting in the score we find, in the comments for the "Thai lullaby", the following gem:

"The instruments utilized in Thai art music are tuned in a different temperament than that utilized in our Western music. It is conceivable that Thai folksongs [such as this lullaby] may be influenced by Thai instrumental art music".¹⁰⁷

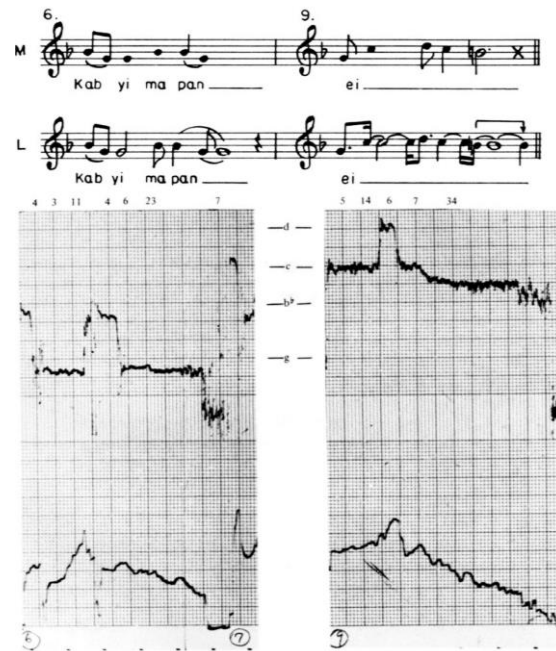

Fig. 3 Figure 9 in [List, 1974, p. 371] with a notated melody and Melograph transcription.¹⁰⁸

Arguing further about the inaccuracy of the measurements of the "Melograph"¹⁰⁹, List discards the discrepancies shown between the Western notation and the "electronic device" results shown in Fig. 3 and concludes (as a supplementary gem) for this lullaby:

"It therefore would seem reasonable to assume that the pitches notated reflect what is found in the graph",¹¹⁰

and in general for his article (as a final gem):

"Finally, and this is the principal point to be derived from this aspect of the discussion, when transcriptions in the form of notation made by ear and hand are compared with electronically produced graphic transcriptions of the same recorded performance the former display proportionally more accuracy than inaccuracy, and the modifications made on the basis of the information offered by the graph are slight. [...] the inescapable conclusion is that the capability of the unaided human ear should not be underestimated. The evidence indicates that

¹⁰¹ [Poland, 1963, p. 155].

¹⁰² See Chapter II in [Beyhom, 2016a].

¹⁰³ As explained in Chapter IV of [Beyhom, 2016a] for the "measurements" of the Music Committee (for the Second 19th-century Reform of Byzantine chant), the reliability of pitch measurements with the monochord is very relative, if not impossible to establish in real life situations.

¹⁰⁴ A review of Pitch measurement methods and their reliability (and a test of the program Praat) is available (for French-speaking readers) in [Beyhom, 2007].

¹⁰⁵ [List, 1974, p. 353].

¹⁰⁶ [List, 1974, p. 365].

¹⁰⁷ [List, 1974, p. 373].

¹⁰⁸ The original legend stands: "Thai Lullaby, Phrases 6 and 9. Comparison with Melograph of Majority Opinion of Students [who participated in the transcription process and formulated their observations about pitch and time duration] and Transcription by George List". Above: pitch graph; below: intensity graph; "M" and "L" are staff identifiers. Quarter-tone discrepancies between Western notation and tonogram (graph above) are clearly distinguishable.

¹⁰⁹ See http://seem.paris-sorbonne.fr/IMG/swf/an_mhaighdean_mhara.swf in which Picard shows the nearly exact correspondences between the graphics of the "Melograph" of Seeger and graphics produced by advanced pitch-measuring programs such as Praat.

¹¹⁰ [*ibid.*].

transcriptions made by ear in notated form are sufficiently accurate, sufficiently reliable to provide a valid basis for analysis and comparative studies of the two aspects of musical style discussed, pitch and duration”.¹¹¹

To such an assertion could be opposed¹¹² another experiment, undertaken by myself when I was teaching ethnomusicology in a Lebanese university. The students listened to Breton songs and tried to determine the scale used in one of the songs. Most of the students – who were all trained in the *maqām* tradition as well as in western music – could not determine a definite scale, while one student (who later graduated brilliantly) determined, obviously by ear, that the song was in the scale of *maqām Rāst*, which obviously it was not.¹¹³

Other aspects of *maqām* music¹¹⁴ or subtleties of ornamentation or of pitch positioning shown elsewhere by the author¹¹⁵, or predominant in Indian music,¹¹⁶ – in fact all we know about non-tempered music – contradict these (very) occicentric statements of George List.

The “inescapable conclusion” is that List made in this analysis all the errors that he himself and others warned about, and imposed a reading grid – here western notation – “to be read by people who do not carry the tradition of the other music” (to quote Seeger once again).

Anyways, Arom’s (changing) position on the use of western notation, which is challenged when applied to monodic music but becomes essential when applied to polyphony – including non-western polyphonic or poly-rhythmic music(s) – is typical of the biases of Western (and here – maybe – typically French and European) ethnomusicology – which still relies mainly on the

(equally) western musicology for its analysis of “foreign” music(s).

Moreover, and whenever Arom’s method for the notation of “monodies” seems to have been too radical a change from western notation despite all critics about the latter when applied to musics not complying with western common practice, one real change would have been the shift from pitch to intervallic notation – as used for example in Byzantine chant notation – but this was probably asking too much from a discipline so closely dependent on (Pitch) music scores for centuries.¹¹⁷

Finally: there is no better conclusion(s) to this part as the introductory paragraph of Bruno Nettl’s sixth chapter of his *Study of Ethnomusicology*, entitled “I Can’t Say a Thing Until I’ve Seen the Score”¹¹⁸:

“Western urban society has a special view of music. We may say that a folk singer deviates from the way a song is ‘written’ when we really mean from the particular form in which he has learned it. We use the term ‘writing music’ broadly, substituting it for ‘composing,’ whether notation is involved or not. We think of a piece of music as existing in its truest form on a piece of paper. The academics among us can hardly conceive of discussing music without knowledge of a single, authoritative, visible version. ‘I can’t say a thing until I’ve seen the score,’ the critic may say upon hearing a new piece; it is surprising that he does not normally say about a new score, ‘I can’t say a thing until I’ve heard it.’¹¹⁹ Dealing with the written music is the classical musician’s ideal. ‘Can you read music?’ is the question used to separate musical sheep from goats, to establish minimum musical competence”,¹²⁰

and Cooks reflections on the role of “ear-training” in Music education:

“An even more basic example of how educational institutions construct and naturalize musical culture is provided by what is

¹¹¹ [List, 1974, p. 375–376].

¹¹² Besides point “3” in Reid’s quote as epigraph to this article, in which he mentions specifically (withdrawn from the epigraph) List’s analyses.

¹¹³ Traditional Breton scales, according to my analyses with Praat, are generally not tempered, but different from the scales of *maqām* music. Erik Marchand, a well-known Breton singer, used to call the nearly “major” scale of Breton music “the Breton *Rāst*”. See also in Part III of this dossier the analyses of *Ar bern plouz* by Manu Kerjean, published as video-analyses at <http://foredofico.org/CERMAA/analyses/breton-music>, and underlining the differences between the singer’s performance and the “minor” scale.

¹¹⁴ As for example for the song *Hawwīl yā Ghannām* sung by Najāh Salām – as expounded in [Beyhom, 2016a, p. 151–152, fn. 782 and FHT 11: 185].

¹¹⁵ See the Interlude in [Beyhom, 2016a, p. 151–152].

¹¹⁶ See for example [Krishnaswamy, 2003 ; 2004 ; 2004], but also the comprehensive blog of Wim Van der Meer at <http://thoughts4>

ideas.eu/ including notably the video <https://vimeo.com/120632175> – accessed 10/01/2018, not forgetting Meer’s invaluable Praat manual at <http://thoughts4ideas.eu/praat-manual-for-musicologists/>.

¹¹⁷ The suitability of intervallic relative notation for *maqām* music is discussed farther in this article.

¹¹⁸ [Nettl, 1983, p. 65–81]: this whole chapter is a retrospective of the problems of notation and transcription, with Nettl implicitly disapproving “automatic notation” while at the same time criticizing Western attitude towards score notation. This attitude is common enough among western ethnomusicologists to raise the question why can such highly educated scientists not overcome their fear of losing their last – however important – castle.

¹¹⁹ The author of this dossier totally agrees with the second formulation of this anonymous critic.

¹²⁰ [Nettl, 1983, p. 65].

sometimes revealingly termed ‘ear training’, a kind of conditioning that takes place at an early stage of conservatory or university education: students are taught to recognize such things as the notes of the scale, the chordal types of ‘common-practice’ harmony, and the basic formal schemes of the classical tradition (binary, ternary, sonata, and so on). When I say ‘things’, I mean the word literally: students are being inducted into the world of Western musicianship, in which music is made up of ‘things’ to hear, constructed out of notes in the same sense that houses are constructed out of bricks. And this has two results. The first is that music is transformed from being primarily something you **do** (but do not necessarily know how you do) to something you **know** (but may not necessarily do); in other words, it is embraced within the structures of the knowledge industry, and of a society which tends to value theory above practice. The second is that it becomes increasingly difficult to conceive that music might work in other ways, or to hear it properly if it does; the harder you listen, the more you hear it in terms of the notes and chords and formal types of the Western tradition, and the less you can understand music that works primarily in terms of timbre and texture, say”,¹²¹

concluding

“At all levels, then, what you know about music can open your ears to it or close them, make certain types of music seem ‘natural’ and others not just inconceivable but, in effect, inaudible. No wonder, then, that music education has become a political battleground on both sides of the Atlantic”.¹²²

*
* *

PART II. A HISTORICAL REVIEW OF THE NOTATIONS OF MAQĀM MUSIC

“The notation of pitch [...] has never been of more than three kinds—alphabetical, imitative, and by the ladder”

[John Stainer, “On the Principles of Musical Notation”]¹²³

“We have no record to prove that the Phoenicians or Hebrews had any method of noting music, nor, indeed, do we imagine that any music worth noting existed amongst them”

[Henry Lunn, “The History of Musical Notation”]¹²⁴

Is it possible to notate a music the notes of which do not lend themselves to standardization, or – simply stated – to notation as it has evolved within Western music? This depends on the purpose of this notation, descriptive or prescriptive as stated by Seeger – or also, from the author’s point of view, on whether it is anterior or posterior to the music itself.

Ethnomusicologists deal mostly – if not exclusively¹²⁵ – with pre-existing music that they try to understand and, for some of them, to analyze. Analytic ethnomusicology needs then a descriptive as well as an analytical tool to research non-Western musics.¹²⁶

Musicians¹²⁷ and composers, on the other side, whenever they may use the tools of Analytic ethnomusicology to (try to) understand some of the peculiarities of a given music, need to notate music for the purpose of being able to reproduce it when needed, to share it with others as a practical means of producing (performing) it, or with the aim of preserving a repertoire from oblivion. They need to write – or consult – a *score* which implies a reduction of the characteristics that are scored.

Notations of *maqām* music have always evolved between the prescriptive and the descriptive aspects of music. From the – known – alphabetical beginnings to

¹²¹ [Cook, 2000, p. 104] – Bold font by the author.

¹²² [Cook, 2000, p. 105].

¹²³ [Stainer, 1874, p. 89–90].

¹²⁴ [Lunn, 1866, p. 261].

¹²⁵ Except in the cases of “Revivalism” of nearly-extinct traditional musics.

¹²⁶ It may be useful here to remind the reader of the purpose of conventional musicology when dealing with these musics – and the use of conventional musicological tools to analyze *maqām* music: there are thoroughly expounded in [Beyhom, 2016a].

¹²⁷ Note that traditional musicians did not need a score to perform music.

the latest computer-aided adapted western notations, the discussion about the aims of notation was never decided in one way or the other.

Moreover, in a society based on oral tradition – such as still (somehow) the *maqām* societies¹²⁸ – the usefulness of notation could also be debated. This is no more the case today when almost all *maqām* music is taught using adapted western scores.¹²⁹

Early notation of *maqām* music

The first – known – notation of *maqām* music is by Yūsuf Abū Yūsuf Ya‘qūb ibn Ishāq ibn a-ṣ-Ṣabbāḥ ibn Ismā‘īl ibn al-Ash‘ath ibn Qays al-Kindī (9th century). It is in fact a sort of literal tablature for the *ūd*.¹³⁰ It is also the first known example of – limited and hypothetical – polyphony in Arabian writings on music. (FHT 21: 218)

Other Early notations of pitch – reduced however to the scale – were based on the Arabian alphabet (*Abjad* – Fig. 4 and Fig. 5) while combining these with a tablature for the *ūd* such as with Abū-n-Naṣr Muḥammad ibn Muḥammad ibn Ṭarkhān ibn Uzlagh al-Fārābī in the 9th-10th centuries (FHT 2: 208, and FHT 3: 208 as a modern equivalent).

Later writings by *maqām* theoreticians are all influenced by the first book of Ṣafīyy-a-d-Dīn ‘Abd-al-Mu‘min ibn Yūsuf ibn (ab-ī-l-Ma)Fākhir (al-) Urmawī (d. 1294)¹³¹, the *Kitāb al-Adwār* [*Book of Cycles*] in which, in parallel to a Pythagorean construction of the scale based on string-lengths divisions (Fig. 6), Urmawī uses an *Abjad* notation (Fig. 7, FHT 4: 209, FHT 5: 209)

concurrently with an intervallic – literal – notation (FHT 6: 210).¹³²

أ	Alif	1	س	Sin	s	60
ب	Ba	(a) 2	ع	‘Ayin	‘	70
ج	Jim	b 3	ف	Fa	f	80
د	Dal	j 4	ص	Ṣad	ṣ	90
هـ	Ha	d 5	ق	Qaf	q	100
و	Wa	h 6	ر	Ra	r	200
ز	Zay	w 7	ش	Shin	sh	300
ح	Ḥa	z 8	ت	Ta	t	400
ط	Ṭ	ḥ 9	ث	Tha*	th	500
ي	Ya	ṭ 10	خ	Kha*	kh	600
ك	Kaf	y 20	ذ	Dhal*	dh	700
ل	Lam	k 30	ض	Ḍad*	ḍ	800
م	Mim	l 40	ظ	Ẓa*	ẓ	900
ن	Nun	m 50	غ	Ghayin*	gh	1000
		n				

* These letters were added to the initial 22 Phoenician letters.

Fig. 4 The *Abjad* alphabet and numerical equivalences.¹³³

The later book of Urmawī, the *A-sh-Sharafīyya Epistle*, features notated examples of melodic phrases using the extended *Abjad* notation devised in the *Book of Cycles*.¹³⁴

Later (intermediate) writings use a literal description of the notes to describe – notably – the scales of Arabian music, with accidentals in “half of the interval” or *nusf* (pl. *anṣāf* – Fig. 8).¹³⁵

¹²⁸ Which are becoming, as all other Human societies, audio-visual cultures?

¹²⁹ A notable exception is *tajwīd* (Koranic recitation) – but for how much longer? Ironically (and most probably), this chant still survives because it is not considered, by the clerical hierarchy, as “music” (*mūsīqī*). As for Byzantine chant: in Volos, during his presentation at a conference on Psaltiki (Byzantine religious chant – see Part III of this dossier), speaker (and cantor in Sophia - Bulgaria) Jordan Banev warned against the classification of Byzantine chant as “Music”, precisely to avoid further distortions in this chant.

¹³⁰ In the *Risāla fi-l-Luḥūn wa-n-Naḡham* (*Mukhtaṣar al-Mūsīqā fi Ta‘līf a-n-Naḡham wa Ṣin‘at al-‘ūd*) [from Manisa (Turquie), MS. 1705, f^{os} 110v^o-123r^o. In Arabic رسالة الكندي في اللحن و النغم [Kindī (al-) and 1965, الكندي].

¹³¹ Ṣafīy al-Dīn al-Urmawī was the founder of the so-called – by Western Orientalists – “Systematist School”, the theory of which is based on a Pythagorean division of the octave in 17 intervals.

¹³² Note that the theoretical scale of Urmawī, based on a division of the octave in 17 *leimmata* and *commata*, comprises intervals of one whole tone *T* composed of two *leimmata* + one *comma*, and two *mujannab(s)* (“neutral” second or “medium tones”) which can be either composed of two successive *leimmata* (*M₁*), or of one *leimma* + one *comma* (*M₂*). His intervallic divisions of the polychords in the manuscripts (one of which is shown in FHT 6: 210) suggest that he based himself on a proportional progression, the whole tone being (evidently) greater than the two *mujannab(s)* and the two *mujannab(s)* being conceptually equivalent one to the other.

¹³³ According to [Ifrah, 1994, p. 585].

¹³⁴ See [Urmawī (d. 1294) and [Jurjānī (al-)], 1938, v. 3, p. 169–173].

¹³⁵ These are treatises and epistles such as [Anonyme, 1983; {Ṣafadī (a-ṣ-)}, 1991]. As long as the exact general scale is not described by these authors, resulting scales of *maqāmāt* (= pl. of *maqām*) can only be approximated – notably on the basis of the contemporary scale of *maqām Rāst*.

MNEMONIC WORDS	BREAKDOWN	
أبجد Abjad	أ ب ج د d j b '(a) ←	أ ب ج د 4. 3. 2. 1 ←
هوز Hawazin	ه و ز z w h ←	ه و ز 7. 6. 5. ←
حطي Ḥuṭiya	ح ط ي y t h ←	ح ط ي 10. 9. 8 ←
كلمن Kalamuna	ك ل م ن n m l k ←	ك ل م ن 50. 40. 30. 20 ←
سقفص Sa'faṣ	س ع ف ص ṣ f ' s ←	س ع ف ص 90. 80. 70. 60 ←
قرشت Qurshat	ق ر ش ت t s h r q ←	ق ر ش ت 400. 300. 200. 100. ←
ثخذ Thakhudh	ث خ ذ d h k h t h ←	ث خ ذ 700. 600. 500. ←
ضظغ Ḍazugh	ض ظ غ g h z ḍ ←	ض ظ غ 1000. 900. 800 ←

Fig. 5 Mnemonic words (*ab[a]jad haw[w]az...*) for the *Abjad* alphabet and breakdown.¹³⁶

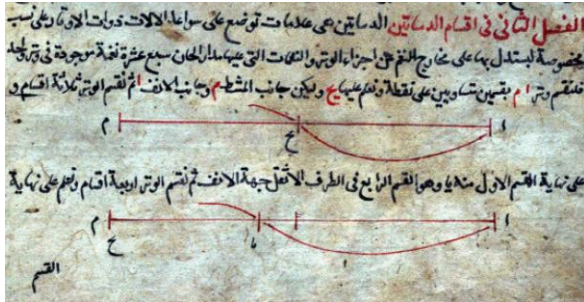

Fig. 6 Using the division of the string for constructing the scale in [Urmawī (d. 1294), 2001, p. 2].

The most probable position of the *nusf* of a *burda* (degree of the basic scale) is the upper one.¹³⁷ The resulting scale would be composed of 14 adjacent intervals, the exact size of which is still unknown.¹³⁸

¹³⁶ According to [Ifrāh, 1994, p. 587].

¹³⁷ This seems to be the case for all the “halves” cited in the *A-sh-Shajara* treatise [Anonyme, 1983], independently from the direction of the intervals, i.e. ascending or descending.

¹³⁸ See also [Beyhom, 2005] and [Beyhom, 2012].

¹³⁹ Previously published in the endnotes of [Beyhom, 2012]. *Burda* (pl. *burdāt*) = “degree” or “interval”; *nusf* (pl. *anṣāf*) = “half”.

¹⁴⁰ [{Ṣafādī (a-ṣ-)}, 1991].

¹⁴¹ A third possibility – yet to be explored – is that the scale of the two cited treatises corresponds theoretically to the scale of Urmawī

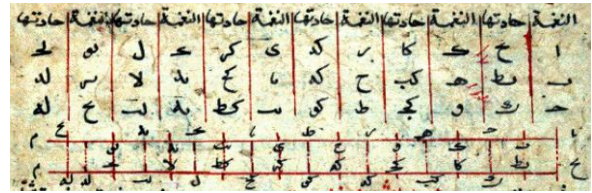

Fig. 7 Use of the *Abjad* alphabet in [Urmawī (d. 1294), 2001, p. 4].

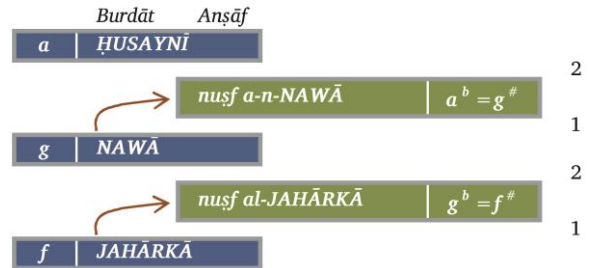

Fig. 8 Most probable division of the intervals in the *A-sh-Shajara* treatise. (Contemporary note names for the Arabic scale and western equivalents are provided in FHT 8: 211.)¹³⁹

Other representations of the scale, mainly in the so-called (a-ṣ-) Ṣafādī epistle,¹⁴⁰ feature two *anṣāf* (“upper” and “lower”) with two possible explanations for their positioning (Fig. 9 and Fig. 1).¹⁴¹ In this case, the theoretical scale would have been composed of seven intervals divided in three “thirds”, a hypothesis which is further expounded in FHT 7: 211.

Most importantly, the denominations featured in these treatises are still in use today – with slight modifications – in *maqām* teaching,¹⁴² including the first writings of the “Modern” era, notably with Mikhā’il Mashāqa and Kāmil a-Khulā’ī¹⁴³ which used however multiple ways for the delineation of the intervals of the “Arabian” scale.¹⁴⁴

– based on a division of the octave in 17 *leimmata* and *commata* – with some intervals (the whole tones) having two “*anṣāf*” and the others – the “neutral” seconds – having only one “*nusf*”.

¹⁴² See FHT 54: 242 to FHT 56: 244.

¹⁴³ Which are reviewed in the following sections.

¹⁴⁴ Including string-lengths divisions and frequency ratios, together with geometric constructions – most of these are theoretical although some may have been based on interval perception.

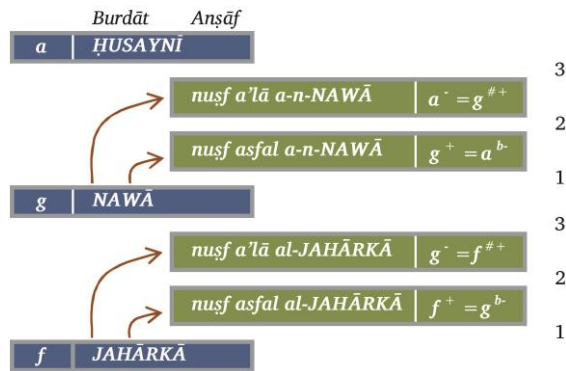

Fig. 9 Two upper *anṣāf* possible divisions (1) of the intervals in [Şafadī (a-Ş-), 1991].¹⁴⁵

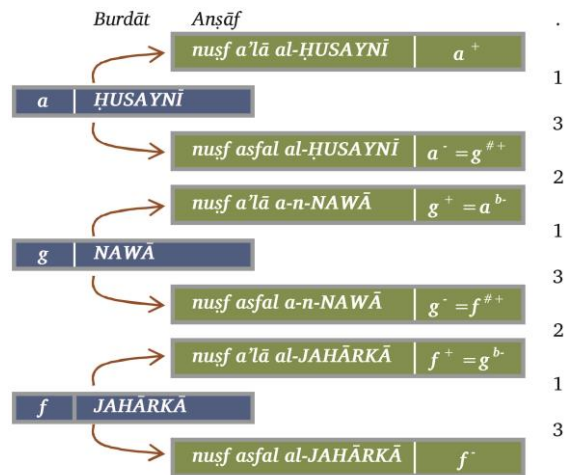

Fig. 10 Two upper *anṣāf* possible divisions (2) of the intervals in [Şafadī (a-Ş-), 1991].

¹⁴⁵ *Burda* (pl. *burdāt*) = “degree” or “interval”; *nusf* (pl. *anṣāf*) = “half”; *a'lā* = “high, higher, [a'lā min] higher than”; *asfal* = “low, lower, [asfal min] lower than”.

¹⁴⁶ I use the following division of the history of Arabian music (theory) in [Beyhom, 2010c]: 1. *The Forerunners*: mostly Kindī (9th century) and Munajjim (9th and beginning of the 10th centuries); 2. *The Golden Age*: from (al-) Fārābī (Latinized “Alfarabius” – 10th century) to ibn Zaylā (d. 1048), not forgetting the mentor of the latter, ibn Sinā – or Avicenna – (980-1037); 3. *The Systematists*: beginning with (al-) Urmawī (13th century), with followers such as (al-) Lādhiqī or (al-) Marāghī; 4. *The Intermediate Period*: with writings such as the anonymous *A-sh-Shajara dhāt al-Akmām* [Anonyme, 1983], or [Şaydāwī (a-Ş-), XV^e siècle] (translated to French in [Şaydāwī (a-Ş-) and Antar, 2001]), or the pseudo Şafadī published as [Şafadī (a-Ş-), 1991]; 5. *The Moderns*: beginning with (‘Aṭṭār and) Mashāqa (19th century) and ending with the 1960s (not forgetting [Khulā‘ī (al-), 1904]); 6. *The Contemporary Period*: roughly since the 1970s and the predominance of the Conservatoires in the teaching of Arabian music. (Note that periods 3 and 4 may overlap.) As for Arabian music *per se*, [Jargy and Chottin, 2001, p. 527] identify (for example – other theoreticians propose other time divisions still) five time periods (which correspond in part only to the aforementioned six, and disregard the post-*Congrès du Caire* period), namely: “1) *Bedouin period*,

One notable addition to the authors of the “Intermediate” period¹⁴⁶ is the case of Shams-a-d-Dīn a-Ş-Şaydāwī a-d-Dimashqī, who uses a graphical color code for his explanations about the scales of *maqām* music (Fig. 11).



Fig. 11 (Detail from) Folio 14 v° from the BNF Ms. or-2480¹⁴⁷ *Kitāb al-In‘ām fī Ma‘rifat al-Anghām wa Sharḥihā* by Shams-a-d-Dīn a-Ş-Şaydāwī a-d-Dimashqī¹⁴⁸.

This unique¹⁴⁹ code, despite its – relative – dissemination¹⁵⁰, and although it uses similar terminology as other writings of the same period, is still however not completely deciphered notwithstanding the numerous research published about it.¹⁵¹

from the *Jāhiliyya* [‘the time of ignorance’] till Early Islam (death of ‘Alī, 661); 2) *Assimilation period*, from the Umayyad dynasty till the First Abbasid cycle (*circa* 830); 3) *Period of Fulfillment and Dispersion*, with the second Abbasid cycle and the establishment of the Umayyad in Spain; 4) *Period of Decline*, from the taking of Granada (1492) till the end of the 18th century; 5) *Renaissance*: from the *Naḥḍa* in the 19th century, beginning with the expedition of Bonaparte in Egypt, until the [C]ongrès du Caire (1932)”.

¹⁴⁷ [Şaydāwī (a-Ş-), XV^e siècle].
¹⁴⁸ See [Neubauer, 1997] for more details on this author and his *urjūza*, notably: “The ‘little Arabic book on music’ [of Şaydāwī] aroused considerable excitement when it reached Paris in 1634. It figures in Diderot’s *Encyclopédie* (Planches, vii, 3-4) and in d’Herbelot’s *Bibliothèque orientale* (ii, 758), and it was partly translated, around 1780, by Pigeon de Saint-Paterne on behalf of de La Borde”.
¹⁴⁹ [Neubauer, 1997]: “al-Şaydāwī’s musical notation is unique in Arabic (and also Persian and Turkish) music literature”.

¹⁵⁰ See [Odeimi, 1994, p. 29].
¹⁵¹ See fn. 148 above and, for example, [Shiloah and Berthier, 1985], [Şaydāwī (a-Ş-) and Antar, 1979; 1999], [Odeimi, 1994] and [Şaydāwī (a-Ş-) and Ghrab, 2002].

Few other notations preceding westernized scores¹⁵²

The 19th century brought with it massive interventionism of Western musicology¹⁵³ – which was not yet thus called – in *maqām* music and many different ways of coping with this influence *and* try to keep the characteristics of this music intact.¹⁵⁴

The main subdivisions of *maqām* music which devised alternative notating systems were both at the heart of the Ottoman Empire, namely Ottoman music and Byzantine chant. Both were triggered by Western influence.

BYZANTINE NOTATIONS FROM THE 19th CENTURY¹⁵⁵

Byzantine melodic notation is, from the outset, an intervallic notation.¹⁵⁶ While undergoing many reforms in its centuries long history, Byzantine chant was subject to two major reforms in the 19th century alone, both initiated by the Patriarchate of Constantinople. These were attempts at acknowledging Western influence while, in the same time, trying to maintain Byzantine chant tradition – and its “Oriental” characteristics – alive.¹⁵⁷

One of the most important “novelties” brought by the First Reform (1814-1818) was the introduction of a specific solmization based on the Greek alphabet (Fig. 12) together with basing the intervallic notation of the scales on a division of the octave in 68 unequal “minutes”¹⁵⁸ (Fig. 15 and Fig. 16). In Fig. 15, in which two systems for constructing the scales are shown, the

central octave (beginning with *νη*) is identical for the two systems and corresponds theoretically to the scale of *maqām Rāst* in Arabian music.¹⁵⁹ (Fig. 13)

Byzantine	Πα	Βου	Γα	Δι	Κε	Ζω	Νη	(Πα)
degree	πα	βου	γα	δι	κε	ζω	νη	(πα)
Western	d	e-	f	g	a	b-	c	(d)
Rōmanou	pa	bou	ga	di	ke	zo	ne	(Pa)

Fig. 12 Solmization of Byzantine chant – from the First Reform (1814-1818) of the 19th century – and equivalences.¹⁶⁰



Fig. 13 Scale of *maqām Rāst* in “Modern” Arabian notation – taken from [Beyhom, 2015, p. 170 (Figure 141)]. The “flat” accidentals with an oblique crossing dash are “half-flat” (quarter-tone) accidentals.

Specific accidentals for *intervals* (Fig. 14) allowed for a more precise notation of the subtleties of Byzantine chant based on the division of the whole tone in quarter-tones and thirds-of-the-tone.

Πλεονεξία μὲν	Μειονεξία δὲ
τὸ μὲν εἶ ἐνὸς τεταρτημορίου ¼	τὸ μὲν εἶ ἐνὸς τεταρτημορίου ¼
τὸ δὲ εἶ δύο τεταρτημορίων ½	τὸ δὲ εἶ δύο τεταρτημορίων ½
τὸ δὲ εἶ τριῶν τεταρτημορ. ¾	τὸ δὲ εἶ τριῶν τεταρτημορ. ¾
τὸ δὲ εἶ ἐνὸς τριτημορίου ⅓	τὸ δὲ εἶ ἐνὸς τριτημορίου ⅓
τὸ δὲ εἶ δύο τριτημορίων ⅔	τὸ δὲ εἶ δύο τριτημορίων ⅔

Fig. 14 Accidentals [of intervals] as explained by Chrysanthos Madytos, the theoretician of the First Reform of Byzantine Chant in the 19th century.¹⁶¹

¹⁵² Note that excerpts from the musics and analyses addressed in the following sections are available as byproducts of previously published material by the author – mainly Power Point shows.

¹⁵³ While it may be argued that Western notation – and musicology – brought some clarity into the (mess of the) analysis of *maqām* music, we will see that the influence of this musicology eventually implemented new contradictions and ambiguities in this music while (see [Beyhom, 2016a]) modifying its characteristics.

¹⁵⁴ See [Beyhom, 2016a] for a detailed review of Orientalism in musicology.

¹⁵⁵ For Byzantine notations before the Reforms of the 19th century see the interesting – however misled as to the roots of Byzantine chant – Wikipedia article [Wikipedia Contributors, 2018f] – accessed 19/07/2018. For Byzantine music after the 2nd Reform of the 19th century see the very complete article [Skoulios, 2012], with tables for the intervallic signs [p. 21] and alterations [p. 32].

¹⁵⁶ See previous footnote and [Levy and Troelsgård, 2001, “1. Manuscript sources and their notation”].

¹⁵⁷ See Chapter IV in [Beyhom, 2016a] and, mainly, [Beyhom, 2015] for detailed explanations about this process.

¹⁵⁸ The numbers of “minutes” (or *moria*) are mainly used for proportionality: the *moria* are not equal in each of the intervals, and most probably also not equal within the same interval composing the scale (see Fig. 15). They are probably the result of a double division, first of the strings of a “*tanbur*”, then of the resulting intervals in particular – and proportional – numbers of *moria*. (See previous footnote.) Note also the *diphonic system* (to the left in Fig. 16) in which 64 *moria* (and not 68) compose the octave.

¹⁵⁹ See Fig. 13.

¹⁶⁰ Reform of the “Three Masters”, among which Chrysanthos Madytos was the theoretician – see Chapter IV in [Beyhom, 2016a] for more details. The bottom row shows the Latin equivalents used by Rōmanou in her translation(s) [Chrysanthos (de Madytos), 2010; Chrysanthos (de Madytos) and Rōmanou, 1973] of Chrysanthos *Great Book on Music* [Chrysanthos (de Madytos) and Pelopidēs, 1832].

¹⁶¹ [Chrysanthos (de Madytos) and Pelopidēs, 1832, p. 101]: raising accidentals to the left, lowering accidentals to the right. Subdivisions (accidentals) in fractions of the tone are, from top to bottom: 1/4, 1/2 (2/4), 3/4, 1/3 and 2/3.

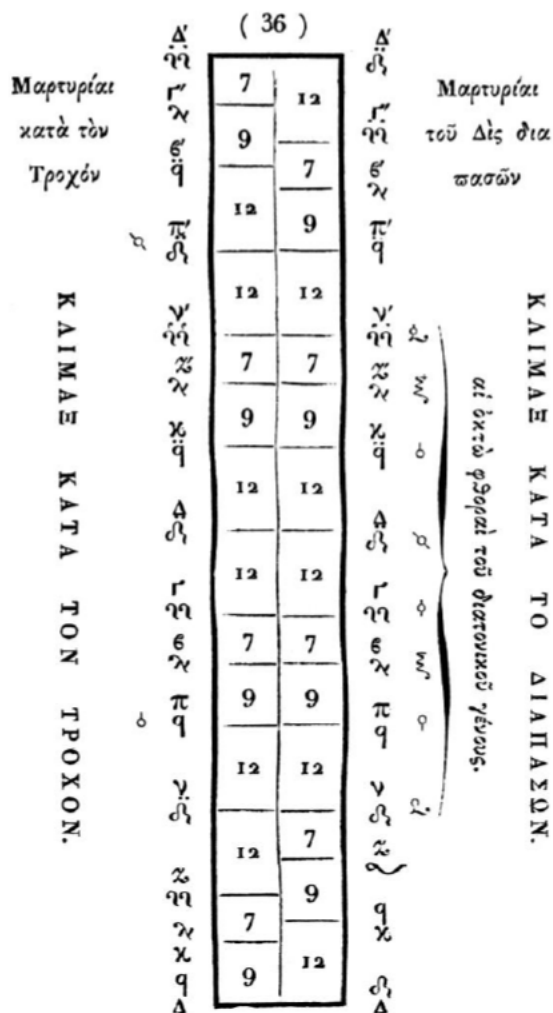

Fig. 15 Diatonic system of the wheel (pentachordal – Left) compared to the diapason diatonic system (Right – effectively based on a tetrachordal construction) in Chrysanthos Madytos' *Eisagogē*.¹⁶²

While keeping the same solmization and notations signs, the Second Reform (1881) waived – among other things – the unequal division of the octave of Chrysanthos Madytos and replaced it with an equal-division (in 72 *moria*) based on equal-temperament (Fig. 18 to Fig. 20).¹⁶³

¹⁶² [Chrysanthos (de Madytos), 1821, p. 36].

¹⁶³ The theoretical justification of the scale being, nonetheless, a harmonic division based on superparticular intervals. (For this and other particularities of the two reforms see, as proposed in fn. 157, Chapter IV in [Beyhom, 2016a] and [Beyhom, 2015].)

¹⁶⁴ [Chrysanthos (de Madytos) and Pelopidēs, 1832, p. 106-107, §245], corresponding to [Chrysanthos (de Madytos) and Rōmanou,

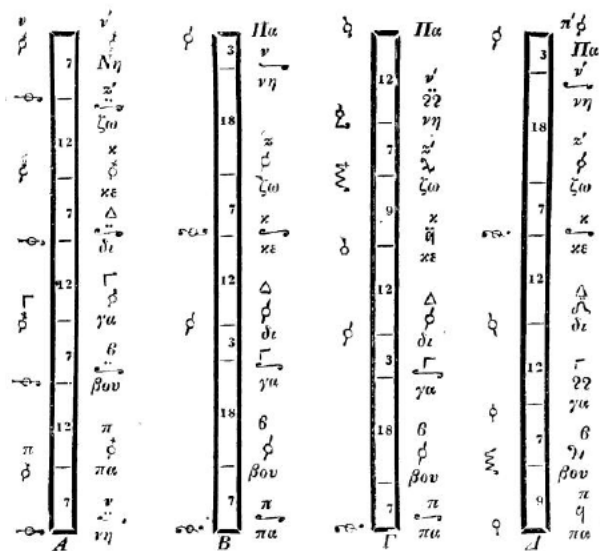

Fig. 16 Chromatic systems according to Chrysanthos Madytos, with the diphonic system to the left.¹⁶⁴

It also replaced Chrysanthos' accidentals by accidentals effectively based on the division of the whole tone in six equal intervals (and of the octave in 36) allowing thus for the use of exact (and tempered) semi-tones. (Fig. 17)

As for the intervallic – and simplified – resulting notation, two examples are provided in FHT 43: 233, FHT 44: 234 and FHT 51: 239 with westernized transnotations in FHT 45: 235, FHT 46: 236 and FHT 52: 240.¹⁶⁵

Sharp signs	♯	♯	♯	♯	"New" Byzantine
		†	≠	#	#
Divisions	2	4	6	8	
equ. in cents	33.33 c.	66.66 c.	100 c.	133.33 c.	
Flat signs	♭	♭	♭	♭	Westernized
	♭	♭	♭	♭	"New" Byzantine

Fig. 17 Byzantine accidentals – Second Reform of the 19th century – with westernized equivalents and values in cents.

1973, p. 99]. The *diphonic system* is composed of 64 (instead of 68 in other systems) *moria* in the octave, which proves the inequality of the *moria* among themselves; the 12 *moria* interval is a whole tone, while the 7 *moria* interval is a (nearly exact) three-quarter-tones interval.

¹⁶⁵ See also [Skoulios, 2012, p. 21] for a table of the signs used in the reformed notation.

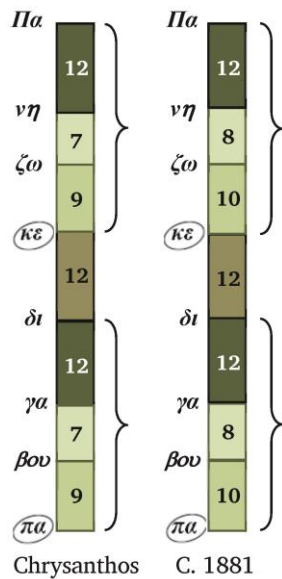

Fig. 18 Structure of the *diatonic system* (main scale) of Byzantine chant.¹⁶⁶

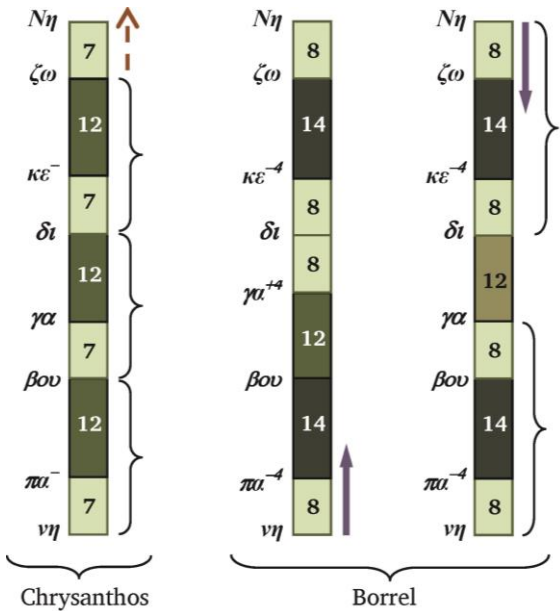

Fig. 19 The *diphonic system* of Byzantine chant.¹⁶⁷

¹⁶⁶ In disjunct tetrachords and as deduced from the theories of Chrysanthos Madytos (left) and of the Music Committee of 1881 (right). The background colors of the intervals follow a code used in the book of the author [Beyhom, 2015]: Green in different shades for the “diatonic” intervals (7 to 13 *moria* in Chrysanthos’ scales), red-ish for the intervals greater than the whole tone, and blue(ish) for the other intervals. The green 12-division (whole-tone) interval gets a maroon(ish) shade when it is a disjunctive tone – previously published in [Beyhom, 2014].

¹⁶⁷ According to Chrysanthos Madytos (left) and the evolution of its presentation in the theory of the Music Committee of 1881 as the *soft chromatic system* (right – rising and descending scales are subject to the phenomenon of “attraction”) as explained by Borrel. (+ and – alterations are in numbers of *moria* for the 2nd Reform. Note that

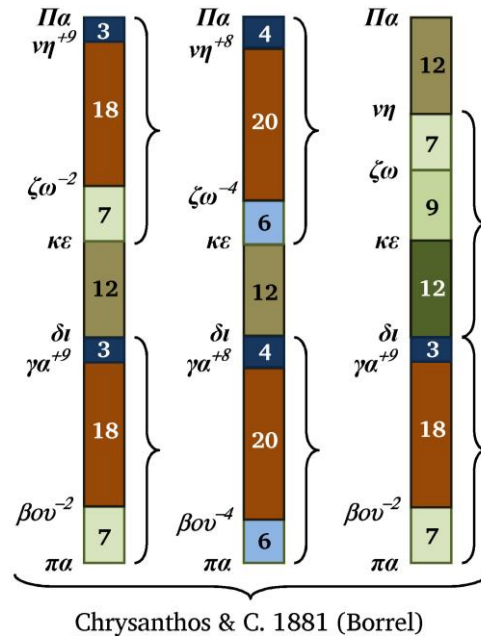

Fig. 20 Some Byzantine *chromatic systems*.¹⁶⁸

In the meanwhile, and preceding or accompanying Byzantine reforms, a few attempts at notating Ottoman music took place in the 18th to 20th centuries.

LATE OTTOMAN NOTATIONS¹⁶⁹

It took a while for musical notation to be accepted in the Ottoman Empire, first by Europeans – and in Western scores – then in forms presumably more adapted to Ottoman music:

“The very slow acceptance of any form of musical notation during the 19th century, documented by Behar [...], seems to have been largely due to the perception of the necessity for lengthy rote-learning in order to assimilate both musical detail and style. However, by the middle of the 20th century the acceptance of both musical notation and a consistent form of theory for pedagogical purposes led to the existence of two forms

the degrees $\pi\alpha$ and $\kappa\epsilon$ with Chrysanthos are slightly offset.) See [Beyhom, 2015] for more details – Previously published in [Beyhom, 2014].

¹⁶⁸ On this figure are represented the second main *chromatic system* of Chrysanthos (left) and its evolution in the representation by the Music Committee (1881) of the Second Byzantine Reform of the 19th century (“C. 1881” – center). To the right: a *diatonic-chromatic* variant (third main *chromatic system*) by Chrysanthos. These *systems* (mostly the first to the left) are typical of the Sixth Mode of Byzantine chant. (Previously published in [Beyhom, 2014].)

¹⁶⁹ Most of the information in this section relies on two secondary sources which are [Feldman, 1996] and [Jäger, 2015].

of legitimation, one through conservatory instruction and the other through master-pupil training”.¹⁷⁰

The first known Intermediate¹⁷¹ notations, together with later notations as well as the first westernized scores, were created by groups somewhat atypical of the Ottoman mainstream:

“The musical theory which was created between 1700 and 1900, and which dominated Arab musical theory until the mid-20th century [...] had its beginnings primarily in the treatise of Prince Cantemir, and not in the 15th-Century treatises by Ottoman writers or in older Persian or Arabic theory. The indigenous, emic response to these Western influences seems to have been created primarily by two groups who were somewhat atypical of the Ottoman mainstream: Mevlevi dervishes like Osman Dede, Mustafa Kevseri, Abdalbaki Nasir Dede and Rauf Yekta, and non-Muslims like [the Armenians] Tanburi Harutin and Baba Hamparsum”.¹⁷²

These notations are well-established since the 18th century¹⁷³ which marks the beginning of autochthonous melodic notations.¹⁷⁴

¹⁷⁰ [Feldman, 1996, p. 18].

¹⁷¹ Between the very rudimentary notations by Urmawî expounded above and the adapted Western notation used today.

¹⁷² [Feldman, 1996, p. 25].

¹⁷³ “Many of the structural and stylistic changes which had occurred between 1600 and 1750 are documented in the notations and treatises which form the material for the present study. Although there is a dearth of notated documents dating from the second half of the 18th century, and although certain crucial documents of the first half of the 18th century are presently unavailable to scholarship, the final results of these developments of the 18th century can be judged by assessing the Turkish repertoire and performance practice of the Modern Era. This is well known thanks to a continuous series of notations starting in the early 19th century (i.e., the Hamparsum notebooks 1813-1815) which record repertoire of several key instrumental musicians of the end of the previous century, a major treatise written in 1795, the first notation of a Mevlevî *âyîn* from the same date, and a continuous lineage of performers spanning the period from the reign of Selim III (1789-1808) until the present day” – [Feldman, 1996, p. 24].

¹⁷⁴ “The stages of transmission [of Ottoman notation systems are] 1650 (Ali Ufkî), 1700 (Cantemir), 1750 (Tanbûrî Petros) [Petros Peloponnēsios] and 1815 (Hamparsum)” – [Jäger, 2015, p. 48].

¹⁷⁵ “Toward the end of the century a new cultural climate both at the court and among the Mevlevi dervishes encouraged a variety of initiatives in musical writing, focusing on notation, theory and lyric collections (*‘mecnû’â*) of the courtly *fasil* repertoire. However, in the first half of the century, an historical accident resulted in the entry of a multi-talented and musically educated European into the Ottoman Palace Service first as a slave-musician (from 1633 to 1651-57) [...], then as an interpreter, who recorded a significant sample of the courtly and other repertoires in Western staff notation. The *‘Mecnû’â-i Saz ü Söz*’ (‘Collection of Instrumental and Vocal Works’) by the converted Pole, Wojciech Bobowski (1610-

Besides the Bobowski accident,¹⁷⁵ the first pre-Western notations in Ottoman music (Fig. 21)¹⁷⁶ date back to the 18th-Century Moldavian Prince Cantemir and Osman Dede. This first attempt at a notation specific to Ottoman (court) music was based on the parallel use of numerals and letters¹⁷⁷. (Fig. 21)

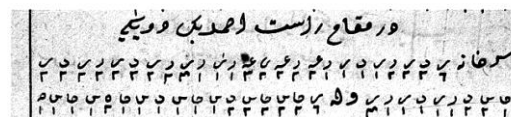
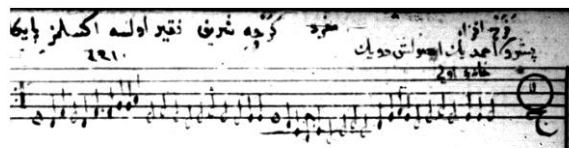

Fig. 21 Comparison of an extract of the same *pesrev* of Ahmed Bey as notated by Ali Ufkî (Bobowski – Top) and Cantemir (bottom).¹⁷⁸

It remained however isolated until the creation of the so-called *Hamparsum* notation (Fig. 22) which uses graphical signs instead¹⁷⁹:

1675), who took the Turkish name Ali Ufkî Bey was created before the cultural developments of the later 17th century, and evidently was removed from Turkey so that it could not play any part in musical thinking there. While Bobowski wrote several other works, including musical settings for the Biblical Psalms [...] and a brief description of the Palace and its musical life, his major significance rests on this *‘Mecnû’â*. The *‘Mecnû’â* is a collection, without a treatise. It contains over three hundred pages of Western staff notation written right to left and the texts of the vocal pieces. There are 195 instrumental pieces, of which 145 are *pesrevs* and 40 are *semâ’îs*. Bobowski evidently wrote this work for himself alone” – [Feldman, 1996, p. 29].

¹⁷⁶ “The most important musicological materials created in the 18th century, [...] are contained in the collection of notations and musical treatise of the Moldavian voyvod Prince Demetrius Cantemir (1673-1723), known in Turkish as Kantemiroğlu” – [Feldman, 1996, p. 30]. (See also fn. 184 for Osman Dede.)

¹⁷⁷ “The notation [of Cantemir] uses letters and numerals to write down the quality and quantity of the tone on two interconnected levels. The method parallels the one used already in the 17th century to write down the *usûls*. Cantemir’s notation is appropriate to notate the course of a melodic line in parameters of pitch and rhythm” – [Jäger, 2015, p. 46].

¹⁷⁸ Courtesy of Ralf Martin Jäger – originally published in [Jäger, 2015, p. 44].

¹⁷⁹ “The notation method of Hamparsum Limonciyan, a century later, is based largely on the same conception that Cantemir used: quality and quantity of the single tone are notated on two interconnected levels. *Hamparsum-notası* proves to be a method that emerged in the context of older Ottoman notations. However, it differs from Cantemir’s notation in important details: instead of letters and numerals, it uses abstracted graphical signs (derived from Armenian *khaz* notation) which are combined into groups of equal

“The question of Cantemir’s influence upon later Turkish theorists has been debated. In the following generation only the Mevlevi dervish Mustafa Kevserî (d. 1770?) seems to have learned his notational system, and neither his notes nor his theory were referred to by the later 18th-century theorists. The Frenchman Charles Fonton was unable to locate a copy of Cantemir’s treatise in 1750. Cantemir’s fame as a musicologist seems to have been better established among European visitors such as Fonton or Toderini, and among the local Greeks than among the Turks”¹⁸⁰.

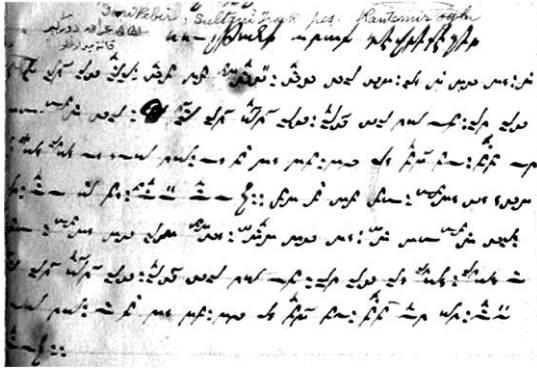

Fig. 22 Detail view of Y.203-1 (Y.86-01), fol. 1 – *Sultani arak devr-i kebîr* in *Hamparsum*(s) notation [originally notated by Cantemir].¹⁸¹

Note however that

(1) “Osman Dede wrote a notated collection using his own system of alphabetic notation, whose alphabetical symbols are distinct from those of Cantemir [...]. It is not known whether Osman Dede’s collection is earlier or later than Cantemir’s. This collection is still extant in Turkey, but is in private hands and has never been the object of serious study”¹⁸²

and that

(2) “After Cantemir’s treatise, [... there] is a treatise in Armeno-Turkish (Turkish in the Armenian script) by the Armenian *Tanbûrî* Harutin, who was a court *tanbûr* player for Sultan Mahmud I (1730-1754). [...] Harutin also was the inventor of a notational system based on the Armenian alphabet which he included in his book without any notated examples”¹⁸³

whenever

duration. It develops additional signs for the graphical depiction of the groups. More important is the differentiation in major line and additional tones, which complement the melodic line in the form of grace notes. Moreover, *Hamparsum*’s notation allows the notation of rests for the first time. It is also suitable to write down performance details to a limited extent, along with the melodic line” – [Jäger, 2015, p. 46–47].

¹⁸⁰ [Feldman, 1996, p. 32].

¹⁸¹ With transcriptions of the title by Refik Fersan [Ottoman writing] and Suphi Ezgi [Latin writing]. Courtesy of Ralf Martin Jäger – originally published in [Jäger, 2015, p. 47].

(3) “Between 1794 and 1795 the Mevlevi Sheikh Abdülbâkî Nâsir Dede (1765-1821) [Osman Dede’s grandson – p. 95 of the same reference] created a musical treatise [...] and notated a score for a Mevlevi *âyîn* written by his patron Selim III using a new notational system [based on his grandfather’s]”¹⁸⁴

One further notation by the well-known composer of Byzantine chant Petros *Hirsis* (“Thief” in Turkish)¹⁸⁵ is to be mentioned, based on the Byzantine neumes of the pre 19th-Century-Reforms period. (Fig. 23)

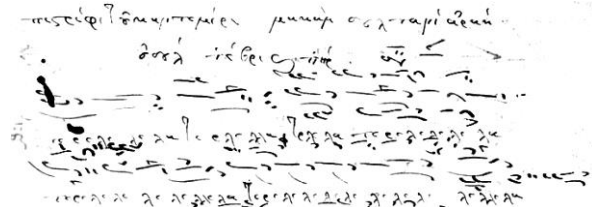

Fig. 23 Detail from the transcription by Petros Peloponnēsios of *pistrifi tō kantemira makâm sultanî arâk ûsûl devri k[e]bîr* – from Gritsanis Ms. 3, f° 14 r°.¹⁸⁶

All these notation methods, as Jäger underlines, focus on different characteristics of sound and none is completely descriptive: they serve before all as a mnemonic aid and score each different details which may have seemed important to the composer or the musician:

“Both the notation and the notes [used by Petros] focus entirely on details other than the two Ottoman methods. *Tanbûrî* Petros did not write down the single tones of the melodic line, but rather their melodic flow in intervals: neume notation emerged to set a music which serves to deliver texts. Thus, only a part of the signs notates the melodic progression and its rhythmical structure, while another – for instance the 7 *Achrona* – captures the style of performance and indicate rest, tremolo, *sforzato*, mordent, legato, the intonation of a caesura or the ‘humming’ of a tone”¹⁸⁷.

Aural tradition remained, however and through, the main vector of the transmission of music as it was practiced at the Ottoman court.

Moreover,

¹⁸² [Feldman, 1996, p. 33].

¹⁸³ [Feldman, 1996, p. 33, 34].

¹⁸⁴ [Feldman, 1996, p. 35].

¹⁸⁵ This is Petros Peloponnēsios, well-known for his ability for notating a melody after having heard it once – see also [Conomos, 2007].

¹⁸⁶ Courtesy of Ralf Martin Jäger – originally published in [Jäger, 2015, p. 48].

¹⁸⁷ [Jäger, 2015, p. 47]. See also the quotes from the same reference above.

“[t]he comparison of the sources provides evidence that each notated variant of an [Ottoman] *opus* has an individual character. It is this parallel transmission of variants within the ‘*opus*-cluster’, which accounts for the peculiarity of the Ottoman sources. It is not the search for the ‘original text’, i.e. the binding form of the *opus*, but the determination of the synchronous individual variants which could be a central point of investigation in the study of these sources. The associated methodological concept differs fundamentally from the approaches and aims which had been developed for research and documentation purposes, and ultimately for the creation of critical complete editions of European music of modern times”.¹⁸⁸

KHOREZMIAN TANBUR TABLATURE

In 1990 an interesting article about a *tanbur* tablature was published in the ICTM revue, in which Otanazar Matyakubov explained:

“In Khiva, in the last quarter of the 19th century, a special tablature for the *tanbur* was created by means of which an abbreviated text of the Khorezmian *māqams* was fixed. Among musicians these manuscripts are called *tanbur chizigi* (tanbur transcriptions), while in present-day literature they are known as ‘Khorezmian *tanbur* notation’”.¹⁸⁹

This tablature (see the *chizigi* – graphics – in FHT 18: 217 to FHT 20: 218) was very detailed:

“The notation can be converted into sound by anyone who has the indispensable aural experience and commands the tradition of the Khorezmian *māqams*. Principles of Notation[:] The *tanbur* notation fixes five parameters of the *māqams*: the pitch (parameter), the metric-rhythmic, the syntactic (microstructure), the compositional (macrostructure), and the poetic. The pitch of the tones constitutes the basic core of the transcription. The *tanbur* notation justifies its name: the height of the tones is fixed corresponding to the 18 frets on the fingerboard of the *tanbur*, the horizontal lines of the notation. They are designated by order numbers in vertical order. The dots indicate the number of plucks of the *nakhun*, a special plectrum that is worn on the index finger of the right hand for performing on the *tanbur*. A dot above the line is a pluck from above, below the line, from below. A single pluck, the stroke *yākkā-z[ā]rb*, is written separately, a double pluck, *khush-zārb*, in pairs above and below the line. The *usul*—a metric formula that is written down with the syllables *gul* and *tāk*—gives an indication of the grouping of the pulse.”¹⁹⁰

¹⁸⁸ [Jäger, 2015, p. 45].

¹⁸⁹ [Matyakubov and Powers, 1990, p. 29].

¹⁹⁰ [Matyakubov and Powers, 1990, p. 32].

¹⁹¹ Property of Jean During. Photo courtesy of the owner.

¹⁹² Translated from a private communication from Jean During in French.



Fig. 24 Bookbinding of a copy of the *Khorezmian tanbur notation*.¹⁹¹

At practically the same period and still in Khiva,

“[t]o fix the repertoire, Feruz Khan [Muhāmmād Rāhim Bāhādūr Khan] commanded as early as 1878 to notate it in a specially invented system. At the dawn of the 20th century twentieth century, the Master Qalandar Donmas recorded the integral repertory on barrel organ punch cards [Fig. 25]. No sponsor has yet been found in order to perform them”.¹⁹²

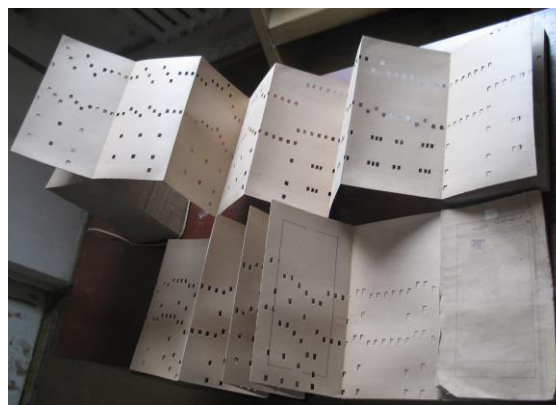

Fig. 25 Barrel organ punch cards recorded by Qalandar Donmas.¹⁹³

This is the main reason why a relation between the two notations has not yet been established.¹⁹⁴

As for the Arabian countries, and as explained above, the major change was to be the implementation of the quarter-tone scale – and eventually notation – in the theoretical discourse on *maqām* music.

¹⁹³ Photo courtesy of Rustam Boltaev via Jean During.

¹⁹⁴ One possibility is that the “piano rolls” could correspond, according to During (who refers to https://uz.wikipedia.org/wiki/Tanbur_chizig'i – in Uzbek, and to his own [Anon. “DOTĀR”]), to the classic repertoire of 30 songs transcribed for the *dutor* in 1883 – the *Dutor Maqomlari*.

MĪKHĀʿIL MASHĀQA AND KĀMIL AL-KHULAʿĪ – OR THE IMPLEMENTATION OF THE WESTERN THEORY OF THE SCALE IN MAQĀM MUSIC



Fig. 26 Photograph of Kāmil al-Khulaʿī appearing in the reprint of his book on Arabian music.¹⁹⁵

The Arabian countries, still under Ottoman rule,¹⁹⁶ were the most receptive in the 19th century to the Siren song of Western musicology. Theoreticians and *maqām*-connoisseurs began (at least) as early as the beginning of the 19th century discussing the concept of the “quarter-tone” division supposedly at the basis of “Arabian” music.¹⁹⁷ Thus Mikhāʿil Mashāqa¹⁹⁸ in the 1820s relating a discussion in Damascus between his mentor sheikh Muḥammad al-ʿAṭṭār and a protagonist named ʿAbd-al-Lāh Effendī Mühürdār, in which the former defended a division of the octave half-string in 24 equal parts to obtain the “quarter-tones” of Arabian music.¹⁹⁹

Notwithstanding the fact that *maqām* music never used a division of the octave in (equal) quarter-tones,²⁰⁰

Mühürdār objected that equal quarter-tones could not be obtained with this method.

In the *Epistle to the Emir Shihāb*²⁰¹ Mashāqa tries to prove Mühürdār right by giving a geometric method for dividing the string in order to obtain (nearly) exact quarter-tones (Fig. 27).²⁰²

Mostly, however, he deems the quarter-tone division “inferior” (for *maqām* music obviously) to the division of the scale of the “Modern Greeks”²⁰³ and compares them together – underlining the (theoretical) discrepancy between the two.²⁰⁴ (see a table of the in FHT 10: 212 and a detailed reproduction of the two scales in FHT 12: 213)²⁰⁵

Nevertheless, and whenever Mashāqa expressed his disbelief in the virtues of this division, he has been considered as the “inventor” of the quarter-tone division by Orientalist musicology.²⁰⁶ On the other hand, he certainly used the concept of quarter-tones to describe literally the scales and formulae of Arabian *maqām* music.²⁰⁷

About one century later the quarter-tone division had become a must through the pen of – mainly – Egyptian authors such as Kāmil al-Khulaʿī²⁰⁸ who – also²⁰⁹ – divided the “Arabian” (*Rāst*) octave in intervals of one-whole-tone and three-quarter-tones (Fig. 28) – based on quarter-tone multiples.

However, at least one other division was proposed in the meanwhile by Shihāb-a-d-Dīn (Muḥammad ibn Ismāʿīl ibn ʿUmar al-Makkī) al-Ḥijāzī, based on 28 “quarter-tones” in the octave (Fig. 29).

¹⁹⁵ [Khulaʿī (al-), 1993].

¹⁹⁶ And influenced by Ottoman theories of the scale – see fn. 172: 166.

¹⁹⁷ The Arabs, in their endeavor to differentiate themselves from the Ottomans, found it – at least for most of them – easier to fully embrace the Western semi-tonal division of the scale by simply dividing the semi-tone in two – theoretical if not practical – parts.

¹⁹⁸ The first chapter of [Beyhom, 2015] expounds the contribution of this author to the Modern theory of *maqām*.

¹⁹⁹ [Beyhom, 2015, p. 12].

²⁰⁰ Early theoreticians of *maqām* based themselves from the outset on Greek theories of the scale. They used thus the concept of the quarter-tone theoretically, namely for the enharmonic *genos*. (See [Beyhom, 2010c].) Later theoreticians complied either with Urmawī’s theoretical division or with the literal description of the scale by naming the notes.

²⁰¹ [Mashāqa, 1887] or an English translated version in [Mashāqa and Smith, 1849].

²⁰² See also the caudal plates in [Mashāqa and Smith, 1849].

²⁰³ The Byzantine chant theory of the 1st Reform of the 19th century.

²⁰⁴ Note that Mashāqa assumes in his “epistle” that the *moria* of Chrysanthos were equal, which they were not.

²⁰⁵ An obvious comparison, however, would have been between the scale of the Second Byzantine Reform of the 19th century (in sixths of the tone) which shows a greater compatibility with the quarter-tone division (FHT 11: 212) – but the latter reform took place first in the 1880s. (See also both Byzantine scales compared with the “Arabian” quarter-tone scale in FHT 13: 214 – remember however that Chrysanthos’ scale is not based on equal-temperament.)

²⁰⁶ See for instance [Parisot, 1898].

²⁰⁷ See [Azar Beyhom, 2012].

²⁰⁸ As one example – another important Egyptian author contemporary to Khulaʿī is Muḥammad Dhākir (Bey) who published booklets on Arabian music theory (see [Dhākir (Bey), 1890a; 1890b; 1903]).

²⁰⁹ Khulaʿī copied off Mashāqa and Ḥijāzī (see farther for the latter).

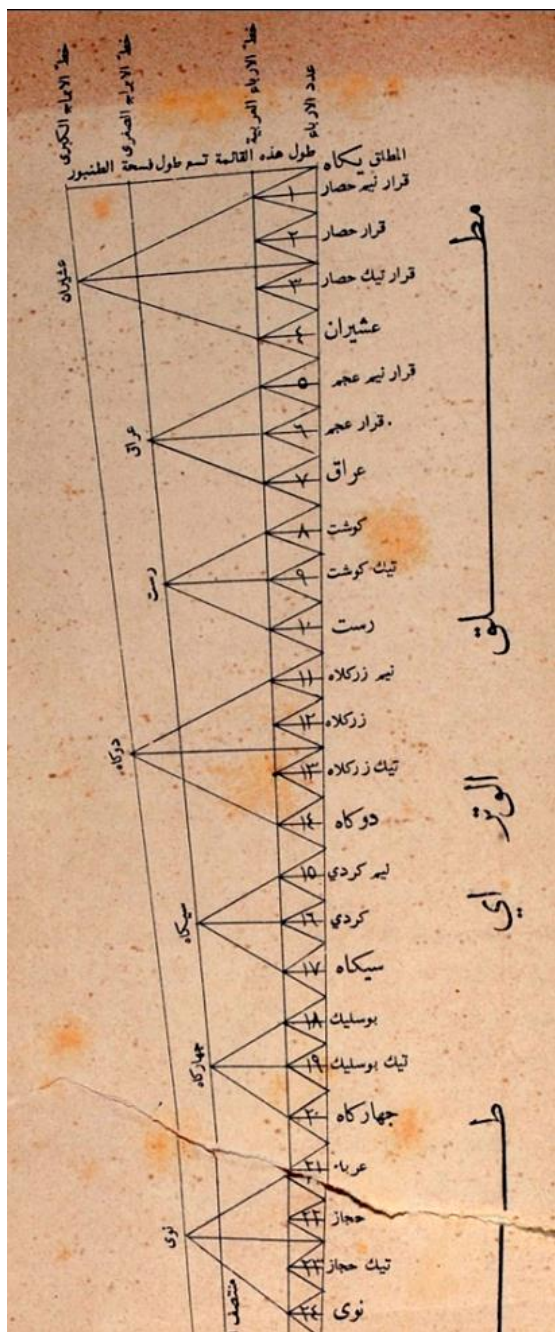

Fig. 27 Detail from Mashāqa’s division of the string of the *ṭunbūr* explaining how to establish an equal-division of the octave in 24 quarter-tones.²¹⁰

²¹⁰ [Mashāqa, 1899, plate inserted between p. 1076 & p. 1077] – previously published as [Beyhom, 2012, p. 72, Fig. 13].

²¹¹ [1864, p. 14–15].

²¹² I use in the following figures the standard contemporary names of the *burdāt* and *ʿarabāt*. Note that the division of al-Ḥijāzī is fully expounded in the first part of [Beyhom, 2012].

²¹³ [Collectif, 1933; 1934; Hassan, 1990; Moussali, 2015] – see also the very complete [Vigreux and Hassan, 1992].

²¹⁴ [Erlanger, 1930]: let us here note that, while most – if not all – autochthonous theoreticians of the beginning of the 20th century

Shihāb-a-d-Dīn also explains²¹¹ how the names of the main degrees of the scale evolved and became the ones shown in the figure.²¹²

The quarter-tone based octave division was soon to be adopted – in the 24 quarter-tones per octave version – together with the use of a Western notation with adapted accidentals for Arabian music in the famous – or infamous? – *Congrès du Caire* of 1932²¹³ (Fig. 30).

It was also used in the equally well-known series of books on Arabian music by the team of Rodolphe (d’) Erlanger (Fig. 33: 172 and FHT 22: 219).²¹⁴

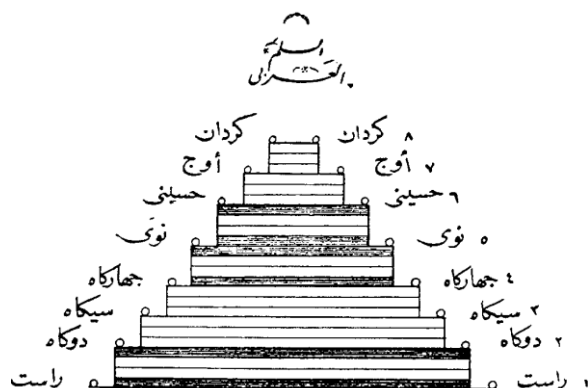

Fig. 28 The scale of “Arabian” [*maqām Rāst*] music according to Kāmil al-Khula’ī with whole-tone and three-quarter-tones intervals.²¹⁵

Finally, scale notation in the quarter-tone theory uses concurrently a numeric – intervallic – notation in multiples of the quarter-tone (FHT 14: 214), still in use today for theoretical purposes (Fig. 31 and Fig. 32, FHT 9: 212, FHT 15: 215, FHT 17: 216 and FHT 16: 215)²¹⁶.

(and beyond) were aware that their “quarter-tones” were not equal, this belief is today firmly rooted in the layman’s thought, if not with conservatoire students and composers of Arabian popular songs.

²¹⁵ As shown in [Khula’ī (al-), 1904, p. 29]. Degrees from bottom upwards: *RĀST DŪKĀ SĪKĀ JAHĀRKĀ NAWĀ ḤUSAYNĪ AWJ KARDĀN*; three-quarter-tones intervals in white (three stripes), whole-tone intervals with two white central stripes and two black bordering ones.

²¹⁶ See also [Beyhom, 2017].

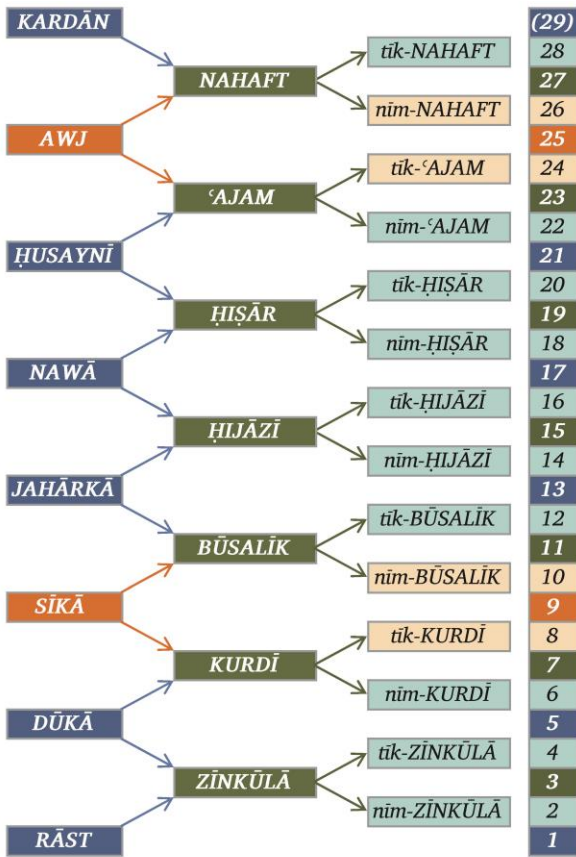

$7 \text{ burdāt} + 7 \text{ arabāt} + 7 \text{ tikāt} + 7 \text{ nīmāt} = 28 \text{ "quarters"}$

Fig. 29 The 28 “quarter-tones” (“maqāmāt” = pl. of maqām) of Shihāb-a-d-Din divided into *burdāt*, *arabāt*, *tikāt* and *nīmāt*.²¹⁷

المحجر المصنوع (زارني باهي الحيا) موشحة مقام هزام

El Mouhaggar El moussadar
(Zarāni bahil mouhaya) Mouwachaha maqam Huzam 28/4

• = 69

زا را ني لازمه
za ra ni

Fig. 30 Beginning of a *muwashshah* in mode *Huzam* as noted in the Conference proceedings of the *Congrès du Caire* of 1932.²¹⁸

²¹⁷ The *burdāt* (s. *burda*) are the main degrees of the scale (left); the *arabāt* (s. *araba* – main intermediate degrees between the *burdāt*) figure on a dark green background (middle), the *tikāt* (s. *tik*) and the *nīmāt* (s. *nīm* – intermediate degrees between the *burdāt* and the *arabāt* – the *tik* raises the degree, the *nīm* lowers it) on light green-blue and green-orange backgrounds. The result is a scale divided in 28 conceptually equal “quarters” (column to the right), while in the contemporary theories of *maqām* the degrees with orange background (*SĪKĀ* and *AWJ*) delineate two (upper and lower) three-

HIGAZ / RAST									
2	6	2	4	4	3	3			
6	2	4	4	3	3	2			
2	4	4	3	3	2	6			
4	4	3	3	2	6	2			
4	3	3	2	6	2	4			
3	3	2	6	2	4	4	Re	SABA	
3	2	6	2	4	4	3			
RAST / RAST									
4	3	3	4	4	3	3	Do	RAST	
3	3	4	4	3	3	4	Re	HUSSEINI	
3	4	4	3	3	4	3	Mb ^b	SĪKĀ	
4	4	3	3	4	3	3	Fa	GIHARKA	
4	3	3	4	3	3	4	So	YEKAH	
3	3	4	3	3	4	4	La	H OSHAIRAN	
3	4	3	3	4	4	3	Tb ^b	IRAQ	

Fig. 31 Detail from FHT 15: 215 showing the *hijāz/rāst* and the *rāst/rāst* matrices in Faṭḥī Sālīh’s intervallic investigation of the combination of “Arabian” tetrachords.²¹⁹

1 ^{er} degré	1 ^{er} int.	2 ^e degré	2 ^e int.	3 ^e degré	3 ^e int.	4 ^e degré
si ^{db}	→ 1	si	→ 8	ré [#]	→ 1	mi ^{db}
si ^{db}	→ 1	si	→ 8	ré [#]	→ 1	mi ^{db}
si ⁻	→ 1	si	→ 5	ré ⁺	→ 1	mi ⁻
si ^b	→ 1	si	→ 5	ré [#]	→ 1	mi ^b

"Enharmonique" si^{db}

Erlanger (quarts)

Quarts (conceptuels)

Conceptuel 17^{es}

Notation simplifiée 17^{es}

Fig. 32 Detail from FHT 17: 216 turned 90° counter-clockwise and showing intervallic equivalences and literal notations for the enharmonic *genos* on B^{bf} in Erlanger’s formulation (1st row), in the author’s proposition in quarter-tones (2nd row – no formulation for this *genos*) and in 17^{ths} of the octave (3rd and 4th rows).²²⁰

quarter-tones intervals. (Figure previously published as [Beyhom, 2012, p. 68, Fig. 4].)

²¹⁸ [Collectif, 1934, p. 417]. Note the key signature using both half-flat (with an oblique crossing dash) for the *b* and a sharp sign for the *f*.

²¹⁹ Numerals represent multiples of the quarter-tone.

²²⁰ Author’s habilitation thesis [Beyhom, 2010b, p. 127, Plate no. 10].

*Westernized scores*²²¹

There are two main subdivisions in the western notations of *maqām* music, which are the use of unmodified notation (with the usual # and b accidentals) or of the modified notation (with adapted accidentals). I shall not explore the first subdivision²²² as it is a pure Orientalist tool of musicology and cannot apply to *maqām* music.

Adapted western notations may be divided in two subdivisions further: the “simplified notation” of Arabian (Fig. 33 – FHT 25: 221 to FHT 30: 226) and Persian (Fig. 34 and Fig. 35) musics, and the “complex” notation of post-Ottoman Turkey.



Fig. 33 An example of *taqsim* (improvisation – traditionally performed as a prelude to the song or music) in *maqām Arḍibār* by the team of Erlanger.²²³ (Here a “transnotation” in [Erlanger, and Kriaa, 2018, v. 5, p. 269].)

²²¹ Some paragraphs in this section are translated and adapted from [Beyhom, 2003a] and [Beyhom, 2014].

²²² Mostly because such notations were adaptations for the piano – see [Pasler, 2012]. Note that standard western notation has been used by both Orientalist and autochthonous theoreticians to describe *maqām* music. In the case of the latter (mostly), implicit alterations of the *e* (= *e*) and the *b* (= *b*) – in the Arabian scale – are assumed. (Compare with the standardized notation of Scottish bagpipes, the scale of which is also incompatible with such notation – see for example [Allan, 1940].)

²²³ [Erlanger, 1949, v. 5, p. 257].

In the first notations only two supplementary accidentals are used for raising or lowering the pitch by one quarter-tone interval (Fig. 30 and Fig. 33 for Arabian music, Fig. 34 and Fig. 35 for Iranian music). These are based on the adaptation of the autochthonous scales to the Western scale by using a “half” of the semi-tone, resulting in a 24 quarter-tones octave.²²⁴



Fig. 34 Westernized notation of the scales of Iranian music using the *koron* (inverted flat sign for a quarter-tone lowering of the pitch) with corresponding key signatures.²²⁵



Fig. 35 *Darāmad of Dashti* according to the *radif* of Borumand in westernized notation using the *koron*.²²⁶

The Turkish adaptation of western notation uses more complex accidentals. Although based on Pythagorean justifications (Fig. 38) and on a division in Holderian commas²²⁷, it is in fact based on a division in twice

²²⁴ Eventually, and with the near-disappearance of aural tradition (notably after the disappearance of the founders of these “new” theories and the gap in aural transmission that followed – see [Beyhom, 2016a]), most aficionados – if not conservatoire musicians – of *maqām* music came to believe that the “quarter-tones” were exact (equal), and that *maqām* music effectively used “quarter-tones”.

²²⁵ [During, 1984, p. 105] – Courtesy of the author.

²²⁶ [During, 1984, p. 112] – Courtesy of the author.

²²⁷ 9 (Holderian – also called Mercatorian) commas – not italicized to differentiate them from Pythagorean and other Ancient Greek

the intervals of the Western 12-ET octave (24 intervals – see FHT 38: 229) as will be expounded farther, but these intervals are conceived as unequal.

Figure 36 shows the notation and key signatures of the main scales of Arabian maqām(s) according to Jabaqī, concurrently with their intervallic formulation in multiples of the quarter-tone. The image displays eight staves of music, each representing a different scale. The notes are written on a five-line staff, and the intervals between them are indicated by numbers in circles below the notes. The scales are: 1) Rast (C major), 2) Yegah (C major with a raised 4th), 3) Zangeneh (C major with a raised 3rd), 4) Segah (C major with a lowered 3rd), 5) Shushtar (C major with a lowered 4th), 6) Nahavand (C major with a lowered 6th), 7) Bayati (C major with a lowered 7th), and 8) Hicaz (C major with a lowered 7th and a raised 4th).

Fig. 36 Notation and key signatures of the main scales of Arabian maqām(s) according to Jabaqī, concurrently with their intervallic formulation in multiples of the quarter-tone.²²⁸

<i>Les dièses</i>			
N°1	N°2	N°3	N°4
♯	♯	♯	♯
<i>Les bémols</i>			
N°1	N°2	N°3	N°4
♭	♭	♭	♭

Fig. 37 Turkish accidentals as in [Yekta, 1922, p. 2986].²²⁹

The desire, common to most – if not all – autochthonous theoreticians, to reconcile western notation and maqām tradition(s) led to deep misunderstandings in the autochthonous formulations and raised problems which are still not solved today.

comma(s) – make up one whole tone, 4 one semi-tone (*leimma*), 53 in all in the octave – see [Holder and Keller, 1731].

²²⁸ [Jabaqī, sd., p. 28].

²²⁹ The n°1 sharp sign (“dièse”) raises the pitch by 524288/531441 (one Pythagorean comma ≈ 24 cents), n°2 by 243/256 (*leimma* ≈ 90 c), n°3 (dotted) by 2048/2187 (*apotome* ≈ 114 c), n°4 (two dots) by 59049/65536 (“minor tone” or *di-leimma* ≈ 180 c). The n°1 flat sign (flattened) lowers by one Pythagorean comma ≈ 24 c, n°2 (plain flat sign) has an approximate ratio 24/25 (equivalent to a

re	mi	fa#	sol	la	si	do	re
8/9	9/10	15/16	8/9	9/10	15/16	8/9	
1	9/8	5/4	4/3	3/2	5/4	10/9	2
re	mi	fa#	sol	la	si	du	ra
8/9	59019/65536	2018/2187	8/9	59019/65536	2018/2187	8/9	
1	9/8	8192/6501	4/3	3/2	32768/19683	10/9	2

Fig. 38 Simplified Turkish scale according to [Yekta, 1922, p. 2986]: Above → “approximate” ratios ; Below → “exact” (Pythagorean) ratios.

THE *TİK-NİM* MISUNDERSTANDING

The Arabs inherited a music theory which was established in the Ottoman Court, and was applied to a highly refined repertoire.

The concept of accidentals in the Ottoman – then Turkish – theories of the scale included a raising (sharp) term for the intermediate notes²³⁰ between the main pitches (the ‘*arabāt* in Fig. 29) – the “*tik*” – and a lowering term for the same degrees – the *nīm*.²³¹

One of the main problems in teaching score notation adapted to maqām music arises from this *tik-nīm* terminology. Fig. 39 shows the two-octavial notation of the scale by Lebanese author, theoretician and ‘ūd player Salīm (al-) Hīlū.

Figure 39 shows the complete scale of the main octave of Arabian music according to [Hīlū (al-), 1972, p. 68]. The notation is on a five-line staff with a key signature of one sharp (F#). The notes are labeled with Arabic terms: رست (Rast), دوگاه (Dugah), بوسلیک (Boslik), حجاز (Hicaz), حصار (Hisar), حصار (Hisar), حصار (Hisar), حصار (Hisar), حصار (Hisar), حصار (Hisar), حصار (Hisar), حصار (Hisar). The notes are grouped into four sets of three notes each, with the first set being Rast, mi, fa# and the others being variations of the scale.

Fig. 39 Complete scale of the main octave of Arabian music according to [Hīlū (al-), 1972, p. 68].

The detail proposed in Fig. 40 features a *tik-HIṢĀR* (*α^{half-flat}*) – which is a *HIṢĀR* (g#) raised by a quarter-tone: its accidental is a “half-flat” sign.

17th of the octave ≈ 71 c), n°3 → *leimma*, ≈ 90 c, n°4 (with a stricken off stem) → *apotome* ≈ 114 c.

²³⁰ It is the interval which is, in fact, made greater – or lesser in the case of the *nīm*. However, whenever one interval in the scale is made lesser, the adjacent interval is automatically made greater: this is but one of the semantic pitfalls in the complex Arabian-Ottoman-Turkish-Persian-Iranian music theories and scales, not speaking of the Byzantine ones.

²³¹ See Fig. 37, FHT 32: 227 and FHT 37: 229.

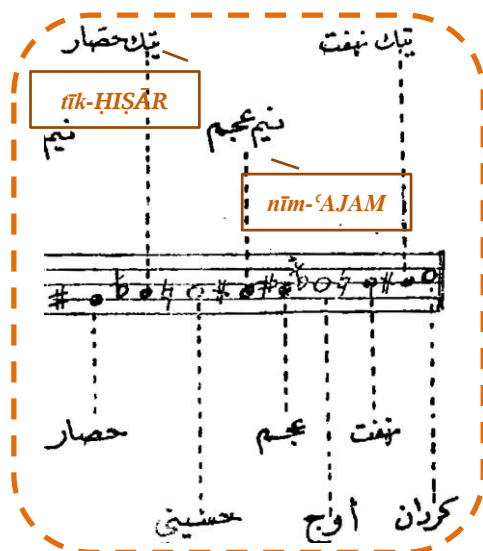

Fig. 40 Detail from the scale of the main octave of Arabian music according to Ḥilū (see previous figure) showing the contradiction with the *tik-nim* usage in “modern” theories of the scale. Here, *tik-Ḥiṣār* ($\alpha^{half-flat}$) is a *Ḥiṣār* (g^\sharp) raised by a quarter-tone: its accidental is a “half-flat” sign. The mirrored *nim-ʿAjām* ($\alpha^{half-sharp}$) is a *ʿAjām* (b^\flat) lowered by one quarter-tone: its accidental is a “half-sharp” sign.

The same applies to the degree *nim-ʿAjām* ($\alpha^{half-sharp}$) which is a *ʿAjām* (b^\flat) lowered by one quarter-tone: its accidental is a “half-sharp” sign.

Needless to say, students in the conservatoires have always had problems understanding these contradictory concepts, which is one of the cons of Western notation applied to *maqām* music.²³² The moreover when “innovative” Arabian theoreticians improvise arbitrary tetrachordal constructions of the scales with “disjunctive” tones of which nearly none is equal to a whole tone (FHT 30: 226).

THE PROBLEM OF THE KEY SIGNATURE(S)

In their desire to mimic the West *and*, strangely enough, to retain their traditional music, Arabian theoreticians could not avoid a(nother) formidable pitfall: the key signatures of their numerous scales and modes. The use of “adapted” key signatures leads to sometimes

considerable inconsistencies as between the key signatures of *maqām Huzām* by the theoreticians of the *Congrès du Caire* (Fig. 30 – and Fig. 44: 175 with no key signature at all) and by further subsequent theoreticians such as the Syrian Shirzād ‘Amr²³³ (Fig. 41, central row – bottom) or the Lebanese Salīm al-Ḥilū (Fig. 42 and Fig. 43 – and a notated example in FHT 24: 220) whose two versions are not even consistent one with another.

With the key signatures of Western music based on the cycle of fifths and Pythagorean theory, their introduction in the westernized notation of *maqām* music imposed this theory as the inevitable reference for all and every Arab theorist, who had to adapt their scales for such use. One simple modification was – as seen above – the use of “half-flat” signs instead of “flat” signs²³⁴ (Fig. 41 to Fig. 43).

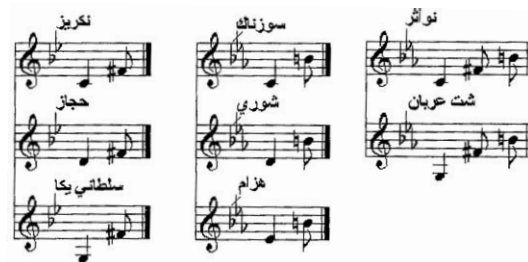

Fig. 41 Key signatures and “dissenting” notes of the Arabian modes.²³⁵

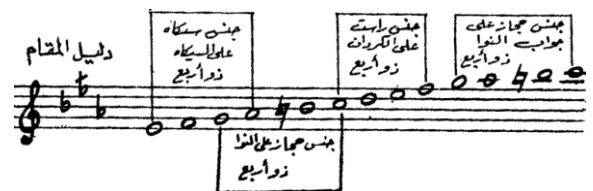

Fig. 42 Scale of *maqām Huzām* by al-Ḥilū (1).²³⁶

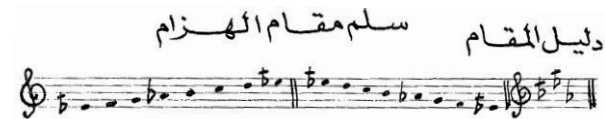

Fig. 43 Scale of *maqām Huzām* by al-Ḥilū (2).²³⁷

²³² Evidently, all traditional terminology could be avoided for conservatoire students – who will very probably then even more believe that the quarter-tone alterations do apply exactly to the degrees of the scale: all *maqām* musicologists are aware that this is not the case, but...

²³³ Having, however, a Persian forename – see [Anon. “First name Shirzad - NamepediA”].

²³⁴ And of “half-sharp” signs instead of “sharp” signs – mostly however in Turkish – or Turkish-influenced – notations.

²³⁵ [ʿAmr, 2000, p. 89]. Left row (top to bottom): modes *Nakriz*, *Ḥijāz* and *Sulṭānī-Yākā*. Central row: modes *Sūzānāk*, *Shūrī* and *Huzām*. To the right: modes *Nawā-Athar* and *Shatt-ʿArabīn*.

²³⁶ [Ḥilū (al-), 1972, p. 132].

²³⁷ [Ḥilū (al-), 1980, p. 175].

The complete inadequacy of the theory of the cycle of fifths applied to *maqām* scales appears in all its glory in one further example of key signature for the “poly-chord *mukhālīf*” by Iraqi Thāmir ‘Abd-al-Ḥasan al-Āmirī (Fig. 45) in which he uses 3 “natural” signs to neutralize implicit flattening of notes (would the scale have followed the cycle of fifths construction scheme).²³⁸

Maqām Huzām

سبكه (ذو الثلاث) على السبكه Sigah Zussalace (tierce) sur le Sigah	جنس حجاز (ذو الخمس) على النوا Genre Hijaz Zul Khams (quin*) sur le Nawa	سبكه (ذو الثلاث) على السبكه Sigah Zussalace (tierce) sur le Djawab Sigah
--	--	---

جنس راست (ذو الخمس) على السكران
 Genre Rast 'Zu khams (quin*) sur le Kirdane

Fig. 44 Detail from the notation of *maqām Huzām* in the proceedings of the *Congrès du Caire* of 1932.²³⁹

عقد المخالف الخماسي على درجة النواج
 كردان
 سبكه
 حجاز
 نوا
 حصار
 كردان

Fig. 45 Notation of the “*uqd*” (pentachordal polychord) *mukhālīf* according to ‘Āmirī.²⁴⁰

FEW OTHER PROBLEMS RAISED BY THE USE OF WESTERN NOTATION FOR MAQĀM MUSIC

Most problems of notation derive, however, from the (un-) precision of Western notation and from the desire of autochthonous theoreticians, on one side, to have more precise signs for accidentals and, on the other side, to avoid the exclusive use of “exact” quarter-tones (Fig. 46, Fig. 47 and Fig. 49) – which would undermine traditional *maqām* music.

²³⁸ See also the key signature in Fig. 48 in which ‘Abbās uses one “natural” sign in the key signature and a # sign between brackets for *maqām Nawā-Athar*.

²³⁹ [Collectif, 1934, p. 528].

²⁴⁰ [‘Āmirī (al-), 1987, p. 169].

²⁴¹ [Mahdi (al-), 1982, p. 18].

للرفع 20 % نسبة 30 % نسبة 40 % نسبة	للخفض 20 % نسبة 30 % نسبة 40 % نسبة
--	--

Fig. 46 Accidentals used by Mahdi.²⁴¹

سبكه (ذو الثلاث) على السبكه
 كردان
 حجاز
 حصار
 كردان

Fig. 47 Scale of *maqām Šabā*, using Western modified notation in quarter-tones concurrently with interval values in HC.²⁴²

سبكه (ذو الثلاث) على السبكه
 كردان
 حجاز
 حصار
 كردان

Fig. 48 The same author as in Fig. 47 uses Western modified notation in quarter-tones concurrently with interval values in HC, with a key signature comprising one “natural” sign and a # sign between brackets for *maqām Nawā-Athar*.²⁴³

Do	Re	Mi (♯)	Mi	Fa	Sol
Comma [-----↑-----↑-----↑-----↑-----↑-----↑-----↑-----↑-----↑-----]					
Sol	La	Si (♯)	Si	Do	
Comma [-----↑-----↑-----↑-----↑-----↑-----↑-----↑-----↑-----↑-----]					

Fig. 49 Positioning of the “quarter-tones” for *maqām Rāst* according to (al-) Bāshā – Based on HC.²⁴⁴

These attempts remained however inconclusive whatever refinement the accidentals could achieve – as with Chabrier (Fig. 50 and FHT 23: 220) – which brings us (back) to the Ottoman (Turkish) notations in the 20th century and to the headlong rush for more precision in notation.

Fig. 50 Accidentals used by Chabrier, based on a combined Holderian comma and equal-temperament division of the whole tone.²⁴⁵

²⁴² “HC” stands for “Holderian comma” – [العيلس and ‘Abbās (al-), 1986, p. 101]. From left to right intervals of 6 7 5 13 4 9 9 commas.

²⁴³ [العيلس and ‘Abbās (al-), 1986, p. 110]. From left to right intervals of 6 7 5 13 4 9 9 commas.

²⁴⁴ [Bacha, s.d. (199x), p. 1].

²⁴⁵ [Chabrier, 1995, p. 67].

*
* *

As a conclusion to this section, let us remind that, not far from Greece and still within the Ottoman Empire, Mikhā'īl Mashāqa's²⁴⁶ comparative approach had no possibility of establishing a connection between two theoretical systems one of which – the Byzantine – was still embedded in the “Oriental” practice formalized, notably and in the 13th century, by Ṣafīyy-a-d-Dīn al-Urmawī while the second – the so-called “Arabian” theory of the “quarter-tone” – was already inspired by the Western theoretical system, if not artificially created by its promoters such as Bourgault-Ducoudray for Byzantine chant²⁴⁷. As seen above, the contents of Mashāqa's treatise were implemented a few decades later in the theory – and maybe in the practice – of Arabian *maqām* music notably, at the turn of the 19th-20th centuries, with the book of the musician and theoretician Kāmil al-Khula'ī in Egypt.

It may well be that the mere existence of a simplified diastematic notation for Byzantine chant²⁴⁸ towards the beginnings of the 19th century helped preserving this chant longer than Arabian – notably Urban – music, the Arabian society having failed in producing a theoretician such as Chrysanthos Madytos who would have paved the way for an endogenous modernization of Arabian *maqām* theory.

THE TURKISH NOTATION SYSTEM²⁴⁹

At the dawn of the 19th century the 17-intervals per octave system of Ṣafīyy-a-d-Dīn al-Urmawī was slowly

becoming inadequate both quantitatively and structurally. Urmawī's scale could not describe the exact intervals of Ottoman music at a time when the comparison with Western music – in which the octave division is structurally different – was demoting it to an accident of history.

Urmawī's system was not conceived for a *description* of the intervals, but for the *identification* of those intervals.²⁵⁰ It was also conceived as a *zalzalian*²⁵¹ system, based on “neutral” seconds that Ṣafīyy-a-d-Dīn called *mujannab(s)*.²⁵²

*
* *

Contemporary Turkish theories of the scale are influenced by Rauf Yekta Bey's theories in the *Encyclopédie du Conservatoire*.²⁵³ Further developments by Suphi Ezgi and Sadettin Arel²⁵⁴ led to what became the “Yekta-Ezgi-Arel” theory taught notably in Turkish conservatoires.²⁵⁵

Yekta's General scale of Turkish music (FHT 31 and FHT 32: 227) is transposed a fifth higher to fit it in a staff in treble clef. As for all Ottoman theories of the scale, it is inspired by Ṣafīyy-a-d-Dīn al-Urmawī's Pythagorean division of the octave.

Urmawī's theory is based on an unequal division of the octave in 17 intervals (FHT 33: 227) in a Pythagorean formulation.

The essence of Urmawī's scale is, however, *qualitative* as his intervals have an identifying function before all (the measure of the interval is only indicative of its

²⁴⁶ Mikhā'īl Mashāqa was an offspring of Greek immigrants in what are today called Lebanon and Syria, or the Bilād a-sh-Shām of the Ottoman Empire. He was an ophthalmologist, a historian and a theoretician of Arabian music – see more in the first chapter of [Beyhom, 2015].

²⁴⁷ See [Beyhom, 2015; 2016a].

²⁴⁸ Apart from Byzantine chant being a religious chant, which generally leads to a better conservation of its characteristics with time.

²⁴⁹ This section is partly translated from [Beyhom, 2014].

²⁵⁰ See [Beyhom, 2018ap].

²⁵¹ The *Zalzalian system* is the main *maqām* system based on the scale of *maqām Rāst*.

²⁵² It is worth reminding here that many systems for the division of the octave have co-existed in the countries or regions of *maqām* music, from the trivial division in 7 intervals to the divisions in 14, 17, 21 (probably) and also 28 intervals – not forgetting the 22-*śruti* division of Indian music. More refined divisions include the 53-commas Turkish system with the 68 and 72-*moria* systems of Byzantine chant. All these systems have theoretical foundations that make

them legitimate, and all should be looked at closely for a better understanding of how autochthonous theoreticians have tried to explain – and sometimes to teach – their music.

²⁵³ [Yekta, 1922]. Yekta Bey also published numerous articles in Turkish – see [Borrel, 1935; Wikipedia Contributors, 2014] – as well as the seminal [Yekta, 1924] – republished as [Yekta, 1986].

²⁵⁴ [Signell, 1977]. This original Ph.D. thesis was further published as [Signell, 1986; 2004; 2008].

²⁵⁵ The main references for this section remain Signell's book with an abundant bibliography in [Signell, 2004, p. 188 sq.] as well as Yekta's article [Yekta, 1922] – Other useful reference are [Feldman, 1996], [Signell, 2001], and [Borrel, 1922; 1923a; 1923b]. Alternate or complementary contributions to the Yekta-Ezgi-Arel theory include [Karadeniz, 1965] and [Karadeniz, 1983] – “Hardly known in Turkey” according to [Signell, 2004, p. 191] and an “obscure writer” in note n° 8 of [Signell, 2004, p. 37] – or the developments by [Tura, 1988], not to forget contributions by young authors such as [Yarman, 2008a; 2008b].

function in the scale).²⁵⁶ It is radically different from the Pythagorean scale in its conception (FHT 33: 227) as it follows an *additive* concept (Fig. 51 – Right) – and not imbricated for the sharp and flat accidentals as with Pythagorean theory as implemented by Western music theorists (Fig. 51 – Left).²⁵⁷

This is even more apparent with Fig. 52, which reproduces the effect of accidentals in the case of a *L C L* tone for Urmawī, in which d^{flat} would be equivalent to $c^{\#}$ in the Pythagorean system (Fig. 51 – Left), and *vice versa*.

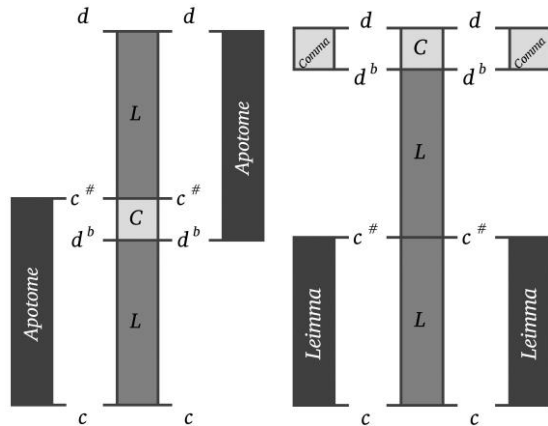

Fig. 51 To the left: Accidentals in Pythagorean theories adapted to the Common practice scale of western music are divisive: intervals $c_c c^{\#}$ and $d d^{\flat}$ intersect. To the right: Conjunct intervals and consecutive action of the accidentals with Urmawī: intervals $c_c c^{\#}$ and $d d^{\flat}$ are independent from one another, and separated by $c^{\#} d^{\flat}$ which is one *leimma*.²⁵⁸

In modern terms, altering an interval²⁵⁹ is different from altering a note of the scale. Whenever altering an interval means adding or removing a measuring (or small conceptual) interval from it, altering a note in western – Pythagorean based – theories is a divisive concept,²⁶⁰ from which we deduce that d^{flat} is one *comma* lower than $c^{\#}$, whenever an “augmented” b_c interval

²⁵⁶ See [Beyhom, 2018ap] for more details on the different functions of intervals in *maqām* music.

²⁵⁷ This reasoning, which is essential for the understanding of the modifications of the scale in Ottoman-Turkish theories, is taken from [Beyhom, 2017, p. 27 sq.].

²⁵⁸ Adapted and translated from Fig. 16-17: 115 in [Beyhom, 2014]; *L* stands for *leimma*, *C* for *comma*, both Pythagorean. Previously published as separate figures in [Beyhom, 2018ap, p. 28].

²⁵⁹ A common characteristic in “Oriental” theories of the scale, including Byzantine chant – see [Azar Beyhom, 2012] for the explanations of Mikhā’il Mashāqa (who compares the “Arabian scale”, according to him, with Chrysanthos Madytos’ scale) about Arabian modes in the first half of the 19th century, and [Beyhom, 2015] for

(or $b_c c^{\#}$ – or its equivalent) with Urmawī will always be below the “diminished” $c_c d$ interval (or $c^{\#} d$).²⁶¹

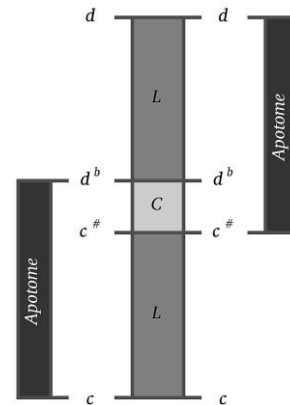

Fig. 52 Alternate formulation (*L C L*) of Urmawī's tone and accidentals.

Furthermore, and in addition to being a *linear* theory of the scale, Urmawī's theory encloses three successive levels of conceptualization, namely the structuring of the octave in (Just) fourths and disjunctive tones, the division of the fourth in three *emelic* intervals (of second) *and* the division of the tone in three further intervals (Fig. 53, and FHT 33: 227).

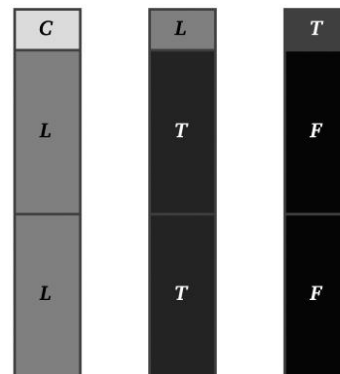

Fig. 53 Similar concepts by Urmawī for the construction of the tone (left), the fourth (center) and the octave (right).²⁶²

more explanations on the alterations in Byzantine theories of the scale (19th to 21st centuries).

²⁶⁰ Intervals $c_c c^{\#}$ and $d d^{\flat}$ intersect – see Fig. 50.

²⁶¹ This can also be understood as a consecutive action of the accidentals: intervals $c_c c^{\#}$ and $d d^{\flat}$ are independent from one another, and separated by $c^{\#} d^{\flat}$ which is one *leimma* – see Fig. 51. (One *comma* in Fig. 52.)

²⁶² Previously published in [Beyhom, 2018ap, p. 29]. Note that while the tone might take a different form from the one shown in the figure – for example *L C L* as in Fig. 52 – in Systematist literature, it is always composed of three *elementary* intervals, which are always two *leimmata* and one *comma*. (Note also that some formulations of the tone may deviate from this norm – see for example

These *emelic* intervals – the whole tone composed of three elementary intervals and the two *mujannab(s)* composed of two elementary intervals²⁶³ or the *baqiyya (leimma)* – lie at the heart of misunderstandings which cripple today’s theories of the scale in *maqām* music. The main reason for these misunderstandings is that Urmawī’s theory was incorrectly assimilated by his successors and was transformed in a practical canon which determined a profound change of the intervals used in Ottoman music.²⁶⁴

The decline of the Ottoman Empire and the evolution of the balance of power in the 19th and 20th centuries precipitated the foundation of the main alternate (*maqām*) theory of the 20th century, the Yekta-Ezgi-Arel theory cited above.

* * *

While closely based on Urmawī’s Pythagorean division – extended to 24 intervals – Yekta’s “General scale” (FHT 31 and FHT 32: 227) uses, besides the usual *leimma* and *comma* intervals (Fig. 38: 173), an accidental in superparticular ratio 24/25 (Fig. 37: 173) which allows for *zalzalian* intervals to become part of the scale. This is the closest possible (simple) approximation of the 17th of the octave²⁶⁵ and a possible indication that this author wished to avoid a practical drift from traditional performance to the theoretical – Pythagorean – values in his scale.

The extension of the number of intervals and the refinement of the accidentals became necessary because – notably – of the growing use of transposition in Ottoman

music.²⁶⁶ It was also dictated by the necessity – as with the 2nd Byzantine Reform of the 19th century – to reconcile Turkish (Urmawī’s) theories with both Western theory, and with Arabian (?) theories of the quarter-tone which are based on it. Yekta’s formulation, however, and due to his conflicting desires of retaining Pythagorean theory – a pre-eminent currency of prestige with Western musicologists – and of preserving the traditional characteristics of Ottoman-Turkish music, led to deep misunderstandings. (Fig. 54 and corresponding footnote)

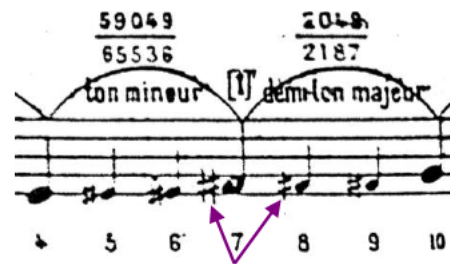

Fig. 54 One misunderstanding in the notation of Yekta Bey.²⁶⁷

This is the probable cause why his successors waived some of Yekta’s refinements in favor of a more straightforward formulation of the scale division (FHT 37: 229 and FHT 38: 229).

However, and while Yekta’s notation retains much of the characteristics of the original *zalzalian* scale of *maqām* music,²⁶⁸ the Ezgi-Arel notation system consecrated the rapprochement of Turkish and Western music. This notation, while using a Pythagorean form, imposes in fact an arithmetic system of notation based

[Schulter, 2013], notably fn. 40, with a possible interpretation of a Systematist “tone” with ratio 8:7.)

²⁶³ The two *mujannab(s)* in Urmawī’s theory are equivalent conceptually. They are identified through their internal composition – this means that they are composed of two elementary intervals, two *leimmata* or one *leimma* + one *comma*.

²⁶⁴ See [Feldman, 1996] and [Olley, 2012].

²⁶⁵ (25/24)¹⁷ (the ratio of 25 over 24 to the power 17 – or 17 intervals in a row) = 2,001654134 which is 1,43 c greater than the octave (= 2).

²⁶⁶ For example [Hilü (al-), 1972, p. 96]: “Transposition was not in use among the Arabs – it is a Turkish invention [in *maqām* music]”. (See also [Beyhom, 2014, p. 100].)

²⁶⁷ Detail from FHT 31: 226 (see Fig. 37: 173 for the accidentals. The altered *f* degrees following *f#* are “lower” than this degree according to the code of accidentals provided by Yekta in Fig. 37. This “error” can only be explained by reminding that Yekta’s notation is transposed to the (upper) fifth of Western notation. The degrees of the General scale of Yekta (FHT 31: 226) must then be read *g a b c*

d e f g₂ instead of *d e f g a b c d₂*. This means that *f#* in this scale is equivalent to *b^{-1c}* (*b - 1 comma*), as *f* in Yekta’s scale is equivalent to *b^b* – in fact “*b - 1 apotome*”. In this case, the “Main” scale of Yekta (delineated by the upper ratios and circle segments) is to be understood as *g a b^{-1c} c d e^{-1c} f g₂* instead of *d e f# g a b c*. Knowing that *b^{-1c}* and *e^{-1c}* in the Turkish scale correspond to *e^{fl}* (*e* “half-flat” – or *e* lowered by a quarter-tone) and *b^{fl}* in Arabian *maqām* theories of the scale, Yekta’s General scale becomes thus equivalent to the Arabian scale of mode *Yākā* – on (equivalent Western) *g* with *e^{fl}* and *b^{fl}* (*b* and *f#* with Yekta). While this means that implicit one-comma accidentals are included – for these two degrees – in Yekta’s scale, the author explains notably, in a footnote (see [Yekta, 1922, p. 2997]): “This *f#*, as well as all the others that we shall use in our transcriptions, are at an interval of one *leimma* 243/256 from *f* [‘natural’], [...] Whenever the *f#* is at an interval of one *apotome* 2048/2187 from *f^{natural}*, we shall use a sharp sign topped by a dot”.

²⁶⁸ These – be they implicit or explicit – are detailed in [Beyhom, 2014]: see also [Signell, 2004, p. 22–26].

on the Holderian comma (FHT 37). Furthermore, the inclusion in the scale of structural intervals of 3 commas (FHT 38) restores the notation to its symmetrical status²⁶⁹ – compatible with Western theories of the scale as with the “Arabian” quarter-tone division.

Consequently, the resulting “Turkish” scale is structurally equivalent to the “Arabian” quarter-tone division while retaining the possibility of a finer description of the intervals which compose it.²⁷⁰

The intrinsic asymmetry of the *zalzalian* scale with an unequal division of the octave in 17 intervals²⁷¹ leads however to misunderstandings – such as seen above for *Yekta* – and discrepancies, notably for transpositions of scales and tetrachords.

PROBLEMS OF TRANSPOSITION IN THE ASYMMETRIC FORMULATIONS OF MAQĀM SCALES

The *zalzalian*- “medium” (“neutral”) – seconds of Urmawī or *mujannab*(s) bear two formulations (Fig. 55).

The difference between the two *zalzalian* seconds, *i.e.*, the difference between two *leimmata* and one *leimma* plus one *comma*, is about 67 cents, almost three Pythagorean *commata*. As the General scale of Urmawī is asymmetric,²⁷² he is compelled to use two different theoretical formulations for some tetrachordal configurations – for example the *bayāt* tetrachord on *d* or *a* in FHT 34: 228.

Transposing this tetrachord on different degrees of the scale imposes also – for example in a transposition on *d*^{#273} – the inversion of the *mujannab*(s) to remain within the scope of the predefined division of the General scale.

Similar problems arise for the *hijāz* (“chromatic”) tetrachord in this scale (FHT 36: 228).

However, and while the internal differences between *mujannab*(s) may well mirror actual practice,²⁷⁴ the undifferentiated – and theoretical – use by Urmawī

of these two forms enforces the equivalence between them and minimizes the importance of the actual sizes of the intervals. In which case a 17th of the octave equal division of the octave, which has the advantage of allowing for all transpositions without theoretical modifications of the intervals (FHT 35: 228), would have been much more convenient for both musicians and theoreticians of *maqām* music.

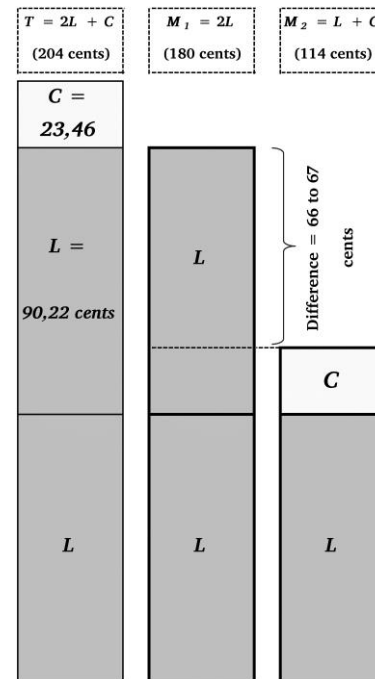

Fig. 55 Urmawī’s tone (left) and two expressions of the *mujannab* (center and right): *T*=tone, *M*=*mujannab*, *L*=*leimma* and *C*=*comma*.²⁷⁵

However, in such a division the whole tone as well as – but to a lesser extent – key intervals such as the just fourth and fifth would no more correspond to the sacrosanct Pythagorean values,²⁷⁶ and the concept of a theory which would merely structure – but not dictate – the

²⁶⁹ Because it is divided in an even number of intervals (24) which, the moreover, structurally correspond to the Arabian quarter-tone (theoretically) equal-division of the octave.

²⁷⁰ This could be debated, but would lead us to unnecessary – in this dossier – extended explanations. Note however that the differences between theoretical and practical values of the intervals of Turkish music are the subject of hot discussions among musicians and theoreticians, as explained throughout [Signell, 2004].

²⁷¹ The 17-intervals division of *maqām* music from its – known – origins is documented in [Beyhom, 2010c].

²⁷² *i.e.* not based on an equal – and even – division of the octave.

²⁷³ *d* + one *leimma* when using Urmawī’s additive conception.

²⁷⁴ See [Beyhom, 2018ap, p. 14, Fig. 5] for explanations on the problematic of the *mujannab*(s) in *maqām* music – see also [Beyhom, 2003b; 2004].

²⁷⁵ Previously published as [Beyhom, 2018ap, p. 11, Fig. 1].

²⁷⁶ Pythagoreanism has always been fashionable with Arabian theoreticians since Urmawī. Note that even al-Kindī (9th century) cheerfully propagated Pythagorean theories among the Arabs (as I explain in [Beyhom, 2010c]). Very few authors questioned Pythagorean absolute “truth” – but one of them was the greatest of all: al-Fārābī who is first cited in the epigraphs to this dossier.

intervals and music seems to be foreign to the thought of Modern *maqām* theoreticians.²⁷⁷

Anyhow, one conclusion that can be reached here is that Urmawi's scale is not strictly fit for transpositions. The extension of the number of intervals,²⁷⁸ whenever not based on an equal-division of the octave, brings no practical solution – as with the Yekta-Ezgi-Arel scale. (FHT 37: 229 to FHT 39: 230)²⁷⁹

In fine, the use of such theoretical intervals in a fixed temperament, while raising specific problems of transposition, rubbed off only very slowly on practice as, as late as in the 1970s, practice still didn't coincide with theory.²⁸⁰

Nevertheless, the Yekta-Ezgi-Arel theory is still taught today and considered as the base division of the Turkish scale, with specially programmed (standard) accidentals in dedicated music notation softwares (Fig. 56) which also allow for additional – non standardized – accidentals²⁸¹ and notations for which an example is provided – for Byzantine chant – in Fig. 57²⁸².

When comparing however the (theoretical and computerized) mechanical performance of this chant (see Fig. 87: 194 and Fig. 88: 194 – and the corresponding videos) with the actual performances by proven cantors proposed in the accompanying video-animations (in Part III), the overall conclusion for Western notations as

applied to *maqām* music is that all the refinements brought to it²⁸³ can still not describe the actual performed music and that these notations remain, in this aspect, mere caricatures of this music.

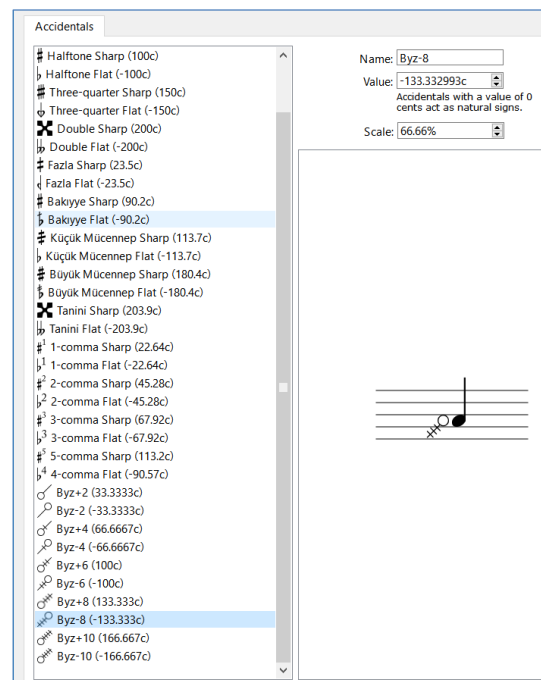

Fig. 56 Detail from a window snippet of the standard accidentals proposed in MUS2 (V 2.1) and the Byzantine accidentals implemented by the author (below – 2nd Reform), with the “Byz-8 (-133.333c)” accidental highlighted.²⁸⁴

²⁷⁷ Turkish musicologists have mostly been longing for a rapprochement with Western music on the base of temperament (as documented in [Signell, 2004]). A musical temperament being, by definition, a freeze – even temporary – of the intervals of the scale, “elastic” – even if theoretical – intervals were for these musicologists – and in particular for Yekta, Ezgi and Arel – simply absurd.

²⁷⁸ As with Karadeniz' 41-intervals per octave system mentioned in [Signell, 2004, p. 42]. Note that even with the “limited” Yekta-Ezgi-Arel theory, Signell reports – according to the explanations of Necdet Yaşar in the 1970s – that some of the *dik(s)* [the Arabian *tik(s)*] are not used in the classical Turkish repertoire, which confirms that theory and practice barely coincide in *maqām* music, a simple truth that I try to remind my readers of in most – if not all – of my writings.

²⁷⁹ [Signell, 2004, p. 41] notes the existence of a few “uncommon” *mujannab(s)* used in some modes such as a 6-comma *mujannab* for *Şabā* (Arabian transliteration), and other, 7-comma *mujannab(s)* – whenever the Turkish theoretical norm is an 8-comma *mujannab* (*di-leïmma*). Otherwise, further examples of transposition problems can be found in [Signell, 2004, p. 37–47].

²⁸⁰ Signell explores these discrepancies at length in the aforementioned reference, and notably – in [Signell, 2004, p. 38]: “Sometimes, the literal value of the accidentals can deviate at least one comma (23 cents) from common practice”. See also Slides nos. 16-17 in the accompanying Power Point show of [Beyhom, 2014] (reproduced as Slides nos. 7-8 in the current dossier), in which the

intervals of the *tunbūr* of Necdet Yaşar follow strictly the Yekta-Ezgi-Arel theory of the scale – with considerable refinements of tone-color, while Murat Aydemir's performance features intervallic variations. As I have expounded in [Beyhom, 2014], the aesthetics of Turkish music have constantly evolved between the traditional aesthetic – based on interval and rhythm variations – and the “Modern” – in fact Western – aesthetic of sound based on the variations and the mastery of tone-colors.

²⁸¹ Refinements of the scale divisions – based on various theoretical grounds – are something of a national sport in Turkey.

²⁸² Which is a detail of FHT 52: 240 – See also the notation of the First Byzantine Mode in FHT 40: 230.

²⁸³ Western notation evidently doesn't stop at the standardized version widely in use today, and has been further improved – notably for composition purposes (see for example the recent – however undated and in French – [Couprie et al.]). Its lacunae for the description of subtleties of *maqām* music persist, however, not speaking of the other problems raised in this and in the previous parts of this dossier.

²⁸⁴ Standard accidentals include equal-temperament (quarter-tone as a common denominator) accidentals together with the accidentals put forward in the Yekta-Ezgi-Arel theory, along with commatic (numbered) accidentals.

31
ran a- sing- ri- tos

36 7th mode
ti- in a- di- a-

41
Lo- go- on

45 8th mode
on- dos The-

Fig. 57 Detail from the transnotated score of *Axion Estin* by Anonymous (FHT 52: 240) with hybrid Western/Byzantine notation using both Byzantine key signatures and in-score Byzantine accidentals.

As for the *prescription* of this music, Western notations are, in what concerns traditional *maqām*, practically useless for prescribing it without actual, prior and aural knowledge of the tradition as will be shown in the third part of this dossier.²⁸⁵

*
* *

I would like, finally for this Second part, to remind of one statement used by Bruno Nettl as a conclusive argument for keeping Western notation as the main analytical tool of ethnomusicology:

“Western notation is being adopted by musical cultures throughout the world, modified to account for diversity, a reasonably adequate prescriptive system; this is leading to a kind of vindication of Western notation for purposes of transcription”.²⁸⁶

In addition to the profound contradiction which arises from the use of a “prescriptive” notation for description purposes, or even for analytical purposes for musics which it cannot help analyze, knowing that its

²⁸⁵ As Cem Behar explained in [Behar, 2014] – personal communication: “A mode does not exist because it is defined; it is the practice which defines it”.

²⁸⁶ [Nettl, 1983, p. 80].

²⁸⁷ Mostly [Meer and Rao, 2006] and the same with video-examples at [Meer, 2018b], together with [Rao and Meer]. Many other

use in autochthonous musics has, more often than not, led to profound changes in the performance of these musics should alone prevent ethnomusicologists from using it further.

So, instead of using the adoption of Western notation by autochthonous musicologies as a justification of the continuous and persisting use of this notation in ethnomusicology – and indulge in some sort of intellectual laziness – should we not further explore other, old or new means for the analysis of these musics?

*
* *

PART III. A TOOL FOR THE ANALYSIS AND TEACHING OF MAQĀM MUSIC

Graphic representation of sound can be found in (relatively) early research in phonetics (FHT 42: 232). Its application to melodic music is best explained in Van der Meer and Rao’s publications²⁸⁷ as well as on the SEEM website²⁸⁸ – which are perfect introductions – and “by-documents” – for this third part of the dossier.

Few examples of graphic analysis of melodies today

At the very beginning of my musicological studies at the Sorbonne University, score notation seemed for me to be far from adequate to describe and explain *maqām* music. I have therefore looked for alternatives and found them quite rapidly in the writings of Wim van der Meer and his explanations about the use of Praat for music analysis, which I tried to apply for *maqām* and other musics. (Fig. 58 to Fig. 63)

articles of Meer are cited in this dossier, and few others are available at the author’s latest website (<http://thoughts4ideas.eu/>), which are all interesting for the reader.

²⁸⁸ In French – [Anon. “Notation musicale et visualisation du son - SEEM”]. See also [Picard, 2011].

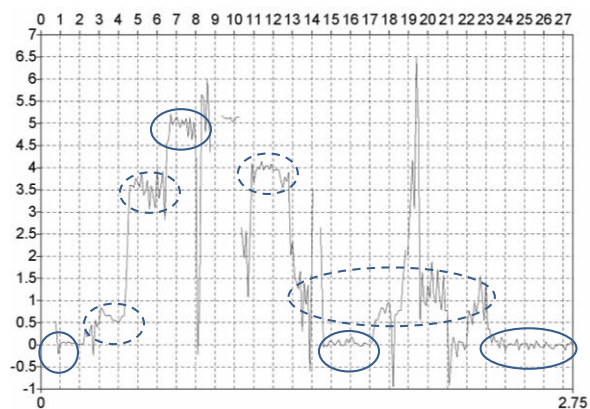

Fig. 58 *Jins (genos) hijāz* performed by Hamdi Makhoul. Pitch (in semi-tones) / Time (in seconds) diagram.²⁸⁹

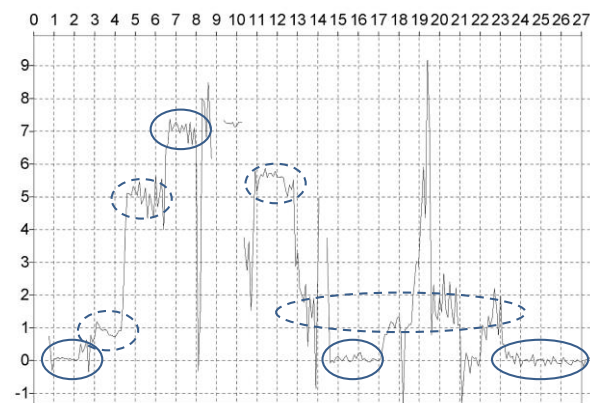

Fig. 59 Same *jins hijāz* as in the previous figure on a 17th of the octave basis.²⁹⁰

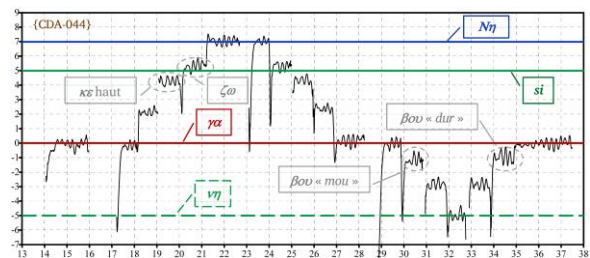

Fig. 60 Annotated (in French and Greek names of notes) example of scale analysis (3rd “enharmonic” mode of Byzantine chant performed by an Anonymous cantor) with Praat.²⁹¹

While the graphs provided through Praat can be as versatile and detailed as needed (Fig. 60 to Fig. 63),²⁹²

²⁸⁹ Originally published in [Beyhom, 2007, p. 219] – graphic annotations are modified in the current figure.

²⁹⁰ Pitch (in 17th of the octave) / Time (in seconds) diagram. Originally published in [Beyhom, 2007, p. 220] – graphic annotations are modified in the current figure.

²⁹¹ Taken from [Beyhom, 2015, p. 355, Figure 293]. Semi-tone (vertical axis) / time (in seconds – horizontal axis) grid drawn with Praat. The additional color-graphic code (horizontal lines – also drawn with Praat) is: Red for the tonic (dashed line for the upper octave – when relevant), Green for the fourth (dashed lines below the tonic) and Blue for the fifth.

some – major – structural limitations²⁹³ restrict the types of music that can be analyzed to mono-instrumental music,²⁹⁴ as well as to reduced time lapses (approx. 30 seconds as a maximum – see Fig. 62).

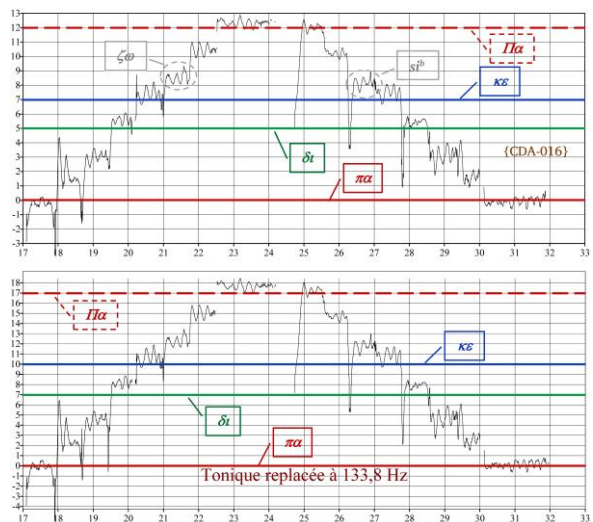

Fig. 61 Annotated (in French and Greek names of notes) example of scale analysis (1st “Diatonic” mode of Byzantine chant performed by fr. Makarios Haidamous) with Praat – taken from [Beyhom, 2015, p. 333, Figure 263]. Above: Semi-tone (vertical axis) / time (in seconds – horizontal axis) grid drawn with Praat; below: 17th of the octave (vertical axis) / time (in seconds – horizontal axis) grid.²⁹⁵



Fig. 62 Annotated (in French) example of a melodic phrase (from *Kyrie Ekekraxa* by Petros Byzantios – performed in Greek by fr. Nicolas Malek) analyzed with Praat in [Beyhom, 2015, p. 408, Figure 393] and featuring a “diatonic” scale (horizontal lines – in parallel with the semi-tones/time grid) and note names added with Praat as well as an inclusion of score detail from MUS2 (see Fig. 56).

²⁹² The only limitation is by the capacity of the computer – and the readiness of the analyst to wait for time-consuming calculations in the case of the use of a computer with an outdated processor – which is what most musicologists can afford.

²⁹³ As with other speech – or sound – analysis programs to the current date.

²⁹⁴ This difficulty can be overcome in specific cases.

²⁹⁵ See fn. 291 for the color-graphic code.

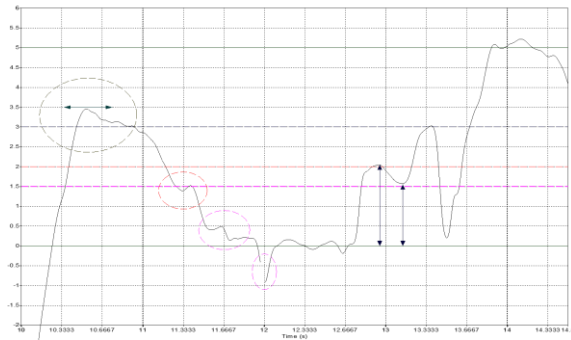

Fig. 63 Analysis of the first 4 seconds of the incipit of a chant in the 1st mode (new Stichiraric style) performed by Giorgios Tsetsis with a quarter-tone (as half of a semi-tone)/time grid and annotations – Used in various presentations by the author.

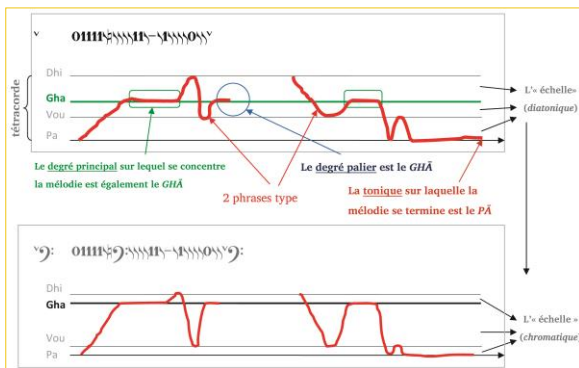

Fig. 64 Analysis from writings by Joseph Yazbeck (Lebanon) on Byzantine chant showing the transformation of two melodic phrases from the “diatonic” (1st) Byzantine mode to the “chromatic” (6th) mode. Added comments (in French) by the author – taken from [Beyhom, 2015, p. 329, Figure 260].²⁹⁶

Within these limits Praat can be a very powerful tool for music analysis, especially when the results are expounded with the help of an animated cursor with, when deemed useful, the parallel down-speeding of the music.

²⁹⁶ Freely adapted from [Yazbeck, 2012a]: the upper line in each graph reproduces the notation put together by Joseph Yazbeck.

²⁹⁷ Whenever the aim of the author is to provide the analyst with the most performing *and* accessible tools – and the least expensive as autochthonous musicologists rarely have the financial means for expensive computer programs, the choice of Praat for such analyses is nearly inevitable. See also the dossier of the author [Beyhom, 2007] on Interval measurements and on the testing of Praat for the analysis of melodic contours.

²⁹⁸ [Anon. “iAnalyse 3 & 4 | Pierre Couprie”]: see also (same reference) *eAnalysis* and [Anon. “Pierre Couprie | Logiciels”]. Note that while Couprie does provide source codes on the *github* platform [Anon. “pierrecouprie (Pierre Couprie)”], these are not the source codes of his showcase programs. Another problem is that whenever the program is free of charge, it only works with specific Apple products, which restricts its use to (generally) musicologists willing

to – and financially capable of – limit(ing) themselves to this material and software platform. The grand majority of autochthonous musicologists use PCs and generic programs on the latter. They have neither the will, nor the financial capabilities, to buy Apple products which may be incompatible with all the material and software available in their milieu. Note that Praat not only works on both platforms (PC and Mac) but also under Linux and few others, and provides the source code free of charge. See also http://liceu.uab.es/~joaquim/phonetics/fon_anal_acus/herram_anal_acus.html – accessed 05/07/2018 – for a comparison of speech analysis softwares – with Praat being used primarily for such analyses.

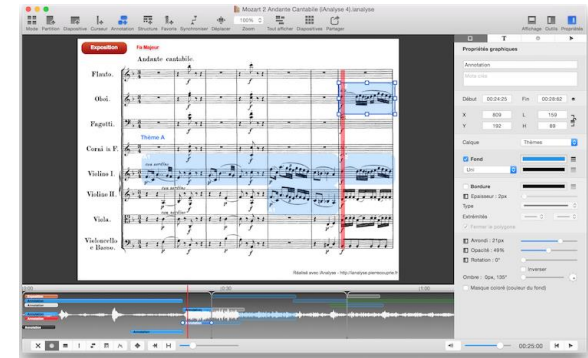

Fig. 65 Excerpt (window snippet) from the Analysis program *iAnalyse* developed by Pierre Couprie.²⁹⁸

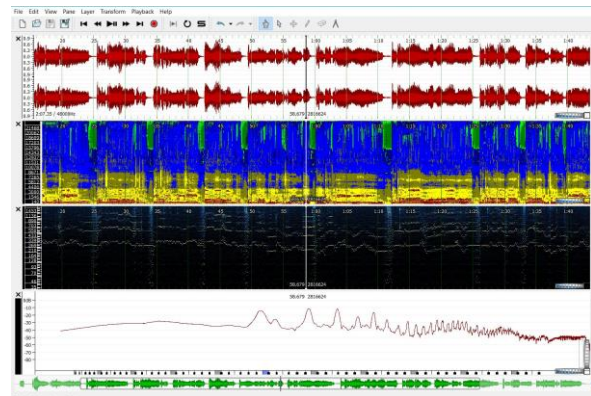

Fig. 66 General view of 4 panes (from top to bottom: Wave form, Spectrogram, Peak frequency spectrogram, Spectrum, with a fifth – lowest – navigation pane in green) analyzing the central part of 7 *maqāmāt* performed by Muḥammad al-Ghazālī in the main window of *Sonic Visualiser*.²⁹⁹

to – and financially capable of – limit(ing) themselves to this material and software platform. The grand majority of autochthonous musicologists use PCs and generic programs on the latter. They have neither the will, nor the financial capabilities, to buy Apple products which may be incompatible with all the material and software available in their milieu. Note that Praat not only works on both platforms (PC and Mac) but also under Linux and few others, and provides the source code free of charge. See also http://liceu.uab.es/~joaquim/phonetics/fon_anal_acus/herram_anal_acus.html – accessed 05/07/2018 – for a comparison of speech analysis softwares – with Praat being used primarily for such analyses.

²⁹⁹ See [Anon. “Sonic Visualiser”]; Cook and Leech-Wilkinson] for more information on this program. (See notably the performance analyses in the latter reference.)

* * *

It is worthwhile here to note that graphic representation of (perceived) pitch is not the same as the graphic representation of the fundamental tone. As musicologists studying the representation of sound, we should first bother about the perceived pitch(es) of the melodic line.³⁰⁰ While the shift in focus of acoustic research from the search for the fundamental to the search of the perceived pitch is relatively recent,³⁰¹ let us stress that, unlike most other programs which simply try to extract the *fundamental*, Praat algorithms allow for the graphic reproduction of the perceived pitch, which is much more effective in pitch determination.³⁰²

Animated analyses

Animations with a horizontally moving cursor synchronized with the music are of common use today, with many examples provided in the ethnomusicological field at the SEEM³⁰³ website of the Université Paris-Sorbonne, and at Wim van der Meer's³⁰⁴ websites.

The author uses power-point animated slides³⁰⁵ with a moving cursor, of which a few examples are provided in the accompanying PPS file to this dossier, and to the making of which a manual³⁰⁶ was dedicated. The usefulness of such animations is obvious, as these provide detailed information on the analyzed music. Their limitations are also evident: only short extracts can be thus analyzed, and only so much information as the (static)

³⁰⁰ See for example [Houtsma and Smurzynski, 1990], see also [Haynes and Cooke, 2001], notably: "Pitch is determined by what the ear judges to be the most fundamental wave-frequency of the sound".

³⁰¹ A good retrospective of the shift from the extraction of the fundamental to the determination of the perceived pitch can be found in [Plomp, 2002, p. 25–29], not forgetting the seminal [Plomp, 1976]. Note also these explanations from Wim van der Meer (personal communication), who raised the subject while reviewing this dossier: "I had learnt most [...] from my French friend/colleague Bernard Bel, who was a computer engineer and programmer. But it was after we met A.J.M. Houtsma (sound perception from TU Eindhoven) that we realized that the fundamental was not necessarily the perceived pitch. My programs took into account those ideas, but later in Leiden and Amsterdam better solutions were created (first LVS in Leiden and then PRAAT in Amsterdam)".

³⁰² Moreover, the source code of Praat is – as already stated above – freely available so anyone can check the way it functions (which is essential in scientific work).

³⁰³ "Séminaire d'Études Ethnomusicologiques" – see <http://seem.paris-sorbonne.fr/>.

screen can contain can be conveyed by a moving cursor with a static graph.³⁰⁷

Successful attempts to overcome the time limitation were made by multiplying the number of animations (joined together in a flash movie in the case of Picard³⁰⁸). These implied however the segmentation of the song in successive slides³⁰⁹ and did not show the effective flow of the melody.³¹⁰

The next step was the use of moving graphs and fixed cursors, or moving graphs and moving cursors, in which the flow of the music appears in its entirety.

INTRODUCTION TO VIDEO-ANIMATED ANALYSES OF THE MELODY – THE VIAMAP

Using animated analyses with moving graphs and (moving or) fixed cursors seems to be, on the face of it, a superfluous step towards a better understanding of *maqām* music as the animations with a moving cursor (and fixed graph) seem to be already rich in teachings. The main lacuna of the latter – apart from the general deficiency of these methods for polyphonic music – lies however in the often too short extracts that can be analyzed following this procedure; analyzing a whole piece or song thus would be time consuming and would require a considerable amount of written explanations with, paradoxically, at least some (or much more) notated musical passages which would lead back to the use of inadequate tools for the analysis of *maqām* music.

Another limitation of the moving cursor with a static graph method is the technical difficulty in explaining tonic shifts and interval variations with time, as well as

³⁰⁴ Mostly <http://thoughts4ideas.eu/>.

³⁰⁵ See the accompanying PPS for a few examples notably for Cypriot and Greek music in Slides nos. 9-15.

³⁰⁶ [Miramon-Bonhoure and Beyhom, 2010].

³⁰⁷ cf. Nettle: "Melographic analysis [...] has been used for the solution of special problems. [...] these studies [are] based on a small amount of music, as little as a few seconds, and in most cases the purpose was to analyze rather minute differences within or among pieces. The kinds of findings one may expect in this type of studies are illustrated by those of Caton (1974:46) on a type of vocal ornament, the Persian *Takiyah*: It is 'distinctly simpler in tone quality than the melody notes'" – [Nettl, 1983, p. 80]. The next section may prove Nettle wrong – at least as for the future of such analyses...

³⁰⁸ See two examples at http://seem.paris-sorbonne.fr/IMG/swf/barbara_allen_molly_jackson.swf and http://seem.paris-sorbonne.fr/IMG/swf/nasori_no_kyu.swf (accessed 12/07/2018).

³⁰⁹ See for example Slides nos. 10-15 in the accompanying PPS.

³¹⁰ This seems to be a decision made by Picard, and not a limitation of the program (Acousmographie) used to create these animated analyses.

identifying intervals for *tajwid*³¹¹-type chanting in which the use of very ample vibrato seems to be the rule.

Once again, and after having nearly abandoned the idea of analyzing whole songs or music pieces, the answer came from Meer's work, this time for the *Music in Motion* program – developed jointly with Suvarnalata Rao, Rustom Irani and Salil P. Kawli – which is concerned with “The Automated Transcription for Indian Music (AUTRIM)”.³¹² The aim of the program is

“to develop a system of notation that would be specifically fit to describe, analyse and even reproduce Indian music with all its fine nuances and inflections”.

While watching the videos, I was stunned at the convenience of the technical handling of the graphs and animation, which made it very easy to follow the (analysis of the) melody and, in parallel, to be able to compare the current passage with preceding or following ones.³¹³ Small literal additions in the video help, at key passages, underline a peculiarity of the analyzed music.

The first video-animation produced by the CERMAA followed these principles loosely³¹⁴ by using a fixed semi-tonal grid to delineate the intervals used in the *Hurrian Song No. 6* in Lara Jokhadar's interpretation of 2012.³¹⁵ (Fig. 67)

The color code used by the author for previous graphic analyses³¹⁶ gives the possibility of identifying intervals (and pitches) at different phases of the song. Small differences in intervals – supposedly between the same pitches in semi-tonal score notation³¹⁷ – can be identified and loosely estimated.³¹⁸ Slight variations of the tonic (and of the pitches in parallel) or of the main

acoustic intervals – the fourth, the fifth and the octave – can also be identified.

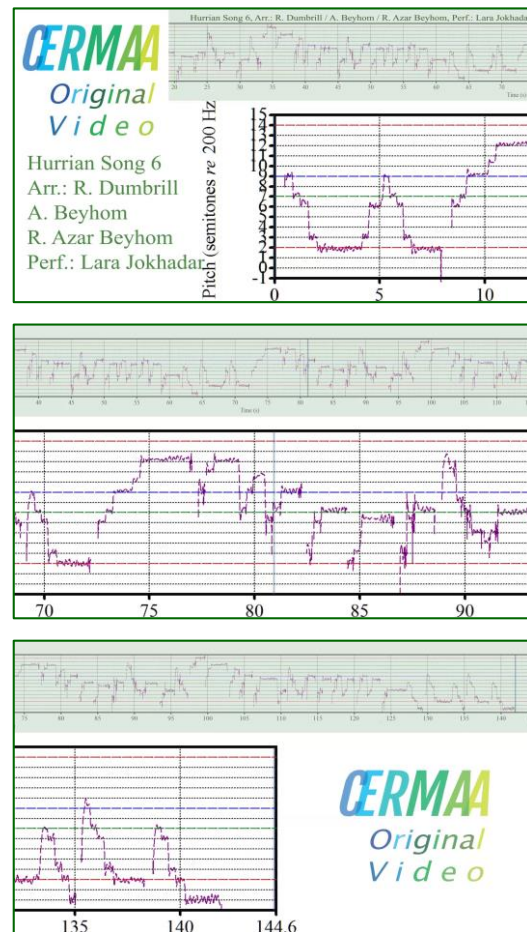

Fig. 67 Three frames (from top: First, Middle, Last) from the video-animated analysis of *Hurrian Song No. 6* in Lara Jokhadar's interpretation of 2012. The lower strip shows the detailed analysis while the upper strip shows a more general view of the same analysis.³¹⁹

³¹¹ Melismatic recitation.

³¹² See <https://autrimnca.wordpress.com/>. Earlier attempts at video-animated representation of melodic music, by the same author or others, existed already but did not reach the degree of refinement achieved in the *Music in Motion* program.

³¹³ The videos of *Music in Motion* (as well as the videos of the CERMAA which were inspired by them) are divided vertically in two lateral stripes, the lower one containing the detailed analysis while the upper stripe shows a more general view of the analysis.

³¹⁴ The main difference lies in the animation of the upper lateral stripe, in which both the cursor and the graph are animated – at a slower pace than for the detailed analysis and with a wider scope – constantly, and in opposite directions. This is one of the secondary differences for technical solutions that can be used in this type of video-animated analyses.

³¹⁵ [Beyhom, 2018c] – Composed according to the corresponding cuneiform text by Richard Dumbrill, Amine Beyhom and Rosy Azar Beyhom. (Watch the video at <https://youtu.be/U8Yr6mKc550> or at [*h6* – \[Beyhom, 2018a\].\) Note also that the recordings analyzed with Praat for these video-animated analyses were treated for broadcasting \(by adding a reverb and, for some of the recordings, by modifying the dynamics – by compression\) when \(later\) included in the animations. \(Praat analysis was undertaken for the “dry” – untreated – sound.\)](http://foredofico.org/CERMAA/analyses/other/hurrian-song-</p>
</div>
<div data-bbox=)

³¹⁶ Reminder: Red lines for the tonic and its octave, Green for the fourth and Blue for the fifth.

³¹⁷ See the original score of the song in Dumbrill's/Beyhom's/Azar Beyhom's interpretation in [Dumbrill, 2017], reproduced in this dossier as FHT 41: 231.

³¹⁸ The main aim of such video-analyses is not the measurement of the intervals, but (notably) to show the variations in both absolute pitch and intervals with the passage of time.

³¹⁹ Figures are given here as examples of particular frames and illustrations of particularities of the analysis. It goes without saying that the video-animated analyses are intended as self-explanatory entities, while the comments and explanations in this dossier are

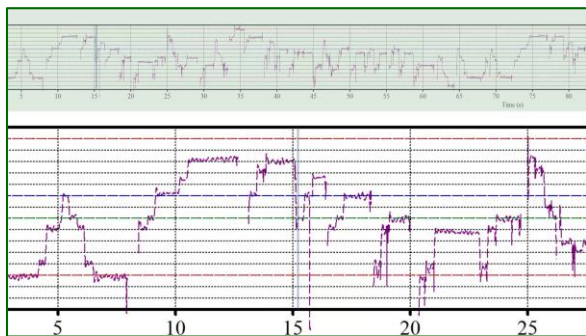

Fig. 68 Rise of the fifth (and upper pitches) then reversion to the semi-tonal grid between 9 s_a and 15 s_a of the video animated analysis by the CERMAA of *Hurrian Song No. 6*, with an ascending *mujannab* around 16 s_a in Lara Jokhadar's interpretation of 2012.

The analysis is in itself pretty much self-explanatory: for example the fifth rises just before 10 s_a³²⁰ shifting the two upper pitches above while the next three pitches (from 13 s_a to 15 s_a) are nearly exactly located at their semi-tonal values (Fig. 68). Such small variations, which may take place either by accident or consciously, do not call for a special technical treatment of the analyzed material as the singer³²¹, although performing *a capella*, maintains a stable tonic – with the aforementioned slight variations – till the end of the song³²².

intended as a help for understanding the need, purpose and usefulness of such analyses in the particular domain of *maqām* music.

³²⁰ “s_a” is used for “seconds of analysis” to differentiate analysis time (s_a) from video time (farther used as “s_v” – or “seconds of the video”).

³²¹ Lara Jokhadar trained in the Lebanese conservatoire and is an experienced performer.

³²² See the very regular positioning of the end pitches in the last frame shown in Fig. 67: compare if needed with the score provided in FHT 41: 231 and with the following by-publications of the same:

- Mixed score (Tonogram reproduction of the intonations in parallel with the score) of Hurrian song H6 (<http://nemo-online.org/wp-content/uploads/2017/08/Hurrian-H6-intonation-120902-12-mixed-scoreS.pdf>)
- Midi reproduction of Hurrian song H6 including intonations (<http://nemo-online.org/wp-content/uploads/2017/08/H6-intonated-Dumbrill-Beyhom-Azar-Beyhom.mp3>)
- Recording of Hurrian song H6 with singer Lara Jokhadar (<http://nemo-online.org/wp-content/uploads/2017/08/H6-Lara-Jokhadar-121021-04-Dumbrill-Beyhom-Azar-Beyhom.mp3>)

³²³ Reminder: the research center of the FOREDOFICO foundation in Lebanon.

³²⁴ Notably to avoid any connotation with the notion of “entertainment” as conveyed by the following websites – which all use “Music in Motion” as a motto: <http://www.djmim.com/>, <https://www.facebook.com/mimskate/> and <http://www.musicinmotionentertainment.com/>.

³²⁵ See <http://foredofico.org/CERMAA/analyses/byzantine-chant/kyrie-ekekraxa> nos. 1-8. These eight videos can also be directly streamed:

While this first analysis concerned itself with a song based on a fixed score – with no variations or interpretations allowed – and on a (near-) semi-tonal grid, it soon became clear that traditional melodies, while based also on a score such as in Byzantine chant, would necessitate a particular treatment for the scale – which in such case should not be based on a semi-tonal division of the octave.

We chose at the CERMAA³²³ to gradually enlarge the scope of the application of such analyses for what we termed “Video-Animated (Music, *maqām* or Melody) Analysis” – or (the) VIAMAP when adding the caudal “Project”.³²⁴

VIDEO-ANIMATED ANALYSES OF BYZANTINE CHANT(S)

The first attempts at such analyses were made for the first set of video-animations of the song *Kyrie Ekekraxa* by Petros Byzantios³²⁵, including 8 variations of this song – 4 in Greek and 4 in Arabic – by 4 Lebanese cantors previously recorded for the book of the author on Byzantine chant³²⁶. The videos are self-explanatory and based on the 1881 Byzantine (Second) Reform “diatonic”³²⁷ scale with a dedicated color code. (Fig. 69 and Fig. 70)

1. *Kyrie Ekekraxa* in Arabic by fr. Makarios Haidamous (published 16/02/2018 – original recording [Haidamous, 2010a]): <https://youtu.be/j8w9I9Cff0c> [Beyhom, 2018b]
2. *Kyrie Ekekraxa* in Greek by fr. Makarios Haidamous (published 19/02/2018 – original recording [Haidamous, 2010b]): <https://youtu.be/8SSETdJWC8o> [Beyhom, 2018d]
3. *Kyrie Ekekraxa* in Arabic by an Anonymous Cantor (published 19/02/2018 – original recording [Anonymous, 2011a]): https://youtu.be/Uek_AD_aRQg [Beyhom, 2018e]
4. *Kyrie Ekekraxa* in Greek by an Anonymous Cantor (published 19/02/2018 – original recording [Anonymous, 2011b]): <https://youtu.be/ush88CvgQYk> [Beyhom, 2018c]
5. *Kyrie Ekekraxa* in Arabic by fr. Nicolas Malek (published 22/02/2018 – original recording [Malek, 2011a]): <https://youtu.be/wlhyN30y-qc> [Beyhom, 2018f]
6. *Kyrie Ekekraxa* in Greek by fr. Nicolas Malek (published 22/02/2018 – original recording [Malek, 2011b]): <https://youtu.be/w6YWloCd2Do> [Beyhom, 2018g]
7. *Kyrie Ekekraxa* in Arabic by Joseph Yazbeck (abridged – published 26/02/2018 – original recording [Yazbeck, 2012b]): <https://youtu.be/QvKcoi7LdVI> [Beyhom, 2018h]
8. *Kyrie Ekekraxa* in Greek by Joseph Yazbeck (abridged – published 26/02/2018 – original recording [Yazbeck, 2012c]): <https://youtu.be/tvElBc7-3-4> [Beyhom, 2018i]

³²⁶ [Beyhom, 2015].

³²⁷ Understand “diatonic” in its original, Ancient Greek use, *i.e.* as in a tetrachord having no *pycnon*.

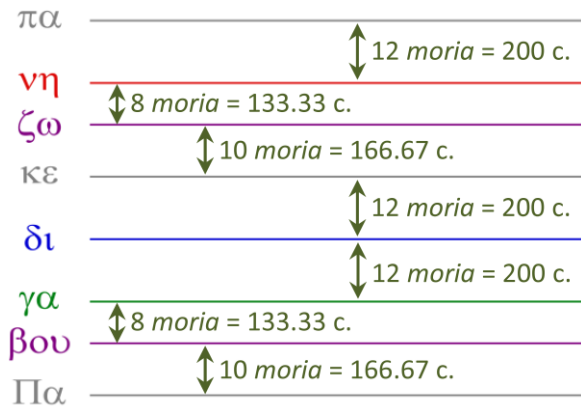

Fig. 69 Graphic scale of the 1st Byzantine mode (“diatonic”) – used in the video-animated analyses, with the theoretical values of intervals (2nd Reform of 1881) given in “minutes” (“*moria*”) and cents.³²⁸

Note that the scales in the videos – be they graphic or in score notation – are only shown to give a reference for the viewer (and listener), and to mark the discrepancy between theory and practice – which is obvious in all the analyses.

A further improvement concerns the upper stripe which has been simplified (no grid but only the red tonic line and – whenever deemed necessary or useful – its upper octave). Readers who practice score notation can compare the interpretations (and the differences between the latter) of the 4 Lebanese cantors with the tentative adapted score provided in FHT 45 and FHT 46, or with the original 1820 Byzantine notation (FHT 43 and FHT 44) – if familiar to the reader.

³²⁸ 1 “*moria*” = $1200 \text{ c} / 72 = 200 \text{ c} / 12 = 16.67 \text{ c}$.

³²⁹ And as can be easily deduced from watching the corresponding videos. Note that recordings made – of his own performances – by fr. Makarios Haidamous included heavy – added – reverb which necessitated a special treatment of the recording prior to the analysis by Praat. This was also the case for the recording of Muḥammad al-Ghazālī’s *Seven Maqāmāt* (explored farther) which was extracted from the corresponding video uploaded on YouTube (the address of the original YouTube video figures at the beginning and at the end of the video-animated analysis).

³³⁰ As used already for previous animated analyses (animated cursor with fixed graph) using Power Point presentations.

³³¹ Note that video-hosting providers – such as YouTube chosen for the hosting of the video-animated analyses by the author – do pro-

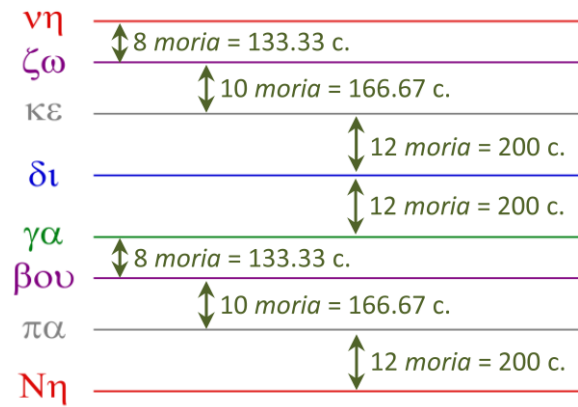

Fig. 70 Graphic scale of the 8th Byzantine mode (“diatonic”) – used in the video-animated analyses, with the theoretical values of intervals (2nd Reform of 1881) in “minutes” (“*moria*”) and cents.

Strikingly enough, and despite the differences in styles and interpretations for these 4 cantors, the tonic remains mostly stable from the beginning to the end of the song, as shown in Fig. 72 to Fig. 75.³²⁹

In-video comments (Fig. 76) were added to help the viewer understand the different changes occurring but these soon seemed a little overwhelming – as too much information was provided in very short periods of time – which triggered the idea³³⁰ of producing a half-tempo version³³¹ complementing the full-tempo version.³³²

In order to be, however, less directive³³³ for the analyses, and while the inlayed comments were kept within the main (lower) stripe, a pair of dashed gray lines was added for the analysis of the Greek version of the same song – to show the positions of the original tonic and octave (Fig. 77).

pose different speeds (up to quarter-tempo for YouTube) and resolutions to the viewer/listener, but the quality of the audio is generally degraded.

³³² At this stage, notated versions of the scales of the modes used in the chant were added at key moments to complete the analyses. Note that the terms “half-tempo” (or “reduced tempo”, or “Xth part of the original tempo”) are more adequate than “slow motion” used by Meer (in <http://thoughts4ideas.eu/what-you-hear-isnt-what-you-see/> [figures 6a and 6b] – accessed 12/07/2018), with the latter terms being even inaccurate when applied to motionless videos (see for example <https://youtu.be/wodNQzUEOCc> from the same author, embedded in the same page); note however that Meer uses further the caption “Fig. 8B: Fig 8A slowed down by a factor 2 (= 3 x slower than the original)” for <https://youtu.be/LSSCjz-D6tg>, which seems to me more accurate.

³³³ I dare not write here “less prescriptive”...

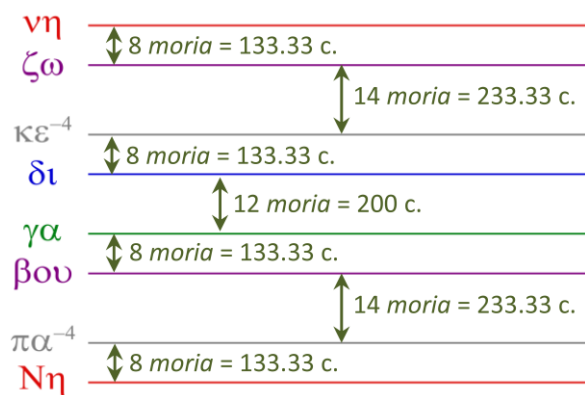

Fig. 71 Graphic scale of the 2nd Byzantine mode – used in the video-animated analyses, with the theoretical values of intervals (2nd Reform of 1881) in “minutes” (“moria”) and cents. (1 “moria” = 1200 c / 72 = 200 c / 12 = 16.67 c)

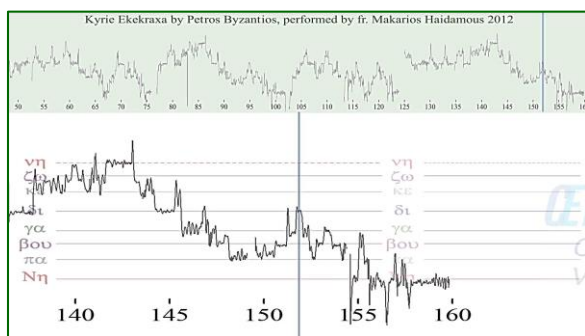
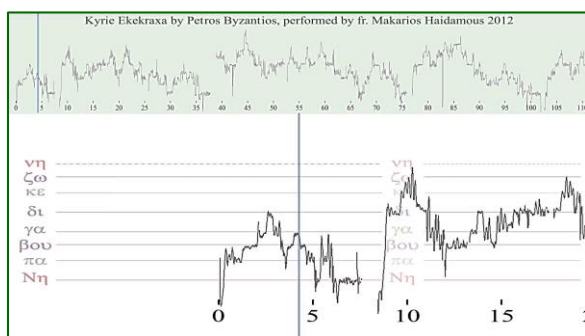

Fig. 72 Beginning and ending tonics in fr. Haidamou’s interpretation of *Kyrie Ekekraxa* (Arabic version).³³⁴

³³⁴ Father Makarios Haidamou declared to me that he used, for this recording, an *ison* (drone) which he could listen to through headphones. All other recordings are *ison*-less and – except otherwise stated – made by Rosy and Amine Beyhom.

³³⁵ Either solid or dashed.

³³⁶ A half-tempo version was also produced for this analysis – See next footnote.

³³⁷ These can be found at <http://foredofico.org/CERMAA/analyses/byzantine-chant/kyrie-ekekraxa> nos. 13-16 and can also be directly streamed:

These are also reproduced in the form of two fine red lines³³⁵ in the upper stripe.³³⁶

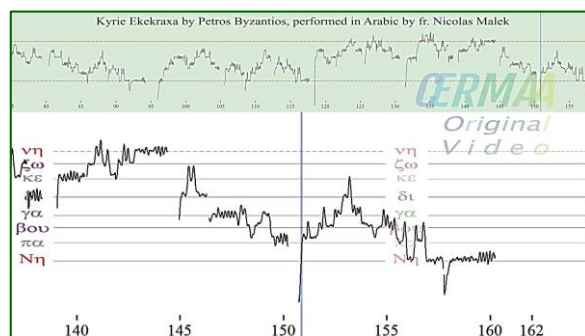
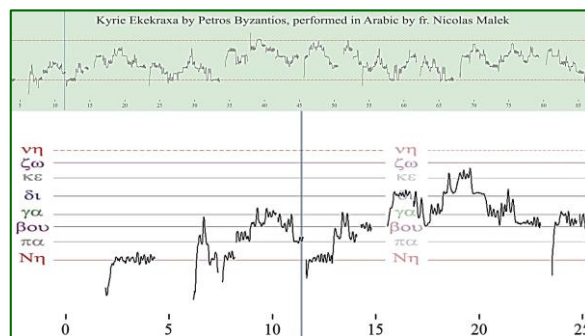

Fig. 73 Beginning and ending tonics in fr. Nicolas Malek’s interpretation of *Kyrie Ekekraxa* by Petros Byzantios in the Arabic version.

Traditional singing is, however, often more dynamic in what concerns variations of intervals and tonic pitch(es). This happened for the next analysis of the Arabic version of the same chant as performed by Bachir Osta.³³⁷

The tonic (FHT 47 to FHT 50) and the intervals in the interpretations of this cantor change constantly which makes it difficult for the viewer to understand the progression of the melody without an appropriate treatment of the scale.

The most simple remedy – and technical solution – for such an analysis is to use a (vertically) moving scale which is adapted to the pitch of the tonic or to either

13. *Kyrie Ekekraxa* in Arabic by Bachir Osta (uploaded 10/10/2018 – original recording [Osta, 2013a]): <https://youtu.be/hAicecu12TI> [Beyhom, 2018j]
14. *Kyrie Ekekraxa* in Arabic by Bachir Osta in Half tempo (uploaded 10/10/2018): <https://youtu.be/gHfSkqOzJio> [Beyhom, 2018k]
15. *Kyrie Ekekraxa* in Greek by Bachir Osta (uploaded 10/10/2018 – original recording [Osta, 2013b]): <https://youtu.be/WQVdSqLh1v4> [Beyhom, 2018l]
16. *Kyrie Ekekraxa* in Greek by Bachir Osta in Half tempo (uploaded 24/10/2018): <https://youtu.be/2QYvuEAOHWE> [Beyhom, 2018m]

note of the scale which can help identifying the melodic contour at a given time.³³⁸

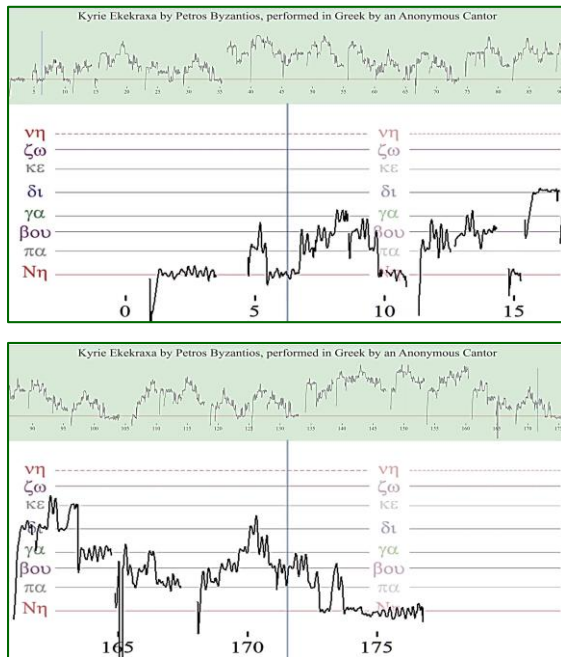

Fig. 74 Beginning and ending tonics in the interpretation by an Anonymous cantor of *Kyrie Ekekraxa* by Petros Byzantios in the Greek version.

This analysis featured also the use of two different scales for each of the modes in use in this chant (the 8th Byzantine chant mode – Fig. 70 – with an incursion in the 2nd mode – Fig. 71).

Let us remind that such a special treatment is only needed in the case of multiple variations in the scale, of the tonic and of intervals.

³³⁸ In the case of Byzantine chant, the *βου* – or even the *ζω* – can sometimes play this role (watch mainly the versions of *Axion Estin* mentioned farther) – which contradicts the “movable”, or “fluctuating” status of these notes in *maqām* music.

³³⁹ See <http://foredofico.org/CERMAA/analyses/byzantine-chant/kyrie-ekekraxa> nos. 9-12 or:

9. *Kyrie Ekekraxa* in Arabic by an Anonymous Cantor (V2 uploaded 10/10/2018): <https://youtu.be/uGL8PtgNHlY> [Beyhom, 2018n]
10. *Kyrie Ekekraxa* in Arabic by an Anonymous Cantor (V2) in Half tempo uploaded 10/10/2018): <https://youtu.be/2-zsuOXtFsU> [Beyhom, 2018o]
11. *Kyrie Ekekraxa* in Greek by an Anonymous Cantor (V2 uploaded 10/10/2018): <https://youtu.be/f-QHaMJ5138> [Beyhom, 2018p]
12. *Kyrie Ekekraxa* in Greek by an Anonymous Cantor (V2) in Half tempo uploaded 10/10/2018): <https://youtu.be/cVvwFtQE8Dc> [Beyhom, 2018q]

Note that the last two videos feature a finer graphical analysis expounded farther.

³⁴⁰ Note that these dashed lines were included systematically as part of a tentative – generalized – template for further analyses.

In a remake of the analysis of these chants (in both Arabic and Greek languages) as interpreted by an Anonymous cantor³³⁹, the use of a special marker for the original tonic in the main analysis stripe was deemed superfluous.³⁴⁰

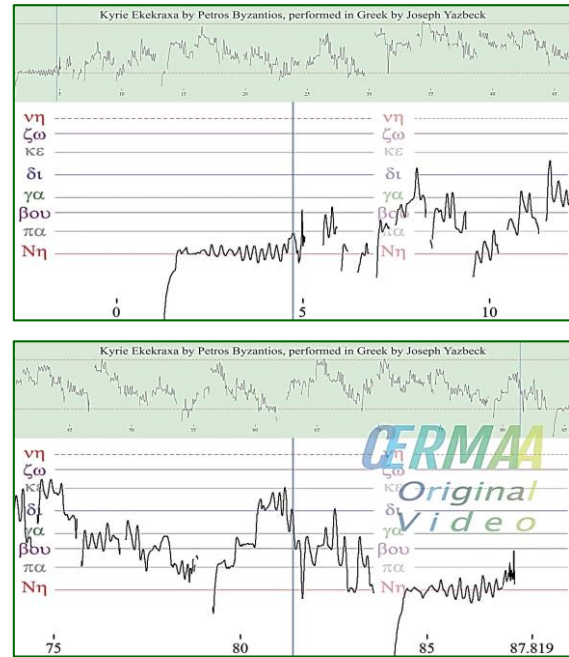

Fig. 75 Beginning and ending – considerably rising at the end for the latter – tonics in Joseph Yazbeck’s interpretation of *Kyrie Ekekraxa* by Petros Byzantios in the Greek version.

This series of analyses was completed by another series of the same chant performed by four Greek cantors.³⁴¹ (Fig. 78) These analyses³⁴² included some technical improvements, the most important of which was

³⁴¹ The four cantors were recorded in parallel to a conference on Psaltic chant in Volos from the 29th of May to the 1st of June.

³⁴² See <http://foredofico.org/CERMAA/analyses/byzantine-chant/kyrie-ekekraxa> nos. 17-20 or:

17. *Kyrie Ekekraxa* in Greek by Emmanouil Giannopoulos (recorded 31/05/2018 by Rosy Beyhom with Zoom H2 in Volos - Greece; uploaded 10/10/2018): https://youtu.be/7_DawlHFeOk [Beyhom, 2018r]
18. *Kyrie Ekekraxa* in Greek by Ioannis Tomas (recorded 31/05/2018 by Rosy Beyhom with Zoom H2 in Volos - Greece; uploaded 10/10/2018): <https://youtu.be/ettizTmrlpw> [Beyhom, 2018s]
19. *Kyrie Ekekraxa* in Greek by Mikhail Stroumpakis (recorded 01/06/2018 by Rosy Beyhom with Zoom H2 in Volos - Greece; uploaded 10/10/2018): <https://youtu.be/lje3EdE9bws> [Beyhom, 2018t]
20. *Kyrie Ekekraxa* in Greek by Nikolaos Siklaidis (recorded 31/05/2018 by Rosy Beyhom with Zoom H2 in Volos - Greece; uploaded 10/10/2018): <https://youtu.be/AvNz2oUYSHY> [Beyhom, 2018u]

the use of vectorized graphic output from Praat which allows for a more precise – and smooth – reproduction of the melodic line and of the superimposed scales³⁴³ (Fig. 79, Fig. 80 and Fig. 81).

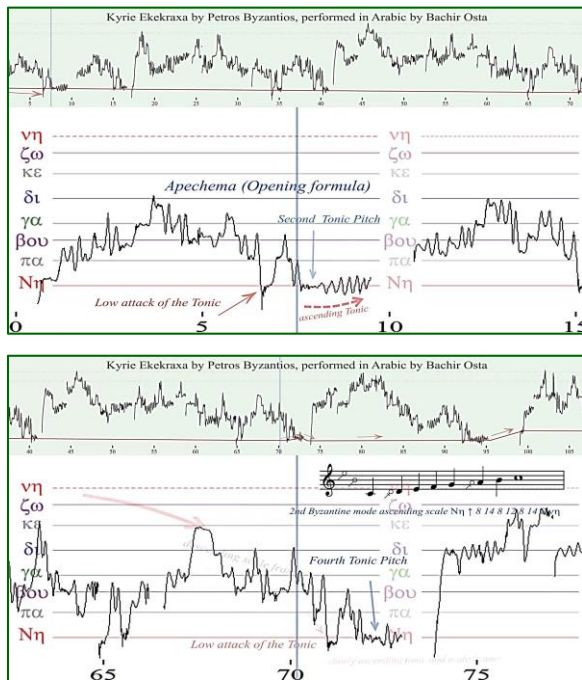

Fig. 76 Additional embedded comments with a (vertically) moving scale used in two frames extracted from the video-analysis of Bachir Osta’s interpretation of *Kyrie Ekekraxa* in Greek.³⁴⁴

The finer delineation of the melodic line made it also possible to systematize the use of the dashed lines indicating the original positions of the tonic and its upper octave, which proved useful for interpretations such as

by Ioannis Tomas for example, but also for the other Greek cantors.³⁴⁵

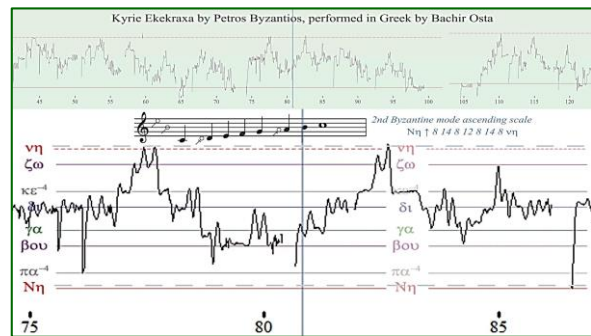

Fig. 77 Additional gray dashed lines show the positions of the original (beginning) tonic and its (upper) octave in the video-analysis of Bachir Osta’s interpretation of *Kyrie Ekekraxa* in Arabic.³⁴⁶



Fig. 78 Five Greek cantors – Volos (Makrinitza) 2018/05/31 (photo credit: Amine Beyhom).³⁴⁷

Further analyses were dedicated to one other Byzantine chant, namely *Axion Estin* in 8 modes by an anonymous composer.³⁴⁸ (Fig. 82 and Fig. 83)

³⁴³ A few – up to nine for the latter videos – different computer programs are used for the production of such video-animated analyses, with Praat being one single – but essential – component of the whole.

³⁴⁴ The red line in the upper stripe shows the general movement (ascending or descending) of the tonic. Graphic scales are complemented at key moments with hybrid Western-Byzantine notated scales and accompanying literal notation in 2nd Reform Byzantine “minutes”.

³⁴⁵ I hypothesize farther – but this needs further research and analyses to be proven (or unproven) – that Lebanese cantors, being more impregnated with “Oriental” *maqām* music and *tajwid*, have therefore less difficulties in maintaining a steady tonic throughout the chant – in the case of (Lebanese) Bachir Osta, Greek Psaltic may have influenced his style.

³⁴⁶ The two fine red lines in the upper strip underline the positions of the same pitches. The superimposed scale reproduces the theoretical intervals of the 2nd Byzantine chant mode in the formulation of the Second reform (see also Fig. 71 above).

³⁴⁷ Front row, left to right: Ioannis Tomas, Nikolaos Siklaidis and Michalis Stroumpakis. 2nd row, left to right: Conference host Konstantin Karagounis with Emmanouil Giannopoulos.

³⁴⁸ See <http://foredofico.org/CERMAA/analyses/byzantine-chant/axion-estin nos. 1-9>. These eight + one – alternate for fr. Nicolas Malek – videos can also be directly streamed:

1. *Axion Estin* by fr. Makarios Haidamous (recorded 06/06/2018 by the performer in Dayr al-Mukhallis - Lebanon; uploaded 09/10/2018): <https://youtu.be/aWnwPvGORi8> [Beyhom, 2018v]
2. *Axion Estin* by an Anonymous Cantor (recorded 25/06/2018 by Rosy Beyhom with Zoom H2 in Broummana - Lebanon; uploaded 09/10/2018): <https://youtu.be/DWsrXGih8hM> [Beyhom, 2018w]
3. *Axion Estin* by fr. Nicolas Malek (recorded 24/06/2018 by Rosy Beyhom with Zoom H2 in Broummana - Lebanon; uploaded 09/10/2018): <https://youtu.be/UNYUifNwHuM> [Beyhom, 2018x]
4. *Axion Estin* by fr. Nicolas Malek – Alternate take (recorded 24/06/2018 by Rosy Beyhom with Zoom H2 in Broummana - Lebanon; uploaded 09/10/2018): <https://youtu.be/JYZAj-DYj60> [Beyhom, 2018y]
5. *Axion Estin* by Joseph Yazbeck (recorded 08/06/2018 by Rosy Beyhom with Zoom H2 in Broummana - Lebanon; uploaded 09/10/2018): https://youtu.be/_Cpyf9hqUEc [Beyhom, 2018z]

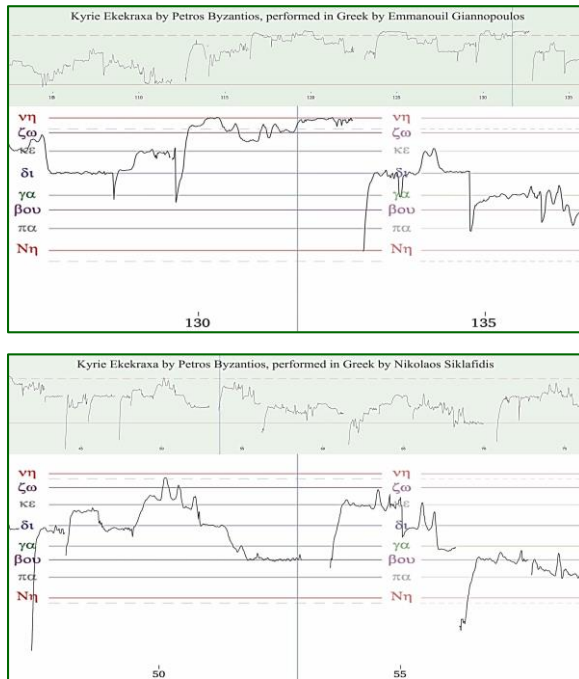

Fig. 79 Frames extracted from the video-animated analyses of *Kyrie Ekekraxa* by Petros Byzantios in, from top to bottom, the interpretations of Emmanouil Giannopoulos and Nikolaos Siklaidis.

Besides this chant being a challenge for any cantor in the field of Byzantine chant,³⁴⁹ these analyses contributed as a test for the procedures already in use and triggered new developments such as the delimitation of the modes (between brackets) together with a more elaborate grid³⁵⁰ in the upper stripe and/or the use of additional indicators for peculiarities of the chant³⁵¹.

6. *Axion Estin* by Emmanouil Giannopoulos (recorded 31/05/2018 by Rosy Beyhom with Zoom H2 in Volos - Greece; uploaded 09/10/2018): <https://youtu.be/4VpOchjBEZA> [Beyhom, 2018aa]
7. *Axion Estin* by Nikolaos Siklaidis (recorded 31/05/2018 by Rosy Beyhom with Zoom H2 in Volos - Greece; uploaded 09/10/2018): <https://youtu.be/gyxoviJs1aU> [Beyhom, 2018ab]
8. *Axion Estin* by Ioannis Tomas (recorded 31/05/2018 by Rosy Beyhom with Zoom H2 in Volos - Greece; uploaded 09/10/2018): <https://youtu.be/QICHWCaOfQA> [Beyhom, 2018ac]
9. *Axion Estin* by Mikhail Stroumpakis (recorded 01/06/2018 by Rosy Beyhom with Zoom H2 in Volos - Greece; uploaded 09/10/2018): <https://youtu.be/qM34JswCUZo> [Beyhom, 2018ad]

³⁴⁹ Most of the recorded Greek cantors had for example difficulties in holding the intervals in the seventh mode – or “diatonic” on *Zō*. I would like to express here my heartfelt thanks to fr. Romanos Joubran who helped us at the CERMAA seek and find this chant, the particularities of which greatly enriched the observation of the resulting analyses.

³⁵⁰ Using once again the color code for main intervals (red solid and dashed horizontal lines for the tonic and octave, green for the fourth and blue for the fifth) and helping thus the viewer identifying the melodic course.

Moreover: a set of identified “attractions” was searched for in the interpretations and underlined (Fig. 81 – upper frame at 112.5 s_a) for each cantor.³⁵²

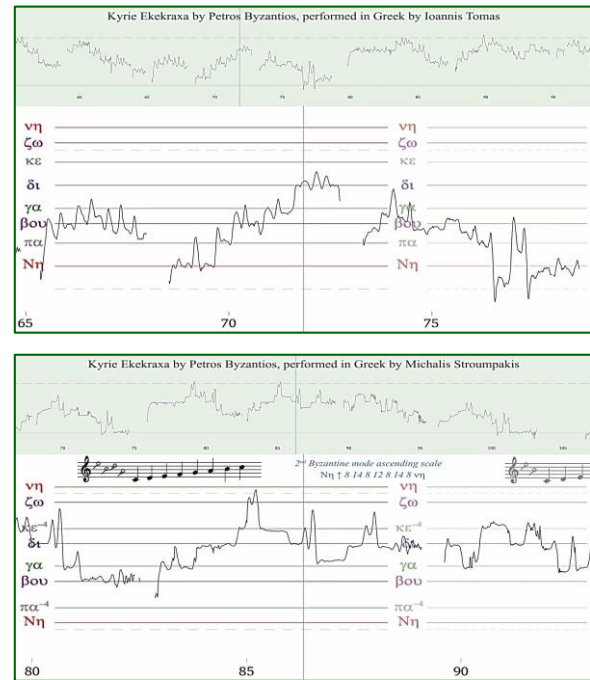

Fig. 80 Frames extracted from the video-animated analyses of *Kyrie Ekekraxa* by Petros Byzantios in, from top to bottom, the interpretations of Ioannis Tomas and Michalis Stroumpakis.³⁵³

One of the lessons to be drawn from these analyses concerns the factual difference between the intervals used in Byzantine chant by cantors impregnated by the 2nd Reform theory and the same intervals as performed

³⁵¹ Notably the “attractions” particular to the modes of Byzantine chant – in the lower stripe – and the literal delimitation of the first tonic and its octave (*Πα* and *πα*) – in the upper stripe.

³⁵² These attractions are the use of the “diatonic” (in the Byzantine sense of the word) *βου*(s) in the 3rd mode (measures 14 and 16 in the score of FHT 52: 240), of the lowered two *Zō*(s) in the 5th mode (measure 27 in the same figure), the use of upper “diatonic” *βου* in the 6th mode – the two *βου*(s) in measure 30, and the two raised *γα*(s) at the beginning of the 7th and of the 8th mode (measures 36 and 45). Note that the attractions were not underlined for the analysis of this chant as performed by Joseph Yazbeck due to the particular style – notably characterized by ample variations and constantly changing pitches – of this cantor.

³⁵³ The first frame (top) illustrates the considerable discrepancies for the positions of the tonic pitch in the cantor’s interpretation. The styles of the cantors vary also considerably which contradicts the theory of standardized Byzantine chanting put forward by the Music Committee of 1881 – see Chapter III in [Beyhom, 2016b] – even when limited to Greece as such.

by the school of “Oriental” singing represented here by fr. Nicolas Malek (third from top in Fig. 83, then Fig. 85) and, as a tentative experiment to include an extraneous element in the analyses, by Rosy Beyhom (Fig. 84)³⁵⁴.

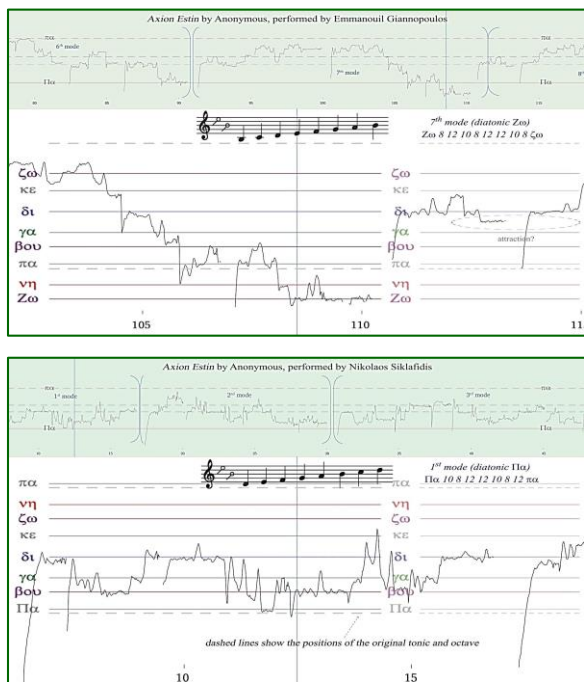

Fig. 81 Frames extracted from the video-animated analyses of *Axion Estin* in, from top to bottom, the interpretations of (Greek) Emmanouil Giannopoulos and Nikolaos Siklaidis.

Both have trouble in choosing the pitches of the *βου* and the *Ζω*, which leads to slight (localized) scale disruptions. This also applies (mainly for the *Ζω*) for the Anonymous cantor (Fig. 86).

More generally, and surprisingly enough, most of – if not all – the cantors have had difficulties in keeping coherent intervals in the 3rd mode which is the “enhar-

monic” (“ditonic” – supposedly equivalent to the “Western”) on $N\eta = c$ ³⁵⁵ (examples are provided in Fig. 82 – bottom frame – and Fig. 83 – 2nd and 4th frames from top).

Further: all these analyses confirm that the notated scores are but a guide, and that these are interpreted more or less freely according to each performer.

Other developments for *Axion Estin* include a template analysis (Fig. 87)³⁵⁶ based on the westernized score as transnotated by fr. Romanos Joubran and the author, (FHT 51 and FHT 52: 239-240). This definitely shows the discrepancy between notated music³⁵⁷ and its interpretation in Byzantine chant.³⁵⁸

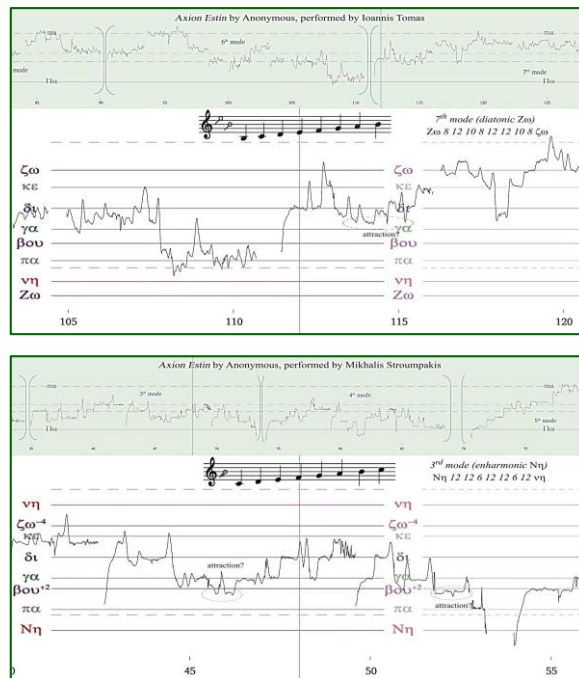

Fig. 82 Frames extracted from the video-animated analyses of *Axion Estin* in, from top to bottom, the interpretations of (Greek) Ioannis Tomas and Michalis Stroumpakis.³⁵⁹

³⁵⁴ See <http://foredofico.org/CERMAA/analyses/byzantine-chant/axion-estin> no. 10 (this video can also be directly streamed):

10. *Axion Estin* by Rosy Beyhom (recorded 14/06/2018 by Rosy Beyhom with Zoom H2 in Broummana - Lebanon; uploaded 09/10/2018): <https://youtu.be/1Dhi2g6dPkY> [Beyhom, 2018ae]

³⁵⁵ All pitches are relative. The Second Reform *enharmonic* mode on $N\eta (= c)$ is equivalent to a western (“ditonic” – as with “having two whole tones in the Fourth”) mode of g on c , or $c\ 2\ 2\ 1\ 2\ 2\ 1\ 2\ C$ in multiples of the semi-tone.

³⁵⁶ See <http://foredofico.org/CERMAA/analyses/byzantine-chant/axion-estin> nos. 11-12. These – original and half-tempo – videos can also be directly streamed:

11. *Axion Estin* by Anonymous, template analysis of audio output by programs MUS2 & Cubase (uploaded 09/10/2018): <https://youtu.be/YuRD6G4PTuE> [Beyhom, 2018af]

12. *Axion Estin* by Anonymous, template analysis of audio output by programs MUS2 & Cubase – Half-tempo (uploaded 09/10/2018): https://youtu.be/MiRuhUt_tMQ [Beyhom, 2018ag]

³⁵⁷ And, here, its computerized interpretation by the program MUS2 for score notation which produced the midi score, then by Cubase which reproduced the pitches according to digitalized violin samples.

³⁵⁸ While the wife of fr. Nicolas Malek (Orthodox priests can be married and have children) was visiting the CERMAA in July 2018, we showed her – among others – this template video-animated analysis. Her main reaction to the beginning of the piece was “This sounds so much like a Minor scale – it has nothing to do with the chanting as such!”

³⁵⁹ The styles of these cantors (their graphic “signature” in these videos and analyses), together with the styles of the two cantors in the previous figure and as for *Kyrie Ekekraxa* by Petros Byzantios, vary considerably.

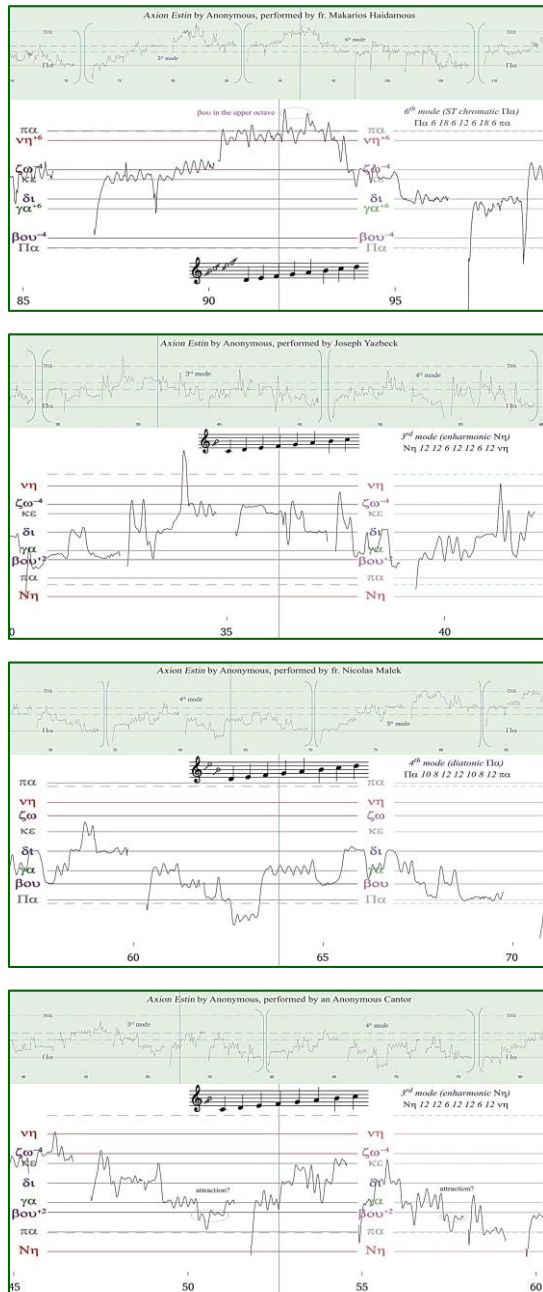

Fig. 83 Frames extracted from the video-animated analyses of *Axion Estin* by an Anonymous composer (in the eight Byzantine modes).³⁶⁰

³⁶⁰ In, from top to bottom, the interpretations of (Lebanese) fr. Makarios Haidamous, Joseph Yazbeck, fr. Nicolas Malek and an Anonymous cantor, also with different styles. Father Makarios Haidamous declared that he didn't use, for this recording, an *ison*. As stated above, all other recordings of Byzantine chant reviewed in this dossier – for the video-animated analyses – were made by me or by Rosy Beyhom: all these recordings were made without the use of an *ison*.

³⁶¹ The first analysis was undertaken for the third audio take – which was the choice of the author. As fr. Malek inclined towards the second take, it was also analyzed and named “Alternate Take”.

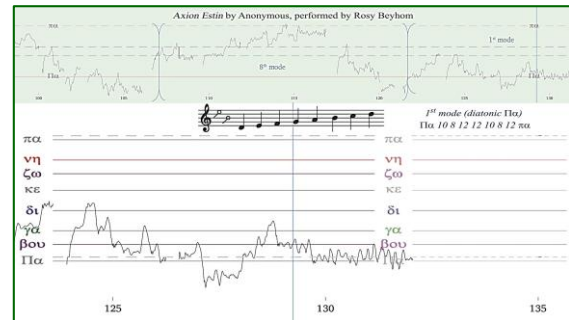

Fig. 84 One frame towards the end of the video-animated analysis of *Axion Estin* as performed by Rosy Beyhom. The performer has visible trouble choosing between the lower, “Oriental” *βου* and the higher, “Byzantine” *βου*.

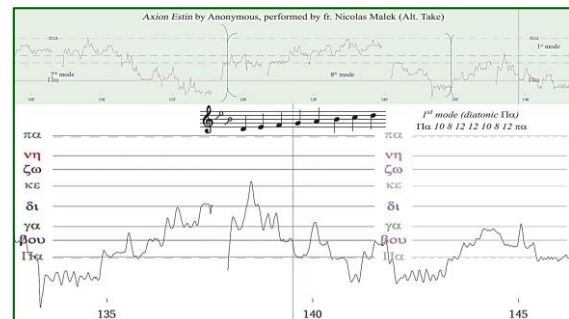
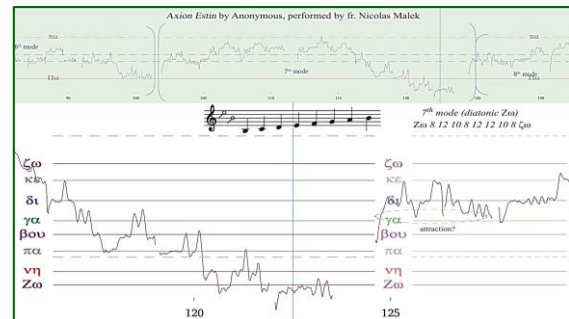

Fig. 85 One frame (top) to the end of the 7th Byzantine mode in the video-animated analysis of *Axion Estin* performed by fr. Nicolas Malek, and one frame (bottom) towards the end of the analysis of the second (alternate) take.³⁶¹

An Arabic language version³⁶² (from right to left – Fig. 88) was also produced in order to verify the feasibility of such videos for Arabic-speaking (or likewise right to left reading) countries.

Note that in the upper frame, the performer has visible trouble choosing between the lower, “Oriental” *ζω* and the higher, “Byzantine” *ζω*. This also applies – in the lower frame – to the lower “Oriental” *βου* and the higher “Byzantine” *βου*.

³⁶² As well as a half-tempo version – see <http://foredofico.org/CERMAA/analyses/byzantine-chant/axion-estin> nos. 13-14. These – original and half-tempo – videos can also be directly streamed:

13. *Axion Estin* by Anonymous, template analysis of audio output by programs MUS2 & Cubase (R to L) – (uploaded 09/10/2018): <https://youtu.be/j3lyDA-IFPE> [Beyhom, 2018ah]

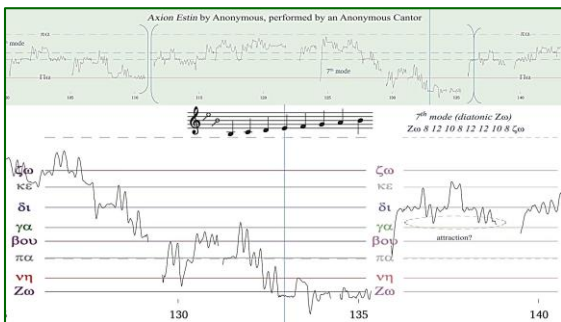

Fig. 86 One frame to the end of the 7th Byzantine mode in the video-animated analysis of *Axion Estin* performed by an anonymous cantor. The performer has visible trouble choosing between the lower, “Oriental” *Zo* and the higher, “Byzantine” *Za*.

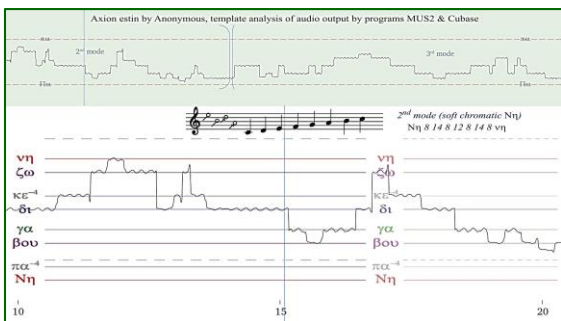

Fig. 87 One frame extracted from the Template analysis of *Axion Estin* by an anonymous composer. The audio was produced by a Cubase violin VST on the base of a midi score extracted with MUS2 from the transnotated score (FHT 52).

As a final addition to these – Byzantine – analyses, a synthetic table of the 9 *Axion Estin* commented Praat analyses³⁶³ was assembled and used as a poster by the author (FHT 53: 241).

14. *Axion Estin* by Anonymous, template analysis of audio output by programs MUS2 & Cubase – Half-tempo (R to L) – (uploaded 09/10/2018): <https://youtu.be/tDXJkXGO8fo> [Beyhom, 2018ai]

³⁶³ To which were added the template analysis and the alternate-take analysis for fr. Nicolas Malek – which makes it 11 analyses in all.

³⁶⁴ The video-analyses of these (Byzantine) chants would have been, in some cases, much more difficult to undertake without prior knowledge of the modes – and of the “attractions”.

³⁶⁵ *i.e.* much more versatile.

³⁶⁶ See [Denny, 2012] for a complete definition – and description. Note also: “*Tajweed* (Arabic: تجويد *tajwid*, IPA: [tædʒˈwiːd], meaning ‘elocution’), sometimes rendered as *tajwid*, refers to the rules governing pronunciation during recitation of the *Quran*. The term is derived from the trilateral root *j-w-d* meaning ‘to make well, make better, improve’. *Tajweed* is a *mustahab* (preferred, but not an obligation) when reciting the *Quran* to the best of one’s ability” – in [Wikipedia Contributors, 2018d].

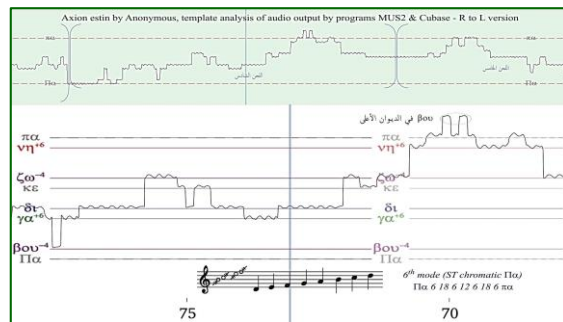

Fig. 88 One frame extracted from the template analysis of *Axion Estin* (Anonymous) from right to left, including incrustations in the Arabic language.

VIDEO-ANIMATED ANALYSES OF TWO *TAJWĪD*-LIKE SONGS BY THE *SHAYKH* ‘ALĪ MAḤMŪD AND THE *QĀRĪ* MUḤAMMAD AL-GHAZĀLĪ

In the case of the two analyzed Byzantine chants, the score – whether in Byzantine or in westernized notation – provided a guide for both the performer and the analyst³⁶⁴. In the particular case of Arabian *maqām* music, which is rich in both ornamentations and modulations³⁶⁵ – and is partly or mainly improvised in its traditional interpretations, undertaking a correct analysis could be much more of a challenge.

Indeed, Byzantine chant analyses may seem relatively simple when compared to analyses of *tajwīd*³⁶⁶ and *ādhān*³⁶⁷ in which ample variations of the pitch are consciously – and often – performed (Fig. 89).³⁶⁸ These difficulties are sometimes magnified by either a broader use of the vertical space (as for example in the chants by sheikh ‘Alī Maḥmūd) or, to the contrary, by a downsizing of this space – as with Muḥammad al-Ghazālī – which create both specific needs and necessitate particular techniques of analysis. In such cases, a static – or

³⁶⁷ See [Juynboll, 2012]. Note also: “The *adhan*, *athan*, or *azaan* (Arabic: أذان [ʔaˈðan]) (also called in Turkish: *Ezan*) is the Islamic call to worship, recited by the *muezzin* at prescribed times of the day. The root of the word is *ʾadhina* أَذِن meaning ‘to listen, to hear, be informed about’. Another derivative of this word is *ʾudhun* (أُذُن), meaning ‘ear’. *Adhan* is called out by a *muezzin* from the mosque five times a day, traditionally from the minaret, summoning Muslims for mandatory (*fard*) worship (*salat*)” – in [Wikipedia Contributors, 2018e].

³⁶⁸ See also examples of *tajwīd* and *ādhān* in the animated powerpoint slides proposed as an accompaniment to [Beyhom, 2014], and FHT 47 (Analysis of *hijāz* performed by Hafiz Hāni Karaca) and FHT 48 and 47 (analyses of *hijāz* by Bekir Sidqi Sezgin) – [p. 148-149] of the same reference. See also Slides nos. 2-6 in the PPS accompanying this dossier.

semi-static³⁶⁹ – analysis is often unsatisfactory while a video-animated analysis can often provide more complete information on the performance. In the particular cases of the two performances analyzed here,³⁷⁰ Al-Ghazālī is a *qārī*³⁷¹, and ‘Ali Maḥmūd a *shaykh*³⁷². Both use a very melismatic style, while both can equally hold notes with virtually no vibrato.

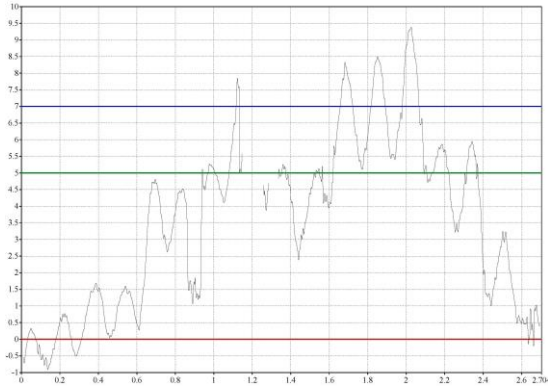

Fig. 89 Graphic analysis with Praat of a *hijāz genos* performed by sheikh ‘Ali Maḥmūd – from [Beyhom, 2014].³⁷³

To be able to analyze these chants a special set of graphic scales was created (examples provided in Fig.

³⁶⁹ The same way as for the “Animations with moving cursors and fixed graphs” seen above.

³⁷⁰ The two video-animated analyses of these chants – with a half-tempo version for each – are available at (<http://foredoifico.org/CERMAA/analyses/maqam-analysis>), and directly streamable as:

1. *Seven Maqāmāt* by Muḥammad al-Ghazālī (uploaded 10/10/2018): <https://youtu.be/Uc22jh65r0M> [Beyhom, 2018aj]
2. *Seven Maqāmāt* by Muḥammad al-Ghazālī – Half-tempo (uploaded 10/10/2018): <https://youtu.be/6TvK2keRZe4> [Beyhom, 2018ak]
3. *Ahlan bi-Ghazālīn* by sheikh ‘Ali Maḥmūd (uploaded 09/10/2018): https://youtu.be/s_Nsm4mzFns [Beyhom, 2018al]
4. *Ahlan bi-Ghazālīn* by sheikh ‘Ali Maḥmūd – Half-tempo (uploaded 09/10/2018): <https://youtu.be/3pbprgsRuRA> [Beyhom, 2018am]

³⁷¹ “A *qārī*” (Arabic: قارئ, plural قراء *qurrā*; English: ‘reader’) is a person who recites the Quran with the proper rules of recitation (*tajwīd*)” – in [Wikipedia Contributors, 2018c].

³⁷² See [Geoffroy, 2012]. Note also: “*sheikh* (jeik) or *sheik* (in Muslim countries) n[:] 1. (Government, Politics & Diplomacy) the head of an Arab tribe, village, etc. 2. a venerable old man [...] 4. (Islam) a high priest or religious leader, esp a Sufi master” – in [Anon. “sheikh”]. In general, [a] learned Islamic sheikh is a *ḥāfiẓ*: “*Sheikh*, also spelled *Sheik*, *Shaikh*, or *Shaykh*, Arabic *Shaykh*, Arabic title of respect dating from pre-Islāmic antiquity; it strictly means a venerable man of more than 50 years of age. The title *sheikh* is especially borne by heads of religious orders, heads of colleges, such as Al-Azhar University in Cairo, chiefs of tribes, and headmen of villages and of separate quarters of towns. It is also applied to learned men, especially members of the class of *ulamas* (theologians), and has been applied to anyone who has memorized the whole *Qur’ān*, however young he might be” – in [Anon. “Sheikh | Arabic title”].

³⁷³ Analysis available in Slide no. 2 of the accompanying PPS.

91 and Fig. 93) based on the theoretical – quarter-tone – division of the vertical space³⁷⁴.



Fig. 90 Photograph of sheikh ‘Ali Maḥmūd.³⁷⁵

The author’s solmization³⁷⁶ (Fig. 92) was extended (FHT 57:245), inspired by the denominations of the degrees of the “Modern Arabian” scale (FHT 54: 242 to FHT 56: 244).

³⁷⁴ Most probably the result of the influence of Western music (theory) on *maqām* theoreticians.

³⁷⁵ The provenance of this photograph is unknown. Extract from the biography of *Shaykh* ‘Ali Maḥmūd (translated in 2006 by Rosy Azar Beyhom from the *Wikipedia* corresponding entry in Arabic – further checked and translated to English by the author): “*Shaykh* ‘Ali Maḥmūd was born in 1878 in Cairo. He became blind due to an accident, when he was still young. He studied Koranic memorization under *shaykh* Abū Hāshim a-sh-Shibrāwī then the *tajwīd* and Koranic reading with *shaykh* Mabruk Ḥusnayn. After learning Koranic Sciences under *shaykh* Abd al-Qāder al-Maznī, he became famous in Egypt as a *qārī*’ (reader of the Koran). He acquired his musical knowledge under *shaykh* Ibrahim Al-Maghribī, and with the great singer ‘Abd a-r-Raḥīm Maslūb who taught him the *muwashshahāt*, performance on instruments and music composition. He also studied with *shaykh* ‘Uthmān al-Mawṣilī, of Turkish origin, who also taught him Turkish (Ottoman) music and its peculiarities. ‘Ali Maḥmūd’s celebrity as a *muṭrib* (profane singer), a *munshid* (religious singer – cantor) and a *qārī*’ (see fn. 371 and 372) can be ascribed to his very complete background in music and Koranic studies, however also to the fact that he was extremely gifted. It is said that he would perform the call to prayer on Fridays at the Al-Ḥusayn mosque in a mode that he would not use again before the year after. As First *munshid* in Egypt, he also had many students some of which became well known such as *shaykh* Muhammad Rifat, *shaykh* Ṭah al-Fishnī, *shaykh* Kāmil Yūsif al-Baḥtimī, *shaykh* Zakariyya Aḥmad as well as singers such as Muḥammad Abd al-Wahhab, Um Kulthūm and Asmahān. He died on the 21st of December 1946 leaving few recordings after him”.

³⁷⁶ The limited (to 7 notes per one octave) solmization was first proposed in [Beyhom, 2012].

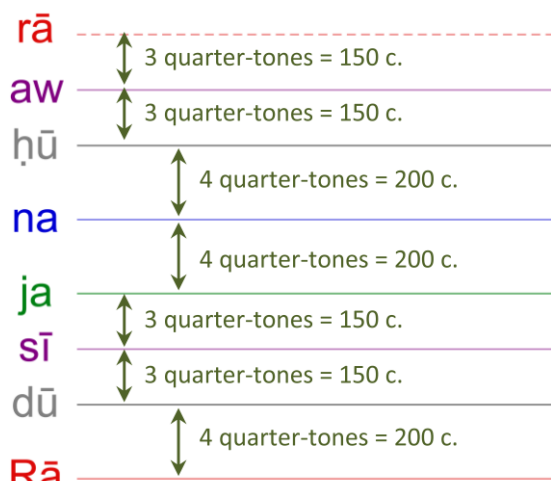

Fig. 91 Simplified octavial graphic – and theoretical – scale of *maqām Rāst* implemented in the video-animated analyses – with intervals in quarter-tones and equivalents in cents.³⁷⁷

KARDĀN	↔	rā₂	c'
AWJ	↔	aw₂	b^{hf}
ḤUSAYNĪ	↔	ḥu₂	a
NAWĀ	↔	na₂	g
JAḤĀRKĀ	↔	ja	f
SĪKĀ	↔	sī	e^{hf}
DŪKĀ	↔	dū	d
RĀST	↔	rā	c

Fig. 92 Solmization proposed for the middle octave of Arabian music by the author in 2012 – and Western equivalents. (“^{hf}” stands for “half-flat”).³⁷⁸

It is systematically used in the following analyses in order to simplify the process of pitch identification, together with the use of equivalent western (literal, relative

³⁷⁷ Names of notes (to the left – originally *RĀST* = c, *DŪKĀ* = d, *SĪKĀ* = e, *JAḤĀRKĀ* = f, *NAWĀ* = g, *ḤUSAYNĪ* = a, *AWJ* = b and *KIRDĀN* = c) follow the solmization proposed by the author in [Beyhom, 2012] with the “minus” (“-”) sign indicating an approximate quarter-tone lowering of the note. (1 equal-tempered quarter-tone = 1200 c / 24 = 200 c / 4 = 50 c.)

³⁷⁸ Previously published as [Beyhom, 2012, p. 68, Fig. 3].

³⁷⁹ *Ṣabā-Nahawand* is a neologism used to describe the (scale of *maqām Ṣabā* when a *nahawand* tetrachord is inserted on the upper *b^b* (as happens in the course of the performance of sheikh ‘Ali Maḥmūd at approx. 47 s in Fig. 98: 200 – see also Fig. 101: 200), instead of a *ḥijāz* tetrachord (262) on *d*. This case is described theoretically in [Erlanger, 1949, v. 5, p. 282] as a ‘*ajam* on *b^b*, which shows the differences of interpretation in *maqām* analysis. The scale

and altered as needed for the equivalence) degrees of the scale (to the right in Fig. 93).

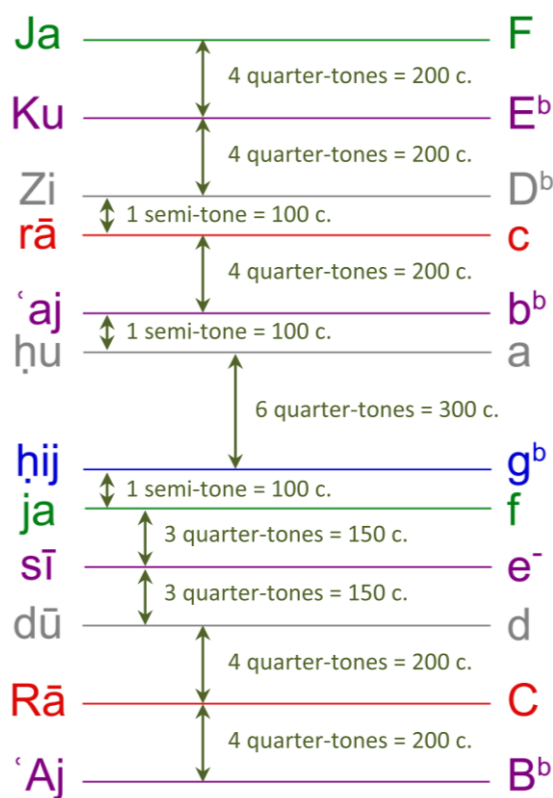

Fig. 93 (Non-dimmed) Right-side of the graphic non-octavial (based on *d*) – and theoretical – scale of *maqām Ṣabā-Nahawand*³⁷⁹ as implemented in the video-animated analyses with intervals in quarter- (or semi-) tones and cents.³⁸⁰

* * *

*Al-Ghazālī’s Seven Maqāmāt*³⁸¹ can readily be considered as an exercise of style in which the reciter shows his mastery of the complex modulations commonly used in Arabian *maqām* chant.

with upper *ḥijāz* tetrachord of the *maqām* could be termed – to differentiate it from the *Ṣabā-Nahawand* – as *Ṣabā-Ḥijāz*. (See also the analysis of *Ahlan bi-Ghazālīn* by sheikh ‘Ali Maḥmūd next.)

³⁸⁰ Names of notes (to the left – originally *QARĀR-‘AJAM*, *RĀST*, *DUKĀ*, *SĪKĀ*, *JAḤĀRKĀ*, *NAWĀ*, *ḤIJĀZ*, *ḤUSAYNĪ*, *‘AJAM-‘USHAYRĀN*, *KIRDĀN*, *SHAH-NĀZ*, *SUNBULĀ* and *MĀHŪRĀN*) follow the solmization proposed by the author in [Beyhom, 2012] and expanded in FHT 57: 245. Theoretic equivalents in Western notation are provided to the right, with the “minus” (“-”) sign indicating a quarter-tone lowering of the note.

³⁸¹ “Seven modes”, with the original video available at <https://www.youtube.com/watch?v=w1OYvFfpjeE>.

The video-animated analysis of this chant opens on an overall graphic description of the performance (approx. from 5 s_v to 11 s_v³⁸² – see also FHT 58) with the names and delineation of the scales of the different *maqāmāt* (in fact *ajnās*³⁸³ or *genī*).

The first observation is that – when relying on the conservatoire terminology in Arabian countries – the reciter uses the term *maqām* for *ajnās* and that he often announces a *maqām* but performs a variant or singles out a tetrachord in a scale. This happens with “*maqām*” *Sikā* which is in conservatoire terminology a *Sikā-Huzām*, i.e. a *Sikā* with an insertion of a *hijāz* tetrachord on *na* (*g* – see Fig. 94: 198, second frame from top), and with a “*maqām*” *Nahawand* (from 49 s_a to 52 s_a) which is in fact the upper *jins nahawand* of *maqām Kurd*.

A literal description of the performance could be:

The performer begins by announcing *maqām Rāst* on its (relative) tonic *RĀST* (*C*) then (from 2 s_a to 14 s_a) develops a *jins rāst*³⁸⁴ (*C 433* in relative – and approximate – multiples of the quarter-tone) then modulates (15 s_a to 25 s_a) to *maqām Sikā-Huzām* on its original tonic *SĪKĀ* starting with the sub-tonic *d* then developing a limited part of the scale *E 3426243*, namely *E 34[2]* in which the initial tri-chord *34* corresponds to a *sikā* on *E* and the *[2]* initiates the upper *jins hijāz g 262* of the scale. The next step (26 s_a to 42 s_a) consists of a modulation and a transposition, namely to *maqām Šabā* (originally on *DŪKĀ* or *D 3326244* in its octavial form) on the degree *SĪKĀ*, with a development of *jins šabā 332* including occasional inceptions of *jins hijāz 262* on the lower³⁸⁵ *g^b* or

c (34 s_a). Although the performer announces a “*Nahawand*” between 42 s_a and 48 s_a, this announcement is also undertaken in the scale of *maqām Šabā* – equally limited to the main (lower) tetrachord – with ample vertical descending variations (reaching the *hu* or central *g^b*) while concluding on the (transposed) tonic *DŪKĀ* (= *D*) on *AWJ = B*. In the following 33 seconds (49 s_a to 72 s_a) the performer develops *maqām Kurd D 24444244* transposed on original *SĪKĀ* (*E*), the scale of which consists in a *kurd* pentachord *D 24444* and a *nahawand* tetrachord *g 424[4]*. The following part (72 s_a to 108 s_a) is a *WIAIWYG*³⁸⁶ and consists in developments within the scale of *maqām Hijāz* (*D 2624244*) transposed on ‘*AJAM*³⁸⁷ = *B^b*. The performance is concluded by the development of the lower part of *maqām Bayāt* transposed also on ‘*AJAM*³⁸⁸.

As expounded above, the range of the performance is limited to one octave – with occasional limited leaps as (for example) at approx. 116 s_a – in the vertical space³⁸⁹, and with intricate modulations due to transpositions of the modes.

Obviously, such a literal description – which could correspond to aural teaching of *maqām* music³⁹⁰ – will not suffice for the purpose of complete analysis of the melody.

The video-animated analysis provides, on the other hand, a compact and complete description of the melodic contour³⁹¹ of the performance along with the listening to the performance itself.³⁹²

³⁸² “s_v” is used for video-time (time as given by the video-player) while “s_a” is used for analysis-time (time as shown on the graphic analysis).

³⁸³ The *ajnās* correspond to particular performances of polychords in a given repertoire. The range of the *jins* (singular of *ajnās*) is generally wider than the range of the polychord as such; this is why, in the following video-animations, a *jins šabā* can be described as composed from the successive (rising) intervals 332[6] meaning that the *šabā* tetrachord on *d* – scale notes are all relative to the current tonic – is composed from the initial intervals 3, 3 and 2 (quarter-tones) and uses the upper one-and-half-tones interval “6” – initially the central interval of the *hijāz* tetrachord on *f* (“*ja*” in the Arabian solmization recommended by the author) as a complement in the realization of the *jins*.

³⁸⁴ The upper and lower cases lettering differentiates (the scale of) *maqām Rāst* (initial uppercase) from the tonic (pitch) *RĀST* (uppercase) and from the polychord (or *jins*) *rāst* (lowercase).

³⁸⁵ The vertical space for the description of this performance of *maqām* music is divided in three parts: the central octave (or near-octave in this case), the lower octave and the upper octave.

³⁸⁶ “What Is Announced Is What You Get”.

³⁸⁷ In fact on *AWJ = b*, but it seems to the author that the intended transposition pitch was on ‘*AJAM*.

³⁸⁸ See previous footnote.

³⁸⁹ In practice this would be the octave from lower ‘*Aj[am]* = *A* to its octave ‘*aj = a* if the initial *Rā = C* is to be taken as the reference pitch.

³⁹⁰ And which could be developed in such a way as to include most of the details of the performance – but this would be very time consuming as well as not as efficient as the video-animated analysis itself.

³⁹¹ With comments added in parallel to help with the identification of the *ajnās* used in the performance.

³⁹² The mastery of this *qārī* for these modulations and transpositions cannot be described by the analysis, but only appreciated by listening to the performance and understanding what happens in its course: the video-animated analyses are of great help for such a purpose. Note also that, as for the aforementioned video-analyses of *Kyrie Ekekraxa* performed by Bachir Osta, a half-tempo version – with quality audio – is proposed for al-Ghazālī’s 7 *maqāmāt*.

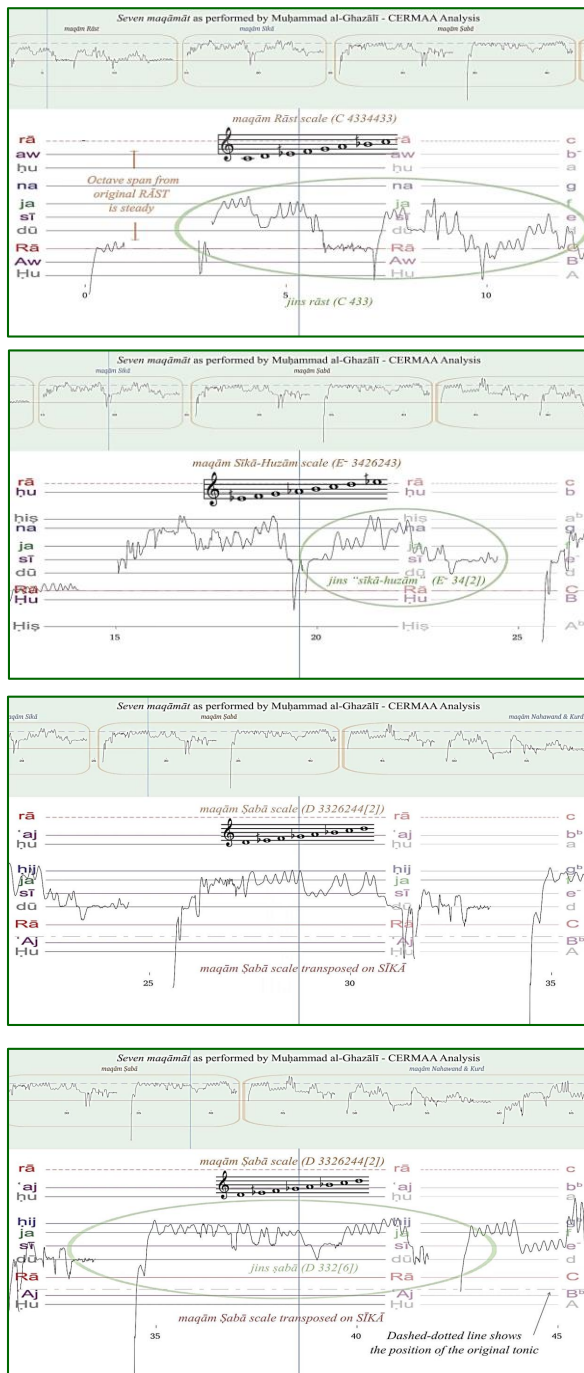

Fig. 94 Four frames from the video-animated analysis of 7 maqāmāt as performed by the qārī³⁹³ Muḥammad al-Ghazālī.

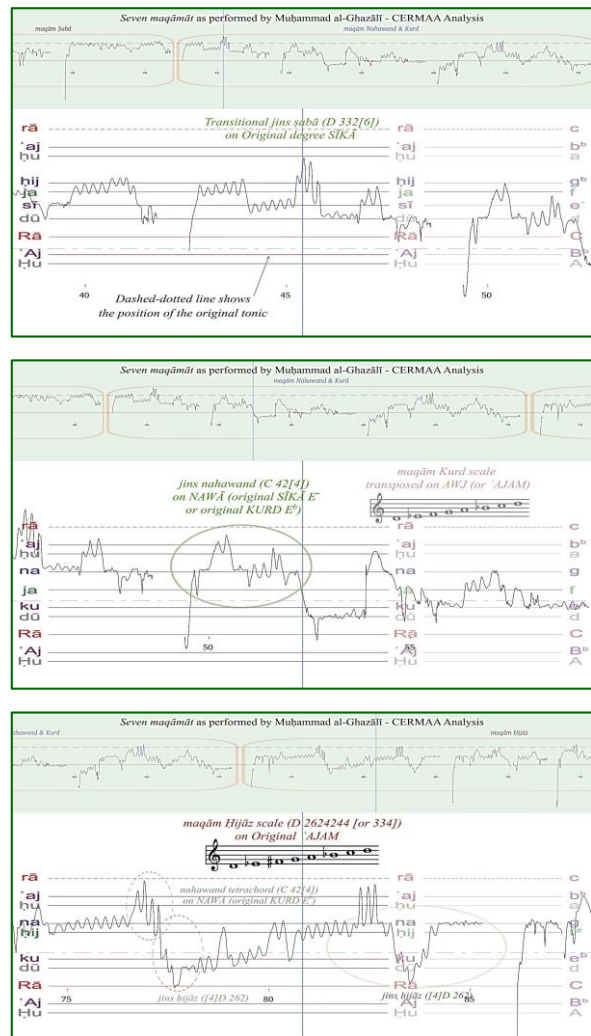

Fig. 95 Three frames from the video-animated analysis of 7 maqāmāt as performed by the qārī³⁹³ Muḥammad al-Ghazālī.³⁹³

This is also the case with *Ahlan bi-Ghazālīn* by sheikh ‘Alī Maḥmūd³⁹⁴ which is the first – solo – part of a hymn performed by a choir.

The date of the recording is unknown³⁹⁵ and the bad quality of the recorded copy – as with most old recordings of Islamic cantors – compelled the author to undertake a light clean-up of the recording prior to the analysis with Praat in such a way as to lower the background noise without, however, altering the melodic line.

³⁹³ The near-leap of fourth (descending) at 52.5 s a (central frame) is in fact structured in five different pitches when listening to the excerpt at decreased speed – namely at 16th tempo, which necessitates a specific handling of the audio recording.

³⁹⁴ <https://youtu.be/3pbprgsRuRA>.

³⁹⁵ Evidently to the author, but it is before (or till) 1946, year of the death of Maḥmūd.

The interpretation of the results of the analysis by Praat took some time as no prior knowledge of the structure of the performance was known to the author except that it was performed in *maqām Šabā*.³⁹⁶

The performance starts directly with *jins šabā* (till 11 s_a) then with an inception of *jins hijāz* on *ja = f* (14.5 s_a to approx. 19 s_a – Fig. 96). It is followed by an extended development of *jins šabā* till 28 s_a with a second inception of *hijāz* then *šabā* till approx. 37 s_a (Fig. 97).

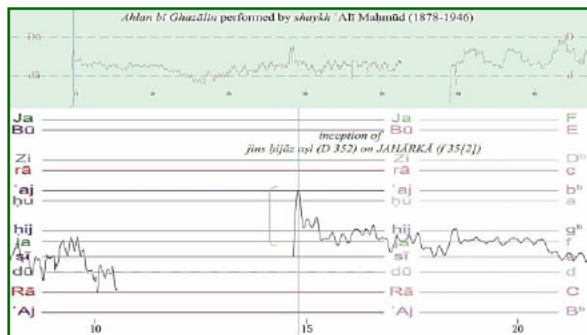
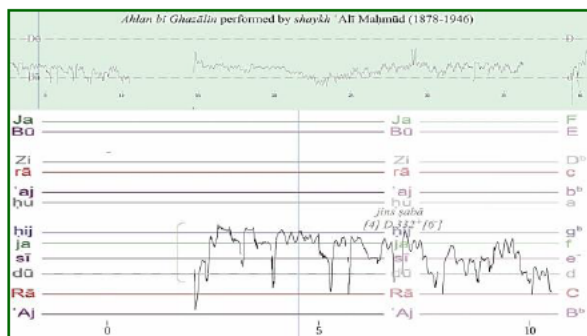

Fig. 96 Two frames from the video-animated analysis of *Ahlan bi-Ghazālīn* performed by sheikh 'Alī Maḥmūd, showing the initial *jins šabā* followed by *jins hijāz* on *ja = f*.

This is followed by the development of (what the author names) a *jins hijāz-mazmūm* – due to the use of somewhat “inwards” extended bordering “semi-tones” of the tetrachord – then by the inception of a *jins nahawand* on *'aj = b^b* followed in descent by alternated *hijāz* on *ja = f* and *šabā* on *dū = d* (ending around 53.5 s_a – Fig. 98).

³⁹⁶ The author relied on a loose analysis by Rosy Beyhom for her Master Thesis in 2006 and on the help of *maqām* connoisseur and 'ūdīst – as well as friend and Director of the department of musicology in the Music Institute of Tunis (ISM de Tunis) – Hamdi Makhlouf from Tunisia. Note however that the conclusive analysis was established by the author, which relieves both Makhlouf and (Rosy) Beyhom from any responsibility in possible errors of interpretation (analysis).

Having thus developed the (non-) octavial scale of *maqām Šabā* (Fig. 99), Maḥmūd reminds the auditor of the importance of *jins hijāz* (by singling it out as shown in Fig. 100 – around 60 s_a) and undertakes then a long development of *jins nahawand* [4]424[4] on *g* initiated with a leap of octave – at 64.5 s_a – between (lower) *'Aj[am] = B^b* and (upper) *'aj[am] = b^b* (Fig. 101).³⁹⁷

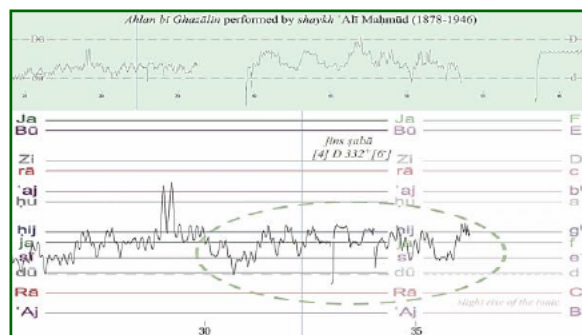

Fig. 97 Two frames from the video-animated analysis of *Ahlan bi-Ghazālīn* performed by sheikh 'Alī Maḥmūd.³⁹⁸

The next *jins 'ajam* is also initiated by a (nearly imperceptible) leap of octave between *'Aj = B^b* and *'aj = b^b* immediately followed by a downwards leap of fifth to *ja = f* while, between 87.5 s_a and 91 s_a, the performer uses the upper *rā = c* as a temporary rest note paving the way to the inception of an upper *hijāz* on the same degree (Fig. 102) and reaching the (upper) *Ja = F*, which completes the scale of *maqām Šabā* as such (Fig. 103).³⁹⁹

³⁹⁷ Tetrachord *nahawand* (“minor”) is 424, here based on *g*. The added bordering [4](s) indicate an extension of (at least) one whole tone of the tetrachord (in both directions), during the development of the *jins*, beyond its tetrachordal borders.

³⁹⁸ These show the extended development of *jins šabā* till 28 s_a with a second inception of *hijāz* then *šabā* till approx. 37 s_a.

³⁹⁹ This is further explained in the synthesis of this analysis.

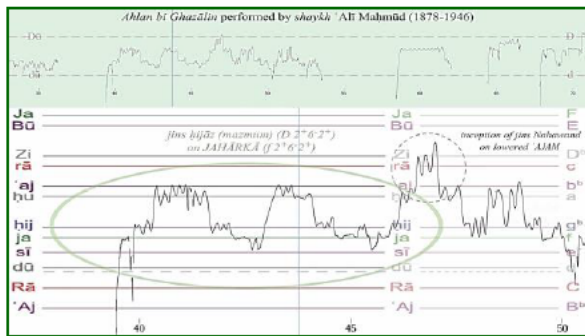

Fig. 98 Two additional frames from the video-animated analysis of *Ahlan bi-Ghazālīn* performed by sheikh 'Alī Maḥmūd.⁴⁰⁰

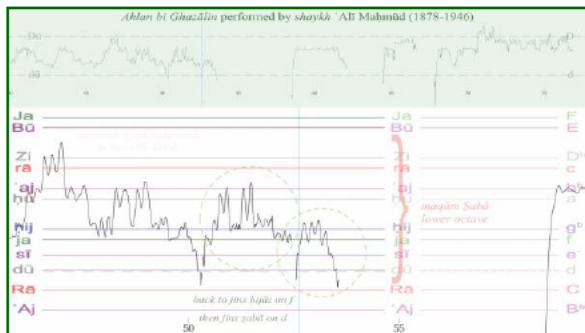

Fig. 99 Frame from the video-animated analysis of *Ahlan bi-Ghazālīn* performed by sheikh 'Alī Maḥmūd, showing the effective use of the non-octavial scale (from $dū = d$ to $Zi = D^b$) of *maqām Ṣabā*.

Note that the range of the whole performance appears clearly on Fig. 102 and Fig. 103 – from (lower) 'Aj = B^b to (upper) Ja = F (one octave plus fifth).

⁴⁰⁰ These show the development of *jins hijāz-mazmūn* followed by the inception of a *jins nahawand* on 'aj = b^b followed in descent by alternated *hijāz* on ja = f then *ṣabā* on $dū = d$.

⁴⁰¹ This takes place between 'Aj = B^b and 'aj = b^b and the beginning of the development of *jins nahawand* [4]424[4] on g.

⁴⁰² This frame shows the (nearly imperceptible) leap of octave between 'Aj = B^b and 'aj = b^b followed by a downwards leap of fifth

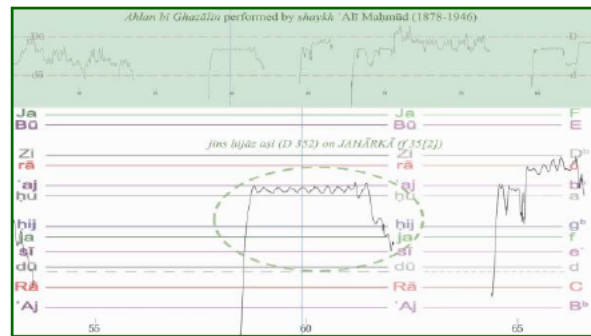

Fig. 100 Frame from the video-animated analysis of *Ahlan bi-Ghazālīn* performed by sheikh 'Alī Maḥmūd in which the performer singles out *jins hijāz* to remind the auditor of its importance in the performance of *maqām Ṣabā*.

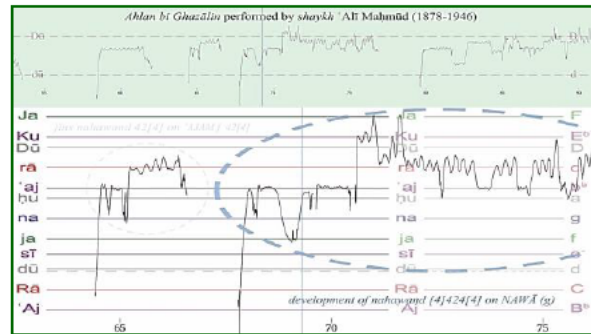

Fig. 101 Frame from the video-animated analysis of *Ahlan bi-Ghazālīn* performed by sheikh 'Alī Maḥmūd, showing a (nearly imperceptible) leap of octave.⁴⁰¹

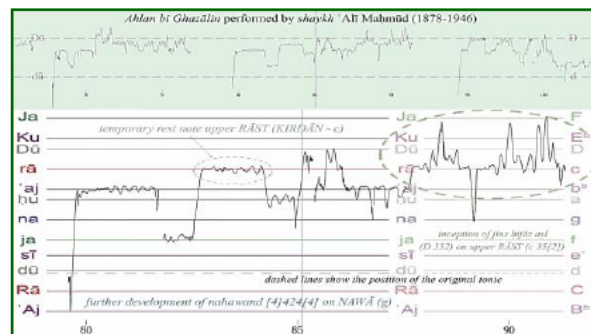

Fig. 102 Frame from the video-animated analysis of *Ahlan bi-Ghazālīn* performed by sheikh 'Alī Maḥmūd.⁴⁰²

This is followed (centered on 95 s_a – Fig. 103 and Fig. 104) by another double leap of (1) octave (still from 'Aj = B^b to 'aj = b^b) then (2 – “minor”) third ('aj = b^b to Zi = D^b) then by the complete descent of the scale

to ja = f, and the use of the upper rā = c as a temporary rest note paving the way to the inception of an upper *hijāz* on the same degree.

till the tonic $dū = d$ (at approx. 116.5 s_a – Fig. 104 and Fig. 105).⁴⁰³

The next developments (120 s_a to 150 s_a) consist in subtle back and forths between *jins nahawand* 424 on $na = g$ and *jins ‘ajam* 442 on $‘aj = b^b$ (Fig. 106).⁴⁰⁴

A descending *nahawand* arpeggio (modulation) at 148–150 s_a, preceded by a leap of near-octave between $Rā = C$ and $‘aj = b^b$ and by an ample *jins ‘ajam* with double descent in thirds between 144 s_a and 146 s_a (Fig. 107), initiates finally the complete descent of the scale of (what the author terms) *maqām Šabā-Nahawand* until the tonic $dū = d$, with a closing slip – for this solo performance which precedes the choir performance – on $Rā = C$ (end at 161 s_a – Fig. 108; compare with the closing *jins šabā* in Fig. 105).

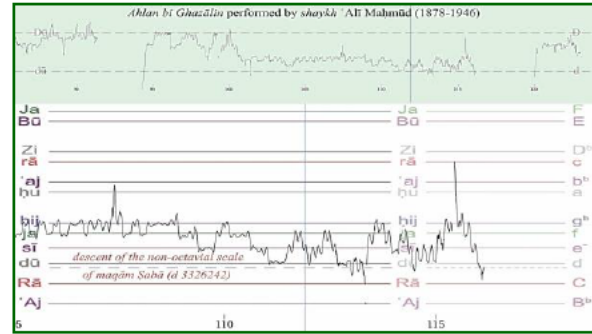

Fig. 105 Frame from the video-animated analysis of *Ahlān bi-Ghazālīn* performed by sheikh ‘Alī Maḥmūd, showing the continuation of the complete descent of the scale till the tonic $dū = d$ with the closing *jins šabā*.

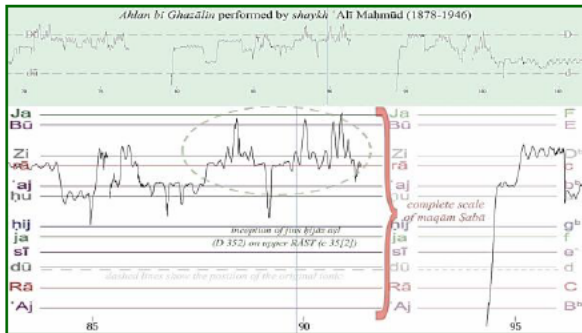

Fig. 103 Frame from the video-animated analysis of *Ahlān bi-Ghazālīn* performed by sheikh ‘Alī Maḥmūd, showing the complete scale of *maqām Šabā*.⁴⁰⁵

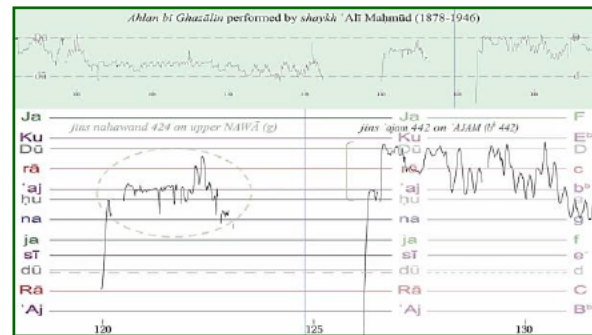

Fig. 106 Frame from the video-animated analysis of *Ahlān bi-Ghazālīn* performed by sheikh ‘Alī Maḥmūd, showing the beginning of the process of back and forths between *jins nahawand* 424 on $na = g$ and *jins ‘ajam* 442 on $‘aj = b^b$.

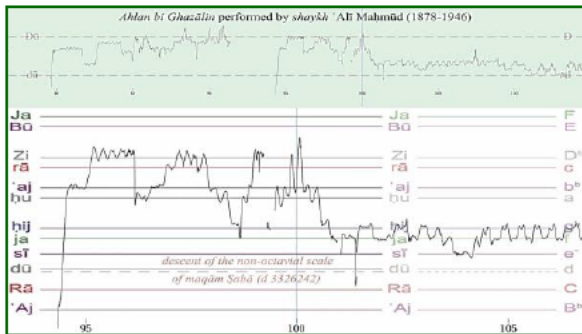

Fig. 104 Frame from the video-animated analysis of *Ahlān bi-Ghazālīn* performed by sheikh ‘Alī Maḥmūd.⁴⁰⁶

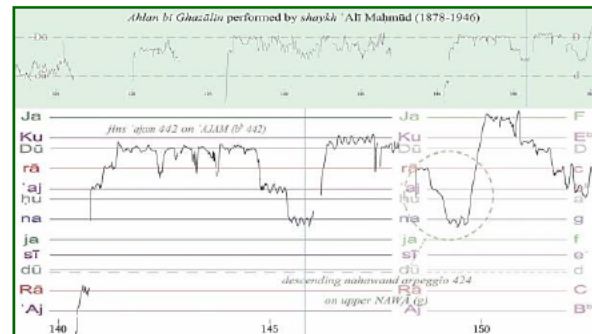

Fig. 107 Frame from the video-animated analysis of *Ahlān bi-Ghazālīn* performed by sheikh ‘Alī Maḥmūd, showing the leap of near-octave between $Rā = C$ and $‘aj = b^b$ and the descending *nahawand* arpeggio between 148 s_a and 150 s_a.

⁴⁰³ Note the closing – near-instantaneous and descending – *jins šabā* (around 116 s_a) with a downwards leap of “augmented” fourth from $rā = c$ to $hij = g^b$, and a “slip” below the $dū$ at the end.

⁴⁰⁴ The global scale (here of *nahawand* on *NAWĀ* or *na* 424424[4]) remains the same: the two *ajnaḥs* are solely differentiated through the insistence on parts of this scale and formulaic turns.

⁴⁰⁵ The scale is completed by the inception of the upper *hijāz* on $rā = c$.

⁴⁰⁶ This frame shows the double leap of octave (from $‘Aj = B^b$ to $‘aj = b^b$) then (2 – “minor”) third ($‘aj = b^b$ to $Zi = D^b$) and the beginning of the complete descent of the scale till the tonic $dū = d$.

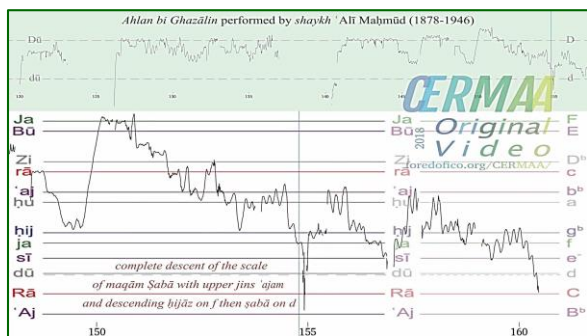

Fig. 108 Frame from the video-animated analysis of *Ahlan bi-Ghazālīn* performed by sheikh ‘Alī Maḥmūd, showing the complete final descent of the scale of *maqām Ṣabā-Nahawand* until the tonic $dū = d$, with a closing slip on $Rā = C$.

* * *

There are many observations which can be made following this (slightly) detailed chronological analysis of the development of *Ahlan bi Ghazālīn* by sheikh ‘Alī Maḥmūd.

The first observation is that “What You See Is [Not] What You Get”.⁴⁰⁷ Whenever the melodic line seems crystal clear when attentively listening to the performance and when scrutinizing in parallel – equally attentively – the sequence of events on the moving graphic, few details may seem difficult to grab – in the case of Maḥmūd and in this performance the octave (or near-octave) leaps. Repeated reviews of these excerpts are the rule, with occasional verifications of the analyst’s interpretations in the half-tempo version provided with the original video-animated analysis.

The author wishes to underline here the fact that, although these characteristics of the performance were not clearly distinguishable at the beginning of the analysis (and without it), these became perceptible after the analysis when listening to the bare performance.⁴⁰⁸

The second observation is about the striking differences in the techniques used by this performer when

compared to the techniques used by al-Ghazālī in the previous analysis, notably in what concerns the frequent use of ample leaps of octave, fifth, fourth and third by Maḥmūd whenever Al-Ghazālī, in the analyzed performance, uses mainly conjunct seconds⁴⁰⁹ with frequent yodels of thirds and a very limited number of leaps of fourth⁴¹⁰.

The third observation concerns the nearly imperceptible⁴¹¹ small slips from the tonic which are frequent with Maḥmūd, together with the near-instantaneous delineation of closing *jīns ṣabā* as can be noted in Fig. 105: 201 and Fig. 108.

All these techniques underline the mastery of this performer and the complexity – and uniqueness – of each interpretation, far from the standardization and reduction of score notation.

FURTHER PERSPECTIVES FOR VIDEO-ANIMATED ANALYSES

There remains here to answer Nettl’s prediction about the future of ethnomusicological analyses of pitch, saying that “automatic analysis” did not become, at his time, as pervasive as it could have been predicted, and that it would merely be used in the future as an aid for aural transcription in western notation.⁴¹²

While this seems to have become a self-fulfilling prophecy,⁴¹³ let us examine some facts.

Firstly: what we are dealing with here – video-animated analysis of the VIAMAP – has nothing to do with “automatic analysis”: the only part that may elude the musicologist is the preliminary analysis with Praat, but this is far from being “automatized”.

Secondly: before undertaking an analysis a complete survey of the musical piece is often necessary, with a preliminary analysis of the content – especially in what concerns other instruments or sounds not related to the melody as happens often in old *maqām* recordings. For the latter recordings, background noise is sometimes also an issue, and may have to be reduced for Praat (or

this leap of fourth as separate pitches. Note also that such a treatment of the intervallic leaps performed by Maḥmūd was not undertaken for this dossier.

⁴¹¹ But which amount to one whole tone according to the graphic analysis.

⁴¹² [Nettl, 1983, p. 80–81].

⁴¹³ Nettl’s closing argumentation for his chapter on transcription resembles a little too much to List’s argumentation expounded in Part I of this dossier to exclude his total opposition to what he calls “automatic transcription”.

⁴⁰⁷ To paraphrase Wim Van der Meer in “What You Hear Isn’t What You See...” – [Meer and Rao, 2006].

⁴⁰⁸ This is precisely the process by which an amateur becomes a connoisseur of a certain music.

⁴⁰⁹ Which is also the case with Maḥmūd.

⁴¹⁰ However, and as noted in fn. 393, even the descending leap of fourth from $na = g$ to $dū = d$ at approx. 52 s a in Ghazālī’s performance (central frame in Fig. 95) becomes structured by 5 different pitches when listening to the excerpt – as the author undertook for verification – in 16th tempo (16 times slower). This does not necessarily mean, though, that it was the performer’s intent to perform

any other graphic pitch analyzer) to be able to handle the analysis properly.

Moreover, Praat provides the analyst with a mere educated guess: at some points, an octave – or fifth, octave + fifth etc. – error creates discrepancies and must be corrected – whenever possible.⁴¹⁴ Furthermore, some of the parameters of the program must sometimes be adapted for a particular analysis: the ear is the final judge of the pertinence of the computer analysis, and of the corrections brought by the analyst.⁴¹⁵

Further improvements – such as the use of moving⁴¹⁶ (and different) scales according to the song or music, the type of motion and the scaling of the graphic etc. – are completely Man-made, meaning that decisions are in this process taken by the human analyst, not by the computer or the program.

Finally, in this complex process (which is an art as much as it is a science), the “automated” part is reduced to its bare bones: it is a simple basis on which the analyst constructs an interpretation of the results which reflects, eventually, his own – or his culture’s – understanding of the music. However, and while this type of analysis can be as subjective as score notation, it is far more superior to it in terms of accuracy, reliability and – at least with *maqām* music – adequacy to the music culture it analyses.

So if Nettl meant by “automatic analysis” the results of the Melograph in his time, neither the analyses proposed here are automatic, nor is the graph the final result of the analysis. It is a tool, used in conjunction with other tools and means of representation in the aim of providing an integrated – and an immediately understandable by the musicologist⁴¹⁷ – analysis of a song or a melody.

However, and if by “automatic analysis” Nettl meant the replacement – or the adjacent use – of score notation with the graphic representation provided by tools such as the Melograph or Praat, there can be no doubt whatsoever that such representations are much more accurate, informative and convincing than score notation. Which raises the question, once again, of the misuse of this score notation for the analysis of *maqām* or other non-Western musics.

*
* *

While it is clear that video-animated analyses, together with the handling – mainly the down-speeding – of the audio recording, provide a complete set of tools for understanding and – eventually – for teaching traditional⁴¹⁸ *maqām* music, one stunning observation is that this type of analyses mostly takes place in parallel to the production of the video, and that the technicalities involved in such approaches are necessitated by the analysis itself.

In other words, the amount of technological implementations in an analysis derives from the complexity and peculiarity of each analyzed song, melody or music piece. The corollary of the last statement is that one standard procedure cannot be applied to all types of performances – be they all acapella or not.⁴¹⁹

Another – paradoxical – observation is that the technical knowledge involved in such analyses is far from excessive, although the use of a few different computer programs may be required at different steps of the analytical and production process.⁴²⁰

⁴¹⁴ Sometimes the program would not even give a hint of the possible pitch, which leaves the analyst with two choices: either to repeat the analysis with other parameters possibly more adapted to the specific song or music, or to accept the limitations of the program and proceed further on.

⁴¹⁵ All these steps are explained – and for some of them detailed – in aforementioned articles by the author, and were further expounded to the participants in the workshops he has directed for nearly two decades.

⁴¹⁶ Scales are displaced vertically “by hand”: this means that it is the choice of the analyst when and how to displace them in order to follow the movement of the intervals. The computer or program has nothing to do with this process: they simply apply whatever position of the scale the analyst chooses.

⁴¹⁷ If he is ready to “hear” the music.

⁴¹⁸ And by this I mean non-westernized, non-polyphonic, non-tempered, etc. *maqām* music.

⁴¹⁹ One example of such differences is the different ranges of the analyzed music, as with Al-Ghazālī and Maḥmūd.

⁴²⁰ This means that the amount of technicality needed to produce such video-analyses is, on the whole, surprisingly small, as it is limited to the basic understanding of the functionalities of each program needed for the said procedure. As for the programs in use, these are – until today – (1) a(ny) word processor (see <https://alternativeto.net/software/libreoffice-writer/> accessed 12/07/2018 – as for all links below), (2) an(y) image editor (see <https://alternativeto.net/software/krita/>), (3) a versatile score maker such as MUS2 (see <http://www.mus2.com.tr/en/>) with an alternate possibility (see <https://musescore.org/> and <https://alternativeto.net/software/>

The main requirement for such analyses remains, however, the understanding and the respectful approach of the music: as with the study of treatises from the past, the first assumption of the analyst must be that the author – be him a writer, a theoretician, a composer or a performer – knows what he is doing and is doing it in a certain way for a definite purpose.

It remains then for the musicologist (the “analyst”) to identify the particular needs for a particular analysis of a particular musical piece. These needs determine the techniques which should be used in the analysis – which are today rather at hand for most musicologists.⁴²¹

However, knowing that technical background is unfortunately far from being the first requirement for the enrolment of students – or for the teaching – in (ethno) musicology today, and that musicological requirements in many musicological institutes are limited to considering music as a science, and musicology as part of the humanities – so to say “not a science”, it seems that a

musescore/) – which however, while proposing a rich palette of accidentals (see figure below), doesn't add non-conventional accidentals but allows for creating non-conventional key signatures.



To these first three programs we should add (4) a(ny) vector graphics editor (see <https://alternativeto.net/software/vectr/>), (5) an(y) audio production tool (see <https://alternativeto.net/software/audacity/>), (6) Praat (see <http://www.fon.hum.uva.nl/praat/>), (7) a video editor (see <https://alternativeto.net/software/kdenlive/>), (8) a(ny) digital visual effects, motion graphics, and compositing program (see <https://alternativeto.net/software/audacity/>) and (9) possibly a(ny) computer program for music production/recording with support for VST plugins (see <https://alternativeto.net/software/lmms/>). Note that while the author aims at not publicizing particular programs, the choice of Praat is expounded in this dossier and in previous – aforementioned – publications; as for MUS2, its low cost and its value for money is unmatched – including for the purpose of the video-analyses expounded in this dossier – from the point of view of the author since he first began to use it in the 2000s. This makes these two programs at least advisable although alternatives exist both as freeware and as commercial programs.

⁴²¹ Technical difficulties can always be overcome as online help is ubiquitous today in the internet or – as in the famous song – “With a little help from my friends”. In the case of the author initial help came willingly from Wim van der Meer and from Kabalan Samaha, a musician and graphic designer in Lebanon.

radical evolution in the way of understanding, teaching and promoting musicology must take place.

In what concerns the future of video-animated analyses as such, and while the scope of the VIAMAP is being slowly extended to cover other musics as *maqām*,⁴²² there are still a few – other – problems to be solved:

- The first – and most general – problem is the feasibility of graphic analyses of Multi-instrumental/voices music.

Although Praat and other programs allow for a limited separation of different “voices” (instruments) based on their characteristics – this being done mainly through the narrowing of the range of the analysis to fit the range of a particular instrument⁴²³ – this solution is impractical whenever there are two or more instruments in the same range – not speaking of instruments in the same range and with similar tone-colors.⁴²⁴ The author

⁴²² A new series of video-analyses was for example initiated for Breton music (Brittany – France) with the audio fund *DASTUM*, starting with the traditional song *Ar bern plouz* by Manu Kerjean, with two analyses up to date – numbered 1-2 – published at <http://fore-dofico.org/CERMAA/analyses/breton-music>, and featuring a third-tempo analysis:

1. “Ar bern plouz” chanté par Manu Kerjean à Bonen (22) éd. Dastum: *Manu Kerjean Chanteur du Centre-Bretagne* DAS153 (piste 15); uploaded 11/10/2018: <https://youtu.be/IIERM9mEw9g> [Beyhom, 2018an]
2. “Ar bern plouz” chanté par Manu Kerjean à Bonen (22) éd. Dastum: *Manu Kerjean Chanteur du Centre-Bretagne* DAS153 (piste 15 – Tempo = 1:3); uploaded 11/10/2018: https://youtu.be/oslJy0P_snu [Beyhom, 2018ao]

To differentiate these analyses from other analyses by CERMAA which are more *Maqām*-oriented, the background and lettering colors have been changed to blue(ish) and yellow(ish), and the cursors colors to tones of red. Other analyses are underway for solo instruments and include for example graphs of the intensity of the sound in parallel to the graph of the pitch.

⁴²³ For example with two instruments playing an octave – or more – apart, provided that their ranges do not overlap; or for two instruments with a rather important difference in acoustic intensity, which allows also to filter some of the input.

⁴²⁴ While this is a technical question, note that instruments with resembling spectrums of sound (tone-colors) – such as the instruments of the symphonic orchestra – are the most difficult to differentiate one from another (unless by their range), and typically with mechanical or electronic means as explained in [Plomp, 2002, p. 12]: “The ear distinguishes between frequency components originating from different sound sources, as opposed to components from the same source. It separates out components according to the first category, but not the second. This calls for an extremely sophisticated process, exceeding by far the performance of any frequency

hopes that further developments of pitch-measuring programs and sound-analysis softwares will allow for this type of analysis in the near future.⁴²⁵

- In the case of multi-vertical space musics (with different registers of voices and/or instruments), a graphical solution must be found to show both (or more) instruments on the same video.⁴²⁶

This is a technical complication that could be solved by integrating the different ranges in one pane, by changing the colors of the graphic analysis for each instrument, and by adding a visual marker for the range of each instrument.⁴²⁷

- Video-analyses, although not complex technically, still require the practice of different programs that aren't necessarily connected between them, and which for most of them aren't even connected directly with pitch analysis of music.⁴²⁸ This will still prevent students – especially those having no or seldom technical background – from taking interest in undertaking such analyses.

analyzer designed for acoustical research, in that auditory perception involves *synthesis* as well as analysis”.

⁴²⁵ At a conference in Paris in the beginning of the 2000s, Simha Arom declared that scientists and programmers with which he worked were on the brink of succeeding at such analyses. Alas! I have never heard of such developments since, which could be caused by our present inability to reproduce the process of synthesis of the ear (see previous footnote).

⁴²⁶ By this is intended live recorded music, and not only separately recorded instruments mixed together in a studio.

⁴²⁷ A prototype of such an analysis is being prepared as this article is being edited for publication.

⁴²⁸ The most striking example being Praat which is a program intended for phonetics, and not for music analysis.

⁴²⁹ Wim van der Meer raised here two noteworthy questions (personal communication): “One thing that crossed my mind is the relation between the x and y axes. After all, this is something totally arbitrary, we can compress the melodic line in time or expand it. This is another aspect of how we see what we hear. [On the other hand,] [m]any people, including the musicians we worked with, had problems with the jittery melodic lines, where they would expect them to be more smooth—or if you like, because they hear them more smoothly. To this day I am not entirely certain about the jittery appearance of melodic lines. What happens there? Is it

Although workshops and training courses can be – and are – proposed to teach (ethno) musicologists to undertake a preliminary analysis of the music, then prepare the subsidiary tools for the video-analysis and put them together before editing the video as such, this is an unsatisfactory solution in the long run. The ideal solution would be to create (build, program) an integrated tool (computer program) which would help making such video-animated analyses a standard tool in ethnomusicology and in autochthonous *maqām* musicologies.⁴²⁹

CONCLUSIONS

Musicology as we know it today is probably the most conservative humanity in the world – be it for musicology itself or for ethnomusicology.⁴³⁰ One first error of Western musicology was to consider score notation as a scientific tools for the analysis of music. One main second error was the use of this tool for the analysis of “Foreign” musics.

Whenever classical musicology may continue to go round in the same vicious circle, ethnomusicology cannot evolve without resolving its original sin, its inability to understand foreign musics otherwise than by examining them through the lens of Western notation and Pythagorean pseudo-science.

really there and do we smooth it out in the ear or the brain? Or is it an artifact of the computer?”. The first question (about shrinking and expanding melodic lines with seemingly the same intervals – a frequent case in traditional acapella singing for example) can be solved by shrinking and expanding the scale accordingly (a technical – and practical – way for doing so while keeping trace of the original scale is still to be determined). As for the second question, different parameters (variables) can intervene in the process of jittering (be it as the result of our perception or because of the programming algorithms or their implementation): I have yet – as with Wim – no definite answer to this question.

⁴³⁰ While there has been some progress in the analysis of “Foreign” musics since Hombostel and Abrahams (and with them for the use of recorded music in comparative musicology), these advances are still limited to few specialized individuals. The discipline as such, as noted by Hood commenting the dismantling of Seeger’s Melograph C, is still going in circles in what concerns graphic analysis of pitch and its further developments. Note also that while other aspects of analysis (paradigmatic, “sequencing”, synoptic analyses) have also been developed, there has not been an effective (and generalized) further questioning of the role of score notation in ethnomusicology.

If we refer to Nettle's discussion of the problem of aural perception *versus* graphic analysis of music:

"one of the issues [of graphic analysis of music] may be the degree to which the kind of distinctions that [we] could draw can be heard by the human ear. There is the typical dilemma: If the distinctions can be made by ear, why does one need the melograph? And if not, are we justified in assigning significance to them?"⁴³¹,

the answer to this dilemma is simple: if one cannot "hear", this occurs mainly because one has not trained his ears to hear subtleties or nuances of the melody – or did not wish to do so.⁴³² However, and while our hearing is impaired by decades – if not centuries – of aural indoctrination, we are compelled to use a hearing aid in order to understand – and eventually learn to hear – these subtleties, which are an integral part of the art of the *maqām*, and of other musics around the world.⁴³³

While this is a question debated for centuries in Western music,⁴³⁴ the persistent doubts of ethnomusicology, and its reluctance – if not its inability – to break away from its musicological womb and score notation have crippled the discipline on the long term. It is vital today for both ethnomusicology and autochthonous musicologies to cut the umbilical cord with musicology.

In order to do so, even more effective replacement methods of analysis must be created to supersede it.⁴³⁵

Far from proposing a musicological "Atlanta compromise", the author believes in the necessity of such an alternate way of understanding and analyzing autochthonous musics, to which the present dossier aims to be a contribution, a further stone for the foundation of an alternate analytical musicology which could be (or become) part of what Meer calls Cultural musicology.⁴³⁶

*
* *

⁴³¹ [Nettl, 1983, p. 80].

⁴³² Nettle's remarks – and commitment to score analysis – become even more surprising when remembering that he was a specialist of Iranian music – one of the main subdivisions of *maqām* music. It is also worthwhile here to remind of Cook's reflection on the role of music education in the training of the hearing of musicians (and musicologists?) quoted in the conclusions of Part I of this dossier.

⁴³³ In a private communication, Wim van der Meer explained: "when we hear things in slowed down mode that we don't hear in normal speed there may be a Nettle question raised. On the other hand, I am convinced that the musical mind of top musicians works 5 times faster and more accurate than that of the average listener and up to 10 times faster than that of the average ethnomusicologist".

⁴³⁴ Remember Rousseau: "In order to put the Reader in a position to judge the various musical Accents of Peoples, I have transcribed a Chinese Tune taken from Father du Halde, a Persian Tune taken from the Chevalier Chardin, and two Chansons of the American Savages taken from Father Mersenne. A conformity of Modulation with our Music will be found in all these pieces which will possibly make some admire the goodness and universality of our rules, and for others will perhaps render suspect the intelligence or the fidelity of those who have transmitted these Tunes to us. (As translated in [Rousseau and Scott, 1998, p. 444–445] and quoted in [Meer and Erickson, R., 2014, p. 19].)

⁴³⁵ The first stage of renovation is always a stage of critique – of deconstruction – while the second stage of a successful reconstruction is to provide tools for it. We may compare the situation of autochthonous musicologies today with the situation of the former slaves in the south of the United States in the Post-Civil war period – in the former Confederacy: The post- (American) Civil war Reconstruction was a failure because, while civil and political rights were formally granted to the Freedmen, no effective alternative was proposed to integrate them economically. Giving *maqām* and others non-western musics their "political and civil rights" – the right to be considered as equals to western music or, as with ethnomusicology, the right to be considered as different from western music – without providing these musics with effective tools for their analysis would be another way for (ethno) musicology to postpone a necessary reevaluation of its methods, and another way to keep autochthonous musicologies under its influence. Needless to say, the first task of autochthonous musicologies today should be to find, and found, these alternate tools of analysis.

⁴³⁶ See the discussion of the definition of "Cultural musicology" in [Meer and Erickson, R., 2014], notably the characterization of Cultural musicology as the "the cultural analysis of music" [p. 20]. Note also: "music has unique powers as an agent of ideology. We need to understand its working, its charms, both to protect ourselves against them and, paradoxically, to enjoy them to the full. And in order to do that, we need to be able not just to hear music but to *read* it too: not in literal, notational terms, to be sure, but for its significance as an intrinsic part of culture, of society, of you and me" – [Cook, 2000, p. 129].

PLATES



FHT 1 “A hand-drawn *lubok* featuring ‘hook and banner notation’” – from [Wikipedia Contributors, 2017b] (source file <https://en.wikipedia.org/wiki/File:Kryuki.jpg>) as an example of modified Byzantine (diastematic) notation.

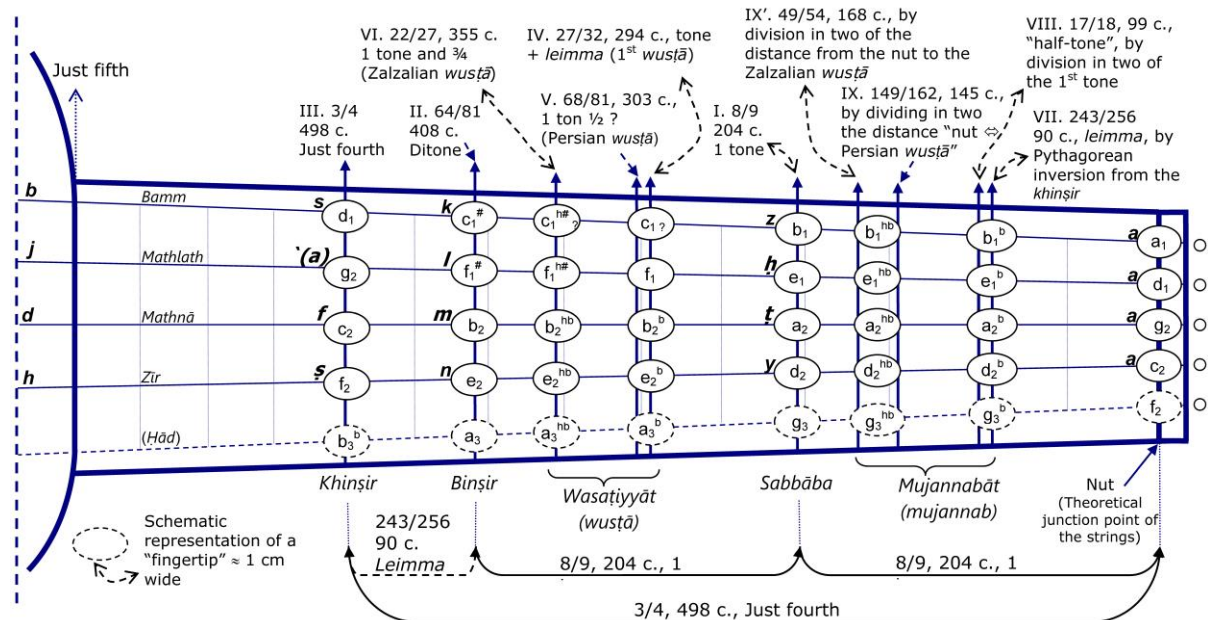

FHT 2 Fārābī’s sequential construction in the *Kitāb al-Mūsīqī al-Kabīr* of the meshing of the fingerboard of the ‘ūd using the *Abjad* alphabet (bold letters) for key notes – “*hb*” and “*hb*” are, respectively, “half-sharp” and “half-flat” accidentals in approximate quarter-tones. The column of letters to the utmost left corresponds to the junctions of the strings with the tailpiece, the right column (bold “*a*”) reminds that the strings make their (theoretical) junction on the nut; the fifth (*Hād*) string is theoretical – adapted and translated from [Beyhom, 2010c, v. 1, p. 205 (Figure 75)].

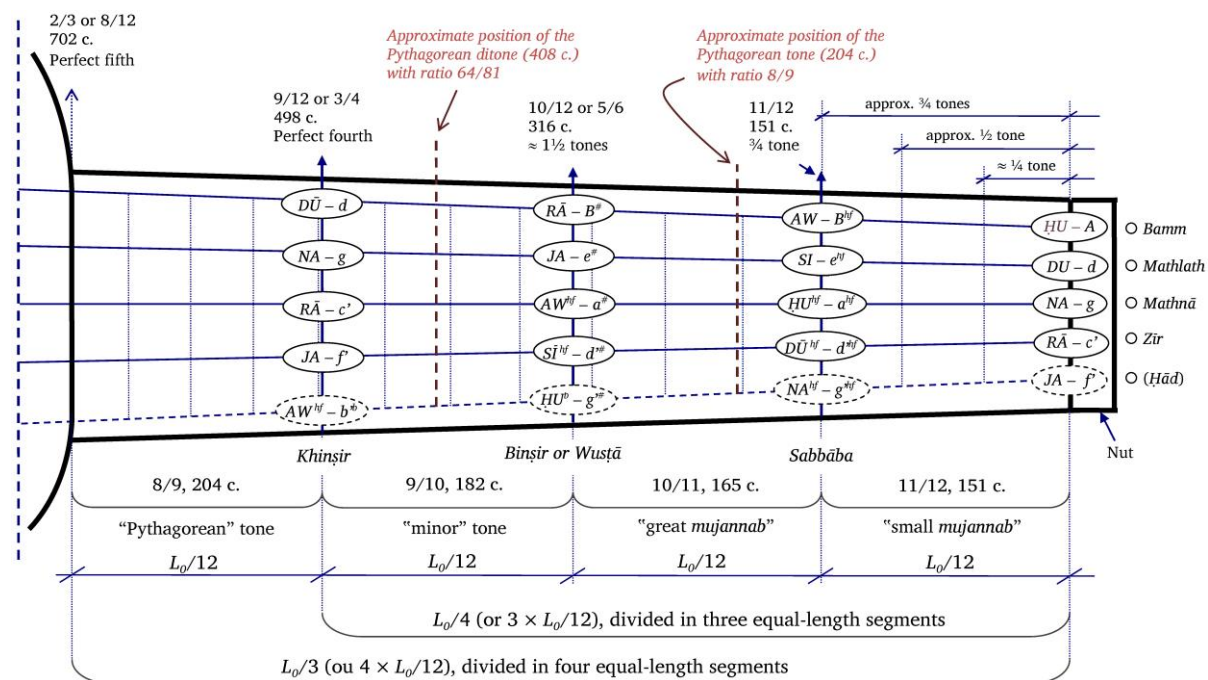

FHT 3 Division of the fingerboard of the ‘ūd on a 12 equal string-parts basis using the solmization proposed by the author. “*hf*” stands for “half-flat” – adapted from [Beyhom, 2012, p. 72 (Fig. 14)].

FHT 4 Use of the Abjad alphabet by Şafiyi-a-d-Din al-Urmawi in his description of the scale as proposed in [1986, الأرموي, p. 44].

ثامنة والحادي عشر قد ساين العوترين عشرة والباقي مستغنى عنها **الفصل الثامن في تسوية اوتار العود والتخرج**
الادوار منه ثم اعلم ان القادمو وضعوا آلة ذات خمسة اوتار وجعلوا مطلق كل وتر من اوتارها ثلثة ارباع بفرقة فصارت الاربعة
 المقتر اليها سبعة وكلمات للجاءات لوجود كل نغمة وحدتها خصوصا كل دستان باسم منضغ لها مثلا وتذكر اسمها الاوتار والوتر
 على اصطلاحهم وهذا سالفنا **وتد**

وتر البسم	ح	س	و	هـ	س	ح	س	ح	س	ح
وتر الثلث	ح	س	و	هـ	س	ح	س	ح	س	ح
وتر المثنى	ح	س	و	هـ	س	ح	س	ح	س	ح
وتر الزبير	ح	س	و	هـ	س	ح	س	ح	س	ح
وتر الحاد	ح	س	و	هـ	س	ح	س	ح	س	ح

الاطلاق من البسم حدها سبابة المثنى
 وحدة سبابة البسم بنهر المثنى وحدة
 بنهر البسم بحجب الزبير ومطلق الثلث
 حدة سبابة الزبير وحدة سبابة الثلث بنهر الزبير وحدة بنهر المثنى بحجب الحاد ومطلق المثنى حدة سبابة الحاد وحدة
 سبابة المثنى بنهر الحاد نسبة مطلق البسم الى بنهر الحاد نسبة البعد الذي باكل مرتين **الفصل التاسع في الادوار المشهورة**

FHT 5 Abjad tablature in [Urmawi (d. 1294), 2001, p. 14].

Intervalllic notations



FHT 6 Intervalllic representation of polychords in [Urmawi (d. 1294), 2001, p. 6]. The theoretical scale of Urmawi is based on a division of the octave in 17 *leimmata* and *commata*, with a whole tone *T* composed of two *leimmata* + one *comma*, and two “neutral” second (“medium tones”) which can be either composed of two successive *leimmata* (M_1), or of one *leimma* + one *comma* (M_2).

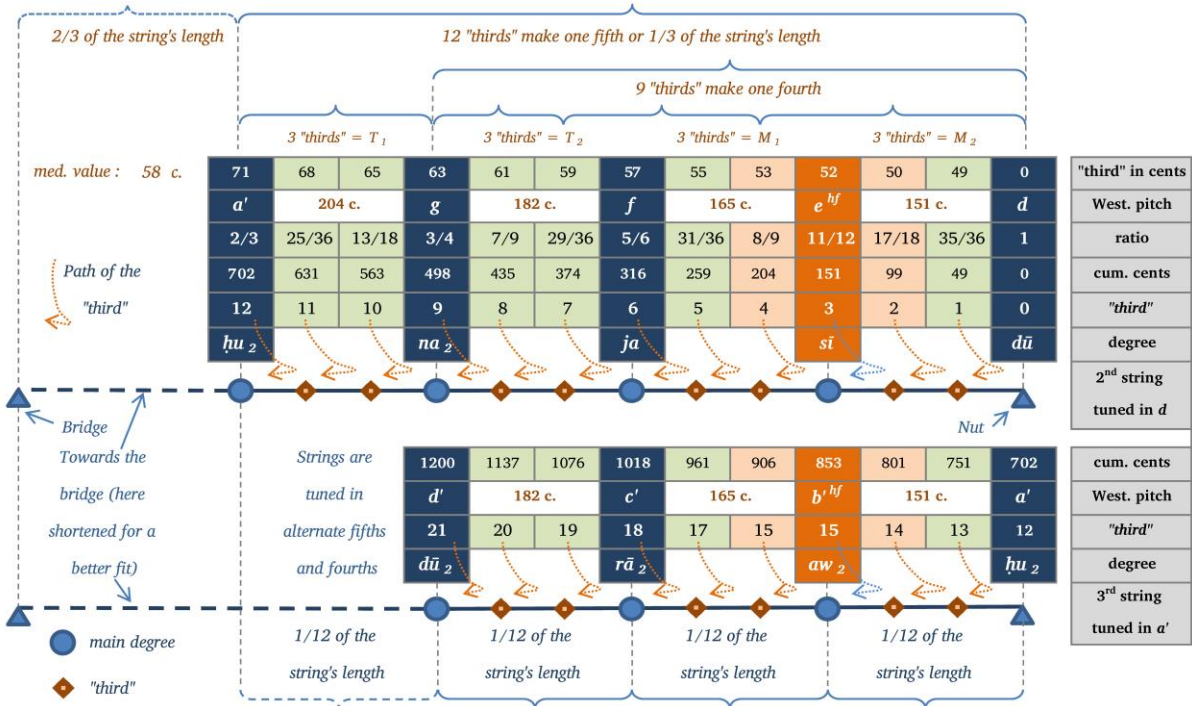

FHT 7 Scale of the pseudo-Şafadi in the hypothesis of an equal-strings division on a *tumbūr* tuned in alternate fifths and fourths.

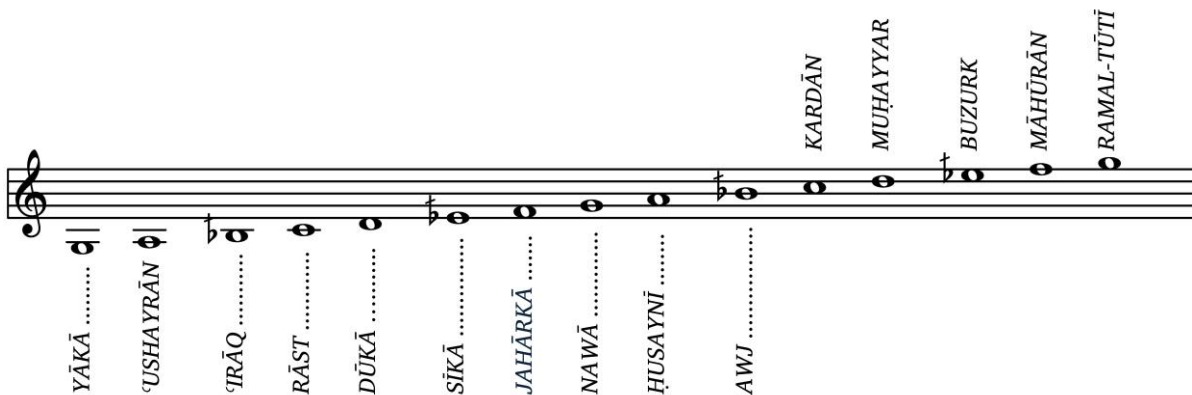

FHT 8 Arabian quarter-tone bi-octavial notation of the main scale of *maqām* music (mode *Rāst* with – exclusively – adjacent “whole-tones” and “three-quarter-tones” intervals) with usual names of the degrees.

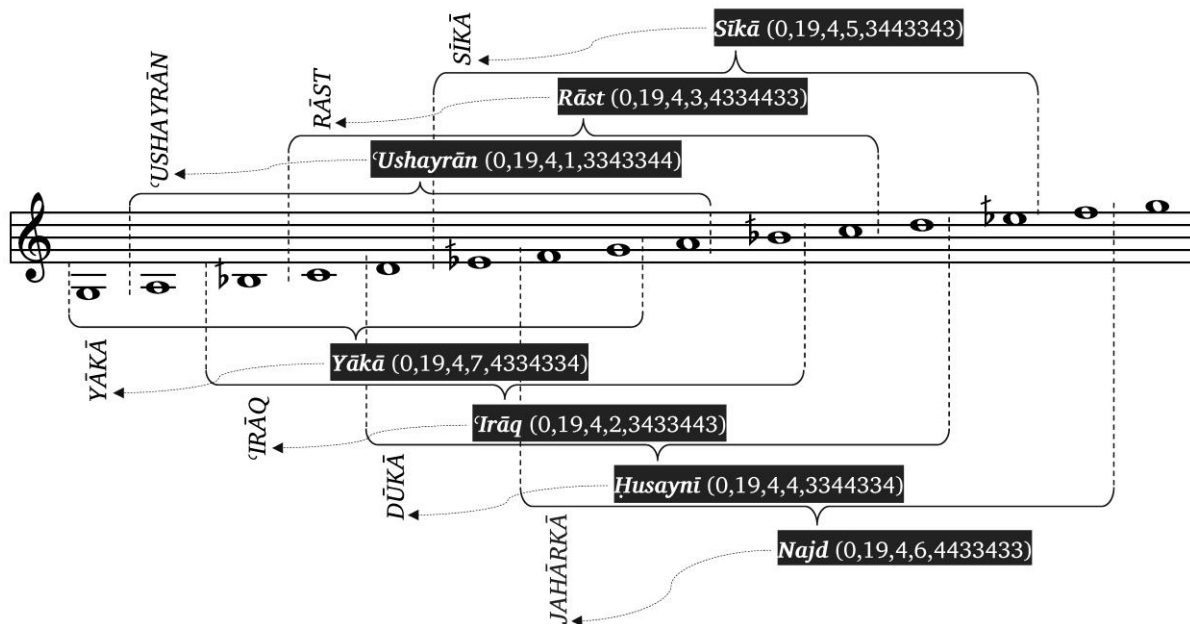

FHT 9 Main sections (octavial scales) of the Arabian quarter-tone division of the bi-octave with corresponding *maqāmāt* and classification in *Modal Systematics*.⁴³⁷

68 (Byz.) / 24 (Ar.)		g_1		a_1		b_1^-		c_1		d_1		e_1^-		f_1		g_2
"Byzantine" Division	Minutes		12		9		7		12		9		7		12	
	Cents		212		159		124		212		159		124		212	
	Total in cents	0		212		371		494		706		865		988		1200
"Arabian" Division	Quarter-tones		4		3		3		4		3		3		4	
	Cents		200		150		150		200		150		150		200	
	Total in cents	0		200		350		500		700		850		1000		1200
Difference in cents	Interval		-12		-9		26		-12		-9		26		-12	
	Note	0		-12		-21		6		-6		-15		12		0

FHT 10 Comparing the intervals of the "Greek scale" (of Chrysanthos – assuming equality between the 68 divisions of the octave – which is not the correct interpretation) and the intervals of the scale in equal quarter-tones embedded by the *Congrès du Caire* of 1932, for a diatonic (Byzantine) scale from g_1 to its octave (g_2) supposedly equivalent to the scale of *maqām Yākā* in Arabian music: the degrees of the two scales do not coincide except for the trivial cases of the unison and the octave.

72 (Byz.) / 24 (Ar.)		<i>sol</i>		<i>la</i>		<i>si-</i>		<i>do</i>		<i>ré</i>		<i>mi-</i>		<i>fa</i>		<i>sol</i>
Partition "grecque"	Minutes		12		10		8		12		10		8		12	
	Cents		200		167		133		200		167		133		200	
	Total en cents	0		200		367		500		700		867		1000		1200
Partition "arabe"	"Quarts"		4		3		3		4		3		3		4	
	Cents		200		150		150		200		150		150		200	
	Total en cents	0		200		350		500		700		850		1000		1200
Différence en cents	Intervalle		0		-17		17		0		-17		17		0	
	Note	0		0		-17		0		0		-17		0		0

FHT 11 Comparing the intervals of the "Greek scale" (2nd Byzantine Reform of the 19th century) and the intervals of the scale in equal quarter-tones embedded by the *Congrès du Caire* of 1932, for a diatonic (Byzantine) scale from g_1 to its octave (g_2) supposedly equivalent to the scale of *maqām Yākā* in Arabian music: the two scales differ only by one *minute* (*moria* or one twelfth of the tone) for the degrees *si* et *mi* ('*IRĀQ* and '*SĪKĀ* in Arabian music). Note that the 2nd Reform scale is based, in practice, on minimal steps in sixths of the tone which makes this difference ineffective. (See FHT 10 above for English equivalences.)

⁴³⁷ Beginning degree for each mode added vertically, with *Modal Systematics* classification between brackets. (See [Beyhom, 2003a ; 2003c ; 2003d ; 2004 ; 2010a ; 2018ap] for more details on the *Modal Systematics* theory).

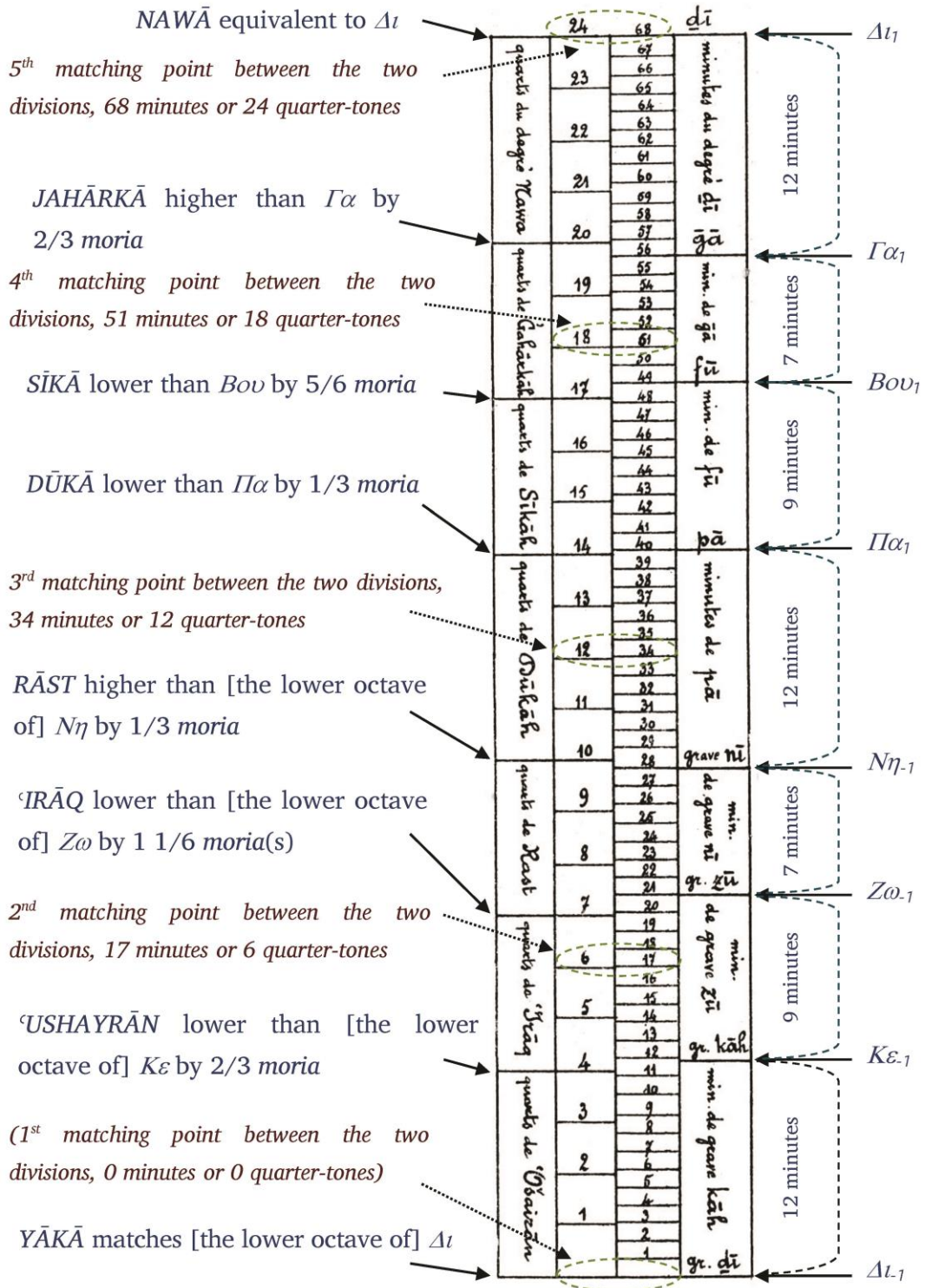

FHT 12 Mashāqa’s diagram (here in Ronzevalle’s French translation with added comments by the author) showing the discrepancies between the intervals of the “Greek scale” (of Chrysanthos – assuming equality between the 68 divisions of the octave – which is not the correct interpretation) and the scale in equal quarter-tones.⁴³⁸

⁴³⁸ [Mashāqa, 1913, detail from Plate I between p. 14 and 15]: subscript indices in the comments show the octave position with “1” corresponding to the main octave and “-1” to the lower octave.

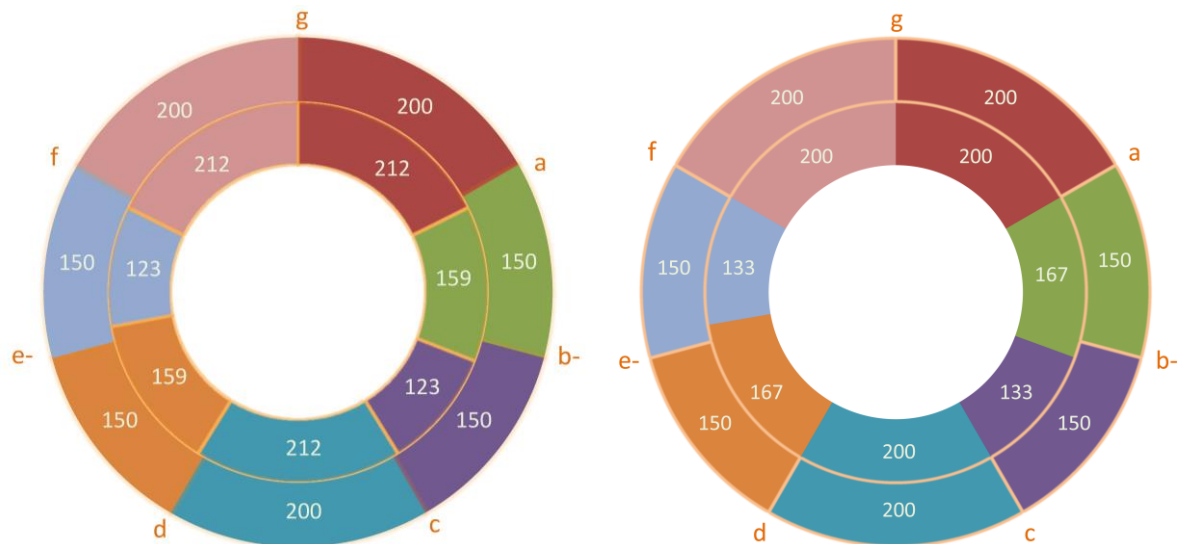

FHT 13 “Doughnut” versions of the comparisons in FHT 10 and FHT 11, with the “Arabian quarter-tone scale” shown in the outer rim. Chrysanthos diatonic division based on 68 “equal-moria” to the left, 2nd Reform intervals based on “sixths-of-the-tones” to the right.⁴³⁹

FHT 14 Scale and polychordal structure (with alternate formulations) – according to Erlanger – of, from top to bottom, *maqām Rāst*, *maqām Ḥawzī* and *maqām ‘Ajām-‘Ushayrān*.⁴⁴⁰

⁴³⁹ While cyclic representations of scales are easier to decipher for such comparisons, it must be however reminded here that cyclic scales do not apply for the majority of *maqām* musics as these musics are mostly non-octavial.

⁴⁴⁰ “Transnotated” and adapted from [Erlanger, 1949, v. 5, p. 178, 238 and 148]. Previously published as figures 189, 192 and 195 in [Beyhom, 2015, p. 233, 235 and 239].

STEM TETRACHORD									
MAJOR			HIGAZ			RAST			
MAJOR / MAJOR			MAJOR / HIGAZ			MAJOR / RAST			
4 4 2 4 4 4 2	Tib	A. OSHAIRAN	4 4 2 4 2 6 2	Tib	SHOK AFZA	4 4 2 4 4 3 3			
4 2 4 4 4 2 4			4 2 4 2 6 2 4			4 2 4 4 3 3 4			
2 4 4 4 2 4 4	Do	KURD	2 4 2 6 2 4 4			2 4 4 3 3 4 4			
4 4 4 2 4 4 2			4 2 6 2 4 4 2	Re	HIGAZ	4 4 3 3 4 4 2			
4 4 2 4 4 2 4			2 6 2 4 4 2 4			4 3 3 4 4 2 4	Do	SUZOLAR	
4 2 4 4 2 4 4	So	FARA FAZA	6 2 4 4 2 4 2			3 3 4 4 2 4 4			
2 4 4 2 4 4 4			2 4 4 2 4 2 6			3 4 4 2 4 4 3			
MINOR / MAJOR			MINOR / HIGAZ			MINOR / RAST			
4 2 4 4 4 4 2			4 2 4 4 2 6 2	Do	NAHAWAND	4 2 4 4 4 3 3			
2 4 4 4 4 2 4			2 4 4 2 6 2 4			2 4 4 4 3 3 4			
4 4 4 4 2 4 2			4 4 2 6 2 4 2			4 4 4 3 3 4 2			
4 4 4 2 4 2 4			4 2 6 2 4 2 4			4 4 3 3 4 2 4			
4 4 2 4 2 4 4			2 6 2 4 2 4 4	Re	NAKRIZ	4 3 3 4 2 4 4			
4 2 4 2 4 4 4			6 2 4 2 4 4 2			3 3 4 2 4 4 4			
2 4 2 4 4 4 4			2 4 2 4 4 2 6			3 4 2 4 4 4 3			
HIGAZ / MAJOR			HIGAZ / HIGAZ			HIGAZ / RAST			
2 6 2 4 4 4 2			2 6 2 4 2 6 2	So	HIGAZ KAR	2 6 2 4 4 3 3			
6 2 4 4 4 2 2			6 2 4 2 6 2 2			6 2 4 4 3 3 2			
2 4 4 4 2 2 6			2 4 2 6 2 2 6			2 4 4 3 3 2 6			
4 4 4 2 2 6 2			4 2 6 2 2 6 2	Re	NAWA ATHER	4 4 3 3 2 6 2			
4 4 2 2 6 2 4			2 6 2 2 6 2 4	Me	HISAR	4 3 3 2 6 2 4			
4 2 2 6 2 4 4			6 2 2 6 2 4 2			3 3 2 6 2 4 4	Re	SABA	
2 2 6 2 4 4 4			2 2 6 2 4 2 6			3 2 6 2 4 4 3			
RAST / MAJOR			RAST / HIGAZ			RAST / RAST			
4 3 3 4 4 4 2	Do	MAHOR	4 3 3 4 2 6 2	Do	SUZNAK	4 3 3 4 4 3 3	Do	RAST	
3 3 4 4 4 2 4	Re	BAYATI	3 3 4 2 6 2 4	Re	B ASHORY	3 3 4 4 3 3 4	Re	HUSSEINI	
3 4 4 4 2 4 3			3 4 2 6 2 4 3	Me	HUZAM	3 4 4 3 3 4 3	Mb	SIKA	
4 4 4 2 4 3 3			4 2 6 2 4 3 3			4 4 3 3 4 3 3	Fa	GIHARKA	
4 4 2 4 3 3 4			2 6 2 4 3 3 4			4 3 3 4 3 3 4	So	YEKAH	
4 2 4 3 3 4 4			6 2 4 3 3 4 2			3 3 4 3 3 4 4	La	H OSHAIRAN	
2 4 3 3 4 4 4			2 4 3 3 4 2 6			3 4 3 3 4 4 3	Tb	IRAQ	

TABLE 6: THE MOST POPULAR ARABIC MAQAMAT LOCATED IN THE HERMETIC MATRIX OF ARABIC MAQAMAT (THE NOTE TO THE LEFT OF EACH MAQAM IS THE TONIC)

FHT 15 Matrices resulting from the combination of “Arabian” tetrachords expressed in multiples of the quarter-tone.⁴⁴¹

hyper n° 12 ; val.: 2 2 4 4 4 4 4

sys.: 3 ; 5tes: 12 ; 4tes 12 ; D_QQ 9

- (0; 12; 1; 2 2 4 4 4 4 4) ; 5te = 2; 4te = 2; D_QQ = 1; Umin = non; Min = oui; Max = non
- 00 sous-système n° 1 ; valeur: 2 2 4 4 4 4 4 ; 5te = non ; 4te = non ; D_QQ = non ; Umin = non ; min = oui ; Max = non ; M347 = non
 - 00 sous-système n° 2 ; valeur: 2 4 4 4 4 2 2 ; 5te = oui ; 4te = oui ; D_QQ = oui ; Umin = non ; min = oui ; Max = non ; M347 = oui
 - 00 sous-système n° 3 ; valeur: 4 4 4 4 2 2 2 ; 5te = non ; 4te = non ; D_QQ = non ; Umin = non ; min = oui ; Max = non ; M347 = non
 - 00 sous-système n° 4 ; valeur: 4 4 4 2 2 4 4 ; 5te = non ; 4te = non ; D_QQ = non ; Umin = non ; min = oui ; Max = non ; M347 = non
 - 00 sous-système n° 5 ; valeur: 4 4 4 2 2 4 4 ; 5te = oui ; 4te = non ; D_QQ = non ; Umin = non ; min = oui ; Max = non ; M347 = oui
 - 00 sous-système n° 6 ; valeur: 4 4 2 2 4 4 4 ; 5te = non ; 4te = oui ; D_QQ = non ; Umin = non ; min = oui ; Max = non ; M347 = oui
 - 00 sous-système n° 7 ; valeur: 4 2 2 4 4 4 4 ; 5te = non ; 4te = non ; D_QQ = non ; Umin = non ; min = oui ; Max = non ; M347 = non

- (0; 12; 2; 2 4 2 4 4 4 4) ; 5te = 4; 4te = 4; D_QQ = 3; Umin = non; Min = non; Max = non
- 00 sous-système n° 1 ; valeur: 2 4 2 4 4 4 4 ; 5te = non ; 4te = non ; D_QQ = non ; Umin = non ; min = non ; Max = non ; M347 = non
 - 11 sous-système n° 2 ; valeur: 4 2 4 4 4 2 2 ; 5te = oui ; 4te = oui ; D_QQ = oui ; Umin = non ; min = non ; Max = non ; M347 = non
 - 00 sous-système n° 3 ; valeur: 2 4 4 4 2 4 4 ; 5te = oui ; 4te = oui ; D_QQ = oui ; Umin = non ; min = non ; Max = non ; M347 = non
 - 00 sous-système n° 4 ; valeur: 4 4 4 2 4 2 2 ; 5te = non ; 4te = non ; D_QQ = non ; Umin = non ; min = non ; Max = non ; M347 = non
 - 11 sous-système n° 5 ; valeur: 4 4 4 2 4 2 4 ; 5te = oui ; 4te = non ; D_QQ = non ; Umin = non ; min = non ; Max = non ; M347 = non
 - 11 sous-système n° 6 ; valeur: 4 4 2 4 2 4 4 ; 5te = oui ; 4te = oui ; D_QQ = oui ; Umin = non ; min = non ; Max = non ; M347 = non
 - 11 sous-système n° 7 ; valeur: 4 2 4 2 4 4 4 ; 5te = non ; 4te = oui ; D_QQ = non ; Umin = non ; min = non ; Max = non ; M347 = non

- (0; 12; 3; 2 4 2 4 4 4 4) ; 5te = 6; 4te = 6; D_QQ = 5; Umin = non; Min = non; Max = non
- 11 sous-système n° 1 ; valeur: 2 4 2 4 4 4 4 ; 5te = non ; 4te = oui ; D_QQ = non ; Umin = non ; min = non ; Max = non ; M347 = non
 - 11 sous-système n° 2 ; valeur: 4 4 2 4 4 2 2 ; 5te = oui ; 4te = oui ; D_QQ = oui ; Umin = non ; min = non ; Max = non ; M347 = non
 - 11 sous-système n° 3 ; valeur: 4 2 4 4 2 4 4 ; 5te = oui ; 4te = oui ; D_QQ = oui ; Umin = non ; min = non ; Max = non ; M347 = non
 - 11 sous-système n° 4 ; valeur: 2 4 4 4 2 4 4 ; 5te = oui ; 4te = oui ; D_QQ = oui ; Umin = non ; min = non ; Max = non ; M347 = non
 - 11 sous-système n° 5 ; valeur: 4 4 4 2 4 4 2 ; 5te = oui ; 4te = non ; D_QQ = non ; Umin = non ; min = non ; Max = non ; M347 = non
 - 11 sous-système n° 6 ; valeur: 4 4 2 4 4 2 4 ; 5te = oui ; 4te = oui ; D_QQ = oui ; Umin = non ; min = non ; Max = non ; M347 = non
 - 11 sous-système n° 7 ; valeur: 4 2 4 2 4 4 4 ; 5te = oui ; 4te = oui ; D_QQ = oui ; Umin = non ; min = non ; Max = non ; M347 = non

FHT 16 Classification of the systems and sub-systems in Hyper-system no. 12 in the author’s Ph.D. thesis – [Beyhom, 2003d, p. 178].

⁴⁴¹ [Sālih, 1994, p. 91]. Previously published in [Beyhom, 2003a, p. 74].

Genre <i>Awj-Ārā</i> si^{db}	1 ^{er} degré	1 ^{er} int.	2 ^e degré	2 ^e int.	3 ^e degré	3 ^e int.	4 ^e degré
Erlanger (quarts)	si ^{db}	→ 3	do	→ 6	ré [#]	→ 1	mi ^{db}
Quarts (conceptuels)	si ^{db}	→ 3	do	→ 5	ré ^{dd} (?)	→ 2	mi ^{db}
Conceptuel 17 ^{es}	si ⁻	→ 2	do	→ 4	ré ⁺	→ 1	mi ⁻
Notation simplifiée 17 ^{es}	si ^b	→ 2	do	→ 4	ré [#]	→ 1	mi ^b
Genre <i>Ājam</i> si^b							
Erlanger (quarts)	si ^b	→ 4	do	→ 4	ré	→ 2	mi
Quarts (conceptuels)	si ^b	→ 4	do	→ 4	ré	→ 2	mi
Conceptuel 17 ^{es}	la ⁺	→ 3	do	→ 3	ré	→ 1	mi
Notation simplifiée 17 ^{es}	si ^{bb}	→ 3	do	→ 3	ré	→ 1	mi
Genre <i>Ājam</i> do							
Erlanger (quarts)	do	→ 4	ré	→ 4	mi	→ 2	fa
Quarts (conceptuels)	do	→ 4	ré	→ 4	mi	→ 2	fa
Conceptuel 17 ^{es}	do	→ 3	ré	→ 3	mi	→ 1	fa
Notation simplifiée 17 ^{es}	do	→ 3	ré	→ 3	mi	→ 1	fa
Genre <i>Ājam</i> do[#]							
Erlanger (quarts)	do [#]	→ 4	ré [#]	→ 4	mi [#]	→ 2	fa [#]
Quarts (conceptuels)	do [#]	→ 4	ré [#]	→ 4	mi [#]	→ 2	fa [#]
Conceptuel 17 ^{es}	do ⁺	→ 3	ré ⁺	→ 3	mi ⁺	→ 1	fa ⁺
Notation simplifiée 17 ^{es}	ré ^{bb}	→ 3	mi ^{bb}	→ 3	fa ^{bb}	→ 1	sol ^{bb}
Genre <i>Hijāz</i> ré							
Erlanger (quarts)	ré	→ 2	mi ^b	→ 6	fa [#]	→ 2	sol
Quarts (conceptuels)	ré	→ 3	mi ^{db}	→ 5	fa ^{dd}	→ 2	sol
Conceptuel 17 ^{es}	ré	→ 2	mi ⁻	→ 4	fa ⁺⁺	→ 1	sol
Notation simplifiée 17 ^{es}	ré	→ 2	mi ^b	→ 4	fa ^{##}	→ 1	sol
Genre <i>Hijāz-Kār</i> do							
Erlanger (quarts)	do	→ 2	ré ^b	→ 6	mi	→ 2	fa
Quarts (conceptuels)	do	→ 2	ré ^b	→ 5	mi ^{db}	→ 2	fa
Conceptuel 17 ^{es}	do	→ 1	ré ⁻	→ 4	mi ⁻	→ 1	fa
Notation simplifiée 17 ^{es}	do	→ 1	ré ^{bb}	→ 4	mi ^b	→ 1	fa
Genre <i>Hijāz</i> do[#]							
Erlanger (quarts)	do [#]	→ 2	ré	→ 6	fa	→ 2	sol ^b
Quarts (conceptuels)	do [#]	→ 3	ré ^{dd}	→ 5	fa	→ 2	sol
Conceptuel 17 ^{es}	do ⁺	→ 2	ré	→ 4	fa	→ 1	fa ⁺
Notation simplifiée 17 ^{es}	do [#]	→ 2	ré	→ 4	fa	→ 1	fa [#]
"Enharmonique" do							
Erlanger (quarts)	do	→ 1	do ^{dd}	→ 8	mi ^{dd}	→ 1	fa
Quarts (conceptuels)	do	-	-	-	-	-	fa
Conceptuel 17 ^{es}	do	→ 1	do ⁺	→ 5	mi	→ 1	fa
Notation simplifiée 17 ^{es}	do	→ 1	do [#]	→ 5	mi	→ 1	fa

FHT 17 Intervallic equivalences and literal notation of tetrachords in Erlanger's formulation (1st row), in the author's proposition in quarter-tones (2nd row) and in 17^{ths} of the octave (3rd and 4th rows).⁴⁴²

⁴⁴² [Beyhom, 2010b, p. 127, Plate no. 10].

Khorezmian tablatures for the tanbur

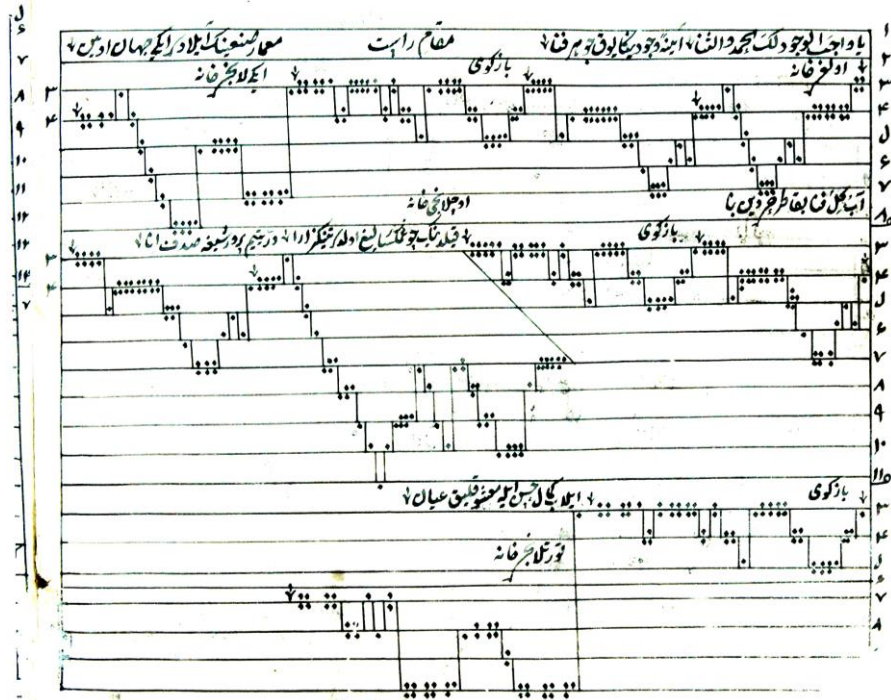

FHT 18 Khorezmian *tanbur* notation (copy of Jean During) p. 1: *maqām Rāst*.⁴⁴³

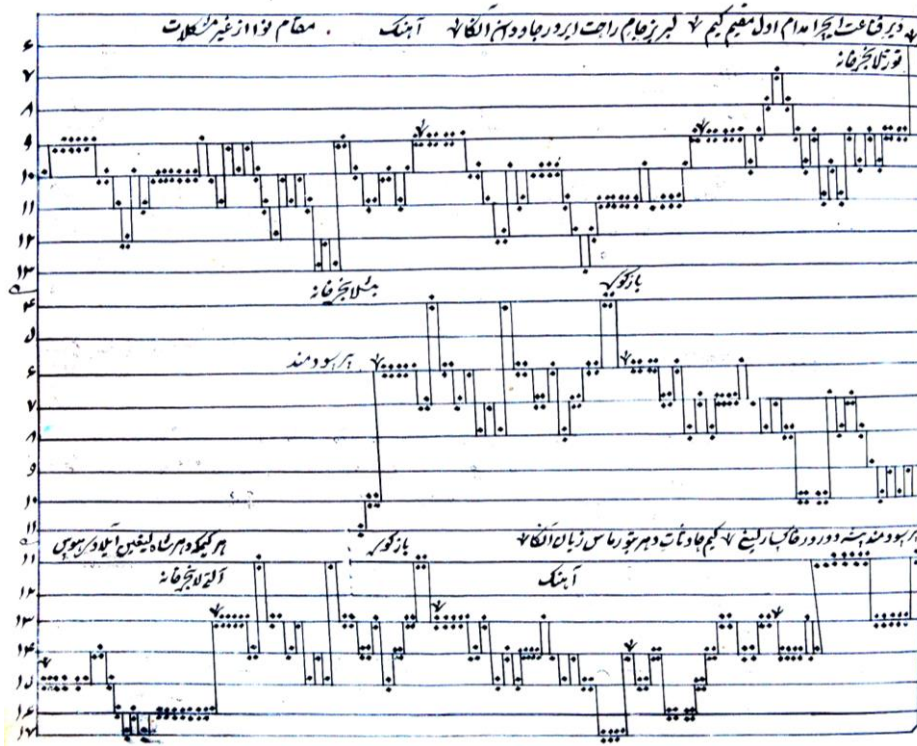

FHT 19 Khorezmian *tanbur* notation (copy of Jean During) p. 21: *maqām Nawā*.⁴⁴⁴

⁴⁴³ Photograph by Jean During / Image treatment by Amine Beyhom.

⁴⁴⁴ Photograph by Jean During / Image treatment by Amine Beyhom.

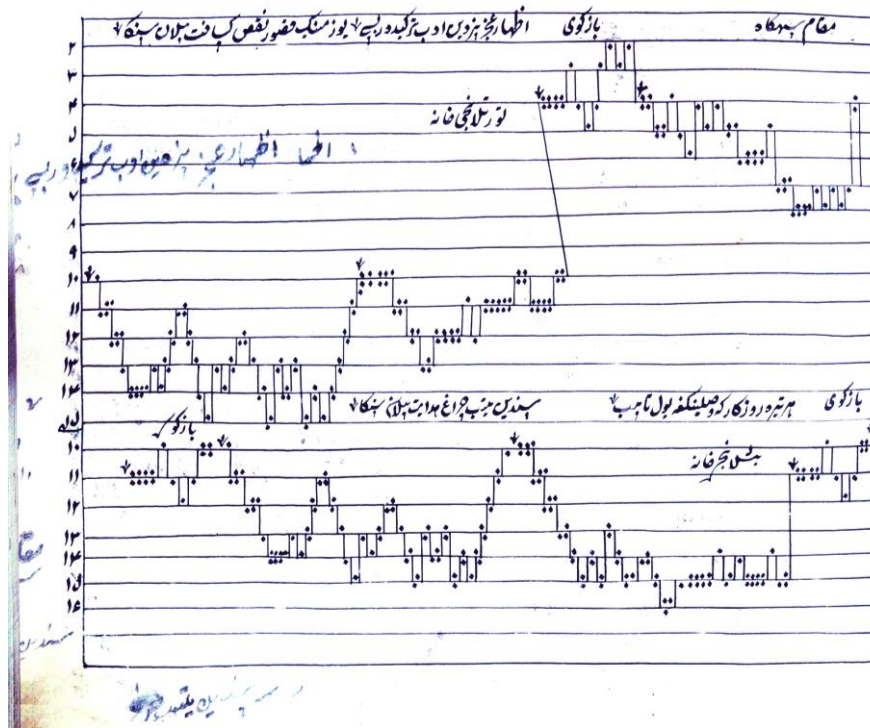

FHT 20 Khorezmian *tanbur* notation (copy of Jean During) p. 53: *maqām Segah*.⁴⁴⁵

Western and modified notations



FHT 21 An exercise for the ‘ūd by Kindī in the *Risāla fī-l-Luḥūn wa-n-Naḡham*. Transnotated by Zakariyyā Yūsuf in 1965.⁴⁴⁶

⁴⁴⁵ Photograph by Jean During / Image treatment by Amine Beyhom.

⁴⁴⁶ [Kindī (al-) and 1965, الكندي, p. 31]: two right-hand fingers are used for the exercise, the thumb and the index.

The image shows a page of handwritten musical notation for the piece 'Dhekr'. The score is written on ten staves, with Arabic lyrics written above the notes. The notation includes various rhythmic values, accidentals, and phrasing slurs. A red watermark is overlaid diagonally across the page. Two specific notes in the score are highlighted with orange dashed boxes: one in the third staff on the right side, and another in the eighth staff on the right side.

FHT 22 One page from the score of *Dhekr* (Document No. 121-03, p. 005) from the archives of Erlanger in Ennejma Ezzahra (Sidi Bou-Said – Tunisia).⁴⁴⁷

⁴⁴⁷ Downloaded 20/07/2018 from <http://ennejma.tn/archives/fr/2018/07/18/121-03-partitions-dhekr/>.

GENRES TRI- TETRA- PENTACORDES CONSTITUTIFS DES MODES ORIENTAUX...INTERVALLES COMMATIQUES ET INSERTION SUR L'ECHELLE

Échelle, Quarts-de-ton ←

↓ GENRES ↓

'ADJAM, ÇAHĀRGĀH
BŪSĀLIK
KURDĪ m. LĀMĪ
KURDĪ m. KURDĪ
KURDĪ-ATHAR
NIKRĪZ, HĪJĀZ
BAYĀTĪ
ŞABĀ
MUKHĀLIF
HUZĀM
ZAWĪL, MUSTA'ĀR
'IRĀK, SEGĀH
YEGĀH, RĀST

© Jean-Claude CHABRIER

String Quartet
© 1984
CNRS

5
1 2 3 4 5

Rang de cordes sur "Gd"

Échelle, Commas, 53/octave

Code JCC 24/octave

	O	P	Q	R	S	T	U	V	X	Y	A	B	C	D	E	F	G	H	I	J	K	L	M	N	O	P	Q	R	S	T	U	V	X	Y	A
DOIGTÉS-DEGRÉS DE L'ÉCHELLE FONDAMENTALE DES SONS																																			
HAUTEURS (ton-clef)																																			

mod. dep. arabesques

FHT 23 geni and "modes" according to Chabrier.⁴⁴⁸

الشعر: قديم
اللحن: قديم

قابع وصلة مقام الهزام
موشح يا وحيد الغيد

الإيقاع
سماعي ثقيل

♩ = 144

FIN.

FHT 24 Muwashshah in maqam Huzam.⁴⁴⁹

⁴⁴⁸ [Chabrier, 1995, p. 285].

⁴⁴⁹ [Hilū (al-), 1980, p. 175].

The quarter tone
(tampered)
on C
Mode " Bayat "

Les quarts des tons
tempéré
sur la gamme Do
Mode " Bayati "

الارباع الصوتية
المعدلة
على سلم دو
مقام " بياتي "



FHT 25 Scale and legend for *maqām Bayāt* according to (al-) Bāshā.⁴⁵⁰

⁴⁵⁰ [Bacha, s.d. (199x), p. 55]: the caption (above the score) is here reduced in size and reproduced strictly "as is". Further explanations from Bāshā (same page – the original text is also reproduced strictly as is): "**The violin and the quarter tone** – Quarter tones became an essential and a remarkable factor in the construction of Oriental-Arabic musical scales. Since hundred of years and until the present time scholars and musicologists are working on systematizing these quarter tones in order to become subdued and subjugate to both the composer and the interpreter. When we designate and establish the degrees and intervals of these quarter tones in order to conform with the needs of instrumental music composition, we do not mean to abolish what is traditionally and conventionally in use, but at the same time we cannot anymore be bound to the MAQAM with its one-tonal degree in the operation of music composition. The amplitude and profusion in MODAL TRANSFERS in the major and minor scales are far more abundant to the composer than that in the scales consisting of quarter tones. The practical and eloquent proof to this essay came out when J.S. Bach introduced through his 24 PRELUDES and FUGUES based on the WELL-TEMPERED scale, and consequently this eventuate that the term TEMPERED gave balance and equilibrium to the scale, which, at the same time caused a decisive turn in the history of music. Our essay in this book (THE VIOLIN AND THE ¼ TONES, 21 ETUDES) seek to open a way to a highly disciplined playing of the quarter tones after mastering playing compositions of remarkable composers based on major and minor scales. This book is compiled to the violin to play scales with (WELL-TEMPERED) quarter tones. Since the violin is the basic and essential instrument in the Orchestra, the purpose of this book is to help in preparing and mobilizing Violin players with high techniques based on the world-wide tuning G - D - A - E (SOL - RE - LA - MI). Two similar books will follow, one for the Viola and another for the Cello".

Moderato معلق من ماضٍ "أسره معاصر"

إعداد وتأليف اوركتة الجي = توفيق باشا

Handwritten musical score for a symphony orchestra and vocal soloist. The score is in Arabic and includes parts for Soprano (S), Alto (A), Tenor (T), Bass (B), Flute I (Fl I), Flute II (Fl II), Clarinet in Bb (Cl Bb), Bassoon (Bsn), and Trombones I, II, III, IV (Tbn I-IV). The vocal part is for a soloist (Soprano). The music is in 4/4 time and marked 'Moderato'. The lyrics are in Arabic. The score is divided into two systems. The first system has four measures, and the second system has four measures. The vocal part enters in the second measure of the first system. The score includes various musical notations such as notes, rests, dynamics (f, mf, p), and articulation marks.

FHT 26 Tuwfiq al-Bāshā: 1st page of the score of the *muwashshah* "Isqī-(a)l-Itāsh". (Courtesy of the author.)

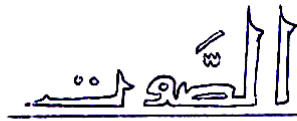

Sacha Bourguignon

Handwritten musical score for the first page of 'A-ş-Şawt' by Sacha Bourguignon. The score is in 4/4 time and consists of four systems, each with a vocal line and a piano accompaniment. The piano part includes chord diagrams and chord names.

System 1: The piano part starts with a D^7sus4 chord. The second measure features an E^b/D chord and a $Dsus4$ chord with a sixteenth-note triplet (marked with a '6' and a slur).

System 2: The piano part starts with a D^7sus4 chord. The second measure features an E^b/D chord and a $Dsus4$ chord.

System 3: The piano part starts with a $Dsus4$ chord. The second measure features a $C-2$ chord and a $D^{\#}$ chord.

System 4: The piano part starts with an F^7sus4 chord with an 'add3' instruction. The second measure features an $E^b\Delta^{\#}$ chord. The third measure features a D/c chord, and the fourth measure features an $F^7sus4b2$ chord (labeled as D^7alt).

FHT 27 1st page of the score of A-ş-Şawt by Sacha Bourguignon.⁴⁵¹⁴⁵¹ Courtesy of the author.

Marmar Zamânî Nena Bakhtanassar - Qânûn

The musical score is presented in four systems, each with a vocal line (Qânûn solo or Q - s) and a rhythmic accompaniment line (Qânûn rythme or Q - r). The key signature has one flat (B-flat) and the time signature is 7/4. The first system shows measures 1-3. The second system shows measures 4-6. The third system shows measures 7-8. The fourth system shows measures 9-10. The score includes various musical notations such as notes, rests, and ornaments (trills). The rhythmic accompaniment features fingerings (1, 2, 3, 4, 7) and accents. The final measure (10) includes a 'rit.' (ritardando) marking and a fermata over the final note.

FHT 28 1st page of the score of *Marmar Zamânî* (for *qânûn*) by Toufic Succar.⁴⁵²

⁴⁵² Courtesy of the author.

SCHERZANDO
Allegretto grazioso

mf
pizz.
mf
pizz.
mf
pizz.
mf

5
cresc. f p
cresc. f p
cresc. f p
cresc. f p

10
mp
mp
mp

FHT 29 1st page of the score of the Scherzando by Toufic Succar.⁴⁵³

⁴⁵³ Courtesy of the author.

مقام فرحناک:
مقام هزام:
مقام مستعار:
مقام بستنکار:

٤ - المقامات المنتمية الى عائلة العراق.

المقام الأساسي: مقام العراق
المقامات المتقاربة: مقام البستنکار.
المقامات الشبيهة: مقام راحة الأرواح.

مقام بستنکار
مقام راحة الأرواح:

FHT 30 Notation (quarter-tone division of the octave) of the *maqām*(s) of the *sikā* and *irāk* “families” according to the CNSML⁴⁵⁴. Only the *irāq* (second staff from bottom – to the left) tetrachord is in just fourth and “disjunctive tones” are all – except for the upper one – different from the “whole tone”⁴⁵⁵.

0 1 2 3 4 5 6 7 8 9 10 11 12 13 14 15 16 17 18 19 20 21 22 23 24

1 2

1 2

FHT 31 General scale of Turkish music according to Rauf Yekta Bey in [Yekta, 1922, p. 2987]. The scale is notated – according to Yekta – a fifth higher in order to fit it in a staff in treble clef (the initial *d* corresponds to a *g* in the Western scale).⁴⁵⁶

⁴⁵⁴ The Lebanese national conservatoire.

⁴⁵⁵ [Ghulmiyya, Kirbāj, and Farah, 1996, v. 5, p. 22].

⁴⁵⁶ “Ton majeur” = whole tone, “ton mineur” = *di-leimma*, “demi-ton majeur” = *apotome*. Note that the origin of the equivalence between *maqām*(ian) degree *RĀST* – in Arabian *maqām* music theory *c* – and the Western *g* goes back at least to Giuseppe Donizetti – as expounded in [Behar, 2013] (private communication). (See also [Ergur and Doğrusöz, 2015], notably [p. 151, fn. 5]: “E.g. identification of Rast makam with G Major or the recalibration of the makam scaling according to a basic tone by the theoreticians Ezgi-Arel, at the beginning of the 20th century, who accepted the Çargāh makam, which is structurally the most similar one to European major scale. (Signell, 1986: 24).”)

C = Comma = 1 x i (1) ↔ 1 comma

L = Limma = 1 x i ; 2 x i (4 ; 1 + 3) ↔ 4 comma

A = Apotome = 2 x i (4 + 1) ↔ 5 comma

T = Tanini = 4 x i = 2 x 2 i ↔ L + A = 9 comma

M* = Mujannab (3 possibilities) = 3 x i = (2 x i) + (1 x i)

↔ L + L ; C + L ; C + A

↔ 4 + 1 + 3 = 8 ; 1 + 3 + 1 = 5 ; 1 + 4 + 1 = 6

○ Type 1 (primary)
 # koma diyezi : raises one comma ↓ koma bemolü : lowers one comma
 # bakiye diyezi : raises 4 comma † bakiye bemolü : lowers 4 comma
 # küc. müc. diyezi : raises 5 comma † küc. müc. bemolü : lowers 5 comma
 ⊙ Type 2 (e⁻ and b⁻)
 ⊗ 'Arabā (Altered primary with own denomination)
 ● Secondary degree (preceded by a tik or a nim)

FHT 32 Yekta Bey's scale completely notated with "Modern" (Yekta-Ezgi-Arel) accidentals, conjunct intervals and structuring intervals.

raises one limma (90 c.) † lowers one comma (24 c.)

Intervals
 Primary: 4th = "Just" fourth, 5th = "Just" fifth
 Auxiliary: 8^{ve} = "Just" octave, T = Tanini → complements the octave

M* = Mujannab (2 possibilities) = 2 x i ↔ L + L ; C + L
 T = Tanini → from the subtraction: 5th - 4th ↔ L = Limma = 1 x i ↔ 4th - ditone
 L = Limma = 1 x i ↔ Pythagorean limma ↔ C = Comma = 1 x i ↔ T - M1

Pythagorean 17-Intervals scale
 # raises one apotome † lowers one apotome

FHT 33 Conceptualization of the « Systematist » scale (Şafiyi-y-a-d-Din al-Urmawi) and comparison with the "Pythagorean" scale.

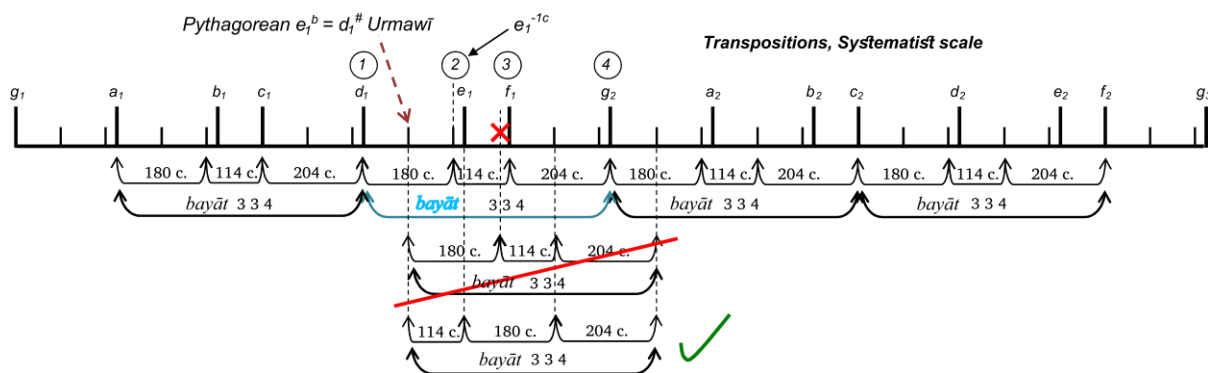

FHT 34 Theoretical transposition in the “Systematist scale” of a bayāt tetrachord [d ↑3 3 4], or $M_1 M_2 T$ (*mujannab₁ mujannab₂* whole-tone) on the degrees g , a and e^b : the transposition on $d^\#$ enforces the inversion of the *mujannab*(s) (“neutral seconds”) as $M_2 M_1 T$.

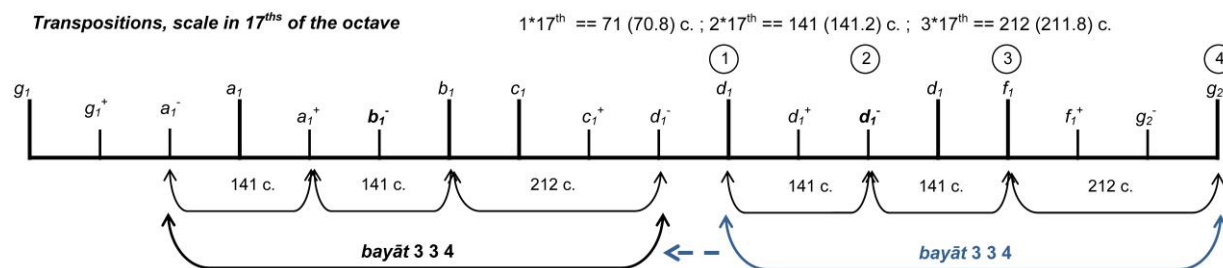

FHT 35 Example of a transposition of the same tetrachord as in FHT 34 on a 17th of the octave grid from d to a . All transpositions in this equal-temperament grid give similar intervals.

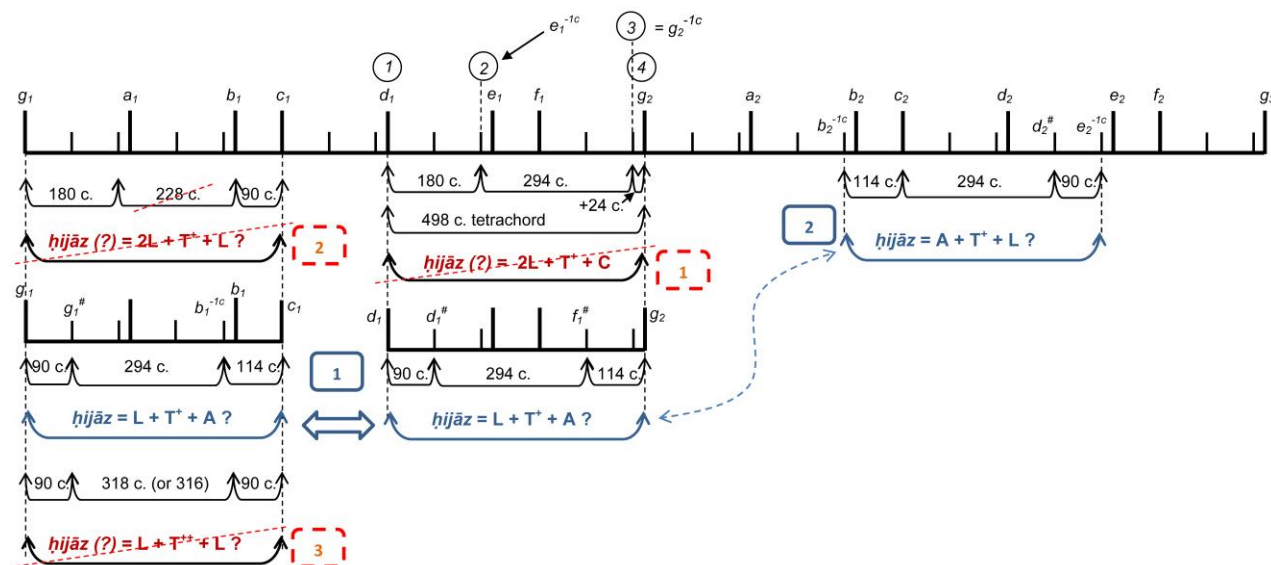

FHT 36 Transpositions of the hijāz tetrachord in Urmawī’s scale: a “Great tone” in this scale is composed of 4 elementary intervals – 3 *leimmata* and 1 *comma*. This makes it impossible to use configuration 3 (red) as (1) a “Great tone” contains 5 elementary intervals in this configuration, and (2) this configuration cannot be transposed again on b^{-1c} and e^{-1c} – which are degrees of the main scale. Likewise, configuration 1 (red) contains a (too) small central interval ($2L + 2C$) while configuration 2 (red) contains one *comma* structural interval – which contravenes Urmawī’s indications about interval compositions in the scale (no *comma* can be used alone in the scale). The only acceptable composition – central $3L + C$ with bordering *leimma* and *apotome* (in blue) – can be transposed without structural modifications except the inversion of the *mujannab*(s) as seen in FHT 34.

C = Comma = 1 x i (1) ↔ 1 comma
L = Limma = 1 x i ; 2 x I (4 ; 1 + 3) ↔ 4 comma
A = Apotome = 2 x i (4 + 1) ↔ 5 comma

T = Tanini = 4 x i = 2 x 2 i ↔ L + A = 9 comma
M* = Mujannab (2 possibilities) = 2 x i ↔ L + L ; C + L
 ↔ 4 + 1 + 3 = 8 ; 1 + 3 + 1 = 5

○ Type 1 (primary)
 ⊕ Type 2 (e and b)
 ⊗ ‘Arabā (Altered primary with own denomination)
 ● Secondary degree (preceded by a tik or a nım)

† koma diyezi: raises 1 comma † koma bemolü: lowers 1 comma
 ‡ bakiye diyezi: raises 4 comma ‡ bakiye bemolü: lowers 4 comma
 † küc. müc. diyezi: raises 5 comma † küc. müc. bemolü: lowers 5 comma

FHT 37 General analysis of the Yekta-Ezgi-Arel Turkish scale – and notation – according to the explanations of [Signell, 2004], structured in *Elementary* (“i”, “C” and “L”) and *Conceptual* (“C”, “L”, “A”, “T” and “M”) – different fillings for the notes are explained on the bottom-right.⁴⁵⁷

FHT 38 Conception (by Signell) of the general (Turkish) scale as deduced from the Yekta-Ezgi-Arel theory (literal notation in French). Two similar chains of 12 *apotomai* and *leimmata* are superposed with a one (Holderian) comma offset. The resulting scale is shown in the previous plate (FHT 37).

⁴⁵⁷ Basic intervals are, according to [Signell, 2004, p. 23] :

- *koma* (*comma*, 23 c) – This is an auxiliary interval (not used as such in the scale between adjacent pitches) – see the Core Glossary of [Beyhom, 2018ap] for more explanations on types of intervals.
- *bakiye* (*leimma* or “small [lesser] half-tone”, 90 c).
- *küçük mücennep* (“small *mujannab*” – *apotome*, or “big [greater] half-tone”, 114 c).
- *büyük mücennep* (“big *mujannab*” – “minor” tone, or “small tone”, 180 c).
- *tanini* (“major” tone, or “big [greater] tone”, 204 c).
- *artık ikili* (“augmented second”, 271 c) – This can be 12, 13 or 14 Holderian commas according to the context, in the latter case equivalent to a “major tone” + an *apotome*, 114 + 204 = 318 c).

FHT 39 Transpositions of tetrachord *hijaz* in modern theories of the scale in Turkey.⁴⁵⁸ Accidentals and graphical differences in the representation of the notes are explained in FHT 37.

FHT 40 Scale of the First mode $\{\pi\alpha \uparrow 10 8 12 12 10 8 12, \Pi\alpha \downarrow 12 12 6 12 12 8 10\}$ in western notation with Byzantine accidentals.⁴⁵⁹ The accidental used for the key signature lowers the pitch by a sixth of a (tempered) tone.

⁴⁵⁸ [Signell, 2001, p. 31]: “Note that occasionally a ‘transposition’ will cause a slight alteration in the size of an interval. In Ex. 7.6 (in [Signell, 2001, p. 32]), the characteristic interval of an augmented second in the HICAZ tetrachord is altered from 12 to 13 commas when it is transposed to F#. This is due to the necessity of accommodating the transposed tetrachord to the pitches available (i.e., willy-nilly, the closest pitch must be used)”.

⁴⁵⁹ As deduced from [Yaziji, 2001] and [Commission musicale de (Musical Committee of) 1881, Aphtonidēs, and al., 1978] and others.

Introduction
First line

A 

Second line

B 

Third line



Fourth line



Fifth line



Sixth line

C 

FHT 41 Richard Dumbrill's interpretation of Hurrian song H6 using MUS2 and comma-numbered accidentals (published in [Dumbrill, 2017, p. 117, Fig. 18] – Courtesy of the author).⁴⁶⁰

⁴⁶⁰ (From the original caption): “Near-Eastern intonation implemented with the collaboration of Rosy Azar Beyhom and Amine Beyhom. The first bar of the introduction is the fourth bar of the conclusion. It is the musical version of well-known catch-lines often used in Mesopotamian texts. Numbers after accidentals indicate: #1 = 1 comma sharper = 22.64 cents; #2 = 2 commas sharper = 45.28 cents; #3 = 3 commas sharper = 67.92 cents; #5 = 5 commas sharper = 113.2 cents; b1 = 1 comma flat = - 22.64 cents; b2 = 2 commas flat = - 45.28 cents; b3 = 3 commas flat = - 67.92 cents; b4 = 4 commas flat = - 90.57 cents”.

Animated analyses

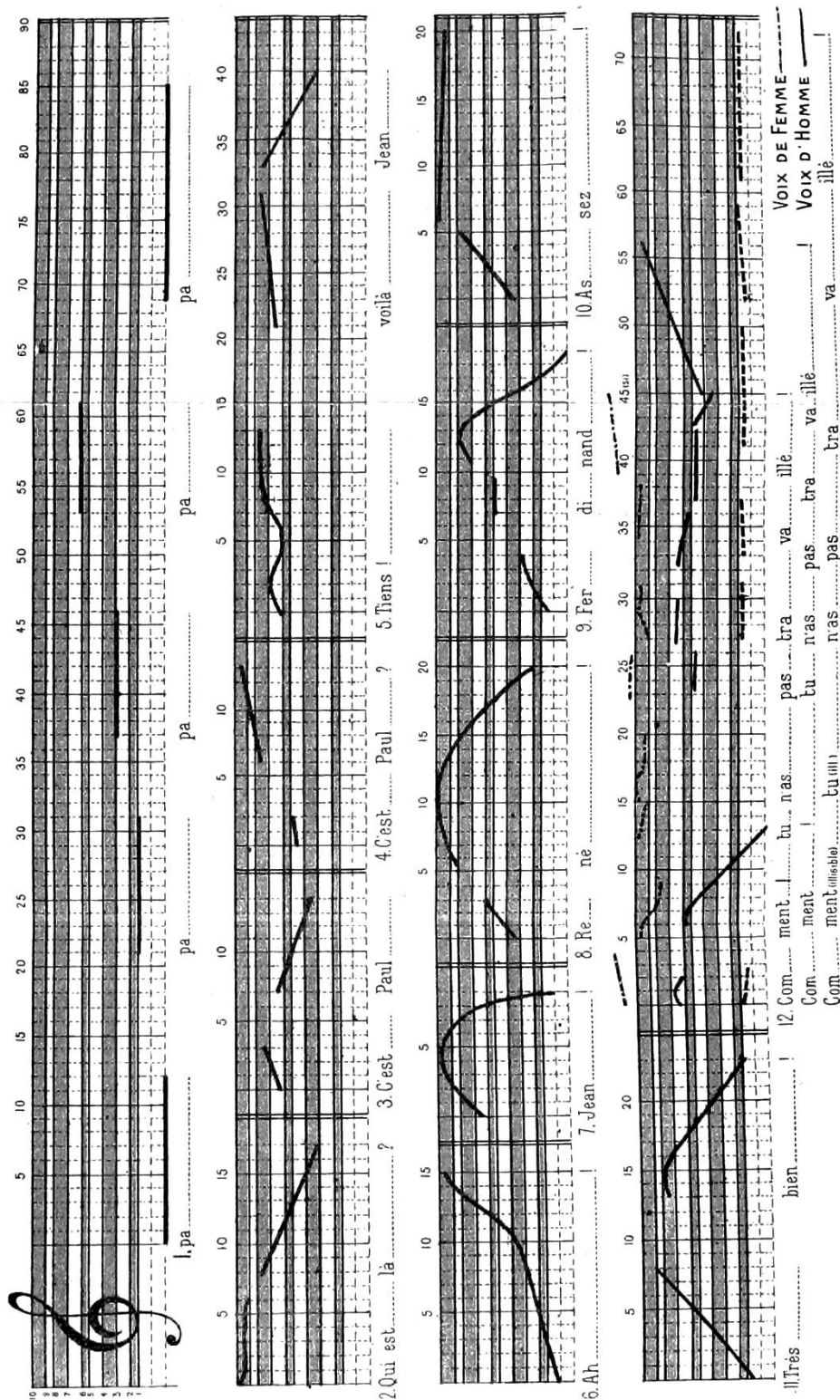

FHT 42 Notation of intonations in French language according to Marichelle (1900).⁴⁶¹

La ligne inférieure (en tirets - - -) représente les inflexions à peu près nulles d'une voix de sourd.

⁴⁶¹ [Marichelle, 1897, p. 112-113 (Planche 11 inserted between ~)].

208

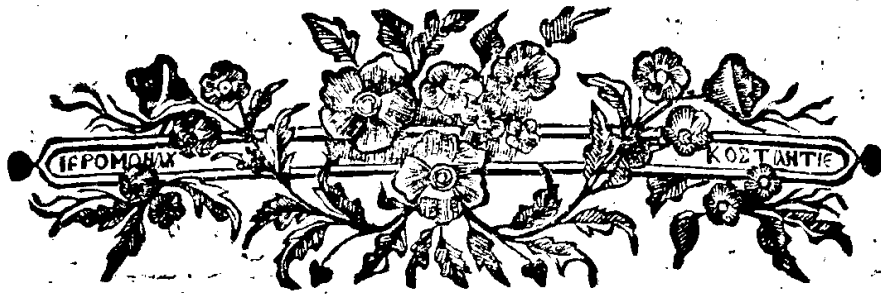

ἀρχὴ τοῦ πλαισίου τετάρτου ἡχοῦ. πέτρου βυζαντίου ἡχος ς̣ ς̣ - μη

↪ **Κ**υ ρι ε ε κε κρα ξα προ ος σε ε(λχ)ει σα κου ου ου
 σο ο ου μου ου ει σα ακου σο ου μου κυ υ υ ρι ε
 ε ε ε ε(δζ) κυ ρι ε ε κε εκρα ξα προ ος σε
 ε σα κου σο ο ου μου προσχε ες τη φω νη η η τη ης δε
 η σε ε ε ε ω ω ω ω ως μου(δζ) εν τω κε κρα γε
 υαι αι με προς σε ε ε ε ε ε ε(δζ) ει σα ακου σο ου μου
 κυ υ υ ρι ε ε ε ε ς̣
 ↪ **Κ**α τευ θυ θυ τω η προ σε ε ευ χη η η μου(λχ) ωι
 θυ μι α α μα α ε υω πι ε ε ε ε ο ο ο ο ου σου

FHT 43 Page 1 of the Byzantine notation of Kyrie Ekekraxa by Petros Byzantios – from [Ephesios, 1820, p. 208].

πα α ρ σ ε ι σ τ ω ω ν χ ε ι ρ ω ω ν μ ο υ ο υ θ υ σ ι ε
 α α ε σ π ε ρ ε ι ε ε υ η π η χ ε ι σ α κ α ι σ ο ο υ μ ο υ
 κυ υ υ υ ρ ε ι ε ι ε ε
 (H) ο υ κυ ρ ι ε φ υ λ α κ η ν τ ω σ τ ο μ α τ ι μ ο υ κ α ι θ υ
 υ ρ α ν π ε ρ ι ο χ η ς π ε ρ ι τ α χ ο ι λ η μ ο υ
 M η εκ κ λ η υ η ς τ η ν κ α ρ δι αυ μ ο υ ε ι σ λ ο γ ο υ ς π ο υ η ρ ε
 α ς τ ο υ π ρ ο φ α σ ι ζ ε σ θ α ι π ρ ο φ α σ ε ι ς ε υ α μ α ρ τ ι α ι ς
 Σ υ ν α ν θ ρ ω π ο ι ς ε ρ γ α ζ ο μ ε ε ν ο ι ς τ η ν α ν ο μ ι ε α ν
 κ α ι ο υ μ η σ υ ν θ υ α σ ω μ ε τ α τ ω ν εκ λε κ τ ω ν αυ τ ω ν
 Π αι δ ε υ σ ε ι μ ε δι κ α ι ο ς ε ν ε λε ει κ α ι ε λ ε γ ξ ε ι μ ε (X)
 ε ε λε ο υ δε α μ α ρ τ ω λ ο υ μ η λι πα ν α τ ω τ η ν κ ε φ α λ η ν
 μ ο υ
 O τ ι ε τ ι κ α ι η π ρ ο σ ε υ χ η μ ο υ ε ν τ α ι ς ε υ δ ο κ ι ε ι ς α υ
 τ ω ν (X) κ α τ ε π ρ ο θ η σ α ν ε χ ο μ ε ν α π ε τ ρ α ς ο ι κ ρ ι
 τ α ι αυ τ ω ν

Kyrie Ekekraxa

from the "Anastasimatarion" by Petros Efesios (1820)

Composed by Petros Byzantinos

Transnotated by Joseph Yazbeck and Amine Beyhom

1 $\text{♩} = 80$
4th mode plagal (8th mode)

Ky ri e E ke kra xa pro os se i

5 sa kou so on mou i sa kou

9 so on mou Ky ri e Ky

13 ri e E ke kra xa pros se i

17 sa kou so on mou pros khe es ti fo

21 ni ti is dhe i se o os

25 (26) = Beginning of the 2nd mode on g ($\delta\iota$)
mou en do ke kra ge ne me pro os

1

29 (31) Returning to the 8th mode on c (Nη)

se i sa kou so on mou

33 (35) New paragraph beginning with "Ka ..."

Ky ri e Ka tef thin

37

thi to i pro se ef khi mou os thi

41

mi a ma e no pi o on

45

sou E pa ar si is to on khi ro on

49

mou thi thi a e spe ri

53

ni i sa kou son mou Ky

57

ri e

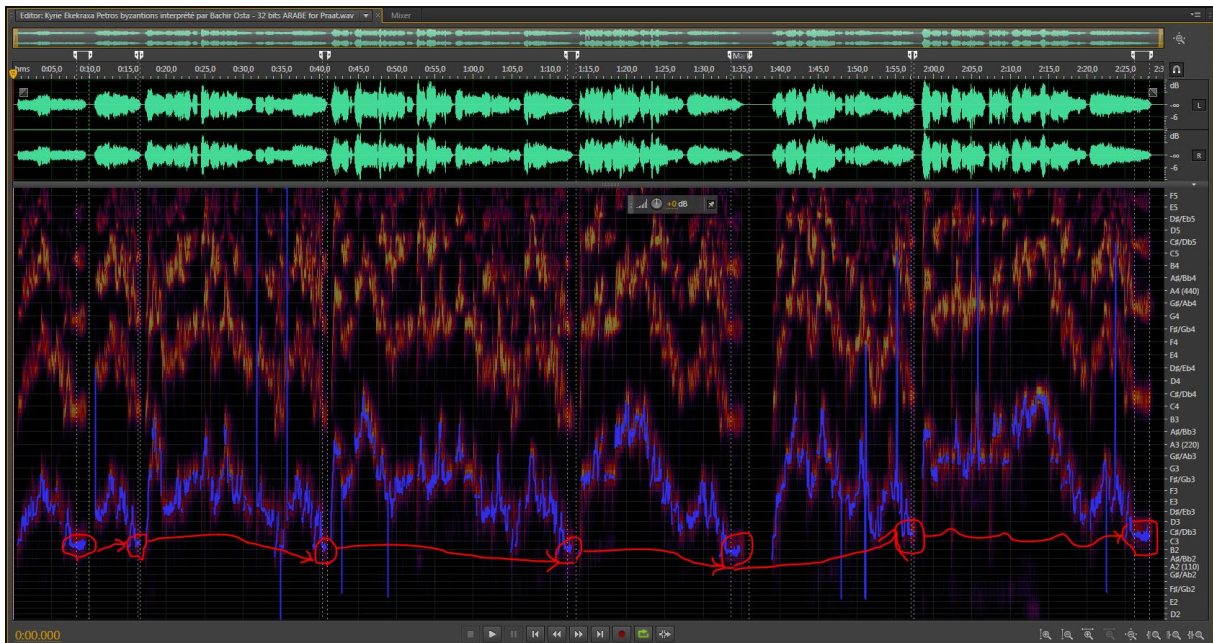

FHT 47 General view – and preliminary analysis – of the Arabic version of *Kyrie Ekekraxa* by Petros Byzantios in the interpretation of Bachir Osta, with approximated indicators for the change in the tonic pitches.

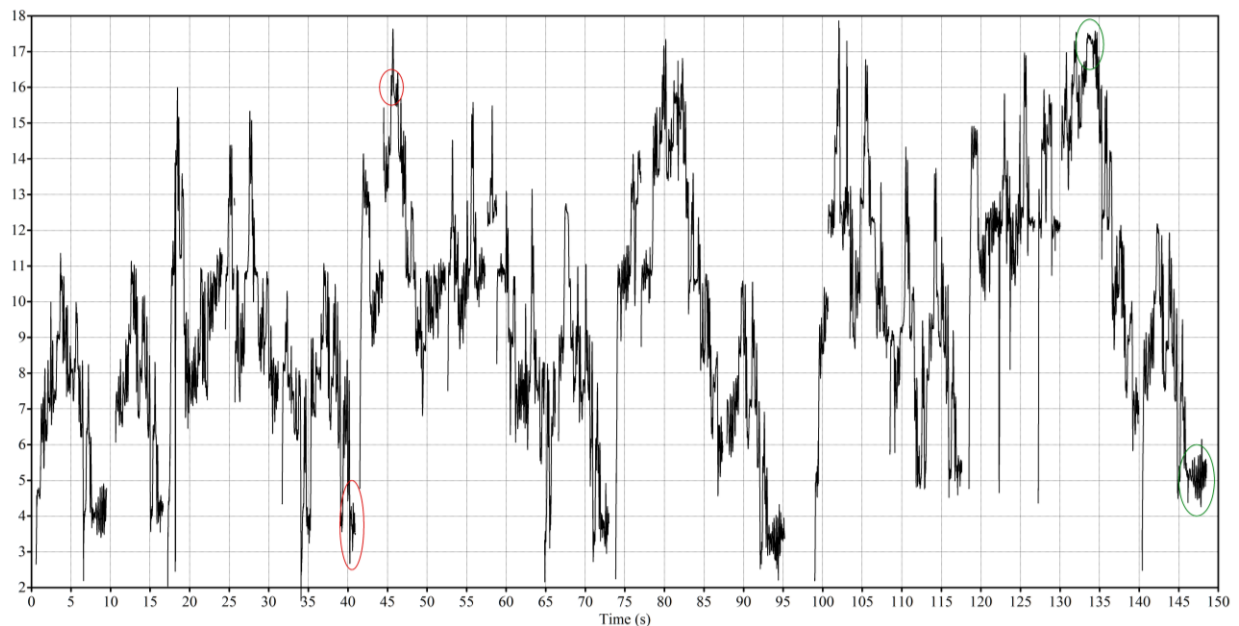

FHT 48 Global analysis of the Arabic version of *Kyrie Ekekraxa* by Petros Byzantios in the interpretation of Bachir Osta, with two neighboring tonics and octaves circled.

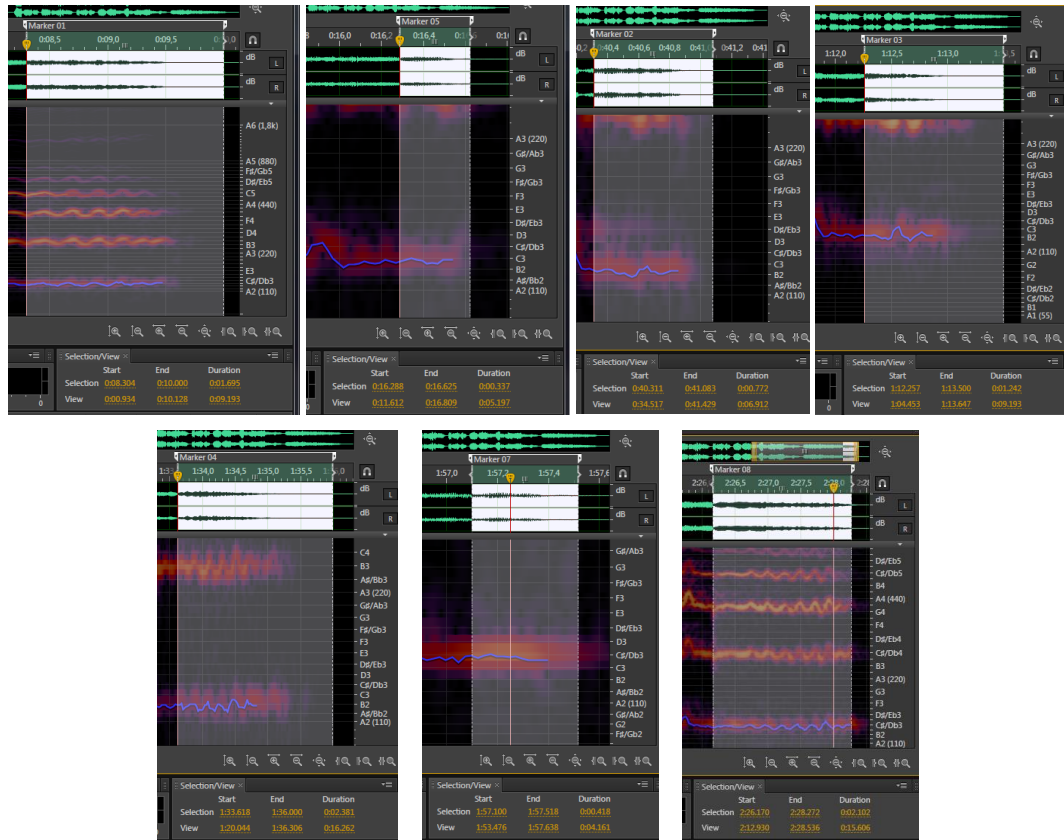

FHT 49 Seven tonic pitches from *Kyrie Ekekraxa* by Petros Byzantios and interpreted by Bachir Osta, marked for extraction and analysis.

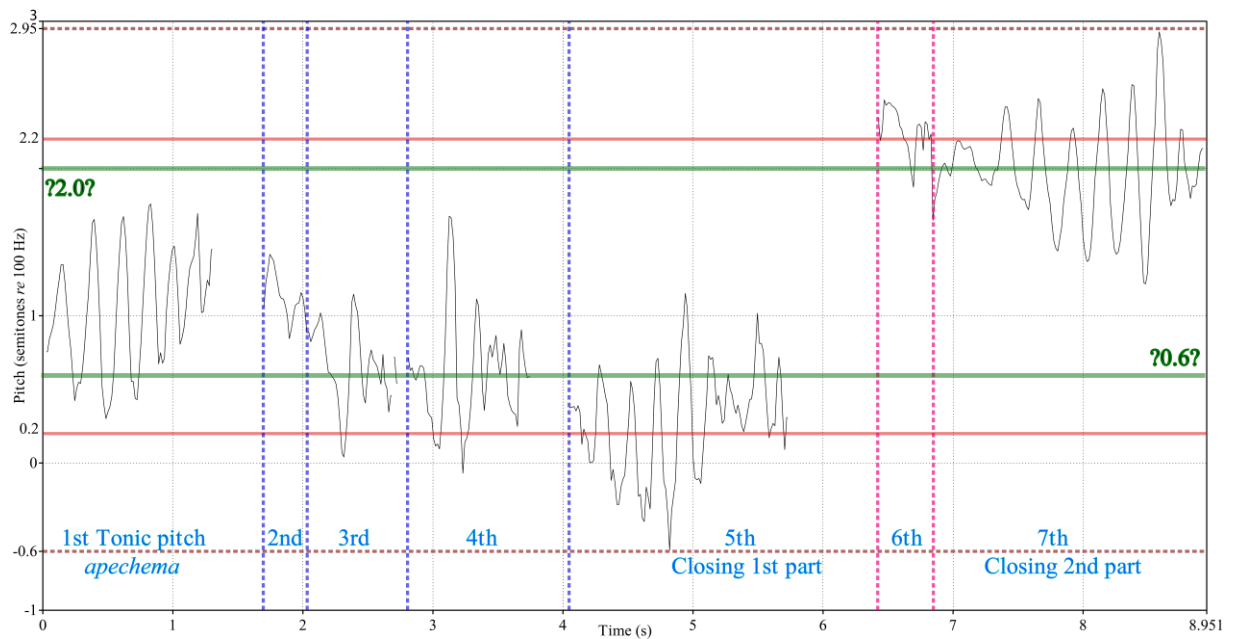

FHT 50 Seven tonic pitches from *Kyrie Ekekraxa* by Petros Byzantios and interpreted by Bachir Osta, extracted and analyzed with Praat.

Σειρά «Ἄξιόν ἐστιν» παρὰ διαφόρων.

Τὸ παρὸν ὀκτάνηχον οὐ ὁ μελοποιὸς ἀγνώστος. Ἦχος $\frac{4}{\bar{\eta}}$ Πα.

A ξι ον ε στιν ως α λη η η θω ως μ α
 κ κ ρ ι ι ζ ει ει εν Σ ι τ η η η ν θ ε ε ε ο ο το
 ο ο κ ο ν β τ η ν α ει ε μ κ κ κ α α ρ ι σ τ ο
 ο ν κ κ ι α ι π κ α ν κ α μ ω ω ω μ η η η η η
 τ ο ο ν π κ κ ι Μ η τ ε ε ε ε ε ρ κ τ ο υ ο υ θ ε ε
 ο υ ο υ ο υ η η η η μ ω ν ρ τ η ν τ ι μ ι ω
 τ ε ε ε ε ρ κ ν ρ τ ω ω ν λ ε ε ρ ο υ ο υ ο υ β ι μ
 κ κ ι εν δ ο ξ ο ο τ ε ε ε ρ κ ν α σ υ γ κ ρ ι τ ω ς τ ω ν Σ ε
 ε ρ κ α α ρ ε ι μ π τ η η ν α α δ ι α φ θ ο ο
 ο ο ρ ω ω ως λ θ ε ο ν λ ο ο ο ο ο γ ο ο ν τ ε
 κ ο υ ο υ ο υ ο υ σ κ ν τ η ν ο ο ν τ ω ω ς θ ε ο ο τ ο
 ο ο ο ο κ ο ο ο ο ν η η Σ ε ε ε μ ε ε γ α λ υ
 υ υ ν ο ο ο ο μ ε ε ε εν

FHT 51 Original Byzantine notation of Axion Estin by an Anonymous composer – from Κυριαζίδης, Αγαθάγγελος. Αἱ Δύο Μέλισσαι. Τόμος Β'. Κωνσταντινούπολη, 1906.

Axion Estin in 8 modes

Anonymous

Transnotated by fr. Romanos Joubran and Amine Beyhom

♩ = 90-100

1st mode

A- xi- on es- tin o- s a li- tho- os

5 2nd mode

ma- ka- ri- zi- in- se ti- in The- o- to- kon

10 3rd mode

tin a- i- ma- ka- ri- st on ke pa- na- mo-

16 4th mode

mi- ton ke mi-te- ra tou The- ou-

22 5th mode

i- mon tin ti- mi- o- te ran ton

27 6th mode

Che- rou- bin ke en- do- xo- te-

31

ran a- sing- ri- tos to- on Se- ra- fim

36 7th mode

ti- in a- di- a- ftho- ro- os The- on

41

Lo- go- on te- kou- san tin

45 8th mode

on- dos The- o- to- ko- on

49 1st mode

Se me- ga- li- no- me-

54

en

FHT 52 Transnotation of *Axion Estin* (Anonymous – see previous figure) by fr. Romanos Joubran and Amine Beyhom. Attractions are circled in orange, and the two “Natural” *βου* in green.

Axion eslim by anonymous: template analysis and performance analyses for nine performers

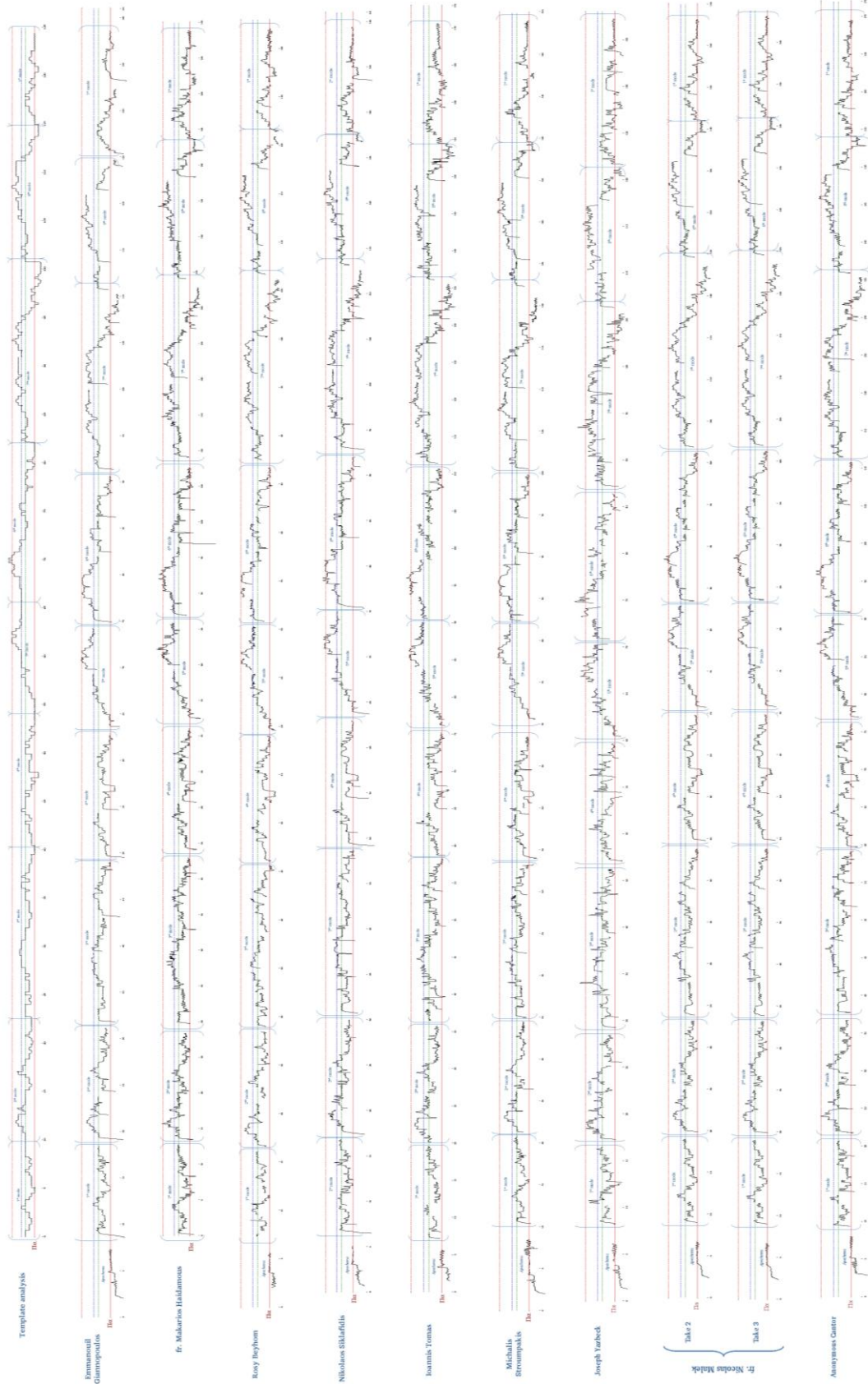

Analyzed and assembled by **Amine Beyhom**

FHT 53 Synoptic table of the graphic analyses of *Axion Estin* (Anonymous) used as a poster by the author.

N ^o .	1 st Octave (Lower)		2 nd Octave (Upper)		N ^o . (+ 24)
(O)	<i>g</i>	<i>NAWĀ/ jawāb-(al-)YĀKĀ</i>	<i>RAMAL-TŪTĪ</i>	<i>g</i>	(O)
24	<i>g^{1/2b}</i>	<i>tīk-ḤIJĀZ</i>	<i>jawāb-tīk-ḤIJĀZ</i>	<i>g^{1/2b}</i>	24 (48)
23	<i>f[#] / g^b</i>	<i>ḤIJĀZ/ṢABĀ</i>	<i>jawāb-ḤIJĀZ</i>	<i>f[#] / g^b</i>	23 (47)
22	<i>f^{1/2#}</i>	<i>nīm-ḤIJĀZ/‘ARABĀ’</i>	<i>jawāb-nīm-ḤIJĀZ</i>	<i>f^{1/2#}</i>	22 (46)
21	<i>f</i>	<i>JAHĀRKĀ</i>	<i>MĀHŪRĀN</i>	<i>f</i>	21 (45)
20	<i>e^{1/2#} / f^{1/2b}</i>	<i>tīk-BŪSALĪK</i>	<i>tīk-ḤUSAYNĪ-SHADD</i>	<i>e^{1/2#} / f^{1/2b}</i>	20 (44)
19	<i>e</i>	<i>BŪSALĪK</i>	<i>ḤUSAYNĪ-SHADD</i>	<i>e</i>	19 (43)
18	<i>e^{1/2b}</i>	<i>SĪKĀ</i>	<i>BUZURK</i>	<i>e^{1/2b}</i>	18 (42)
17	<i>d[#] / e^b</i>	<i>KURD</i>	<i>ZAWĀL/SUNBULA</i>	<i>d[#] / e^b</i>	17 (41)
16	<i>d^{1/2#}</i>	<i>nīm-KURD</i>	<i>nīm-ZAWĀL</i>	<i>d^{1/2#}</i>	16 (40)
15	<i>d</i>	<i>DŪKĀ</i>	<i>MUḤAYYAR</i>	<i>d</i>	15 (39)
14	<i>d^{1/2b}</i>	<i>tīk-ZĪRKŪLĀ</i>	<i>tīk-SHĀH-NĀZ</i>	<i>d^{1/2b}</i>	14 (38)
13	<i>c[#] / d^b</i>	<i>ZĪRKŪLĀ</i>	<i>SHĀH-NĀZ</i>	<i>c[#] / d^b</i>	13 (37)
12	<i>c^{1/2#}</i>	<i>nīm-ZĪRKŪLĀ</i>	<i>nīm-SHĀH-NĀZ (KUNNĀZ)</i>	<i>c^{1/2#}</i>	12 (36)
11	<i>c</i>	<i>RĀST</i>	<i>KARDĀN/MĀHŪR</i>	<i>c</i>	11 (35)
10	<i>b^{1/2#} / c^{1/2b}</i>	<i>tīk-KAWASHT</i>	<i>tīk-NAHAFT</i>	<i>b^{1/2#} / c^{1/2b}</i>	10 (34)
9	<i>b</i>	<i>KAWASHT</i>	<i>NAHAFT</i>	<i>b</i>	9 (33)
8	<i>b^{1/2b}</i>	<i>‘IRĀQ</i>	<i>AWJ</i>	<i>b^{1/2b}</i>	8 (32)
7	<i>a[#] / b^b</i>	<i>qarār-(al-)‘AJAM</i>	<i>‘AJAM</i>	<i>a[#] / b^b</i>	7 (31)
6	<i>a^{1/2#}</i>	<i>qarār-nīm-‘AJAM</i>	<i>nīm-‘AJAM</i>	<i>a^{1/2#}</i>	6 (30)
5	<i>a</i>	<i>‘USHAYRĀN</i>	<i>ḤUSAYNĪ</i>	<i>a</i>	5 (29)
4	<i>a^{1/2b}</i>	<i>qarār-tīk-ḤIṢĀR</i>	<i>tīk-ḤIṢĀR</i>	<i>a^{1/2b}</i>	4 (28)
3	<i>g[#] / a^b</i>	<i>qarār-ḤIṢĀR</i>	<i>ḤIṢĀR/SHŪRĪ</i>	<i>g[#] / a^b</i>	3 (27)
2	<i>g^{1/2#}</i>	<i>qarār-nīm-ḤIṢĀR</i>	<i>nīm-ḤIṢĀR</i>	<i>g^{1/2#}</i>	2 (26)
1	<i>g</i>	<i>YĀKĀ</i>	<i>NAWĀ</i>	<i>g</i>	1 (25)

FHT 54 Transliterated denominations of the degrees of the “Arabian” scale according to [Ḥilū (al-), 1972, p. 69]. “(O)” indicates an octave change; background colors follow the conventions expounded in [Beyhom, 2005, p. 112, Fig. 3.29] and [Beyhom, 2012]. Note that *BŪSALĪK* is here equivalent to *e* “natural” (compare with Khulā’ī’s *BŪSALĪK* in the next figure) and that *SHŪRĪ* is assimilated to *a^b* and to *ḤIṢĀR*, while *ṢABĀ* is equivalent to *ḤIJĀZ*.

NO.	NOTATION	MASHĀQA	KHULA‘Ī	ḤILŪ
(25)	g_2	<u>NAWĀ</u>	<u>NAWĀ</u>	<u>NAWĀ</u>
24	$g_2^{1/2b}$	<i>t</i> -ḤIJĀZ	<i>t</i> -ḤIJĀZ + ṢABĀ	<i>t</i> -ḤIJĀZ
23	$f_1^\# / g_2^b$	ḤIJĀZ	ḤIJĀZ	ḤIJĀZ + ṢABĀ
22	$f_1^{1/2\#}$	+ ‘ARABĀ’	<i>n</i> -ḤIJĀZ	+ ‘ARABĀ’
21	f_1	<u>JAHĀRKĀ</u>	<u>JAHĀRKĀ</u>	<u>JAHĀRKĀ</u>
20	$e_1^{1/2\#} / f_1^{1/2b}$	<i>t</i> -BŪSALĪK	BŪS. or ‘USHSHĀQ	<i>t</i> -BŪSALĪK
19	e_1	BŪSALĪK	<i>n</i> -BŪSALĪK	BŪSALĪK
18	$e_1^{1/2b}$	<u>SĪKĀ</u>	<u>SĪKĀ</u>	<u>SĪKĀ</u>
17	$d_1^\# / e_1^b$	KURDĪ	KURDĪ	KURD
16	$d_1^{1/2\#}$	<i>n</i> -KURDĪ	<i>n</i> -KURDĪ + NAH.	<i>n</i> -KURD
15	d_1	<u>DŪKĀ</u>	<u>DŪKĀ</u>	<u>DŪKĀ</u>
14	$d_1^{1/2b}$	<i>t</i> -ZĪRKULĀ	<i>t</i> -ZĪRKŪLA	<i>t</i> -ZĪRKŪLĀ
13	$c_1^\# / d_1^b$	ZĪRKULĀ	ZĪR. or ZĪNKULĀ	ZĪRKŪLĀ
12	$c_1^{1/2\#}$	<i>n</i> -ZĪRKULĀ	<i>n</i> -ZĪRKŪLA	<i>n</i> -ZĪRKŪLĀ
11	c_1	<u>RĀST</u>	<u>RĀST</u>	<u>RĀST</u>
10	$b_1^{1/2\#} / c_1^{1/2b}$	<i>t</i> -KAWASHT	KAWASHT + NAHAFT	<i>t</i> -KAWASHT
9	b_1	KAWASHT	<i>n</i> -K. + RAHĀWĪ	KAWASHT
8	$b_1^{1/2b}$	<u>‘IRĀQ</u>	<u>‘IRĀQ</u>	<u>‘IRĀQ</u>
7	$a_1^\# / b_2^b$	<i>q</i> -‘AJAM	‘AJAM-‘U.	<i>q</i> -‘AJAM
6	$a_1^{1/2\#}$	<i>q</i> - <i>n</i> -‘AJAM	<i>n</i> -‘AJAM-‘U.	<i>q</i> - <i>n</i> -‘AJAM
5	a_1	<u>‘USHAYRĀN</u>	<u>‘USHAYRĀN</u>	<u>‘USHAYRĀN</u>
4	$a_1^{1/2b}$	<i>q</i> - <i>t</i> -ḤIṢĀR	<i>t</i> - <i>q</i> -ḤIṢĀR + SHŪRĪ	<i>q</i> - <i>t</i> -ḤIṢĀR
3	$g_1^\# / a_1^b$	<i>q</i> -ḤIṢĀR	<i>q</i> -ḤIṢĀR	<i>q</i> -ḤIṢĀR
2	$g_1^{1/2\#}$	<i>q</i> - <i>n</i> -ḤIṢĀR	<i>n</i> - <i>q</i> -ḤIṢĀR	<i>q</i> - <i>n</i> -ḤIṢĀR
1	g_1	<u>YĀKĀ</u>	<u>YĀKĀ</u>	<u>YĀKĀ</u>
NO.	NOTATION	MASHĀQA	KHULA‘Ī	ḤILŪ

FHT 55 Compared denominations of the degrees of the lower octave of “Arabian” music according to Mashāqa, Khula‘ī and Ḥilū. BŪS. = BŪSALĪK; NAH. = NAHĀWAND; ‘U. = ‘USHAYRĀN; ZĪR. = ZĪRKŪLA; *q*- = *qarār* (“lower octave of”); *j*- = *jawāb* (“upper octave of”); *t*- = *tik* (“1 quarter-tone higher than”); *n*- = *nīm* (“1 quarter-tone lower than”); “+” = same as the other authors plus the following denomination. Detailed information is provided in footnotes to the original tables (in French) published in [Beyhom, 2014, p. 158–160].

NO.	NOTATION	MASHĀQA	KHULA‘Ī	ḤILŪ
(49)	g_3	<u>RAMAL-TŪTĪ</u>	<u>RAMAL-TŪTĪ</u>	<u>RAMAL-TŪTĪ</u>
48	g_3^{hb}	<i>j-t-ḤIJĀZ</i>	+ <i>j-ṢABĀ</i>	<i>j-t-ḤIJĀZ</i>
47	$f_2^\# / g_3^b$	<i>j-ḤIJĀZ</i>	<i>j-ḤIJĀZ</i>	<i>j-ḤIJĀZ</i>
46	$f_2^{h\#}$	+ <i>j-‘ARABĀ’</i>	<i>j-n-ḤIJĀZ</i>	<i>j-n-ḤIJĀZ</i>
45	f_2	<u>MĀHŪRĀN</u>	<u>MĀHŪRĀN</u>	<u>MĀHŪRĀN</u>
44	$e_2^{h\#} / f_2^{hb}$	<i>t-ḤUS.-SHADD</i>	<i>j-BŪSALIK</i>	<i>t-ḤUS.-SHADD</i>
43	e_2	<i>ḤUS.-SHADD</i>	<i>j-n-BŪSALIK</i>	<i>ḤUS.-SHADD</i>
42	e_2^{hb}	<u>BUZURK</u>	<u>j-SĪKĀ</u>	<u>BUZURK</u>
41	$d_2^\# / e_2^b$	SUNBULA	SUNBULA	+ ZAWĀL
40	$d_2^{h\#}$	<i>n-SUNBULA</i>	<i>n-SUNBULA</i>	<i>n-ZAWĀL</i>
39	d_2	<u>MUḤAYYAR</u>	<u>MUḤAYYAR</u>	<u>MUḤAYYAR</u>
38	d_2^{hb}	<i>t-SHĀH-NĀZ</i>	<i>t-SHĀH-NĀZ</i>	<i>t-SHĀH-NĀZ</i>
37	$c_2^\# / d_2^b$	<i>SHĀH-NĀZ</i>	<i>SHĀH-NĀZ</i>	<i>SHĀH-NĀZ</i>
36	$c_2^{h\#}$	<i>n-SHĀH-NĀZ</i>	<i>n-SHĀH-NĀZ</i>	+ <i>KUNNĀZ</i>
35	c_2	<u>MĀHŪR</u>	<u>KARDĀN</u>	+ <u>MĀHŪR</u>
34	$b_2^{h\#} / c_2^{hb}$	<i>t-NAHAFT</i>	<i>MĀHŪR + NAHAFT</i>	<i>t-NAHAFT</i>
33	b_2	<i>NAHAFT</i>	<i>n-MĀHŪR</i>	<i>NAHAFT</i>
32	b_2^{hb}	<u>AWJ</u>	<u>AWJ</u>	<u>AWJ</u>
31	$a_2^\# / b_3^b$	<i>‘AJAM</i>	<i>‘AJAM + NĪRIZ</i>	<i>‘AJAM + NĪRIZ</i>
30	$a_2^{h\#}$	<i>n-‘AJAM</i>	<i>n-‘AJAM</i>	<i>n-‘AJAM</i>
29	a_2	<u>HUSAYNĪ</u>	<u>HUSAYNĪ</u>	<u>HUSAYNĪ</u>
28	a_2^{hb}	<i>t-ḤIṢĀR</i>	+ <i>SHŪRĪ</i>	<i>t-ḤIṢĀR</i>
27	$g_2^\# / a_2^b$	<i>ḤIṢĀR</i>	<i>ḤIṢĀR</i>	<i>ḤIṢĀR / SHŪRĪ</i>
26	$g_2^{h\#}$	<i>n-ḤIṢĀR</i>	<i>n-ḤIṢĀR</i>	<i>n-ḤIṢĀR</i>
25	g_2	<u>NAWĀ</u>	<u>NAWĀ</u>	<u>NAWĀ</u>
NO.	NOTATION	MASHĀQA	KHULA‘Ī	ḤILŪ

FHT 56 Compared denominations of the degrees of the upper octave of “Arabian” music according to Mashāqa, Khula‘ī and Ḥilū. ḤUS. = ḤUSAYNĪ; *q* = *qarār* (“lower octave of”); *j* = *jawāb* (“upper octave of”); *t* = *tik* (“1 quarter-tone higher than”); *n* = *nīm* (“1 quarter-tone lower than”); “+” = same as the other authors plus the following denomination. Detailed information is provided in footnotes to the original tables (in French) published in [Beyhom, 2014, p. 158–160].

Solmi- zation	7 'burdāt	7 'arabāt	7 tīkāt + 7 nīmāt	Hijāzī	Extended Solmization	"Modern"
Rā, rā	KIRDĀN			(29)	Rā, rā	(25)
	(KAWASHT)	NAHAFT	tīk-NAHAFT	28	t-Ka, t-ka	24
			nīm-NAHAFT	27	Ka, ka	23
Aw, aw	AWJ			26	n-Ka, n-ka	
		'AJAM	tīk-'AJAM	25	Aw, aw	22
			nīm-'AJAM	24	t-'Aj, t-'aj	
Ḥu, ḥu	ḤUSAYNĪ			23	'Aj, 'aj	21
		ḤIṢĀR	tīk-ḤIṢĀR	22	n-'Aj, 'aj	20
			nīm-ḤIṢĀR	21	Ḥu, ḥu	19
Na, na	NAWĀ			20	t-Ḥiṣ, t-ḥiṣ	18
		ḤIṢĀR	tīk-ḤIṢĀR	19	Ḥiṣ, ḥiṣ	17
			nīm-ḤIṢĀR	18	n-Ḥiṣ, n-ḥiṣ	16
Ja, ja	JAHĀRKĀ			17	Na, na	15
		ḤIṢĀR	tīk-ḤIṢĀR	16	t-Ḥij, t-ḥij	14
		ḤIṢĀR	nīm-ḤIṢĀR	15	Ḥij, ḥij	13
		BŪSALĪK	tīk-BŪSALĪK	14	n-Ḥij, n-ḥij	12
			nīm-BŪSALĪK	13	Ja, ja	11
Sī, sī	SĪKĀ			12	t-Bū, t-bū	10
		BŪSALĪK	tīk-BŪSALĪK	11	Bū, bū	9
			nīm-BŪSALĪK	10	n-Bū, n-bū	
		KURDĪ	tīk-KURDĪ	9	Sī, sī	8
			nīm-KURDĪ	8	t-Ku, t-ku	
Dū, dū	DŪKĀ			7	Ku, ku	7
		ZIRKŪLĀ	tīk-ZIRKŪLĀ	6	n-Ku, n-ku	6
			nīm-ZIRKŪLĀ	5	Dū, dū	5
		ZIRKŪLĀ	tīk-ZIRKŪLĀ	4	t-Zi, t-zi	4
			nīm-ZIRKŪLĀ	3	Zi, zi	3
Rā, rā	RĀST			2	n-Zi, n-zi	2
				1	Rā, rā	1

FHT 57 Extended solmization of the scale of *maqām* music as proposed by the author. Columns from left to right: (1) Original (7 notes per octave) solmization proposed in [Beyhom, 2012]; (2) Names of the main notes of the scale (the *burdāt* of *maqām RĀST*); (3) Names of the intermediate notes between the *burdāt* ('*arabāt*); (4) Names of the intermediate notes between the '*arabāt* (*tīk* = raised, *nīm* = lowered); (5) number of the note in the scale of al-Ḥijāzī; (6) Extended solmization as proposed by the author; (7) Corresponding numbers of the notes in the "Modern" scale (Western-inspired on the base of the division of the half-tone in two equal parts). Note that RĀST equates with *c* while however not indicating a fixed (but a relative) pitch. Degrees *tīk-KURDĪ*, *nīm-BŪSALĪK*, *tīk-'AJAM* and *nīm-NAHAFT* figure on a gray background to underline the fact that the "Modern" theory of the scale does not acknowledge them: consequently, the intervals between adjacent notes in column (7) – the last to the right – differ one from another by one quarter-tone (theoretical). Lastly: the solmization of note NAHAFT was modified as to avoid creating a duplicate with the (main) note NAWĀ: KAWASHT is the equivalent of NAHAFT in the lower octave (below the RĀST). See also the tables in FHT 54 for a complete review of the degrees of the two-octavial scale of *maqām* music.

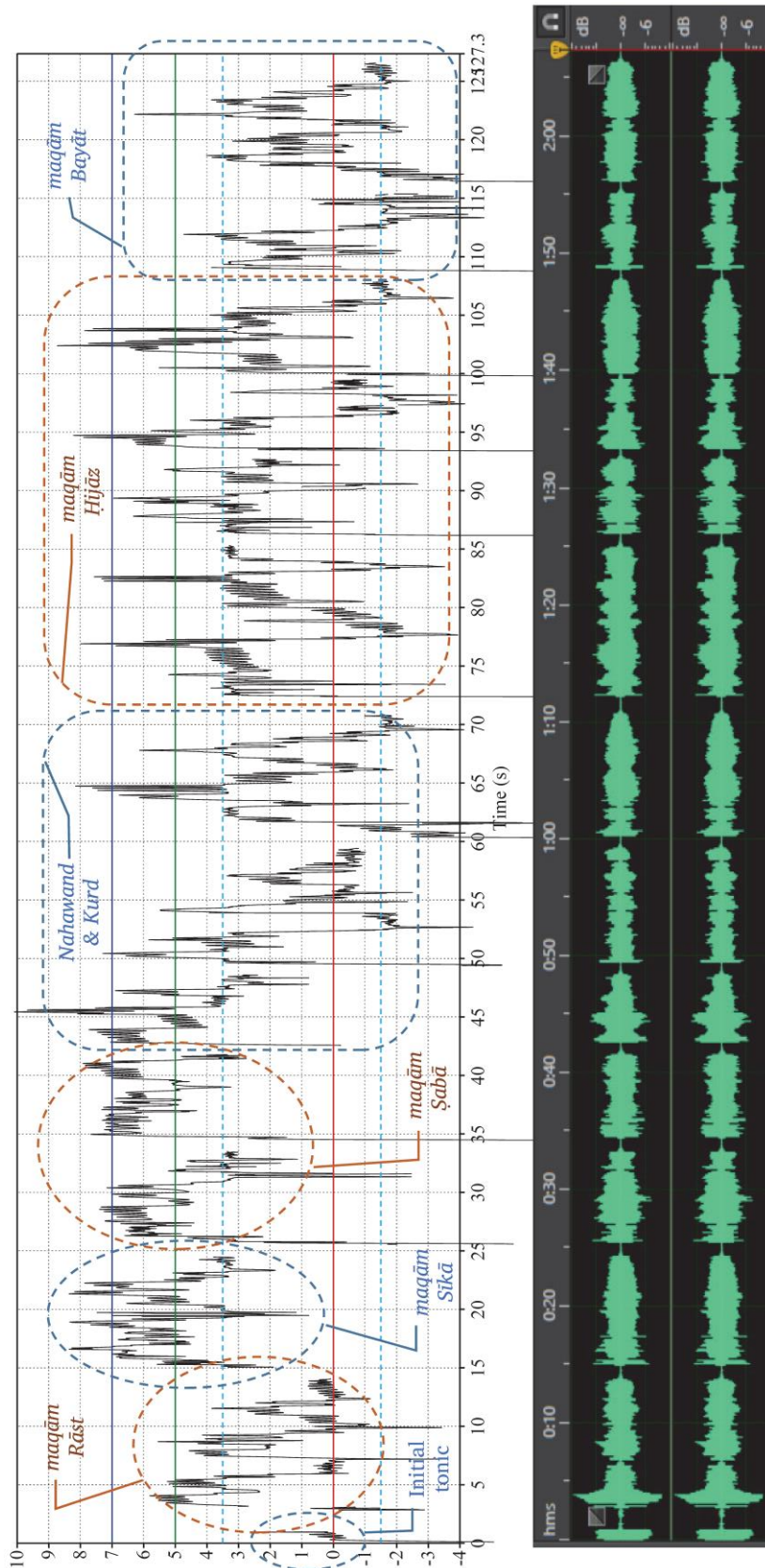

FHT 58 An overview of the analysis of the 7 maqāmāt piece by Muḥammad al-Ghazālī.

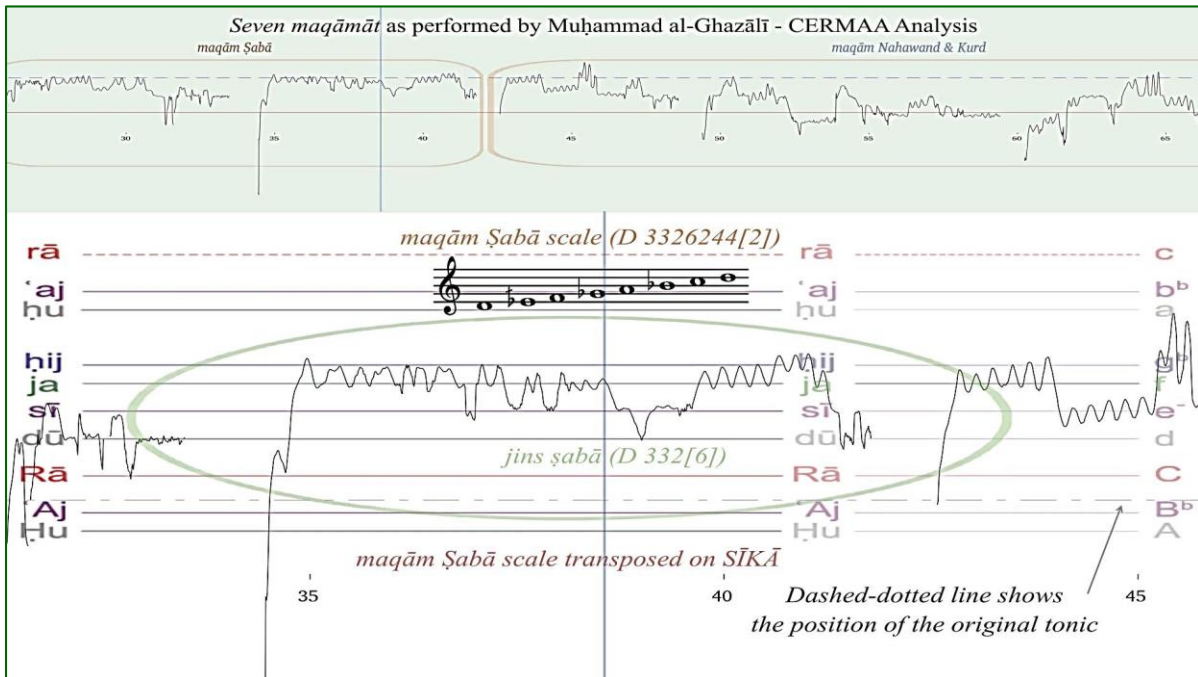
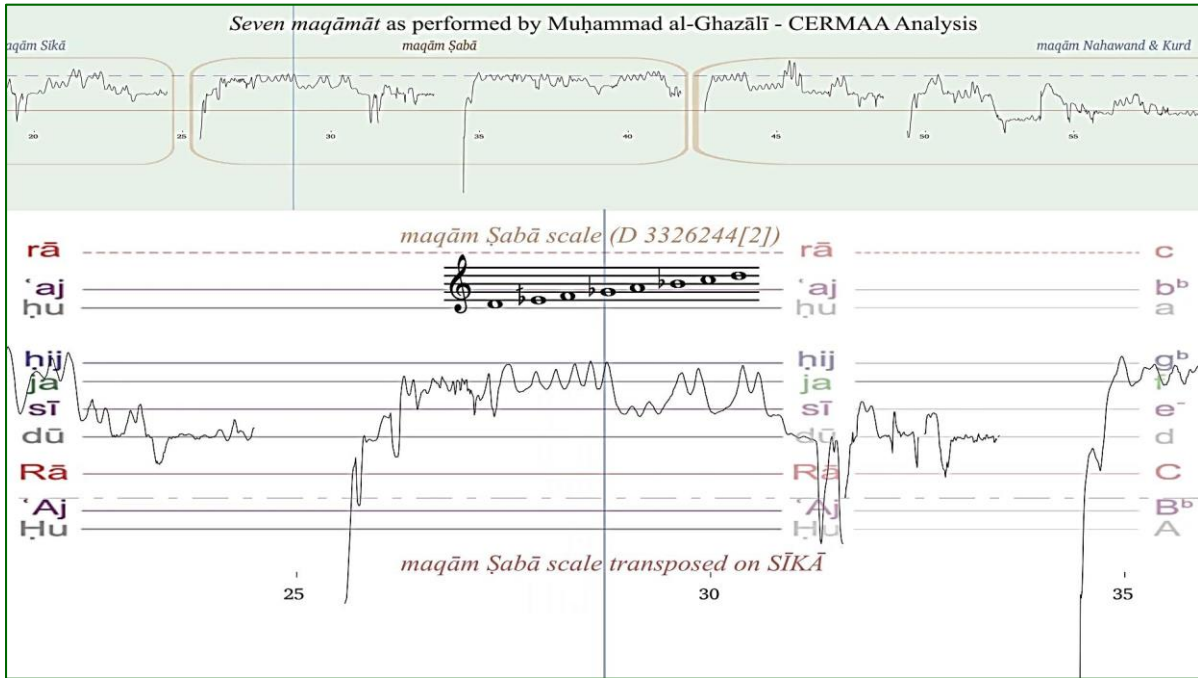

FHT 59 Two frames from the video-animated analysis of 7 maqāmāt as performed by the qārī' Muḥammad al-Ghazālī.

References

1. ABRAHAM, Otto and Erich Moritz (von) HORNBOSEL: “Studien über das Tonsystem und die Musik der Japaner”, *Sammelbände der Internationalen Musikgesellschaft* 4 2 [1903-2-1] [url: <http://www.jstor.org/stable/929003>] p. 302–360.
2. ABRAHAM, Otto and Erich Moritz (von) HORNBOSEL: “Phonographierte indische Melodien”, *Sammelbände der Internationalen Musikgesellschaft* 5 3 [1904-5-1] [url: <http://www.jstor.org/stable/929162>] p. 348–401.
3. ABRAHAM, Otto and Erich Moritz (von) HORNBOSEL: “Über die Harmonisierbarkeit exotischer Melodien”, *Sammelbände der Internationalen Musikgesellschaft* 7 1 [1905-1-1] [url: <http://www.jstor.org/stable/929150>] p. 138–141.
4. ABRAHAM, Otto and Erich Moritz (von) HORNBOSEL: “Vorschläge für die Transkription exotischer Melodien”, *Sammelbände der Internationalen Musikgesellschaft* 11 1 [1909-10-1] [url: <http://www.jstor.org/stable/929275>] p. 1–25.
5. ABRAHAM, Otto and Erich Moritz (von) HORNBOSEL: “Suggested Methods for the Transcription of Exotic Music”, *Ethnomusicology* 38 3 [1994-10-1] [doi: 10.2307/852110. url: <http://www.jstor.org/stable/852110>] p. 425–456.
6. ALLAN, GE: “XVIII. The musical scale of the highland bagpipe”, *The London, Edinburgh, and Dublin Philosophical Magazine and Journal of Science* 29 193 [1940] p. 154–161.
7. Anon. “DOTĀR” [url: <http://www.iranicaonline.org/articles/dotar>].
8. Anon. “First name Shirzad - Namepedia” [url: <http://namepedia.org/en/firstname/Shirzad/>].
9. Anon. “From the Editor (Vol. 8, issue 3)”, *Ethnomusicology* 8 3 [1964] [url: <http://www.jstor.org/stable/850123>] p. iv.
10. Anon. “How Can I Keep From Singing? A Seeger Family Tribute (The American Folklife Center, Library of Congress)” [url: <http://www.loc.gov/folklife/Seegersymposium/>].
11. Anon. “iAnalyse 3 & 4 | Pierre Couprie” [url: http://logiciels.pierrecouprie.fr/?page_id=672].
12. Anon. “Notation musicale et visualisation du son - SEEM” [url: <http://seem.paris-sorbonne.fr/Notation-musicale-et-visualisation>].
13. Anon. “Pierre Couprie | Logiciels” [url: <http://logiciels.pierrecouprie.fr/>].
14. Anon. “pierrecouprie (Pierre Couprie)”, *GitHub* [url: <https://github.com/pierrecouprie>].
15. Anon. “Seeger Family Concert”, Video, *Library of Congress, Washington, D.C. 20540 USA* [url: <https://www.loc.gov/item/ihas.200196407/>].
16. Anon. “sheikh”, *The Free Dictionary* [url: <https://www.thefreedictionary.com/sheikh>].
17. Anon. “Sheikh | Arabic title”, *Encyclopædia Britannica* [url: <https://www.britannica.com/topic/sheikh>].
18. Anon. “Sonic Visualiser” [url: <https://www.sonicvisualiser.org/>].
19. ANONYME: *A-sh-Shajara Dhāt al-Akmām al-Hāwiya li-Uṣūl al-Anghām [The tree with calyxes which contains the origins of the melodies]*, editors Ghattās ‘Abd-al-Malik Khashaba (غطّاس عبد الملك خشبة) and Isis Fath-al-Lāh (إيزيس فتح الله), *Al-Hay’ā al-Miṣriyya al-‘amma li-l-Kitāb (الهيئة المصرية العامة للكتاب)* [Le Caire, 1983-xiv^e siècle].
20. ANONYMOUS: *Kyrie Ekekraxa in Arabic*, Windows PCM (.wav), Comp. Petros (Byzantios), CDA-009 [Mansourieh - Liban, 2011a-5-25].
21. ANONYMOUS: *Kyrie Ekekraxa in Greek*, Windows PCM (.wav), Comp. Petros (Byzantios) and Mitri Murr (al-), CDA-008 [Mansourieh - Liban, 2011b-5-25].
22. ANTAR, Thérèse (soeur Berthe): *Héritage de la musique orientale*, Dār Al-Ibdā’ [Beyrouth, 1999].
23. APEL, Willi: *The notation of polyphonic music, 900-1600*, Cambridge, Mass., Mediaeval Academy of America [1961] [url: <http://archive.org/details/notationofpolyph00apel>].
24. AROM, Simha: “Essai d’une notation des monodies a des fins d’analyse”, *Revue de Musicologie* 55 2 [1969-1-1] [doi: 10.2307/927823. url: <http://www.jstor.org/stable/927823>] p. 172–216.
25. AROM, Simha: “Une méthode pour la transcription de polyphonies et polyrythmies de tradition orale”, *Revue de Musicologie* 59 2 [1973-1-1] [doi: 10.2307/928853. url: <http://www.jstor.org/stable/928853>] p. 165–190.
26. AROM, Simha: “The Use of Play-Back Techniques in the Study of Oral Polyphonies”, *Ethnomusicology* 20 3 [1976] [doi: 10.2307/851046. url: <http://www.jstor.org/stable/851046>] p. 483–519.
27. AROM, Simha: “Nouvelles perspectives dans la description des musiques de tradition orale”, *Revue de Musicologie* 68 1/2 [1982-1-1] [doi: 10.2307/928289. url: <http://www.jstor.org/stable/928289>] p. 198–212.
28. ATKINSON, Charles M.: *The Critical Nexus: Tone-System, Mode, and Notation in Early Medieval Music, AMS studies in music*, Oxford University Press [Oxford; New York, 2008-12-19].
29. AZAR BEYHOM, Rosy: “La modalité écrite: un exemple avec Mikhā’il Mashāqa au XIX^e siècle”, *Near Eastern Musicology Online* 1 1 [2012-11] [url: <http://nemo-online.org/wp-content/uploads/2016/12/INTERNET-05-Article-NEMO-n%C2%B01-1-Rozy-Azar-Beyhom-Reissue-201612S.pdf>] p. 55–66.
30. BACHA, Toufic El: *Le violon et les quarts des tons, Vol. 2*, ed. Original, *CNSM (Liban)* 24, Conservatoire National de Musique (Liban) [Beyrouth - Liban, s.d. (199x)].
31. BAKER, Theodore: *Über die Musik der nordamerikanischen Wilden*, Ph.D., Universität Leipzig, Druck von Breitkopf & Härtel [Leipzig, 1882] [url: <http://archive.org/details/berdiemusikdem01bakegoog>].
32. BEHAR, Cem @ to Amine Beyhom: “do = sol” [2013-10-5].
33. BEHAR, Cem @ to Amine Beyhom: “Shadd-Araban” [2014-9-26].
34. BENT, Ian D., David W. HUGHES, Robert C. PROVINE, et al.: “Notation”, editor Stanley Sadie, *New Grove: Dictionary of Music & Musicians* 18/ [Oxford, 2001] p. 73–189.
35. BERGER, Donald Paul: “The Shakuhachi and the Kinko Ryū Notation”, *Asian Music* 1 2 [1969-10-1] [doi: 10.2307/833910. url: <http://www.jstor.org/stable/833910>] p. 32–72.
36. BEYHOM, Amine: *I. Systématique modale – Volume I*, Thèse de doctorat, Université Paris Sorbonne [2003a-9-1] [url: <http://foredo-fico.org/CERMAA/publications/publications-on-the-site/publications-amine-beyhom>].
37. BEYHOM, Amine: *Systématique modale – Volume II-III*, Thèse de doctorat, Université Paris Sorbonne [Paris, 2003b-9-1] [url: <http://foredo-fico.org/CERMAA/publications/publications-on-the-site/publications-amine-beyhom>].

38. BEYHOM, Amine: 2. *Systématique modale – Volume II*, Thèse de doctorat, Université Paris Sorbonne [2003c-9-2] [url: <http://foredofico.org/CERMAA/publications/publications-on-the-site-publications-amine-beyhom>].
39. BEYHOM, Amine: 3. *Systématique modale – Volume III*, Thèse de doctorat, Université Paris Sorbonne [2003d-9-3] [url: <http://foredofico.org/CERMAA/publications/publications-on-the-site-publications-amine-beyhom>].
40. BEYHOM, Amine: “Systématique modale: génération et classement d’échelles modales”, *Musurgia XI* 4 [2004-12] [url: http://foredofico.org/CERMAA/wp-content/uploads/2017/11/Beyhom-2004-Systématique-modale-intro-appendices-Musurgia-XI-4-2004_OCR.pdf] p. 55–68.
41. BEYHOM, Amine: “Approche systématique de la musique arabe: genres et degrés système”, *De la théorie à l’Art de l’improvisation: analyse de performances et modélisation musicale*, ed. Mondher Ayari, Delatour |Paris, 2005-12| [url: http://foredofico.org/CERMAA/wp-content/uploads/2017/11/Beyhom_2005_Genres_et_echelle_système_Delatour.pdf] p. 65–114.
42. BEYHOM, Amine: “Dossier: Mesures d’intervalles – méthodologie et pratique”, *Revue des Traditions Musicales des Mondes Arabe et Méditerranéen 1* 1 [2007-6] [url: http://foredofico.org/CERMAA/wp-content/uploads/2017/11/Beyhom_2007_Mesures_d_intervalles_RTMMAM_n11.pdf] p. 181–235.
43. BEYHOM, Amine: “A new hypothesis on the elaboration of heptatonic scales and their origins”, *ICONEA 2008*, Lulu on behalf of ICONEA PUBLICATIONS, LONDON-UK [London, 2010a] [url: <http://foredofico.org/CERMAA/wp-content/uploads/2017/11/ICONEA-2008-2010-Hypothesis-Beyhom-complete.pdf>] p. 151–209.
44. BEYHOM, Amine: *Une approche systématique et diachronique de la modalité maqamiyye*, Mémoire d’habilitation à diriger les recherches (HDR), Université Paris Sorbonne |Paris (France), 2010b-3-9|.
45. BEYHOM, Amine: *Théories de l’échelle et pratiques mélodiques chez les Arabes – Volume 1 : L’échelle générale et les genres – Tome 1 : Théories gréco-arabes de Kāndī (IX^e siècle) à Tūsi (XIII^e siècle) 1/4* (vols.), Librairie orientaliste Paul Geuthner |Paris, 2010c-11|.
46. BEYHOM, Amine: “*Kashf al-Asrār ‘an Karkarat al-Aḥbār fi Ta’wīl al-Adwār*”, *Kشف الأسرار عن كركرة الأحبار في تؤول الأوار*, *Near Eastern Musicology Online 1* 1 [2012-11] [url: <http://nemo-online.org/wp-content/uploads/2016/12/INTERNET-06-Article-NEMO-n%C2%B01-1-Amine-Beyhom-Reissue-201612S.pdf>] p. 67–88.
47. BEYHOM, Amine: “Dossier: Influence des théories européanisées du XIX^e siècle sur la notation et la pratique des modes de la musique arabe et d’autres musiques, à travers la mise en exergue du mythe du genre *ḥijāz* semi-tonal”, *Near Eastern Musicology Online 2* 3 [2014-11] [url: <http://nemo-online.org/wp-content/uploads/2016/12/INTERNET-06-Article-NEMO-n%C2%B01-1-Amine-Beyhom-Reissue-201612S.pdf>] p. 87–177.
48. BEYHOM, Amine: *Théories et pratiques de l’échelle dans le chant byzantin arabe: Une approche comparative et analytique proposant une solution inédite pour le système théorique de Chrysanthos le Madyte*, Par l’auteur |Broummana (Liban), 2015-9|.
49. BEYHOM, Amine: “Dossier: Hellenism as an Analytical tool for Occidentism (in musicology) (V2)”, *Near Eastern Musicology Online 3* 5 [2016a-11] [url: [http://nemo-online.org/wp-content/uploads/2017/02/\(V2-INTERNET\)%205-04.%20Article%20NEMO%20n%C2%B05%20Amine%20Beyhom%20170219S.pdf](http://nemo-online.org/wp-content/uploads/2017/02/(V2-INTERNET)%205-04.%20Article%20NEMO%20n%C2%B05%20Amine%20Beyhom%20170219S.pdf)] p. 53–275.
50. BEYHOM, Amine: “Dossier: Hellenism as an Analytical tool for Occidentism (in musicology)”, *Near Eastern Musicology Online 3* 5 [2016b-11] [url: <http://nemo-online.org/articles>] p. 53–273.
51. BEYHOM, Amine: “A Hypothesis for the Elaboration of Heptatonic Scales”, *Near Eastern Musicology Online 4* 6 [2017-11] [url: <http://nemo-online.org/>] p. 5–89.
52. BEYHOM, Amine: *HURRIAN SONG 6 (H6) by CERMAA (DUMBRILL BEYHOM AZAR-BEYHOM JOKHADAR)*, 1920x1080, CERMAA |Broummana, 2018a-2-15| [url: <https://www.youtube.com/watch?v=U8Yr6mKc550>].
53. BEYHOM, Amine: *Kyrie Ekekraxa by Petros Byzantios performed by fr. Makarios Haidamous in Arabic*, 1920x1080, *Kyrie Ekekraxa by Petros Byzantios*, CERMAA |Broummana - Lebanon, 2018b-2-16| [url: https://www.youtube.com/edit?o=U&video_id=j8w9i9CfF0c].
54. BEYHOM, Amine: *Kyrie Ekekraxa by Petros Byzantios performed by an Anonymous Cantor in Greek*, 1920x1080, *Kyrie Ekekraxa by Petros Byzantios*, CERMAA |Broummana - Lebanon, 2018c-2-19| [url: https://www.youtube.com/edit?o=U&video_id=ush88CvgQYk].
55. BEYHOM, Amine: *Kyrie Ekekraxa by Petros Byzantios performed by fr. Makarios Haidamous in Greek*, 1920x1080, *Kyrie Ekekraxa by Petros Byzantios*, CERMAA |Broummana - Lebanon, 2018d-2-19| [url: https://www.youtube.com/edit?o=U&video_id=8SSETdJWC8o].
56. BEYHOM, Amine: *Kyrie Ekekraxa by Petros Byzantios performed by an Anonymous Cantor in Arabic*, 1920x1080, *Kyrie Ekekraxa by Petros Byzantios*, CERMAA |Broummana - Lebanon, 2018e-2-19| [url: https://www.youtube.com/edit?o=U&video_id=Uek_ADaRQg].
57. BEYHOM, Amine: *Kyrie Ekekraxa by Petros Byzantios performed by fr. Nicolas Malek in Arabic*, 1920x1080, *Kyrie Ekekraxa by Petros Byzantios*, CERMAA |Broummana - Lebanon, 2018f-2-22| [url: https://www.youtube.com/edit?o=U&video_id=wI-hyN30y-qc].
58. BEYHOM, Amine: *Kyrie Ekekraxa by Petros Byzantios performed by fr. Nicolas Malek in Greek*, 1920x1080, *Kyrie Ekekraxa by Petros Byzantios*, CERMAA |Broummana - Lebanon, 2018g-2-22| [url: https://www.youtube.com/edit?o=U&video_id=w6YWloCd2Do].
59. BEYHOM, Amine: *Kyrie Ekekraxa by Petros Byzantios performed by Joseph Yazbeck in Arabic (abrid.)*, 1920x1080, *Kyrie Ekekraxa by Petros Byzantios*, CERMAA |Broummana - Lebanon, 2018h-2-26| [url: https://www.youtube.com/edit?o=U&video_id=QvKcoi7LdVI].
60. BEYHOM, Amine: *Kyrie Ekekraxa by Petros Byzantios performed by Joseph Yazbeck in Greek (abrid.)*, 1920x1080, *Kyrie Ekekraxa by Petros Byzantios*, CERMAA |Broummana - Lebanon, 2018i-2-26| [url: https://www.youtube.com/edit?o=U&video_id=uvElBc7-3-4].
61. BEYHOM, Amine: *Kyrie Ekekraxa by Petros Byzantios performed by Bachir Osta in Arabic*, 1920x1080, *Kyrie Ekekraxa by Petros Byzantios*, CERMAA |Broummana - Lebanon, 2018j-9-6| [url: https://www.youtube.com/edit?o=U&video_id=QvKcoi7LdVI].
62. BEYHOM, Amine: *Kyrie Ekekraxa by Petros Byzantios performed by Bachir Osta in Arabic (Half-Tempo)*, 1920x1080, *Kyrie Ekekraxa by Petros Byzantios*, CERMAA |Broummana - Lebanon, 2018k-9-6| [url: https://www.youtube.com/edit?o=U&video_id=QvKcoi7LdVI].

63. BEYHOM, Amine : *Kyrie Ekekraxa by Petros Byzantios performed by Bachir Osta in Greek*, 1920x1080, *Kyrie Ekekraxa by Petros Byzantios*, CERMAA |Broummana - Lebanon, 2018l-9-6| [url: <https://youtu.be/WQVdSqLh1v4>].
64. BEYHOM, Amine : *Kyrie Ekekraxa by Petros Byzantios performed by Bachir Osta in Greek (Half-Tempo)*, 1920x1080, *Kyrie Ekekraxa by Petros Byzantios*, CERMAA |Broummana - Lebanon, 2018m-9-6| [url: https://youtu.be/Jcg_xSC5NXA].
65. BEYHOM, Amine : *Kyrie Ekekraxa by Petros Byzantios performed by an Anonymous Cantor in Arabic (V2)*, 1920x1080, *Kyrie Ekekraxa by Petros Byzantios*, CERMAA |Broummana - Lebanon, 2018n-9-6| [url: <https://youtu.be/uGL8PtgNH1Y>].
66. BEYHOM, Amine : *Kyrie Ekekraxa by Petros Byzantios performed by an Anonymous Cantor in Arabic (V2 - Half-Tempo)*, 1920x1080, *Kyrie Ekekraxa by Petros Byzantios*, CERMAA |Broummana - Lebanon, 2018o-9-6| [url: <https://youtu.be/2-zsuOXtFsU>].
67. BEYHOM, Amine : *Kyrie Ekekraxa by Petros Byzantios performed by an Anonymous Cantor in Greek (V2)*, 1920x1080, *Kyrie Ekekraxa by Petros Byzantios*, CERMAA |Broummana - Lebanon, 2018p-9-6| [url: <https://youtu.be/f-QHaMJ5138>].
68. BEYHOM, Amine : *Kyrie Ekekraxa by Petros Byzantios performed by an Anonymous Cantor in Greek (V2 - Half-Tempo)*, 1920x1080, *Kyrie Ekekraxa by Petros Byzantios*, CERMAA |Broummana - Lebanon, 2018q-9-6| [url: <https://youtu.be/cVvWfTQE8Dc>].
69. BEYHOM, Amine : *Kyrie Ekekraxa by Petros Byzantios performed by Emmanouil Giannopoulos*, 1920x1080, *Kyrie Ekekraxa by Petros Byzantios*, CERMAA |(Volos) Broummana - (Greece) Lebanon, 2018r-9-6| [url: https://youtu.be/7_DawLHFcOkI].
70. BEYHOM, Amine : *Kyrie Ekekraxa by Petros Byzantios performed by Ioannis Tomas*, 1920x1080, *Kyrie Ekekraxa by Petros Byzantios*, CERMAA |(Volos) Broummana - (Greece) Lebanon, 2018s-9-6| [url: <https://youtu.be/ettIzTmrlpw>].
71. BEYHOM, Amine : *Kyrie Ekekraxa by Petros Byzantios performed by Michalis Stroumpakis*, 1920x1080, *Kyrie Ekekraxa by Petros Byzantios*, CERMAA |(Volos) Broummana - (Greece) Lebanon, 2018t-9-6| [url: <https://youtu.be/Jje3EdE9bws>].
72. BEYHOM, Amine : *Kyrie Ekekraxa by Petros Byzantios performed by Nikolaos Siklaidis*, 1920x1080, *Kyrie Ekekraxa by Petros Byzantios*, CERMAA |(Volos) Broummana - (Greece) Lebanon, 2018u-9-6| [url: <https://youtu.be/AvNz2oUYSHY>].
73. BEYHOM, Amine : *Axion Estin by Anonymous performed by fr. Makarios Haidamous*, 1920x1080, *Axion Estin by Anonymous*, CERMAA |Broummana - Lebanon, 2018v-9-6| [url: <https://youtu.be/aWnwPvG0Ri8>].
74. BEYHOM, Amine : *Axion Estin by Anonymous performed by an Anonymous Cantor*, 1920x1080, *Axion Estin by Anonymous*, CERMAA |Broummana - Lebanon, 2018w-9-6| [url: <https://youtu.be/DWwRxGih8hM>].
75. BEYHOM, Amine : *Axion Estin by Anonymous performed by fr. Nicolas Malek*, 1920x1080, *Axion Estin by Anonymous*, CERMAA |Broummana - Lebanon, 2018x-9-6| [url: <https://youtu.be/UNYUfNwHuMj>].
76. BEYHOM, Amine : *Axion Estin by Anonymous performed by fr. Nicolas Malek (Alternate Take no. 2)*, 1920x1080, *Axion Estin by Anonymous*, CERMAA |Broummana - Lebanon, 2018y-9-6| [url: <https://youtu.be/JYZAJDyj60>].
77. BEYHOM, Amine : *Axion Estin by Anonymous performed by Joseph Yazbeck*, 1920x1080, *Axion Estin by Anonymous*, CERMAA |Broummana - Lebanon, 2018z-9-6| [url: https://youtu.be/_Cpyf9hqUEc].
78. BEYHOM, Amine : *Axion Estin by Anonymous performed by Emmanouil Giannopoulos*, 1920x1080, *Axion Estin by Anonymous*, CERMAA |(Volos) Broummana - (Greece) Lebanon, 2018aa-9-6| [url: <https://youtu.be/4VpOchjBEZA>].
79. BEYHOM, Amine : *Axion Estin by Anonymous performed by Nikolaos Siklaidis*, 1920x1080, *Axion Estin by Anonymous*, CERMAA |(Volos) Broummana - (Greece) Lebanon, 2018ab-9-6| [url: <https://youtu.be/gxoviviJs1aU>].
80. BEYHOM, Amine : *Axion Estin by Anonymous performed by Ioannis Tomas*, 1920x1080, *Axion Estin by Anonymous*, CERMAA |(Volos) Broummana - (Greece) Lebanon, 2018ac-9-6| [url: <https://youtu.be/QICHWCaOfQA>].
81. BEYHOM, Amine : *Axion Estin by Anonymous performed by Michalis Stroumpakis*, 1920x1080, *Axion Estin by Anonymous*, CERMAA |(Volos) Broummana - (Greece) Lebanon, 2018ad-9-6| [url: <https://youtu.be/qM34JswCUZo>].
82. BEYHOM, Amine : *Axion Estin by Anonymous performed by Rosy Beyhom*, 1920x1080, *Axion Estin by Anonymous*, CERMAA |Broummana - Lebanon, 2018ae-9-6| [url: <https://youtu.be/IDhi2g6dPkY>].
83. BEYHOM, Amine : *Axion Estin by Anonymous. Template Analysis of audio output by programs MUS2 (V2.1 - midi score) & CUBASE (V. 8.5 - HALION SONIC SE2 VST) - Left to Right*, 1920x1080, *Axion Estin by Anonymous*, CERMAA |Broummana - Lebanon, 2018af-9-6| [url: <https://youtu.be/YuRD6G4PTuE>].
84. BEYHOM, Amine : *Axion Estin by Anonymous. Template Analysis of audio output by programs MUS2 (V2.1 - midi score) & CUBASE (V. 8.5 - HALION SONIC SE2 VST) - Left to Right (Half-Tempo)*, 1920x1080, *Axion Estin by Anonymous*, CERMAA |Broummana - Lebanon, 2018ag-9-6| [url: https://youtu.be/MiRuhUt_tMQ].
85. BEYHOM, Amine : *Axion Estin by Anonymous. Template Analysis of audio output by programs MUS2 (V2.1 - midi score) & CUBASE (V. 8.5 - HALION SONIC SE2 VST) - Right to Left*, 1920x1080, *Axion Estin by Anonymous*, CERMAA |Broummana - Lebanon, 2018ah-9-6| [url: <https://youtu.be/j3lyDA-IFPE>].
86. BEYHOM, Amine : *Axion Estin by Anonymous. Template Analysis of audio output by programs MUS2 (V2.1 - midi score) & CUBASE (V. 8.5 - HALION SONIC SE2 VST) - Right to Left (Half-Tempo)*, 1920x1080, *Axion Estin by Anonymous*, CERMAA |Broummana - Lebanon, 2018ai-9-6| [url: <https://youtu.be/tDXJkXG08fo>].
87. BEYHOM, Amine : *7 Maqāmāt performed by Muḥammad al-Ghazālī*, 1920x1080, *Arabian Maqāmāt*, CERMAA |Broummana - Lebanon, 2018aj-9-6| [url: <https://youtu.be/Uc22jh65r0M>].
88. BEYHOM, Amine : *7 Maqāmāt performed by Muḥammad al-Ghazālī (Half-Tempo)*, 1920x1080, *Arabian Maqāmāt*, CERMAA |Broummana - Lebanon, 2018ak-9-6| [url: <https://youtu.be/6TvK2keRZe4>].
89. BEYHOM, Amine : *Ahlan bi-Ghazālin performed by sheikh ‘Alī Maḥmūd*, 1920x1080, *Arabian Maqāmāt*, CERMAA |Broummana - Lebanon, 2018al-9-6| [url: https://youtu.be/s_Nsm4mzFns].
90. BEYHOM, Amine : *Ahlan bi-Ghazālin performed by sheikh ‘Alī Maḥmūd (Half-Tempo)*, 1920x1080, *Arabian Maqāmāt*, CERMAA |Broummana - Lebanon, 2018am-9-6| [url: <https://youtu.be/3pbprgsRuRA>].
91. BEYHOM, Amine : *“Ar bern plouz” chanté par Manu Kerjean à Bonen (22) éd. Dastum*: Manu Kerjean Chanteur du Centre-Bretagne DAS153 (piste 15), 1920x1080, *Brittany*, CERMAA |Broummana - Lebanon, 2018an-10-10| [url: <https://youtu.be/IERM9mEw9g>].
92. BEYHOM, Amine : *“Ar bern plouz” chanté par Manu Kerjean à Bonen (22) éd. Dastum*: Manu Kerjean Chanteur du Centre-Bretagne

- DASI53 (piste 15) - *Tempo* = 1:3, 1920x1080, Brittany, CERMAA |Broummana - Lebanon, 2018ao-10-10| [url: <https://youtu.be/JYZAjDYjj60>].
93. BORREL, Eugène: “La musique turque”, *Revue de Musicologie* 3 4 |1922| [url: <http://www.jstor.org/stable/925743>] p. 149–161.
94. BORREL, Eugène: “La musique turque (Suite)”, *Revue de Musicologie* 4 5 |1923a| [doi: 10.2307/925512. url: <http://www.jstor.org/stable/925512>] p. 26–32.
95. BORREL, Eugène: “La musique turque (Suite et fin). Les Oussouls”, *Revue de Musicologie* 4 6 |1923b| [url: <http://www.jstor.org/stable/925898>] p. 60–70.
96. BORREL, Eugène: “Raouf Yekta Béy. (1871-1935)”, *Revue de Musicologie* 16 53 |1935-2-1| [url: <http://www.jstor.org/stable/925950>] p. 64.
97. BRÄILOU, Constantin: “Sur une mélodie russe”, ed. P. Souvtchinsky, *Musique Russe II*, Presses Universitaires de France |1953| p. 329–391.
98. BUSONI, Ferruccio: *Sketch Of A New Esthetic Of Music*, translator Theodore Baker, New York: G. Schirmer |1911| [url: <http://archive.org/details/sketchofanewsth000125mbp>].
99. CARPENTIER, Nan Cooke: “The Study of Music at the University of Paris in the Middle Ages”, *Journal of Research in Music Education* 2 2 |1954-10| [doi: 10.2307/3343693. url: <http://journals.sagepub.com/doi/10.2307/3343693>] p. 119–133.
100. CAZDEN, Norman: “Staff Notation as a Non-Musical Communications Code”, *Journal of Music Theory* 5 1 |1961-4-1| [doi: 10.2307/842874. url: <http://www.jstor.org/stable/842874>] p. 113–128.
101. CHABRIER, Jean-Claude Ch.: *Analyses de musiques traditionnelles. identification de systèmes acoustiques, scalaires, modaux et instrumentaux. représentation morpho-mélodique, structuro-modale et du langage instrumental Vol. 1 (A-B)*, Doctorat d'état, Université de Paris-Sorbonne |Paris - France, 1995|.
102. CHRYSANTHOS (DE MADYTOS): *Εισαγωγή εις το Θεωρητικόν και Πρακτικόν της Εκκλησιαστικής Μουσικής* [Eisagogē eis to theōrētikon kai praktikon tēs ekklesiastikēs mousikēs – Introduction to the Theory and Practice of Ecclesiastical Music], Koultoura [En Parisiois (Paris), 1821].
103. CHRYSANTHOS (DE MADYTOS): *Great theory of music*, translator Kaitē Rōmanou, The Axion Estin Foundation |2010|.
104. CHRYSANTHOS (DE MADYTOS) and Panagiōtēs G. PELOPIDĒS: *Θεωρητικόν Μέγα της Μουσικής* [Theōrētikon mega tēs mousikēs – Great theoretical book of music], En Tergeste: ek tes typographias Michael Vais (Michele Weis) |Trieste - Italie, 1832|.
105. CHRYSANTHOS (DE MADYTOS) and Kaitē RŌMANOU: *Great theory of music by Chrysanthos of Madytos*, Thesis, Indiana University |1973|.
106. COLLECTIF: *كتاب مؤتمر الموسيقى العربية Kītāb mu'tamar al-mūsiqā al-'arabiyya* [Livres du Congrès de Musique arabe], Al-Matḥa'a al-Amīriyya (وزارة المعارف العمومية) |Le Caire 1933 القاهرة|.
107. COLLECTIF, ouvrage: *Recueil des Travaux du Congrès de Musique Arabe qui s'est tenu au Caire en 1932 (Hég. 1350) sous le Haut Patronage de S. M. FOUAD 1er, ROI D'ÉGYPTÉ*, Imprimerie Nationale d'Égypte |Le Caire - Egypte, 1934|.
108. COMMISSION MUSICALE DE (MUSICAL COMMITTEE OF) 1881, APHTONIDĒS and AL.: *Στοιχειώδης διδασκαλία της εκκλησιαστικής μουσικής εκπονηθείσα επί τη βάση του ψαλτηρίου υπό της μουσική επιτροπής του Οικουμενικού Πατριαρχείου εν έτει 1883* [Elementary teachings of ecclesiastical music elaborated on the basis of the psalter by the musical committee of the Ecumenical Patriarchate in the year 1883], ed. 2 (?), Coultoura |Athènes, 1978-1888|.
109. CONOMOS, Dimitri E.: “Petros Peloponnesios”, *Grove Music Online* |2007-2012| [url: <http://www.oxfordmusiconline.com/>].
110. COOK, Nicholas: *Music: a very short introduction*, Oxford University Press |Oxford, 2000|.
111. COOK, Nicholas and Daniel LEECH-WILKINSON: “A musicologist's guide to Sonic Visualiser” [url: http://www.charm.rhul.ac.uk/analysing/p9_1.html].
112. COUPRIE, Pierre, Dominique FOBER, Jean BRESSON and Yann GELSIN: “Les nouveaux espaces de la notation musicale”, *Journées d'informatique musicale* [url: https://www.academia.edu/20847919/Les_nouveaux_espaces_de_la_notation_musicale].
113. CRAWFORD, Richard: *The American Musicological Society, 1934-1984: An Anniversary Essay*, The AMS |1984|.
114. DAY, C. R. (Charles Russell): *The music and musical instruments of southern India and the Deccan*, London & New York Novello, Ewer & co. [etc.] |1891| [url: <http://archive.org/details/musicmusicalinst00dayc>].
115. DENNY, F. M.: “Tadjwid”, *Encyclopaedia of Islam, Second Edition* |2012-4-24| [url: http://referenceworks.brillonline.com/entries/encyclopaedia-of-islam-2/tadjwid-COM_1145?s.num=0&s.rows=20&s.mode=DEFAULT&s.f.s2_parent=encyclopaedia-of-islam-2&s.start=0&s.q=tadjwid].
116. DESCHĒNES, Bruno: “A preliminary approach to the analysis of honkyoku, the solo repertoire of the Japanese shakuhachi”, *Near Eastern Musicology Online* 4 6 |2017-11| [url: <http://nemo-online.org/Articles>] p. 123–143.
117. DHĀKĪR (BEY), Muḥammad: *الروضة البهية في أوزان الألحان الموسيقية* [A-r-Rawda al-Bahiyya fi Awzān al-Alḥān al-Mūsiqiyya], *Dār al-Kutub al-Miṣriyya* |Le Caire القاهرة, 1890a|.
118. DHĀKĪR (BEY), Muḥammad: *حياة الإنسان في تزييد الألحان* Ḥayāt al-Insān fi Tardīd al-Alḥān, *Al-Kutubkhāna al-Khidiyawiyya fi Miṣr* [La librairie khédiévale en Égypte] |Le Caire القاهرة, 1890b|.
119. DHĀKĪR (BEY), Muḥammad: *تحفة الموعود بتعليم العود* Tihfat al-Maw'ūd fi Ta'lim al-'ūd, 1st ed., Maṭḥa'at al-Liwā' |Shāri' a-d-Dawāwīn Miṣr (rue Dawāwīn – Égypte!), 1903|.
120. DUMBRILL, Richard: “The Truth about Babylonian music”, *Near Eastern Musicology Online* 4 6 |2017-11| [url: <http://nemo-online.org/Articles>] p. 91–121.
121. DURING, Jean: *La musique iraniennne: tradition et évolution*, Recherche sur les Civilisations |Paris, France, 1984|.
122. ELLIS, Alexander John: “On the musical scales of various nations”, *Journal of the Society of Arts* 33 |1885| p. [485]-527.
123. ELLIS, Alexander John and A. J. HIPKINS: “Tonometrical Observations on Some Existing Non-Harmonic Musical Scales”, *Proceedings of the Royal Society of London* 37 232–234 |1884| p. 368–385.
124. EPHESIOS, Petros: *Neon Anastasimatarion* |1820|.
125. ERGUR, Ali and Nilgün DOĞRUSÖZ: “Resistance and Adoption towards Written Music at the Crossroads of Modernity: Gradual Passage to Notation in Turkish Makam Music”, *International Review of the Aesthetics and Sociology of Music* 46 1 |2015| [url: <http://www.jstor.org/stable/24327332>] p. 145–174.
126. ERLANGER, Rodolphe (d'): *La musique arabe, 6 tomes – I. [Al-Fārābī] (1930) ; II. [Al-Fārābī et Ibn Sīnā] (1935) ; III. [Commentaires sur Le Livre des Cycles de Safīyy-a-d-Dīn al-Urmawī] (1938) ; IV. [Anon. – a-sh-Shīrwānī – et al-Lādhīqī] (1939) ; V. [Échelles et modes] (1949) ; VI. [Rhythmes et formes] (1959) 6 (vols.)*, Librairie orientaliste Paul Geuthner |Paris, 1930-1959|.
127. ERLANGER, Rodolphe (d'): *La musique arabe (5) – Essai de codification des règles usuelles de la musique arabe moderne. Échelle générale*

- des sons, système modal 5/6 (vols.), Librairie Orientaliste Paul Geuthner |Paris, France, 1949].
128. ERLANGER, Rodolphe (d'), Lasaad KRIAA and الأمدد قريعة: *Translation in Arabic of La musique arabe* (5) – Essai de codification des règles usuelles de la musique arabe moderne. Échelle générale des sons, système modal 5/6 (vols.), Sotimedia |Paris, France, 2018-1949].
129. FELDMAN, Walter: *Music of the Ottoman Court: makam, composition and the early Ottoman instrumental repertoire, Intercultural Music studies*, VVB-Verlag für Wissenschaft und Bildung |Berlin, 1996].
130. FILLMORE, John Comfort: “THE HARMONIC STRUCTURE OF INDIAN MUSIC”, *American Anthropologist* 1 2 |1899-4| [doi: 10.1525/aa.1899.1.2.02a00060. url: <http://doi.wiley.com/10.1525/aa.1899.1.2.02a00060>] p. 297–318.
131. FRASER, C. Gerald: “Charles Seeger, Musicologist, 92”, *The New York Times*, sec. Archives |1979-2-8| [url: <https://www.nytimes.com/1979/02/08/archives/charles-seeger-musicologist-92-father-of-folk-singer-was-first-to.html>].
132. GEOFFROY, E.: “Shaykh”, *Encyclopaedia of Islam, Second Edition* |2012-4-24| [url: http://referenceworks.brillonline.com/entries/encyclopaedia-of-islam-2/shaykh-SIM_6890?s.num=0&s.f.s2_parent=s.f.book.encyclopaedia-of-islam-2&s.q=shaykh].
133. GERSON-KIWI, Edith: “Towards an Exact Transcription of Tone-Relations”, *Acta Musicologica* 25 1/3 |1953-1-1| [doi: 10.2307/931677. url: <http://www.jstor.org/stable/931677>] p. 80–87.
134. GHULMIYYA, Walid, Tawfiq KIRBĀJ and Anṭūn FARAH: *Nazarīyyat al-Mūsīqā A-sh-Sharqī ‘Arabīyya* 5/, CNSMB – Conservatoire National Supérieur de Musique de Beyrouth |Beyrouth, 1996].
135. GIOVANNELLI, Alessandro: “Goodman’s Aesthetics”, *The Stanford Encyclopedia of Philosophy*, ed. Edward N. Zalta, ed. Fall 2017, Metaphysics Research Lab, Stanford University |2017| [url: <https://plato.stanford.edu/archives/fall2017/entries/goodman-aesthetics/>].
136. GOODMAN, Nelson: *Languages of Art*, Bobbs-Merrill |1968].
137. HAIDAMOUS, Makarios: Kyrie Ekekraxa in Arabic, Windows PCM (.wav), Comp. Petros (Byzantios), CDA-007 |Deir al-Mukhallis (Couvent Saint-Sauveur - Joum) - Liban, 2010a-2011].
138. HAIDAMOUS, Makarios: Kyrie Ekekraxa in Greek, Windows PCM (.wav), Comp. Petros (Byzantios) and Mitri Murr (al-), CDA-006 |Deir al-Mukhallis (Couvent Saint-Sauveur - Joum) - Liban, 2010b-2011].
139. HASSAN, Schéhérazade Qassim: “Un récent colloque sur le Congrès du Caire de 1932”, *Cahiers de musiques traditionnelles* 3 |1990| [doi: 10.2307/40240086. url: <http://www.jstor.org/stable/10.2307/40240086?origin=crossref>] p. 268.
140. HAYNES, Bruce and Peter COOKE: “Pitch”, *Grove Music Online* |2001| [url: <http://www.oxfordmusiconline.com/subscriber/article/grove/music/40883?q=pitch&search=quick&pos=1&start=1#firsthit>].
141. HĪJĀZĪ (AL-MAKKĪ AL-), a-sh-Shaykh Shihāb-a-d-Dīn Muḥammad ibn Ismā‘īl ibn ‘Umar (الشيخ شهاب الدين محمد بن اسماعيل بن عمر المكي) *Safīnat al-Mulk wa-Nafīsat al-Fulk* (F) 2274.8769.379 PUL| [Égypte, 1864].
142. HĪLŪ (AL-), Salīm الموسيقى النظرية: سليم الحلو *Al-Mūsīqā a-n-Nazarīyya [La musique théorique]*, 2nd ed., منشورات دار مكتبة الحياة al-Ḥayāt |بيروت - لبنان| Beyrouth - Liban, 1972].
143. HĪLŪ (AL-), Salīm الموسىحات الأتلسية، نشأتها و تطورها Al-Muwashshahāt al-Andalūsiyya: Nash’atuhā wa-Taṭawwuruḥā [Les muwashshahāt andalous : leur origine et leur développement], 2nd ed., منشورات دار مكتبة الحياة، بيروت - لبنان |Dār Maktabat al-Ḥayāt |بيروت - لبنان| Beyrouth, 1980].
144. HINDEMITH, Paul: *The craft of musical composition*, Associated music publishers, inc. |1945].
145. HIPKINS, A. J. : “Dorian and Phrygian”, *Sammelbände der Internationalen Musikgesellschaft* 4 3 |1903-5-1| [url: <http://www.jstor.org/stable/929209>] p. 371–381.
146. HIRST, Daniel: “The analysis by synthesis of speech melody: from data to models”, *Journal of Speech Sciences* 1 1 |2012-1-25| [url: <http://www.journalofspeechsciences.org/index.php/journalofspeechsciences/article/viewArticle/21>] p. 55–83.
147. HOLDER, William and Gottfried KELLER: *A treatise of the natural grounds, and principles of harmony*, Printed by W. Pearson, ... for J. Wilcox ... and T. Osborne |London, 1731].
148. HOOD, M.: “Musical significance”, *Ethnomusicology* 7 3 |1963| p. 187–192.
149. HOOD, M.: “Reminiscent of Charles Seeger”, *Yearbook of the International Folk Music Council* 11 |1979| p. 76–82.
150. HOOD, Mantle: *The ethnomusicologist*, Kent, Ohio: Kent State University Press |1982| [url: <http://archive.org/details/ethnomusicologis00hood>].
151. HORNBOSTEL, E. M. v.: “Musikalische Tonsysteme”, *Akustik, Handbuch der Physik*, Springer, Berlin, Heidelberg |1927| [doi: 10.1007/978-3-642-47352-4_9. url: https://link.springer.com/chapter/10.1007/978-3-642-47352-4_9] p. 425–449.
152. HORNBOSTEL, Erich M. von: “On Comparative Acoustic and Music Psychological Studies”, *Translingual Discourse in Ethnomusicology* 2 0 |2017-8-23| [url: <https://www.tde-journal.org/index.php/tde/article/view/1870>] p. 1–18.
153. HORNBOSTEL, Erich Moritz (von): “Phonographierte tunesische Melodien”, *Sammelbände der Internationalen Musikgesellschaft* 8 1 |1906-1-1| [url: <http://www.jstor.org/stable/929108>] p. 1–43.
154. HOUTSMA, A. J. M. and J. SMURZYNSKI: “Pitch identification and discrimination for complex tones with many harmonics”, *The Journal of the Acoustical Society of America* 87 1 |1990-1| [doi: 10.1121/1.399297. url: <http://asa.scitation.org/doi/10.1121/1.399297>] p. 304–310.
155. IFRAH, Georges: *Histoire universelle des chiffres: l’intelligence des hommes racontée par les nombres et le calcul*, R. Laffont |Paris, 1994].
156. IVEY, Bill: “Ethnomusicology and the Twenty-First Century Music Scene (Seeger Lecture presented at the Society for Ethnomusicology Annual Meeting, 2007)”, *Ethnomusicology* 53 1 |2009| [url: <http://www.jstor.org/stable/25653045>] p. 18–31.
157. JABAQŪĪ, ‘Abd-a-r-Raḥmān تحليل الأرقام في علم المقام Taḥlīl al-Anghām fī ‘Ilm al-Maqām, دار التراث الموسيقي، Dār a-t-Turāth al-Mūsīqī |سوريا حلب - Syrie, sd.].
158. JÄGER, Ralf Martin: “Concepts of Western and Ottoman Music History”, *Writing the history of “Ottoman Music”*, ed. Martin Greve, ed. 1. Aufl, *Istanbul Texte und Studien* 33, Ergon-Verl |Würzburg, 2015| p. 33–50.
159. JARGY, Simon and Alexis CHOTTIN: “La Musique Arabe”, editor Roland-Manuel, *Histoire de la musique Tome I - Des Origines à Jean-Sébastien Bach, Encyclopédie de la Pléiade* 1/2 (vols.), Gallimard |Paris, 2001| p. 526–571.
160. JUYNBOLL, Th W.: “Adhān”, *Encyclopaedia of Islam, Second Edition* |2012-4-24| [url: http://referenceworks.brillonline.com/entries/encyclopaedia-of-islam-2/adhan-SIM_0302?s.num=0&s.f.s2_parent=s.f.book.encyclopaedia-of-islam-2&s.q=adhan].
161. KARADENİZ, M. Ekrem: *Türk musikîsinin nazariye ve esasları [Theory and Principles of Turkish Music]*, Kültür |Ankara, 1965].
162. KARADENİZ, M. Ekrem: *Türk musikîsinin nazariye ve esasları*, Türkiye İş Bankası Kültür Yayınları |1983].

163. KAUFMANN, Walter: *Musical notations of the Orient; notational systems of Continental, East, South and Central Asia*, Bloomington, Indiana University Press [1967] [url: <http://archive.org/details/musicalnotations00kauf/>].
164. KHULĀTĪ (AL-), Muḥammad Kāmil محمد كامل الخلي: *Kitāb al-Mūsīqī a-sh-Sharqīy [The book of oriental music / Le livre de la musique orientale]* [1904].
165. KHULĀTĪ (AL-), Muḥammad Kāmil محمد كامل الخلي: *Kitāb al-Mūsīqī a-sh-Sharqīy [The book of oriental music / Le livre de la musique orientale]*, ed. X, *Maktabat a-d-Dār al-‘Arabīyya li-l-Kitāb* مكتبة دار العربية للكتاب [Beirut, 1993].
166. KIESEWETTER, Raphael Georg: *Die Musik der Araber nach Originalquellen dargestellt, mit einem Vorworte von Jos. von Hammer-Purgstall: Mit VI. Abbildungen im Text und XXIV. Seiten Noten-Beilagen, welche die Tonformeln der alten Autoren, dann einige jetzt gangbare Volksweisen und Gesänge enthalten*, Breitkopf und Härtel [1842].
167. KINDĪ (AL-), Ya‘qūb ibn Ishāq Abū Yūsuf (0801?-0867?) and الكندي: *Risāla fi-l-Luḥūn wa-n-Naḡham (Mukhtaṣar al-Mūsīqā fi Ta‘līf a-n-Naḡham wa Shir‘at al-‘ūd) [from Marisa (Turquie), MS. 1705, f^{80v} 110^v-123^r] رسالة الكندي في الحون و النغم* Maṭba‘at Shafīq |Baghdād, 1965].
168. KORZYBSKI, Alfred: “A non-Aristotelian system and its necessity for rigour in mathematics and physics” (Paper presented before the American Mathematical Society, December, 28 1933) [1931].
169. KRISHNASWAMY, A.: “Melodic atoms for transcribing camatic music”, *Proceedings of the International Conference on Music Information Retrieval, Barcelona, Spain* [2004].
170. KRISHNASWAMY, Arvindh: “Pitch measurements versus perception of south indian classical music”, *Proc. of the Stockholm Music Acoustics Conference (SMAC)* [2003] p. 627–630.
171. KRISHNASWAMY, Arvindh: “Multi-dimensional musical atoms in South-Indian classical music”, *Proc. of the International Conference of Music Perception & Cognition* [2004].
172. KUNST, Jaap: “Memorial to Curt Sachs (June 29, 1881 - Feb. 5, 1959)”, *Ethnomusicology* 3 2 [1959-5-1] [url: <http://www.jstor.org/stable/924288>] p. 71–74.
173. LEE, Riley Kelly: “Fu Ho U vs. Do Re Mi: The Technology of Notation Systems and Implications of Change in the Shakuhachi Tradition of Japan”, *Asian Music* 19 2 [1988-4-1] [doi: 10.2307/833867. url: <http://www.jstor.org/stable/833867>] p. 71–81.
174. LEPENDORF, Jeffrey: “Contemporary Notation for the Shakuhachi: A Primer for Composers”, *Perspectives of New Music* 27 2 [1989-7-1] [doi: 10.2307/833414. url: <http://www.jstor.org/stable/833414>] p. 232–251.
175. LEVY, Kenneth and Christian TROELSGÅRD: “Byzantine Chant”, editors Stanley Sadie and John Tyrrell, *The New Grove Dictionary of Music and Musicians - Vol. 4 - Barovski to Canobbio 4/29* (vols.), Oxford University Press |Oxford, 2001| p. 734–755.
176. LIST, George: “The Musical Significance of Transcription (Comments on Hood, ‘Musical Significance’)”, *Ethnomusicology* 7 3 [1963] [doi: 10.2307/924577. url: <http://www.jstor.org/stable/924577>] p. 193–197.
177. LIST, George: “Transcription III”, *Ethnomusicology* 8 3 [1964] [doi: 10.2307/850127. url: <http://www.jstor.org/stable/850127>] p. 252–265.
178. LIST, George: “The Reliability of Transcription”, *Ethnomusicology* 18 3 [1974] [doi: 10.2307/850519. url: <http://www.jstor.org/stable/850519>] p. 353–377.
179. LUNN, Henry C.: “The History of Musical Notation”, *The Musical Times and Singing Class Circular* 12 278 [1866-4-1] [doi: 10.2307/3354152. url: <http://www.jstor.org/stable/3354152>] p. 261–263.
180. MAHDĪ (AL-), Muḥammad Ṣāliḥ مفاہات الموسیقی العربیة الدكتور صالح المهدي: *Maqāmāt al-Mūsīqā al-‘Arabīyya, Ma‘ al-Fann wa-l-Fannānīn* 3, المعهد الرشیدی للموسیقی التونسية Al-Ma‘had a-r-Rashīdī li-l-Mūsīqā a-t-Tūni-siyya |تونس - نونس| Tunis, 1982].
181. MALEK, Nicolas: *Kyrie Ekekraxa in Arabic*, Windows PCM (.wav), Comp. Petros (Byzantios) and Mitrī Murr (al-), CDA-005 [Mansourieh - Liban, 2011a-5-25].
182. MALEK, Nicolas: *Kyrie Ekekraxa in Greek*, Windows PCM (.wav), Comp. Petros (Byzantios) and Mitrī Murr (al-), CDA-004 [Mansourieh - Liban, 2011b-5-25].
183. MARICHELLE, H.: *La Parole d’après le tracé du phonographe*, Paris, Delagrave [1897] [url: <http://archive.org/details/laparoledaprs100mari/>].
184. MASHĀQA, Mikhā‘īl: “Ms. A-r-Risālā a-sh-Shihābiyya fi-ṣ-Ṣinā‘a al-Mūsīqīyya – الصناعة الموسيقية (في الرسالة الشهابية في) BO 220 34 f^{80v} [Beyrouth, 1887-xix^e siècle] [Bibliothèque Orientale – Beyrouth. url: <http://cdm.csbsju.edu/u/?HMMLCollect,7092>].
185. MASHĀQA, Mikhā‘īl: “A-r-Risālā a-sh-Shihābiyya fi-ṣ-Ṣinā‘a al-Mūsīqīyya”, editor Louis Ronzevalle, *Al-Mashriq (Beyrouth)* 2 [1899] p. 146, 218, 296, 408, 561, 629, 726, 883, 928, 1018, 1073.
186. MASHĀQA, Mikhā‘īl: *Un traité de musique arabe moderne – Version française (avec reproduction de l’original arabe) de A-r-Risālā a-sh-Shihābiyyah fi-ṣ-Ṣinā‘a al-Mūsīqīyya [The Shihabi treatise of the musical art]*, editor Louis Ronzevalle, translator Louis Ronzevalle, Imprimerie Catholique |Beyrouth, 1913].
187. MASHĀQA, Mikhā‘īl and Eli SMITH: “A Treatise on Arab Music, Chiefly from a Work by Michail Meschakah of Damascus”, *Journal of the Oriental American Society* 1 3 [1849-1847 selon JSTOR] p. 171 + 173-217.
188. MATYAKUBOV, Otanazar and Harold S. POWERS: “19th Century Khorezmian Tanbur Notation: Fixing Music in an Oral Tradition”, *Yearbook for Traditional Music* 22 [1990-1-1] [doi: 10.2307/767929. url: <http://www.jstor.org/stable/767929>] p. 29–35.
189. MEER, Wim van der: “Praat manual (for musicologists)”, *Wim van der Meer’s music pages* [2015-1-30] [url: <https://wimvandermeer.wordpress.com/praat-manual-for-musicologists/>].
190. MEER, Wim van der: “PRAAT Manual for musicologists” [2018a-1-19] [url: https://www.academia.edu/10404719/PRAAT_Manual_for_musicologists].
191. MEER, Wim van der: “What you hear isn’t what you see...”, *Thoughts for Ideas* [2018b-2-22] [url: <http://thoughts4ideas.eu/what-you-hear-isnt-what-you-see/>].
192. MEER, Wim van der: “PRAAT TUTORIAL FOR MUSICOLOGISTS” [url: http://www.musicology.nl/wm/research/praat_musicologists.htm].
193. MEER, Wim van der and ERICKSON, R.: “Resonating Cultural Musicology: sources, streams and issues”, *Cultural Musicology: premises, practices, prospects*, Musicology at Amsterdam University, Bake Society [2014] [url: [http://dare.uva.nl/personal/pure/en/publications/resonating-cultural-musicology-sources-streams-and-issues\(5845cfae-095d-40fe-8ce0-2618f64b0fd2\).html](http://dare.uva.nl/personal/pure/en/publications/resonating-cultural-musicology-sources-streams-and-issues(5845cfae-095d-40fe-8ce0-2618f64b0fd2).html)].
194. MEER, Wim van der and Suvarnalata RAO: “What You Hear Isn’t What You See: The representation and cognition of fast movements in Hindustani music”, *Proceedings of the International Symposium Frontiers of Research on Speech and Music* [2006]

- [url: http://www.academia.edu/340912/What_You_Hear_Isnt_What_You_See_The_representation_and_cognition_of_fast_movements_in_Hindustani_music] p. 12–20.
195. MIRAMON-BONHOURE, Jeanne and Amine BEYHOM: “Praat: Petit manuel pratique pour débutants – 1^{ère} partie: Analyses de systèmes intervalliques et d'échelles V 1.0.3”, Université Paris Sorbonne |2010-9|.
196. MIYAKAWA, Felicia M.: “Turntablature: Notation, Legitimization, and the Art of the Hip-hop DJ”, *American Music* 25 1 |2007-4-1| [doi: 10.2307/40071644. url: <http://www.jstor.org/stable/40071644>] p. 81–105.
197. MOLINO, Jean: “EXPÉRIENCE ET SAVOIR”, *Musurgia* 2 4 |1995| p. 112–118.
198. MOLINO, Jean: “La Sociologie de la Musique de Max Weber Après un Siècle”, *Revue de Synthèse* 129 2 |2008-6| [doi: 10.1007/s11873-008-0039-2. url: <http://link.springer.com/10.1007/s11873-008-0039-2>] p. 215–239.
199. MOUSSALI, Bernard: *Congrès de musique arabe du Caire: The Cairo congress of Arab music* |2015|.
200. NETIL, Bruno: *The study of ethnomusicology: twenty-nine issues and concepts*, Univ. of Illinois Press |Urbana, Ill., 1983|.
201. NEUBAUER, Eckhard: “al-Ṣaydāwī: Encyclopaedia of Islam, Second Edition: Brill Online”, [*Print Version: Volume IX, page 101, column 1J*] |1997| [url: http://www.brillonline.nl/subscriber/uid=2022/entry?result_number=1&entry=islam_SIM-6680&search_text=Saydawi&refine_editions=islam_islam#hit].
202. ODEIMI, Bechir: “*Makḥūṭ ‘Arabīyy fi Tadwīn al-Mūsīqā*”, *Al-Hayāt al-Mūsīqīyya* 5 |1994-1| [url: [Damas]] p. 27–61.
203. OLLEY, Jacob: “Modal diversity in early Ottoman music: the case of *makām Sabā*”, *Near Eastern Musicology Online* 1 1 |2012-11| [url: <http://nemo-online.org/articles>] p. 39–54.
204. OSTA, Bachir: *Kyrie Ekekraxa in Arabic*, Windows PCM (.wav), Comp. Petros (Byzantios), CDB-054 |Patriarcat des Grecs-Catholiques - Liban, 2013a-3-15|.
205. OSTA, Bachir: *Kyrie Ekekraxa in Greek*, Windows PCM (.wav), Comp. Petros (Byzantios), CDB-053 |Patriarcat des Grecs-Catholiques - Liban, 2013b-3-15|.
206. PARISOT, Jean (1862-): *Musique orientale: Conférence prononcée dans la salle de la Société Saint-Jean, le 28 février 1898*, Schola Cantorum |Paris, 1898|.
207. PASLER, Jann: “Musical Hybridity in Flux: Representing Race, Colonial Policy, and Modernity in French North Africa, 1860s-1930s”, *Afrika Zamani: revue annuelle d'histoire africaine = annual journal of African history* 20–21 |2012| p. 21–68.
208. PICARD, François: “Oralité et notations, de Chine en Europe”, *Cahiers de musiques traditionnelles* 12 |1999-1-1| [doi: 10.2307/40240342. url: <http://www.jstor.org/stable/40240342>] p. 35–53.
209. PICARD, François: “Un protocole de visualisation du son” |2011-Summer| [url: http://seem.paris-sorbonne.fr/IMG/pdf/un_protocole_de_visualisation_du_son.pdf] p. 2.
210. PIGGOTT, Francis Taylor and T. L. (Thomas Lea) SOUTHGATE: *The music and musical instruments of Japan*, London: B.T. Batsford |1893| [url: <http://archive.org/details/musicmusicalinst00pigg2>].
211. PLOMP, Reinier: *Aspects of tone sensation: A psychophysical study*, Academic Press |1976|.
212. PLOMP, Reinier: *The intelligent ear: on the nature of sound perception*, Lawrence Erlbaum Associates |Mahwah, N.J., 2002|.
213. POLAND, William: “Theories of Music and Musical Behavior”, *Journal of Music Theory* 7 2 |1963-12-1| [doi: 10.2307/843107. url: <http://www.jstor.org/stable/843107>] p. 150–173.
214. RAO, Suvamalata and Wim van der MEER: “Visual representation of Indian music” p. 11.
215. REID, James: “Transcription in a New Mode”, *Ethnomusicology* 21 3 |1977| [doi: 10.2307/850727. url: <http://www.jstor.org/stable/850727>] p. 415–433.
216. ROUSSEAU, Jean-Jacques: *Collection complète des œuvres de J.J. Rousseau XVI/XXXIII* (vols.), [Paul Moutou et duPeyrou] |Genève, 1782| [url: <http://archive.org/details/collectioncompl70rousgoog>].
217. ROUSSEAU, Jean-Jacques and John T SCOTT: *Essay on the Origin of Languages and Writings Related to Music (The Collected Writings of Rousseau)*, Dartmouth College |1998|.
218. RUWET, Nicolas: “Méthodes d'analyse en musicologie”, *Revue belge de Musicologie/Belgisch Tijdschrift voor Muziekwetenschap* |1966| p. 65–90.
219. RUWET, Nicolas and Mark EVERIST: “Methods of Analysis in Musicology”, *Music Analysis* 6 1/2 |1987-3| [doi: 10.2307/854214. url: <http://www.jstor.org/stable/854214?origin=crossref>] p. 3.
220. SABAT, Marc and Wolfgang von SCHWEINITZ: “The Extended Helmholtz Ellis-J-I Pitch Notation.pdf” |2004| [url: <http://www.marcsabat.com/pdfs/legend.pdf>].
221. SACHS, Curt: *The wellsprings of music*, Martinus Nijhoff |The Hague, 1962|.
222. SACHS, Ignacy: *The discovery of the Third world*, translator Michael Fineberg, MIT Press |Cambridge, Mass, 1976|.
223. {ŞAFADĪ (A-Ş)}, Khalīl ibn Ayybak Ṣalāḥ-a-d-Dīn: خليل بن أيك الصفي: خليل بن أيك الصفي رسالة في علم الموسيقى *Risāla fi ‘Ilm al-Mūsīqā*, editors ‘Abdul-Majīd Dyāb, Ghattās ‘Abd-al-Malik Khashaba, الأستاذ غطلس عبد الملك خشبة، الدكتور المتكور عبد المجيد دياب، *Turāthuna*, الهيئة المصرية العامة للكتاب، *Al-Hay’a al-Misriyya al-‘amma li-l-Kitāb* |Le Caire, 1991-1297?-1363) xiv^e siècle|.
224. ŠĀLIḤ, Faṭḥī: “*Naḥwa Maḥmūm Šāmil Muwaḥḥad li-l-Maqāmāt a-sh-Sharqīyya – Taṣawwur Mustaḡbaliyy li-Taṭawwur al-Mūsīqā a-sh-Sharqīyya*”, *Al-Ḥadātha (Dār al-Ḥadātha li-ṭ-Ṭiba’a wa-n-Nashr - Beirut)* 3-4 |1994-Fall| p. 83–92.
225. ŠAYDĀWĪ (A-Ş), Šams al-Dīn al-Ṣaydāwī al-Maṣṣūfī: شمس الدين الصيداوي المصفي: Shams-a-d-Dīn (a-d-Di-mashqī): “BNF Ms. or-2480 *Kitāb al-In’ām fi Ma’rifat al-Anghām wa Sharḥihā* = *Kitāb fi Ma’rifat al-Anghām wa Sharḥihā* (كتاب في معرفة الأنغام وشرحها) [XV^e siècle].
226. ŠAYDĀWĪ (A-Ş), Šams al-Dīn al-Ṣaydāwī al-Maṣṣūfī: شمس الدين الصيداوي المصفي: Shams-a-d-Dīn (a-d-Di-mashqī) and Thérèse B. ANTAR: *Livre de la connaissance des tons et leur explication* = *Kitāb al-In’ām fi Ma’rifat al-Anghām wa Sharḥihā* (كتاب في معرفة الأنغام وشرحها), Th. 3^e cycle Hist. mus. et musicol. Paris 4 (Sorbonne), Université de Paris Sorbonne |1979|.
227. ŠAYDĀWĪ (A-Ş), Šams al-Dīn al-Ṣaydāwī al-Maṣṣūfī: شمس الدين الصيداوي المصفي: Shams-a-d-Dīn (a-d-Di-mashqī) and Thérèse (soeur Berthe) ANTAR: *Kitāb al-In’ām fi Ma’rifat al-Anghām wa Sharḥihā* = *Kitāb fi Ma’rifat al-Anghām wa Sharḥihā* (كتاب في معرفة الأنغام وشرحها) [*traduction et commentaire par Thérèse B. Antar du manuscrit BNF Ms. or-2480*] (*Exploitation de la couleur en musique: Livre de la connaissance des tons et leur explication*), Chemaly and Chemaly |Beyrouth, 2001-XV^e siècle|.
228. ŠAYDĀWĪ (A-Ş), Šams al-Dīn al-Ṣaydāwī al-Maṣṣūfī: شمس الدين الصيداوي المصفي: Shams-a-d-Dīn (a-d-Di-mashqī) and Anas GHIRAB: *Livre de la générosité dans la connaissance des modes* = *Kitāb al-In’ām fi Ma’rifat al-Anghām wa Sharḥihā* (كتاب في معرفة الأنغام وشرحها), Master II (French DEA), Université LU-MIÈRE-LYON2 |2002|.

229. SCHULTER, Margo: "Systematist Buzurg and its Relatives: Notes on a Zalzalian Modal Genre", *Near Eastern Musicology Online* 2 2 [2013-11] [url: <http://nemo-online.org/articles>] p. 25-49.
230. SEEGER, Charles: "Prescriptive and Descriptive Music-Writing", *The Musical Quarterly* 44 2 [1958-4-1] [url: <http://www.jstor.org/stable/740450>] p. 184-195.
231. SHILOAH, Amnon and Annie BERTHIER: "A propos d'un 'petit livre arabe de musique'", *Revue de Musicologie* 71 1/2 [1985-1-1] [doi: 10.2307/928598. url: <http://www.jstor.org/stable/928598>] p. 164-177.
232. SHIRLAW, Matthew: *The theory of harmony; an inquiry into the natural principles of harmony, with an examination of the chief systems of harmony from Rameau to the present day*, DeKalb, Ill., B. Coar [1955] [url: <http://archive.org/details/theoryofharmony1955shir>].
233. SIGNELL, Karl L.: *Makam: modal practice in Turkish art music, D (Monographs) 4*, Asian Music Publications [1977].
234. SIGNELL, Karl L.: *Makam: modal practice in Turkish art music*, Da Capo Press [1986-1].
235. SIGNELL, Karl L.: "Contemporary Turkish Makam Practice", *Gardland Encyclopedia of World Music Volume 6: The Middle East*, Routledge [United Kingdom, 2001-8-1] [url: <http://gnd.alexanderstreet.com/View/329978#page47>] p. 47-58.
236. SIGNELL, Karl L.: *Makam: modal practice in Turkish art music*, Usul [Nokomis (FL), 2004].
237. SIGNELL, Karl L.: *Makam: modal practice in Turkish art music*, Usul Editions [Sarasota, FL, 2008].
238. SKOULIOS, Markos: "Modern theory and notation of Byzantine chanting tradition: a Near-Eastern musicological perspective", *Near Eastern Musicology Online* 1 1 [2012-11] [url: <http://nemo-online.org/articles>] p. 19-38.
239. SOKAL, Alan: "What is science and why should we care", *Vortrag gehalten am 27* [2008] [url: <http://ai2-s2-pdfs.s3.amazonaws.com/6b8c/57e888f5e61e892d3093de6c1dd29ab2dae0.pdf>] p. 2008.
240. SOMFAI, László: *Béla Bartók: Composition, Concepts, and Autograph Sources*, University of California Press [1996-5-7].
241. STAINER, John: "On the Principles of Musical Notation", *Proceedings of the Musical Association* 1 [1874-1-1] [url: <http://www.jstor.org/stable/765409>] p. 88-111.
242. STOCK, Jonathan: "The Application of Schenkerian Analysis to Ethnomusicology: Problems and Possibilities", *Music Analysis* 12 2 [1993-7-1] [doi: 10.2307/854273. url: <http://www.jstor.org/stable/854273>] p. 215-240.
243. TURA, Yalçın: *Türk mûsikîsinin mes'eleleri*, Pan Yayincılık [İstanbul, 1988].
244. URMAWĪ (D. 1294), Şafiyî-a-d-Din 'Abd-al-Mu'min ibn Yūsuf ibn (ab-ī-l-Ma)Fākhir (al-) صفى الدين الراموي "Kitāb al-Adwār – ljs235", [D. 1293, XIII^e siècle] [2001] [url: <http://sceti.library.upenn.edu/ljscollection/index.cfm>, <http://dewey.library.upenn.edu/sceti/ljs/PageLevel/index.cfm?ManID=ljs235>].
245. URMAWĪ (D. 1294), Şafiyî-a-d-Din 'Abd-al-Mu'min ibn Yūsuf ibn (ab-ī-l-Ma)Fākhir (al-) صفى الدين الراموي and 'Alī ibn Muḥammad [JURJĀNĪ (AL-)] : *La musique arabe (3) – I. A-sh-Sharafīyya ou Épître à Sharaf a-d-Din. II. (Commentaire anonyme du) Kitāb al-Adwār ou Livre des Cycles musicaux*, translator Rodolphe (d') Erlanger, ed. orig., *La Musique Arabe* 3/6 (vols.), Librairie Orientaliste Paul Geuthner [Paris, 1938].
246. VIGREUX, Philippe and Scheherazade Qassim HASSAN: *Musique arabe: le congrès du Caire de 1932*, CEDEJ [Le Caire – Égypte, 1992].
247. VILLOTEAU, Guillaume André: *De l'état actuel de l'art musical en Égypte, ou relation historique et descriptive des recherches et observations faites sur la musique en ce pays*, 2nd ed., *Description de l'Égypte, ou Recueil des observations et des recherches qui ont été faites en Égypte pendant l'expédition de l'armée française État Moderne 14/*, Impr. de Charles Louis Fleury Panckoucke [France, 1826].
248. WALKER, George: "Ethnomusicologist George List", *Profiles - Indiana Public Media* [2007-7-29] [url: <http://indianapublicmedia.org/profiles/george-list/>].
249. WIKIPEDIA CONTRIBUTORS: "Rauf Yekta Bey", *Wikipedia, the free encyclopedia* [2014-9-8] [url: http://en.wikipedia.org/w/index.php?title=Rauf_Yekta_Bey&oldid=594546466].
250. WIKIPEDIA CONTRIBUTORS: "Labanotation", *Wikipedia* [2017a-3-16] [url: <https://en.wikipedia.org/w/index.php?title=Labanotation&oldid=770629628>].
251. WIKIPEDIA CONTRIBUTORS: "Znamenny chant", *Wikipedia* [2017b-10-12] [url: https://en.wikipedia.org/w/index.php?title=Znamenny_chant&oldid=805053732].
252. WIKIPEDIA CONTRIBUTORS: "Jianpu", *Wikipédia* [2017c-10-22] [url: <https://fr.wikipedia.org/w/index.php?title=Jianpu&oldid=141783665>].
253. WIKIPEDIA CONTRIBUTORS: "Jaap Kunst", *Wikipedia* [2017d-11-23] [url: https://en.wikipedia.org/w/index.php?title=Jaap_Kunst&oldid=811678960].
254. WIKIPEDIA CONTRIBUTORS: "Numbered musical notation", *Wikipedia* [2017e-12-18] [url: https://en.wikipedia.org/w/index.php?title=Numbered_musical_notation&oldid=815949389].
255. WIKIPEDIA CONTRIBUTORS: "Khwarezm", *Wikipedia* [2018a-1-3] [url: <https://en.wikipedia.org/w/index.php?title=Khwarezm&oldid=818396111>].
256. WIKIPEDIA CONTRIBUTORS: "Musical notation", *Wikipedia* [2018b-1-4] [url: https://en.wikipedia.org/w/index.php?title=Musical_notation&oldid=818640041].
257. WIKIPEDIA CONTRIBUTORS: "Qāri", *Wikipedia* [2018c-5-23] [url: <https://en.wikipedia.org/w/index.php?title=Q%4%81ri%CA%BE&oldid=842657681>].
258. WIKIPEDIA CONTRIBUTORS: "Tajwid", *Wikipedia* [2018d-6-22] [url: <https://en.wikipedia.org/w/index.php?title=Tajwid&oldid=846999415>].
259. WIKIPEDIA CONTRIBUTORS: "Adhan", *Wikipedia* [2018e-6-27] [url: <https://en.wikipedia.org/w/index.php?title=Adhan&oldid=847743430>].
260. WIKIPEDIA CONTRIBUTORS: "Byzantine music", *Wikipedia* [2018f-7-11] [url: https://en.wikipedia.org/w/index.php?title=Byzantine_music&oldid=849795769].
261. WILL, Udo: "The magic wand of ethnomusicology.", *Cahiers de musiques traditionnelles* 12 [1999a] p. 9-34.
262. WILL, Udo: "La baguette magique de l'ethnomusicologue: Repenser la notation et l'analyse de la musique", *Cahiers de musiques traditionnelles* 12 [1999b-1-1] [doi: 10.2307/40240341. url: <http://www.jstor.org/stable/40240341>] p. 9-33.
263. YARMAN, Ozan: "Search for a Theoretical Model Conforming to Turkish Maqam Music Practice: A Selection of Fixed-Pitch Settings. From 34-Equal Temperament to the 79-tone Tuning", *Problems and Solutions for Practice and Theory in Turkish Music*, Kültür A. Ş. [İstanbul, 2008a].
264. YARMAN, Ozan: *79-Tone Tuning & Theory for Turkish Maqam Music - as a solution to the non-conformance between current model and practice*, Istanbul Technical University - Institute of Social Sciences [İstanbul - Turquie, 2008b-6].

265. YAZBECK, Joseph : "Form in Byzantine Music", SEM (School of Ecclesiastic Music) [Mtaileb - Lebanon, 2012a-8-1] [url: <http://www.semlebanon.org/sem/home.do>].
266. YAZBECK, Joseph : Kyrie Ekekraxa in Arabic, Windows PCM (.wav), Comp. Petros (Byzantios) and Mitri Murr (al-), CDA-011 [Mansourieh - Liban, 2012b-9-5].
267. YAZBECK, Joseph : Kyrie Ekekraxa in Greek, Windows PCM (.wav), Comp. Petros (Byzantios) and Mitri Murr (al-), CDA-010 [Mansourieh - Liban, 2012c-9-5].
268. YÄZLÜ, Yühamnâ *Mabâdî' al-Mûsîqâ al-Bizantîyya*, 2nd ed., منشورات معهد القديس يوحنا الممشقي اللاهوتي - جامعة البلمند Manshûrât Ma'had al-Qiddis Yühanna a-d-Dimashqî al-Lâhûti – Jâmi'at al-Balamand لبنان Liban, 2001].
269. YEKTA, Rauf : "La musique turque", editor Albert Lavignac, *Encyclopédie de la musique et dictionnaire du conservatoire – Première partie : Histoire de la musique 1.5/2.6* (vols.), Delagrave [Paris, 1922] [url: <http://gallica.bnf.fr/ark:/12148/bpt6k1237270>] p. 2945–3064.
270. YEKTA, Rauf : *Türk musikisi nazariyatı: ilmin en son usullerine göre Türk musikisinin müstenid olduğu nazari kaideleri tesbit ve bu kaideler* rin millî musikimizin ameliyatına ne suretle tatbik edeceğını izah eder nazari ve ameli bir eserdir, Mahmud Bey Matbaası [1924].
271. YEKTA, Rauf : *Türk musikisi*, Pan Yayınclık [1986].
272. ZOUARI, Mohamed Zied : *Évolution du langage musical de l'istikhbâr en Tunisie au XXe siècle : une approche analytique musico-empirique*, Sorbonne - Paris 4 [Paris, 2014] [url: <http://www.theses.fr/2014PA040028>].
273. 'AMIRI (AL-), Thâmir 'Abd-al-Ḥasan *المغنون الرقيقون وأطوار الأيونية العراقية: Al-Mughannûn a-r-Rifîyyûn wa Aṭwâr al-Abûdhîyya al-'Irâqîyya*, دار الشؤون الثقافية العامة Dâr a-sh-Shu'ûn a-th-Thaqâfiyya al-'Āma [Baghdad?, 1987].
274. 'AMR, Shîrzād : *Al-Buzuq. Tārîkh wa Manhaj wa Fann*, Dâr 'Alâ'u-d-Dîn [Damascus, 2000].
275. غطلس عبد الملك خشبة. ed. الأرموي، صفي الدين عبد المؤمن: *كتاب الأدوار في الموسيقى*، الهيئة المصرية العامة للكتاب، مركز تحقيق التراث | القاهرة 1986.
276. نظريات الموسيقى العربية : 'ABBÂS (AL-) and Ḥabîb Zāhir *Nazarîyyât al-Mûsîqâ al-'Arabîyya*, وزارة الثقافة والإعلام، دائرة الفنون الموسيقية، معهد الدراسات النغمية العراقي (Wizārat a-th-Thaqāfa wa-l-Flām, Dā'irat al-Funûn al-Mûsiqîyya, Ma'had a-d-Dirāsât a-n-Naghmiyya al-'Irâqîyy) | (Baghdad – Irak) 1986. [بغداد - العراق].