



HAL
open science

An aggregated graph to qualify historical spatial networks using temporal patterns detection

Benoit Costes, Julien Perret, Bénédicte Bucher, Maurizio Gribaudi

► To cite this version:

Benoit Costes, Julien Perret, Bénédicte Bucher, Maurizio Gribaudi. An aggregated graph to qualify historical spatial networks using temporal patterns detection. The 18th AGILE International Conference on Geographic Information Science, 2015, Lisbon, Portugal. hal-02535779

HAL Id: hal-02535779

<https://hal.science/hal-02535779>

Submitted on 7 Apr 2020

HAL is a multi-disciplinary open access archive for the deposit and dissemination of scientific research documents, whether they are published or not. The documents may come from teaching and research institutions in France or abroad, or from public or private research centers.

L'archive ouverte pluridisciplinaire **HAL**, est destinée au dépôt et à la diffusion de documents scientifiques de niveau recherche, publiés ou non, émanant des établissements d'enseignement et de recherche français ou étrangers, des laboratoires publics ou privés.

See discussions, stats, and author profiles for this publication at: <https://www.researchgate.net/publication/282332658>

An aggregated graph to qualify historical spatial networks using temporal patterns detection

Conference Paper · June 2015

CITATIONS

7

READS

139

4 authors:



Benoit Costes

Institut national de l'information géographique et forestière

7 PUBLICATIONS 19 CITATIONS

SEE PROFILE



Julien Perret

Institut national de l'information géographique et forestière

68 PUBLICATIONS 411 CITATIONS

SEE PROFILE



Bénédicte Bucher

Institut national de l'information géographique et forestière

73 PUBLICATIONS 603 CITATIONS

SEE PROFILE



Gribaudo Maurizio

Ecole des Hautes Etudes en Sciences Sociales, France, Paris

30 PUBLICATIONS 245 CITATIONS

SEE PROFILE

Some of the authors of this publication are also working on these related projects:



iSpace&Time [View project](#)



Lung Transplantation [View project](#)

An aggregated graph to qualify historical spatial networks using temporal patterns detection

Benoit Costes
Université Paris-Est
IGN/SRIG, COGIT
73, avenue de Paris
94160 St-Mandé, France
benoit.costes@ign.fr

Julien Perret
Université Paris-Est
IGN/SRIG, COGIT
julien.perret@ign.fr

Bénédicte Bucher
Université Paris-Est
IGN/SRIG, COGIT
benedicte.bucher@ign.fr

Maurizio Gribaudi
LaDéHis, EHES
190-198, av de France
75244 Paris, France
gribaudi@ehess.fr

Abstract

This paper introduces a model of an aggregated graph suitable to study dynamics of city street networks, and a method to build it. Using temporal pattern detection, it allows detecting inconsistencies in historical spatial networks attributable mainly to old maps themselves, without ground truth data but by comparing each data with each other, and helps to take into account their imperfections such as differences in levels of detail, incompleteness, fuzzy temporalisation, geometric inaccuracies and so on, in the objective of performing further spatio-temporal analyses with corrected data. Our model is applied on Paris old street network at five different temporalities.

1 Introduction

The increasing availability of historical data, particularly through the development of collaborative projects is a first step towards the design of a representation of space and its changes over time in order to study its evolution, whether social, administrative or topographical. However, maps and especially old maps, are models of the world and not images [4]. It is a representation altered by several factors such as the accuracy of survey methods, the associated specifications, and the temporal uncertainty of those surveys, usually long and poorly known. We focus in this paper on historical spatial networks which model the state of a network, such as streets, the way it is represented on given sources.

Historical spatial networks are highly inaccurate, uncertain or inexact according to the existing terminology [3, 13, 10] because of sources but also digitization itself, and raise meaningful analysis issues, in particular the study of street evolutions and the characterization of their transformations. However, such analyses are commonly performed without qualifying data or considering their specificities, which may lead to controversial conclusions.

Thus, we propose a structure of merged data capable of modelling spatial networks at different times. We also provide tools such as pattern detection in order to criticize and qualify data and sources without using ground truth data but the comparison of data with each other through the merging process. The proposed model is thereby suitable to easily study temporal, topological and morphological evolution of data whose inconsistencies are considered and possibly corrected.

Numerous models have been proposed in order to integrate time and dynamics in GIS [21, 28], some based either on an implicit representation of spatio-temporal phenomena [1, 34] on changes [18], or on events and processes [8, 19]. More recently, several propositions have been published inspired by graph theory. Graph theory is a mathematic framework for modeling all type of networks, in particular spatial networks such as street networks, and one can find a substantial state of

the art devoted to the analysis of their structure and their morphological characteristics [3, 24, 16]. For instance, a graph model has been defined to formalize spatio-temporal relationships between objects at different times and granularities [9]. More recently, a structure and a method suitable to build spatio-temporal data have been proposed [11] and applied on Paris street network.

Many works have also been achieved to capture the evolving characteristics of networks with highly dynamic behavior such as communication networks. At a very short scale of time, authors propose models and algorithms of called *evolving graphs* [35], *temporal graphs* [20], *time-varying graphs* [6, 33], *temporal networks* [17], basically commonly called *dynamic graphs*. A topological aggregated graph has also been defined in the context of the study of traffic evolution of a city transportation network in the purpose of optimizing the computational cost of shortest path algorithms in time-varying graphs [14]. The dynamic of the graph is supported by the edge labels, with sequences of values corresponding to weights of edges at different times. Nevertheless, it models the topological state of the very same network at various instants on a very short scale of time without any geometrical consideration (solely the weight of the connection between the nodes of the network may vary), so the merge is roughly equivalent to the temporal aggregation of the weights of the edges. We extend the basics of this approach to merge the geometrical representations of a spatial network on different sources, having specific characteristics such as geometric inaccuracies, temporal uncertainty, various levels of detail, incompleteness, or heterogenic specifications, and propose a novel model of Spatio-Temporal-Aggregated-Graph (or *STAG*) adapted to the study of network dynamics, which behaves as a dynamic graph and is easily queryable (extraction of edges creation, detection of temporal or morphological patterns, etc.). Let us note that in our model, the merge is both topological and geometrical.

The layout of this paper is as follows. In section 3, we introduce the *STAG* model. Section 4 proposes a generic approach to build this graph, together with tools to perform

queries to qualify data consistency. The model is tested on Paris street network.

2 Model of a spatio-temporal aggregated graph

A graph $G = (V, E)$ consists of a set of *vertices* (or *nodes*) V and a set of *edges* $E \subset V \times V$ connecting pairs of vertices.

A graph $G' = (V', E')$ is a *subgraph* of G if $V' \subset V$ and $E' \subset E$. For the following, we consider that a subgraph may be reduced to a single node or a single edge.

2.1 Temporal snapshots

A temporal snapshot is commonly defined as the state of a spatial network at a given period of time ([2] for instance). For the following, we assimilate the temporal domain of a snapshot with the date of the survey of the associated map. As this date is commonly vague, we model it with fuzzy set theory as previously proposed in [31] to represent temporal inaccuracy of archeological data.

Thus, a temporal interval t_i is a fuzzy set $t_i = (a_i, b_i, c_i, d_i)$ of \mathbb{N}^{+*} . Figure 1 shows the example of the fuzzy temporal interval (1784, 1785, 1789, 1791) which is interpreted as a survey which started between 1784 and 1785, and ended between 1789 and 1791. Let $\mathbb{T} = \bigcup_{i \leq N} t_i$ be the temporal domain of the evolving graph to be defined. We provide \mathbb{T} with a partial order whose choice is not discussed in this paper (see [32] for instance). The fuzzy sets are then sorted.

Figure 1: Representation of the fuzzy interval $t = (1784, 1785, 1789, 1791)$.

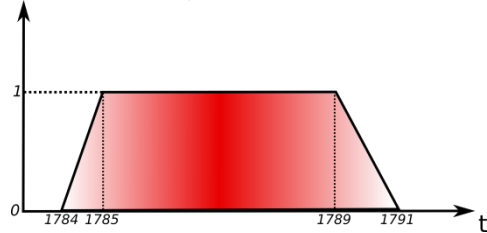

Let's assume $(G_i = (V_i, E_i))_{i \leq N}$ is a sequence of N graphs where V_i is a set of *spatial nodes* and $E_i \subset V_i \times V_i$ a set of *spatial edges*, such as G_i is defined over the temporal interval t_i . $(G_i)_{i \leq N}$ is ordered with the previously chosen temporal order, and G_i is called the i^{th} *temporal snapshot*. See figure 2 for examples.

Figure 2: Three arbitrary temporal snapshots.

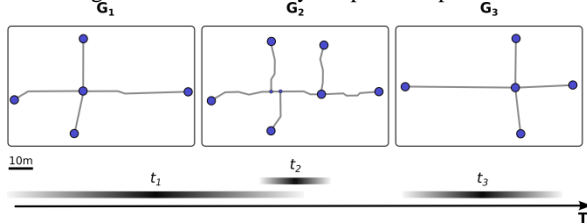

We define \mathbb{S}_i as the set of subgraphs of G_i , and $G = \bigcup_{i \leq N} \mathbb{S}_i$ as the union of all subgraphs of all temporal snapshots.

Finally, let μ be the temporal labeling function which links every element of G with its temporal interval:

$$\mu : \begin{array}{l} G \rightarrow \mathbb{T} \\ g \rightarrow t_i / g \in \mathbb{S}_i \end{array}$$

2.2 Merging snapshots in an unified graph

2.2.1 Matching networks

We define a model to structure and analyze spatio-temporal data. Thus, our proposal is positioned downstream a preliminary matching step that identifies homologous entities through the different temporal snapshots. The choice of the matching algorithm does not affect the definition of our generic model, and may be adapted to the characteristics of data.

Two elements g and g' of G from two different snapshots (i.e. $\mu(g) \neq \mu(g')$) are said to be in a spatio-temporal relation, and we note $g \rho_{st} g'$ if there is a match between g and g' .

Figure 3 shows in its upper part few examples of manual matching links between the nodes (dotted lines) and the edges (solid lines) of the temporal snapshots. The bottom part illustrates three spatio-temporal relations between elements of the snapshots. The green one is a simple lineage link between a node of G_1 and a node of G_2 . The red one is a split relation between one edge of G_1 and two edges of G_2 . Finally, the orange relation is a merge, between three edges of G_2 and one edge of G_3 .

Figure 3: examples of matching links and spatio-temporal relations between elements of the temporal snapshots.

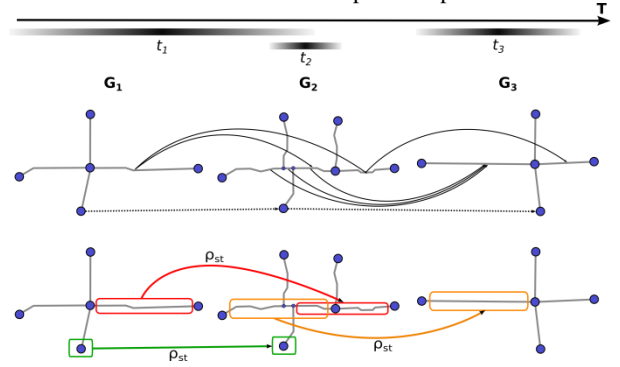

2.2.2 Spatio-temporal nodes

A *spatio-temporal node* (or *ST-node*) is conceptually defined as a group of single nodes or sometimes subgraphs (which means nodes and edges) from the temporal snapshots that are matched one with each other, and thus merged in a single object. Formally, it is a finite subset φ of subgraph of G such as every element of φ is in a spatio-temporal relationship with another element of φ : $\varphi \subset G, \forall g \in \varphi, \exists g' \in \varphi / g \rho_{st} g'$. The temporal domain $\Lambda(\varphi)$ of a spatio-temporal node φ is then the union of the temporal domains of all its

elements: $\Lambda(\varphi) = \bigcup_{g \in \varphi} \mu(g)$. Note that most of the time a ST-node is reduced to a subset of spatial nodes of G , except when multi-scale matching is used, such as a roundabout matched with a single node in the case of networks with different levels of detail.

Figure 4 shows a ST-node built from the spatio-temporal relation between the node g_1 of G_1 and the subgraph g_2 (two nodes and one edge) of G_2 . The empty set at t_3 just illustrates the lack of a homologous element at this date (no node at t_3 matched with element g_2 at t_2).

Figure 4: example of a spatio-temporal node.

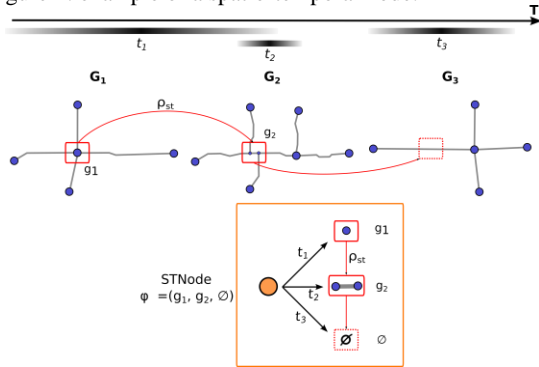

2.2.3 Spatio-temporal edge

A *spatio-temporal edge* (or *ST-edge*) is conceptually defined as a group of matched edges from the temporal snapshots, merged in a single object

Formally, it is defined as a finite subset ψ of spatial edges of G such as every edge of ψ is in a spatio-temporal relationship with another edge of ψ : $\psi \subset G, \forall e \in \psi, \exists e' \in \psi / e \rho_{st} e'$. The temporal domain $\Lambda(\psi)$ of a spatio-temporal edge ψ is then the union of the temporal domains of all its elements: $\Lambda(\psi) = \bigcup_{e \in \psi} \mu(e)$.

In figure 5, the split relation in red between G_1 and G_2 has been broken into simple lineage relations with the introduction of a *fictive node* (in white) on G_1 , which is the projection of the intermediate node of G_2 . Then a ST-edge is built from the three lineage relations in green.

Figure 5: example of a spatio-temporal edge.

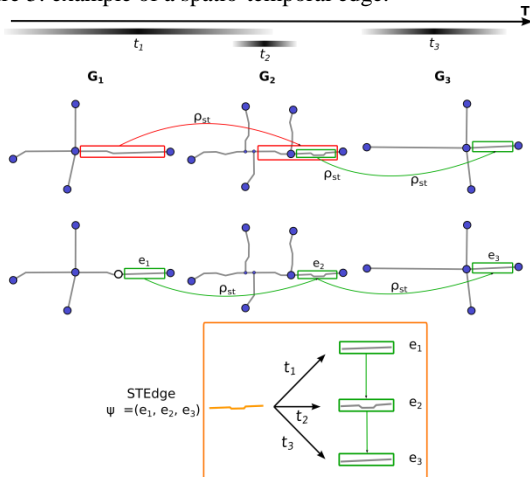

2.2.4 Spatio-temporal aggregated graph

A *spatio-temporal aggregated graph* (or *STAG*) corresponds to the merged temporal snapshots. Homologous nodes are aggregated in ST-nodes, and homologous edges are aggregated in ST-edges.

Formally, A *STAG* $G_{stag} = (\phi, \Psi)$ consists of a set of ST-nodes ϕ and a set of ST-edges Ψ connecting pairs of ST-nodes. See figure 6 for example. Let notice that the evolving graph is constrained by some predicates. If $\psi = (\varphi^1, \varphi^2)$ is a ST-edge connecting ST-node φ^1 and φ^2 then:

1. the temporal domains of φ^1 and φ^2 intersect each other: $\Lambda(\varphi^1) \cap \Lambda(\varphi^2) \neq \emptyset$,
2. there is a spatial-edge between every subgraph g of φ^1 and g' of φ^2 that comes from the same snapshot (*i.e.* $\mu(g) \cap \mu(g') \neq \emptyset$).

Figure 6: Spatio-temporal aggregated graph associated with figure 2. Edges and nodes are labeled with their time-series.

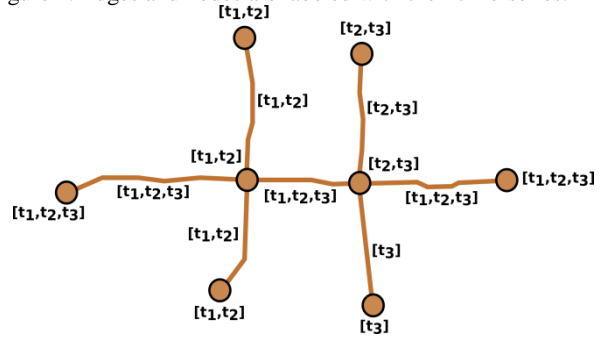

3 Testing STAG modeling on Paris old street networks

3.1 From old maps to streets networks

We test our model on Paris road networks. Five maps from five periods of time have been georeferenced and digitized by IGN (National Institute for Geographic and Forestry Information) and EHESS (School for Advanced Studies in Social Sciences) (figure 7). We use the official date of the survey of each map [5, 16, 30, 29].

Figure 7: Sources used to test the STAG. From top left to bottom right: Verniquet (1784/1785-1789/1791), Vasserot [26] (1808/1810-1836/1853), Jacoubet (1825/1827-1836/1839), Andriveau (1848/1849-1849/1850) and "1871" (1870/1871-1871/1872).





We restrict all networks to a common area corresponding mostly to the wall of the "ferme générale", Paris extent before 1860.

For the following let's note t_i the temporal interval of the i^{th} snapshot, according to the order of figure 7. Then $\mathbb{T} = t_1 \cup t_2 \cup t_3 \cup t_4 \cup t_5$.

3.2 From street networks to STAG

Although many matching algorithm exist [11, 23, 27], and as we do not focus in this paper of the matching process itself, we use an algorithm which has the particularity to be perfectly adapted to match road networks with different levels of detail [25] and is already implemented in our coding framework [15].

We used a semi-automatic approach with a manual correction of matching links. Naturally, a number of mistakes remain, that might be automatically detected afterwards (see section 4).

The global process for building the STAG is an iterative approach (figure 8) which at a step number i aggregates the i^{th} snapshot with the STAG calculated in the previous step $i-1$. The geometric merge roughly consists in averaging homologous edges previously weighted with a confidence degree that can be interpreted either as the importance of one source over the others, or by the global estimated accuracy for each map. The core of the algorithm at a given step is first to merge matched nodes (or a node and a subgraph in the case of $1:n$ links), then to decompose each $1:n$ or $n:m$ links regarding only edges into elementary $1:1$ links by projecting possible intermediate node of edges on their closest matched edge, and finally to aggregate those $1:1$ matching links.

Figure 8: Global iterative approach for building the STAG.

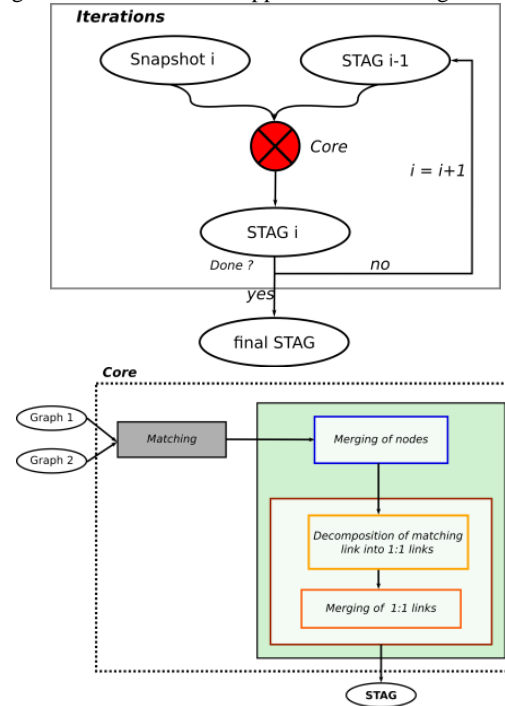

Figure 9 shows the resulting geometric STAG calculated for the 5 snapshots described above. It contains approximately 7850 edges and 4750 nodes, whereas the sum of vertices and edges of all snapshots is respectively 22000 and 14000.

Figure 9: the STAG calculated with the 5 previous snapshots.



3.3 Looking for temporal patterns

Each element of the STAG can be linked to its *temporal-signature* which is a binary sequence $(\delta_i)_{i \leq N}$, ordered according to the temporal order defined on \mathbb{T} , where $\delta_i = 1$ if the element exists over the temporal interval t_i , and 0 otherwise. For instance, a spatio-temporal node defined over the period $t_2 \cup t_3$, has a temporal signature $(0, 1, 1, 0, 0)$.

We call *pattern* any binary tuple of size N . Looking for temporal pattern is looking for elements which temporal signature matches a given pattern. For computational

purposes, it can be practical to depict the temporal signature of each element with a string, and look for patterns using regular expressions. Table 1 describes five particular patterns, and gives for each the regular expression used to detect it, an example and the waveform graphic associated [7].

Table1: the different temporal patterns.

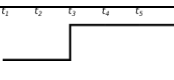
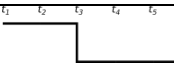
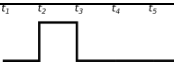
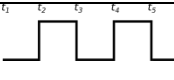
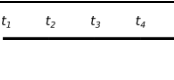
Temporal pattern	Regular expression	Example	Waveform graphic
Birth	$^0+1+\$$	“00111”	
Death	$^1+0+\$$	“11000”	
Appearance	$^0+1+0+\$$	“01000”	
Reincarnation	$10+1$	“01010”	
Stability	$^11+1\$$	“11111”	

Let us notice that those patterns establish a partition of the set of all possible patterns. Below in table 2 are the percentages of each pattern detected on our test data.

Table 2: percentages of each detected temporal pattern on Paris data.

Birth patterns	30%
Death patterns	11%
Appearance patterns	9%
Reincarnation patterns	3%
Stability pattern	47%

The proportion of stability pattern being under 50% confirms that many transformations occurred in Paris between 1789 and 1871. Appearance patterns are not insignificant (9%) whereas in real street networks, these cases are very uncommon (given the studied period, it would be surprising if a street was destroyed almost immediately after being built). Thus these patterns tend to highlight inconsistencies into digitized networks.

3.4 Detecting data inconsistencies

One can wonder why they are so many detected reincarnations and appearances. After manual review of these cases, we propose the following taxonomy of inconsistencies.

3.4.1 Inconsistencies attributable to the merging process

Because in practice, no matching process can achieve 100% of precision and recall, invalid matching links may cause wrongly identified transformations inside the STAG building process.

3.4.2 Inconsistencies attributable to the sources

Every map is specific, by its purpose (military, touristic, urban planning and so on), its sponsor (public or private funding), its scale and level of detail, its specifications and survey techniques. After a manual review we identified four causes of inconsistencies attributable to sources:

1. differences in levels of detail, heterogeneity or incompleteness of maps,
2. future street projects depiction,
3. time uncertainties about surveys,
4. mistakes inside the maps.

Figure 10 shows the detected appearance pattern “00010”. Historically, the *Cité Riverin* has been opened in 1829 [22]. The street appears neither on Jacobuet map nor on Vasserot digitized data, either because of a low granularity, or because of the fuzzy temporality of those maps. The street is drawn on Andriveau map but not on 1871 map, what suggests that 1871 map is either incomplete, or its level of detail is lower than Andriveau map.

Figure 10: a detected appearance pattern “00010” attributable to different levels of detail. 1854 map is shown for the transformations dates.

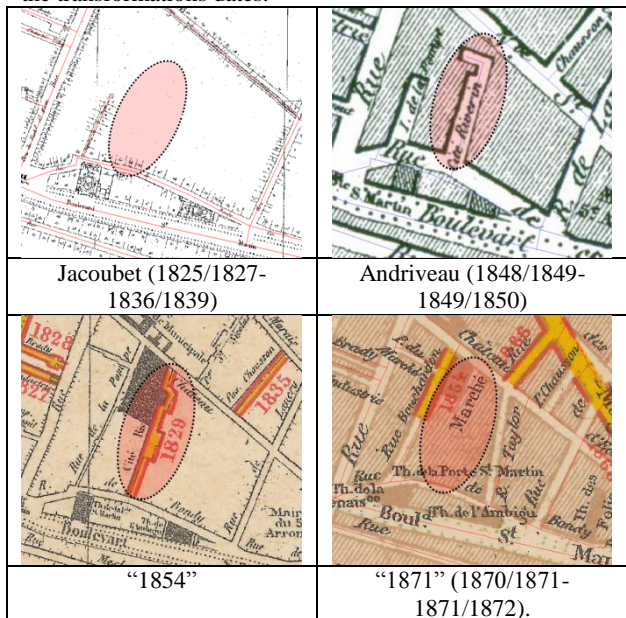
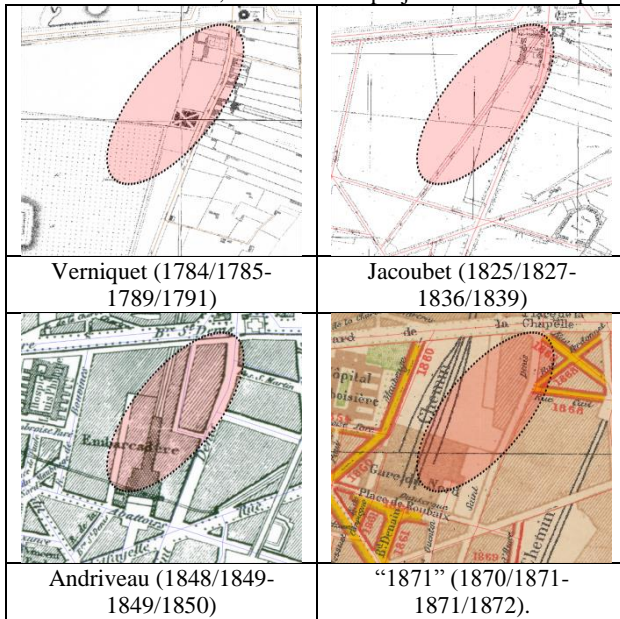

Figure 11 illustrates another appearance pattern detection. The *rue de la Barrière Saint-Denis* is planned on Jacobuet map as shown by the dotted delimitations of the street which also crosses existing buildings. Actually, this street has never been opened because of the construction, in 1846, of the *Gare du Nord* train station. One can notice that the inconsistency may also be attributable to digitization specifications as the street, clearly in project on the map, has been digitized without that information.

Figure 11: a detected appearance pattern "00100": Rue de la Barrière Saint-Denis, attributable to projects drawn on maps.



Finally, figure 12 illustrates an inconsistency detected by a reincarnation pattern "10111": *rue des Écuries d'Artois*. The portion of the street between *rue de Berry* and *rue de la Boetie* is on Verniquet map. Indeed, it was planned to be created in 1778 [22] but the opening only occurred in 1823 because of several circumstances.

Figure 12: a detected reincarnation pattern "10111": Rue des Écuries d'Artois, attributable to mistakes on Verniquet's map.

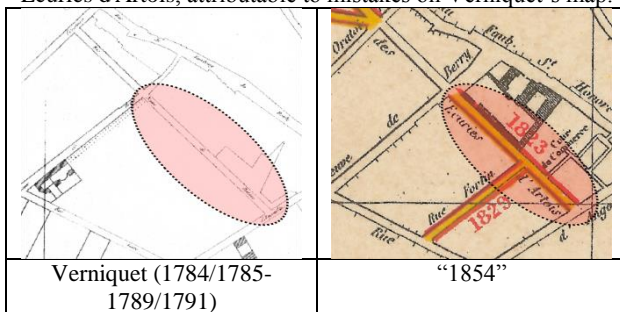

3.4.3 Inconsistencies attributable to digitization

The last type of inconsistencies is due to digitization issues. Incompleteness is a first source of errors, but the major one comes from differences in digitization specifications. Figure 13 shows an example of a reincarnation pattern "11001" which is due to the way places and roundabouts have been digitized: a single centroid point, or streets constituting the place, or even both. The STAG picture on figure 13 illustrates the detected reincarnation in purple. This particular case is easily automatically detectable, and thus a multi-scale object can be build, which level of detail may be adapted for a specific purpose.

Figure 13: a reincarnation pattern attributable to differences in digitization specifications. The map is superimposed with the associated digitized data.

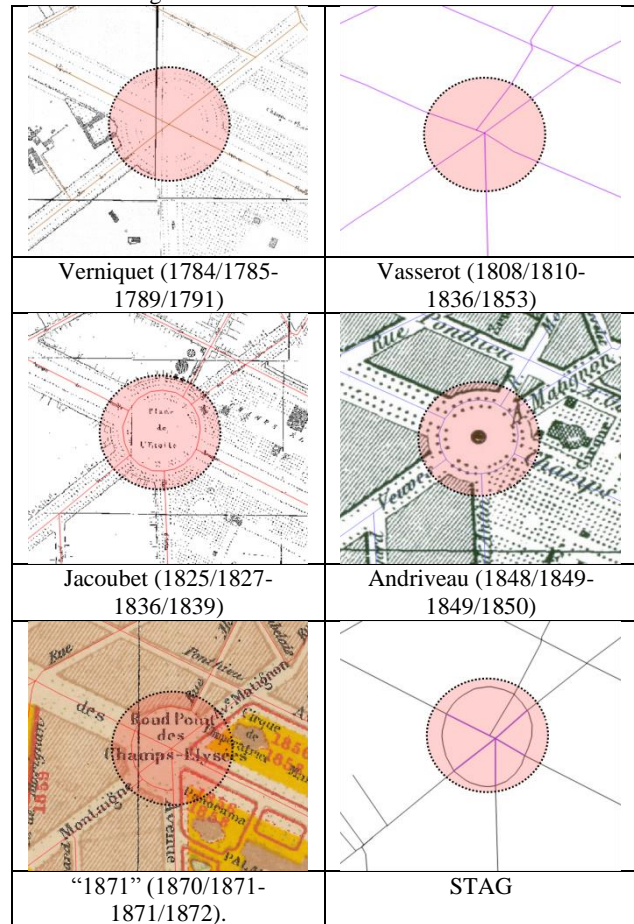

4 Discussion

The first quality of the STAG is to restrict data redundancy through the merging process (the number of edges and nodes is divided by 3). Let us note that some of the inconsistencies detailed above may be automatically corrected. Indeed, the errors attributable to the matching process create pairs of topologically close temporal patterns. For instance, the combination of a birth pattern and a death pattern whose extremities are equal suggests that the process has failed to match them.

It should be noted that most cases of appearance and reincarnation are attributable to the sources or the different digitization specifications. It would be relevant to develop a method to classify each inconsistency and automatically highlight its most likely cause, even though case by case surveys and manual corrections are unavoidable.

As we adopt a generic and methodological approach, we did not discuss in this paper on the definition of what homologous entities are, and thus on how to define the identity of a street. We propose a method to build the STAG that takes as input

generic matching links, whatever the matching algorithm. Nevertheless, we think that a specific process to filter these matching links, capable of distinguishing between real transformations of networks, such as street straightening or new openings, and geometrical inaccuracies as proposed in [12], may be helpful to study the dynamics of city street networks.

5 Conclusion

The spatio-temporal aggregated graph proposed in this paper unifies spatio-temporal networks data in an integrated and merged framework. It allows to automatically detect temporal patterns, such as appearances or reincarnations which may highlight inconsistencies in data and helps to adopt a cautious approach for the analysis of spatio-temporal data. Our test on Paris road network illustrates that those inconsistencies are essentially attributable to sources (fuzzy temporalisation, heterogeneity, incompleteness, objective of representation and geometric accuracy) but also, to a lesser extent, to the digitization process (georeferencing, oversights and differences of specifications) and the matching.

As the model inherently contains all lineage information of graph entities, it is suitable to study the morphological evolution and the dynamics of city street networks which might have been qualified and eventually corrected through the criticism of sources, and thus the survey of the imperfections of their digitized data.

For future works, it seems relevant to study the impact of the consideration of the detected inaccuracies on the calculation of global and local morphological indicators. The STAG also raises research issues such as the merging process of N-polylines, and its connection with geographical data adjustment, or the morphological characterization of the transformations identified by the temporal patterns. Can we find trends or ruptures in the structural development of a street network?

References

- [1] Marc P Armstrong. Temporality in spatial databases. In *Proceedings: GIS/LIS*, volume 88, pages 880–889, 1988.
- [2] M. Barthelemy, P. Bordin, H. Berestycki, et al. Self-organization versus top-down planning in the evolution of a city. *Scientific reports*, 2013, vol. 3.
- [3] D. Beauquier, J. Berstel, and P. Chrétienne. *Éléments d'algorithmique*. 1992.
- [4] Olivier Bonin. Analyse de la croissance de réseaux de transport sur le moyen terme à partir de sources cartographiques. In *Actes de la troisième journée d'étude du groupe FMR*, 2014.
- [5] Alfred Bonnardot. *Études Archéologiques sur les anciens plans de Paris*. 1851.
- [6] Arnaud Casteigts, Paola Flocchini, Walter Quattrociocchi, and Nicola Santoro. Time-varying graphs and dynamic networks. In *Ad-hoc, Mobile, and Wireless Networks*, pages 346–359. Springer, 2011.
- [7] Jeffrey Chan, James Bailey, and Christopher Leckie. Discovering correlated spatio-temporal changes in evolving graphs, 2007.
- [8] Christophe Claramunt and Marius Thériault. Managing time in gis an event-oriented approach. In *Recent Advances in Temporal Databases*, pages 23–42. Springer, 1995.
- [9] Géraldine Del Mondo. *Un modèle de graphe spatio-temporel pour représenter l'évolution d'entités géographiques*. PhD thesis, Université de Bretagne occidentale-Brest, 2011.
- [10] T Devogele, T Badard, Thérèse Libourel Rouge, et al. La problématique de la représentation multiple. *IGAT-Généralisation et Représentation Multiple*, pages 45–70, 2002.
- [11] B. Dumenieu, J. Perret, and A. Ruas. Une méthode de construction de données spatio-temporelles appliquée aux rues anciennes de paris. In *Actes de la Conférence Internationale de Géomatique et d'Analyse Spatiale*, 2013.
- [12] Bertrand Dumenieu. *Construction d'un modèle de données géo-historiques, intégration, gestion des imperfections et simulation*. PhD thesis, EHESS, to be published in 2015.
- [13] Peter F Fisher. Models of uncertainty in spatial data. *Geographical information systems*, 1:191–205, 1999.
- [14] Betsy George and Shashi Shekhar. Time-aggregated graphs for modeling spatio-temporal networks. In *Advances in Conceptual Modeling-Theory and Practice*, pages 85–99. Springer, 2006.
- [15] GeOxygene. homepage-project, 2009.
- [16] J-F. Gleyze. *La vulnérabilité structurelle des réseaux de transport dans un contexte de risques*. PhD thesis, Université Paris VII, 2005.
- [17] Petter Holme and Jari Saramäki. Temporal networks. *Physics reports*, 519(3):97–125, 2012.
- [18] Kathleen Hornsby and Max J Egenhofer. Identity-based change: a foundation for spatio-temporal knowledge representation. *International Journal of Geographical Information Science*, 14(3):207–224, 2000.
- [19] Jixiang Jiang and Michael Worboys. Event-based topology for dynamic planar areal objects. *International Journal of Geographical Information Science*, 23(1):33–60, 2009.
- [20] Vassilis Kostakos. Temporal graphs. *Physica A: Statistical Mechanics and its Applications*, 388(6):1007–1023, 2009.
- [21] Gail Langran and Nicholas R Chrisman. A framework for temporal geographic information. *Cartographica: The International Journal for Geographic Information and Geovisualization*, 25(3):1–14, 1988.
- [22] Félix Lazare and Louis Lazare. *Dictionnaire administratif et historique des rues de Paris et de ses Monuments*. 1844.
- [23] Linna Li and Michael F. Goodchild. An optimisation model for linear feature matching in geographical data conflation. *International Journal of Image and Data Fusion*, 2011, 2(4), pages 309-328.
- [24] P. Mathis. *Graphes et réseaux - modélisation multiniveau*. Philippe Mathis, 2003.
- [25] S. Mustière and T. Devogele. Matching networks with different levels of detail. *GeoInformatica*, 12:435–453, 2008.

- [26] H. Noizet and E. Grosso. The alpage project : Paris and its suburban area at the intersection of history and geography (9th-19th century). In *25th International Cartographic Conference (ICC'11)*, Paris (France), 3-8 juillet 2011.
- [27] Ana-Maria Olteanu. *Fusion de connaissances imparfaites pour l'appariement de données géographiques: proposition d'une approche s' appuyant sur la théorie des fonctions de croyance*. 2008. PhD Thesis. Université Paris-Est.
- [28] Donna J Peuquet. Making space for time: Issues in space-time data representation. *GeoInformatica*, 5(1):11–32, 2001.
- [29] Pierre Pinon, Bertrand Le Boudec, and Dominique Carré. *Les plans de Paris: histoire d'une capitale*. Atelier parisien d'urbanisme, 2004.
- [30] Jeanne Pronteau. *Edme Verniquet, 1727-1804*. Commission des travaux historiques de la ville de Paris, 1986.
- [31] Cyril De Runz. *Imperfection, temps et espace: modélisation, analyse et visualisation dans un SIG archéologique*. 2008. PhD Thesis. Université de Reims-Champagne Ardenne.
- [32] Y.L.P Thorani, P. Phani Bushan Rao, and N. Ravi Shankar. Ordering generalized trapezoidal fuzzy numbers. *International Journal Of AlgebraW*, 6(22):1069–1085, 2012.
- [33] Klaus Wehmuth, Artur Ziviani, and Eric Fleury. A unifying model for representing time-varying graphs. *arXiv preprint arXiv:1402.3488*, 2014.
- [34] Michael Worboys. Computation with imprecise geospatial data. *Computers, Environment and Urban Systems*, 22(2):85–106, 1998.
- [35] B Bui Xuan, Afonso Ferreira, Aubin Jarry, et al. Evolving graphs and least cost journeys in dynamic networks. In *WiOpt'03: Modeling and Optimization in Mobile, Ad Hoc and Wireless Networks*, 2003.