



**HAL**  
open science

# Fractionation of a dilute acetic acid aqueous mixture in a continuous countercurrent packed column using supercritical CO<sub>2</sub>: Experiments and simulation of external extract reflux

Astrid Novella, Séverine Camy, Jean-Stéphane Condoret

## ► To cite this version:

Astrid Novella, Séverine Camy, Jean-Stéphane Condoret. Fractionation of a dilute acetic acid aqueous mixture in a continuous countercurrent packed column using supercritical CO<sub>2</sub>: Experiments and simulation of external extract reflux. *Journal of Supercritical Fluids*, 2020, 157, pp.104680. 10.1016/j.supflu.2019.104680 . hal-02533378

**HAL Id: hal-02533378**

**<https://hal.science/hal-02533378>**

Submitted on 6 Apr 2020

**HAL** is a multi-disciplinary open access archive for the deposit and dissemination of scientific research documents, whether they are published or not. The documents may come from teaching and research institutions in France or abroad, or from public or private research centers.

L'archive ouverte pluridisciplinaire **HAL**, est destinée au dépôt et à la diffusion de documents scientifiques de niveau recherche, publiés ou non, émanant des établissements d'enseignement et de recherche français ou étrangers, des laboratoires publics ou privés.



## Open Archive Toulouse Archive Ouverte

OATAO is an open access repository that collects the work of Toulouse researchers and makes it freely available over the web where possible

This is an author's version published in: <http://oatao.univ-toulouse.fr/25801>

Official URL : <https://doi.org/10.1016/j.supflu.2019.104680>

**To cite this version:**

Novella, Astrid<sup>ORCID</sup> and Camy, Séverine<sup>ORCID</sup> and Condoret, Jean-Stéphane<sup>ORCID</sup>  
*Fractionation of a dilute acetic acid aqueous mixture in a continuous countercurrent packed column using supercritical CO<sub>2</sub>: Experiments and simulation of external extract reflux.* (2020) *The Journal of Supercritical Fluids*, 157. 104680. ISSN 0896-8446

Any correspondence concerning this service should be sent to the repository administrator: [tech-oatao@listes-diff.inp-toulouse.fr](mailto:tech-oatao@listes-diff.inp-toulouse.fr)

# Fractionation of a dilute acetic acid aqueous mixture in a continuous countercurrent packed column using supercritical CO<sub>2</sub>: Experiments and simulation of external extract reflux

A. Novella, S. Camy, J.-S. Condoret\*

Laboratoire de Génie Chimique, Université de Toulouse, CNRS, INPT, UPS, Toulouse, France

## HIGHLIGHTS

- Supercritical separation of acetic acid-water mixtures was experimentally studied.
- Purity and recovery ratio of AA proved to be low due to thermodynamic limitation.
- Simulation of external extract reflux was performed using the Prosim Plus software.
- Use of reflux significantly increased the mass fraction of AA in the extract.

## GRAPHICAL ABSTRACT

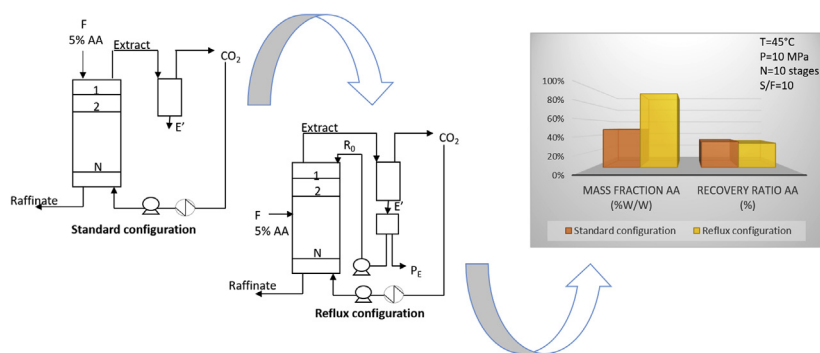

## ABSTRACT

Fractionation of dilute acetic acid aqueous mixtures was operated using a continuous countercurrent packed column with supercritical CO<sub>2</sub>. A generic procedure was developed to assess the feasibility of such an operation. Experiments were performed using a 2 m high and 17 mm inner diameter column, in the range (10–15 MPa) and (40 °C–60 °C). Thermodynamics of the mixture was described using the Soave-Redlich-Kwong equation modified by Boston Mathias with PSRK mixing rules and UNIQUAC activity coefficient model. Experimental results were compared to simulation using a software based on the concept of equilibrium stage. Conventional liquid-liquid extraction methods indicated that thermodynamics limits the separation performances. Therefore, an external extract reflux configuration was tested by simulation. It was shown that the limitation could be overridden and influence of design (number of stages, position of the feed) and operating conditions (reflux ratio, solvent-to-feed ratio) has been assessed.

### Keywords:

Supercritical CO<sub>2</sub>  
Fractionation  
Acetic acid  
Continuous countercurrent column  
Simulation  
Extract reflux

## 1. Introduction

In the framework of the development of biorefineries, downstream processing, which deals with recovery/purification of

biosynthesized products, is now an important issue for the cost effective production of added-value products, biofuels, pharmaceutical molecules or chemical building blocks, as for instance carboxylic acids. Carboxylic acids can be produced from renewable raw materials by fermentation and are used in many applications at large scale. Some of them, like succinic acid, levulinic acid or 3-hydroxypropionic acid belong to the top chemical opportunities from carbohydrates as mentioned in the top 10 list of bio-based

\* Corresponding author.

E-mail address: jeanstephane.condoret@ensiacet.fr (J.-S. Condoret).

chemicals by the U.S. Department of Energy in 2004 [1] and in the revisited version of Bozell and Peterson in 2010 [2]. Recently, in 2017, a report from the Lignocellulosic Biorefinery Network from UK, has identified twenty bio-based chemical opportunities for the UK. Levulinic acid is still in the top ten such as 2,5-Furandicarboxylic acid (FDCA) or glucaric acid and 5-hydroxymethylfurfural has now emerged [3] compared to first reports. Acetic acid (AA) is one of the most important international commodity chemicals [4]. Total market of acetic acid (bio-based and fossil sources) represents 8,373 million USD/year in which bio-based acetic acid only represents 10 % of the total market [5]. Acetic acid from fermentation processes is mainly used for vinegar production [6]. The production cost of carboxylic acids depends on the feedstock cost and for a non-negligible part, on the cost of the downstream processing (30–40% of the production cost) [7]. Acetic acid was traditionally obtained by ethanol fermentation where acetic acid bacteria oxidize ethanol to acetate [8]. As an alternative to this fermentation path, microorganisms can also convert glucose into acetic acid *via* glycolysis, as detailed by Pal et al. [9].

Purification processes for acetic acid from dilute fermentation broths predominantly operate azeotropic distillation, because simple distillation is not practical to separate acetic acid from water, as it requires a high number of stages and a high reflux ratio [10]. Solvent extraction and extractive distillation are also proposed [11]. In the case of azeotropic distillation, azeotropic agents like esters, benzene, chlorinated hydrocarbons or acetate such as ethyl acetate are used [12]. Solvent extraction is generally chosen to separate mixtures with low concentration of solute in water (lower than 40 %w/w) but this process involves the use of an organic solvent and usually requires a distillation operation to regenerate the solvent. For instance, Dobre et al. performed acetic acid liquid-liquid extraction with back extraction for solvent recycling [13], using ethyl acetate and ethyl ether as solvents and a feed at around 4 %w/w of acetic acid. Haque et al. have studied the separation of acetic acid from aqueous solutions using various solvents such as ethyl acetate, n-butanol, iso-butanol and amyl alcohol [14]. They concluded that amyl alcohol was the most selective solvent for this separation. They defined a separation factor (which is the ratio of partition coefficient of AA to the distribution coefficient of water), which is a measure of the ability of solvents to separate acetic acid from aqueous solutions (*i.e.*, a measure of selectivity), and they found that the separation factor of the amyl alcohol was the highest. Sofiya et al. have studied solubility data for the systems water + acetic acid + different solvents (butyl butyrate, benzene, ethyl acetate *etc.*) at room temperature. According to feed concentration, the most suitable solvent can be chosen. This study can thus be used for the choice of the solvent for acetic acid manufacturing process [15].

Nowadays, other separation methods such as hybrid extraction/distillation processes are investigated, but addition of separation agents is still needed (isobutyl acetate, isopropyl acetate, *etc.*) [16]. In the present work, we have considered the use of supercritical CO<sub>2</sub> (ScCO<sub>2</sub>) as the separation agent. Supercritical CO<sub>2</sub> extraction, also commonly referred to as supercritical fractionation, is in direct competition with liquid-liquid extraction, its main advantage being the well-known properties of CO<sub>2</sub> as a solvent on the point of view of non-toxicity and non-flammability. So, usual drawbacks of liquid organic solvents could be alleviated. Such a process is usually operated using countercurrent packed columns in a continuous mode [17]. Supercritical extraction applied to liquids has been reported for separation of aqueous solutions (dealcoholisation of beverages [18,19] and recovery of aromas from fruit juices [20]) or for essential oil deterpenation [21].

Although the use of supercritical fluids for separation of ethanol-water mixtures has been proposed since the 1990s [22,23], studies about separation of carboxylic acids-water mixtures are rather seldom in the literature. Indeed, acetic acid weakly partitions into

the carbon dioxide phase [24] due to the low solubility of acetic acid in this solvent. Indeed, its partition coefficient is much smaller than 1 (around 0.05), expressed in mass % [25]. To compare, the partition coefficient for acetic acid-water-amyl alcohol system is around 2.5 [26]. Moreover, for our system the separation factor (which compares the partition coefficient of acetic acid to the one of water) is not very high (around 20), indicating a moderate selectivity of CO<sub>2</sub> towards AA. Dooley et al. have studied the supercritical CO<sub>2</sub> separation of acetic acid and others amphiphilic compounds from acid-water mixtures in batch mode. They investigated interactions between the different compounds in the aqueous phase and assessed the possibility of fractionation [27]. Garrett et al. have considered the separation of acetic acid contained in cow rumen using dense CO<sub>2</sub> in a semi-continuous mode [28], in the temperature range from 25 °C to 50 °C, pressure range from 10.3–17.2 MPa and 1 h–5 h extraction duration. After 5 h, at 45 °C and 14.5 MPa, using the highest flow-rate of CO<sub>2</sub> (0.12 kg/h), they theoretically predicted an extract containing 92.5 %w/w of AA from an initial concentration in the feed equal to 92.4 g/L (approximately 9 %w/w of AA).

The aim of the present work is to develop a methodology to conclude upon feasibility and interest of supercritical carbon dioxide separation of aqueous carboxylic acids solutions, focusing here on the case of acetic acid, a compound with a low partition coefficient in this system. This approach is developed combining experiments and simulation. To interpret the results, thermodynamic behavior of the ternary system (CO<sub>2</sub>-acetic acid-water) must be known and a suitable thermodynamic model allowing a good representation of the ternary fluid phase equilibrium of the system has to be chosen. This allows the simulation of the process and the comparison with experiments, performed here using a continuous countercurrent packed column. All these steps constitute pre-requisites to assess the interest of this separation process applied here to the recovery of carboxylic acids from aqueous solutions.

## 2. Materials and methods

### 2.1. Materials

Carbon dioxide was supplied by Air Liquide ( $\geq$  purity 99.98 %) and acetic acid by Sigma-Aldrich ( $\geq$  purity 99.5 %). Tap water was used to prepare liquid feeds containing around 5 %w/w of acetic acid, to mimic usual fermentation broths that typically contain 90–95 % of water.

### 2.2. Experimental set-up

The experimental set-up (Fig. 1) was already described in our previous works [29] and comprises a 2 m high, 17 mm inner diameter column. In this study, the column was filled with Dixon packing (Fig. 1) which is composed of metallic mesh gauze empty cylinders, 3 mm length and diameter. For this packing, Croft Manufacturing claims a specific area of 2378 m<sup>2</sup>/m<sup>3</sup> [30] with 0.91 void fraction [31].

Analysis of the composition of the extract (top) and raffinate (bottom) phases was performed by UV-vis spectroscopy technique (at 201 nm). External calibration with different acetic acid concentration solutions was performed. Raffinate and extract samples are diluted before analysis because concentration of samples must be less than 6 g/L for this spectroscopy technique.

At the bottom of the column, a system of two automatic valves in series, alternatively closed and opened by a timer, allows recovering the liquid aqueous raffinate in a pseudo-continuous mode. Compared to our previous work about separation of aqueous isopropanol mixtures [29], some modifications were done for the

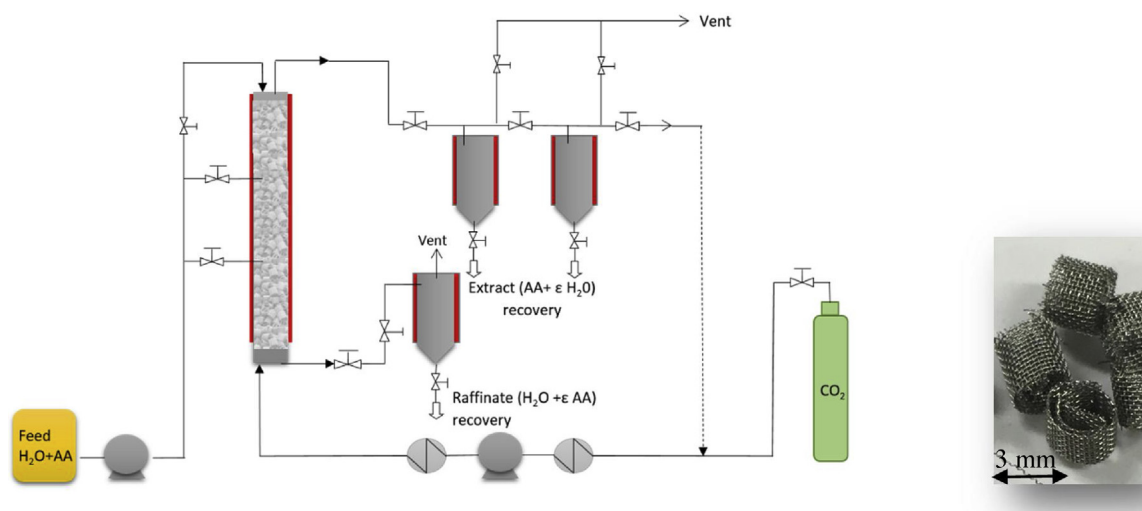

Fig. 1. Experimental set-up (left) and Dixon packing (right).

Table 1

AARE (%) for ternary system, data from [25,33,35,36].

i	j	$A_{ij}$	$A_{ji}$	AARE $x_{CO_2}$ (%)	AARE $x_{H_2O}$ (%)	AARE $x_{AA}$ (%)	AARE $y_{CO_2}$ (%)	AARE $y_{H_2O}$ (%)	AARE $y_{AA}$ (%)
CO <sub>2</sub>	AA	-50.60 - 1.33T	-18.40 + 2.30T						
CO <sub>2</sub>	H <sub>2</sub> O	20.10 + 5.07T	-137.86 + 2.68T	7.65	1.94	2.77	1.03	14.56	39.74
AA	H <sub>2</sub> O	0.76 + 0.30T	0.74 - 0.34T						

starting procedure : the preheated CO<sub>2</sub> at 45 °C is firstly fed alone at the bottom of the column during 30 min until the temperature is constant and close to the targeted value. Then the CO<sub>2</sub> pump is stopped and the pre-heated aqueous feed (acetic acid + water) is introduced at the top of the contactor and maintained at constant flowrate during few minutes until liquid is recovered at the bottom (residence time is around 100 s). Then the CO<sub>2</sub> pump is started again. In our case, such a starting procedure proved to be effective to limit liquid entrainment in the extract phase at the top of the column. All experiments were done without CO<sub>2</sub> recycling in order to easily perform mass balances. Indeed, as mentioned in our previous works, recovery of the extract in the separators is imperfect due to mechanical entrainment of the solute at decompression. This problem has already been described by several authors [29], [32]. Therefore, in this study, acetic acid recovery ratios in the extract and in the raffinate are deduced by mass balance using measured values of the feed flow rate and feed composition, and only measured values of the extract and the raffinate phases composition. In all experiments, liquid flowrate was 0.48 kg/h with a mass fraction of acetic acid of 5.03 %w/w ± 0.04. The first separator (Fig. 1) was operated at 20 °C, 4 MPa and the second one at atmospheric pressure and 20 °C.

Acetic acid extract and raffinate mass fraction proved to remain constant after around 40 min (Fig. 2), indicating that steady state is achieved. Consequently, all measurements were performed after 1 h of experiment. Experiments were done in triplicate and standard deviation was found to be 2.19 % for the composition in the extract and 0.21 % for the composition in the raffinate.

### 3. Thermodynamic modelling of the ternary mixture

Experimental data for carbon dioxide-acetic acid-water high pressure systems are available in the literature [33]. In order to perform the simulation of the process, a thermodynamic model has been chosen to represent the behavior of the ternary system. The Simulis® Thermodynamics software (from ProSim SA, France), implemented in the Excel environment (Microsoft), was used to

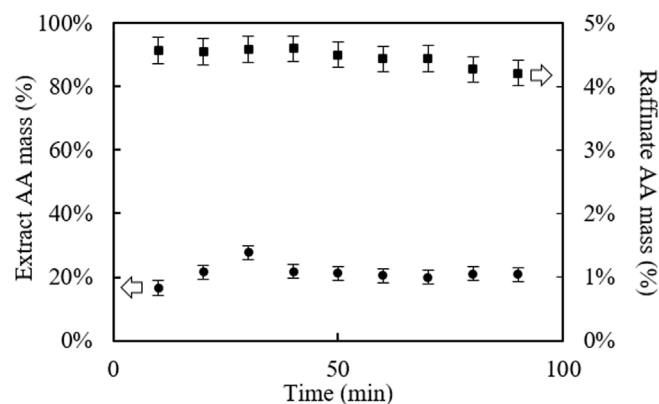

Fig. 2. Time course of experimental extract (●) and raffinate (■) compositions at 10 MPa, 45 °C, solvent-to-feed ratio = 6.3, feed at 5 % (w/w) of AA.

perform the calculations. The polar nature of carboxylic acids and water together with high pressure operation, suggest the use of a so-called  $\varphi$ - $\varphi$  approach with a cubic of equation of state (EoS), combined with activity coefficient model (EoS/ $G^E$ ) through a complex mixing rule. This mixing rule allows the incorporation of an expression for the excess Gibbs energy  $G^E$  inside the EoS. Consequently, EoS can be applied to polar components and high pressure conditions [34]. The equation of state chosen in this study was the Soave-Redlich-Kwong (SRK) equation modified by Boston-Mathias, with the PSRK mixing rule and UNIQUAC model as the excess Gibbs energy model. This model was already selected in our former study concerning the recovery of isopropanol with supercritical carbon dioxide [29]. Best results were obtained with temperature dependent binary interaction coefficients (BIC). In that case, four coefficients have to be fitted for each binary sub-system, meaning twelve coefficients for the whole ternary system. These coefficients were obtained here by fitting experimental data using the Excel software, which minimizes the objective function in Eq. (1). Fitted values of binary interaction parameters are shown in Table 1,

together with the corresponding Absolute Average Relative Error (AARE) calculated from Eq. (2).

$$Fobj = \frac{1}{N_p} \sum_{j=1}^{N_p} \left( \sum_{i=1}^{N_c} \left| \frac{y_i^{exp} - y_i^{calc}}{\frac{y_i^{exp} + y_i^{calc}}{2}} \right| + \sum_{i=1}^{N_c} \left| \frac{x_i^{exp} - x_i^{calc}}{\frac{x_i^{exp} + x_i^{calc}}{2}} \right| \right) \quad (1)$$

where  $x_i$  is the liquid mole fraction and  $y_i$  the vapor mole fraction of compound  $i$ .  $N_p$  is the number of data points and  $N_c$  is the number of components.

$$AARE_{z_i} = \frac{100}{N_p} \sum_{i=1}^{N_p} \left| \frac{z_i^{exp} - z_i^{calc}}{z_i^{exp}} \right| \quad (2)$$

where  $z_i^{exp}$  is the experimental mole fraction (corresponding to  $x_i$  or  $y_i$ ) and  $z_i^{calc}$  is the calculated mole fraction of compound  $i$  and  $N_p$  is the number of data points.

Absolute Average Relative Error upon mass fraction of AA in the vapor phase are relatively high (almost 40 %) because of very low values of mass fraction of AA in this phase but thermodynamic behavior remains well represented by the model (Fig. 3).

As usually encountered in liquid-liquid extraction, so-called Type I (Fig. 3a) or Type II (Fig. 3b) ternary diagrams can be obtained depending on temperature and pressure conditions. In the case of Type I behavior, the solute and the solvent are miscible in all proportions, while in the case of Type II, an immiscibility zone appears between these latter. It is the case for the carbon dioxide-acetic acid-water system at 80 °C and 15 MPa, for example. However, on Fig. 3c, it can be observed that this immiscibility zone is very narrow. These two kinds of behaviors are well accounted for by the selected thermodynamic model as it is seen on Fig. 3 for two sets of conditions described in the literature [25,33]. On the pressure and temperature range considered here, Type I and Type II are very close to each other because of the very narrow immiscibility zone between solute and solvent for Type II and the tie line directions for Type I contrarily, for example, to the CO<sub>2</sub>-ethanol-water system described by Brunner et al. [23].

At 80 °C and 15 MPa (Fig. 3b), it can be observed that the slope of the tie-lines exhibits unfavorable configuration to perform an efficient extraction of AA with CO<sub>2</sub>. This is mainly due to the low solubility of AA in the CO<sub>2</sub> phase and corresponds to the already mentioned low partition coefficients for the acid.

#### 4. Comparison of experiments and simulation for the conventional configuration

As reported in Table 2, most experiments were conducted at 40 °C and 10 MPa by varying the solvent-to-feed ratio (S/F). A higher pressure (15 MPa) and higher temperatures (45 °C and 60 °C) were also tested. Results are displayed in terms of experimental mass fraction of acetic acid ( $x_{AA}$ ) in the raffinate and in the extract, both on a CO<sub>2</sub>-free basis, and in terms of computed experimental recovery ratio of acetic acid ( $\tau_{AA}$ ) in the extract and in the raffinate. Performance of the operation can also be assessed using the concept of "concentration factor" which is defined as the ratio of the mass fraction of acetic acid in the CO<sub>2</sub>-free extract to the mass fraction of acetic acid in the feed.

Simulations of the supercritical fractionation column were performed using the ProSim Plus software (ProSim SA, France), which is a commercial tool allowing simulation of steady-state processes. Absorption module (ABSO) of ProSim Plus was used to simulate the counter-current column, described as a cascade of theoretical stages, accounting therefore only for thermodynamic equilibrium between phases and heat and mass balances at each stage (MESH equations). To operate the Prosim Plus software, it is mandatory to

**Table 2** Comparison between experimental results and simulation for one theoretical stage (N = 1) on ProSim Plus software.

Run	Operating conditions			Raffinate experimental results			Extract experimental results			Raffinate simulation results (N = 1)			Extract simulation results (N = 1)		
	P (MPa)	T (°C)	S/F	$x_{AA}$ (%w/w, CO <sub>2</sub> -free)	$\tau_{AA}$ (%) (mass balance)	Concentration factor	$x_{AA}$ (%w/w, CO <sub>2</sub> -free basis)	$\tau_{AA}$ (%) (mass balance)	Concentration factor	$x_{AA}$ (%w/w, CO <sub>2</sub> -free basis)	$\tau_{AA}$ (%)	Concentration factor	$x_{AA}$ (%w/w, CO <sub>2</sub> -free basis)	$\tau_{AA}$ (%)	Concentration factor
1	10	40	4.2	5.00 ± 0.21	96.2	6.03	31.25 ± 2.19	4.2	6.03	4.13	81.33	6.03	54.1	18.67	10.81
2	10	40	5.8	4.61 ± 0.21	86.4	6.24	32.58 ± 2.19	13.6	6.24	3.89	76.10	6.24	52.2	23.90	10.44
3	10	40	6.6	4.54 ± 0.21	84.7	4.97	25.81 ± 2.19	15.3	4.97	3.80	74.00	4.97	51.5	26.00	10.29
4	10	40	10.1	4.27 ± 0.21	79.5	5.88	30.45 ± 2.19	20.5	5.88	3.36	64.75	5.88	48.13	35.25	9.63
5	10	40	11.6	3.96 ± 0.21	73.2	6.45	33.44 ± 2.19	26.8	6.45	3.21	61.50	6.45	46.89	38.50	9.38
6	10	45	4.2	4.70 ± 0.21	91.3	4.97	25.13 ± 2.19	8.7	4.97	4.44	87.52	4.97	45.85	12.48	9.17
7	10	45	6.3	4.41 ± 0.21	83.7	4.13	20.88 ± 2.19	16.3	4.13	4.21	82.54	4.13	44.10	17.46	8.82
8	10	45	10.1	4.36 ± 0.21	83.4	5.24	26.52 ± 2.19	16.6	5.24	3.85	74.75	5.24	41.58	25.25	8.32
9	15	40	9.3	3.67 ± 0.21	69.2	8.06	41.12 ± 2.19	30.8	8.06	2.43	46.10	8.06	52.99	53.90	10.60
10	15	45	10.1	3.52 ± 0.21	66.6	7.84	39.65 ± 2.19	33.4	7.84	2.48	46.88	7.84	49.86	53.12	9.97
11	10	60	9.7	4.80 ± 0.21	86.0	1.98	10.27 ± 2.19	14.0	1.98	4.44	86.49	1.98	25.65	13.51	5.13



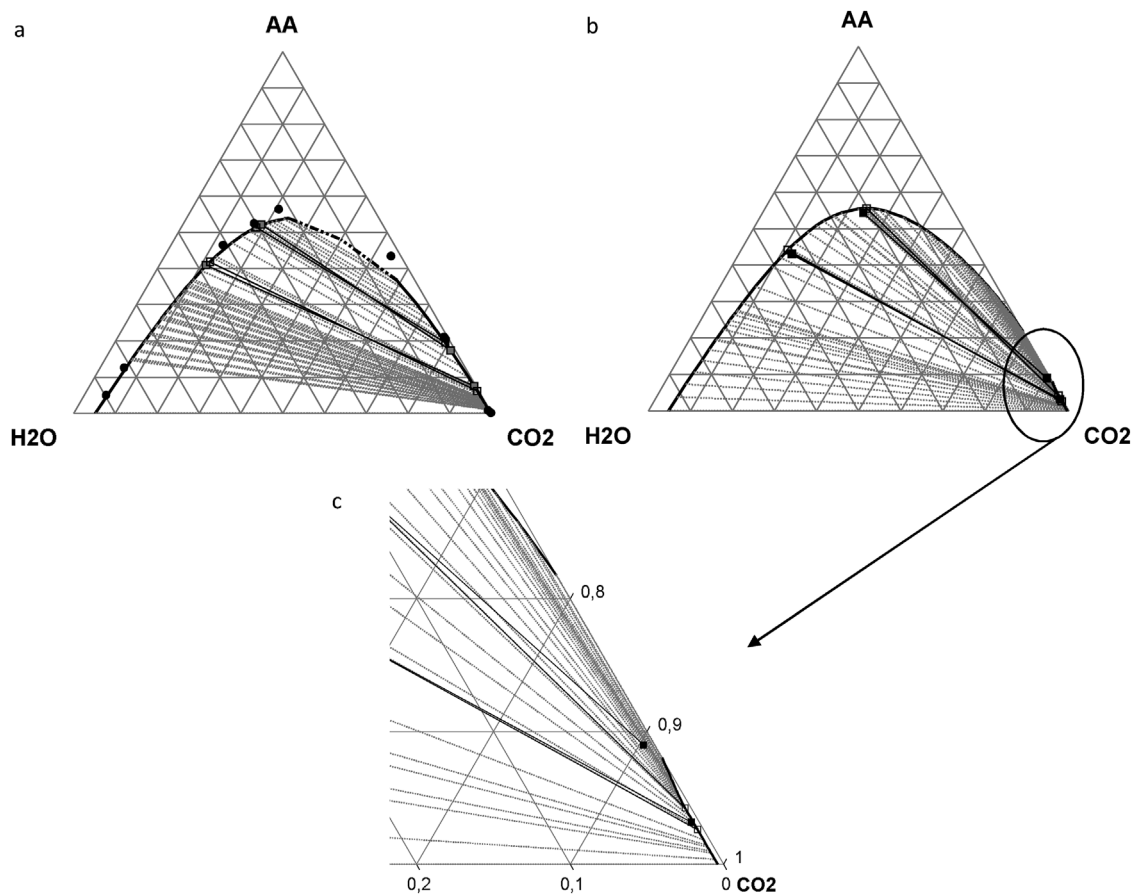

**Fig. 3.** a. Type I ternary diagram (mass fractions) for CO<sub>2</sub>-acetic acid-water system for 40 °C and 10 MPa, b. Type II ternary diagram (mass fractions) for CO<sub>2</sub>-acetic acid-water system for 80 °C and 15 MPa. and c. zoom in CO<sub>2</sub> corner in Type II diagram, 80 °C 15 MPa (–) equilibrium line calculated, □ calculated points, ● experimental data from Panagiotopoulos [25], ■ experimental data from Bamberger [33].

fix the number of stages and the location of the feed and then mass flows must be initialized before launching the computation. Thanks to an internal optimizer, the software is able to vary certain parameters to match specifications imposed by the user. This software is thus well adapted for our approach when thermodynamics are the prominent criterion. Lalam et al., in the context of isopropanol recovery using the same experimental set-up, have concluded that our column was equivalent to around one or two theoretical stages [29], depending on operating conditions. Although the theoretical stage concept is not well adapted to assess the mass transfer efficiency of a contactor (because it depends on the thermodynamics of the system of compounds), this former result nevertheless indicates that mass transfer efficiency of our experimental apparatus is rather low.

#### 4.1. Influence of solvent-to-feed ratio (S/F)

Influence of Solvent-to-Feed (S/F) ratio can be evaluated from runs 1–5 at 40 °C/10 MPa and from runs 6–8 at 45 °C/10 MPa. A first general conclusion on experimental results is that recovery ratio of AA ( $\tau_{AA}$ ) is favored by high S/F, whereas concentration factor is not strongly influenced, and stays almost constant in the range of S/F considered in this work whatever the temperature. This result tends to show that recovery ratio of water in the extract increases with the same trend that AA when increasing S/F. On a general way, it can be observed that concentration factors are slightly higher at 40 °C than at 45 °C at this pressure and the maximal value is obtained for run 5, where 26.8 % of AA is recovered at the extract with a concentration factor around 6.45.

Anyway, these experimental results show that separation performances are weak in terms of purity of AA in the extract and so concentration factor, as well as recovery ratio of AA in the extract. Best results were obtained at maximum S/F and low temperature.

It can be observed on Fig. 4 and Table 2 (runs 1–5 for 40 °C experiments and runs 6–8 for 45 °C experiments) that the global experimental trend of AA recovery ratio in the extract is well described by the simulation, *i.e.*, an increase of S/F leads to a better recovery ratio of AA. However, experimental concentration factors are lower than those given by the simulation that predicts a slight decrease of concentration factor when S/F increases, while this was not observed experimentally. The obtaining of higher computed values is directly related to the fact that the theoretical stage approach cannot describe systems with less than one theoretical stage, as it is the case here. So, in the range of experimental conditions investigated here, simulation systematically overestimates the actual performance of the separation.

Fig. 5 indicates that the influence of the number of theoretical stages at 45 °C and 10 MPa is more important at high S/F ratio and also shows that the number of stages has a weak influence on the separation performances. This can be explained by thermodynamic considerations and will be further developed.

However, the fact the experimental set-up has low mass transfer and is equivalent to less than one theoretical stage could be explained considering the “liquid wetting rate of the packing”, conventionally defined for gas-liquid packed columns as *volumic liquid flow rate / (specific packing area x cross section of the column)*. For our experimental system and conditions (liquid flow rate, column cross section and geometrical packing area), this gives values that

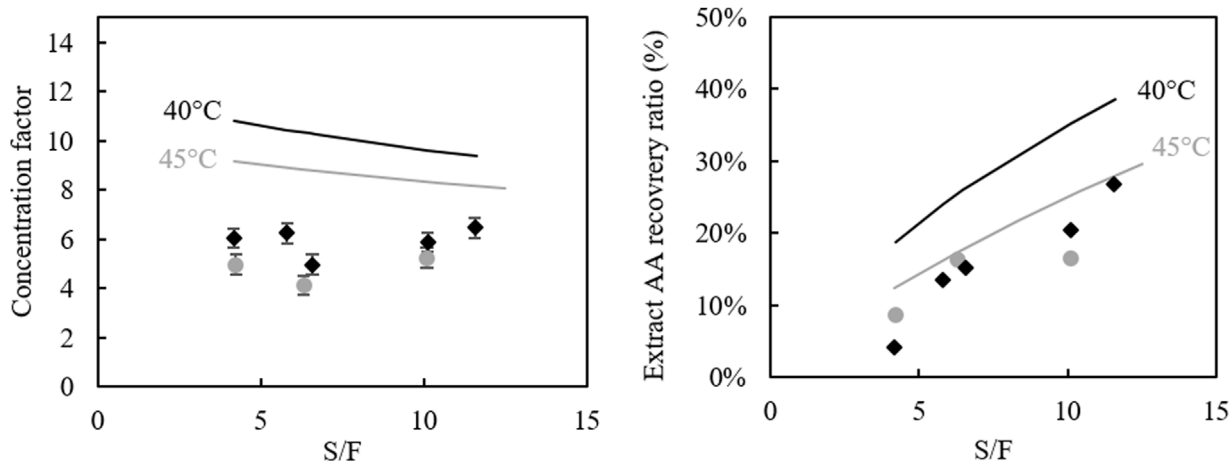

**Fig. 4.** Comparison between experiments (black dots: 40 °C and grey dots: 45 °C) and modelling (continuous lines) for one theoretical stage at 40 °C (black lines) and 45 °C (grey lines). Influence of S/F on the recovery ratio of AA and concentration factor (10 MPa,  $F=0.48$  kg/h, 5 % w/w AA).

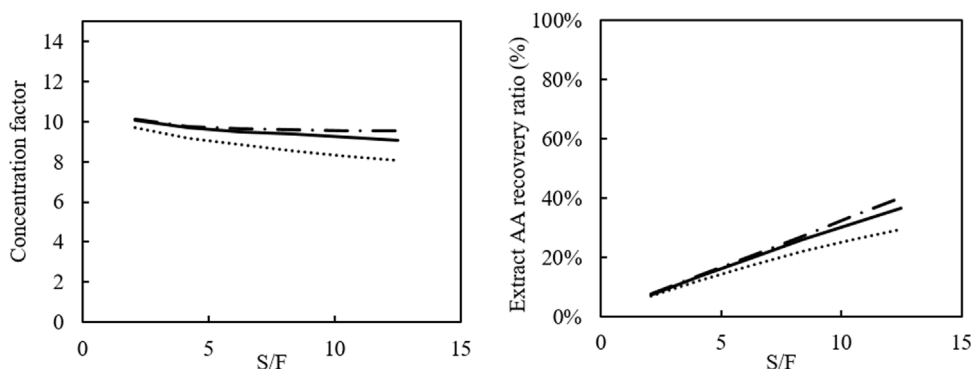

**Fig. 5.** Comparison between modelling of one theoretical stage (dotted lines), two theoretical stages (continuous lines) and ten theoretical stages (large and small dotted line) at 45 °C, 10 MPa,  $F=0.48$  kg/h, 5 % w/w AA.

are much lower than the usual minimum advised values for gas-liquid systems. Even if the liquid flow occurs here in a very different environment, because the supercritical phase is much denser than a gas, this nevertheless indicates that good liquid distribution on the packing is not favored. So the liquid-fluid exchange area is probably significantly smaller than the geometrical packing area, hence the poor mass transfer efficiency. One conclusion is that this contactor technology is not well adapted to this application because the liquid flow-rate is too low in respect to packing area. For instance, static mixers or sieve tray columns would have been a better option, as proposed by Seibert and Moosberg [37], in the context of the recovery of isopropanol with supercritical carbon dioxide, where it has been shown that a sieve tray extractor yielded the highest mass transfer efficiency.

Finally, simulation can be used to theoretically predict the best performances of separation that could be reached for this system, and what should be the number of theoretical stages necessary to reach this objective. This is illustrated on Fig. 6 which relates number of theoretical stages, S/F and concentration factors. For instance, for one theoretical stage, recovery ratio of 70 % and 90 % are obtained using S/F values around 30 and 180, respectively. When number of stages is 3, S/F value is around 10 for a recovery ratio of 70 % and around 50 for a recovery ratio of 90 %. Beyond 3, the number of stages has a weaker influence, as already shown on Fig. 5. So, it is seen that, with 3 theoretical stages, moderate values of the concentration factor, around 7, can be obtained if the imposed recovery ratio is not very high (70 %) using a realistic S/F value (around 10).

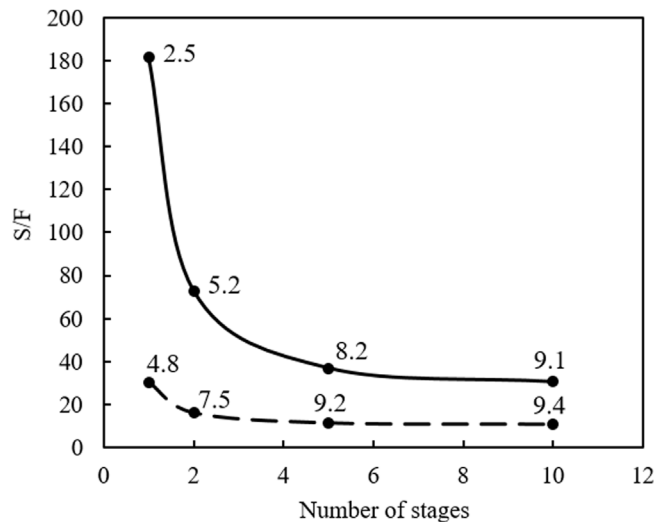

**Fig. 6.** Simulation results. S/F values as function of the number of stages, for different recovery ratio specifications, continuous line: recovery ratio = 90 % and dotted line: recovery ratio = 70 %. Values are computed at 45 °C and 10 MPa. Numbers reported near dots are values of the concentration factor.

At 10 MPa and 45 °C, at best, the concentration factor would be around 9 (*i.e.* around 45 % of AA in the CO<sub>2</sub>-free extract) even with a contactor with good mass transfer performances. Although this simple configuration extraction could not be used to obtain pure AA, note that, when moderate recovery ratios are acceptable, it



could be used as a pre-concentration step, before further purification.

#### 4.2. Influence of the pressure

Experiments were done at 45 °C and 40 °C, with a solvent-to-feed ratio equal to 10, at two different pressures, 10 and 15 MPa, (runs 4 and 9 at 40 °C and runs 8 and 10 at 45 °C in Table 2). The pressure of the process has been chosen according to experimental set-up limits and also because very high pressures cannot be envisaged in order to keep a significant density difference between the two phases to insure efficient mechanical phase separation.

Experimental results showed an improvement of the concentration factor and recovery ratio of AA when the pressure is increased for both temperatures. The best results have been obtained for run 10, i.e. at 15 MPa and 45 °C, for which the highest AA recovery ratio (33 %, compared to 17 % at 10 MPa) is obtained in the solvent-free extract with a concentration factor improved from around 5–8 (mass fraction of AA in the solvent-free extract is increased from 26.52 % to 39.65 %).

Here again, the computed values with one theoretical stage overestimate the experimental values but the tendency is reproduced by the simulation. At 45 °C, 10 MPa, simulation of a one-stage contactor predicts a concentration factor equal to 8.32 (41.58 % AA w/w in the extract CO<sub>2</sub>-free) with a 25.3 % recovery ratio. When pressure is increased from 10 to 15 MPa, simulation predicts a significant increase of the recovery ratio of acetic acid in the extract CO<sub>2</sub>-free (53.1 %) and a slight increase of acetic acid mass fraction (from 40 % to 50 %). Same conclusions can be drawn for 40 °C, 10 MPa.

Influence of higher pressures, up to 30 MPa at 45 °C, can be theoretically studied by using the ProSim Plus software. At 30 MPa, the recovery ratio of AA in the CO<sub>2</sub>-free extract increased to 70 % and mass fraction of AA in the CO<sub>2</sub>-free extract from 41 % at 10 MPa to around 50 %, this latter exhibiting a plateau around 15 MPa. As already mentioned, note that higher pressures are usually not considered, according to literature reviews [17,38], mostly because, in the case of aqueous systems, density difference becomes too low for easy decantation of phases. At 30 MPa, density difference is around 110 kg/m<sup>3</sup>.

As a conclusion, remember that only the trends can be represented by the simulation in this paper. To obtain a more accurate representation of experimental fractionation, a rate-based model (non-equilibrium model) should be preferred in this case as we proposed in our previous works [39].

#### 4.3. Influence of the temperature

It has been found experimentally at 10 MPa, that a change of temperature from 40 °C to 60 °C (Table 2, runs 4 and 11), led to a concentration factor decrease from 6 to 2. Indeed, at 60 °C, CO<sub>2</sub>-free extract was less concentrated in acetic acid (10.3 %w/w compared to 30.5 % at 40 °C) and acetic acid recovery ratio also decreased, 14.0 % compared to 20.5 % at 40 °C, which means that, at 10 MPa, a temperature increase is not favorable for the partition coefficient of AA. Similar trend was indicated by the simulation, where the concentration factor is divided by 2 (mass fraction of AA decreases from 48 % to 26 %) when temperature is increased from 40 °C to 60 °C and recovery ratio is also divided by 2 (from 35 % to 13 %). Indeed, when temperature is increased from 40 °C to 60 °C at 10 MPa, ternary diagram configuration is changed from Type I to Type II meaning that a solubility limit of AA in scCO<sub>2</sub> occurs at 60 °C, whereas at 40 °C, AA and CO<sub>2</sub> are totally miscible.

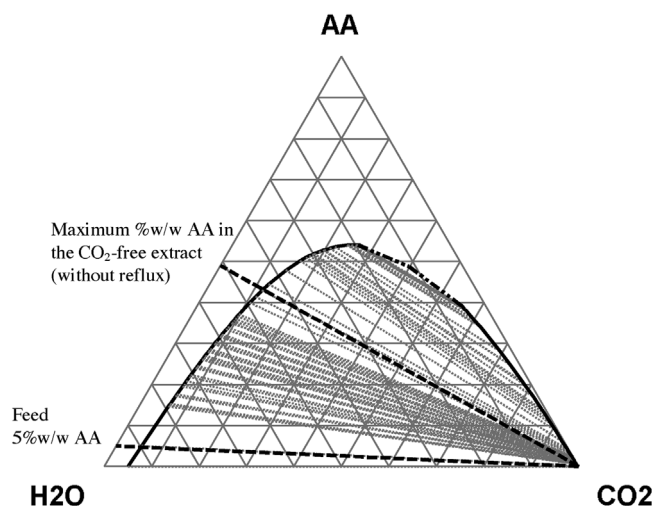

Fig. 7. Type I ternary diagram (mass fractions) for acetic acid-water-CO<sub>2</sub> system for 45 °C and 10 MPa. (–) Determination of maximum AA in the CO<sub>2</sub>-free extract.

#### 4.4. Conclusion upon the conventional column configuration

As a conclusion, the conventional configuration of counter-current column did not lead, in the case of a dilute feed, to efficient recovery of acetic acid in the extract.

Analysis of thermodynamic data will help to identify the limitations of our system. Considering the ternary diagram, it can be observed that a thermodynamic limitation of AA extraction with CO<sub>2</sub> is existing when a conventional column configuration is used in the case of a 5 %w/w aqueous feed. This is graphically illustrated using usual liquid-liquid extraction graphical constructions on ternary diagrams (Treybal [40]). Indeed, drawing the tie-line which passes by the point representing the 5 %w/w feed, and projecting the corresponding extract composition on the acetic acid-water side of the triangle, yields the maximum mass fraction of AA in the liquid extract obtained after removing CO<sub>2</sub> (CO<sub>2</sub>-free extract). At 45 °C and 10 MPa, the maximum AA mass fraction of the CO<sub>2</sub>-free extract is found around 50 %w/w (Fig. 7). Consequently, the concentration factor could not exceed 10 in this conventional column configuration. This ascertains that higher extract purity is not achievable with this simple contactor configuration. Experimental results shown in Table 2 are in accordance with this analysis since the maximum AA mass fraction in the CO<sub>2</sub>-free extract that was obtained at 45 °C and 10 MPa, was 26.5 % of acetic acid (run 8, S/F≈10). So, although mass transfer efficiency of our contactor is improvable, for instance by increasing the height of the column, this will not allow overpassing this theoretical maximum value of the AA concentration in the CO<sub>2</sub> free extract (50 %w/w).

As we mentioned above, depending on separation targets, this configuration (with a moderate concentration factor) could be useful to pre-concentrate the feed before another separation process, such as distillation for example. Nevertheless, we propose below to evaluate if the limitation cited above can be overridden if the counter-current extraction is operated with a reflux of extract. Such a configuration with reflux is also proposed in conventional liquid-liquid operation but examples are nevertheless seldom. In a first approach, we intend to assess the interest of this alternative by using simulation.

### 5. Assessment of the reflux configuration by simulation

#### 5.1. Thermodynamic study

Usual liquid-liquid extraction graphical analyses, using ternary diagrams, can be implemented to assess the interest of using a

reflux and also to obtain a preliminary estimation of the operating conditions. Then, using the ProSim Plus software, a deeper study can be performed by simulating the new configuration with reflux. The same 5 % w/w dilute acetic acid feed was considered. Two sets of realistic conditions were studied, 45 °C and 10 MPa, resulting in a Type I diagram, and 80 °C and 15 MPa, corresponding to a Type II diagram.

Graphically, the theoretical maximum solute concentration that can possibly be obtained in the extract when using a reflux is deduced by drawing a line linking the pure solvent point (bottom right summit of the triangle) to the tangency point at the two-phase curve. This gives the AA richer CO<sub>2</sub>-free extract that can be reached (intersection with the solute-diluent axis). Thus, it appears that, in the case of the Type I diagram (45 °C and 10 MPa, Fig. 8 left), a CO<sub>2</sub>-free extract containing about 90 % w/w of acetic acid could be obtained. Note that this value is rather high for a type I system and indicates a favorable case for reflux performance. For any type II systems, this value is always 100 %w/w (pure acetic acid) (80 °C and 15 MPa, Fig. 8 right).

At 45 °C, 10 MPa (Type I diagram), for a 5 %w/w acetic acid feed, we have shown that the maximum purity extract achievable in the conventional configuration is around 50 %w/w. At 80 °C, 15 MPa (Type II diagram), this value is around 40 %w/w. So, the higher theoretically achievable values mentioned in above paragraph (90 % and 100 %, respectively), clearly demonstrates the interest of the reflux mode in the case of a dilute feed.

### 5.2. Selection of extract reflux mode: internal or external reflux

In liquid-liquid extraction processes, two types of reflux of extract, internal or external reflux, can be operated. Internal reflux can be generated either by changing temperature in the enriching section of the column or by adding a component playing the role of anti-solvent.

In supercritical CO<sub>2</sub> columns internal reflux is usually implemented by increasing temperature in the enriching section (*i.e.*, above the feed). This operating mode is the most convenient on a technical point of view, because it can be operated without use of external equipment such as valves, tanks or pumps. Indeed, when the temperature is increased, the solute is expected to be de-solubilized (because of the decrease of the CO<sub>2</sub> density) and generate a downward AA rich liquid phase, in order to enrich the ascending CO<sub>2</sub> phase. To be interesting in the context of CO<sub>2</sub>-acetic acid-water system, a temperature range has to be found at a given pressure, in which a liquid phase would appear by changing the temperature from T1 in the stripping zone to T2 in the enriching zone. Graphically, the temperature of the enriching zone of the column should be such that the point corresponding to the extract of the stripping zone at temperature T1, falls inside the immiscibility zone at T2. A classical favorable configuration should be a change from diagram of Type 1 at T1 to Type II at T2. Surprisingly, the ternary diagrams of our system indicate that the point representing the extract in equilibrium with the feed in the Type I at T1, lies now in a monophasic zone in the Type II at T2. This means that no liquid phase would be generated when increasing the temperature. This surprising behavior is explained by the fact that increasing temperature, although it induces a decrease solubility of AA (thus a partial miscibility of AA and a shift to Type II diagram), conversely induces a significant increase of water solubility. These antagonist effects result in the above described peculiar behavior for the ternary system. All these considerations mean that use of an internal reflux of extract is not suitable for the particular case of dilute acetic acid recovery with scCO<sub>2</sub>.

So, external reflux must be envisaged, requiring a depressurization step for removal of the solvent and a liquid pump to re-inject a fraction of the CO<sub>2</sub>-free liquid extract at the top of the column. As

our experimental system does not allow implementing an external reflux, the study was done thanks to simulation and the flowsheet of the complete process with external reflux is represented on Fig. 9. Reflux ratio is defined as  $R_0/P_E$  ( $R_0$  being the liquid flowrate that is re-injected at the top of the column and  $P_E$  is the production of the process).

### 5.3. Simulation results for external extract reflux

As a first approach, the liquid-vapor separator at the top of the column and the separator at the bottom were described as ideal separators, allowing perfect removal of CO<sub>2</sub> from the extract. Consequently, in this simulation study, the value of pressure in the separators has no influence on the efficiency of acetic acid recovery at the CO<sub>2</sub> separation step, which would not be the case in the real process.

Note that the actual implementation of a reflux in our packed column would suffer of even more severe mass transfer limitation that in the case of the conventional configuration, due to still much lower liquid flow rate in the reflux section than in the conventional configuration.

Two distinct sets of conditions were selected in respect to thermodynamic behavior, *i.e.*, Type I diagram, at 45 °C and 10 MPa, and Type II diagram, at 80 °C and 15 MPa. Imposed specifications of AA mass fraction in the CO<sub>2</sub>-free extract were chosen very close to thermodynamic limitations (from the diagrams of Fig. 8) inducing operation at high reflux ratios. Minimum reflux ratio necessary to obtain 90 %w/w AA in the solvent-free extract was graphically evaluated using Janecke type diagrams for better accuracy (see Treybal [40]). In the range of 90 %w/w targeted values, very high minimal reflux ratios are necessary so this implies the use of high S/F values to maintain the productivity.

Position of the feed was chosen in order to define the same number of theoretical stages for both the enriching and stripping sections. Indeed, position of the feed proved to have only a slight influence on results.

Minimum reflux ratios, as well as minimum number of stages, for a targeted separation can also be obtained thanks to simulation. For a given number of stages and using the optimizer of the software, the reflux ratio and the solvent-to-feed ratio are varied to match the separation target (AA 90 %w/w in the CO<sub>2</sub>-free extract). This is shown on Fig. 10 where minimum reflux ratio  $(R_0/P_E)_{\min}$  is asymptotically obtained at high values of the number of stages. Conversely, the minimum number of stages is asymptotically obtained when the reflux ratio is very high. Recovery ratio was imposed to be 90 % for all cases. For Type I conditions, 45 °C and 10 MPa (Fig. 10 left), specifications were 90 %w/w in the CO<sub>2</sub>-free extract. Minimal reflux ratio is found to be around 11 and matches with the value graphically obtained. For Type II conditions, 80 °C and 15 MPa, minimal reflux ratio necessary to achieve the same target is higher (around 16). Minimal number of stages to reach specifications in terms of recovery ratio and mass fraction of AA in the extract were found around  $N=5$  for both conditions. Also, for both cases, solvent-to-feed ratios are similar and high (between 21 and 59). These values (minimum number of stages and minimum reflux ratio) can be used to propose reasonable values of design using conventional design rules. In our case, they were also used as initialization values for the software optimizer (see next paragraph 5.4).

Fig. 11 shows the behavior of the concentration factor and the recovery ratio of AA in the extract, at 10 MPa and 45 °C, as a function of the reflux ratio at fixed values of solvent-to-feed ratio. Such an analysis was already reported in literature, for example in the case of modelling the supercritical carbon dioxide separation of fish oils ethyl esters [41]. For a given S/F value, increasing reflux ratio leads to an increase of concentration factor until reaching

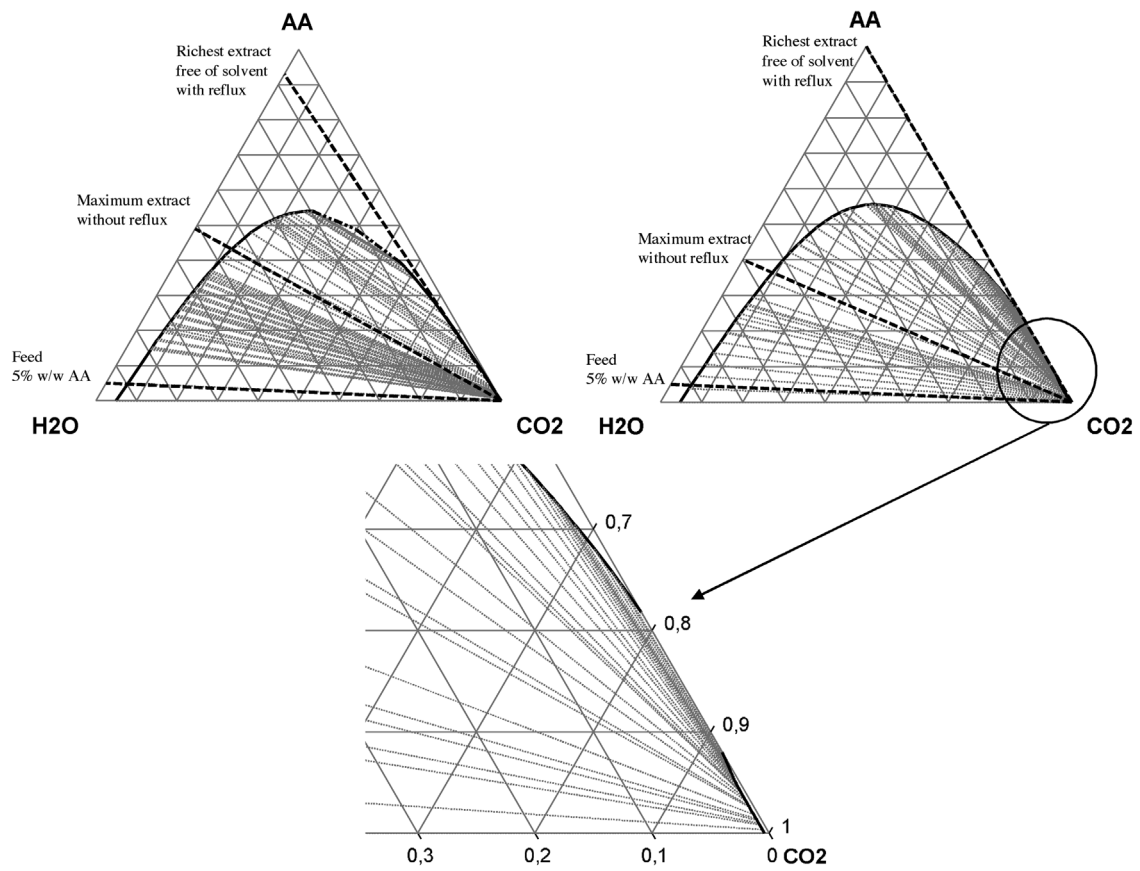

**Fig. 8.** Left: Type I ternary diagram (mass fractions) for CO<sub>2</sub>-acetic acid-water system for 45 °C and 10 MPa & Right: Type II ternary diagram (mass fractions) for CO<sub>2</sub>-acetic acid-water system for 80 °C and 15 MPa. (–) Determination of maximum extract purities according in conventional configuration and reflux configuration.

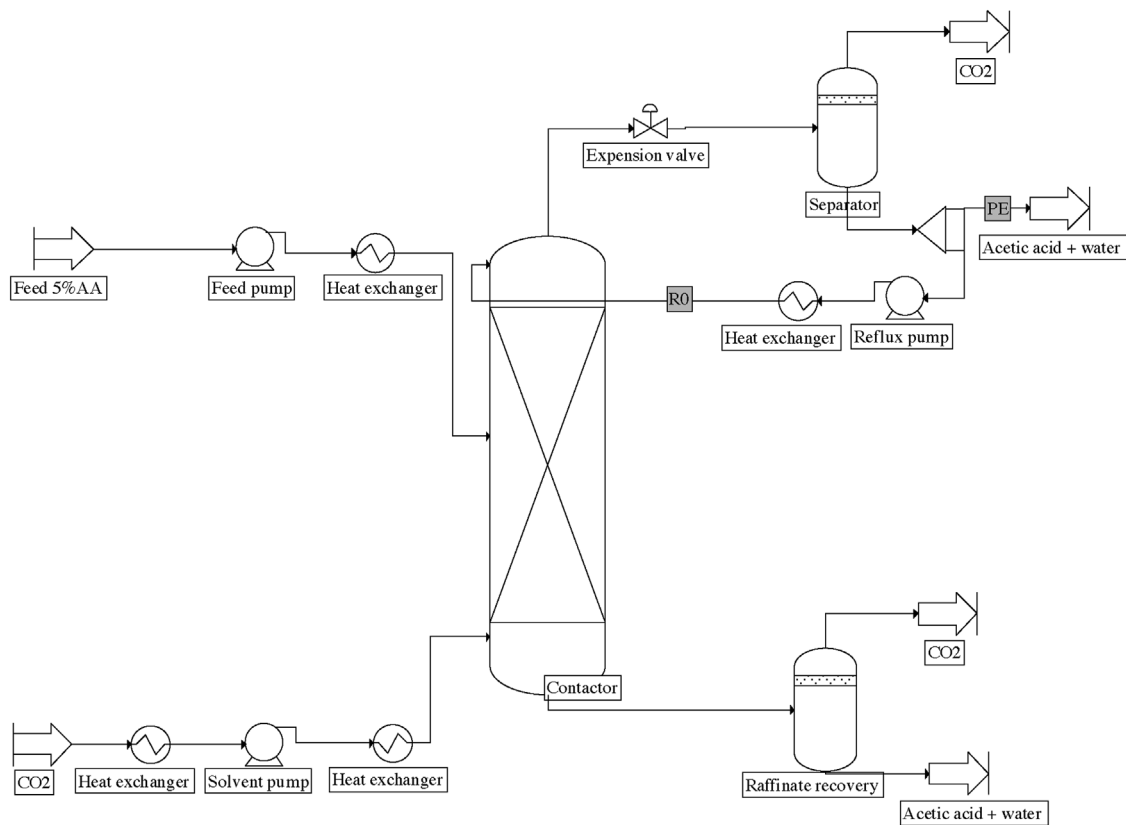

**Fig. 9.** Flowsheet of the simulation process of supercritical extraction with external extract reflux.

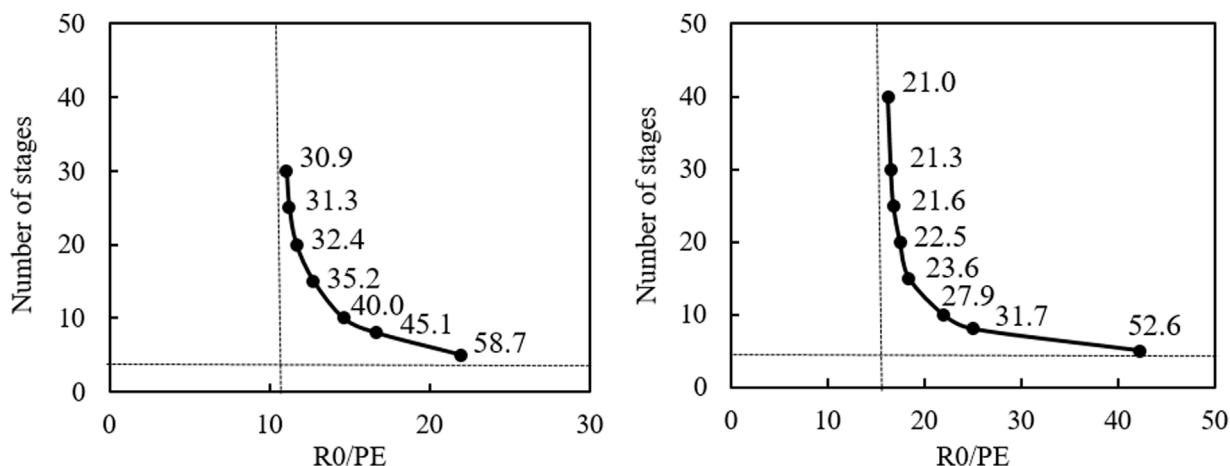

Fig. 10. Number of theoretical stages required in order to reach, in the extract, 90 % of recovery ratio for each conditions (45 °C 10 MPa on the left and 80 °C 15 MPa on the right) and mass fraction of 90 % w/w for Type I and Type II. Numbers reported near the simulated points stands for solvent-to-feed ratio.

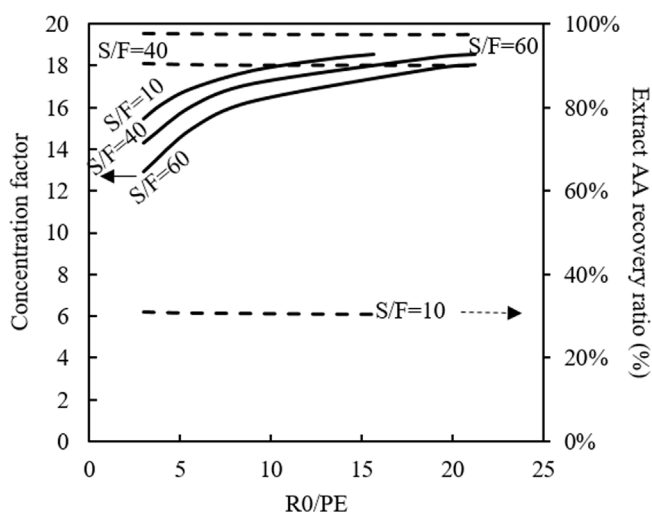

Fig. 11. Concentration factor (continuous lines) and recovery ratio (dotted lines) of acetic acid in the extract as a function of the reflux ratio for three different values of solvent-to-feed ratio. Simulations performed at 45 °C and 10 MPa for 10 theoretical stages (5 enriching stages).

the maximum achievable concentration factor about 18 (maximum achievable extract  $\approx 90$  %w/w at these conditions) according to thermodynamics. Also, for a given S/F value, increase of reflux ratio leads to an unexpectedly slight decrease of the AA recovery ratio in the extract. Moreover, at a given reflux ratio value, increase of S/F induces higher recovery ratio but a decrease of the concentration factor. So, in this case, this figure shows that the recovery ratio is mostly dependent upon S/F and that reflux ratio values above 12 ensure high concentration factors (around 18).

#### 5.4. Optimization of operating conditions

The optimizer of the Prosim Plus software was used to find the conditions leading to the best results in terms of AA mass fraction ( $x_{AA}$ ) and recovery ratio ( $\tau_{AA}$ ) in the extract for conditions of Type I (Table 3). In this approach, design parameters have to be fixed (number of stages and position of the feed), and the optimizer varies reflux ratio and solvent-to-feed ratio in order to reach imposed specifications. Optimization is run until maximum CO<sub>2</sub>-free AA mass fraction in the extract ( $x_{AA}$ ) and recovery ratio ( $\tau_{AA}$ ) are both maximum. Best values for both sets of conditions are indicated in Table 3.

At 45 °C and 10 MPa, Type I, using 10 theoretical stages, 5 being enriching stages, with S/F = 76.7 and a reflux ratio around 34, the mass fraction of AA in the CO<sub>2</sub>-free extract reached 92 %w/w (corresponding to the thermodynamic limitation) and recovery ratio was 99 %. If number of stages is increased from 10 to 20 (10 being enriching stages), the same separation performances are obtained (92 %w/w and recovery ratio = 99 %) but S/F is decreased to 46.4, as well as reflux ratio from 34 to 20.

Similarly, at 80 °C and 15 MPa, Type II, a recovery ratio of 99 % is obtained with a CO<sub>2</sub>-free mass fraction equal to 92 %w/w for similar design conditions (number of stages, feed position) but operating conditions are slightly different: solvent-to-feed ratio is decreased (for N = 10, S/F = 55.0 against 76.7 for Type I) and reflux ratio is increased (for N = 10, R<sub>0</sub>/P<sub>E</sub> = 49 against 34.3 for Type I). However, even theoretically possible, pure solute could not be obtained in these simulations (around 95 %w/w of AA in the extract solvent-free corresponding to a concentration factor around 19). Nevertheless, this higher purity is obtained with a lower recovery ratio, around 70 %.

Indeed, the simulated results concerning external extract reflux, for the two sets of conditions, yielded rather similar results. Type I appears to be very favorable for implementation of reflux, and a maximum 92 %w/w CO<sub>2</sub>-free extract is obtained. Solvent-to-feed ratio (S/F) values to get 99 % recovery are not so different for both cases. So, for the system carbon dioxide-acetic acid-water, it is *a priori* difficult to privilege one set of operating conditions.

We propose here to use the criterium of exergetic efficiency, as developed by Smith et al. [42] for CO<sub>2</sub> pump cycles. This criterium accounts for the “quality” of energy fluxes in the process by considering their potential for mechanical work recovery. For Type I and Type II, exergy loss can be computed using the dedicated fitted equation of Smith et al. [42]. In this work, chemical exergy, kinetic and potential energies were not taken into account. The difference between exergy flow input and exergy flow output was considered as irreversibility rate or exergy loss.

For a 5 MPa pressure in the separators, a value of 19.7 kJ/kg of CO<sub>2</sub> and 33.4 kJ/kg of CO<sub>2</sub> is obtained, for Type I and Type II, respectively. Considering a 99 % AA recovery and a 92 % AA purity of the CO<sub>2</sub>-free extract, and using the corresponding S/F values given in Table 3, this yields 3.27 10<sup>-5</sup> kg of AA/kJ of exergy loss for Type I (45 °C, 10 MPa) and 2.02 10<sup>-5</sup> kg of AA/kJ for Type II (80 °C, 15 MPa). These values can be compared because they correspond to similar separation objectives (recovery ratio = 99 % and AA mass fraction solvent-free = 92 %). According to this exergy study, Type I (45 °C, 10 MPa) would be preferred to Type II (80 °C, 15 MPa) because more



**Table 3**

Best simulation results for external extract reflux configuration (obtained with the optimizer of the Prosim Plus software). Feed 0.48 kg/h and 5 %w/w AA.

T = 45 °C P = 10 MPa TYPE I DIAGRAM							
Sim	S/F	N stages	N enriching stages	Reflux ratio	x <sub>AA</sub> extract (%w/w)	τ <sub>AA</sub> extract (%)	Concentration factor
1	76.7	10	5	34.3	92.0	99.0	18.4
2	46.4	20	10	20.4			
T = 80 °C P = 15 MPa TYPE II DIAGRAM							
Sim	S/F	N stages	N enriching stages	Reflux ratio	x <sub>AA</sub> extract (%w/w)	τ <sub>AA</sub> extract (%)	Concentration factor
3	55.0	10	5	49.0	92.0	99.0	18.4
4	16.3	20	10	24.1	95.0	70.0	19

product is obtained for the same exergy loss. Nevertheless, note that other criteria could have been envisaged, such as investments costs (CAPEX) or purely based on energy consumption of the whole processes.

So, we also propose here simplified energetic calculations, performed using the ProSim plus software, to estimate the energy consumption of the process. We have considered that 75 % of the energy required by the fractionation process is constituted by the compression of carbon dioxide [43,44]. As in Smith et al. [42], the compressor was considered as a single-stage compressor with no intercoolers (in our case isentropic efficiency was at 65 %). The same separation objectives were chosen (recovery ratio = 99 % and AA mass fraction solvent-free = 92 %). In the two configurations, after the separator, carbon dioxide is at 10 °C, 5 MPa, before entering the compressor. For Type I conditions, the computed energy consumption is 12.66 kW h/kg of 92 %w/w acetic acid. For Type II conditions, the energy consumption is 15.57 kW h/kg of 92 %w/w acetic acid. So, with the criterion of energetic cost, Type I will be preferred, as was also the case for the exergy loss criterion.

## 6. Conclusion

This work has proposed the use of supercritical CO<sub>2</sub> extraction to recover acetic acid from dilute aqueous solutions. This case is not favorable because partition coefficients are low but this unfavorable case enabled us to develop a complete methodology that can be adapted to the targeted separation specifications: pre-concentration, obtaining of a very pure extract, energetic priority. . . This pre-strategy has been developed here on a simplified mixture composed of only three compounds but it is very likely that the presence of other compounds (present in a fermentation broth for example) would not invalidate the strategic choices that have been made with this simplified mixture. Experiments were performed and evidenced the expected low separation performance in a configuration without reflux and were mainly caused by a thermodynamic limitation, not by the low mass transfer efficiency of our contactor. To overcome this thermodynamic limitation and to obtain a better separation, it was proposed to implement an external extract reflux because internal reflux was shown to be not suitable in the particular case of water-acetic acid mixture. Conventional graphical methods using ternary diagrams allowed evaluating design and operating parameters for this configuration (reflux ratio, number of stages. . .) and simulation using the Prosim Plus software (based on the concept of theoretical stages) confirmed that separation could be indeed improved.

Therefore, the less conventional reflux configuration proved to be effective on the point of view of purity of the extract but the required high solvent-to-feed ratio questions its relevance in this particular case. A deeper energetic study upon the regeneration of CO<sub>2</sub> has to be done to give a complete assessment.

Provided thermodynamic data are available, the same methodology can be applied to other carboxylic acids or even to other

organic solutes. Depending on the targeted separation, this will allow predicting performances and deciding for the interest of this technology, with or without the use of an extract reflux. Finally, the economic study, where the commercial value of the extracted product is taken into account, will provide the needed data to compare with other separation technologies.

## Declaration of Competing Interest

None.

## Acknowledgement

The authors thank French Ministry of Higher Education, Research and Innovation for funding of Astrid Novella PhD. The authors are grateful to Pr. Nadine Le Bolay for helping in using conventional liquid-liquid extraction design methods.

## References

- [1] T. Werpy, G. Petersen, A. Aden, J. Bozell, J. Holladay, J. White, A. Manheim, D. Eliot, L. Lasure, S. Jones, Top Value Added Chemicals from Biomass. Volume 1-Results of Screening for Potential Candidates from Sugars and Synthesis Gas, DTIC Document, 2004 <http://oai.dtic.mil/oai/oai?verb=getRecord&metadataPrefix=html&identifier=ADA436528>.
- [2] J.J. Bozell, G.R. Petersen, Technology development for the production of biobased products from biorefinery carbohydrates—the US Department of Energy's "Top 10" revisited, *Green Chem.* 12 (2010) 539, <http://dx.doi.org/10.1039/b922014c>.
- [3] E4tech, UK Top Bio-based Chemicals Opportunities, Lignocellulosic Biorefinery Network, United Kingdom, 2017 <https://lb-net.net/wp-content/uploads/2018/02/LBNet-UK-Top-Bio-based-Chemicals-Opportunities.Final.Dec2017.pdf>.
- [4] L.A. Román-Ramírez, Vapour-Liquid Equilibria of Acetic Acid + Water and Propanoic Acid + Water: Experimental Measurement and Thermodynamic Modelling, The University of Birmingham, 2015.
- [5] R. Taylor, L. Nattrass, G. Alberts, P. Robson, C. Chudzjak, A. Bauen, I.M. Libelli, G. Lotti, M. Prussi, R. Nistri, et al., From the Sugar Platform to Biofuels and Biochemicals: Final Report for the European Commission Directorate-General Energy, E4tech/Re-CORD/Wageningen UR, 2015 <http://library.wur.nl/WebQuery/wurpubs/492297>.
- [6] C.S. López-Garzón, A.J.J. Straathof, Recovery of carboxylic acids produced by fermentation, *Biotechnol. Adv.* 32 (2014) 873–904, <http://dx.doi.org/10.1016/j.biotechadv.2014.04.002>.
- [7] A.J.J. Straathof, The proportion of downstream costs in fermentative production processes, in: *Compr. Biotechnol.*, 2nd ed., Elsevier, 2011, pp. 811–814.
- [8] A.J.J. Straathof, Transformation of biomass into commodity chemicals using enzymes or cells, *Chem. Rev.* 114 (2014) 1871–1908, <http://dx.doi.org/10.1021/cr400309c>.
- [9] P. Pal, J. Nayak, Acetic acid production and purification: critical review towards process intensification, *Sep. Purif. Rev.* 46 (2017) 44–61, <http://dx.doi.org/10.1080/15422119.2016.1185017>.
- [10] S. Widagdo, W.D. Seider, Journal review - azeotropic distillation, *AIChE J.* 42 (1996) 96–130, <http://dx.doi.org/10.1002/aic.690420110>.
- [11] H. Cheung, R.S. Tanke, G.P. Torrence, Acetic acid, in: Wiley-VCH Verlag GmbH & Co. KGaA (Ed.), *Ullmanns Encycl. Ind. Chem.*, Wiley-VCH Verlag GmbH & Co. KGaA, Weinheim, Germany, 2011, [http://dx.doi.org/10.1002/14356007.a01\\_045.pub2](http://dx.doi.org/10.1002/14356007.a01_045.pub2).
- [12] I.L. Chien, K.-L. Zeng, H.-Y. Chao, J. Hong Liu, Design and control of acetic acid dehydration system via heterogeneous azeotropic distillation, *Chem. Eng. Sci.* 59 (2004) 4547–4567, <http://dx.doi.org/10.1016/j.ces.2004.06.041>.

- [13] T. Dobre, T. Ofiteru, A. Sturzoiu, Liquid-liquid extraction by continuous solvent recycling for acetic acid separation, *UPB Sci. Bull. Ser. B Chem. Mater. Sci.* 68 (2006).
- [14] S. Haque, M.Z.H. Khan, Bhupesh C. Roy, M. Helal Uddin, Separation of acetic acid from aqueous solution using various organic solvents, *J. Sci. Technol.* 5 (2013).
- [15] K. Sofiya, B. Karunanithi, R. Thilakavathi, Solubility data of several solvents in acetic acid separation process, *Int. J. Latest Trends Eng. Technol.* 8 (2017) 168–171, <http://dx.doi.org/10.21172/1.83.023>.
- [16] C. Chilev, F.D. Lamari, M. Dicko, E. Simeonov, Investigation of acetic acid dehydration by various methods, *J. Chem. Technol. Metall.* 51 (2016) 73–84.
- [17] A. Bejarano, P.C. Simões, J.M. del Valle, Fractionation technologies for liquid mixtures using dense carbon dioxide, *J. Supercrit. Fluids* 107 (2016) 321–348, <http://dx.doi.org/10.1016/j.supflu.2015.09.021>.
- [18] I. Medina, J.L. Martínez, Dealcoholisation of cider by supercritical extraction with carbon dioxide, *J. Chem. Technol. Biotechnol.* 68 (1997) 14–18, [http://dx.doi.org/10.1002/\(SICI\)1097-4660\(199701\)68:1<14::AID-JCTB589>3.0.CO;2-E](http://dx.doi.org/10.1002/(SICI)1097-4660(199701)68:1<14::AID-JCTB589>3.0.CO;2-E).
- [19] F.J. Señoráns, A. Ruiz-Rodríguez, E. Ibañez, J. Tabera, G. Reglero, Countercurrent supercritical fluid extraction and fractionation of alcoholic beverages, *J. Agric. Food Chem.* 49 (2001) 1895–1899, <http://dx.doi.org/10.1021/jf001261v>.
- [20] F.J. Señoráns, A. Ruiz-Rodríguez, S. Cavero, A. Cifuentes, E. Ibañez, G. Reglero, Isolation of antioxidant compounds from orange juice by using countercurrent supercritical fluid extraction (CC–SFE), *J. Agric. Food Chem.* 49 (2001) 6039–6044, <http://dx.doi.org/10.1021/jf010762t>.
- [21] K. Gast, M. Jungfer, C. Saure, G. Brunner, Purification of tocopherols from edible oil, *J. Supercrit. Fluids* 34 (2005) 17–25, <http://dx.doi.org/10.1016/j.supflu.2004.09.003>.
- [22] M. Carles, J. Fra, C. Perre, G. Delestre, Extraction par CO<sub>2</sub> supercritique en continu sur colonne équipée d'un reflux - Application à la séparation eau/alcools en taille semi-industrielle, Paris, 1991.
- [23] M. Budich, G. Brunner, Supercritical fluid extraction of ethanol from aqueous solutions, *J. Supercrit. Fluids* 25 (2003) 45–55.
- [24] S.M. Payne, F.M. Kerton, Solubility of bio-sourced feedstocks in 'green' solvents, *Green Chem.* 12 (2010) 1648, <http://dx.doi.org/10.1039/c0gc00205d>.
- [25] A.Z. Panagiotopoulos, R.C. Willson, R.C. Reid, Phase equilibria in ternary systems with carbon dioxide, water and carboxylic acids at elevated pressures, *J. Chem. Eng. Data* 33 (1988) 321–327.
- [26] C.R. Bhupesh, M.J. Kabir, M.S. Rahman, Ternary phase equilibrium data for acetic acid-water-solvent systems and separation of acetic acid from aqueous solution, *J. Appl. Sci.* 5 (2005) 720–723.
- [27] K.M. Dooley, A.W. Cain, F. Carl Knopf, Supercritical fluid extraction of acetic acid, alcohols and other amphiphiles from acid-water mixtures, *J. Supercrit. Fluids* 11 (1997) 81–89, [http://dx.doi.org/10.1016/S0896-8446\(97\)00026-0](http://dx.doi.org/10.1016/S0896-8446(97)00026-0).
- [28] B.G. Garrett, K. Srinivas, B.K. Ahring, Design and optimization of a semi-continuous high pressure carbon dioxide extraction system for acetic acid, *J. Supercrit. Fluids* 95 (2014) 243–251, <http://dx.doi.org/10.1016/j.supflu.2014.08.029>.
- [29] R. Lalam, S. Chamali, S. Camy, D. Rouzineau, R. Kessas, J.-S. Condoret, Fractionation of aqueous isopropanol mixtures in a countercurrent packed column using supercritical CO<sub>2</sub>, *J. Supercrit. Fluids* 101 (2015) 24–35, <http://dx.doi.org/10.1016/j.supflu.2015.02.032>.
- [30] R. Alford, M. Burns, N. Burns, Dixon Rings - A revolutionary random column packing, *Filtration* 11 (2011) 218–223.
- [31] Dixon rings, CROFT Filters. (n.d.). <https://www.filters.co.uk/filters/dixon-rings.php>.
- [32] S.M. Pourmortazavi, S.S. Hajimirsadeghi, Supercritical fluid extraction in plant essential and volatile oil analysis, *J. Chromatogr. A* 1163 (2007) 2–24, <http://dx.doi.org/10.1016/j.chroma.2007.06.021>.
- [33] A. Bamberger, G. Sieder, G. Maurer, High-pressure phase equilibrium of the ternary system carbon dioxide + water + acetic acid at temperatures from 313 to 353 K, *J. Supercrit. Fluids* 32 (2004) 15–25, <http://dx.doi.org/10.1016/j.supflu.2003.12.014>.
- [34] G.M. Kontogeorgis, G.K. Folas, *Thermodynamic Models for Industrial Applications*, John Wiley & Sons Ltd, United Kingdom, 2010.
- [35] J. Briones, J. Mullins, M. Thies, B.-U. Kim, Ternary phase equilibria for acetic acid-water mixtures with supercritical carbon dioxide, *Fluid Phase Equilib.* 36 (1987) 235–246.
- [36] S. Laugier, D. Richon, H. Renon, Simultaneous determination of vapor-liquid equilibria and volumetric properties of ternary systems with a new experimental apparatus, *Fluid Phase Equilib.* (1990) 19–34.
- [37] A.F. Seibert, D.G. Moosberg, Performance of spray, Sieve Tray, and packed contactors for high pressure extraction, *Sep. Sci. Technol.* 23 (1988) 2049–2063, <http://dx.doi.org/10.1080/01496398808075682>.
- [38] C.A. Pieck, *Development of Tools for the Implementation of an Industrial-scale Supercritical Fractionation Process*, Université Aix-Marseille, 2015.
- [39] N. Gañán, J. Morchain, S. Camy, J.-S. Condoret, Rate-based simulation of a high pressure counter-current packed column for supercritical CO<sub>2</sub> extraction of alcohol from dilute aqueous mixtures, *J. Supercrit. Fluids* 135 (2018) 168–179, <http://dx.doi.org/10.1016/j.supflu.2018.01.020>.
- [40] R.E. Treybal, *Liquid Extraction*, 2nd edition, McGraw-Hill Book Company, New York, 1963.
- [41] F. Gironi, M. Maschietti, Separation of fish oils ethyl esters by means of supercritical carbon dioxide: thermodynamic analysis and process modelling, *Chem. Eng. Sci.* 61 (2006) 5114–5126, <http://dx.doi.org/10.1016/j.ces.2006.03.041>.
- [42] R.L. Smith, H. Inomata, M. Kanno, K. Arai, Energy analysis of supercritical carbon dioxide extraction processes, *J. Supercrit. Fluids* 15 (1999) 145–156.
- [43] A.J. Allen, S.K. Muse, *Energy Analysis of Butanol Extraction Using Supercritical Carbon*, Worcester Polytechnic Institute, 2017.
- [44] G.A. Tompsett, J.T. Boock, C. DiSpirito, E. Stolz, D.R. Knutson, A.G. Rivard, M.R. Overdeest, C.N. Conlon, K.L.J. Prather, J.R. Thompson, M.T. Timko, Extraction rate and energy efficiency of supercritical carbon dioxide recovery of higher alcohols from dilute aqueous solution, *Energy Technol.* 6 (2018) 683–693, <http://dx.doi.org/10.1002/ente.201700626>.