



HAL
open science

Modelling of a conveying zone of a corotating twin screw extruder based on the local residence time distribution

Mathilde Mercier, Sandrine Hoppe, Thierry Vivier, Guo-Hua Hu, Fernand Pla

► To cite this version:

Mathilde Mercier, Sandrine Hoppe, Thierry Vivier, Guo-Hua Hu, Fernand Pla. Modelling of a conveying zone of a corotating twin screw extruder based on the local residence time distribution. 18th Annual Meeting of the Polymer Processing Society, Jun 2002, Guimarães, Portugal. hal-02521860

HAL Id: hal-02521860

<https://hal.science/hal-02521860>

Submitted on 24 Feb 2023

HAL is a multi-disciplinary open access archive for the deposit and dissemination of scientific research documents, whether they are published or not. The documents may come from teaching and research institutions in France or abroad, or from public or private research centers.

L'archive ouverte pluridisciplinaire **HAL**, est destinée au dépôt et à la diffusion de documents scientifiques de niveau recherche, publiés ou non, émanant des établissements d'enseignement et de recherche français ou étrangers, des laboratoires publics ou privés.

Modelling of the conveying zone and study of the melting zone in a twin-screw extruder through local Residence Time Distributions

M. Mercier^(a), S. Hoppe^(a), T. Vivier^(b), G-H. Hu^(a), F. Pla^(a)

(a) Laboratoire des Sciences du Génie Chimique

1 rue Grandville BP451-54001 Nancy Cedex, France

(b) CERDATO, Atofina 27470 Serquigny, France

Abstract

This work gives an access to local Residence Time Distribution (RTD) in a twin-screw extruder and is concerned by the elaboration of a model for a conveying zone and a study of the melting zone.

An in-line fluorescence monitoring device has been designed to determine local RTD functions along a co-rotating twin screw extruder. The sensor used can be mounted at various locations in the barrel. Experiments were carried out to validate this system.

The convolution theory enables to determine the RTD functions of independent sections of the extruder. This mathematical device gives an access to local zones such as melting areas despite some measurement difficulties.

Then, a predictive model of conveying screw elements is developed based on the flow in individual screw elements and the theory of convolution. First, the conveying zone is divided into independent elements to be defined. Second, the flow inside the channel is supposed to be the same as in a parallel plate model. Then, the model is achieved by the statistical superposition of the individual RTDs.

Finally, another interesting use of the fluorescent signal is to correlate it with the melting state and the temperature of the polymer in the melting zone.

INTRODUCTION

Residence Time Distribution (RTD) in a twin-screw extruder is one of the most important parameters for characterizing an extrusion process in terms of material flow, product quality, chemical reaction efficiency and mixing performance. In the literature, many authors only measure the overall RTD but local RTDs provide more insight information about the flow and mixing in individual screw areas enabling to understand and improve the processing conditions.

An efficient in-line method to characterize the flow in local zones is presented here. In a previous work, Hu and Kadri [1] used an on-line fluorescence monitoring device with measurements at the die exit whereas in the present system, the injection of the fluorescent tracer and the RTDs measurements are made at any location along the extruder. Optical fiber probes are used in order to obtain real-time measurements of the fluorescence response of anthracene.

First, experiments are carried out to measure local residence time distributions in different processing conditions and to determine the quality of mixing thanks to the specific throughput.

Then, the RTD functions of independent sections of the extruder are numerically convoluted and compared to the overall RTD function. The convolution theory enables to determine RTD functions corresponding to each independent section of the extruder despite some possible measurement difficulties especially in the melting area.

The following part of this work concerns two possible applications of the RTD measurements.

To understand the flow behaviour, numerous models have been developed. This paper develops a predictive model for a conveying zone of a co-rotating twin screw extruder based on the convolution theory introduced by Chen et al.[2, 3, 4] for a non intermeshing counter-rotating twin screw extruder.

In Reactive Extrusion, grafting reactions occur mainly in the melting zone of the extruder [5]. Generally, chemical models suffer from the absence or the complexity of description of the melting process ([6], [7]). Bawiskar and White [8] analyze polymer extractions to quantify the solid phase evolution. As Migler and Bur [9] have noticed, the fluorescence signal depends on the temperature. Our purpose is to show how on-line measurements can be correlated with the melting state and the polymer temperature.

1. THEORETICAL BACKGROUNDS

1.1 RTD functions

The RTD is described quantitatively using the function, $f(t)$, introduced by Danckwerts [10]. $f(t).dt$ represents the fraction, at the exit, of flow that has been in the extruder during a period comprised between t and $t + dt$.

It can be evaluated thanks to data of concentration c vs. time using the following equations [11]:

$$f(t) = \frac{c(t)}{\int_0^{\infty} c(t) dt} \quad (1)$$

The mean residence time is then given by :

$$t_m = \int_0^{\infty} t f(t) dt = \frac{V_f}{Q} \quad (2)$$

where V_f represents the filled volume and Q is the volumetric flow rate.

Dimensionless time θ can be defined:

$$\theta = \frac{t}{t_m} \quad (3)$$

$$f(\theta) = t_m f(t) \quad (4)$$

The variance represents the axial dispersion:

$$\sigma_t^2 = \int_0^{\infty} (t - t_m)^2 f(t) dt \quad (5)$$

and,

$$\sigma_{\theta}^2 = \frac{\sigma_t^2}{t_m^2} \quad (6)$$

1.2 Superposition of RTD functions

Consider n statistically independent screw elements with individual RTD functions $f_1(t)$, $f_2(t)$, $f_n(t)$. This statistic independence requires a two-dimensional perfect mixing or a uniform concentration at every boundary that connect two subsystems. Moreover, each subsystem must be closed. So particles in the downstream subsystem do not communicate with adjacent ones [4].

The overall RTD $f(t)$ is given, in the Laplace domain, by [12]:

$$\bar{f}(s) = \bar{f}_1(s) \bar{f}_2(s) \dots \bar{f}_n(s) \quad (7)$$

It corresponds, in the time domain, to:

$$f(t) = \int_0^t f_1(\tau_1) \int_0^{t-\tau_1} f_2(\tau_2) \dots \times \int_0^{\tau_{n-3}-\tau_{n-2}} f_{n-1}(\tau_{n-1}) f_n(\tau_{n-2} - \tau_{n-1}) d\tau_{n-1} \times \dots d\tau_2 d\tau_1 \quad (8)$$

1.3 RTD model for a conveying zone

The theory of convolution can be used between statistically independent elements. In a twin-screw extruder, the flow is supposed to be sufficiently randomized in the apex area between the two screws to consider that the RTD functions in any two adjacent half-turns of the screw channel [4] are independent. The model for a given conveying zone presented here is based on the multiple convolution of those individual elements.

As a first approximation, the RTD in an individual turn of the screw channel can be represented by the RTD model for a single screw extruder filled with a Newtonian melt, developed by Pinto and Tadmor [13], used by Wolf and White [14] and by Chen et al.[4].

The equations are based on a parallel plates model and constant depth of the channel. The distribution function $f(t)$ is represented by:

$$f(t) = \frac{9v_b(1+\Theta)}{2} \frac{\sin\theta \times \cos\theta}{L} \frac{a^3(a-1-(1+2a-3a^2)^{0,5})^3}{(6a^2-4a-1)(3a-1+(1+2a-3a^2)^{0,5})} \quad (9)$$

where $a=y/H$ ($a<2/3$) is a dimensionless coordinate,
 y measures the distance from the screw root,
 H is the channel depth,
 θ represents the helix angle,
 L is the axial length,
 V_b is the barrel velocity,
 V_z the down channel velocity component of the barrel,

The ratio between the pressure and the drag flow, noted Θ , is defined by equation 10 and is related to the flow rate through relation 11:

$$\Theta = -\frac{H}{6v_z} \frac{1}{\mu} \frac{\partial P}{\partial z} \quad (10)$$

$$Q = \frac{WHv_z}{2} (1+\Theta) \quad (11)$$

where μ is the viscosity.

The time, t , is related to the dimensionless coordinate, a by:

$$t = \frac{L}{3v_z(1+\Theta)} \frac{1}{\sin\theta \times \cos\theta} \frac{3a-1+3(1+2a-3a^2)^{0,5}}{a(1-a+(1+2a-3a^2)^{0,5})} \quad (12)$$

The mean residence time is then equal to:

$$t_m = \frac{2L}{v_z(1+\Theta)} \frac{1}{\sin\theta \times \cos\theta} \quad (13)$$

2. EXPERIMENTAL

The extruder used was a Clextral BC21 fully intermeshing co-rotating twin screw extruder.

2.1 System of detection

2.1.1 Monitoring device

A fluorescence monitoring device was used to measure in real time the RTD function. Optical fiber probes, made in silica to endure high temperatures, transmitted optical excitation energy (UV light: $\lambda = 365\text{nm}$) and detected anthracene fluorescence response ($\lambda = 400\text{ nm}$).

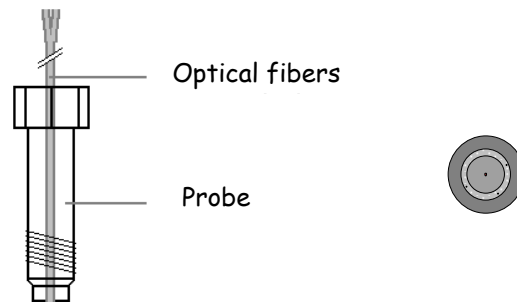

Figure 1. Optical fiber probes (length 1,5 m, diameter 6 mm)

The fluorescent tracer used was a masterbatch made with 9-(methylamino-methyl)-anthracene (1% wt.) dispersed in polymer [15].

It was injected at different locations along the extruder. At the feed throat, pellets of tracer were injected as a pulse. In the melt zone, pellets were melted and injected thanks to an air pulse jet.

The detection system is shown in figure 2.

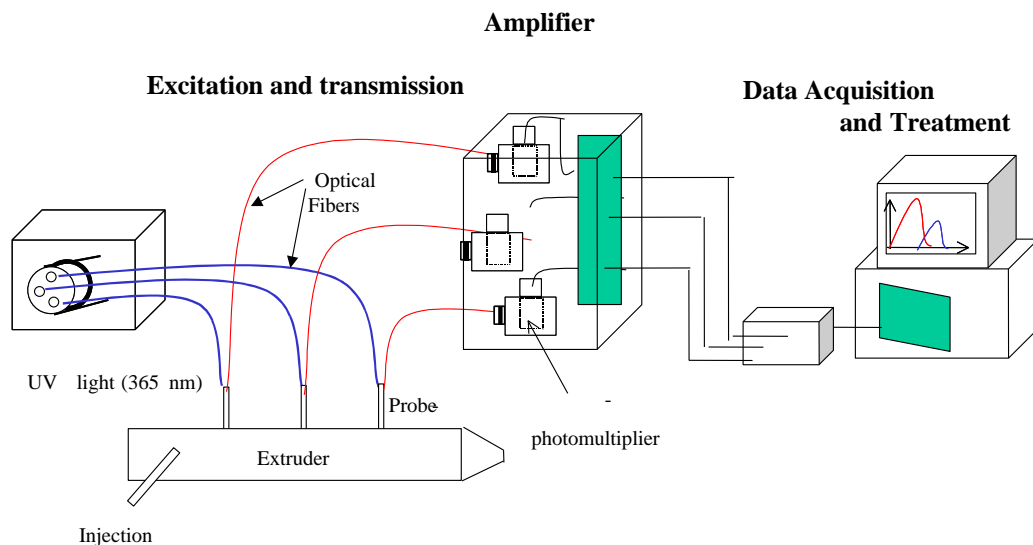

Figure 2. RTD measurement system

2.1.2 Validation of the system of detection

Figure 3 presents the screw profile used for studying the influence of operating conditions and the reproducibility of the measurements. It also indicates the injection and detection locations.

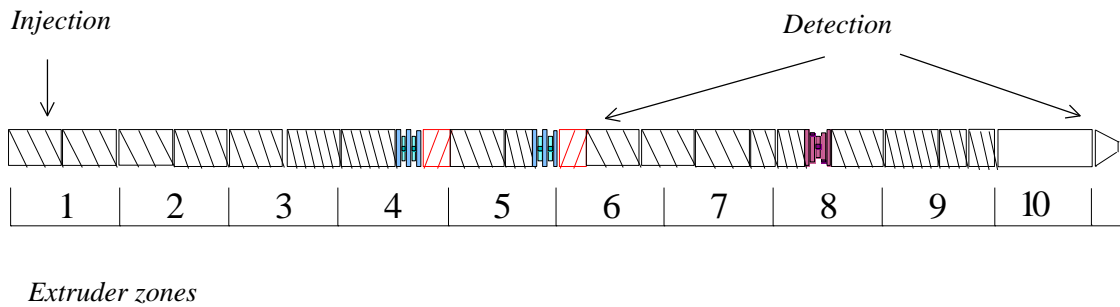

Figure 3. Screw profile A

Some explanations about the screw elements are given in the table 1.

Conveying element, type C2F					
Pitch (mm)	16.66	25	33.33	25	33.33
Length (mm)	50	50	50	25	25
Reverse element, type C2F			Kneading block, type BLO2		
Pitch (mm)	16.66	25	Rotation	90°	45° left
Length (mm)	50	50	Length (mm)	50	50

Table 1. Screw elements

2.2 Convolution theory

A global RTD functions is the result of the convolution of local RTD functions corresponding to local areas separated by a perfect two-dimensional mixing. The screw profile B shows different locations of injection and detection used to validate the convolution theory.

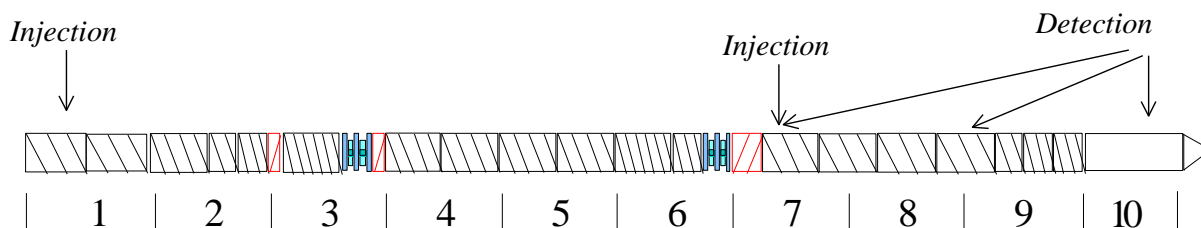

Figure 4. Screw profile B

The convolution theory can be verified between independent elements. In our experiments, staggered elements included to the screw profile at the beginning of zone 7 (figure 4, Screw profile B) enable to obtain perfect mixing. In theory, f must be equal to the convolution result of f_1 and f_2 . Figure 5 shows the principle of the convolution.

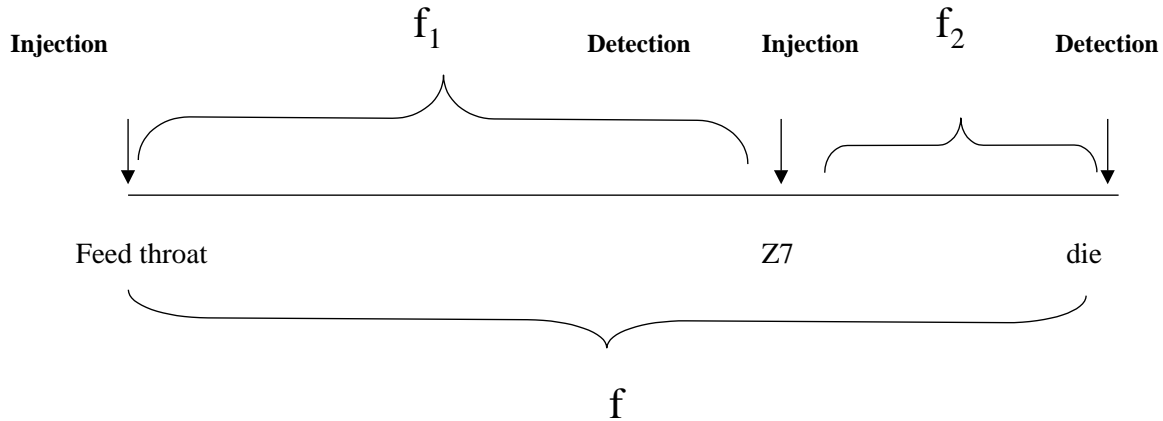

Figure 5. Convolution principle

The convolution theory was verified with two polymers: Polyethylene (HDPE, BASF Lupolen 5031 L) and Polypropylene (Atofina, Appryl MN1). The tracer used is a masterbatch of polymer and 9-(methylamino-methyl)-antracene (1% wt). The mass injected is 0.1 g.

Experiment number	Injection location	Detection location
N1	Feed throat	Z7
N2	Z7	die
N3	Feed throat	die

Table 2. Experiments

The convolution of f_1 and f_2 has been numerically calculated and compared to the RTD function obtained in experiment N3.

2.3 Model for a Conveying zone

The twin screw zone 6 composed of conveying screw elements presented on figure 6 will be modelled as depicted in paragraph 1.3.

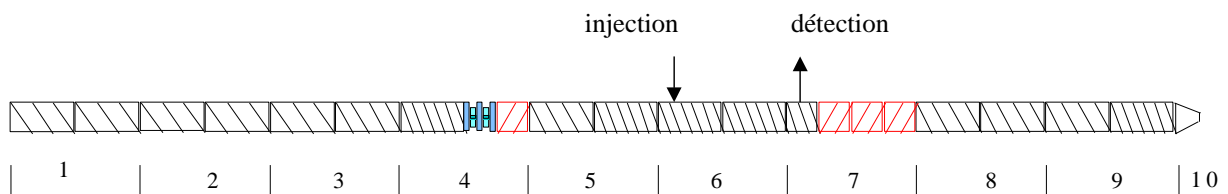

Figure 6. Screw profile C

As the model presented by Pinto and Tadmor [13] is valid for screw filled elements, a low values of screw rotation speed) and a low viscous polymer was used (Polypropylene Solvay HY001P) in order to fill the channel. As a verification, measurements of the pressure were made.

2.4 Fluorescent signal and melting state

This paragraph concerns the polymer characterization in the melting zone in terms of temperature and melting state.

Migler and Bur [9] have developed a measurement methodology for measuring temperature profiles during processing using fluorescence spectroscopy because the fluorescence measurements reflect the temperature and the neighbourhood of the fluorescent molecule. In this paper, our purpose is to correlate the fluorescent signal to the melting state and the temperature of the polymer in a qualitative way.

Cho and White [16] have noticed that melting occurred more slowly when a small quantity of a second polymer was mixed to the pellets.

So, two parameters will be chosen to modify the melting state: the temperature and the incorporation of another polymer.

2.4.1 Material properties

The polymer studied in the melting zone was Polypropylene (PP Atofina Appryl MN1).

The technique consisted of mixing Polyethylene (HDPE BASF Lupolen 5031 L) with Polypropylene at low concentration and monitoring the dependence of the signal in the melting zone on the solid and melt phases of the two polymers.

The tracer was prepared in the same proportions of the polymer's mixtures. Indeed, it was composed of 10% of a masterbatch of HDPE + anthracene (1% wt) and 90 % of a masterbatch of PP + anthracene (1% wt) when a mixing of 10% HDPE and 90% PP was extruded.

The melting behaviour of the two polymers was studied by differential scanning calorimetry (DSC Perkin Elmer Pyris 1), as shown on figure 7.

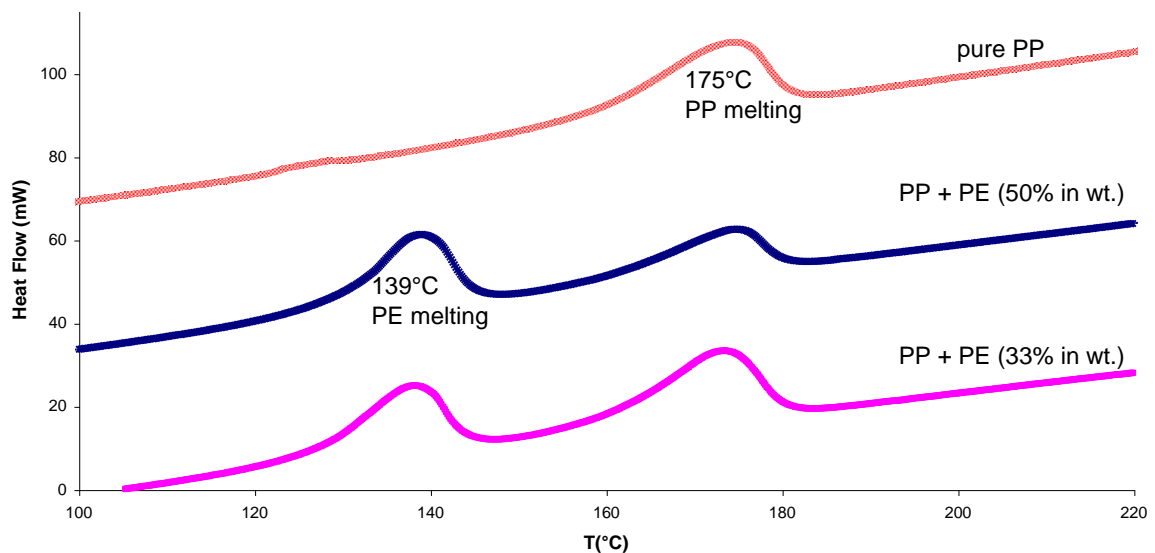

Figure 7. Thermograms of DSC
Melting of pure PP and PP/PE systems
Rate of heating = 10°C/min

Figure 7 shows that for a blend of PP/PE, the melting temperatures of each polymer are not modified by the presence of the second polymer.

2.4.2 Operating conditions

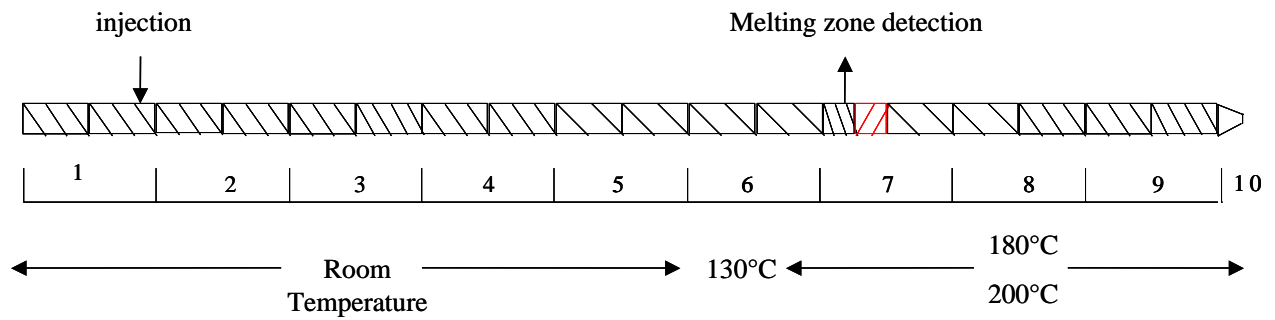

Figure 8. Screw profile D

For this study, the screw profile shown in figure 8 is chosen to slow down the polymer melting and to detect a multiphase system at the beginning of zone 7. A reverse element is placed to fill this melting zone in order to enable to detect a fluorescent signal.

The operating conditions were as following:

$Q = 18 \text{ g/min}$ and $N = 50 \text{ rpm}$;

$Q = 76 \text{ g/min}$ and $N = 100 \text{ rpm}$.

The polyethylene proportions in the pellets introduced were:

0, 10, 20 and 30% in weight.

Two temperatures were performed in zone 7:

180°C and 200°C.

3. RESULTS AND DISCUSSION

3.1 Validation of the technique of detection

The screw profile used is presented in figure 3 (Screw profile A).

3.1.1 Local and global RTD

The reproducibility of the measurements has been checked before.

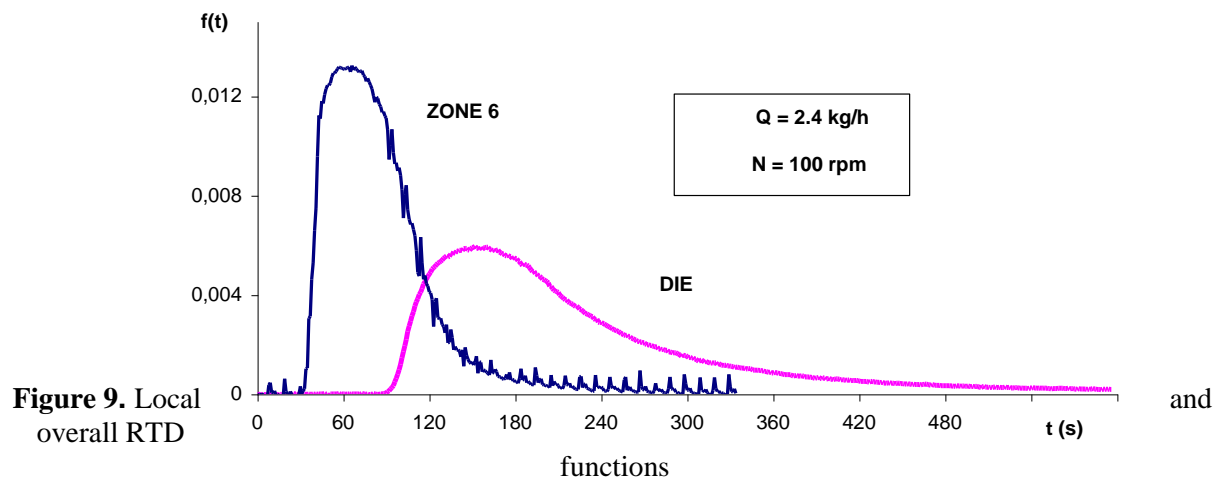

As expected, figure 9 shows that the distribution is wider and the mean residence time is longer for the overall RTD.

3.1.2 Linearity verification

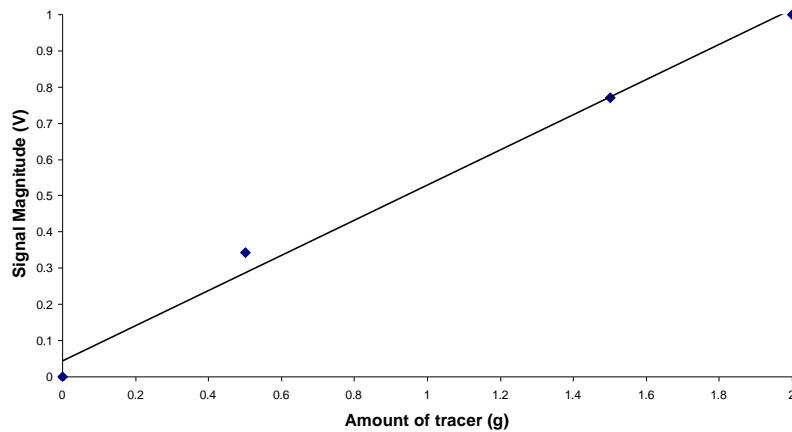

Figure 10. Influence of the quantity of tracer injected
Tracer: HDPE + 9-(methylamino-methyl)-anthracene (1% wt)

Figure 10 shows clearly that the magnitude of the signal is proportional to the tracer concentration.

3.2 Influence of the operating conditions

As expected, an increase of the screw rotation speed gives rise to a decrease of the mean residence and the dispersion time. A flow rate increase makes the mean residence time and the dispersion decrease.

Specific throughput

In reactive extrusion, the quality of a product is related to mixing quality.

The specific throughput is a process parameter, useful for characterizing the distributive mixing. It is defined by the ratio of the volumetric flow rate to the screw rotation speed, Q/N [17].

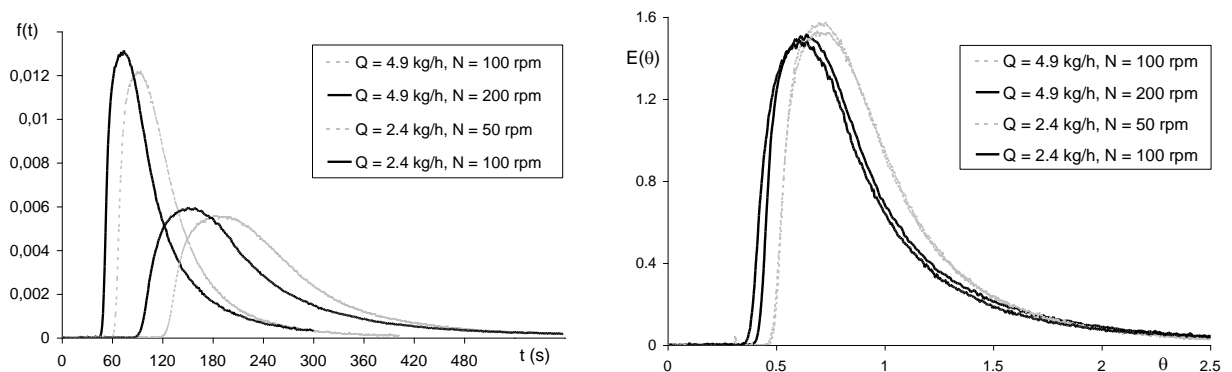

Figure 11. Influence of specific throughput at the die

If Q/N is maintained constant, the same dispersion can be obtained, ensuring the same quality of mixing.

3.3 Verification of the convolution theory

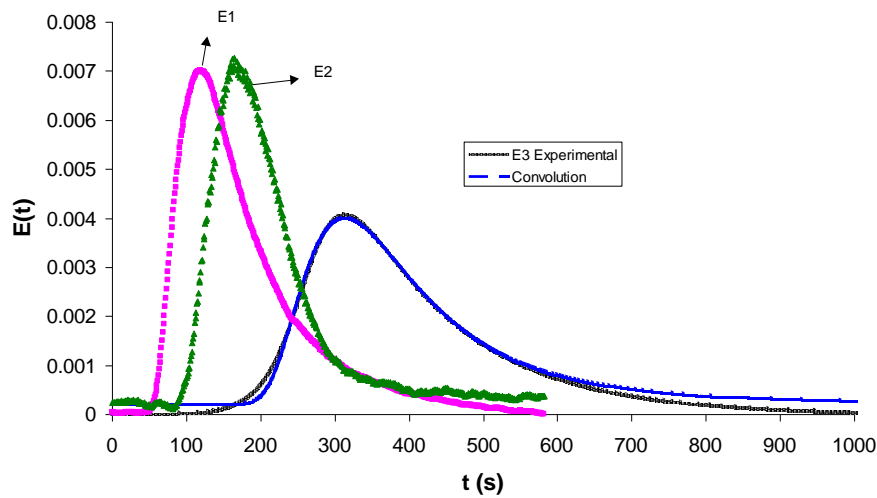

Figure 12. Convolution validation
Q= 2.5 kg/h N= 200 rpm
HDPE + tracer (1% wt)

The curves (figure 12) reflect some experiments done as depicted on figure 6 and in table 1. They clearly validate the convolution theory between two independent elements. It can be an interesting mathematical tool to determine local RTD and will be used to model a conveying zone in paragraph 3.4.

3.4 Analysis of the predictive model

The model presented in paragraphs 1.3 and 2.3 was validated for different operating conditions. In each case, the pressure in zone 6 (see figure 6) was measured to ensure the full fill of the channel. Figure 13 shows the results obtained under the following conditions: Q= 75 g/min and N= 59 rpm.

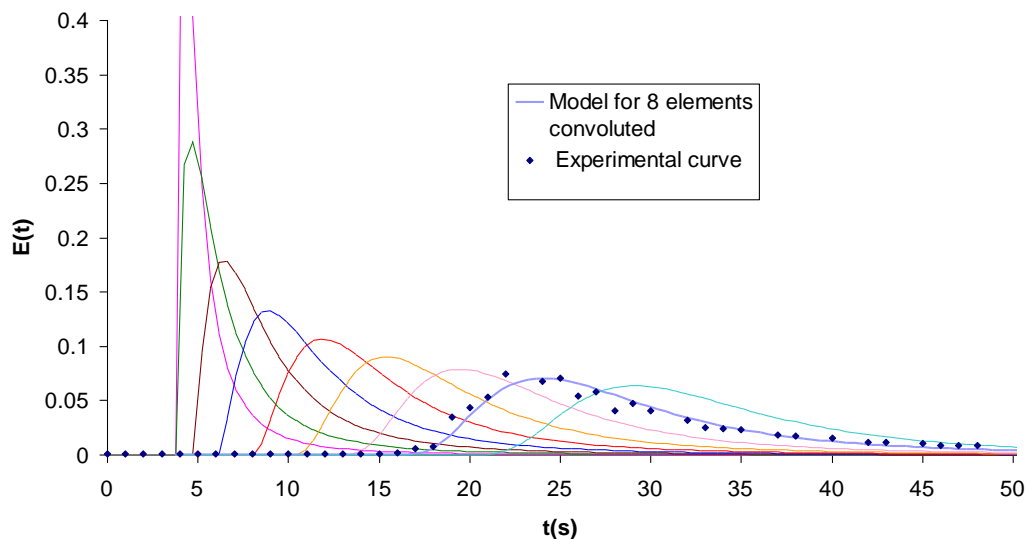

Figure 13. Model of a conveying zone
Q= 75 g/min N= 59 rpm
Pressure in the zone 6 = 5 bar

These results clearly show that the model is in good agreement with the experimental RTD of a conveying zone. One important condition to use of this model is the fill of the screw elements. The degree of fill is improved thanks to the use a polymer of low viscosity. The results show that the mixing in the apex area between the two screws is enough intensive to consider that each half turn is statistically independent from its neighbours.

3.5 Fluorescent signal and melting state

The melting state of polypropylene was modified by the temperature of the barrel and the presence of polyethylene in the pellets introduced at the hopper of the extruder.

3.5.1 Measurements in the melting zone

First, a thermocouple measured the temperature of the blend inside the channel in the melting zone for different mixtures of PP/PE.

	0% HDPE	10% HDPE	20% HDPE	30% HDPE
T(°C)	162	160	158	156

Table 3. Temperature in the melting zone (zone 7)
 Q= 18 g/min N= 50 t/min ,
 T barrel = 180 °C

Table 3 summarises the influence of the polyethylene. As expected, with this polymer, the material temperature decreases and the melting rate of polypropylene slows down. Nevertheless, as shown in figure 7, the melting temperature of polypropylene does not change.

The fluorescence signal is then monitored for different polymer blends. The configuration of the system of detection is fixed. The amount of tracer injected is 0.3 g for all the experiments.

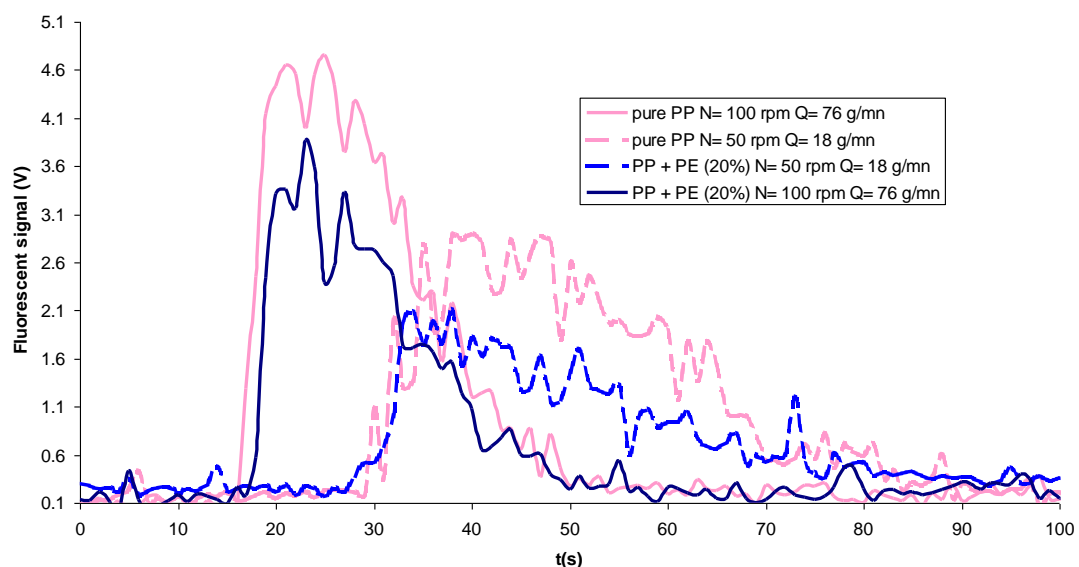

Figure 14. Fluorescence signal for different operating conditions in the melting zone

The magnitude of the fluorescent signal (figure 14) is affected by the presence of polyethylene. As it modifies both the material temperature and the melting state of polypropylene, the fluorescent signal is linked to the melting rate.

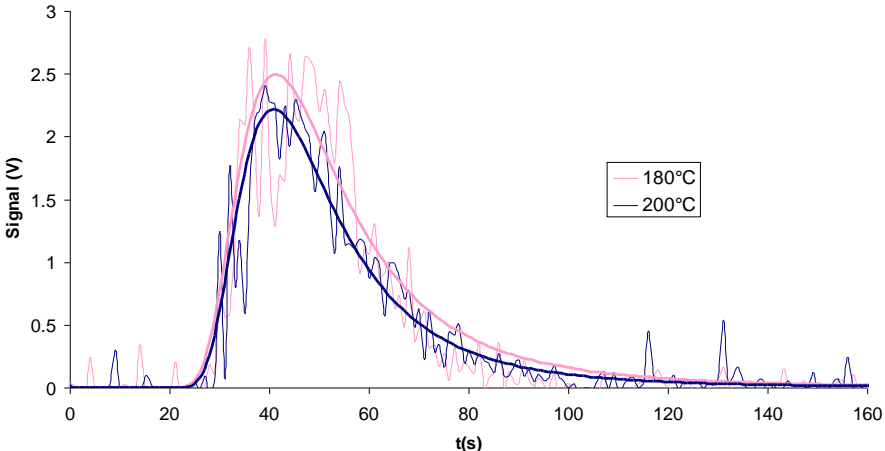

Figure 15. Influence of the barrel temperature on the fluorescent signal in the melting zone
 $Q= 18 \text{ g/min}$ $N= 50 \text{ rpm}$

Another way to influence the material state and the fluorescent signal is to modify the barrel temperature. It seems that a decrease in temperature leads to an increase in the signal on figure 15.

3.5.2 Influence of the temperature on the fluorescent signal

Some measurements were done at the die position to study the influence of the temperature on the signal. The tracer was injected at the hopper. The polymer feeding and screw rotation speed were stopped for a maximum fluorescent signal recorded. Then the fluorescent signal and the material temperature were monitored during the barrel heating and cooling (see figure 16).

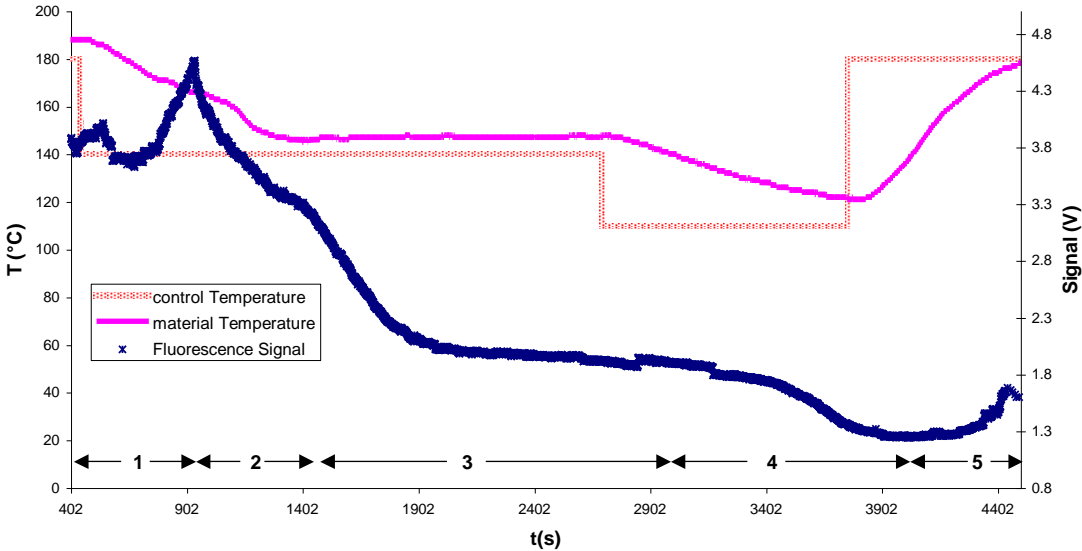

Figure 16. Fluorescent signal during a barrel cooling and heating
 Material: Polypropylene

The fluorescent signal depends strongly on the temperature profile as shown on figure 16.

Its evolution is divided into 5 main parts (see numbers on figure 16):

- Part 1 corresponds to a cooling phase. The material temperature is between 185 and 175°C. Polypropylene is melt in this range of temperature. The increase in the fluorescent signal is due to the PP melt phase cooling.

- Part 2 represents the beginning of the PP crystallization. The material temperature is between 175 and 140°C. It corresponds to a decrease of the fluorescent signal due to the low fluorescent activity of the solid state.

- Part 3: The barrel temperature is maintained at 140°C during 20 minutes to achieve PP crystallization. The fluorescent signal is always decreasing.

- Part 4 shows another cooling period. The temperature material is between 140 and 125°C. It is the end of PP crystallization.

- Part 5 corresponds to a heating phase. A fast increase in the fluorescent signal at 175°C reflects PP melting. Finally, a weak decrease of the signal is noticed due to the melt PP heating.

Figure 17 represents the fluorescent signal versus the polymer temperature.

Figure 17. Fluorescent signal influenced by temperature and phase transitions
Material: Polypropylene

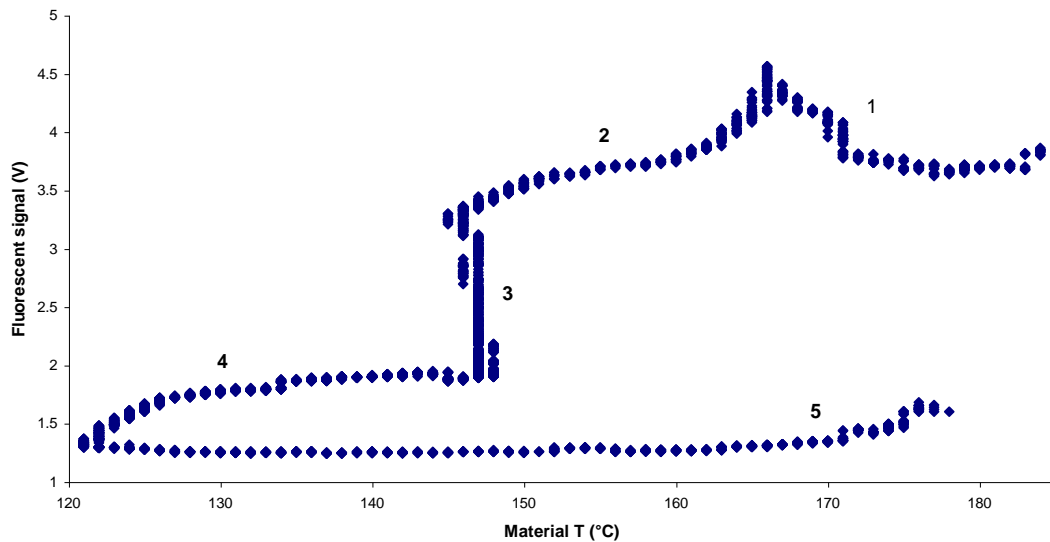

This curve confirms clearly the five parts of the evolution of the fluorescent signal on figure 16. It is due to the material temperature changes and the phase transitions (see numbers on figures 16 and 17). PP melting is characterized by a signal transition at 175°C on figure 17.

These results enable some remarks:

- A melt phase cooling or heating involves respectively an increase or a decrease in the signal,
- The crystallization process involves a decrease in the fluorescent signal,
- The fluorescent signal is deeply influenced by the melting state,

In fact, by monitoring the fluorescent signal, the melting rate and the cooling or heating of a polymer inside an extruder could be controlled.

4. CONCLUSIONS AND PERSPECTIVES

In this study, a fluorescence monitoring device was developed to measure in real time the local residence time distribution (RTD) in extruders. This knowledge can constitute a diagnostic tool for Reactive Extrusion.

Some applications of the local RDTs determination are proposed.

This experimental set-up was used to validate the theory of convolution giving a mathematical access to local areas of an extruder.

A predictive model is developed and validated for conveying zones of a co-rotating twin screw extruder.

Finally, the fluorescent signal is presented as a function of the melting state and the material temperature. It could be a way to monitor and/or control the melting rate, the heating or cooling of the polymer inside the channel. As material properties of semi-crystalline polymers depend on the cooling or heating rate and chemical reactions are directly linked to the melting rate, the fluorescent signal could be a useful processing tool.

REFERENCES

1. G.-H. Hu, I. Kadri and C. Picot, *On-line measurement of the residence time distribution in screw extruders*, Polym. Eng. and Sci., **39**, 2, pp. 299-311 (1999)
2. L. Chen, Z. Pan and G.-H. Hu, *Residence Time Distribution in Screw Extruders*, AICHE J., **39**, 9, 1455-1464 (1993)
3. L. Chen and G.-H. Hu, *Applications of a statistical theory in Residence Time Distributions*, AICHE J., **39**, 9, 1558-1562 (1993)
4. L. Chen, G.-H. Hu, and J.T. Lindt, *Residence Time Distribution in Non-intermeshing Counter-rotating twin screw Extruders*, Polym. Eng. and Sci., **35**, 7, pp. 598-603 (1995)
5. H. Cartier and G.-H. Hu, *Plastification or melting: a critical process for free radical grafting in screw extruders*, Polym. Eng. and Sci., **38**, 1, pp. 177-185 (1998)
6. O.S. Carneiro, J.A. Covas and B. Vergnes, *Experimental and theoretical study of twin-screw extrusion of polypropylene*, J. of Appl. Polym. Sci., **78**, 7, pp. 1419-1430 (2000)
7. H. Potente and U. Melisch, *Theoretical and Experimental investigations of the melting of pellets in co-rotating twin screw extruders*, Intern. Polymer Processing, **2**, pp. 101-108 (1996)
8. S. Bawiskar and J.L. White, *Melting model for modular self wiping co-rotating twin screw extruders*, **38**, 5, pp. 727-740 (1998)
9. K.B. Migler and A.J. Bur, *Fluorescence based measurement of temperature profiles during polymer processing*, Polym. Eng. and Sci., **38**, 1, pp. 213-221 (1998)
10. P.V. Danckwerts, *Continuous Flow Systems: Distribution of Residence Times*, Chem. Eng. Sci., **2**, 1 (1953)
11. O. Levenspiel, *Chemical Reaction Engineering*, 2 ed., Wiley, New York (1972)
12. E.B. Nauman and B.A. Buffham, *Mixing in continuous flow system*, Wiley, New York, p. 19 (1983)
13. G. Pinto and Z. Tadmor, *Mixing and Residence Time Distribution in melt screw extruders*, Polym. Eng. and Sci., **10**, 5, pp. 270-279 (1970)
14. D. Wolf and D.H. White, *Experimental study of the Residence Time Distribution in plasticating screw extruders*, AICHE J., **22**, 1, pp. 122-131 (1976)
15. G.-H. Hu, I. Kadri, *Preparation of macromolecular tracers and their use for studying the residence time distribution of polymeric systems*, Polym. Eng. and Sci., **39**, 5, 930-939 (1999)
16. J.W. Cho and J.L. White, *Melting and Blending in a modular co-rotating / counter-rotating twin screw extruder*, Intern. Polymer Processing, pp. 21-28 (1996)
17. G.E. Gasner, D. Bigio, C. Marks, F. Magnus and C. Kiehl, *A new approach to analysing residence time and mixing in a co-rotating twin screw extruder*, Polym. Eng. and Sci., **39**, 2, pp. 286-298 (1999)