



**HAL**  
open science

# Robust Control of VSC-HVDC System with Input and States Constraints

Elkhatib Kamal, B. Marinescu

► **To cite this version:**

Elkhatib Kamal, B. Marinescu. Robust Control of VSC-HVDC System with Input and States Constraints. 14th International Workshop on Advanced Control and Diagnosis, University of Bucharest from 16-17 November 2017, Nov 2017, Bucharest, Romania. pp.6. hal-02512819

**HAL Id: hal-02512819**

**<https://hal.science/hal-02512819>**

Submitted on 19 Mar 2020

**HAL** is a multi-disciplinary open access archive for the deposit and dissemination of scientific research documents, whether they are published or not. The documents may come from teaching and research institutions in France or abroad, or from public or private research centers.

L'archive ouverte pluridisciplinaire **HAL**, est destinée au dépôt et à la diffusion de documents scientifiques de niveau recherche, publiés ou non, émanant des établissements d'enseignement et de recherche français ou étrangers, des laboratoires publics ou privés.

# Robust Control of VSC-HVDC System with Input and States Constraints

E. Kamal and B. Marinescu

ECN (Ecole Centrale Nantes)- LS2N (Laboratoire des sciences du numérique de Nantes).

DSG (team Dynamics of Smart Grids), 1, rue de la Noë, 44000 Nantes Cedex 3, France.

Email: Elkhatabibrahim@ec-nantes.fr and Bogdan.Marinescu@ec-nantes.fr.

**Abstract**—This paper proposes a robust control strategy for a High Voltage Direct Current (HVDC), in order to improve the dynamic behavior performance under a wide range of operating conditions, parameters uncertainties, input and state constraints. It proposes first to model the HVDC and investigates the robust control based on Model Recovery Anti-windup (MRAW) to improve regional performance and stability of HVDC systems with saturating actuators. More precisely, in this paper sufficient conditions based on Linear Matrix Inequalities (LMIs) are derived for robust stabilization, in the sense of Lyapunov method. First, a robust controller is designed to show a desirable nominal performance by ignoring states and control inputs constraints. Next, an additional compensator is designed to mitigate the adverse effects due to state and the control constraints. The proposed strategy validations are performed using a MATLAB/Simulink software.

## I. INTRODUCTION

In the transmitting power over long distances, High Voltage Direct Current (HVDC) transmission systems are used because there are several advantages for the Voltage Source Converter (VSC) based HVDC transmission (VSC-HVDC) compared to the conventional, thyristor based HVDC. One of the advantages of VSC-HVDC is that it can supply inductive or capacitive reactive power to the connected AC system in addition to supplying real power interchange with the DC link. Moreover, VSC- HVDC has high speed and high voltage switches [1]-[4]. Its known that, VSC- HVDC dynamics are effect by changing its operating conditions, so the controller design problem to provide required performance over an expected range of operating conditions is arises. In addition, controller design for state and actuator constrained VSC-HVDC systems is a challenging problem. It becomes more complex if the multivariable HVDC system is subject to parameter uncertainties, which is quite common in many physical systems. The parameter uncertainties may come with the change of environment (temperature change, pressure change, load change, etc.), changes of AC grid parameters due to disturbances like short-circuits [5], [6], ageing of components, measurement error, etc.. Parameter uncertainties make the values of the parameters deviate from the nominal values and may degrade the system performance or even cause instability of the system.

Several authors have presented mathematical models and control strategies for VSC-HVDC transmission that include small signal stability [7], decoupling control in converter stations

using feedback linearization [8], LMI based robust control [9]-[16], and adaptive control [17]-[19]. Most of these papers have not considered the parameter uncertainties and/or the hard constraints.

The main contributions of this paper are twofold: The primary objective is to investigate and propose a reliable model of VSC-HVDC systems. The second main contribution corresponds to the proposition of a robust control based on Model Recovery Anti-windup (MRAW), in order to improve the dynamic behavior performance under wide range of operating conditions, parameters uncertainties, input and state constraints and minimize the tracking reference error. The sufficient conditions are formulated in the format of LMIs. The effectiveness of the robust controllers is demonstrated using the simulation studies with the aid of the MATLAB software package. The rest of the paper is organized as follows. In section II, a state space of the HVDC dynamics is presented. In section III, the control problem representation is formulated. The proposed controller structure is developed in section IV. Simulation results are presented that illustrates the effectiveness of the proposed strategies in section V. Finally, the conclusions and future prospects are presented in section VI.

## II. VSC-HVDC POWER STRUCTURE AND ITS DYNAMICS NONLINEAR MODEL

VSC-HVDC transmission power structure is depicted in Figure 1. For system modelling, a monopolar HVDC system with metallic return is considered. It has two conversion stations that employ bidirection three-phased (voltage-source) AC-DC power converters. They are interlinked by means of a DC cable and their connection with AC grid is realised by using a step-up transformer. The AC grid is represented by infinite buses and equivalent AC lines. As in real application, converters are operating in switched mode. Therefore, filtering elements are found on each station: capacitors on DC side and line reactors (inductors) on AC side. A supplementary low-pass filter is inserted between line reactor and transformer in order to alleviate the high frequency switching components. Both VSC of HVDC link are operated in pulse-width modulation (PWM) in order to interchange averaged sinusoidal variables with AC grid. VSC control is focused precisely to shaping this averaged behaviour. The state space can be given as the following,

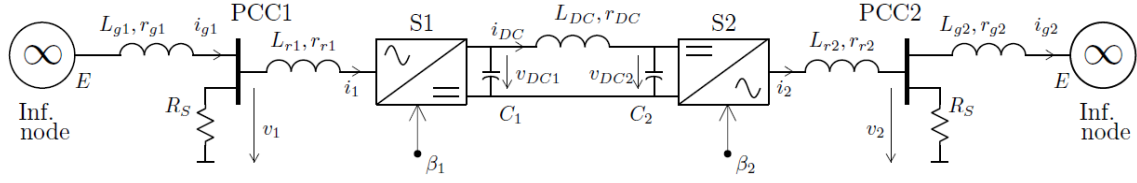

Fig. 1. HVDC power structure simplified.

$$\dot{x}(t) = Ax(t) + Bu(t) \quad (1)$$

Where

$$A = \begin{bmatrix} a_{11} & w & a_{13} & 0 & 0 & 0 & 0 & 0 & 0 & 0 & 0 & 0 & 0 & 0 & 0 & 0 & 0 & 0 & 0 & 0 & 0 \\ -w & a_{22} & 0 & a_{24} & 0 & 0 & 0 & 0 & 0 & 0 & 0 & 0 & 0 & 0 & 0 & 0 & 0 & 0 & 0 & 0 & 0 \\ a_{31} & 0 & a_{33} & w & a_{35} & 0 & 0 & 0 & 0 & 0 & 0 & 0 & 0 & 0 & 0 & 0 & 0 & 0 & 0 & 0 & 0 \\ 0 & \frac{R_s}{L_{r1}} & -w & a_{44} & a_{45} & 0 & 0 & 0 & 0 & 0 & 0 & 0 & 0 & 0 & 0 & 0 & 0 & 0 & 0 & 0 & 0 \\ 0 & 0 & a_{53} & a_{54} & 0 & -\frac{2}{C_1} & 0 & 0 & 0 & 0 & 0 & 0 & 0 & 0 & 0 & 0 & 0 & 0 & 0 & 0 & 0 \\ 0 & 0 & 0 & 0 & \frac{1}{2L_{DC}} & a_{66} & a_{67} & 0 & 0 & 0 & 0 & 0 & 0 & 0 & 0 & 0 & 0 & 0 & 0 & 0 & 0 \\ 0 & 0 & 0 & 0 & 0 & \frac{1}{C_2} & 0 & 0 & 0 & a_{710} & a_{711} & 0 & 0 & 0 & 0 & 0 & 0 & 0 & 0 & 0 & 0 \\ 0 & 0 & 0 & 0 & 0 & 0 & 0 & a_{88} & w & \frac{R_s}{L_{g2}} & 0 & 0 & 0 & 0 & 0 & 0 & 0 & 0 & 0 & 0 & 0 \\ 0 & 0 & 0 & 0 & 0 & 0 & 0 & -w & a_{99} & 0 & \frac{R_s}{L_{g2}} & 0 & 0 & 0 & 0 & 0 & 0 & 0 & 0 & 0 & 0 \\ 0 & 0 & 0 & 0 & 0 & 0 & a_{107} & a_{108} & 0 & a_{10} & w & 0 & 0 & 0 & 0 & 0 & 0 & 0 & 0 & 0 & 0 \\ 0 & 0 & 0 & 0 & 0 & 0 & a_{117} & 0 & \frac{R_s}{L_{r2}} & -w & a_{111} & 0 & 0 & 0 & 0 & 0 & 0 & 0 & 0 & 0 & 0 \\ \hline 0 & 0 \\ 0 & 0 \\ x_5^o \frac{-1}{2L_{r1}} & 0 \\ 0 & x_5^o \frac{-1}{2L_{r1}} & 0 & 0 & 0 & 0 & 0 & 0 & 0 & 0 & 0 & 0 & 0 & 0 & 0 & 0 & 0 & 0 & 0 & 0 & 0 \\ x_3^o \frac{3}{2C_1} & x_4^o \frac{3}{2C_1} & 0 & 0 & 0 & 0 & 0 & 0 & 0 & 0 & 0 & 0 & 0 & 0 & 0 & 0 & 0 & 0 & 0 & 0 & 0 \\ 0 & 0 \\ 0 & 0 & 0 & x_{10}^o \frac{3}{2C_2} & x_{11}^o \frac{3}{2C_2} & 0 & 0 & 0 & 0 & 0 & 0 & 0 & 0 & 0 & 0 & 0 & 0 & 0 & 0 & 0 & 0 \\ 0 & 0 \\ 0 & 0 \\ 0 & 0 \\ 0 & 0 & 0 & x_7^o \frac{-1}{2L_{r2}} & 0 & 0 & 0 & 0 & 0 & 0 & 0 & 0 & 0 & 0 & 0 & 0 & 0 & 0 & 0 & 0 & 0 \\ 0 & 0 & 0 & 0 & x_7^o \frac{-1}{2L_{r2}} & 0 & 0 & 0 & 0 & 0 & 0 & 0 & 0 & 0 & 0 & 0 & 0 & 0 & 0 & 0 & 0 \end{bmatrix},$$

where,  $(^o)$  is denoted to the optimal operating point,  $a_{11} = -\frac{R_s}{L_{g1}} - \frac{r_{g1}}{L_{g1}}$ ,  $a_{13} = \frac{R_s}{L_{g1}}$ ,  $a_{22} = -\frac{R_s}{L_{g1}} - \frac{r_{g1}}{L_{g1}}$ ,  $a_{24} = \frac{R_s}{L_{g1}}$ ,  $a_{31} = \frac{R_s}{L_{r1}}$ ,  $a_{33} = -\frac{R_s}{L_{r1}} - \frac{r_{r1}}{L_{r1}}$ ,  $a_{35} = u_1^o \frac{-1}{2L_{r1}}$ ,  $a_{44} = -\frac{R_s}{L_{r1}} - \frac{r_{r1}}{L_{r1}}$ ,  $a_{45} = u_2^o \frac{3}{2L_{r1}}$ ,  $a_{53} = u_1^o \frac{3}{2C_1}$ ,  $a_{54} = u_2^o \frac{3}{2C_1}$ ,  $a_{66} = -\frac{r_{DC}}{L_{DC}}$ ,  $a_{67} = -\frac{1}{2L_{DC}}$ ,  $a_{710} = u_3^o \frac{3}{2C_2}$ ,  $a_{711} = u_4^o \frac{3}{2C_2}$ ,  $a_{88} = -\frac{R_s}{L_{g2}} - \frac{r_{g2}}{L_{g2}}$ ,  $a_{99} = -\frac{R_s}{L_{g2}} - \frac{r_{g2}}{L_{g2}}$ ,  $a_{107} = u_3^o \frac{-1}{2L_{r2}}$ ,  $a_{108} = \frac{R_s}{L_{r2}}$ ,  $a_{10} = -\frac{R_s}{L_{r2}} - \frac{r_{r2}}{L_{r2}}$ ,  $a_{117} = u_4^o \frac{-1}{2L_{r2}}$ ,  $a_{111} = -\frac{R_s}{L_{r2}} - \frac{r_{r2}}{L_{r2}}$ .

The outputs of the HVDC are defined as the following;

$$\begin{aligned} y_1 &= V_{DC1} = x_5 \\ y_2 &= P_2 = \frac{3}{2}x_{10}^o R_s x_8 + \frac{3}{2}x_{11}^o R_s x_9 + \frac{3}{2}x_8^o R_s x_{10} \\ &\quad - 3x_{10}^o R_s x_{10} + \frac{3}{2}x_9^o R_s x_{11} - 3x_{11}^o R_s x_{11} \\ y_3 &= Q_1 = -\frac{3}{2}x_4^o R_s x_1 + \frac{3}{2}x_3^o R_s x_2 + \frac{3}{2}x_2^o R_s x_3 - \frac{3}{2}x_1^o R_s x_4 \\ y_4 &= Q_2 = -\frac{3}{2}x_{11}^o R_s x_8 + \frac{3}{2}x_{10}^o R_s x_9 + \frac{3}{2}x_9^o R_s x_{10} \\ &\quad - \frac{3}{2}x_8^o R_s x_{11} \end{aligned} \quad (2)$$

where the states variables and the control input is defined as the following,

$$\begin{aligned} x_1 &= i_{g1d} & x_2 &= i_{g1q} & x_3 &= i_{1d}^\infty & x_4 &= i_{1q}^\infty \\ x_5 &= v_{DC1} & x_6 &= i_{DC} & x_7 &= v_{DC2} & x_8 &= i_{g2d} \\ x_9 &= i_{g2q} & x_{10} &= i_{2d}^\infty & x_{11} &= i_{2q}^\infty \\ u_1 &= \beta_{1d} & u_2 &= \beta_{1q} & u_3 &= \beta_{2d} & u_4 &= \beta_{2q} \end{aligned}$$

where  $i_{DC}$  is the DC line current,  $v_{DC1}$  is the DC voltage for VSC on left side,  $i_{g1d}$  and  $i_{g1q}$  are the grid current on  $d$  and  $q$  axis for AC filter on the left side, respectively,  $i_{g2d}$ ,  $i_{g2q}$  are the grid current on  $d$  and  $q$  axis for AC filter on the right side,  $\beta_{1d}$ ,  $\beta_{1q}$ ,  $v_{DC1}$  are variables for VSC on left side,  $\beta_{2d}$ ,  $\beta_{2q}$ ,  $v_{DC2}$  are variables for VSC on right side ( $\beta_{ij}$ ,  $i \in \{1, 2\}$ ,  $j \in \{1, 2\}$  are the duty ratios of the converter, i.e., the controls of the VSC system),  $i_{2d}^\infty$ ,  $i_{2q}^\infty$  are AC grid currents on the right side,  $i_{1d}^\infty$ ,  $i_{1q}^\infty$  are AC grid currents on the left side,  $L_{g1}$ ,  $L_{g2}$ ,  $r_{g1}$ ,  $r_{g2}$ ,  $L_{r1}$ ,  $L_{r2}$ ,  $r_{r1}$ ,  $r_{r2}$ ,  $R_s$ ,  $C_1$ ,  $C_2$ ,  $r_{DC}$ ,  $L_{DC}$ ,  $E$  and  $w$  are constants,  $P_2$ ,  $Q_1$ ,  $Q_2$  are active power and reactive power, respectively. The system parameters are given values of these constants are provided as:

Variable Names	Constants	Values
AC grid inductance	$L_{g1} = L_{g2}$	$0.11\Omega$
AC grid resistance	$r_{g1} = r_{g2}$	$0.01\Omega$
Filter inductance	$L_{r1} = L_{r2}$	$0.025\Omega$
Filter resistance	$r_{r1} = r_{r2}$	$0.08\Omega$
AC filter resistance	$R_s$	$2\Omega$
DC capacitor filter	$C_1 = C_2$	$220 * 10^{-6}F$
DC line resistance	$r_{DC}$	$1.39\Omega$
DC line inductance	$L_{DC}$	$1.59 * 10^{-2}H$
Grid voltage	$E$	$187 * 10^3V$
Grid frequency	$w$	$314rad/sec$

### III. PROBLEM FORMULATION

The objective is to design robust controller based on LMI for HVDC transmission systems taking into consideration parameter uncertainties, constraints on states and control inputs. With this constraints the aim of this controller is to regulate output variable according to the following:

- 1) Consider the following linear system with parameter uncertainties, constrained states and controls, therefore (1) rewritten as the following,

$$\begin{aligned} \dot{x}(t) &= (A + \Delta A)x(t) + (B + \Delta B)u(t) \\ y(t) &= Cx(t) \end{aligned} \quad (3)$$

where  $x(t) \in \mathbb{R}^{n \times 1}$  and  $u(t) \in \mathbb{R}^{m \times 1}$  are the state vectors and the HVDC control input, respectively,  $C \in \mathbb{R}^{g \times n}$  is the system output matrix,  $\Delta A \in \mathbb{R}^{n \times n}$  and  $\Delta B \in \mathbb{R}^{n \times m}$  are the uncertainties of the constant system matrices  $A \in \mathbb{R}^{n \times n}$  and  $B \in \mathbb{R}^{n \times m}$ , respectively,

in our application  $n = 11$ ,  $m = 4$ ,  $g = 4$  and function  $sat$  represents the nominal saturation as defined after in (11).

- 2) In this study, the parameter uncertainties are assumed given by,

$$\Delta A = EF_1(t)H_1 \quad \Delta B = EF_2(t)H_2 \quad (4)$$

where  $E$ ,  $H_1$  and  $H_2$  are known real constant matrices which characterize the parameter uncertainties for the nominal matrices  $A$  and  $B$ ,  $F_1(t)$  and  $F_2(t)$  are unknown real matrices with Lebesgue measurable elements, satisfying

$$F_i(t)^T F_i(t) \leq I \quad i = 1, 2 \quad (5)$$

where  $I$  is identity matrix.

- 3) Let the state be constrained as follows

$$\gamma = \{x \in \mathbb{R}^{n \times 1} / -q \leq x \leq q; \quad q \in \mathbb{R}^{n \times 1}\} \quad (6)$$

From (6), we can see that  $-q \leq x \leq q$  is equivalent to  $x \leq q$  and  $-x \leq q$  which in augmented form can be expressed as  $[I; -I]x \leq [q; q]$ , where  $I$  stands for the identity matrix. If we define  $M = [I; -I]$  and  $N = [q; q]$ , then (6) can be written as the following

$$\gamma(M, N) = \{x \in \mathbb{R}^{n \times 1} / Mx \leq N\} \quad (7)$$

Therefore  $M \in \mathbb{R}^{h \times n}$  and  $N \in \mathbb{R}^{h \times 1}$  are known. In this paper, we consider the current and voltage variables ( $x_3$ ,  $x_4$ ,  $x_3$ ,  $x_4$ ,  $x_{10}$ ,  $x_{11}$ ) are constrained as the following;

$$\begin{aligned} -2000Amp &\leq x_3 \leq 2000Amp \\ -2000Amp &\leq x_4 \leq 2000Amp \\ 10KV &\leq x_5 \leq 380KV \\ 10KV &\leq x_7 \leq 380KV \\ -2000Amp &\leq x_{10} \leq 2000Amp \\ -2000Amp &\leq x_{11} \leq 2000Amp \end{aligned} \quad (8)$$

- 4) also, let the control input be constrained as follows

$$\Lambda = \{u \in \mathbb{R}^{m \times 1} / -z \leq u \leq z; \quad z \in \mathbb{R}^{m \times 1}\} \quad (9)$$

In our application, the constraints on control inputs  $u_1$ ,  $u_2$ ,  $u_3$  and  $u_4$  are considered between  $-z = -1$  &  $z = 1$  as the following

$$\begin{aligned} -1 &\leq u_1 \leq 1 & -1 &\leq u_2 \leq 1 \\ -1 &\leq u_3 \leq 1 & -1 &\leq u_4 \leq 1 \end{aligned} \quad (10)$$

and the actuator saturation, which is defined by

$$sat(u) = \begin{cases} u_{min} & \text{if } u(t) \leq u_{min} \\ u(t) & \text{if } u_{max} \leq u(t) \leq u_{min} \\ u_{max} & \text{if } u(t) \geq u_{max} \end{cases} \quad (11)$$

where  $u_{min} = -1$  and  $u_{max} = 1$  are minimum and maximum control inputs, respectively.

- 5) Controlling the DC voltage for VSC on left side ( $y_1=V_{DC1}$ ), active ( $y_2=P_2$ ) and reactive powers ( $y_3=Q_1$ ,  $y_4=Q_2$ ) to their set points (so that the controlled output  $y_i$  ( $i = 1, 2, 3, 4$ ) tracks its reference value  $y_{i,ref}$

( $i = 1, 2, 3, 4$ ). Accordingly, the tracking error  $\epsilon_i$  ( $i = 1, 2, 3, 4$ ) approaches zero when the time tends to infinity. In order to force to zero the steady-state tracking error, we add new state which corresponds to the integral of the tracking error  $\epsilon_i$  ( $i = 1, 2, 3, 4$ ). Therefore we define  $\xi_i = \int \epsilon_i dt$  ( $i = 1, 2, 3, 4$ ) with  $\epsilon_i = y_i - y_{i,ref}$  therefore,

$$\begin{aligned} x_{12} &= \xi_1 = \int \epsilon_1 dt = \int (y_1 - y_{1,ref}) dt \\ &= \int (V_{DC1} - V_{DC1,ref}) dt \\ x_{13} &= \xi_2 = \int \epsilon_2 dt = \int (y_2 - y_{2,ref}) dt \\ &= \int (P_2 - P_{2,ref}) dt \\ x_{14} &= \xi_3 = \int \epsilon_3 dt = \int (y_3 - y_{3,ref}) dt \\ &= \int (Q_1 - Q_{1,ref}) dt \\ x_{15} &= \xi_4 = \int \epsilon_4 dt = \int (y_4 - y_{4,ref}) dt \\ &= \int (Q_2 - Q_{2,ref}) dt \end{aligned} \quad (12)$$

The augmented by integrators state space model is deduced from the six equations below:

$$\begin{cases} \dot{x}(t) = Ax(t) + Bu(t) \\ \dot{x}_{12}(t) = y_1 - y_{1,ref} = V_{DC1} - V_{DC1,ref} = x_5 - V_{DC1,ref} \\ \dot{x}_{13}(t) = y_2 - y_{2,ref} = P_2 - P_{2,ref} = \frac{3}{2}x_{10}^*R_sx_8 + \frac{3}{2}x_{11}^*R_sx_9 + \frac{3}{2}x_8^*R_sx_{10} - 3x_{10}^*R_sx_{10} + \frac{3}{2}x_9^*R_sx_{11} - 3x_{11}^*R_sx_{11} - P_{2,ref} \\ \dot{x}_{14}(t) = y_3 - y_{3,ref} = Q_1 - Q_{1,ref} = -\frac{3}{2}x_4^*R_sx_1 + \frac{3}{2}x_3^*R_sx_2 + \frac{3}{2}x_2^*R_sx_3 - \frac{3}{2}x_1^*R_sx_4 - Q_{1,ref} \\ \dot{x}_{15}(t) = y_4 - y_{4,ref} = Q_2 - Q_{2,ref} = -\frac{3}{2}x_{11}^*R_sx_8 + \frac{3}{2}x_{10}^*R_sx_9 + \frac{3}{2}x_9^*R_sx_{10} - \frac{3}{2}x_8^*R_sx_{11} - Q_{2,ref} \end{cases} \quad (13)$$

We consider the set point is given by  $y_{1,ref}=V_{DC1,ref}=320KV$ ,  $y_{2,ref}=P_{2,ref}=100MW$ ,  $y_{3,ref}=Q_{1,ref}=250MVA$ ,  $y_{4,ref}=Q_{2,ref}=250MVA$ .

#### IV. THE PROPOSED ROBUST CONTROLLER WITH STATE AND CONTROL CONSTRAINTS STRATEGY

This section presents a systematic robust control scheme for HVDC to compensate the effect parameter uncertainties and regulate output variable taking in consideration the constraints on states and control inputs. For the robust control scheme implementation based on the MRAW (Model Recovery Anti-windup). Sufficient conditions are derived for robust stabilization in the sense of Lyapunov stability. The sufficient conditions are formulated in the format of LMIs. First, a robust controller is designed to show a desirable nominal performance by considering the state and the control constraints in a LMI formalism and take in consideration the parameter uncertainties. Then, an additional MRAW compensator is designed to mitigate the adverse effects due to state and the control constraints as shown in the following subsections.

##### A. The Proposed Robust Controller with State and Control Constraints Strategy

The closed-loop system with robust controllers is depicted in Figure 2. To design the proposed controller, we consider two

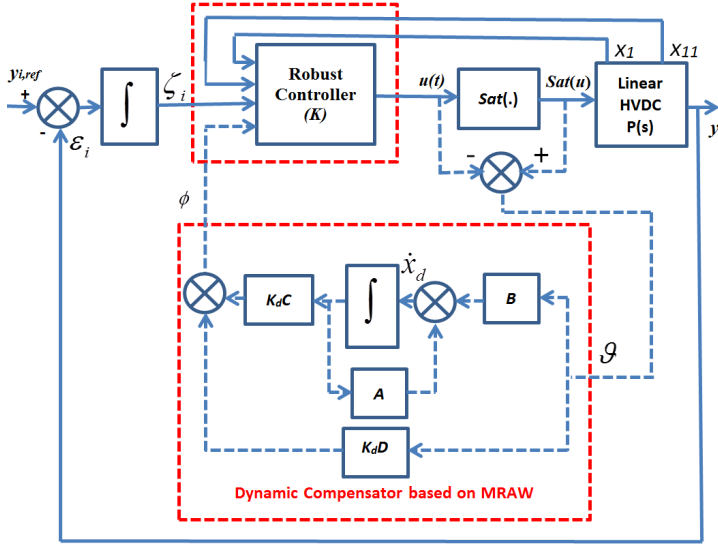

Fig. 2. Overall HVDC system schematic diagram with compensation structure for states and control inputs constrained based on MRAW strategy.

classes of robust controllers that meet the saturation constraints (8) and (10) and compensate the effect parameter uncertainties which is defined in (4), one is given by

$$u(t) = KX(t) = K_s X(t) \quad (14)$$

and the other is given by

$$u(t) = [K_s \quad I] \begin{bmatrix} X(t) \\ \phi(t) \end{bmatrix} = K_a \begin{bmatrix} X(t) \\ \phi(t) \end{bmatrix} \quad (15)$$

where  $X(t)$  is given in (13) and  $\phi(t)$  is based on the dynamics of the MRAW, which is given by,

$$\begin{aligned} \dot{x}_d(t) &= Ax_d(t) + B\varphi \\ \phi(t) &= K_d C x_d(t) + K_d D \varphi \end{aligned} \quad (16)$$

where  $x_d(t)$  is the state vector of the MRAW. The advantage of adding MRAW architecture is to compensate the undesired effects of control saturation. The closed-loop system with these controllers is given in Figure 2, where the dashed part is absent and  $K = K_s$  for (14) while the dashed part is present and  $K = K_a$  for (15).

### B. Proposed Stability and Robustness for HVDC Systems with Parameter Uncertainties and Constraints Strategy

In this section, we derive the closed loop system stability conditions and calculate the robust controller gains and MRAW compensation gains.

#### 1) Dynamics of Closed-Loop System in Absence of MRAW Compensator:

In this section, robust stabilization sufficient condition and corresponding synthesis approach for uncertain HVDC systems with sector saturating actuator and states saturating are design in the absence of MRAW compensator. The stability and robustness analysis with reference to an uncertain control system described by (8) under the constrains on the states and the control inputs is summarized in the following theorem 1.

The proof is shown in the appendix A.

**Theorem 1:** The uncertain HVDC system (3) and (4) subject the constrained states and the control inputs is robustly stabilizable if the controller gains are set to  $K = OZ^{-1}$ , there exist positive definite symmetric matrix  $P = Z^{-1}$  and scalars  $\iota$ ,  $\delta$  and  $\beta_i$ , such that the following LMI is satisfied,

$$\begin{bmatrix} \hat{A}Z + Z\hat{A}^T + (\hat{B}O) + (\hat{B}O)^T + \delta EE^T & ZH_1^T + OH_2^T \\ H_1Z + H_2O & -\delta I \end{bmatrix} \leq 0 \quad (17)$$

$$\begin{bmatrix} \iota\beta_i N_i - M_i Z M_i^T & \beta_i \\ \beta_i & 1 \end{bmatrix} \geq 0 \quad \text{for } 1 \leq i \leq h \quad (18)$$

$$\begin{bmatrix} 1 & O_j \\ O_j^T & Z \end{bmatrix} \geq 0 \quad \text{for } 1 \leq j \leq m \quad (19)$$

where  $h$  and  $m$  are defined in (6) and (7), let  $O_j$ ,  $N_i$  and  $M_i$  are the  $j^{\text{th}}$  and  $i^{\text{th}}$  row of  $O$ ,  $N$  and  $M$ , respectively and  $\iota$  is constant.

**Proof.** The proof can be given as the following. In order to carry out the analysis for robust control strategy, the closed-loop system should be obtained first. Therefore, robust control system of the state with integrators without control saturation can be obtained. Substituting (14) into (13) and (3), we obtain the dynamics of the closed loop system:

$$\begin{aligned} \dot{X}(t) &= (\hat{A} + \Delta\hat{A})X + (\hat{B} + \Delta\hat{B})(KX(t)) \\ Y(t) &= \hat{C}X(t) \end{aligned} \quad (20)$$

Based on the useful lemma [20], we can proof the part of the parameter uncertainties (17). Based on [21], can easily be shown that  $(\max|KX| = \sqrt{K P^{-1} K^T})_{X^T P X \leq 1}$ . Squaring this expression, inserting the definition of  $Z$  and  $O$ , and performing a Schur complement shows that the  $KX \leq 1 \forall : X^T P X \leq 1$  is equivalent to (19).

#### 2) Dynamics of Closed-Loop System in Presence of MRAW Compensator:

To design the compensation gains ( $K_d$ ) in (16), the closed-loop system related the augmented system state should be defined. In this case, we consider the HVDC system (3) without the parameter uncertainties ( $\Delta A = 0$  and  $\Delta B = 0$ ). After a suitable change of coordinates the interconnection between  $\varphi = \text{sat}(u) - u(t)$  and (16), which is named the compact antiwindup closed-loop system as given in Figure 2. The compensation gains ( $K_d$ ) is obtained based on the following theorem 2

**Theorem 2:** If there exists an MRAW controller (16), a symmetric positive definite matrix  $G$  and a positive scalar  $\alpha$  such that the following LMI hold. Then, the antiwindup closed-loop system is asymptotically stable,

$$\begin{bmatrix} G\bar{A}^T + \bar{A}G & \bar{B}W + G\bar{C}^T & 0 & G\bar{C}^T \\ * & \bar{D}W + W\bar{D}^T - 2W & 0 & W\bar{D}^T \\ * & * & -\alpha I & 0 \\ * & * & * & -\alpha I \end{bmatrix} \leq 0 \quad (21)$$

$$G = G^T \geq 0 \quad (22)$$

**Proof.** The closed loop system (20) without the parameter uncertainties ( $\Delta\hat{A} = 0$  and  $\Delta\hat{B} = 0$ ) with MRAW (15) and (16) can be rewetted as the following

$$\begin{aligned} \dot{X}(t) &= \hat{A}X(t) + \hat{B}sat(u) \\ Y(t) &= \hat{C}X(t) + \hat{D}sat(u) \end{aligned} \quad (23)$$

From (23) and (16), we obtain,

$$\begin{aligned} \dot{X}(t) &= [\hat{A} + \hat{B}K_s]X(t) + \hat{B}K_d\hat{C}x_d(t) + [\hat{B}K_d\hat{D} + \hat{B}]\varphi \\ Y(t) &= [\hat{C} + \hat{D}K_s]X(t) + \hat{D}K_d\hat{C}x_d(t) + [\hat{D}K_d\hat{D} + \hat{D}]\varphi \end{aligned} \quad (24)$$

Then from (16) and (24), the augmented closed loop model is written as:

$$\begin{aligned} \dot{X}_a(t) &= \bar{A}X_a(t) + \bar{B}\varphi \\ Y_a(t) &= \bar{C}X_a(t) + \bar{D}\varphi \end{aligned} \quad (25)$$

$$\begin{aligned} \text{Where } X_a(t) &= \begin{bmatrix} X(t) \\ x_d(t) \end{bmatrix}, \bar{A} = \begin{bmatrix} \hat{A} + \hat{B}K_s & \hat{B}K_d\hat{C} \\ 0 & \hat{A} \end{bmatrix}, \\ \bar{B} &= \begin{bmatrix} \hat{B}K_d\hat{D} + \hat{B} \\ \hat{B} \end{bmatrix}, \bar{C} = \begin{bmatrix} \hat{C} + \hat{D}K_s & \hat{D}K_d\hat{C} \end{bmatrix}, \\ \bar{D} &= \begin{bmatrix} \hat{D}K_d\hat{D} & \hat{D} \end{bmatrix}. \end{aligned}$$

By applying the Lyapunov function  $V(X_a(t)) = X_a(t)^T P_a X_a(t)$  on (25) and using the Schur complement method we can obtain (21) and (22).

## V. SIMULATIONS AND RESULTS

In this section, we apply our results to HVDC (1). The control objective of this paper is to design a robust control law for the HVDC system (1) to ensure that all signals in the closed-loop system are bounded and regulate output variable in the presence of the parameter uncertainties, the constraints on states and control inputs.

Figure 3 and Figure 4 show the time response of constrained states (AC grid currents on the left side ( $i_{1q}^\infty$ ), and on the right ( $i_{2d}^\infty$ )) and control actions, respectively, in the presence of parametric uncertainties, states and control input constrains. The parametric uncertainties within 20% is considered, this means that  $E$ ,  $H_1$  and  $H_2$  matrices are selected about 20% from the nominal value from system matrix  $A$  and input matrix  $B$ . In addition the additive disturbance to the ouput matrix is  $Dis = [0.01 \ 0.01 \ 0.01 \ 0.01]^T$  (from the nominal value of the ouput), therefore  $Y = CX + DisCX \sin(3t)$ , where  $DisCX \sin(3t)$  is additive disturbance term. If this percentage is increased, the system lost its performorane. Figure 5 and Figure 6 show the system ouputs (DC voltage, active and

reactive power) and tracking error, respectively, from initial condition  $x_o = [1046.7 \ -5331.6 \ 1977 \ 749.3 \ 319891 \ -61 \ 320063 \ 878 \ -5278 \ 498 \ -2000]^T$ , together with control evolution. It can be seen that robust feedback is achieved with give a good tracking. Figure 7 shows the time response of control actions with and without limitation on the DC voltage. It can be seen that from Figure 7 without the constraints on  $V_{DC1}$  and without MRAW, that there are more oscillation on the control action compared to the limitation case and with MRAW. In summary results, we can be seen that the system trajectory follows the trajectory of the reference input. Thus, the proposed controller is robust against norm-bounded parametric uncertainties with respected constraints.

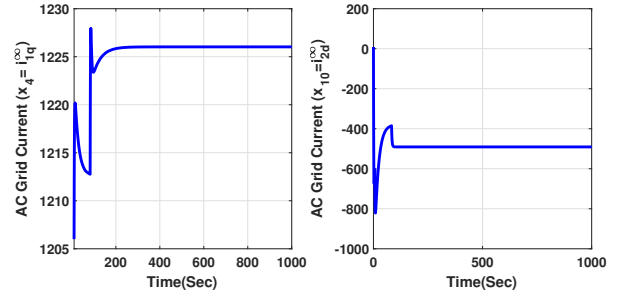

Fig. 3. Time response of the constrained states (AC grid currents on the left and the right side ( $x_4 = i_{1q}^\infty$ ,  $x_{10} = i_{2d}^\infty$ )).

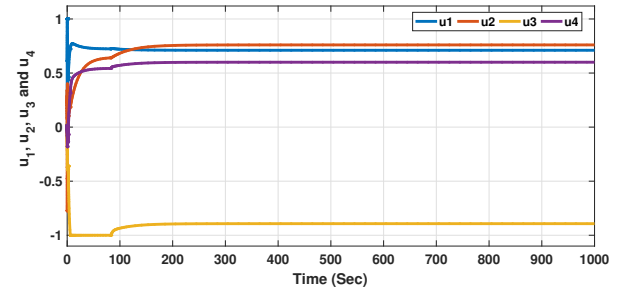

Fig. 4. Time response of the control action.

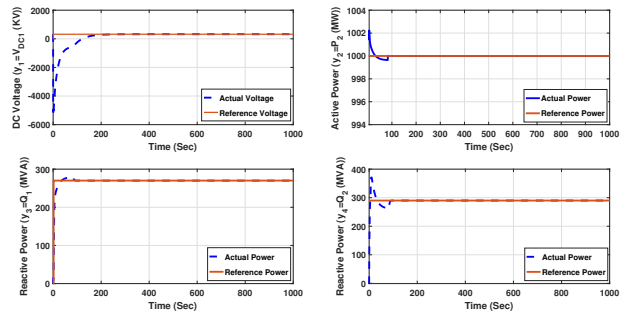

Fig. 5. Time response of DC voltage, active and reactive power.



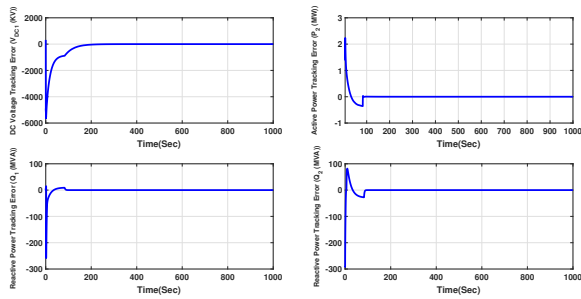

Fig. 6. DC voltage, active and reactive power tracking error.

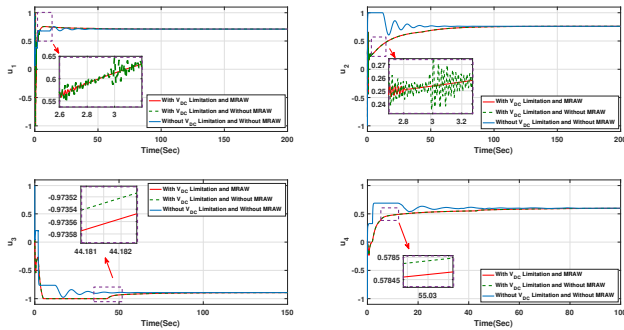

Fig. 7. Time response of the control action with and without  $V_{DC}$  limitation.

## VI. CONCLUSION

In this paper the mathematical models of the main components of the VSC-based HVDC transmission system were presented. There are two main difficulties in the controller design for real systems: parametric uncertainties and saturations. Parameter uncertainties often degrade system performance and may even lead to instability and saturation reduce the system performance. In this paper stabilization of HVDC system with parametric uncertainties and having restricted states and/or controls is studied. In the sense of Lyapunov method, for the HVDC system, sufficient conditions are formulated in the format of LMIs (Linear Matrix Inequalities). The MRAW is used to compensate the effect of the control saturation. The advantage of the MRAW architecture lies in the fact that the anti-windup filter keeps track (via MRAW states) of the amount of HVDC states response that is missing in the saturated closed-loop due to the undesired effects of saturation. The design scheme was applied to the stabilizing control of the HVDC. The simulation results proved the effectiveness, robustness and better tracking performance of the proposed controller in controlling HVDC systems with parametric uncertainties and the inputs and states constraints. It is planned in the near future, first to validate this control methodology on a HVDC inserted in a more detailed AC grid and next to implement the overall proposed control strategy on the actual hardware platform. In addition, modify this methodology to deals with nonlinear model. In future work, the stability with respect to the constraints on the system and eliminate the effect of

disturbance on system performance will study by synthesizing a Lyapunov quadratic function and by using LMI.

## REFERENCES

- [1] B. Anderson, "Topologies for VSC Transmission", In Seventh International Conference on AC-DC Power Transmission (IEE Con1 Publ. No.485), pp. 298-304, 2001.
- [2] F. Schettler, H. Hung and N. Chnstl, "HVDC Transmission using voltage sourced converters - Design and Applications", IEEE summer power meeting 2000, Seattle, July 2000.
- [3] M. Schwegmann, P. Kamp and B. Weis, "Voltage Sourced Converter for HVDC Application", In EPE 2001.
- [4] L. Thomas, S. Poullain, and A. Benchaib, "Analysis of a robust DC bus voltage control system for a VSC transmission scheme", In Seventh International Conference on AC-DC Power Transmission PEE Con/ Publ. No.ISS), pp. 119-24, 2001
- [5] L. Arioua and B. Marinescu, "Multivariable control with grid objectives of an HVDC link embedded in a large-scale AC grid", Int. J. Electrical Power and Energy Systems, vol. 72, pp.99-108, 2015.
- [6] L. Arioua and B. Marinescu, "Robust grid-oriented control of high voltage DC links embedded in an AC transmission system", Int. J. Robust Nonlinear Control, vol. 26, pp.1944-1961, 2016.
- [7] G. Asplund, "Application of HVDC Light to power system enhancement", IEEE Power Engineering Society Winter Meeting, Vol.4, Jan 2000, pp.2498-2503.
- [8] G. Zhang and Z. Xu, "Steady-state model for VSC based HVDC system and its controller design", IEEE Power Engineering Society Winter Meeting, vol.3, pp.1085-1090, 2001.
- [9] G. B. Zhang, Z. Xu and G. Z. Wang, "Steady state model and its nonlinear control of VSC-HVDC system, Proc. CSEE, vol.22, part-1, pp.17-22, 2002.
- [10] E. Kamal, A. Aitouche and D. Abbes, Robust fuzzy scheduler fault tolerant control of wind energy systems subject to sensor and actuator faults, International Journal of Electrical Power and Energy Systems, vol. 55, no.1, pp. 402-419, 2014.
- [11] E. Kamal, A. Aitouche, Fuzzy Fault-Tolerant Control of Wind-Diesel Hybrid Systems Subject to Sensor Faults, IEEE Transactions on Sustainable Energy, vol. 4, no. 4, pp. 857-866, Oct.2013.
- [12] E. Kamal and A. Aitouche, Robust Scheduler Fuzzy Controller of DFIG Wind Energy Systems, IEEE Transactions on Sustainable Energy, vol. 4, no 3, pp. 706-715, 2013.
- [13] E. Kamal, A. Aitouche, R. Ghorbani and M. Bayart, Robust Fuzzy Fault Tolerant Control of Wind Energy Conversion Systems Subject to Sensor Faults, IEEE Transactions on Sustainable Energy, vol. 3, no 2, pp. 231-241, 2012.
- [14] E. Kamal, A. Aitouche and M. Bayart, Intelligent Control of WECS subject to Parameter Uncertainties, Actuator and Sensor Faults, Acta Press, Control and Intelligent Systems, vol. 40, no 3, pp. 1-9, 2012.
- [15] E. Kamal, A. Aitouche, R. Ghorbani and M. Bayart, Robust Fuzzy Logic Control of Wind Energy Conversion Systems with Unknown Inputs. Acta Press, International Journal Power and Energy Systems, vol. 32, no 2, pp. 71-81, 2012.
- [16] E. Kamal, A. Aitouche, R. Ghorbani and M. Bayart, Robust Nonlinear Control of Wind Energy Conversion Systems, International Journal of Electrical Power and Energy Systems, 44, no.1, pp. 202-209, Jan. 2013.
- [17] M. Durrant, H. Werner, and K. Abbott, "Synthesis of multi-objective controllers for a VSC HVDC terminal using LMIs", IEEE Conference on Decision and Control, pp.4473-4478, 2004.
- [18] S. Y. Ruan, G. J. Li, X. H. Jiao, Y. Z. Sun, T. T. Lie, "Adaptive control design for VSC-HVDC system based on backstepping approach", Electric Power System Research, vol.77, no.5-6, pp.559-565, 2007.
- [19] H. Liang, L. Gengyin, L. Guangkai, P. Li and M. Yin, "Analysis and Design of Hf controller in VSC HVDC system", IEEE/PES Transmission and Distribution conference and Exhibition: Asia and Pacific, China, pp.1-6, 2005.
- [20] S. Hongye and C. Jian, "Robust stabilizing control for uncertain time-delay systems contain saturating actuators", Proc. IFAC LrDS'98, Grenoble, France, pp.7-12, 1998.
- [21] S. Boyd, L. El Ghaoui, E. Feron, and V. Balakrishnan. Linear Matrix Inequalities in System and Control Theory. SIAM Studies in Applied Mathematics. SIAM, Philadelphia, Pennsylvania, 1994.