



HAL
open science

Optimization of parallelized power inverters using a direct modelling approach for More Electrical Aircraft

Alvaro Morentin Etayo, Jeremy Bourdon, Lucien Prisse, Thierry Meynard,
Hubert Piquet

► **To cite this version:**

Alvaro Morentin Etayo, Jeremy Bourdon, Lucien Prisse, Thierry Meynard, Hubert Piquet. Optimization of parallelized power inverters using a direct modelling approach for More Electrical Aircraft. 2015 International Conference on Electrical Systems for Aircraft, Railway, Ship Propulsion and Road Vehicles (ESARS), Mar 2015, Aachen, Germany. pp.1-5, 10.1109/esars.2015.7101483 . hal-02507618

HAL Id: hal-02507618

<https://hal.science/hal-02507618v1>

Submitted on 14 Feb 2025

HAL is a multi-disciplinary open access archive for the deposit and dissemination of scientific research documents, whether they are published or not. The documents may come from teaching and research institutions in France or abroad, or from public or private research centers.

L'archive ouverte pluridisciplinaire **HAL**, est destinée au dépôt et à la diffusion de documents scientifiques de niveau recherche, publiés ou non, émanant des établissements d'enseignement et de recherche français ou étrangers, des laboratoires publics ou privés.

Optimization of parallelized power inverters using a direct modelling approach for More Electrical Aircraft

Alvaro Morentin Etayo^{1,2}, Jeremy Bourdon^{1,2},
Lucien Prisse

¹Airbus Operation SAS ; 316 route de Bayone,
31060 Toulouse cedex 9, France

Thierry Meynard, Hubert Piquet

²Université de Toulouse ; INPT ; UPS ; CNRS ; LAPLACE
(Laboratoire Plasma et Conversion d'Énergie) ; 2 rue
Camichel, F-31071 Toulouse cedex 7, France

Abstract—This paper presents a new approach to design parallelized power inverters used in More Electrical Aircraft equipment. Dimension-based analytical modelling of building components are described and their use to achieve the optimized design is presented. The results help choosing, among various solutions, which is the optimal (minimizing the global mass) parallelization strategy of two power inverters.

Keywords—More Electrical Aircraft, Parallelized Power Inverters, Direct Modelling

I. INTRODUCTION

In recent years, aircraft manufactures have been replacing pneumatic and hydraulic systems for electrical ones. First, this allows reducing CO₂ emissions and helps complying with new environmental objectives [1]. Second, the use of electrical equipment leads to advantages in terms of maintenance, power control, traceability and efficiency. As a consequence, the aircraft electrical equipment becomes a more significant part of the total aircraft mass. Different efforts are made in order to reduce the mass of electrical equipment considering new system level configurations [4] and new technologies (GaN, SiC,...) and topologies or integration of existing components [5],[8],[9]. Moreover, the synergies between the automotive and aerospace industries can lead to significant reduction of costs concerning research and development towards electrification of vehicles.

The More Electrical Aircraft concept implies that new architectures will be implemented in future aircraft. Manufacturers are evaluating the potential of an HVDC network (540V) to increase the flexibility of network management [7]. From this DC network a set of AC loads will be supplied through several power inverters and these power inverters can be reconfigured or parallelized to supply different loads of the aircraft. As the power consumption of each load varies from one flight phase to the other, a given power inverter could be connected or disconnected from a

load, according to the needs (See Figure 1). Besides, this power distribution strategy increases the availability in failure cases. In addition, the use of generic power inverters reduces the direct, manufacturing and maintenance costs thanks to large scales production and reduction of number of parts [4][6].

However, in order to implement this solution of mutualized power inverters, an optimal pre-design of the power inverters has to be performed in order to estimate if the proposed solution is more cost effective than the state-of-the-art solution, i.e. using one power inverter per load. In this study, the embedded mass is looked as the critical parameter in the design as it directly impacts the operational costs.

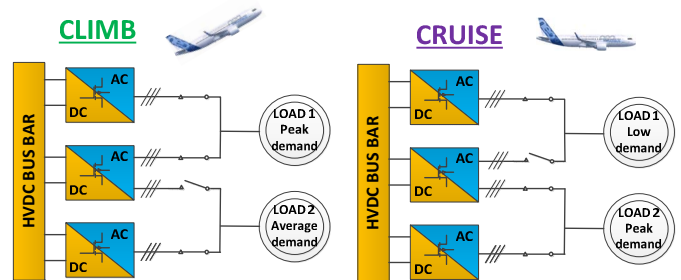

Fig. 1. Parallelization of power inverters for two different flight phases

In order to do so, a modelling method based on the dimensions on the different objects is used to predict accurately the mass of the power inverters. These models are validated comparing their properties to those of actual objects and used in an optimization loop to estimate the optimal weight of a solution consisting of two power converters supplying the same load.

II. PARALLELIZATION STRATEGY

In this study, two different parallelization strategies are considered: synchronous carriers and phase-shifted carriers (Figure 3). In the synchronous mode, the same carrier is used to generate the control signals of all parallel switching cells and in the phase-shifted mode, the carriers have a phase delay of $2\pi/N_{\text{cell}}$ radians between them, where N_{cell} represents the number of cells being parallelized.

A. Synchronous carrier

In theory, the command signals to each parallelized cells are exactly the same.

The advantages of this strategy are:

- Simple control

- No differential current between cells

However, in practice it has a major drawback due to the dispersion of the semiconductors properties which makes it hard for all cells to commute at exactly the same time. If a perfect synchronization is not obtained, quasi unlimited current spikes can circulate between the inverters, so in practice switching synchronization must be optimized and a minimal inductance is required between the inverters. (See Fig 2.)

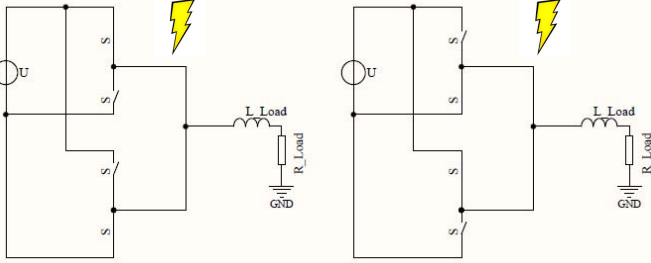

Fig. 2. Possible short-circuits between parallelized cells

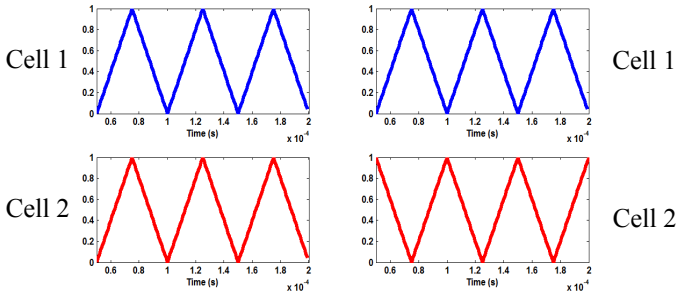

Fig. 3. Synchronized Carriers (Left) - Phase Shifted Carriers (Right) for two parallelized switching cells.

B. Phase shifted carrier

In this case the carriers of the parallelized cells are phase-shifted by $2\pi/N_{leg}$ radians. This makes the control more complex than in the synchronous carrier case. The advantages of this type of control are:

- Cancellation of the $N_{leg}-1$ first carrier band harmonics, which means that the load-side filter can be reduced in order to comply with the norm [10] and that the common mode filter can be reduced. The load current ripple is reduced and so are the losses induced by high frequencies so that the gauge section of the load can also be reduced.
- the decoupling capacitor of the DC bus can be reduced since the legs withdraw power from the bus dc-link capacitor at different times
- Faster transient response

In this case, the differential current between legs is high. As a result, the coupling inductance can be quite heavy compared to the synchronous solution.

III. MODELS

A. Direct Modelling

In this study, the analytical models are calculated using a so called “direct modelling” methodology; the components are described using their physical dimensions, shape and material [3]. The electric, magnetic and thermal models of these objects are derived from these physical inputs in a purely deterministic way. For example, an inductor which is physically described by its dimensions and material has an inductance value which is fully determined, while in an inverse modelling approach, using the inductance value given as an input, there is an infinite number of objects that give this inductance value. Using direct models, the problems related to the non-unicity of solutions to an optimization problem are thus avoided at the modelling level and will be handled at a later stage of the design process.

B. Modelling Levels

In this approach, the components are described at different complexity levels. Level 0 is the most simple, must be very fast to compute and should be used for fast predesign or when a large system is described. It can use homothetic equations or response surfaces that come from experimental data and use a reduced number of variables. These simple models allow exploring in a short time a wide number of solutions in order to choose the optimal one.

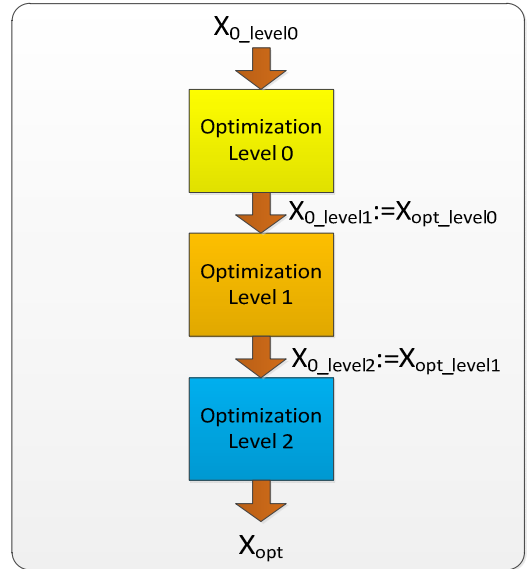

Fig. 4. Level optimization algorithm

Using the results of the exploration phase, optimum second search can be performed using more sophisticated models that need more computation time, but looking into a smaller set of solutions (See Fig. 4). At this level simplified physics-based models like 1D or 2D approximations are typically used. The third level allows much more complicated models to be used like multiphysics 3D models, but because of the computation time they need, this level is only provided for post processing check, and will generally not be used by the optimization routines.

C. Geometric Model

The inputs of the model are the physical dimensions, the shape and the materials of the object. Its volume and weight can be easily calculated and unlike other outputs of the models, there should not be any error in the calculations.

D. Electric Model

The electrical parameters of all the components are calculated using their physical dimensions. To prove the validity of the models, the results are compared to experimental data, which gives a first estimate of the error. Knowing this error is important since it can be used as a security factor in the optimization constraints. In addition, these parameters are used to build an electric model for simulation. The complexity level is represented as well in the simulation models (See Fig. 5). It can be seen that the equivalent electric model of the inductor increases the number of elements in order to better simulate the real behaviour.

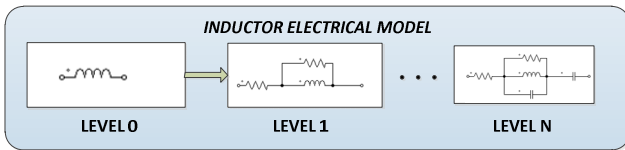

Fig. 5. Inductor Level Modelling

E. Thermal Model

In the design of power components, the maximum allowed temperature is a critical point, so it is always needed to have a thermal model. At this point of the study, only the steady state temperature is considered, so the model involves only thermal resistances. To prove the validity, it is compared to finite element calculation data. In Fig. 6, a validation of the temperature difference is presented to show the difference between an analytical calculation and a finite element method calculation for an inductor leg.

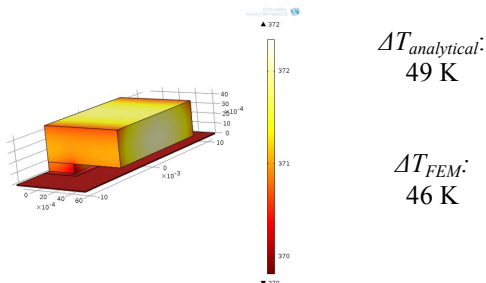

Fig. 6. Finite Element Thermal Model for an inductor

F. Calculation Algorithm

The models cannot be used simultaneously. For example, for the temperature calculation, the losses should be calculated in previous step. The calculation algorithm of the direct modelling is presented on Fig. 7.

First, the parameters needed for electrical simulation or those that can be calculated just using the physical inputs are computed. Second, an electrical simulation is performed at the system level. From the waveforms obtained from these simulations, the losses can be calculated and the temperatures are estimated.

IV. EXPERIMENTAL VALIDATION

The models are compared to actual objects to have a first estimation of the precision error. On the following tables, the comparison between experimental and model data for an inductance and a heat sink are presented.

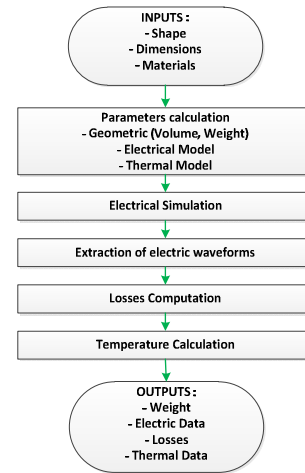

Fig. 7. Direct modelling calculation algorithm

TABLE I. INDUCTOR VALIDATION

Parameter	Value		Relative error %
	Model	Component	
Inductance (μH)	1361	1469	-7,32
Resistance (Ω)	101,46	92	10,28

TABLE II. HEATSINK VALIDATION

Parameter	Value		Relative error %
	Model	Component	
$R_{th}(\text{W/K})$	0,228	0,23	-1,18

The results show that the model is sufficiently accurate to estimate the parameters (maximal relative error 10%) and give a first indicator to prove the validity of the final optimal solution.

V. OPTIMIZATION

Once all the component models have been set up and validated with experimental data, they can be used for the design of the power inverters of our case of study within an optimizing process which will minimize the mass. The direct modelling is inserted in an optimization loop as it is described on the figure 8. As it can be seen, the values of the inputs are changed by the optimizer in order to find the optimal solution.

The optimization algorithm chosen is the gradient descent due to its fast convergence. As a result, all the models need to be continuous; this means that the discrete variables will be assumed continuous. Thus, the optimal result may not normally be an actually feasible solution. For these discrete variables the solution will be approximated to its closest actual

value. The constraints of the optimization process can be classified into two groups:

- Physical constraints: specific to the component. For example maximal temperatures, saturation level of induction field, dielectric strength...
- Systems constraints: user-defined. In our case of study they refer to specific airborne equipment standards [10].

Mathematically, it is described using the following notation:

$$\text{Min } m_{\text{heatsink}} + m_{\text{filter}} + m_{\text{inductors}}$$

s.t.

$$\Delta T_{\text{element}} \leq \Delta T_{\text{element_limit}} \quad (1)$$

$$B_{\text{inductors}} \leq K_{\text{margin}_1} \cdot B_{\text{sat}} \quad (2)$$

$$V_{\text{diff_capa}} \leq K_{\text{margin}_2} \cdot V_{\text{breakdown}} \quad (3)$$

$$I_{\text{DC_Bus}} \leq I_{\text{Norm}} \quad (4)$$

Where m_i represents the mass of each element i , being it sum the objective function to minimize. Constraint 1 considers that the temperature difference ($\Delta T_{\text{element}}$) for each element must always be below a certain limit ($\Delta T_{\text{element_limit}}$). Constraint 2 takes into account the magnetic field inside inductors ($B_{\text{inductors}}$) which must remain below the magnetic saturation field (B_{sat}) using a margin K_{margin_1} . Constraint 3 forces the filter capacitor to be sized to be able to withstand a differential bus voltage ($V_{\text{diff_capa}}$). Constraint 4 implies the injected current in the DC Bus ($I_{\text{DC_Bus}}$) fulfils the system standard (I_{Norm}).

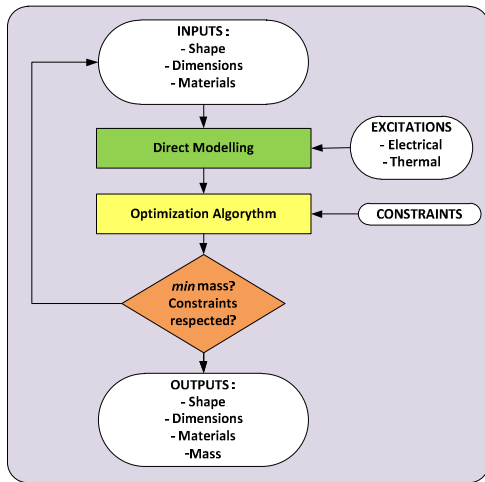

Fig. 8. Optimization algorithm using the direct modelling approach

A. Problem Description

After all the models have been implanted and validated the optimization design can be performed. For our case of study,

the parallelization of two three phase power inverters supplying a load shall be performed.

The components optimized in this problem are:

- 1 L-C differential filter per module
- 3 coupling inductors per module
- 3 semiconductors for the higher voltage side of the power inverters per module
- 3 semiconductors for the lower voltage side of the power inverters per module
- 1 heat sink per module, cooled by forced air. Its purpose is to cool the switching devices

The operating point is described in TABLE III. .

TABLE III. OPERATING POINT

Parameter	Value
Voltage High Side	540 V
Peak Voltage Low Side	270 V
Load consumption	15 kW
Ambient Temperature	25 °C

The switching frequency is considered as an optimization parameter as it may impact directly the filters weight, as well as the losses. Furthermore, this optimization will help to determine which are the optimal control strategy in terms of parallelizing power inverters using separate inductors (Synchronous carrier {S} or Phase Shifted carrier {PS}). The power converters are cooled by forced air.

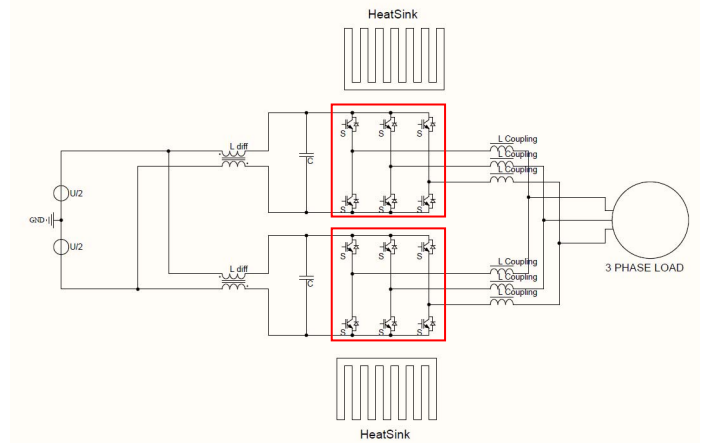

Fig. 9. System being optimized

B. Optimization Results

All the results and the optimal waveforms for the optimized power inverter are presented in TABLE IV. The results are normalized to reference values.

TABLE IV. RESULTS

Parameter	Value	
	Synchronous	Phase-Shifted
Mass (p.u.)	1.1	14.03
Losses (p.u.)	1.55	1.22

The results are as expected, the weight of the phase shifted carrier is higher due to the impact of the coupling inductances as they have to handle a differential mode current. Moreover, the weight of the synchronous carrier solution strongly depends on the short-circuit protection inductance value. On the contrary, the phase-shifted carrier strategy exhibits lower losses which is advantageous as the embedded carburant for a flight mission and as consequence the CO₂ emissions are reduced. The next steps will be to predict this impact and on the common mode filter, which will be normally smaller for the phase shifted strategy. In order to so, a CEM model for all the components must be described. In Fig. 10 the waveforms for the currents of the two cells parallelized for the first phase is presented. It can be seen that the differential current causes high current ripple which increases the electric losses and as consequence the weight of the inductors. In Fig. 11, it can be seen that the current ripple per cell is lower so the inductances are lighter.

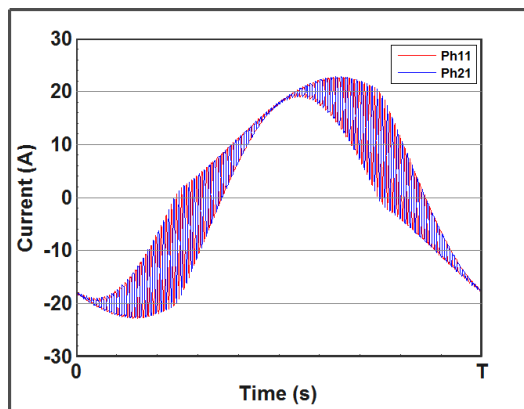

Fig. 10. AC current waveform for the two cells being parallelized using a Phase Shifted carrier strategy

VI. CONCLUSION

A new way of modelling power components for inverter design has been presented. It was then used to solve an optimization problem related to the parallelization of two power inverters. Results show that synchronous carrier strategy is the best parallelization method in terms of mass.

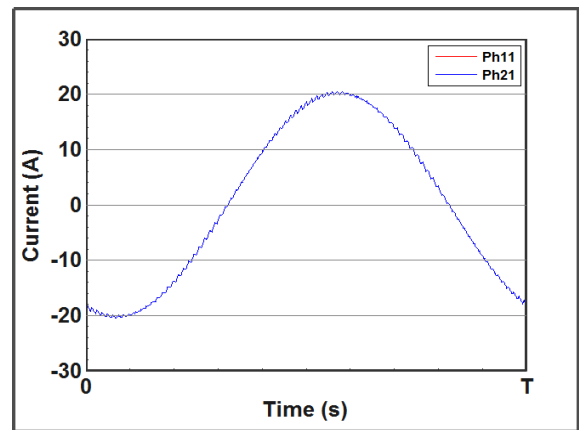

Fig. 11. AC current waveform for the two phases being parallelized using a Synchronous carrier strategy

References

- [1] Advisory Council for Aeronautics Research in Europe, Aeronautics and Air Transport Beyond vision 2020 towards 2050 http://ec.europa.eu/research/transport/pdf/acare_background_2010_en.pdf.
- [2] J. Biela, U. Badstuebner, and J. W. Kolar, "Impact of Power Density Maximization on Efficiency of DC; DC Converter Systems," *IEEE Transactions on Power Electronics*, vol. 24, no. 1, pp. 288–300, Jan. 2009.
- [3] F. Forest, J. Brunello, J. Bourdon, T. Meynard, E. Labouré, J. J. Huselstein, and others, "Modèles analytiques simplifiés des composants de puissance passifs et actifs pour la conception optimale de convertisseurs," in *Symposium de Génie Électrique 2014*, 2014.
- [4] X. Giraud, "Méthodes et outils pour la conception optimale des réseaux de distribution d'électricité dans les avions," Phd Thesis. INSA Toulouse, 2014.
- [5] R. R. Mariani, F. Lacressonniere, G. Fontes, and X. Roboam, "Design of a medium voltage power converter-storage devices embedded in a hybrid emergency network for more electrical aircraft," *Mathematics and Computers in Simulation*, vol. 91, pp. 72–90, 2013.
- [6] L. Prisse, D. Ferer, H. Foch, and A. Lacoste, "New power centre and power electronics sharing in aircraft," in *Power Electronics and Applications, 2009. EPE'09. 13th European Conference on*, 2009, pp. 1–9.
- [7] X. Roboam, B. Sareni, and A. Andrade, "More Electricity in the Air: Toward Optimized Electrical Networks Embedded in More-Electrical Aircraft," *IEEE Industrial Electronics Magazine*, vol. 6, no. 4, pp. 6–17, Dec. 2012.
- [8] X. Roboam, "New trends and challenges of electrical networks embedded in 'more electrical aircraft,'" in *Industrial Electronics (ISIE), 2011 IEEE International Symposium on*, 2011, pp. 26–31.
- [9] J. A. Rosero Garcia, J. A. Ortega Redondo, E. Aldabas Rubira, J. L. Romeral Martínez, and others, "Moving towards a more electric aircraft," 2013.
- [10] "EUROCAE ED-14D/ RTCA DO-160D." 2010.
- [11] X. Giraud, M. Sartor, X. Roboam, B. Sareni, H. Piquet, M. Budinger, S. "Load allocation problem for optimal design of aircraft electrical power system" - *International Journal of Applied Electromagnetics and Mechanics* – 2013 - Volume 43 - Issue 1- pp 37-49, <http://dx.doi.org/10.3233/JAE-131708>