

# Active clamping of IGBT : capacitor replaces TRANSIL<sup>tm</sup> diodes

Lefranc Pierre<sup>1</sup>, Bergogne Dominique<sup>1</sup>, Planson Dominique<sup>1</sup>, Allard Bruno<sup>1</sup>, Morel Hervé<sup>1</sup>  
Roche Jean-François<sup>2</sup>

<sup>1</sup>Cegely (UMR CNRS n°5005)  
Bât L. de Vinci, INSA de Lyon, 20, Av. A. Einstein  
F-69621, Villeurbanne, France  
Tel : 33 04 72 43 83 83  
Fax : 33 04 72 43 85 30  
[lefranc@cegely.insa-lyon.fr](mailto:lefranc@cegely.insa-lyon.fr)

<sup>2</sup>ARCEL  
2 rue des Aulnes, ZI du Tronchon  
F-69410 Champagne au Mont d'Or, France  
Tel : 33 04.78.35.02.21  
Fax : 33 04 78 35 69 54  
[roche@arcel.fr](mailto:roche@arcel.fr)  
[www.arcel.fr](http://www.arcel.fr)

## Keywords

Device applications, Drives, Discrete power devices, High power discrete devices

## Abstract

**Active clamping is one major security function of an IGBT driver. Transil diodes are commonly used. This paper details the investigation of an original solution without such diodes. A charged capacitor in series with a fast diode is used. Clamping voltage is continuously adjustable. Experimental results are presented.**

## 1. Active clamping

This introduction presents the active clamping feature of an IGBT driver. This security function is implemented to control over-voltage at IGBT turn-off occurring after an over-current detection. The energy stored in the parasitic inductance can be absorbed by turning-on the IGBT in its linear region to smooth-out the over-voltage. Classically, the active clamping is based on Transil diodes [3], [4], [5], [6]. The name “active” comes from the fact that the active clamping makes use of an active component, the IGBT itself.

The threshold voltage of Transil diodes is not well controlled and few values are commercially available. The converter designer has to manage a security margin and set the desired clamping voltage far below the IGBT breakdown voltage [1], [2] (Fig. 2). The circuit proposed here permits an extended control of the clamping voltage.

In actual clamping systems, the clamping voltage is set by several series connected Transil diodes. When unexpected over-voltage occurs at turn-off, a current is injected in the gate of the IGBT so as to obtain conduction. The shape of the gate current waveform indicates the action of the active clamping as in Fig. 1. When the gate driver produces a negative voltage to turn-off the IGBT, a negative current flows in the gate circuit. Should active clamping occurs, gate current is modified and becomes positive. Gate-emitter capacitance recovers charge and gate to emitter voltage increases : the IGBT is in a conduction state in the linear region.

Active clamping creates a feedback effect limiting the IGBT's collector to emitter voltage :  $V_{ce}$  voltage is clamped. The IGBT operates in the linear operating area absorbing the energy from the leakage inductance.

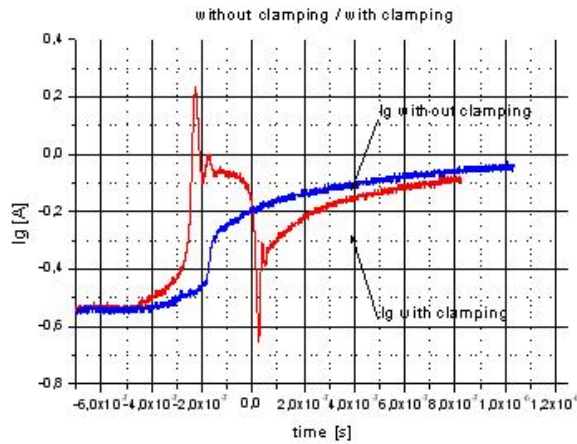

Fig. 1.  $I_g$  with and without clamping

Active clamping operates when the turn-off current in the IGBT is higher than the rated current, well over functional operating conditions.

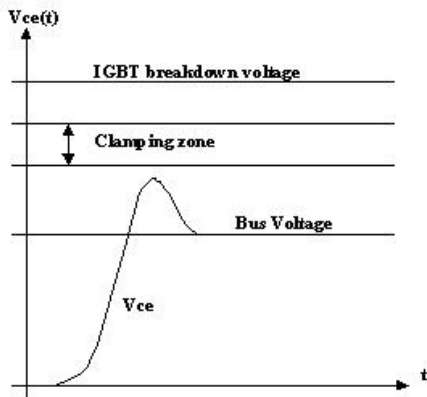

Fig. 2.  $V_{ce}$  during the turn off of IGBT (normal operation)

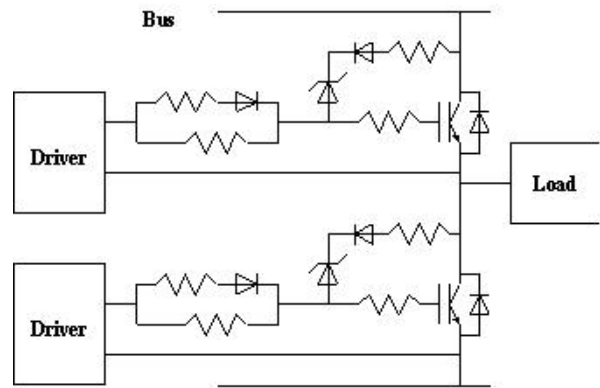

Fig. 3. Classical clamping (only one Transil diode shown for clarity)

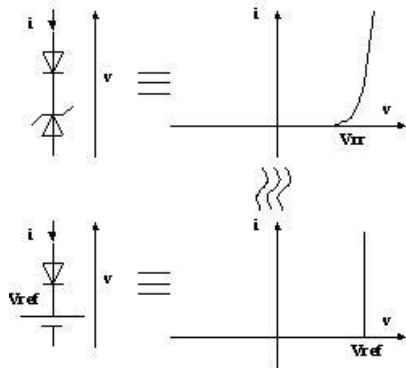

Fig. 4. Equivalence between transil diode and voltage source

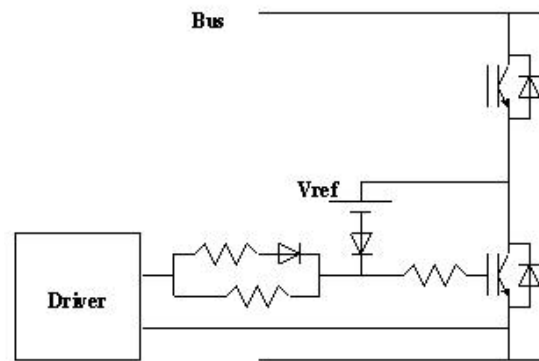

Fig. 5. clamping with ideal voltage source

## 2. Use of a capacitor

In actual clamping circuits Transil diodes are series connected with a diode in order to provide a threshold response. This circuit has the same  $i=f(v)$  characteristic as a voltage source in series with a diode (Fig. 4).

Transil diodes can be replaced by a voltage source as in Fig. 5. The voltage source  $V_{ref}$  can be made continuously adjustable whereas it is not the case of Transil diodes.

The simplest practical voltage source is a charged capacitor with a constant voltage. It is the principle of the system presented in this paper (Fig. 6).

Resistance  $R_1$  biases capacitor  $C_1$  to  $V_{ref}$  voltage. Capacitor  $C_1$  is equivalent to a voltage source. Diode  $D_1$  prevents capacitor  $C_1$  from discharging in  $T_1$  when in the on-state. Diode  $D_2$  isolates the clamping circuit when not in use. Resistors  $R_2$  and  $R_5$  permits to adjust the dynamic behaviour. In the following paragraph, we will see how the clamping voltage is adjusted by resistor  $R_5$  as well as it can be set by the voltage source  $V_{ref}$ .

Notice the external voltage source  $V_{ref}$  in Fig. 6. A previous study on the action of  $V_{bus}$  [7] has shown that it is preferable, especially for industrial applications, to make  $V_{ref}$  equal to  $V_{bus}$ .

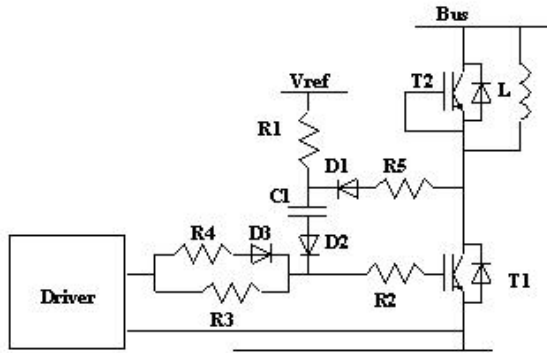

Fig. 6. Clamping circuit using a capacitor



Fig. 7. IGBT Mitsubishi CM100DU-24H

### 3. Experimental set-up

An experimental set-up is developed to study the use of a capacitor, and associated components, in an active clamping circuit.

Fig. 6 shows the experimental set-up, leakage parasitic inductance is not shown on diagram.

IGBTs  $T_1$  and  $T_2$  are in the same package with integrated diodes.

The IGBT module is a CM100DU-24H (Mitsubishi [8], Fig. 7). It is rated 100A and 1200V.

Inductor  $L$  is  $5,7\mu\text{H}$ .

Leakage inductance is estimated to around 70nH.

$V_{ref}$  is equal to  $V_{bus}$ .

$V_{bus}$  is 600VDC.

In the experimental set-up, Fig. 6, the IGBT's switched current is adjusted from 150A to 650A. The choice of a low inductor value for  $L$  permits to reach full load current in one short conduction period as to avoid excessive thermal stress. Exceeding the IGBT's rated current is possible, but above 800A - 8 times the rated value - destruction is almost inevitable.

### 4. Influence of components

In order to study this influence of components, the experimental set-up is used. A first measurement is made with clamping circuit deactivated ( $R_5 = \text{infinity}$ ), switched-off current greater than two times rated current. Subsequent measurements are carried out with clamping circuit activated and with changing values of  $R_5$  (range : 33-500 $\Omega$ ) and swapping diode  $D_2$  (SiC, BY228, BY448).

#### 4.1. Conditions of tests

The results here have been made with a fixed configuration of resistors  $R_1$ ,  $R_2$ ,  $R_3$  and  $R_4$ , of diode  $D_3$  and inductance  $L$  as in Fig. 6. These values are the result of a previous study. Resistor  $R_5$  (dynamic control) and diode  $D_2$  (threshold switch) are the components of which the influence is studied in these tests.

$$R_1 = 2.2\text{k}\Omega$$

$$R_2 = 1.2\Omega$$

$$R_3 = 47\Omega$$

$$R_4 = 1\Omega$$

$$L = 5.7\mu\text{H}$$

$$D_3 : \text{BY448}$$

$$V_{ref} = V_{bus}$$

$$C_1 = 10\text{nF}$$

## 4.2. Turn off with clamping deactivated

The Fig. 8 displays the turn off of the IGBT. The  $V_{bus}$  voltage is equal to 600V and the turn-off IGBT current is 230A (the IGBT is 100A rated).

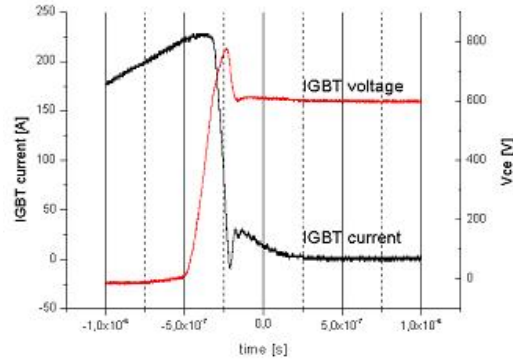

Fig. 8. Turn off of the IGBT, 230A, 600V

The maximum of  $V_{ce}$  is 800V, the over voltage represents 30% of the bus voltage.

## 4.3. Turn off with clamping activated : influence of $C_1$

First, we determine the influence of capacitor  $C_1$ . During the turn off of the IGBT, capacitor  $C_1$  must supply a current in the gate of the IGBT. For this IGBT, we consider that the capacitor must supply 1A during clamping. Capacitor voltage mustn't vary more than 10% during clamping (around 200ns). If we consider equation (1), capacitor  $C_1$  must be higher than 3.3nF.

$$i_{c1} = C_1 \cdot \frac{dV_{C1}}{dt} \quad (1)$$

Electrical values are :  $\Delta V_{C1} = 60V$ ,  $\Delta t = 200ns$  and  $i_{c1} = 1A$ . Hence :  $C_1 = 3.3nF$ .

$C_1$  must be equal or higher than 3.3nF. A complete study has been made previously to validate the theoretical calculation of  $C_1$  [7].

## 4.4. Influence of $D_2$

Diodes  $D_2$  and  $D_1$  are in series when the clamping circuit is functioning. The influence of diodes  $D_1$  and  $D_2$  is presented in the former reference [7]. The results show that the nature (general-use, fast, super-fast, Silicon and Silicon Carbide) of diodes  $D_1$  and  $D_2$  has an influence on the clamping voltage. The major influence is produced by  $D_2$ .

Fig. 9, Fig. 10, and Fig. 11 show the results with SiC diodes (D06S60, Schottky, 600V, 6A), BY228 (1650V, 5A) and BY448 (1650V, 4A) diodes. Resistor  $R_5$  is equal to 33 $\Omega$ , capacitor  $C_1$  is equal to 10nF.  $V_{ref}$  voltage is equal to  $V_{bus}$ .

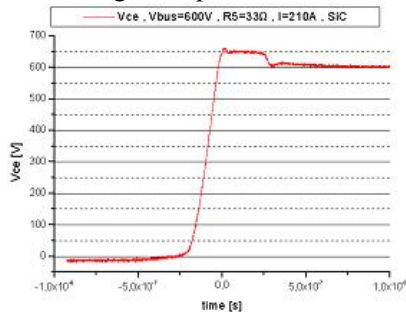

Fig. 9. Clamping with SiC diode ( $D_2$ )

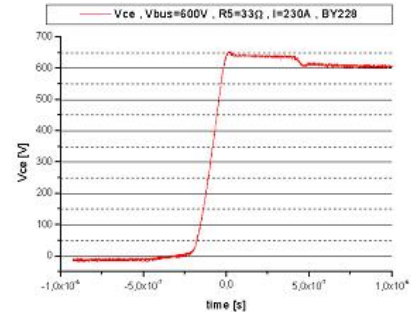

Fig. 10. Clamping with BY228 diode ( $D_2$ )

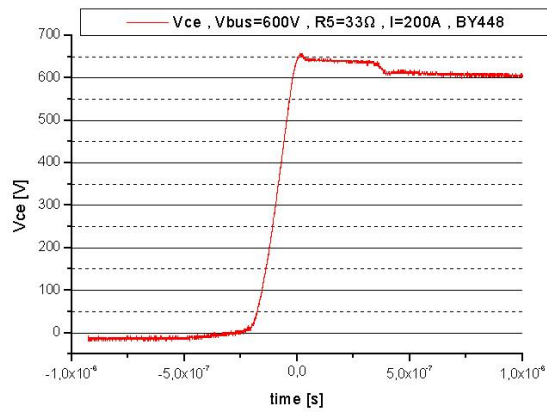

Fig. 11. Clamping with BY448 diode ( $D_2$ )

The nature of diode  $D_2$  has an influence on the clamping voltage. The shape is not the same with SiC Schottky diode (D06S60) as with PN diodes (BY228 and BY448). SiC diodes are Schottky while Si diodes are PIN diodes.

SiC diodes were introduced with the hope of increased dynamic performance. What the experiment reveals is a relatively slower behaviour resulting in a higher clamping voltage. It is important to notice that, here, the diodes are not used in a standard switching cell where forced turn-off is the main issue. In the proposed circuit  $D_2$  is zero volt biased prior to turning on. It is the ability of the diode to allow a direct current to flow that is implied. Further work is necessary on this aspect, comparing silicon and silicon-carbide diodes at turn-on under zero volt biasing.

#### 4.5. Influence of $R_5$

$V_{ref}$  is the most direct means to adjust the clamping voltage. But for industrial solutions, it is not advisable to implement a voltage source with a floating reference. A second possibility is to use the dynamic response. Resistor  $R_5$ , which adjust dynamic behaviour, permits to adjust the clamping voltage as a consequence.

The experimental results presented here show the influence of  $R_5$  on clamping voltage with  $R_5$  ranging from  $33\Omega$  to  $500\Omega$  (Fig. 12 to Fig. 17.)

Capacitor  $C_1$  is  $10nF$ , diodes  $D_1$  and  $D_2$  are Schottky SiC diodes.

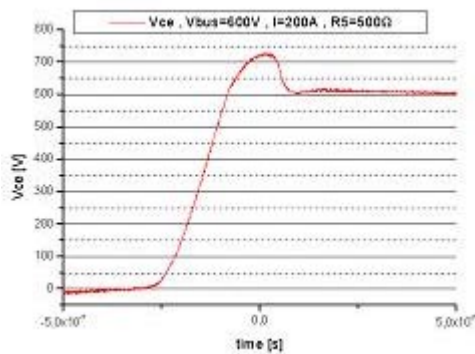

Fig. 12. Clamping with  $R_5=500\Omega$

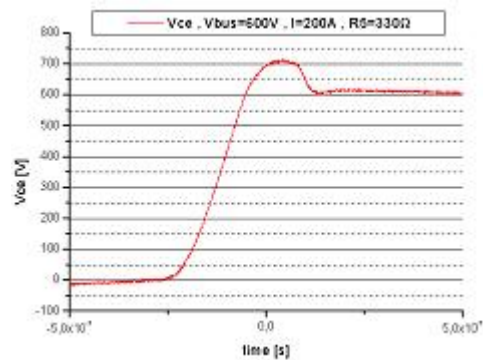

Fig. 13. Clamping with  $R_5=330\Omega$

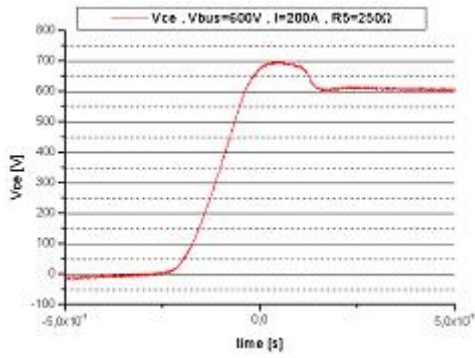

Fig. 14. Clamping with  $R_5=250\Omega$

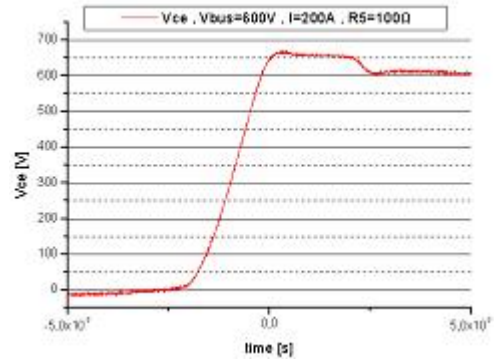

Fig. 15. Clamping with  $R_5=100\Omega$

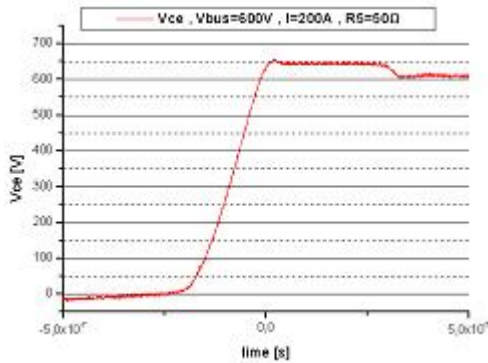

Fig. 16. Clamping with  $R_5=50\Omega$

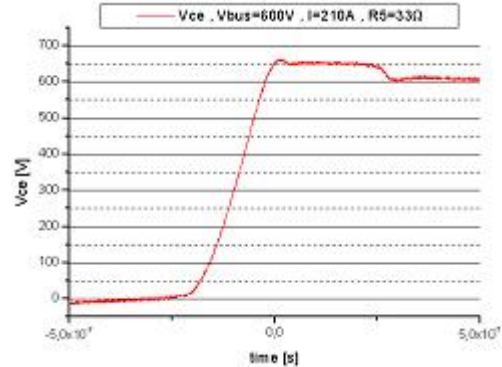

Fig. 17. Clamping with  $R_5=33\Omega$

It can be noticed that the value of the over-voltage of  $V_{ce}$  is dependent on  $R_5$ .

For low values of  $R_5$  (from  $50\Omega$  to  $33\Omega$ ), the over voltage is equal to  $650V$  and is not reduced further. Much lower values will produce unwanted oscillations.

## 5. Performance of proposed clamping circuit versus switched current

The switched current of the IGBT has an influence on the over voltage. The larger the current, the larger the energy in the stray inductance resulting in over voltage. Performance of the proposed circuit is investigated : bus voltage is set to  $600VDC$ , switched current is variable from  $200A$  to  $630A$  (rated current is  $100A$ ), resistor  $R_5$  is  $50\Omega$ , diodes  $D_1$  and  $D_2$  are SiC Schottky diodes, capacitor  $C_1$  is  $10nF$ . The experimental results are displayed in Fig. 18 to Fig. 22.

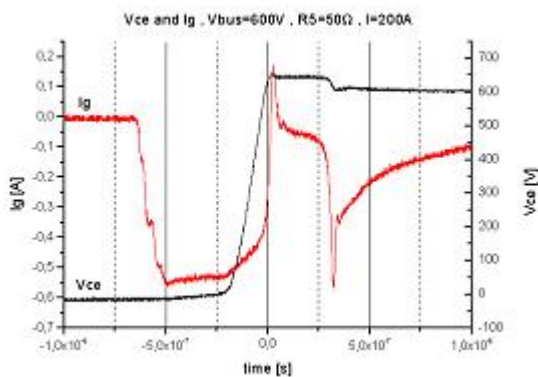

Fig. 18. Clamping with  $I=200A$

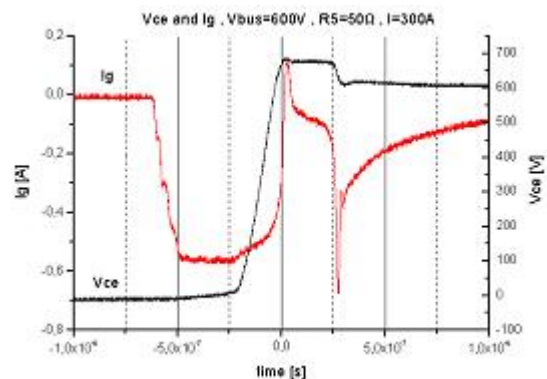

Fig. 19. Clamping with  $I=300A$

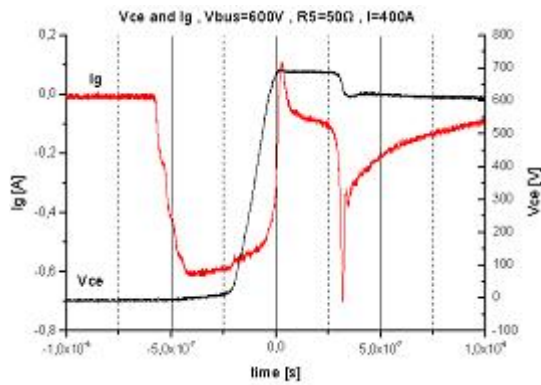

Fig. 20. Clamping with I=400A

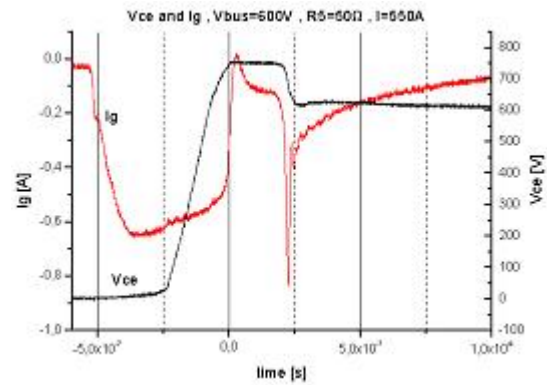

Fig. 21. Clamping with I=550A

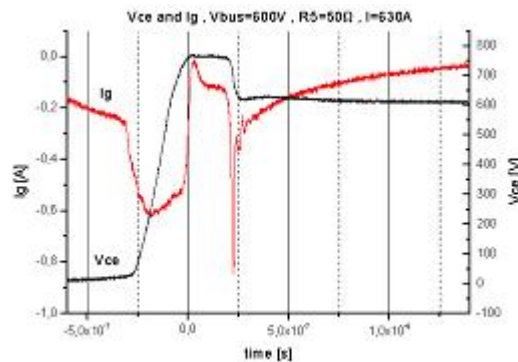

Fig. 22. Clamping with I=630A

## 6. Conclusion

Controlling over-voltage at IGBT turn-off occurring after an over-current detection is called active clamping when the IGBT itself is used via an additional circuit injecting a feedback current in the gate. In this paper we present an alternative to the Transil diodes commonly used in clamping circuits : a charged capacitor in series with a diode

A selection of experimental results show the influence of the main components on the system's behaviour. SiC diodes are used but a conclusion cannot be made as turn on behaviour under zero voltage bias is not corresponding to usual expectations, further work is to be carried out.

However, the proposed circuit permits to implement a clamping function. Clamping voltage is adjusted by setting one resistor value. Thought for industrial applications this circuit is kept simple.

## 7. References

- [1]. C.S. Mitter, "Application consideration using Insulated Bipolar Transistor", application note AN1540, Motorola.
- [2]. J. Dodge, J.Hess, "IGBT Tutorial", application note APT0201, Advanced Power Technology, Rev.B, july 2002.
- [3]. Heinz Rüdi, "Driver Solutions for high-voltage IGBTs-short circuit detection by monitoring the saturation voltage", PCIM Europe 2002, pp.14-23, CT Concept Technologie AG, April 2002.
- [4]. Heinz Rüdi, Peter Köhli, "SCALE driver for high voltage IGBTs", PCIM Europe 1999, CT Concept Technologie AG, Juin 1999.
- [5]. Heinz Rüdi, "Modular SCALE driver solution for EconoPACK+", PCIM 2001, CT Concept Technologie AG.
- [6]. H.Foch, F.Richardeau, G.Bonnet, P.Austin, J-L. Sanchez, "Intégration de protections vitales, aide à la surveillance rapprochée", GdR Intégration des systèmes de puissance, GdR 2001.
- [7]. P.Lefranc, « Clamping actif d'IGBT : diodes transil remplacées par des condensateurs », JCGE 2003.
- [8]. Mistubishi Semiconductor, <http://www.mitsubishichips.com/common/cfm/eEntry.cfm>