



HAL
open science

Multiproduct biorefinery optimal design: application to the acetone-butanol-ethanol system

Ségolène Belletante, Ludovic Montastruc, Michel Meyer, Heri Hermansyah, Stéphane Négny

► To cite this version:

Ségolène Belletante, Ludovic Montastruc, Michel Meyer, Heri Hermansyah, Stéphane Négny. Multiproduct biorefinery optimal design: application to the acetone-butanol-ethanol system. Oil & Gas Science and Technology - Revue d'IFP Energies nouvelles, 2020, 75, 14p. 10.2516/ogst/2020002 . hal-02490115

HAL Id: hal-02490115

<https://hal.science/hal-02490115>

Submitted on 24 Feb 2020

HAL is a multi-disciplinary open access archive for the deposit and dissemination of scientific research documents, whether they are published or not. The documents may come from teaching and research institutions in France or abroad, or from public or private research centers.

L'archive ouverte pluridisciplinaire **HAL**, est destinée au dépôt et à la diffusion de documents scientifiques de niveau recherche, publiés ou non, émanant des établissements d'enseignement et de recherche français ou étrangers, des laboratoires publics ou privés.

Multiproduct biorefinery optimal design: application to the acetone-butanol-ethanol system

Ségolène Belletante¹, Ludovic Montastruc^{1,*}, Michel Meyer¹, Heri Hermansyah², and Stéphane Negny¹

¹ Université de Toulouse, Laboratoire de Génie Chimique UMR CNRS/INPT/UPS 5503, 4 allée Emile Monso, CS 84264, 31432 Toulouse, France

² Department of Chemical Engineering, Faculty of Engineering, University of Indonesia, Depok 16424, Indonesia

Received: 30 September 2019 / Accepted: 17 January 2020

Abstract. The bioproduct from biomass appears to be major interests for future years given the spectacular and fast advances in microbiology. But the industrial developments of the new bioproducts production struggle to follow this constant and massive creation. Therefore, to estimate the potential of new bioproducts is necessary to pre-design biorefineries with the highest relevance. This study proposes a methodology assessing the relevance of such industrialized production. The presented tool is a multi-scale methodology describing a decision-support tool for the determination of an optimal biorefinery from a superstructure through process simulation, and economic and environmental evaluations. To optimize the biorefinery, energy integration is also applied on the selected processes, because a biorefinery needs a large amount of energy to operate, especially in the pretreatment and purification steps of the process due to huge water flowrate. Thus, the tool designs an efficient, profitable and sustainable biorefinery. We demonstrate our methodology capabilities with the acetone, butanol and ethanol production (ABE system) from lignocellulosic biomass, especially from wood wastes.

Abbreviations

MINLP	Mixed Integer Non-Linear Programming
MILP	Mixed Integer Linear Programming
IPCC GWP	Intergovernmental Panel on Climate Change Global Warming Potential
LCA	Life Cycle Assessment
DM	Dry Matter
HMF	Hydroxymethylfurfural

1 Introduction

The quest for sustainability is changing how chemical engineers imagine new processes in a complex system. It is necessary to evaluate the economic profit with social uncertainties, local diversity of renewable resources and globalization but also to evaluate the environmental impact. These realities are changing the nature of process design problems and recent advancements have been able to incorporate the multidimensionality and multi-scale boundaries. The biorefinery concept is a famous example to illustrate this complex system. In this article, the aim is to propose

an integrated framework that captures the full range of scales and interactions from molecular to process levels. The concept of biorefinery is nowadays in an era of energy transition, which is an additional difficulty because all solutions are compared to petrochemicals, so it is very difficult to avoid this analysis.

In this context, we need to develop new processes of valorization of biomass. Currently, pyrolysis, gasification, liquefaction and biorefining are some alternatives to transform the biomass (Domine *et al.*, 2015). Cherubini (2010) explains that the “*biorefining is the sustainable processing of biomass into a spectrum of marketable products and energy*”; the principle of biorefining is the same as the principle of refining from petroleum. This process is composed by physical, chemical, thermal and biological steps. Biorefining is a growing topic and biorefinery laboratory data is accumulating strongly, but this type of process is still largely unknown on an industrial scale. Therefore, the economic and ecological viability of biorefineries in the current level of development is uncertain, especially compared to a perfectly optimized process like that of the traditional refinery. Moreover, according to Harmsen *et al.* (2014) and to the report of the *National Renewable Energy Lab* (Werpy and Petersen, 2004), it is possible to develop some new biochemical products thanks to the use of biomass and the microorganism related on. In this case,

* Corresponding author: ludovic.montastruc@ensiacet.fr

it is necessary to propose a method to evaluate the industrial interest to synthesize and design the biorefinery.

In the same time, biologists imagine and create via the genetic engineering new microorganisms producing current and new products faster than the development of the industrial process of biorefinery related to a microorganism. The development of metabolic engineering and synthetic biology tools showed that various microorganisms are being used to produce biochemicals for various purposes. Thus, the study of the industrial potential and the selection of the most promising microorganisms are necessary to offset this backwardness in the development of industrial processes. Therefore, in order to reconcile laboratory scale and industrial scale, we need to develop methods for determining the potential of industrial biorefineries from laboratory data. In addition, these methods must include the design and optimization of the process to make the biorefinery attractive to the petrochemical process. As a result, the main contribution of this article is to propose a multi-scale methodology for the optimal design of multi-product biorefineries. Currently in the literature, the optimal design of biorefineries is studied at the different space scales but most researches are focused on a single scale.

On the biorefinery scale, [Pham and El-Halwagi \(2012\)](#) proposed a two stages approach for the synthesis and the optimization of biorefineries configuration. The first stage consists in determining the potential conversions from several raw materials to desired final products. The second part includes the optimization of the process depending on the performances of the biorefinery. [Moncada et al. \(2013\)](#) determined the biorefinery's configuration by comparison and optimization of different biochemical pathways with economic, environmental and technical objectives to produce biochemical products and bioenergy. The model includes process simulation in order to obtain exact energy results. [Sammons et al. \(2007, 2008\)](#) evaluated different pathways to maximize the Net Present Value and minimize the environment impact. They created a library of processes based on experimental data and process simulation. Pinch method (for the energy integration) and research for green solvents are included in their approach. The optimization tool of [Zondervan et al. \(2011\)](#) determined the optimal black box structure of the process among a superstructure for a multiproduct biorefinery from several feedstocks. The objectives of the optimization are the minimization of costs, the maximization of yields and the minimization of wastes. The Mixed Integer Nonlinear Programming (MINLP) model gives as a result the optimal allocation of feedstock and the transformation pathway for each targeted bioproduct. [Geraïli et al. \(2014\)](#) determined the optimal process among a superstructure via a Linear Programming model for a multiproduct biorefinery. Then, the process is studied further in details by simulation with complex kinetics and some operating conditions are optimized.

Some articles focused on the optimization of water and energy consumption, two of the most important operating costs in a biorefinery. Especially, Grossmann and Martín worked on the minimization of both previous criteria in first and second generation biorefinery producing bioethanol ([Ahmetović et al., 2010](#); [Čuček et al., 2011](#); [Grossmann](#)

and [Martín, 2010](#)). They proposed a two-step model that minimizes energy consumption by designing the biorefinery from a superstructure with a MINLP program, and then optimized the water supply system to minimize fresh water. They proposed a very comprehensive superstructure encompassing the new technological breakthrough in the field.

According to the previous reviews, many studies ([Geraïli et al., 2014](#); [Sammons et al., 2007, 2008](#); [Zondervan et al., 2011](#)) were conducted to create tools for the optimization and the design of biorefineries. However, they focus on different facets and are often limited to one process scale. Then in this study, we aim to go one step forward by developing a complete approach. Our method consists in a decision support tool for the design of an optimal process of a multiproduct, efficient, profitable and sustainable biorefinery. The main contribution is that the approach includes a detailed model of all the process steps thanks to a multi-scale approach. Furthermore, the methodology proposed in this paper uses economic and environmental key indicator in order to evaluate a promising bio-based molecule through the determination of the selling price related on fossil-based molecule. Moreover the multi-scale integration in the methodology allows determining the industrial potential of bio-based molecules and of microorganisms producing them.

To determine an optimal biorefinery in terms of economics and environmental evaluation, it is necessary to create a methodology in order to evaluate these indicators as accurately as possible to reflect reality. The proposed approach is based on a superstructure representing all the process alternatives for bio-product(s) production. But unfortunately, if all the scenarios are evaluated and optimized with a detailed multi-scale model, the calculation time would be tremendous so it is necessary to propose a methodology to reduce this calculation time by selecting rapidly the most promising scenarios.

The remainder of this article is structured as follows. [Section 2](#) details the different steps of the multi-scale modeling and biorefinery optimization methodology. The methodology is applied to the ABE system in [Section 3](#). [Section 4](#) highlights results and discussions on optimizing ABE production. Finally, conclusions about biobutanol production are drawn and some perspectives are proposed for future studies.

2 Methodology

In this section, the methodology is explained in details. The most important point of the proposed model is the multi-scale integration ([Belletante et al., 2016](#)): it moves from the molecular scale to the biorefinery scale, including the scale of operations and processes, and the different levels interact iteratively. The thermodynamic and microbiological data at the molecular scale are used to describe the different unit operations that make up the different phases of the process. Then, in the calculation, we use in turn the scales of molecules, unit operations, processes

and biorefineries according to the required data. This integration is illustrated in Figure 1. In addition, the approach can be used in any direction. For example, the starting point of the model can be indifferently a desired product or a specific raw material. We note that the unit operation scale is very important in the model because it represents the interactions and links between the constraints of the process scale and the experimental data extracted from the scale of the molecule. In addition, the units operation scale will be used to calculate accurate results based on a rigorous equation instead of stating assumptions as in black box or grey box approaches.

In order to explain Figure 1, we propose to follow the same workflow as in the methodology:

- 1a. Choose the potential raw material and determine its composition and physicochemical properties.
- 1b. Define the bioproducts and physicochemical properties required in relation to.
2. Make an inventory of any microorganisms that produce the necessary bioproducts.
3. Collect data on fermentation.
4. Collect thermodynamic data for the separation phase.
5. Collect thermodynamic data for the purification phase.
6. Determine the chemical compounds to be transformed into pretreatment.
7. Define the reagents for fermentation.
8. Make an inventory of any potential pretreatment transforming the raw material into reagents for fermentation.
9. Optimization with economic, environmental and energy objectives.

2.1 Strategy

In process design, generating alternatives, modeling and evaluating them is a complex problem due to the potentially high number of different combinations. Depending on the number of alternatives, *i.e.* size of the problem, and the complexity of the problem, the search of the global optimal solution is very difficult and time consuming, especially for multi-objectives optimization. Sometimes, it is even impossible to find. As a consequence, an efficient and systematic methodology is mandatory. In the area of chemical engineering, this kind of combinational process is often encountered like in computer aided molecular design or in process intensification synthesis or design. Whatever the application, the type of problem is decomposed and solved into several steps. This is particularly true for the design of biorefineries. In this paper, a methodology based on problem decomposition for finding the process optimal design is proposed. To enable the implementation of this multi-scale methodology, a six-steps method is created to achieve the optimal process, illustrated in Figure 2.

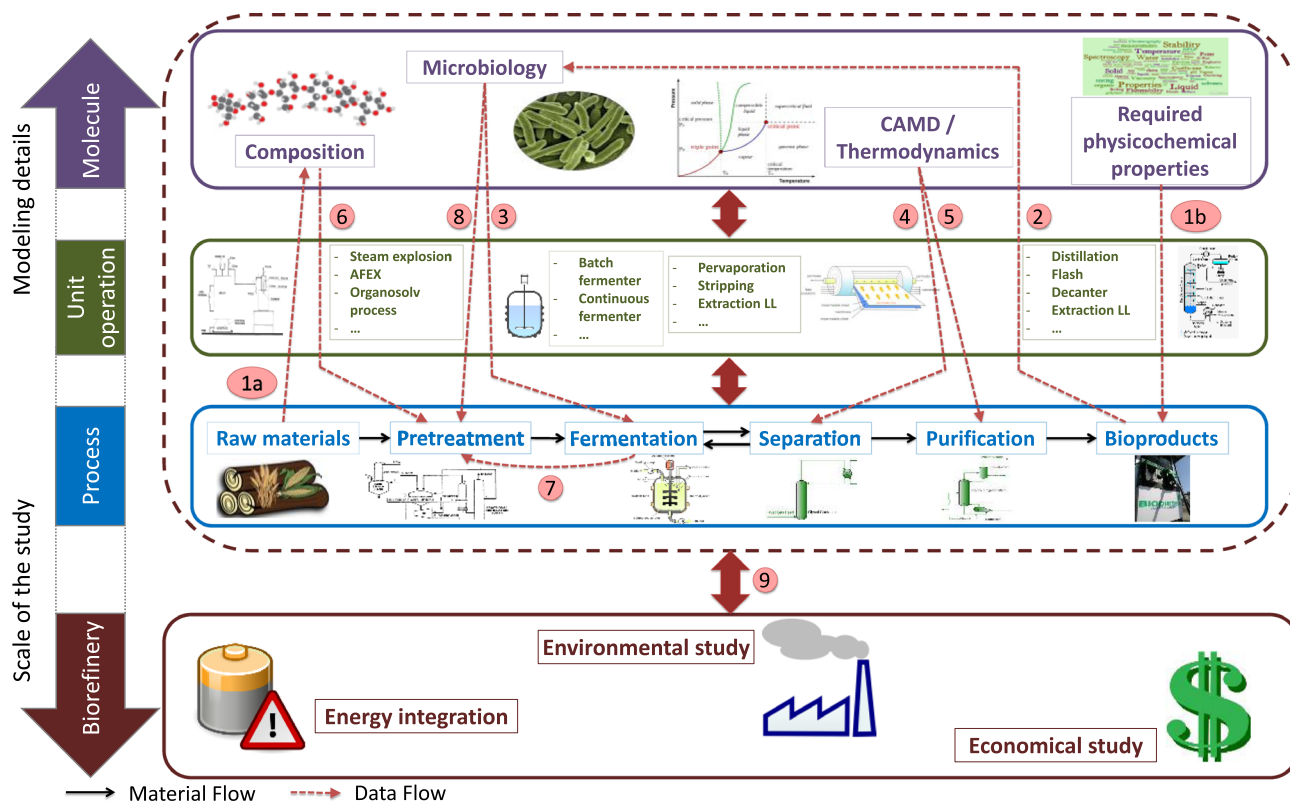

Fig. 1. Illustration of the multi-scale modeling and optimization of biorefineries.

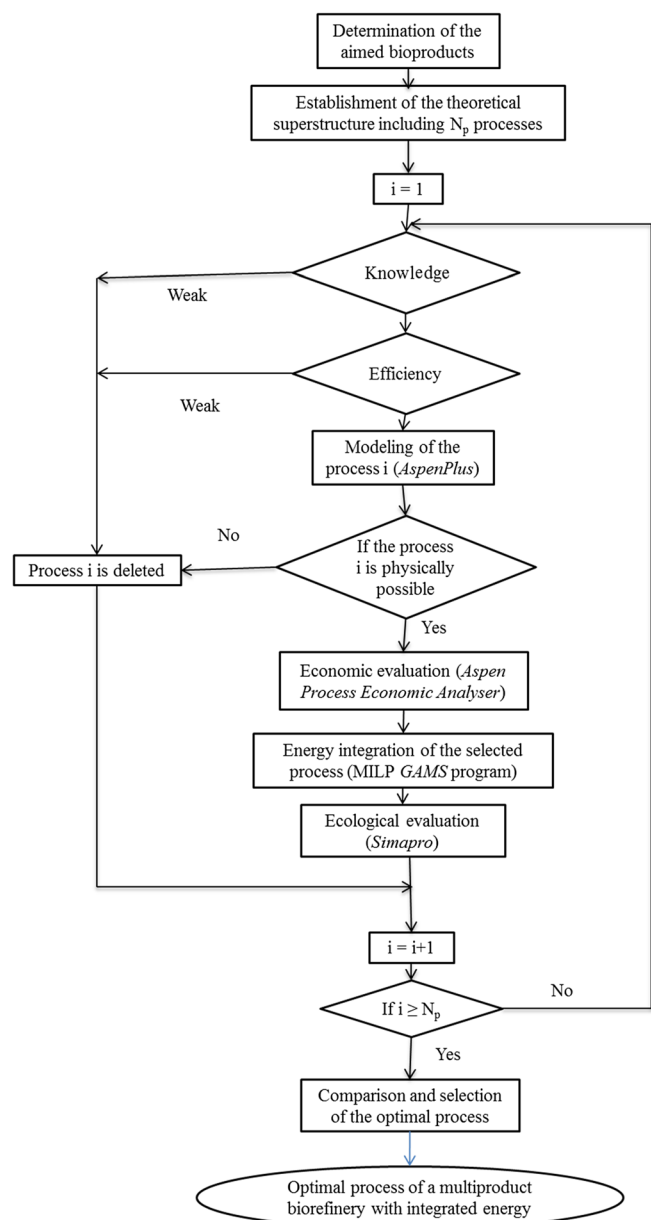

Fig. 2. Methodology diagram.

The different tools used in the methodology, e.g. Aspen, GAMS, Simapro are also specified.

The method first addresses the determination of targeted bioproducts. While at the macroscale all the biorefineries can be decomposed into the same four meta-units (*i.e.* pretreatment, fermentation, separation and purification), depending on the bioproduct different unit operations in each meta-unit must be selected and connected/interconnected (when a unit operation cannot appear without another one) to build an alternative. Then the superstructure with all the process options is generated based on user and/or expert knowledge. The superstructure represents the initial search space that will be reduced in the successive steps of the methodology. These steps sequence corresponds

to the spine of the method. As the approach is based on a multi-scale and detailed model of the process, the quality and the quantity of data and parameters needed must be guaranteed in order to obtain the optimal solution or the best compromise between criteria. All the required data and parameters, and the level of details of the model are explained on Figure 1 and described in the previous paragraph.

But currently, there is a strong research activity for improving biorefining process with a wide panel of new unit operations, operating conditions, and process configurations, for examples in Zondervan *et al.* (2011). Unfortunately, all the potential options available do not have the same level of maturity, sometimes leading to a lack of data and knowledge on the new technological device. As a result, the amount of knowledge to model as precisely as required in the methodology is not sufficient enough to consider this option. Consequently, the goal of the first test, *i.e.* knowledge on Figure 2, is to screen if all the required information, data and knowledge are available to model the current alternative with a white box approach. If it is not the case, the process engineers can add the missing elements, if not the alternative is deleted. One main idea of the methodology is that it is preferable to have a suboptimal solution (because promising alternatives could be removed due to the lack of knowledge) with a detailed model rather than an optimal solution obtained with a macroscopic model.

All feasible processes are subsequently screened by their performances. Thus energetic, productivity and carbon yield are preliminary calculated with a black box representation for unit operation. This mere and rapid evaluation permits to withdraw the less promising alternatives, because they have a too low effectiveness with respect to the previous criteria. At this step, the set of remaining process alternatives that match all the previous constraints are the feasible set of solution, *i.e.* those which can be modeled and simulated with the white box approach previously explained and detailed in a previous paper (Belletante *et al.*, 2016). During these simulations, it is sometimes impossible to identify operating conditions for some units of the process. Thus, this process alternative is removed as it cannot be physically or thermodynamically feasible. This is the major advantage of our contribution compared to the black box approach proposed by Zondervan *et al.* (2011).

Afterward, it remains only the solution that can be evaluated by the economic and environmental assessment for the identification of the optimal process option. For all the process alternatives in the final set of solutions, all the parameters, operating conditions and heat integration are fine-tuned by optimization to allow the comparison between processes and to eventually move toward to the optimal retained process. Figure 2 illustrates the complete iterative scheme of the methodology with the three inner loops that represent the different steps for removing alternatives and thus reducing the combinatory aspect of the initial problem based on a successive introduction of the three previous constraints. The general loop, *i.e.* the outer one, is activated to perform the previous described steps for all the process alternatives.

2.2 Economic evaluation

Thanks to the precise results of the process simulation, the model includes the economic evaluation of the remaining process alternatives for the biorefineries. In this study, due to new creation or production bioproduct, we fixed some economic parameters in order to decrease the financial risk. This study is made with the software Aspen Process Economic Analyser, and then the model encompasses the taxes and the depreciation. For the economic study, we fix the price of acetone to 1.1 \$/kg, the price of ethanol to 0.55 \$/kg and the butanol to 4 \$/kg (prices fixed in case the oil barrel cost is 100\$).

For all the processes of the superstructure, the calculations are made with the following hypothesis:

- The workshop life is 20 years.
- The costs of raw materials are constant.
- By-product prices are constant.
- The cost for treating liquid waste is set at 1 \$/m³.
- Depreciation rate: 12%
- Tax rate: 0.4

For further detailed studies, these parameters can be easily changed to reflect more accurately the current economic context in which the company operates.

2.3 Environmental evaluation

The objective of the ecological study is to evaluate the influence of the biorefinery on the environment. This assessment is significant in the current context of industrial ecology because chemical companies are looking for “green” plants and because of the restrictive constraints on the environment. Many impact factors exist, but our model mainly focuses on Impact 2002+ and IPCC GWP 100a. The Impact 2002+ method contains the evaluation of the human health, the ecosystem quality, the climate change and of the resources. The IPCC GWP 100a method calculates the carbon equivalent coefficient of the biorefinery. The calculations are made on the software SimaPro. SimaPro uses specific databases for the Life Cycle Assessment method. The evaluation is only based on raw materials, utilities, energy consumption, products, wastes and emissions.

3 Application to the acetone-butanol-ethanol system

The case study focuses on the production of Acetone-Butanol-Ethanol (ABE) from lignocellulosic raw materials, particularly wood. This case study illustrates the multi-scale methodology and integration for pretreatment at the process purification stage. Biobutanol is a promising product because it can replace ethanol in fuels to improve its efficiency as it provides more energy (Kumar *et al.*, 2012). It is a chemical intermediate to create higher value-added products, such as other chemicals or plastics. Currently, the most interesting bio-based pathway to produce butanol

is the fermentation Acetone-Butanol-Ethanol. Since the discovering of the ABE fermentation using *Clostridium acetobutylicum* by Pasteur in 1861, this pathway was used to product acetone and 1-butanol. However, according to the study of Niemistö *et al.* (2013), the production was industrialized in the 20th century. As soon as the development of petrochemical production, ABE fermentation was forsaken. Interest in the ABE fermentation only reappears in the 2000s.

During the 15 past years, many researchers studied the ABE fermentation according to different topics: the batch fermentation, the continuous fermentation, the coupling fermentation/separation, etc. In this fermentation, butanol is the main product, thus acetone and ethanol are byproducts. The fermentation is anaerobic, described by the following simplified reactions (Ballerini, 2006):

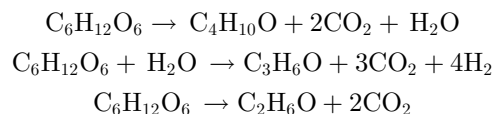

3.1 Problem description

The feedstock of the application case is woody waste from papermaker industry. Then, the aim of the biorefinery is to convert wastes in high added value products, mainly butanol, in order to create a circular economy. The biorefinery is located in southwestern France, where pine is one of the most common tree species due to its rapid growth. It is therefore chosen as raw material. The dry matter content of the pine is detailed in Table 1. To obtain a realistic industrial production, the feed rate of the raw material is set at 300 t/h.

3.2 Superstructure creation

The first step of the process concerns the pretreatment meta-unit. In many case, this phase is divided into two subsections: the pretreatment step and the hydrolysis step. The first step allows separating different components of the feedstock, and then hydrolysis produces sugars from separated components. In the same way as the study on the fermentation phase, detailed investigations are performed to determine all the possible pretreatments and hydrolysis and their operating parameters. Concerning pretreatment, several alternatives exist, for example: physical, chemical or thermal. Each type of pretreatment operates with different operating conditions: temperature, pressure, concentration, catalyst, residence time, yields, losses and degradation of components. Pretreatment is highly dependent on the nature and composition of the raw material, for example, the components of cellulosic biomass are easier to separate than those of lignocellulosic biomass. As a result, a physical pretreatment as milling is sufficient for cellulosic feedstock like barley straw and corn stover (Qureshi *et al.*, 2014). Conversely, the lignocellulosic feedstock must be milled and treated to separate lignin from sugars. This treatment can be physical such as pyrolysis, physico-chemical such as steam explosion, chemical such as ozonolysis, biological

Table 1. Dry matter content of pine (Hamelinck *et al.*, 2005) (% w/w DM).

Cellulose	Hemicellulose	Lignin	Other
44.55	21.90	27.67	5.87

such as biological oxidation or combination of pretreatments (Haghighi Mood *et al.*, 2013; Kumar *et al.*, 2009). With respect to hydrolysis, two main types exist: enzymatic hydrolysis or acid hydrolysis (Wyman *et al.*, 2005). The enzymatic hydrolysis operates under mild operating conditions but the yields of the reaction are medium and the hydrolysis medium is very dilute. On the contrary, acid hydrolysis has good yields but operates under difficult and severe operating conditions and has a significant impact on the environment.

Concerning the fermentation step, the main bacteria are *Clostridium acetobutylicum* (Kayaalp, 2013), *Clostridium beijerinckii* (Formanek *et al.*, 1997; Liew *et al.*, 2006), *Clostridium saccharobutylicum* (Lu, 2011; Law, 2010) and *Clostridium saccharoperbutylacetonicum* (Tashiro *et al.*, 2004). The second topic is the study of the operating conditions of the fermentation including the use of different natures (hexoses, pentoses, etc.) and concentrations of sugars (Kayaalp, 2013), the pH (Lee *et al.*, 2008), the temperature (Liew *et al.*, 2006), and the dilution rate (Liew *et al.*, 2006). Finally the last main topic is the coupling between fermentation and separation. Indeed butanol is an inhibitor during the fermentation (Soni *et al.*, 1987; Soucaille *et al.*, 1987), thus it is necessary to remove it from the fermentation broth to increase conversion performances. Many previous studies were focused on the comparison between different in-situ separations (Abdehagh *et al.*, 2014; Huang *et al.*, 2014; Lu, 2011; Xue, *et al.*, 2014), and others studied a specific in-situ separation. More and more in-situ separations are proposed, e.g. Pervaporation (Cai *et al.*, 2013; Van Hecke *et al.*, 2013), gas stripping (Ezeji *et al.*, 2003; Liu *et al.*, 2011; Qureshi and Blaschek, 2001; Xue *et al.*, 2013), liquid-liquid extraction (Qureshi and Maddox, 1995; Yen and Wang, 2013), Perstraction (Tanaka *et al.*, 2012), adsorption (Nielsen and Prather, 2009; Qureshi *et al.*, 2005), etc.

Concerning the last process step, *i.e.* the purification step, several alternatives are possible. We considered different distillation sequences, an adsorption step with liquid-liquid extraction or distillation.

Figure 3 summarizes the 7168 initial alternatives which are established; they represent the initial theoretical superstructure.

3.3 Final superstructure

In the next step of the methodology, all of these alternatives are first tested to determine if the technology is mature enough to have enough knowledge and data to examine it, specifically to have a detailed model of the process. If this is not the case, the alternative is removed from the superstructure. The deleted processes are in red in the

superstructure. This limits the superstructure to 3360 alternatives. A second test is then introduced, analyzing the effectiveness of the replacement solution based on preliminary calculations with a black box approach. The purpose of this test is to avoid a detailed study (with complex calculations) of an irrelevant alternative while a preliminary study eliminates this option with certainty. Therefore, the alternative is removed if its effectiveness is too low. The superstructure is then reduced to 21 alternatives. Finally, each remaining alternative in the reduced superstructure can be modeled and simulated. The last test aims to eliminate any feasible alternative according to the simulation, which limits the superstructure to 18 different processes. Energy integrations and evaluations are then carried out on these processes to allow their comparison and finally to move towards a single process. Figure 3 depicts the successive removals of alternatives and puts in highlights the final set of remaining alternatives, *i.e.* the final superstructure that gathers all the alternatives which are going to be studied in details.

The chosen pretreatment is a steam explosion with acid impregnation. Despite the degradation of lignin and the large energy consumption, the steam explosion remains a rapid and very efficient physicochemical pretreatment which can be used for all kinds of wood. In addition, it is possible to limit the energy consumption during the combustion of degraded lignin to produce energy. Then, the enzymatic hydrolysis is retained because it uses mild operating conditions: aqueous medium, temperature below 50 °C and atmospheric pressure. In addition, it is a unit operation with a low impact on the environment because the use of enzymes limits the production of polluting molecules such as acids. Currently, enzymatic hydrolysis is considered as the most ecological hydrolysis because enzymes are used as catalysts instead of chemical compounds. In addition, it improves conversion performance. The operating conditions selected for the acid vapor explosion (Tab. 2) and enzymatic hydrolysis (40 °C and 0.25 g enzymes per g of solid) were tested by Stenberg *et al.* (1998). Activated charcoal detoxification follows hydrolysis to remove impurities that may interfere with fermentation, such as furfural or hydroxymethylfurfural.

According to Table 3, from an input stream of 300 t/h of wood, only 93 t/h of sugars are produced, leading to a mass conversion ratio of 31%.

As the input flowrate in the fermentation phase is very important, this flux is divided into six similar streams that feed six parallel fermentors. This division helps to maintain production if a fermentor is contaminated, to limit the size of the equipment, to simplify mixing in fermenters and to improve process control. In pretreatment, the lignin is separated into cellulose and hemicellulose. We chose to burn the lignin in an oven to produce energy for the process. In addition, we emphasize that the boiler is the most energy supplier with a production of 319 Gcal/h. On the contrary, the oven is the most energy-consuming device with a consumption of 200 Gcal/h.

The retained bacterium is *Clostridium acetobutylicum* and operating conditions have been selected to maximize fermentation efficiency. According to Kayaalp (2013), the

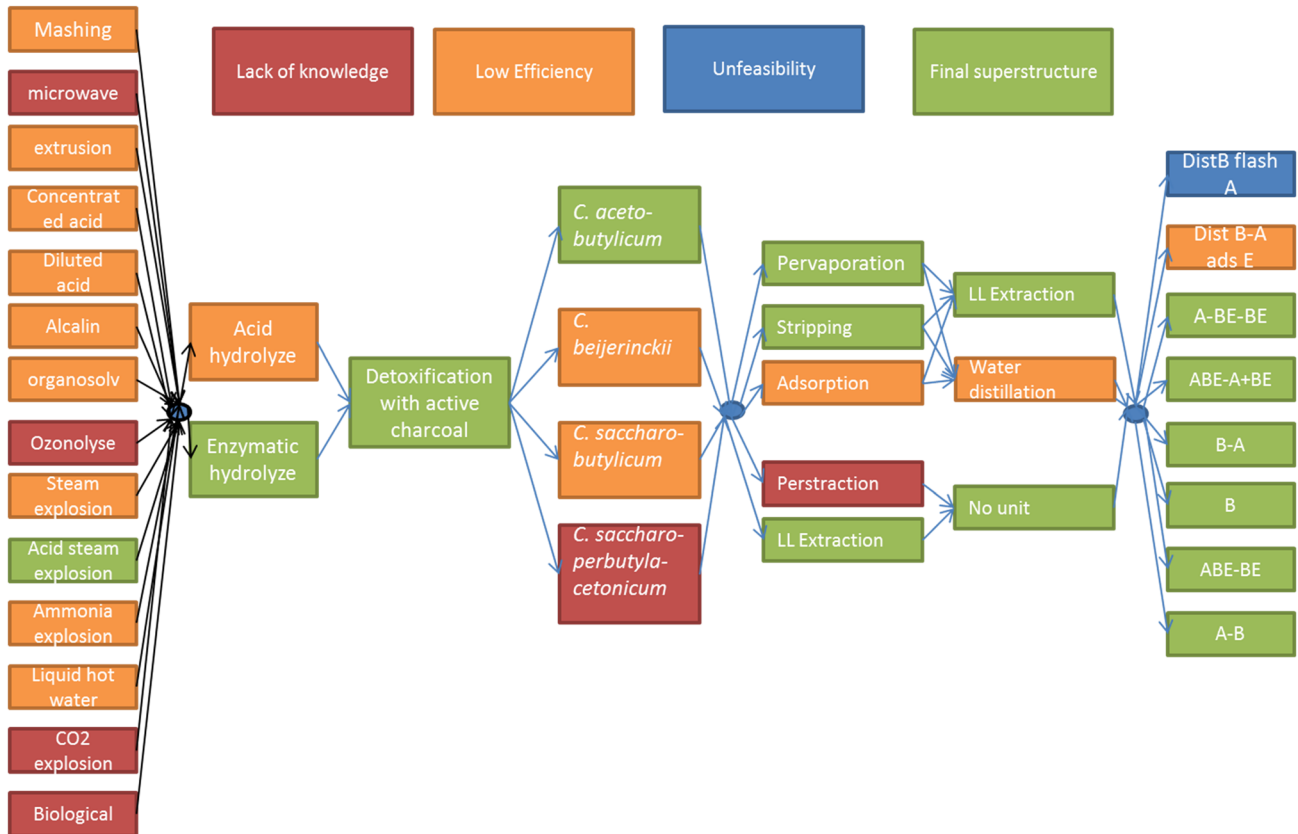

Fig. 3. Initial superstructure and successive removals.

Table 2. Operating conditions of the steam explosion pretreatment.

Operating conditions	Value
Temperature (°C)	210
Residence time (min)	5.5
Acid concentration (% w/w DM)	3.5

Table 3. Input and output streams for the pretreatment phase.

Flow	Mass flows (t/h)
Wood	300
Enzymes	40
Active charcoal	65
Medium-pressure vapor	48
High-pressure vapor	714
Input of fermentation phase (Sugars)	939 (93)

sugar concentration is set at 100 g/L in order to consume all the sugars, the temperature is set at 35 °C and nitrogen gas is added to flood the atmosphere. We opt for a new fermentation kinetics including reaction yield to simplify the

model. In order to realize the mass and energy balance, it is necessary to know the conversion reaction. It is important to note that few studies proposed this kind of equation. Fermentation reaction for hexoses conversion is (Yerushalmi, 1985):

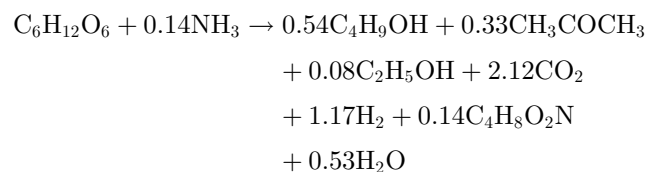

Reactions for pentoses are based on the previous reaction.

To limit inhibiting impact of butanol, a separation step is inserted at the top of the fermenter. Figure 4 described the different alternatives after pretreatment.

Whatever, the outlet stream of the coupling fermentation/ butanol recovery alternatives, the six purification possibilities for the bio-products are depicted on Figure 5.

The purification superstructure is composed of different sequences of distillations to purify products. Scenarios include the compulsory purification of butanol, and acetone and ethanol are purified or treated with liquid wastes. To consider the most unfavorable scenarios, highest industrial purities are imposed: for butanol and ethanol, we impose 99.7% w/w and for acetone 99.9% w/w. These butanol

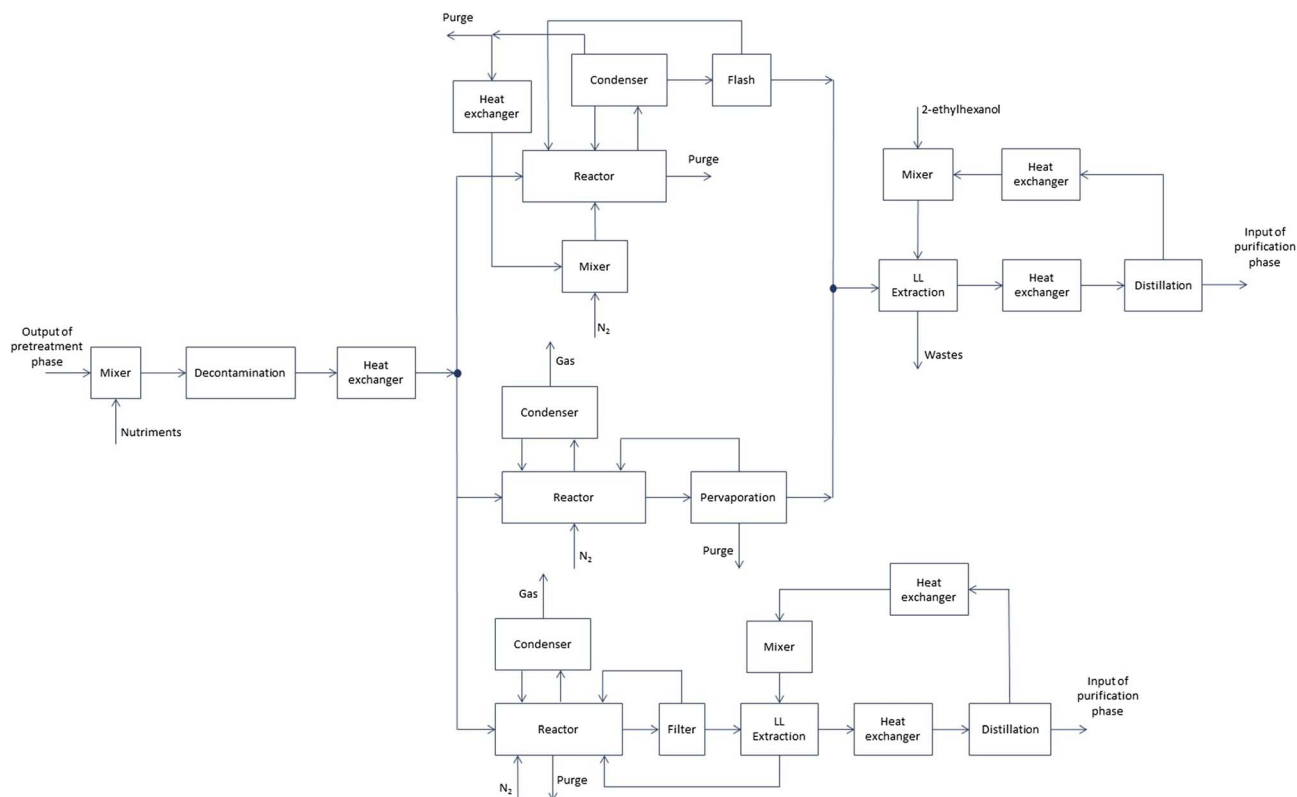

Fig. 4. Detailed superstructure for the coupling fermentation/butanol recovery scenarios.

and ethanol purities correspond to the required purities for fuels uses according to European laws. The purity of 99.9% w/w for acetone matches to the extra pure acetone in the market. Extra pure acetone is used as high quality solvent and in cosmetics industry. Finally, the superstructure contains only the promising processes, all the alternatives are modeled in details by integrating all the data at the different scales thanks to the simulation software ASPEN and with the development of specific modules e.g. for pervaporation.

4 Results and discussion

Once the model established, the operating conditions optimized and the heat integration completed for each alternative, the last step is to compare them. For each scenario, the Net Present Value and the Environmental Impact are calculated. Concerning energy integration, more explanations will be delivered in the next paragraph. The results are summarized in Figure 6. On this figure, three different zones are visualized corresponding to the three separation alternatives. In Appendix, all results are presented.

For all scenario, a weak carbon conversion ratio (Outlet/Inlet) is observed around 2.9%–6.1%. For each separation possibility, the six points on the figure correspond to the six alternatives for the butanol purification, *i.e.* distillation alternatives (cf. Fig. 5). Whatever the

separation alternative, the purification sequence has a weak influence on two indicators because the purification does not change significantly the biorefinery efficiency.

With a pervaporation separation unit, it is not possible to obtain a positive economic profit, because the production is two times less than the others alternatives. Moreover, it is difficult to estimate accurately the initial cost of the membrane due to a lack of information. We probably underestimate the real cost in particular due to the maintenance in the operational cost.

The Liquid-Liquid extraction has a low environmental impact because this separation unit consumes the low energy quantity compared to the gas stripping. Moreover, the choice of a relevant solvent permits to increase its efficiency. With an adapted solvent this separation can become competitive. To find this solvent, a perspective would be to combine our approach with a Computer Aided Molecular Design (CAMD) methodology. The gas stripping is the most promising due to the recovery process.

The alternative B (Tab. 4) is considered as the optimal point in the Pareto Front. The most promising sequence of distillation valorizes the three products. The explanation of this result is due to the low energy consumption in this step compared to the global energy consumption of the biorefinery and also to the low capital cost.

Let's go deeper with solution B to demonstrate the importance of heat integration. The goal of heat integration is to reduce utility consumption in the plant, thereby improving the economic and environmental aspects of the

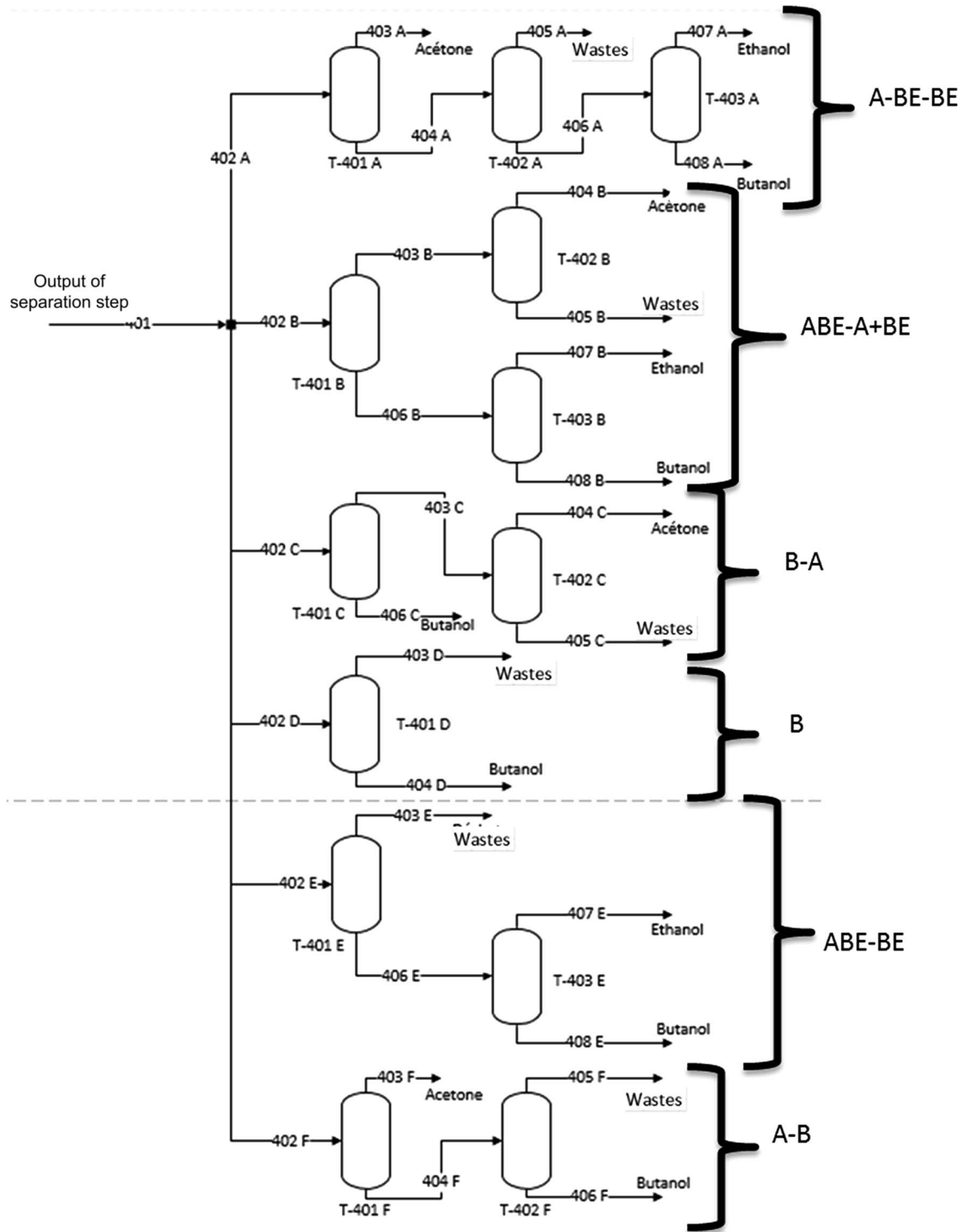

Fig. 5. Detailed superstructure for the butanol purification.

biorefinery. In fact, the reduction of the energy consumption has led to a reduction in operating costs and a reduction in the environmental impact. The model to solve is a MINLP model similar to the model of [Yee and Grossmann \(1990\)](#). However, the resolution of such a model is only possible for small size models, that is, for a number of hot and

cold flows less than 5. However, in this study, a biorefinery potentially encompasses dozens of hot and cold streams. For example, in our case study, the biorefinery contains 32 hot and 31 cold streams. One possible strategy to reduce this number of streams would be to use the methodology developed by [Rafione et al. \(2014\)](#). This methodology has

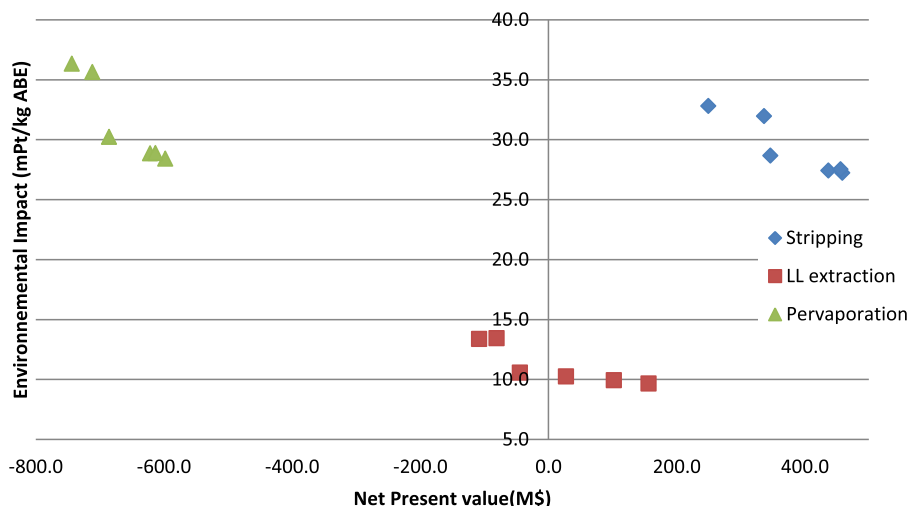

Fig. 6. Net Present Value *vs.* Environmental Impact for each alternative.

Table 4. Main results for the stripping separation.

Alternatives name	A	B	C	D	E	F
	A-BE-BE	ABE-A+BE	B-A	ABE-BE	A-B	B
Butanol Annual production ($1e^3$ t/year)	135	136	137	131	131	137
Acetone Annual production ($1e^3$ t/ year)	22	22	22	0	21	0
Ethanol Annual Production ($1e3$ t/ year)	3	2	0	2	0	0
Total Project Capital Cost with heat integration(M\$)	322	323	320	320	320	317
Total Operating Cost with heat integration (M\$/ year)	409	410	411	412	413	414
Total Product Sales (M\$/ year)	565	571	571	526	549	547
Net Present Value (M\$)	437	459	456	250	347	337
Environmental Impact (mPt/kg ABE)	27	27	28	33	29	32

determined the principal streams, namely those with very large temperature differences and those with high enthalpy. The selection is made using a multi-criteria decision support tool. Using the TOPSIS (Technique for Order of Preference by Similarity to Ideal Solution) methodology, a ranking is made for hot and cold streams. To use a MINLP model, a limit (5–6) of hot and cold streams is chosen.

However, as the biorefinery contains many identical unit operations characterized by a very high enthalpy, it is impossible to implement such a methodology. As a result, the proposed strategy is to transform the problem into a MILP formulation, that is, to no longer calculate the exchange area and the average logarithmic temperature difference. Thus, different scenarios are described by defining the number of double heat exchangers, the minimum temperature difference and the number of possible divisions per stream. For each scenario, the optimization criterion is the minimization of the sum of the utilities consumed, both hot and cold. The scenarios are compared by calculating the Net Present Value and the impact on the environment.

For the energy integration scenario, the minimum temperature difference is set at 5 °C or 10 °C, the maximum

number of stream divisions one and two, and the number of integrated heat exchangers between 10 and 30. The total cost of the energy network depends of the stream rates and the previous fixed parameters. Once the different stream rates calculated the exchange areas of the heat exchangers are estimated, then their investment costs. Thanks to the sizing, the cost of the utilities is also evaluated. Energy integration is done on the whole process. According to Table 5, whatever the scenario, energy integration can lead to a profit of at least 20%. The scenario with one division and a minimum temperature difference of 10 °C is forsaken because it has the lowest benefits while requiring the lowest investments. In other words, the heat exchanger network is less complex than for two-division scenarios or with a lower minimum temperature difference; but in turn, the consumption of utilities is higher. Scenarios with a minimum temperature difference of 5 °C seem more interesting, especially the two scenarios with 25 or 30 integration heat exchangers (gray lines in Tab. 5). The minimum temperature difference of 5 °C favors the exchange of energy. In this case, it is necessary to increase the integration because the annual operating costs are higher than the capital cost.

Table 5. Result for each scenario.

N.D.	ΔT_{\min}	N.H.E.	C.C. (M\$)	A.O.C. (M\$/year)	C.B. (%)	E.B. (%)
0	0	0	11	60	0	0
1	5	25	21.3	44.1	62.5	30.4
2	5	25	23.6	39.2	82.5	38.2
1	10	24	20.5	46.9	50.6	25.9
1	5	15	23.4	40.7	75.9	36.1
1	5	10	21.1	45.2	57.7	31
1	5	20	23.5	39.7	80.3	38.8
1	5	28	20.9	46.2	53.4	25.6
2	5	30	23.8	39.1	82.8	38.4
1	5	20	20.8	44.3	62.0	30.1
1	5	15	18.8	44.8	61.5	29.7
1	5	10	20.2	45.6	56.7	28.1
1	10	10	17.5	48.3	46.9	24.2
1	10	15	18.3	47.5	49.8	25.4
1	10	20	19.4	47.1	50.7	25.7

N.D. = Number of Divisions; N.H.E. = Number of Heat Exchanger; C.C. = Capital Cost; A.O.P. = Annual Operating Costs; C.B. = Cost Benefit; E.B. = Environmental Benefit.

Finally the optimal scenario for the production of butanol from wood is the scenario B with 25 two-streams heat exchangers (and 42 heat exchangers working with utility) and a minimum temperature difference of 5 °C.

5 Conclusion

In this paper, we propose a multi-scale methodology for the selection of the optimal design for a multiproduct biorefinery applied to the Acetone-Butanol-Ethanol system. The design of biorefineries is currently problematical in both optimal design of process and optimal biochemical pathway. Therefore, methodologies for the creation of the optimal design are necessary to estimate the industrial potential and sustainability of processes or pathways. This methodology must gather a multi-scale dimension to take into account each level of details: the molecule scale covers the microbiology and the thermodynamic dimension, the unit operation determines operating conditions, and at the process scale the process modeling and simulation calculate feasibility and accurate mass and energy balances. Finally the search of optimal process is possible at the biorefinery scale through several objectives. In this study, we explain step by step our multi-scale methodology for the optimal design of biorefineries and we apply it to the Acetone-Butanol-Ethanol system with the goal to produce biobutanol.

The methodology was carried out for general biorefineries composed of pretreatment, hydrolysis, fermentation, separation and purification phases. Interactions between scales via data flows are included to create a comprehensive and detailed methodology. The proposed method is to design the optimal process for the production of bioproducts from biosourced waste. The optimal biorefinery

is selected from a feasible superstructure of potential scenarios. Process modeling with a white box approach and rigorous simulation guarantee the feasibility of scenarios. This rigorous simulation of scenarios is coupled with a multi-objectives optimization to find a compromise between profitability, production and environmental impact. In addition, energy integration is carried out to optimize the consumption of utilities in order to reduce operating costs and the environmental impact. In addition, through the various scenarios, the method studies the importance of purification of by-products. Indeed, their purification decreases ecological indicators and provides a minimum income. The methodology is exemplified with a lignocellulosic biorefinery producing biobutanol. In the future research, it will be necessary to take account the outlet concentration variation in the fermentor. In this context, flexibility of distillation sequences plays a very important role, since the design of distillation sequences based on nominal production data may imply operation infeasibilities (*i.e.* failure to achieve desired product purity, for example) and moreover, unsustainable operation and an energy overconsumption.

Acknowledgments. This work was financially supported by ANR (the French National Research Agency) through TO the TRAVOR Project. Researcher from Indonesia side was also supported by Ministry of Research and Higher Education Republic of Indonesia for Nusantara Project to promote Indonesia-France Researchers Cooperation.

References

- Abdehagh N., Tezel F.H., Thibault J. (2014) Separation techniques in butanol production: Challenges and developments, *Biomass Bioenergy* **60**, 222–246.

- Ahmetović E., Martín M., Grossmann I.E. (2010) Optimization of energy and water consumption in corn-based ethanol plants, *Ind. Eng. Chem. Res.* **49**, 17, 7972–7982.
- Ballerini D. (2006) Chapitre 6 - La transformation de la biomasse lignocellulosique par voie biochimique, in: *Les Biocarburants : Etat des lieux, perspectives et enjeux du développement*, IFP Publication, Éd. Technip, Paris, pp. 261–306.
- Belletante S., Montastruc L., Negny S., Domenech S. (2016) Optimal design of an efficient, profitable and sustainable biorefinery producing acetone, butanol and ethanol: Influence of the in-situ separation on the purification structure, *Biochemical Eng. J.* **116**, 195–209.
- Cai D., Zhang T., Zheng J., Chang Z., Wang Z., Qin P., Tan T. (2013) Biobutanol from sweet sorghum bagasse hydrolysate by a hybrid pervaporation process, *Bioresour. Technol.* **145**, 97–102.
- Cherubini F. (2010) The biorefinery concept: Using biomass instead of oil for producing energy and chemicals, *Energy Convers. Manag.* **51**, 7, 1412–1421.
- Čuček L., Martín M., Grossmann I.E., Kravanja Z. (2011) Energy, water and process technologies integration for the simultaneous production of ethanol and food from the entire corn plant, *Comput. Chem. Eng.* **35**, 8, 1547–1557.
- Domine M.E., Marinas A., Sheldon R.A. (2015) Biomass valorization into fuels, energy, materials and chemicals (UBIOCHEM-IV), *Catal. Today* **257**, Part 2, 151–153.
- Ezeji T.C., Qureshi N., Blaschek H.P. (2003) Production of acetone, butanol and ethanol by *Clostridium beijerinckii* BA101 and *in situ* recovery by gas stripping, *World J. Microbiol. Biotechnol.* **19**, 6, 595–603.
- Formanek J., Mackie R., Blaschek H.P. (1997) Enhanced butanol production by *Clostridium beijerinckii* BA101 grown in semidefined P2 medium containing 6 percent maltodextrin or glucose, *Appl. Environ. Microbiol.* **63**, 6, 2306–2310.
- Geraili A., Sharma P., Romagnoli J.A. (2014) A modeling framework for design of nonlinear renewable energy systems through integrated simulation modeling and metaheuristic optimization: Applications to biorefineries, *Comput. Chem. Eng.* **61**, 102–117.
- Grossmann I.E., Martín M. (2010) Energy and water optimization in biofuel plants, *Chin. J. Chem. Eng.* **18**, 6, 914–922.
- Haghighi Mood S., Hossein Golfeshan A., Tabatabaei M., Salehi Jouzani G., Najafi G.H., Gholami M., Ardjmand M. (2013) Lignocellulosic biomass to bioethanol, a comprehensive review with a focus on pretreatment, *Renew. Sustain. Energy Rev.* **27**, 77–93.
- Hamelinck C.N., Van Hooijdonk G., Faaij A.P. (2005) Ethanol from lignocellulosic biomass: techno-economic performance in short-, middle- and long-term, *Biomass Bioenergy* **28**, 4, 384–410.
- Harmsen P.F.H., Hackmann M.M., Bos H.L. (2014) Green building blocks for bio-based plastics, *Biofuels Bioprod. Biorefining* **8**, 3, 306–324.
- Huang H.-J., Ramaswamy S., Liu Y. (2014) Separation and purification of biobutanol during bioconversion of biomass, *Sep. Purif. Technol.* **132**, 513–540.
- Kayaalp U. (2013) Two stage ABE fermentation with *in situ* pervaporation and high cell density, *Dissertation*, Faculdade de Ciências e Tecnologia, Universidade Nova de Lisboa.
- Kumar P., Barrett D.M., Delwiche M.J., Stroeve P. (2009) Methods for Pretreatment of Lignocellulosic Biomass for Efficient Hydrolysis and Biofuel Production, *Ind. Eng. Chem. Res.* **48**, 8, 3713–3729.
- Kumar M., Goyal Y., Sarkar A., Gayen K. (2012) Comparative economic assessment of ABE fermentation based on cellulosic and non-cellulosic feedstocks, *Appl. Energy* **93**, 193–204.
- Law L. (2010) Production of biobutanol from white grape pomace by *Clostridium saccharobutylicum* using submerged fermentation, *Thesis*, Auckland University of Technology.
- Lee S.Y., Park J.H., Jang S.H., Nielsen L.K., Kim J., Jung K.S. (2008) Fermentative butanol production by Clostridia, *Biotechnol. Bioeng.* **101**, 2, 209–228.
- Liew S.T., Arbakariya A., Rosfarizan M., Raha A.R. (2006) Production of Solvent (acetone-butanol-ethanol) in Continuous Fermentation by *Clostridium saccharobutylicum* DSM 13864 Using Gelatinised Sago Starch as a Carbon Source, *Malays. J. Microbiol.* **2**, 2, 42–50.
- Liu G., Wei W., Wu H., Dong X., Jiang M., Jin W. (2011) Pervaporation performance of PDMS/ceramic composite membrane in acetone butanol ethanol (ABE) fermentation–PV coupled process, *J. Membr. Sci.* **373**, 1–2, 121–129.
- Lu C. (2011) Butanol Production from Lignocellulosic Feedstocks by Acetone-Butanol-Ethanol Fermentation with Integrated Product Recovery, *PhD Thesis*, The Ohio State University.
- Moncada J., Matallana L.G., Cardona C.A. (2013) Selection of process pathways for biorefinery design using optimization tools: A Colombian case for conversion of sugarcane bagasse to ethanol, Poly-3-hydroxybutyrate (PHB), and energy, *Ind. Eng. Chem. Res.* **52**, 7, 4132–4145.
- Nielsen D.R., Prather K.J. (2009) *In situ* product recovery of n-butanol using polymeric resins, *Biotechnol. Bioeng.* **102**, 3, 811–821.
- Niemistö J., Saavalainen P., Isomäki R., Kolli T., Huuhtanen M., Keiski R.L. (2013) Biobutanol production from biomass, in: V.K. Gupta, M.G. Tuohy (eds), *Biofuel technologies*, Springer, Berlin Heidelberg, pp. 443–470.
- Pham V., El-Halwagi M. (2012) Process synthesis and optimization of biorefinery configurations, *AIChE J.* **58**, 4, 1212–1221.
- Qureshi N., Blaschek H.P. (2001) Recovery of butanol from fermentation broth by gas stripping, *Renew. Energy* **22**, 4, 557–564.
- Qureshi N., Maddox I.S. (1995) Continuous production of acetone-butanol-ethanol using immobilized cells of *Clostridium acetobutylicum* and integration with product removal by liquid-liquid extraction, *J. Ferment. Bioeng.* **80**, 2, 185–189.
- Qureshi N., Hughes S., Maddox I.S., Cotta M.A. (2005) Energy-efficient recovery of butanol from model solutions and fermentation broth by adsorption, *Bioprocess Biosyst. Eng.* **27**, 4, 215–222.
- Qureshi N., Cotta M.A., Saha B.C. (2014) Bioconversion of barley straw and corn stover to butanol (a biofuel) in integrated fermentation and simultaneous product recovery bioreactors, *Food Bioprod. Process.* **92**, 3, 298–308.
- Rafione T., Marinova M., Montastruc L., Paris J. (2014) The green integrated forest biorefinery: An innovative concept for the pulp and paper mills, *Applied Thermal Engineering* **73**, 1, 74–81.
- Sammons N., Eden M., Yuan W., Cullinan H., Aksoy B. (2007) A flexible framework for optimal biorefinery product allocation, *Environ. Prog.* **26**, 4, 349–354.
- Sammons N.E. Jr, Yuan W., Eden M.R., Aksoy B., Cullinan H.T. (2008) Optimal biorefinery product allocation by combing process and economic modeling, *Chem. Eng. Res. Des.* **86**, 7, 800–808.
- Soni B.K., Das D.K., Ghose T.K. (1987) Inhibitory factors involved in acetone-butanol fermentation by *Clostridium saccharoperbutylacetonicum*, *Curr. Microbiol.* **16**, 2, 61–67.

- Soucaille P., Joliff G., Izard A., Goma G. (1987) Butanol tolerance and autobacteriocin production by *Clostridium acetobutylicum*, *Curr. Microbiol.* **14**, 295–299.
- Stenberg K., Tengborg C., Galbe M., Zacchi G. (1998) Optimisation of steam pretreatment of SO₂-impregnated mixed softwoods for ethanol production, *J. Chem. Technol. Biotechnol.* **71**, 4, 299–308.
- Tanaka S., Tashiro Y., Kobayashi G., Ikegami T., Negishi H., Sakaki K. (2012) Membrane-assisted extractive butanol fermentation by *Clostridium saccharoperbutylacetonicum* N1–4 with 1-dodecanol as the extractant, *Bioresour. Technol.* **116**, 448–452.
- Tashiro Y., Takeda K., Kobayashi G., Sonomoto K., Ishizaki A., Yoshino S. (2004) High butanol production by *Clostridium saccharoperbutylacetonicum* N1–4 in fed-batch culture with pH-Stat continuous butyric acid and glucose feeding method, *J. Biosci. Bioeng.* **98**, 4, 263–268.
- Van Hecke W., Hofmann T., De Wever H. (2013) Pervaporative recovery of ABE during continuous cultivation: Enhancement of performance, *Bioresour. Technol.* **129**, 421–429.
- Werpy T., Petersen G. (2004) *Top value added chemicals from biomass: Volume I – Results of screening for potential candidates from sugars and synthesis gas; DOE/GO-102004-1992*, National Renewable Energy Lab, Golden, CO, USA.
- Wyman C.E., Decker S.R., Himmel M.E., Brady J.W., Skopec C.E., et al. (2005) Hydrolysis of cellulose and hemicellulose, *Polysacch. Struct. Divers. Funct. Versatility* **1**, 1023–1062.
- Xue C., Zhao J., Liu F., Lu C., Yang S.-T., Bai F.-W. (2013) Two-stage *in situ* gas stripping for enhanced butanol fermentation and energy-saving product recovery, *Bioresour. Technol.* **135**, 396–402.
- Xue C., Zhao J.-B., Chen L.-J., Bai F.-W., Yang S.-T., Sun J.-X. (2014) Integrated butanol recovery for an advanced biofuel: Current state and prospects, *Appl. Microbiol. Biotechnol.* **98**, 8, 3463–3474.
- Yee T.E., Grossmann I.E. (1990) Simultaneous optimization models for heat integration–II. Heat exchanger network synthesis, *Computers Chem. Eng.* **14**, 10, 1165–1184.
- Yen H.-W., Wang Y.-C. (2013) The enhancement of butanol production by *in situ* butanol removal using biodiesel extraction in the fermentation of ABE (acetone–butanol–ethanol), *Bioresour. Technol.* **145**, 224–228.
- Yerushalmi L. (1985) Physiological aspects of the acetone–butanol fermentation, *PHD Thesis*, McGill University, Montreal, Canada, 430 p.
- Zondervan E., Nawaz M., de Haan A.B., Woodley J.M., Gani R. (2011) Optimal design of a multi-product biorefinery system, *Comput. Chem. Eng.* **35**, 9, 1752–1766.

