



HAL
open science

Comparative study of tow buckling defect during preforming of structural composites based on vegetable fibers

Mohamed Medhat Salem, Marina Fazzini, Pierre Ouagne

► **To cite this version:**

Mohamed Medhat Salem, Marina Fazzini, Pierre Ouagne. Comparative study of tow buckling defect during preforming of structural composites based on vegetable fibers. International Conference on Structural Analysis of Advanced Materials, Aug 2018, Tarbes, France. pp.030014, 10.1063/1.5024164 . hal-02487097

HAL Id: hal-02487097

<https://hal.science/hal-02487097>

Submitted on 21 Feb 2020

HAL is a multi-disciplinary open access archive for the deposit and dissemination of scientific research documents, whether they are published or not. The documents may come from teaching and research institutions in France or abroad, or from public or private research centers.

L'archive ouverte pluridisciplinaire **HAL**, est destinée au dépôt et à la diffusion de documents scientifiques de niveau recherche, publiés ou non, émanant des établissements d'enseignement et de recherche français ou étrangers, des laboratoires publics ou privés.



Open Archive Toulouse Archive Ouverte

OATAO is an open access repository that collects the work of Toulouse researchers and makes it freely available over the web where possible

This is an author's version published in: <http://oatao.univ-toulouse.fr/23568>

To cite this version:

Salem, Mohamed Medhat[✉] and Fazzini, Marina[✉] and Ouagne, Pierre[✉] *Comparative study of tow buckling defect during preforming of structural composites based on vegetable fibers.* (2018) In: International Conference on Structural Analysis of Advanced Materials, 28 August 2018 - 31 August 2018 (Tarbes, France).

Any correspondence concerning this service should be sent to the repository administrator: tech-oatao@listes-diff.inp-toulouse.fr

Comparative Study Of Tow Buckling Defect During Preforming Of Structural Composites Based On Vegetable Fibers

Mohamed Salem^{1, b)}, Marina Fazzini^{1, a)} and Pierre Ouagne^{1, c)}

¹Laboratoire Génie de Production (LGP), INP-ENIT, Univ. de Toulouse, Tarbes, France.

^{a)} Corresponding author: marina.fazzini@enit.fr

^{b)} mohamed-medhat.salem@enit.fr

^{c)} pierre.ouagne@enit.fr

Abstract. During the complex shape forming of composite fibrous reinforcement, the planar bending of roving tows results in an out-of-plane deflection, along with a rotation on its central axis. The need to accurately follow and quantify the mechanism of formation of such defect has led us to consider two 3D imaging techniques, of which, have been tested and compared in this work.

INTRODUCTION

Seventy percent of parts of the automotive sector are metallic and relate to structural and semi-structural parts. A double ecological approach (reduction of the mass of the parts to reduce CO₂ emissions and recyclability of materials) justifies the choice of composite materials with bidirectional reinforcements in natural fibers to replace these metallic materials.

The feasibility of manufacturing complex and specific geometry, such as structural parts, without defects, by a process with a high cost / production rate / accessible shape ratio, such as reinforcement stamping, is a major scientific challenge. This feasibility depends on the geometries of the shapes to be produced, but also on the architectures of the reinforcing textile at macroscopic and mesoscopic scales.

If some defects, such as wrinkles may appear in the shaping of technical textiles, have been extensively studied [1-3], it is not the same for the tow buckling defects leading to gaps and discontinuities in the reinforcing fiber structure [4,5].

This paper will propose a study of these tow buckling defects detected with different optical systems such as the Stereo-DIC and focus-variation microscopy. When the last technique make it possible to reconstruct a relief with a very good resolution and accuracy, the first one allows in addition, to access to the displacement and strain undergone by each point of the measured surface. The defect is studied independently of the process with a device specially designed. The experimental set-up will make it possible to carry out a multi-scale kinematic analysis of the tow buckling phenomenon in estimating the height and elevation profile of the buckle and the strains undergone by the fibers.

EXPERIMENTAL SET UP

Tow Buckling Device

The buckling defect is mainly the result of a combination between the bending of tows in their plane and level of tension applied to the tows perpendicular to the ones showing the buckles. A device has therefore been designed to impose separately in-plane bending angles to the tows showing the buckles and variable tensions in the perpendicular tows. The design of the mechanical part of the device was described into details in [5] and is summarized in Fig. 1.

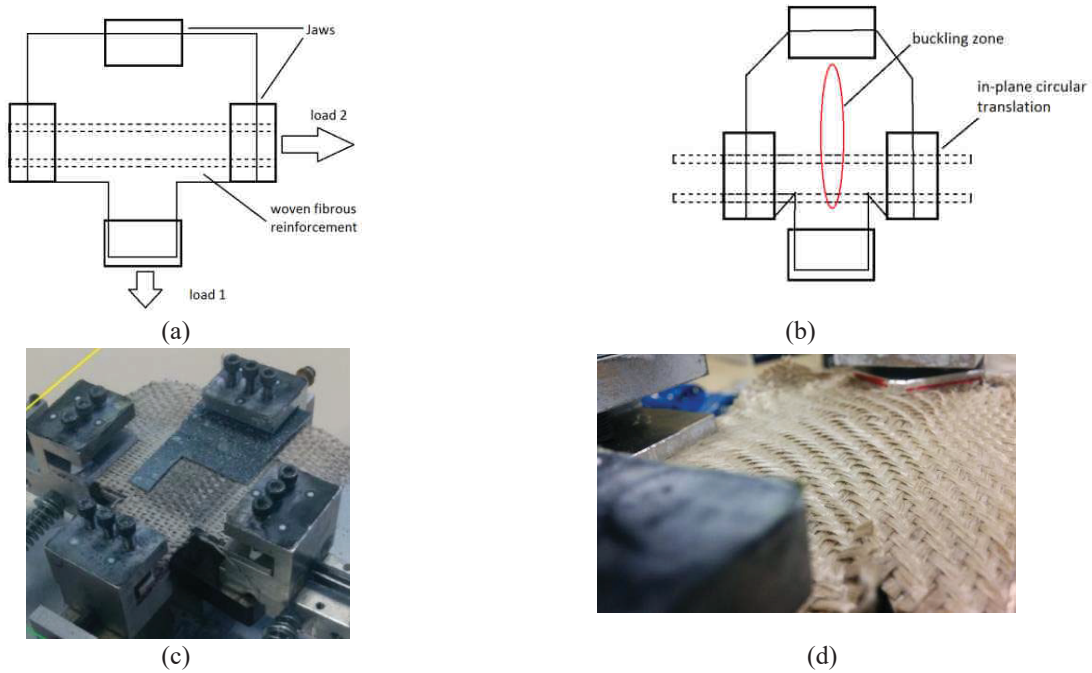

FIGURE 1. Principle of the tow buckling device

The device is instrumented with load sensors and DIC (Digital image correlation) system. The geometry of the samples is adapted to maximize the buckling zone. The samples are maintained by jaws in two directions with different tensions. (300N for the load 1 and 20N for the load 2).

The jaws which make it possible to apply the load 2 undergo an in-plane circular translation (Fig. 1. (b)).

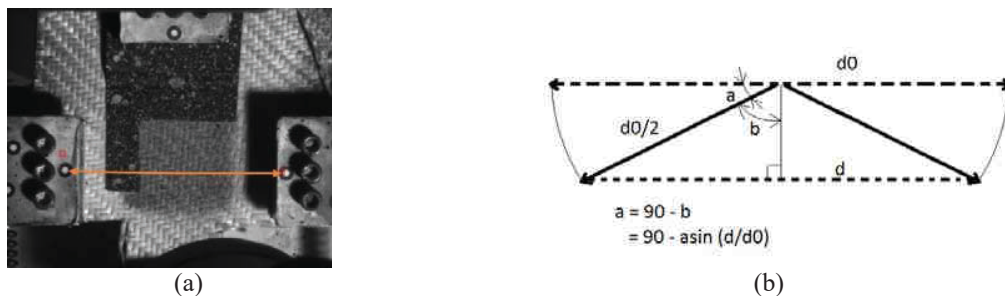

FIGURE 2. Bending angle measurement

By using DIC with one camera and the software GOM ARAMIS®, it is possible to follow the displacement of the jaws and then estimate the angle of curvature of the bended tows. Markers are glued on the jaws and the DIC software will allow to follow their movements in the plane and the evolution of the distance between them. The bending angle can be calculated from this distance (Fig. 2).

Measurement systems

Stereo-DIC

The stereo-correlation (SDIC) system used is composed of two digital cameras capable of capturing twelve images per second associated with the software GOM ARAMIS ®. Stereo correlation is a full field measurement method that combines digital image correlation (DIC) and stereovision.

The DIC makes it possible to determine on plane displacement of a planar object by recording an image at each state of deformation of this object. Given two images corresponding to two deformation states of an object, to determine the correspondent of a point and its signature of the first image in the second, a similarity function is used. In practice, a single value is not the unique signature of a point, hence neighboring pixels are used. The matching of images acquired by only one camera, at different times, on an object which becomes deformed is called temporal matching, or tracking. From its principle, the correlation technique can function correctly only with objects having a surface with a sufficiently random texture. If the object is not naturally textured or if its texture is not sufficiently discriminating, various techniques exist to allow the use of correlation (paint projection).

Stereovision is based on the principle that the depth information (3D) can be obtained by triangulation starting from two images having a common part in their field of sight. Obtaining this data involves the calibration of the stereoscopic vision sensor. The calibration of a camera is an important stage in dimensional metrology by artificial vision. Calibrating a camera consists in determining its intrinsic parameters. Calibrating a stereovision sensor made up of two dependent cameras involves determining the intrinsic parameters of each camera, as well as the position and relative orientation of both cameras. These calibration parameters are necessary to calculate, by triangulation, the three-dimensional co-ordinates of a point corresponding to pixels matched in the two images. The matching of two acquired images, at a given moment, by two dependent stereoscopic cameras is called matching by stereo-correlation. The measurement of 3D displacement fields using stereovision implements simultaneously a temporal matching technique and a stereo-correlation matching. The correlation technique can also be used to seek stereo-correspondants starting from a pair of stereoscopic images. Note that an essential difference distinguishes temporal matching by correlation from matching by stereo-correlation: in the case of the stereovision, there is a geometrical constraint known as epipolar which can guide research into the stereo-correspondant.

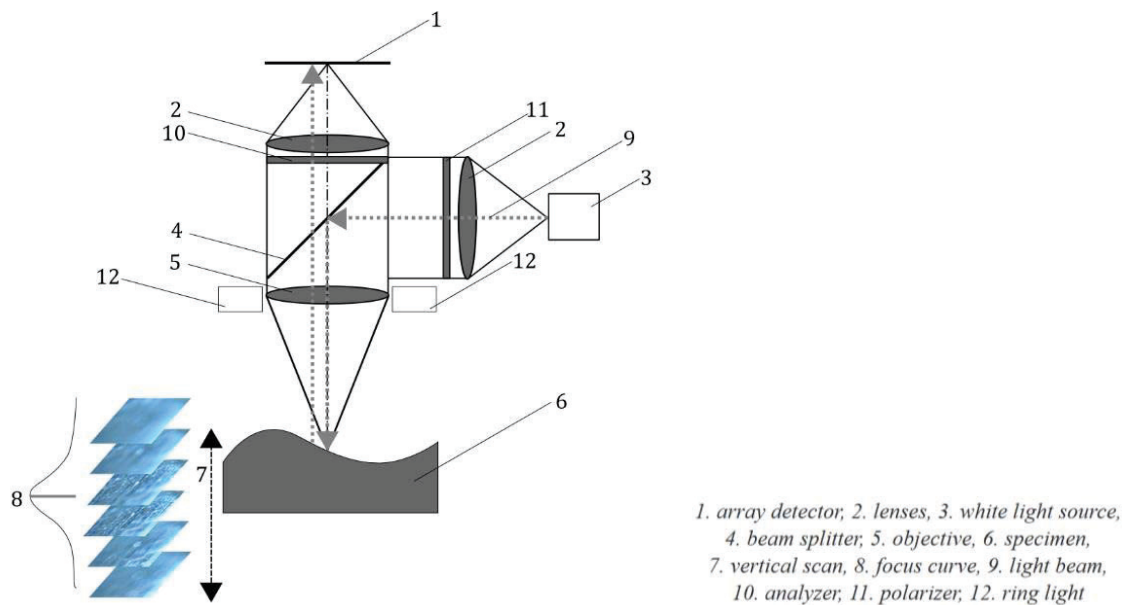

FIGURE 3. Schematic diagram of a typical measurement device based on focus variation [6]

The microscope used is an InfiniteFocus, Alicona ®. It is a topography measurement system that uses the principle of focus variation. This system captures images of the surface to be measured by varying the focal length. Thanks to a contour detection algorithm, the image corresponding to the best focus is selected for each point on the surface. It is then possible to connect the image to the focal distance and therefore to the relief of the surface.

The schematic diagram of the focus variation microscope is shown in Fig. 3.

RESULTS

The tests were performed on two types of textiles. Both are linen. The first is a sized up linen, Serge 2x2 and the second is a desized linen, plain weave (B). Fig. 4 illustrates these two textiles.



FIGURE 4. Textiles used – (a) Sized up linen, Serge 2x2, (b) desized linen, plain weave (B)

Taking into account the peculiar nature of the reinforcement, two major problems had to be overcome to fully use the stereo-correlation. The first problem was the abundant stray fibers and fiber ends that poke out of linen reinforcement. These fibers are so fine that they blend in the plane of the reinforcement while they are several millimeters out-of-plane. This led to a several decorrelation across the surface and required the reinforcement to be shaved down. The second problem was that the linen fiber was overly reflective. A thin layer of white revealing powder was applied to decrease the reflection and a light black speckle was applied on top by paint spray cans to make the contrast needed for the correlation.

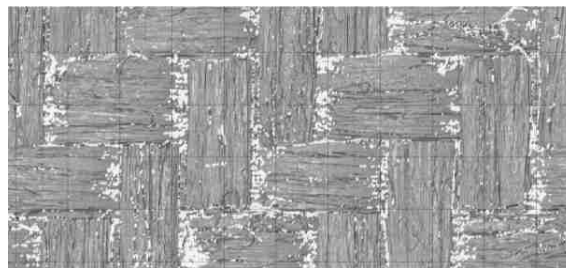

FIGURE 5. Reconstructed surface obtained by focus-variation microscopy

During the buckling process, tow's bending leads to a displacement of transversal tows, while longitudinal tows will remain still. Tows will overlap and cover parts of the preexisting speckles while also leading to the appearance of speckle-less areas. This will eventually cause the loss of correlated information overtime.

Focus-variation microscopy eliminates the need of a speckle. The transcribed surface is much more accurate with 100nm of vertical resolution for the confocal microscope against 21µm for the stereo-correlation.

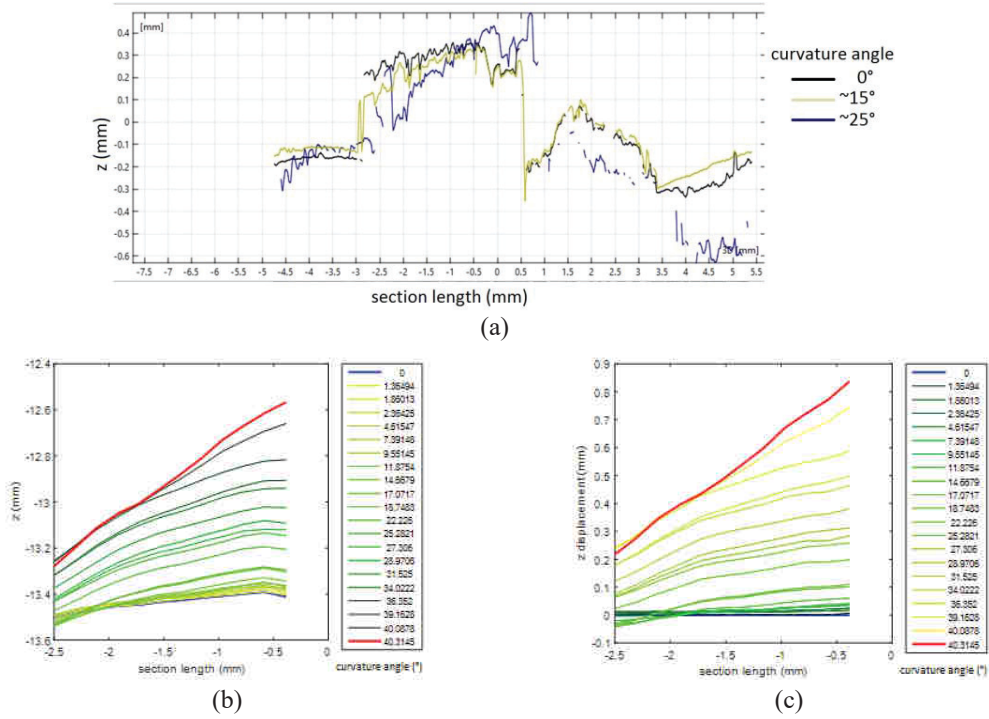

FIGURE 6. Profile of a tow of sized up serge 2x2 obtained by focus variation microscopy (a) and SDIC (b) for different curvature angles. Out of plane displacements of the tow obtained by SDIC (c).

The microscope offers a great accuracy in the reproduction of the surface, as the Fig.5 shows, the shape of the section is clearly defined and offers precise pinpoint 3D localization of each point. Yet going from step to step is a more difficult endeavor. Taking into consideration that the microscope has no meaning of following the displacement and the complex kinetic of the tow's deflection coupled with the rotation involved in the buckle's formation, it is extremely difficult to get the displacement out of the acquired data curves, that were by default aligned in the graphs using the best fit method which will try to negate the displacement in certain cases (Fig.7). On the other hand, the stereo-correlation setup provides us with both the shape and the displacement of each correlated point as shown by Fig.6 (b), Fig.6 (c), Fig.7 (b) and Fig.7 (c). The displacement is crucial in a future experimental design to be able to predict the formation of a buckle, while the shape of the tow is of interest since early experimentation suggests that the initial layout of the tow seems to influence the final maximum elevation.

TABLE 1. Maximum elevation and rotation measured by stereo-DIC and microscopy for both textiles

Reinforcement	Curvature angle (°)	Maximum elevation (mm)		Rotation	
		SDIC	Microscopy	SDIC	Microscopy
Sized up serge 2x2	25	0.26	0.3	5.24	6.51
Linen plain weave (B)	35	0.69	0.72	12.7	14.1

Still, with both techniques shortcomings, the comparison between the two is pretty interesting. By recentering results and aligning the steps of microscopes graph (releve de surface microscope diapo 6 et 7) around the lower tows, which variations are less prominent than the upper buckling tows, we are able to get an idea of the displacement and rotation of the buckle. The results of both setups are displayed in the **TABLE 1**.

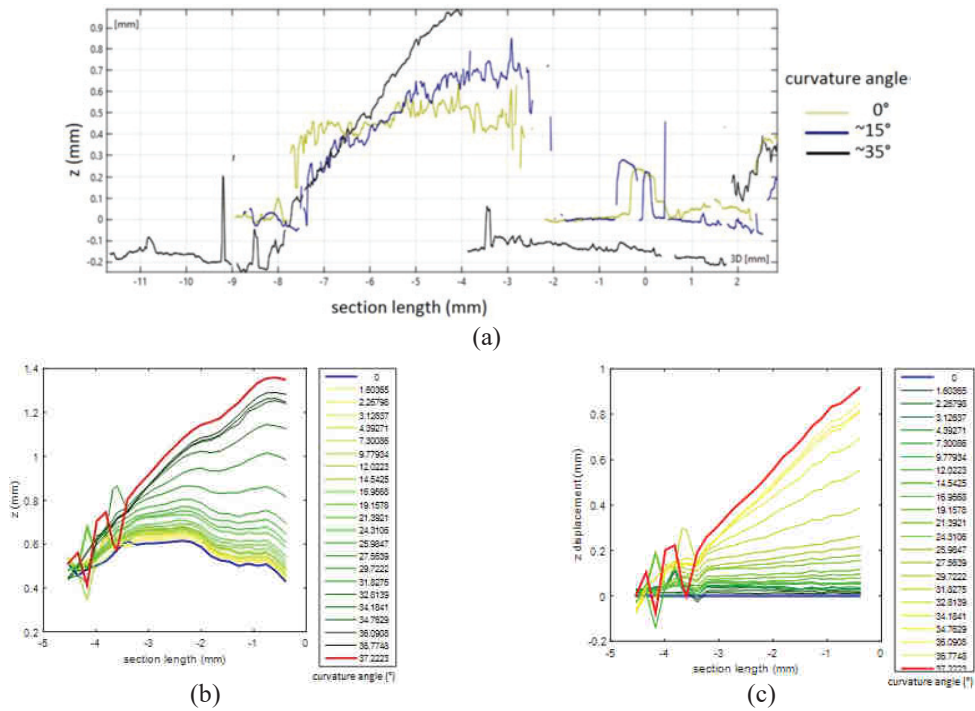

FIGURE 7. Profile of a tow of linen plain weave (B) obtained by focus variation microscopy (a) and SDIC (b) for different curvature angles. Out of plane displacements of the tow obtained by SDIC (c).

By comparison, the recorded values with both setups are fairly similar and from the same order of magnitude with small differences that were expected, since the same experimental conditions couldn't be exactly replicated in both setups. This allows us to validate the results obtained from the SDIC.

While the variable focal microscope is able to provide a fairly accurate recreation of the surface, the amount of data that are available in the stereo-correlation, the relative accuracy and time effectiveness makes it a more convenient choice for the measurements. In future work, it is to be compared with the fringe projection technique.

Plotting the maximum elevation and angle of rotation of the tow versus the curvature angle as shown in Fig.8 gives us an idea of the kinetic involved the formation of the buckle and shows us the influence of the contecture of the reinforcement. While the plain weave has larger tows than the serge, they deflect less and rotate less due to the lack of unsupported length.

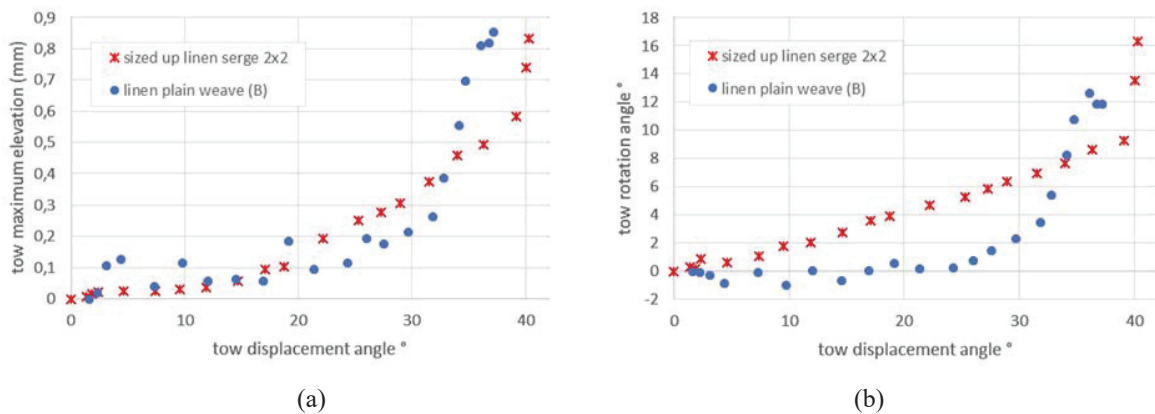

FIGURE 8. Maximum elevation (a) and angle rotation of the tow (b) as a function of the curvature angle.

CONCLUSIONS

By comparison, the recorded values with both setups are fairly similar and from the same order of magnitude. The small differences were expected since the same experimental conditions couldn't be exactly replicated in both setups.

While the confocal microscope is able to provide a fairly accurate recreation of the surface, the amount of data that are available in the stereo-correlation and the relative accuracy makes it a more convenient choice for the measurements. In future work, it is to be compared with the fringe projection technique.

REFERENCES

1. T. Gereke, O. Döbrich, M. Hübner, C. Cherif, *Experimental and computational composite textile reinforcement forming: a review*, (*Composites: Part A*, 46, 2013), pp. 1–10.
2. L.D. Bloom, J. Wang, K.D. Potter, *Damage progression and defect sensitivity: an experimental study of representative wrinkles in tension*, (*Composites: Part B*, 45, 2013), pp. 449–458.
3. J. Lee, S. Hong, W. Yu, T. Kang, *The effect of blank holder force on the stamp forming behavior of non-crimp fabric with a chain stitch*, (*Compos Sci Technol*, 67, 2007), pp. 357–366.
4. P. Ouagne, D. Soulat, G. Hivet, S. Allaoui, D. Duriatti, *Analysis of defects during the preforming of a woven flax*, (*Adv Compos Lett*, 20, 2011), pp. 105–108.
5. C. Tephany, J. Gillibert, P. Ouagne, G. Hivet, S. Allaoui, D. Soulat, *Development of an experimental bench to reproduce the tow buckling defect appearing during the complex shape forming of structural flax based woven composite reinforcements*, (*Composites Part A*, 81, 2016), pp. 22-33.
6. R. Danzl, F. Helmlí, S. Scherer, *Focus Variation – a Robust Technology for High Resolution Optical 3D Surface Metrology*, (*Journal of Mechanical Engineering*, 57, 2011) 3, pp. 245-256.