



HAL
open science

Impact of cyclic mechanical compression on the electrical contact resistance between the gas diffusion layer and the bipolar plate of a polymer electrolyte membrane fuel cell

Khadidja Bouziane, El Mahdi Khetabi, Rémy Lachat, Nada Zamel, Yann Meyer, Denis Candusso

► To cite this version:

Khadidja Bouziane, El Mahdi Khetabi, Rémy Lachat, Nada Zamel, Yann Meyer, et al.. Impact of cyclic mechanical compression on the electrical contact resistance between the gas diffusion layer and the bipolar plate of a polymer electrolyte membrane fuel cell. *Renewable Energy*, 2020, 153, pp. 349-361. 10.1016/j.renene.2020.02.033 . hal-02484247

HAL Id: hal-02484247

<https://hal.science/hal-02484247v1>

Submitted on 25 Feb 2020

HAL is a multi-disciplinary open access archive for the deposit and dissemination of scientific research documents, whether they are published or not. The documents may come from teaching and research institutions in France or abroad, or from public or private research centers.

L'archive ouverte pluridisciplinaire **HAL**, est destinée au dépôt et à la diffusion de documents scientifiques de niveau recherche, publiés ou non, émanant des établissements d'enseignement et de recherche français ou étrangers, des laboratoires publics ou privés.

Impact of cyclic mechanical compression on the electrical contact resistance between the gas diffusion layer and the bipolar plate of a polymer electrolyte membrane fuel cell.

Khadidja BOUZIANE^{a,b,c,d,*}, El Mahdi KHETABI^{a,b,c,d}, Remy LACHAT^{c,d,e}, Nada ZAMEL^f, Yann MEYER^{b,c}, Denis CANDUSSO^{a,d}

^a Université Paris-Saclay, ENS Paris-Saclay, CNRS, Université Gustave Eiffel, Systèmes et Applications des Technologies de l'Information et de l'Energie, 94235, Cachan, France.

^b Sorbonne Universités, Université de Technologie de Compiègne, CNRS, FRE 2012 Roberval, centre de recherche Royallieu, CS 60 319, 60203 Compiègne cedex, France.

^c Univ. Bourgogne Franche-Comté, UTBM bât. F, Rue Thierry Mieg, 90010 Belfort Cedex, France.

^d FR FCLAB (FR CNRS 3539), Plateforme pile à combustible, UTBM bât. F, Rue Thierry Mieg, 90010 Belfort Cedex, France.

^e ICB (UMR 6303), CNRS Univ. Bourgogne Franche-Comté, UTBM, Belfort, France.

^f Fraunhofer Institute for Solar Energy Systems ISE, Freiburg, Germany.

[*] Corresponding author's email: khadidja.bouziane@utbm.fr;

Other emails: el-mahdi.khetabi@ifsttar.fr, remy.lachat@utbm.fr,

nada.zamel@ise.fraunhofer.de, yann.meyer@utc.fr, denis.candusso@ifsttar.fr.

Abstract:

The electrical contact resistance between the Gas Diffusion Layer (GDL) and the BiPolar Plate (BPP) used in Polymer Electrolyte Membrane Fuel cells (PEMFCs) is responsible for a substantial amount of Ohmic losses in the electrical power generator. This contact resistance was measured for a variety of carbon paper GDLs under cyclic mechanical compression between 0 and 8 MPa according to the Transmission Line Method (TLM). Contact resistance and strain hysteresis were noticed as a result of cyclic compression. The effect of GDL structure and composition on the electrical contact resistance and its cyclic behaviour has been evaluated. The contact resistance was found to decrease non-linearly with compression; more than 75% of reduction was attained at 2.5 MPa. The electrical contact resistance's difference between the different cycles of compression decreased with compression loads. Graphitised straight fibre Toray GDLs demonstrated the smallest contact resistance followed by the MicroPorous Layer (MPL) and the felt fibre substrate. The SGL straight fibre substrates exhibited the highest contact resistance. The felt fibre structure exhibited the smallest difference rates between the cycles of compression.

Keywords:

Fuel cell, Gas Diffusion Layer, Bipolar plate, Electrical contact resistance, Cyclic compression.

Highlights:

- GDL - BPP electrical contact resistance is measured under cyclic compression.
- A non-linear decrease of the contact resistance is observed with compression.
- Contact resistance difference between cycles decreases with higher compression loads.
- Graphitised carbon paper GDLs exhibit the smallest contact resistance.
- The felt structure GDL is the least sensitive to cyclic compression.

Abbreviations:

2D/3D: Two dimensions / Three Dimensions.

BPP: BiPolar Plate.

CL: Catalyst Layer.

CCM: Catalyst Coated Membrane.

DMA: Dynamic Mechanical Analysis machine.

GDL: Gas Diffusion Layer.

FEP: Tetrafluoroethylene-hexafluoropropylene.

FC: Fuel Cell.

MEA: Membrane Electrode Assembly.

MPL: MicroPorous Layer.

PEMFC: Polymer Electrolyte Membrane Fuel Cell (also called Proton Exchange Membrane Fuel Cell).

PTFE: Polytetrafluorethylene.

PTL: Porous Transport Layer.

SGL: Commercial Sigracet carbon Paper GDL series.

TGP: Commercial Toray carbon Paper GDL series.

TLM: Transfer Length Method also called Transmission Line Measurement.

Nomenclature:

R_c : Electrical contact resistance (Ohm).

ρ_c : Specific electrical contact resistance ($\text{mOhm}\cdot\text{cm}^2$).

W : Width of GDLs (mm).

L : Width of metallic indenters (mm).

d : Distance between metallic indenters (mm).

R_t : Total electrical resistance of the two metallic contacts and the GDL (Ohm).

R_s : Sheet resistance (Ohm / \square or Ohms per square).

A_{eff} : Specific contact area (mm^2).

C_{pc} : Contact resistance absolute difference between cycles ($\text{mOhm}\cdot\text{cm}^2$).

RC_{pc} : Contact resistance relative difference between cycles (%).

i : cycle number.

σ : Compression pressure (MPa)

1. Introduction

Although known for their high efficiency, quick start at room temperature [1], and the variety of possible applications [2] (stationary systems, mobile devices, transportation [3] and space applications [4]), the Low-Temperature Polymer Electrolyte Membrane Fuel cells - PEMFC are subject to several voltage losses reducing their power production. Activation, Ohmic and mass transport losses are respectively predominant at low, medium and high current densities limiting the Fuel Cell - FC voltage production. Despite the continuous growth of these clean electrical generators [5] in the energy market, a larger deployment requires enhancing their reliability [6], lifespan [7–9] and reducing their costs [1]. Improving electrical power production by reducing FC voltage losses is also required. A good understanding of the influence of mechanical compression during both the stack assembly stage and the FC operation itself is necessary to reach this aim. Mechanical compression is known to reduce Ohmic losses as it decreases the resistance of the Gas Diffusion Layer - GDL and increases mass transport losses by reducing the porosity of the GDL. This is due to the high porosity of this layer making it the most sensitive element towards compression. In this paper, the effect of cyclic mechanical compression on the electrical contact resistance between the GDL and the BiPolar Plate - BPP is analysed as this resistance is responsible of a substantial amount of Ohmic losses.

These Ohmic losses are the sum of ionic losses due to the protonic resistance of the membrane and the electronic losses caused by the bulk resistances of the other components of the cell (Gas Diffusion Layer - GDL, Bipolar Plate - BPP, Catalyst Layer – CL, Membrane) and by the contact resistances between them [10,11] (between the GDL and the CL, and between the GDL and the BPP). Contact resistances are estimated as the biggest source of electronic Ohmic losses [12,13]. They are estimated to be more than 50% of the total electronic losses [14,15] and the most significant one, between the GDL and BPP, represents 10% of the total Ohmic losses [14,15]. Because of the voltage losses, a single PEM fuel cell can produce 0.6 to 0.7 V, at

nominal current density. In order to reach the requested power, the cells are stacked (usually up to 100 cells) electronically in series, and in parallel in terms of flows. The stack assembly is realised by a mechanical clamping system, which creates stresses [16] that affect power production.

Other external mechanical sources of stress in FC include vibrations (like in transportation system technologies) and shocks. In the other hand, FC operating conditions are responsible for internal stresses [12,13]. The swelling and shrinking of the membrane [17], depending on its water content, the difference between the thermal coefficient of the components, and to a lesser extent, the difference between reactant gas pressure induce mechanical constraints. These various internal and external loads generate an unsteady state of stress inside the FC, especially on the GDL - BPP interface. Besides, because of the nature of the BPP geometry and the GDL structure, the pressure distribution is inhomogeneous. This distribution also depends on the position of the cell inside the stack [18] and is further impacted by the nature of the clamping process. Considering the aforementioned conditions, the use of only static loads to study the effect of compression is insufficient. In addition, the structure of the GDL exhibits a nonlinear compression stress-strain curve, with a strain hysteresis along the loading-unloading cycles [19], which might become stable after 5 cycles of compression [20]. Only few studies are devoted to the impact of these cycles of compression on the physical properties of the GDL, such as electrical properties. More research needs to be conducted in order to understand their impact on the different functions of the GDL.

This porous composite media of 100-500 μm thick [21], generally made of carbon fibres either woven, carbon cloth, or non-woven, in straight and felt (spaghetti shaped) carbon fibre papers, plays different roles which require specific physical properties. First, 1) the layer must have a high porosity to provide a homogenous reactant gas flow (H_2 in the anode and O_2 in the cathode) to the CL for an optimal use of the active surface. Besides, 2) it needs a high electrical and

thermal conductivity to conduct electrons and heat to the BPP. In addition, 3) the GDL has an important role in water management; it should properly evacuate the produced water to avoid flooding and keep the pores always open to reactant gases diffusion, without drying the membrane (whose ionic conductivity is directly related to water content [11]). In this aim, GDLs are treated with a hydrophobic agent, namely PTFE or FEP [22], and sometimes, a Microporous Layer – MPL [23] is added to the GDL substrate, on the CL side. This sublayer improves the contact with the Catalyst Coated Membrane - CCM and blocks the water inside it. Researchers are developing new methods to improve water management inside the GDLs by promoting preferable water patterns [24–26], the use of porosity graded MPLs [27], the use of double gas diffusion baking layers [28,29] in self-humidified PEMFCs or by applying hydrophobic treatment on BPP [30]. Along to these functions, GDLs 4) should resist corrosion as it is in contact with different substances (BPP, water, oxygen, hydrogen). Finally, one of the most important functions of the GDL is 5) to undergo the mechanical efforts and support the MEA system so that it does not change its shape and remains functional.

As it undergoes these mechanical stresses, GDL thermal [31–33], structural [34], water management [35], durability [36], mechanical [20,37,38], and electrical properties [19,39–48] are affected, and this will influence the global cell performance. A number of papers have examined this effect [49] in order to find the optimal mechanical pressure, whereas other studies have focused on the GDL alone. M. Ahmad et al. [45] set up a numerical model that predicted a greater performance when the GDL was compressed at 1.67 MPa while N. Ul Hassan et al. [38] observed a better performance at the torque that corresponds to the most uniform pressure distribution at the BPP-GDL interface, which for the particular case of their cell was at a compression torque of 1.5 N.m. T. J. Mason et al. [47] perceived the best performance at the smallest pressure of 0.5 MPa and explained that mass transport resistance was more sensitive to compression pressure as its increase with pressure was much more important than the Ohmic

resistance's decrease. This unusual observation can possibly be due to the high humidity rate of 100% of reactant gases, which enhanced water accumulation. Concluding on a particular pressure value is however difficult because of the variation of cell configurations (type of gaskets / GDLs / BPPs, assembly process...etc) and the difference of compression approach (compression torque, GDL interfacial pressure, etc).

Other studies have focused directly on the GDL electrical properties, namely its different resistivities. It was found that the electrical conductivity of the GDL increases with compression [41] while its porosity decreases. Besides, because of the structure of the GDL, this conductivity / resistivity is anisotropic. In [50], the through-plane and in-plane conductivities of carbon paper GDLs were numerically estimated regarding the porosity rate. The through-plane conductivity was found lower than the in-plane one. Results agreed with experimentally measured conductivities with different porosity rates resulting from compression. M.S. Ismail et al. [51] also estimated the effect of GDL anisotropy by comparing isotropic / anisotropic cases. Their model shows that considering isotropic GDLs would over / underestimate the average current density (23-30%). The current density distribution was more uniform for anisotropic GDL and the in-plane anisotropy found in [52] had no significant impact on FC performance. O. Aydin et al. [43,44] measured the electrical in-plane and through-plane resistivities of paper GDLs under compression employing three different 4-point probe processes. They compared results from a gold-coated electrode method, a pin method and a micro-wire one that was deduced as the most accurate way to measure the through-plane resistivity. Both in and through-plane resistivities decreased with compression. M. Zhiani et al. [48] studied the behaviour of GDLs under compression in order to find the best MPL fabrication process. They noted a reduction of electrical in-plane resistivity and gas permeability with compression. They selected the ultra-sonic bath as the best MPL fabrication process compared to pulse sonication, continuous sonication, and mechanical stirring ultra-sonic as it provided a good trade-off between a low

resistivity and an acceptable permeability. M. Hamour et al. [46] found that the in-plane conductivity of cloth GDLs increased by 45% at a 4 MPa compression and reached 50% at 8 MPa.

Despite the number of papers on the bulk resistivity of the GDL, most studies have been done under static compression, except for the work of D. Todd [53] and Qui D. [54] where cyclic compression was used.

D. Todd et al. [53] measured the through-plane resistivity and both fibre and cross fibre alignment direction in-plane resistivities of a carbon paper GDL under cyclic compression. They noticed a decrease of all resistivities with compression, with the lowest in-plane resistivity measured in the direction of fibre alignment. They also observed a decrease in the through-plane resistivity during cycling, while the in-plane resistivity increased. In [54], the electrical resistance of the 3 different structures (carbon cloth and straight / felt fibre papers) of GDL has been investigated under cyclic mechanical compression, and the through-plane resistance has been extracted using GDLs with different thicknesses. They found that felt structure was the most stable one.

Regarding the electrical contact resistance between the GDL and the BPP, focus was also given to static compression. This electrical contact resistance was found to decrease with compression [19,39,40], [55-57]. Three main methods were used to determine the contact resistance. A subtraction method [56], [57] can be used by measuring the electrical resistance of two assemblies in such a way that the difference between the assemblies' resistances gives the desired contact resistance. However, most studies that used this method neglected either the bulk resistance or its variation with compression. Another constraint is the difficulty of using this method with GDLs having non-identical sides such as one side MPL coated GDLs. The contact resistance can also be determined by a numerical or experimental estimation that can be achieved using results of the subtraction method. For instance, in [55], T. J. Mason et al.

estimated this contact resistance, by placing a GDL between 2 compressed BPPs and by measuring the resistance under compression, the entire resistance was attributed to the contact resistance. An estimation process can also be used to determine the variation of the through-plane resistance of the GDL with compression, from its porosity such as in the work of M.S. Ismail et al. [40]. They concluded that compression reduces the contact resistance and that it is influenced by the GDL's initial thickness in the presence of a gasket. They also denoted a better contact when the MPL is more loaded with PTFE. A numerical model can also be set to obtain the global contact resistance using experimental results with a flat graphite plate [58–60].

Finally, the use of the Transmission Line Method - TLM allows a direct experimental determination of the contact resistance of each side of the GDL. D. Ye et al. [15] employed a TLM method to measure the contact resistance under static compression and concluded no dependence on clamping pressure. S. El Oualid et al. [19] set up a TLM method to measure the contact resistance, that was found to decrease with compression non-linearly.

Despite the numerous ways of determination of contact resistance under compression, just as in the case of bulk resistivity, most studies have been done under static compression, even if GDL have been preconditioned in some studies ([19], [55], [57].) Neither the real quantification of the effect of cyclic compression on the contact resistance of GDLs, nor the effect of structural parameters is available in literature. Only one study has used cyclic compression [55] when measuring contact resistance: they found a dependence of this resistance to the cycles of compression. However, the total resistance was estimated as the contact resistance. The relationship between the different structures and composition of GDL and the effect of the cycles of compression on the contact resistance is still not explored and to the knowledge of the authors, no study has determined the effect of cyclic compression on the electrical contact resistance measured by the TLM method.

In this paper, we determine the electrical contact resistance between the GDL and the BPP, using a TLM method under cyclic mechanical compression from 0 to 8 MPa. A quantification of the effect of the cycles of compression is given. In addition, the effect of PTFE, MPL, and different carbon paper GDL structures is analysed. In the next section, a brief explanation of the experimental method and data analysis is given. In the third section, mechanical aspects are treated followed by the analysis of the electrical contact resistance behaviour towards mechanical compression, the effect of structure and composition and the influence of cyclic compression on mechanical and electrical parameters. Before concluding this paper, the results are compared to the literature.

2. Experimental procedure

The electrical contact resistance (R_c) (and its specific value ρ_c) between the GDL and the BPP were evaluated under cyclic mechanical compression using an ex-situ testing method similar to the study of S. El Oualid et al. [19]. However, we employed a mechanical force and a contact area different from [19], and considered six types of GDL samples. The measurement of the contact resistance was carried out according to the Transmission Line Method (TLM); a brief explanation of the method is given in [Section 2.3](#).

2.1 Samples and sample holder

Six different types of carbon paper GDL samples were used (Cf. [Table 1](#)). The SGL 24 BC is coated with a MPL at one side. Even though the MPL usually faces the CL, both the fibres substrate side and the MPL one were evaluated.

GDL type	Thickness (μm)	Structure and composition
SGL 24 AA	190 +/-30 ¹	Straight carbon fibre paper.
SGL 24 BA	190 +/-30 ¹	Straight carbon fibre paper with 5% PTFE (hydrophobic agent).
SGL 24 BC	235 +/-30 ¹	Straight carbon fibre paper with 5% PTFE + MPL.
Toray TGP H90	280 [61]	Graphitised straight carbon fibre paper.
Toray TGP H120	370 [61]	Graphitised straight carbon fibre paper.
Freudenberg H2315 I3	210 [62]	Felt Carbon fibre paper + hydrophobic agent.

¹ From SGL carbon company

Table 1: GDL sample type.

The samples were cut into two sheets, each with a width ($W/2$) of 2 mm and a length of 40 mm (Fig. 1 a). They were disposed at each side of the sample holder in order to guarantee some mechanical stability. This homemade sample holder was specifically designed to ensure the application of a homogenous mechanical compression on the samples, thanks to its ball device. The sample holder includes two gold coated metallic indenters with a width L of 1 mm, which is a typical size of BPP rib width. These indenters are in contact with the GDL samples on 4 contact surfaces of $W/2 \times L = 2 \times 1 \text{ mm}^2$ areas each, making a total contact area of 8 mm^2 . The GDL-indenter system is electrically insulated from the machine with two glass plates. The upper plate is designed in a way that allows the variation of the distance between the indenters d ($d1$ to $d4$) (Table 2), which is required to evaluate the contact resistance R_c using the TLM method (Fig. 1 b). This method is based on the fact that the total resistance R_t (between two metallic contacts and the GDL) is proportional to the distance between the two metallic contacts d .

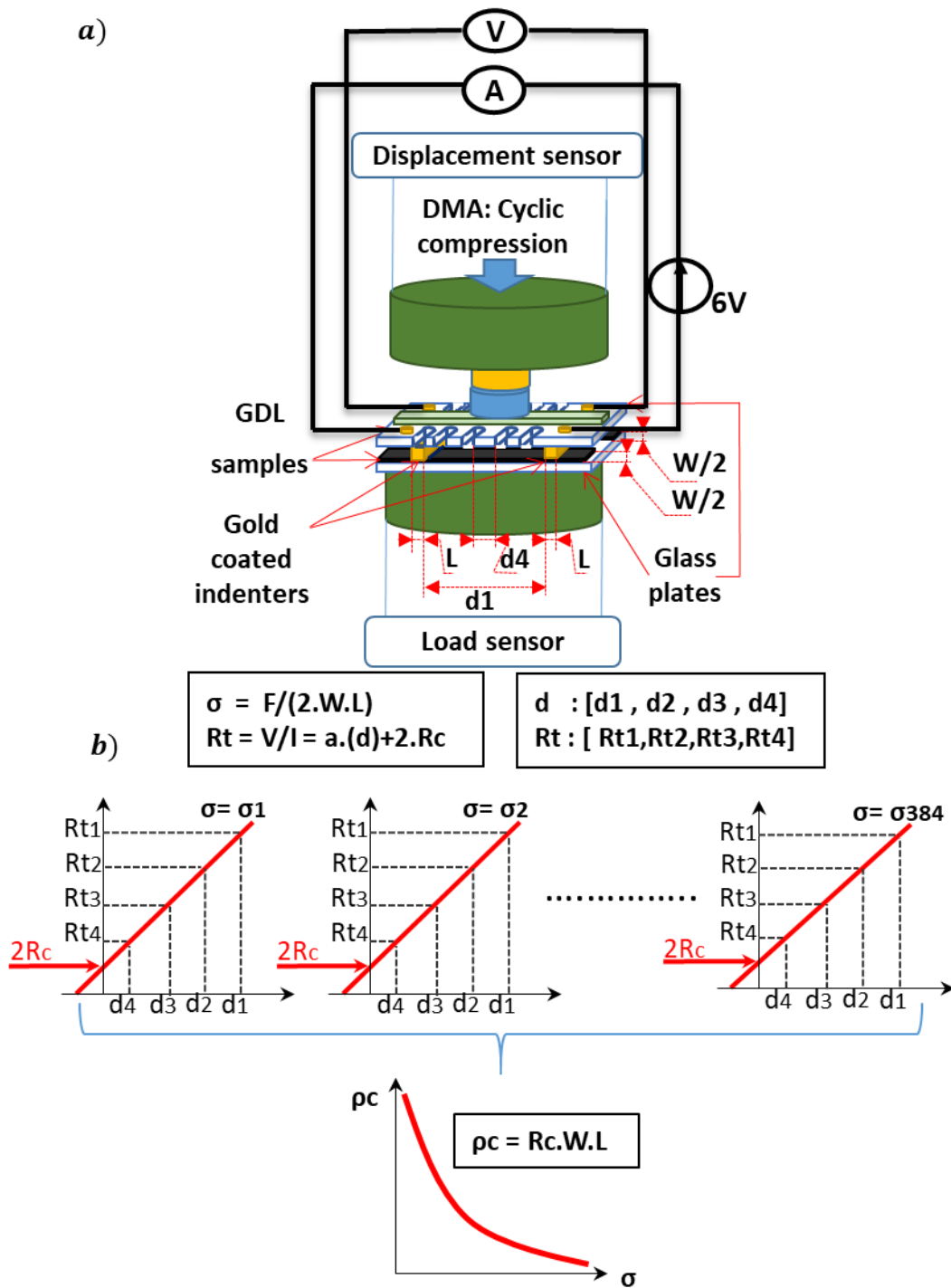

Fig. 1: Graphic summarising the experimental procedure to estimate the electrical contact resistance between the GDL and the BPP under cyclic mechanical compression. a) Experimental set-up, b) Contact resistance (R_c) extraction.

2.2 The mechanical load

A cyclic mechanical compression has been applied on the GDL samples using a Dynamic Mechanical Analysis machine - DMA type Metravib VA2000. GDLs were compressed by the indenters, i.e. the 4 compressed surfaces, which are the 4 contact surfaces forming a total compressed area of 8 mm^2 . The mechanical force ranged from 0 to 65 N ($\pm 0.2 \text{ N}$); in terms of applied stress: 0 - 8.25 MPa ($\pm 0.025 \text{ MPa}$). Five cycles of loading-unloading compression were applied with four levels of pressure as shown in Fig. 2. This cyclic loading has been applied three consecutive times for every distance d (i.e. d_1, d_2, d_3, d_4), on each GDL sample.

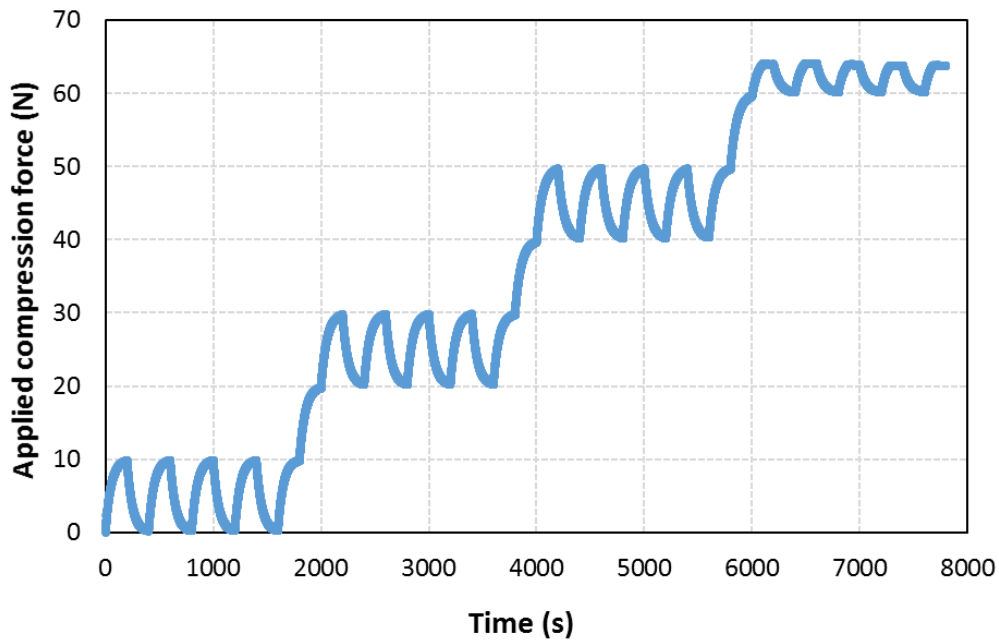

Fig. 2: Applied mechanical load.

2.3 Specific electrical contact resistance determination

As mentioned earlier, the electrical contact resistance measurement method applied in this research is the TLM method, which is usually used to measure the electrical contact resistance between a metal and a semi-conductor. This method is based on the fact that the total resistance between two metallic contacts and the GDL (R_t) is proportional to the distance between the two metallic contacts (d) following Eq. 1:

$$R_t = R_s \frac{d}{W} + 2R_c = a \cdot (d) + b \quad (1)$$

With:

R_s : the sheet resistance (Ohm / \square or Ohms per square).

W : the width of the GDLs (mm).

R_c : the contact resistance (Ohm).

d : the distance between the metallic indenters (mm).

The contact resistance R_c can be determined by varying the distance between the metallic indenters d in order to find the slope a and the offset b of the linear curve $R_t = f(d)$. In this study, four values of d have been used as shown in [Table 2](#).

Distance name	Length (mm) (+/-5%)
$d1$	31.1
$d2$	18.1
$d3$	9.9
$d4$	2.2

Table 2: Distances between the two indenters.

The slope $a = R_s / W$ and the offset $b = 2 \cdot R_c$ are then extracted using the least square method.

The specific electrical contact resistance is obtained by multiplying the contact resistance by the specific area of one side of the contacts (A_{eff}):

$$\rho_c = R_c \cdot A_{eff} \quad (2)$$

So that:

$$\rho_c = R_c \cdot W \cdot L \quad (3)$$

With: $W \cdot L = 4 \text{ mm}^2$.

For more details on the mathematical model of the TLM method, the reader is referred to [63–68]. The electric circuit composition is similar to the circuit of [19]. The GDL-indenters set is included in an electrical circuit with a fixed voltage source and a witness resistance. Voltage and current are measured across the system and the total resistance R_t is evaluated as a function of compression for every distance d . The voltage generator is set to 6 V. (Fig. 1 a), as El Oualid S. et al. [19] has found that this value was more suitable for a linear relation between (R_t) and (d). The voltage and the current resolutions are 2 mV and 0.1 mA, respectively. Uncertainties of type B [69] were determined for the measured voltage U and current I , according to the user manual of the Oscilloscope used (Tektronix tds2002) with an accuracy of 3% of the measured values. Uncertainty on R_t was calculated according to error propagation laws applied to U and I . Uncertainty on R_c was extracted from the uncertainty on the offset (b) calculated according to the ordinary least-square methods, considering the highest uncertainty on R_t and neglecting the uncertainty on d .

2.4 The data analysis process

Experimental data were collected by an acquisition card. The same experimental process was followed for the seven sample types (including the MPL side of SGL 24 BC). First, the distance between indenters d was fixed, starting by the longest distance d_l , so that the material between the indenters is always uncompressed and not damaged by previous compression. Then, an electromechanical test was done including the mechanical load depicted in Fig. 2, and the voltage of 6 V was applied to the circuit. The total resistance between the indenters R_t is measured, as well as the displacement of the GDL. The data was stored in one file corresponding to d_l . Then, the same test was repeated twice again on the same sample and the data was stored in the same spreadsheet file (tests 1, 2 and 3). The same process was repeated

for the three other distances d and the data was recorded in three other files. The four files obtained are treated in order to obtain the contact resistance R_c and the total strain as a function of the applied stress. Every file consists of a number of data sequences. Each data sequence includes: measured force, target force, measured displacement, current intensity, voltage, and time. The number of data sequences in each file is reduced to 384 measurement points by using a simple moving average of the current intensity, the voltage and the displacement by step of 1N of measured force.

For every GDL, the four files of the measured resistances R_t for the four distances d are combined to calculate the contact resistance using the least square method and the average strain. E.g. the measurement point 5 corresponds to a loading compression of 0.5 MPa for the first cycle of compression, the contact resistance for this point of pressure is calculated using the 4 total resistances R_t (for d_1, d_2, d_3, d_4) at this point of compression using the least square method according to Eq. 1. The steps of the experimental process are depicted in Fig. 1.

Figure 3 shows the relationship between R_t and d , for the SGL 24 AA. We can observe that the experimental points are quite linear with a regression coefficient of 96%. Accurate measurement of R_c involves a good alignment of the points formed by $R_t=f(d)$ which requires a high regression coefficient.

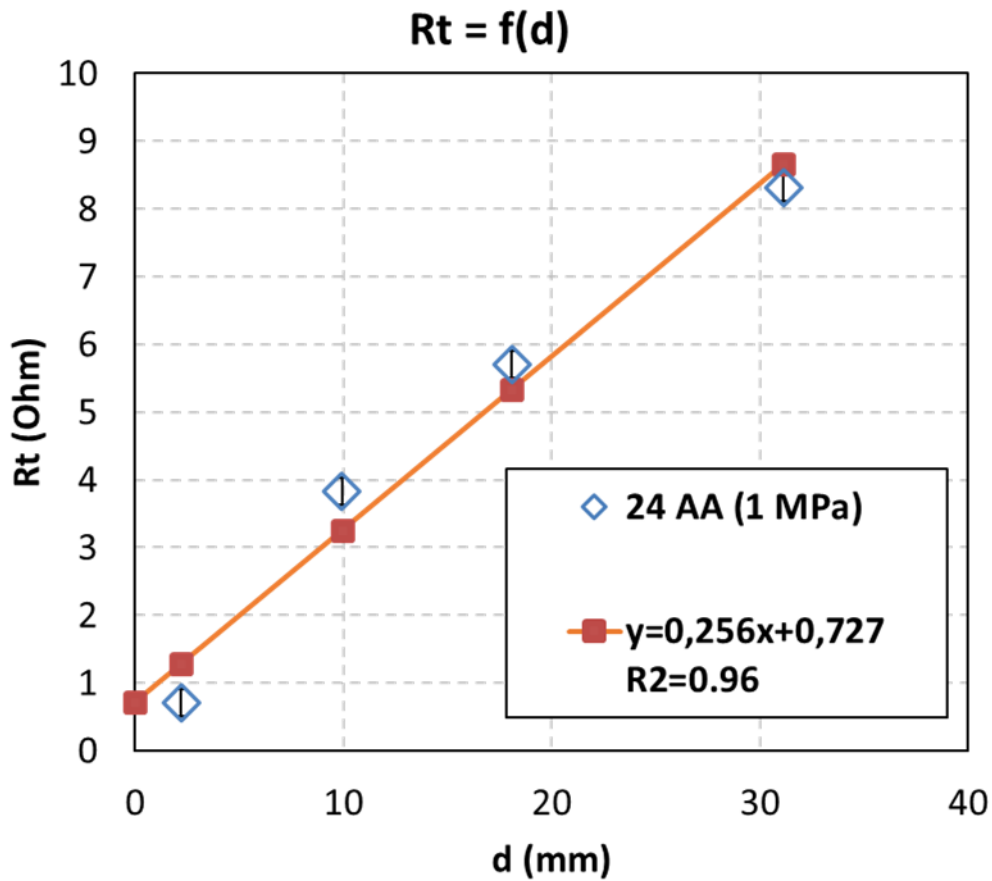

Fig. 3: Real $R_t = f(d)$ and least square line for SGL 24 AA, first test.

3. Results and discussion

The following section describes the mechanical and the electrical behaviour of the GDLs under cyclic mechanical compression, followed by a detailed discussion on the difference of electrical and mechanical parameters obtained by this cyclic compression.

3.1 The mechanical behaviour of the GDLs

For every GDL, the total strain was determined by calculating an average of the total displacements measured (d_1 , d_2 , d_3 or d_4). The average value is then divided by the initial thickness given in the material datasheet (Cf. [Table 1](#)).

One source of uncertainty is the unstable initial position of the sample holder, as well as the inaccurate GDL initial thickness value due to the material structure of the GDL that is similar

to a fabric-structure. These two issues are the cause of displacement starting point related uncertainties. To limit these uncertainties, the initial position has always been set less than ($\pm 10 \mu\text{m}$) in terms of displacement with an initial force less than ($\pm 0.2\text{N}$).

When comparing the thickness of Toray samples and the SGL 24 BC samples of this investigation with the study of A. El-Kharouf et al. [70] at the compression pressures of 0.5 and 2.5 MPa, less than 12% difference was observed for the Toray and less than 24% for the SGL. This difference can be explained by the use of another type of compression load and other experimental variations.

Figure 4 shows the mechanical stress-strain of every GDL for the first test. Three main levels of stiffness are observed for all GDLs. A stiffer group composed of the Freudenberg GDL and the MPL side of the SGL 24 BC, a medium group including the remaining GDLs apart from the SGL 24 AA, which composes alone the soft level and last group. For the Sigracet series, we can first notice that the SGL 24 BA is much stiffer than the SGL 24 AA, as well as the SGL 24 BC. Two different stress-strain curves were obtained when compressing the SGL 24 BC from each side (the MPL side and the substrate one). For the Toray series, the samples belong to the medium level and the Toray H90 exhibits a stiffer behaviour.

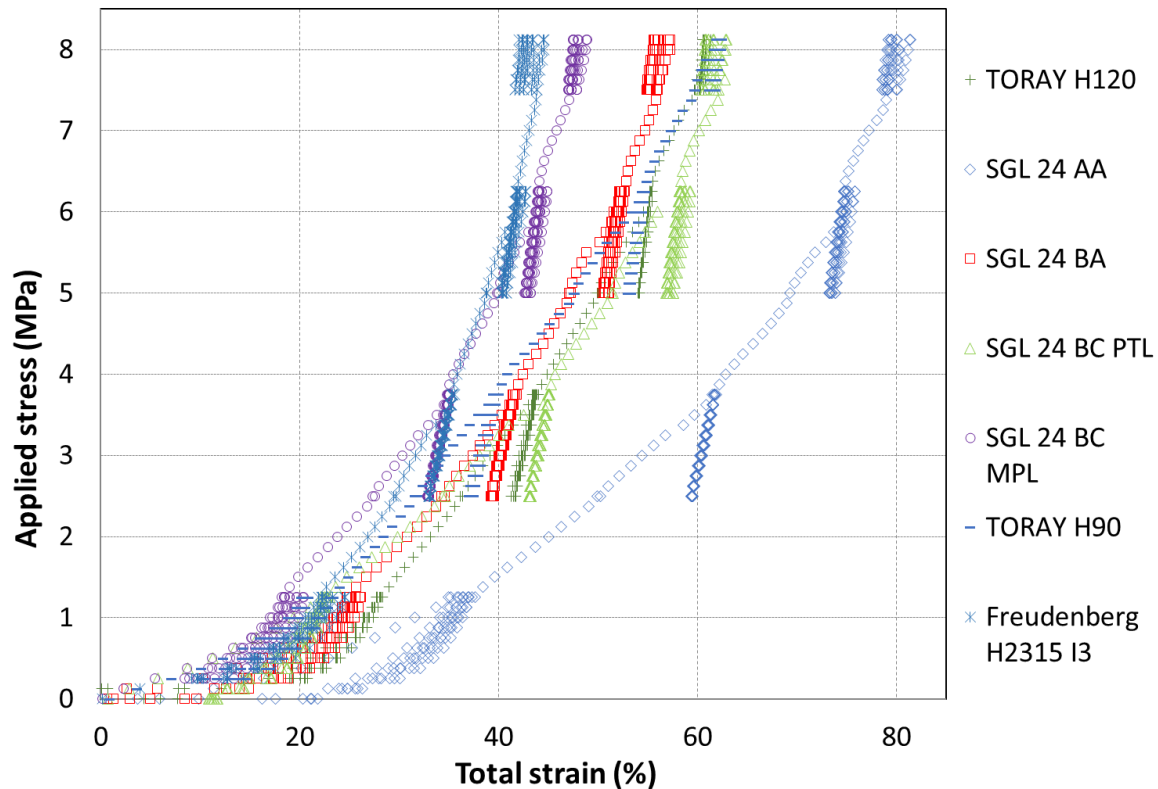

Fig. 4: Stress-strain curves.

3.1.1 Effect of PTFE

The higher stiffness of the SGL 24 BA compared to the SGL 24 AA is the result of the 5 wt% of PTFE added to the 24 BA, which is the only distinction of composition between the two GDLS. The PTFE covers the carbon fibres and mechanically locks their movement making the substrate stiffer.

3.1.2 Effect of the MPL

The SGL 24 BC is originally a substrate of type SGL 24 BA covered with an MPL at one side. When compressing this SGL 24 BC from two different sides (the substrate side or Porous Transport Layer side - PTL and the MPL side), two different curves were obtained. We expect that the result of the deformation curves represents mainly the deformation of the upper

compressed layer with a slightly lower layer compression. It is noteworthy to mention that for the first loading cycle of compression from 0 to 0.7 MPa the two curves are quite similar.

3.1.3 Effect of structure and fabrication process

The materials from Toray have comparable mechanical stiffness curves with the SGL 24 BC PTL side and the SGL 24 BA, which are hydrophobic straight carbon fibre papers. The felt carbon paper of Freudenberg is stiffer compared to the straight carbon fibre structures. It has the same mechanical behaviour as the MPL side of the 24 BC.

3.2 The specific electrical contact resistance

As expected, the experiments described a non-linear decrease of the specific electrical contact resistance ρ_c with compression as shown in Fig. 5. A very rapid reduction of ρ_c from 0 to 3 MPa can be observed, then a slower one from 3 to 8 MPa. For all the GDLs, more than 75% of the total reduction of ρ_c is obtained at 2.5 MPa. The applied stress improves the contact between the GDL and the indenters by increasing the contact surface. It also decreases the porosity of the GDL, making carbon fibres that conduct electrons closer to each other.

At first glance, the Toray GDLs manifested a small specific electrical contact resistance ρ_c (4-20 mOhm.cm²), SGL GDLs a higher one (4-65 mOhm.cm²), while the Freudenberg had a medium contact resistance (8-32 mOhm.cm²) (Fig. 5 a). In the SGL group, the PTL side of the 24 BC shows the highest resistance (27-65 mOhm.cm²) while its MPL side displays the lowest one (4-23 mOhm.cm²). The SGL 24 BA has a higher resistance compared to the SGL 24 AA as shown in Fig. 5 b). For the Toray Series, the Toray H120 has a comparable resistance with the H90. Some scattered points can be observed when pressure is lower than 1.25 MPa, even after 2 previous tests reaching 8MPa as depicted in Fig. 5.

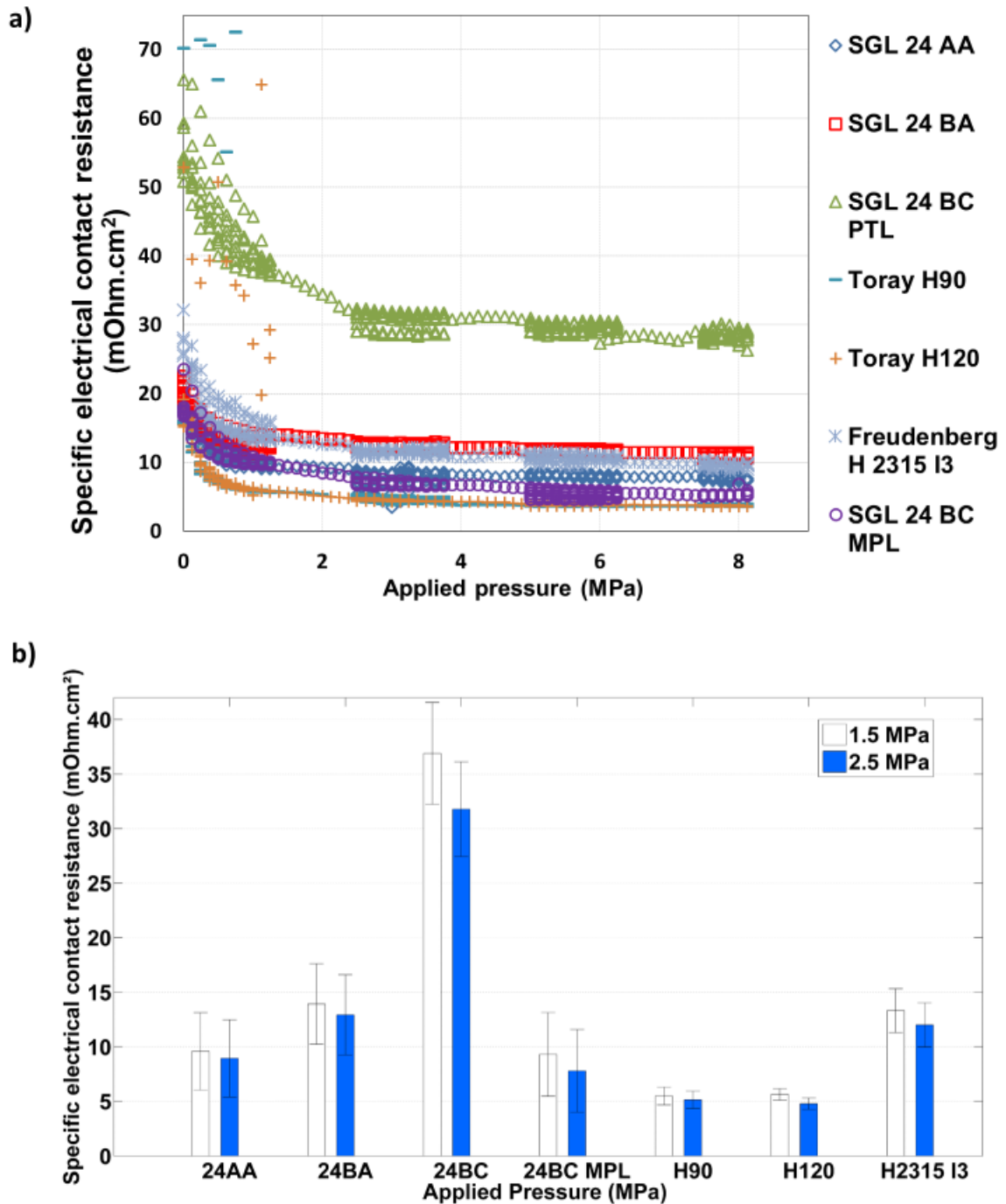

Fig. 5: a) Electrical contact resistance as a function of the applied stress for the third test. b) Electrical contact resistance at 1.5 and 2.5 MPa

3.2.1 Effect of PTFE loading

Analogously to the mechanical behaviour, the fact that the SGL 24 BA has a higher electrical contact resistance compared to the SGL 24 AA is ascribed to the PTFE which is added to the

reference 24 BA (5 wt%). The PTFE is a non-conductive material that can cover some of the contact surfaces with the indenters. However, more importantly, it increases the mechanical resistance limiting the compression rate of the GDL, which will limit the decrease of the contact resistance attributed to the larger contact area enhanced by compression. This can explain the visible increase of the gap between the resistance of the 24 AA and the 24 BA with compression (from 0 to 1 MPa) that is observed in [Fig. 5 a](#)).

3.2.2 Effect of the MPL

With its smooth surface, the MPL of the SGL 24 BC improves the contact with the indenters, which decreases the contact resistance of the MPL side. The SGL 24 BC PTL side, which originally has the same structure and composition of the SGL 24 BA, exhibited a higher contact resistance compared to the SGL 24 BA's one. Because the contact resistance measured also includes the contact resistance between the MPL and PTL side of the GDL that should also be taken into consideration when analysing Ohmic resistances. We expect that the measurement of R_c at the PTL side of 24 BC contains also the contact resistance between the PTL and the MPL interface. This is not the case when ρ_c is measured at the MPL side because the MPL bulk resistance might be much lower than the MPL substrate contact resistance and the PTL bulk resistance. Therefore, the current flows only from the first indenter through the MPL layer, then get back to the second indenter without passing through the lower layer (PTL side, i.e. macroporous layer side), in the case of the MPL side measurement.

3.2.3 Effect of structure and composition

The felt carbon paper exhibited a resistance between the resistances of SGL straight carbon paper 24 AA and 24 BA and the smallest resistances were measured for the graphitised straight

carbon papers of Toray. Graphitised and felt structure are also showing smaller uncertainty values compared to the straight paper GDLs as shown in table 3.

GDL		24 AA	24 BA	24 BC	24 BC MPL	H90	H120	H2315 I3
Uncertainty on ρ_c (mOhm.cm ²)	Minimum	3,52	3,61	4,18	3,56	0,71	0,51	1,97
	Maximum	3,68	3,92	4,99	4,33	1,23	0,74	2,25
	Average	3,54	3,68	4,54	3,79	0,81	0,53	2,05
Average relative uncertainty (%)		41,89	29,62	13,84	55,52	18,16	11,47	17,29

Table 3: Uncertainty of the contact resistance (3rd test).

3.3 Effect of the cycles of compression

3.3.1 Effect on the contact resistance ρ_c

While measuring the electrical contact resistance, the GDLs were compressed from 0 to 8.25 MPa. They were subjected to 5 cycles of loading-unloading mechanical compression upon four levels of compression (0-1.25 MPa, 2.5-3.75 MPa, 5-6.25 MPa, and 7.5-8.25 MPa) (Fig. 2).

The effect of the cycles of compression has been evaluated with two methods by calculating an absolute value and a relative one. The absolute difference of contact resistance ρ_c between the cycles $C\rho_c$ has been evaluated by determining the average of the absolute value of the difference between ρ_c at the loading of the 2nd, 3rd, 4th, and 5th cycle and ρ_c at the loading of the 1st cycle (Cf. Eq 4). The rate of this difference $RC\rho_c$ was extracted by dividing it by the value of ρ_c at the 1st cycle (Cf. Eq 5). The effect of the cyclic compression on the mechanical properties has been evaluated in the same way, using the strain instead of ρ_c . One pressure value has been chosen for every compression level: 1, 3, 6, and 8 MPa. Standard deviation has been evaluated for absolute values.

$$C\rho c = \frac{\sum_{i=1}^5(\rho c_1 - \rho c_i)}{4} \quad (4)$$

$$RC\rho c = \frac{C\rho c}{\rho c_1} \times 100\% \quad (5)$$

With:

$C\rho c$: Contact resistance absolute difference between cycles (mOhm.cm²).

$RC\rho c$: Contact resistance relative difference between cycles (%).

ρc_i : Specific electrical contact resistance at cycle i (mOhm.cm²).

The electrical contact resistance is globally affected by the number of cycles of compression. As expected, we observe a general trend of decrease of the difference between cycles ($C\rho c$ and $RC\rho c$) with compression for all GDLs, as well as the difference for strain values. The difference between cycles for compression values of 1 and 3 MPa is much higher than for values of 6 and 8 MPa (Fig. 6). This decrease is higher in absolute values $C\rho c$ and less evident in relative values $RC\rho c$ because the contact resistance itself decreases with compression (Fig. 6). Values of $C\rho c$ depicted a maximum mean value of 8.9 mOhm.cm² for the SGL 24 BC substrate sample.

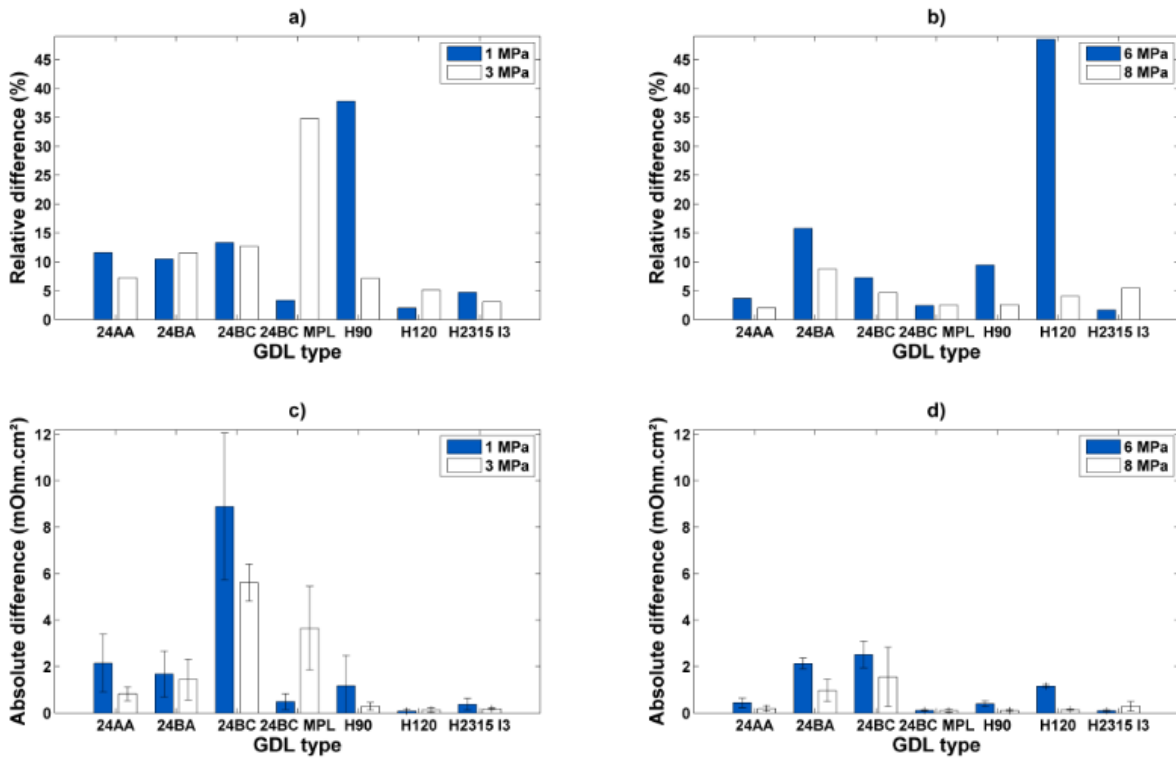

Fig. 6: The difference of Contact resistance between cycles as a function of compression pressure: the relative difference $RC\rho_c$ at low pressure and b) at high pressure. The absolute difference $C\rho_c$ c) at low pressure and d) at high pressure.

When analysing the absolute values at 1 and 3 MPa (Fig. 6 c)) the Toray H120 manifested a low difference between cycles followed by the Freudenberg H2315 I3, while the highest ones were presented by the GDL 24 BC substrate side (PTL) followed by its MPL side. We can imagine that the Toray graphitised structure is the least sensitive to the mechanical cyclic issues. Yet, when observing the relative values, this H120 had to some degree higher difference rates. This is explained by the fact that its contact resistance is so low compared to other GDLs that even values of less than 1.2 mOhm.cm² give relative differences $RC\rho_c$ of about 48%. The Freudenberg, on the other hand, had the lowest difference rate $RC\rho_c$ (Fig. 6 a) and b)), which is attributed to its 3D felt structure being less sensitive to cyclic effects compared to the 2D straight carbon fibre structures. Observing the mechanical properties regarding the difference between cycles, it is visible that, for absolute and relative difference of strain, the Freudenberg

H2315 I3 had the lowest value as well (Fig. 7), which confirms that its structure is the least sensitive to cyclic compression and therefore its ρc as well. Qiu D. et al. [54] also concluded that the felt carbon structure had the highest stability in terms of electrical resistance and microstructure after applying cyclic and steady loads. We also notice that the 24 BC GDL is mechanically the most sensitive GDL to strain difference between cycles just as it is in terms of $C\rho c$.

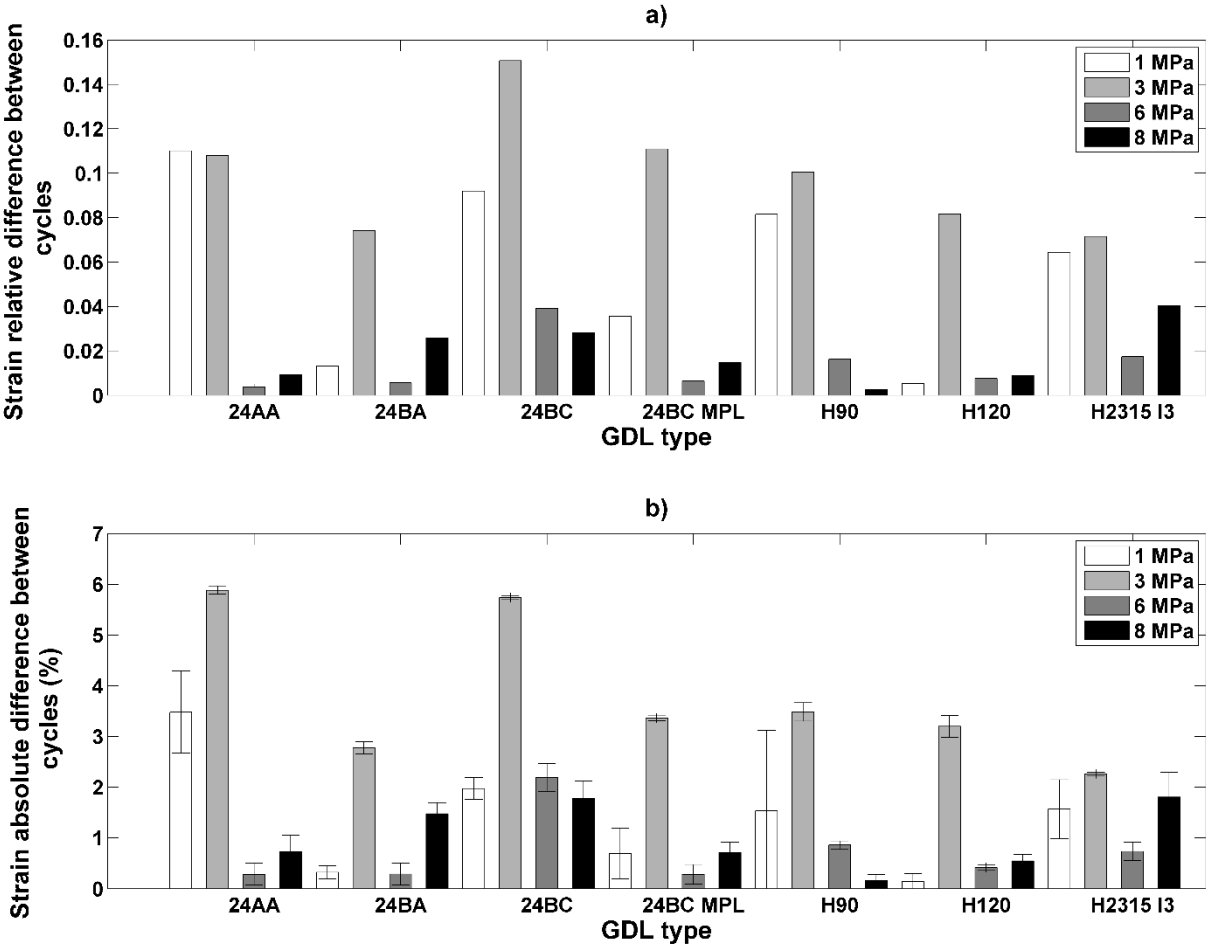

Fig. 7: Strain difference between cycles for 1, 3, 6 and 8 MPa.

3.3.2 Effect of PTFE

The difference between cycles $C\rho c$ of the 24 BA increased unexpectedly compared to the 24 AA. It appears that the PTFE increases the electrical sensitivity to cyclic compression. This is

not explained by the mechanical difference between cycles, which decreased with PTFE. The increase of the $C\rho c$ may be attributed to the PTFE deterioration with cycles.

3.3.3 Effect of MPL loading

The 24 BC GDL substrate, which has originally the same structure as the 24 BA, exhibited a higher absolute and relative difference $C\rho c$ and $RC\rho c$. The MPL side of the 24 BC also showed a higher $RC\rho c$ at low pressure. Adding a MPL increased the difference between cycles of the GDL substrate side, electrically and mechanically.

3.3.4 Effect of the thickness

The thick Toray sample H120 has a lower difference between cycles at low pressure in adequation to its mechanical behaviour and a higher $C\rho c$ compared to the thin H90 at the high pressure of 6MPa, in contrast to the strain difference between cycles of the Toray H90 which is higher than the one of Toray H120,

3.3.5 Effect of the three tests of mechanical compression

The mean electrical contact resistance is almost constant over the three consecutive compression tests for all the GDL types with a trend of a slight decrease of ρc along the tests for the SGL GDLs (Fig. 8) and a little increase of ρc for the other GDLs. The $C\rho c$ tends generally to diminish with the tests.

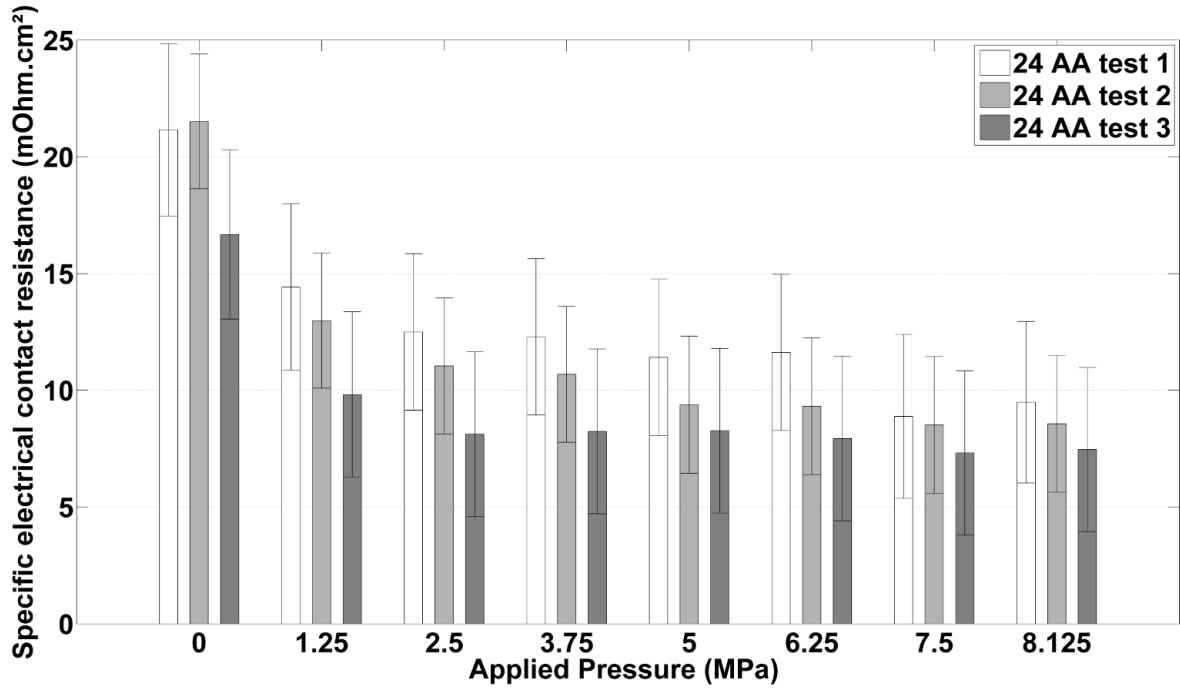

Fig. 8: Electrical contact resistance as a function of the applied stress for the three tests performed with SGL 24 AA.

3.3.6. Effect of cyclic compression on the FC efficiency

For a cell with an Ohmic resistance of 150 mOhm.cm², and a compression pressure of 1 MPa applied on a GDL, the variation of the BPP-GDL contact resistance due to the cycles of compression depending on the GDL type ranges from 1 to 8 mOhm.cm², and will contribute by 1.33 to 10.66 % to the total Ohmic losses. For a cell of 200 cm² at a current of 1 A/cm² and a cell voltage of 0.5V, this will impact the produced power by 0.4 to 3.2 W (i.e. about 0.4%-3.2% of the total electrical power produced by the cell). This amount (of the energy delivered by the cell) can be considered as significant in the context of a widespread deployment of FC technologies and regarding the total energy losses of the FC generator fleet.

3.4 Comparison with literature values

Table 3 is a summary of some results found in literature, from studies that considered the same GDLs and measured the electrical contact resistance between the GDL and the BPP under

mechanical compression. Most values are selected for compression stresses of 1.5 MPa and 2.5 MPa in order to compare between different studies.

In these works, different methods of measurement are used. The electrical contact resistance are measured by the TLM method [15,19], (and this study), a subtraction method [56], [57] or estimated [55]. In some studies, the GDLs are pre-conditioned or cyclic compression is applied [19], [55], [57], (and this study). BPPs or gold covered electrodes are employed [19], [56], [57], (and this study).

We compared the contact resistance measured in the first cycle of the third test for the GDLs used in this study, in order to take into account the previous cyclic compression. For the Toray H120, the contact resistance decreased in this study from 5.64 mOhm.cm² at 1.5 MPa to 4.79 mOhm.cm² MPa at 2.5 MPa (Table 3). T. J. Mason et al. [55] estimated that it decreases from 14 mOhm.cm² to 9.9 mOhm.cm²; this difference can be attributed to the fact that their measurement value included the bulk resistance of the GDL and because of the use of a 5 % PTFE treated H120 sample. In addition, BPPs were not gold coated. In a subtraction method used by A. El-kharouf [57], this resistance was found equal to 4.6 mOhm.cm² at 1.5 MPa and decreased to 3.23 mOhm.cm² at 2.5 MPa. D. Ye et al. [15] found a resistance of 12-13 mOhm.cm² that did not change much with compression; they used a TLM method with copper indenters and a Toray H120 with 20 wt% of PTFE. This higher resistance can be due to the copper electrodes and because of the presence of PTFE. This may also be the reason why there was no notable change with compression as the PTFE is known to increase the stiffness of GDLs.

GDL studied	Compression pressure Vs ρ_c		Method of measurement or estimation (in literature)	Ref.
	σ (MPa)	ρ_c (mOhm.cm ²)		
Toray H120 (5wt% PTFE)	1.4	1 st : 15 (loading) / 12 (unloading) 7 th : 17	A GDL was put between two BPPs (graphite) and the set was compressed (CCU). Then, the resistance between the two BPPs was measured. The measured value was considered as the contact resistance because of the small values of the GDL and BPP bulk resistances. The effect of the numbers of cycles of compression was studied by unloading back to 0.2 MPa for every pressure value (from 0.2 to 2.5 MPa) (14 cycles). The active area: 6.2 cm ² . The rib area (compressed area): 3.3 cm ² .	[55] <i>(Average value + cyclic compression)</i>
	1.6	1 st : 13 (loading) / 10 (unloading) 8 th : 18		
	1.5: mean	1 st : 14 (loading) / 11 (unloading) 8 th : 17.5		
	2.5	1 st : 9.9 14 th : 13.5		
SGL 24 BA	1.4	1 st : 11.7		
	1.6	1 st : 10.6		
	1.5: mean	1 st : 11.2		
	2.5	1 st : 7.9		
Toray H90	1.4	0.9: Au and Ni coating	1. A GDL was put between 2 compressed copper electrodes and the resistance R_{GDL} was measured. 2. A BPP (stainless steel SS316L) was put between 2 GDLs that were between 2 compressed copper electrodes and the resistance R_{all} was measured.	[56] <i>(Subtraction method + gold coating)</i>
	1.6	0.8: Au and Ni coating		
	1.5: mean	0.85: Au and Ni coating 1.7: Au coating		

	2.4	0.76: Au and Ni coating	3. The specific electrical contact resistance between the GDL and BPP was calculated:	
	2.6	0.70: Au and Ni coating	$R_{cr} = S1.(R_{all}-2R_{gdl}) / 2$	
	2.5: mean	0.73 : Au and Ni coating 1.4: Au coating	The BPPs were covered by gold with different thicknesses; in some samples an intermediate layer of 100 nm of Ni was added before gold coating.	
	1.5	100 (without any coating)	No GDL compression preconditioning has been done.	
	2.5	50 (without any coating)	The active electrode area: 3.14cm ² (electrode diameter: d = 2 cm).	
	4	44 (without any coating)		
Toray H120 (+ PTFE)	1.5 2.5	4.60 3.23	1. A GDL was put between 2 compressed graphite BPPs which were placed between 2 stainless steel gold covered electrodes and the resistance $R_{measured}$ was measured. 2. A BPP was put between the 2 compressed stainless steel gold covered electrodes and the resistance $R_{BPP,measured}$ was measured.	[57] <i>(subtraction + gold coated electrodes +</i>
Toray H90 (+ PTFE)	1.5 2.5	3.64 2.77	3. The GDL and BPP through plane resistances were neglected and the contact resistance between the GDL and the BPP was calculated as: $R_c = (R_{measured} - R_{BPP,measured}) / 2$. The GDLs were preconditioned by applying a 3 MPa pressure 3 times.	<i>pre-conditioning of GDL)</i>
SGL 24 BA	1.5 2.5	2.69 1.76	The area of samples: 4 cm ² .	
Toray H120 (20 wt% PTFE)	0.8 0.27- 2.16	12.8 13 (no much difference)	- The TLM method was used to find the contact resistance by measuring the voltage between several copper pads with different distances. - The inhomogeneous compression was modelled by using different sizes of channels / ribs and blocks. - Compression pressure (deduced from GDL thickness): 0.27 MPa - 2.16 MPa.	[15] <i>(TLM + Copper indenters)</i>
	1.5	28	- The TLM method was used to measure the electrical contact resistance of GDLs.	[19]

SGL 24	2.5	25	- Gold-coated indenters were employed. - A Dynamic Mechanical Analysis machine-DMA was used to apply a mechanical excitation (static compression force of (-10 to -60 N) on a surface of 6 mm ²).	<i>(TLM + Gold covered indenters+</i>
AA				
SGL 24	1.5	32.5	- The GDLs have been preconditioned by 7 cycles of compression before starting. - The compressed area: 6 mm ² .	<i>Pre-conditioning of GDLs)</i>
BA	2.5	29		
SGL 24	1.5	27.5		
BC PTL	2.5	26		
SGL 24	1.5	15		
BC MPL	2.5	14		
SGL 24	1.5	9.59	This study:	This study:
AA	2.5	8.94	- The TLM method was used to determine the electrical contact resistance (gold-coated indenters were used).	<i>(TLM + gold covered indenters +</i>
SGL 24	1.5	13.93	- A Dynamic Mechanical Analyser was used to apply the mechanical excitation (5 cycles of compression force of 0 to -65 N).	<i>cyclic compression)</i>
BA	2.5	12.94		
SGL 24	1.5	36.90	- Every Sample was tested 3 times. The values are selected for the 1 st loading cycle of the 3 rd test.	
BC PTL	2.5	31.78		
SGL 24	1.5	9.31	- The compressed area: 8mm ² .	
BC MPL	2.5	7.80		
Toray	1.5	5.49		
H90	2.5	5.15		
Toray	1.5	5.64		
H120	2.5	4.79		

3 According to the different studies that employed the Toray H90, the contact resistance at these
4 pressure levels is in the range of 1-10 mOhm.cm², with the common characteristics of
5 decreasing with compression. However, when A. Miyazawa et al. [56] used no gold coating, it
6 ranged from 50 to 100 mOhm.cm².

7 The SGL24 BA's contact resistance ranges from 2 to 35 mOhm.cm².

8

9 It is then clear that the contact resistance measured is dependent on the measurement apparatus
10 and specifically on the electrode used. However, almost all studies found that the contact
11 resistance decreases with compression. Methods with gold coating gave relatively lower
12 electrical resistance values compared to those with bare stainless steel or copper surfaces and
13 the subtraction method gave a lower contact resistance compared to the TLM.

14

15 **4. Conclusion**

16 In order to study the effect of the variability of the mechanical stress exerted on a GDL inside
17 a PEMFC, a cyclic mechanical compression was applied on a variety of carbon paper GDLs
18 while measuring their specific electrical contact resistance with the BPP using the TLM method.
19 The influence of the GDL structure and composition was analysed. The experiments describe a
20 non-linear decrease of the electrical contact resistance with compression, a very rapid reduction
21 from 0 to 3 MPa, then a slower one from 3 to 8 MPa. A pressure of 2.5 MPa exerted on GDLs
22 should be sufficient to insure an acceptable range of contact resistance inside a PEMFC.
23 Besides, this contact resistance is affected by the cycles of compression. The difference between
24 cycles of the contact resistance and the strain tends, however, to decrease with higher
25 compression values. Furthermore, it is notable that the mean electrical contact resistance is
26 almost constant over the three consecutive mechanical tests for all GDLs and that generally, the
27 electrical difference between cycles tends to decrease along the tests.

28 Regarding the impact of composition and structure, in terms of electrical contact resistance,
29 graphitised GDLs displayed the smallest contact resistance followed by MPL covered GDLs
30 (MPL side) then felt and straight fibre paper GDLs. In terms of stiffness, the felt carbon
31 structure and the MPL side of the SGL 24 BC, exhibited, again closely, the highest rigidity.
32 Besides, it is noteworthy that the PTFE increased the mechanical stiffness of the GDL,
33 increasing with that the contact resistance. Finally, PTFE treated GDLs and graphitised
34 structures were stiffer than the simple untreated GDLs. In terms of the difference between the
35 cycles of compression, the felt GDL structure was denoted as the least sensitive to cyclic
36 compression and the double layer GDL 24 BC as the most affected. The mechanical difference
37 between cycles explains a substantial part of the electrical one, such as the felt structure and the
38 double layer's behaviours but it is still not sufficient to explain all the impacts of GDL
39 composition. For example, the PTFE increased the electrical difference between cycles and
40 decreased the mechanical one.

41 This work has been conducted under room temperature and humidity conditions. A possible
42 extension to this study is to conduct the measurements inside an environmental chamber
43 applying FC humidity and temperature conditions. The contact resistivities measured in this
44 research can also be used in numerical models to evaluate the global contact resistance and the
45 Ohmic losses regarding the pressure distribution on GDLs.

46

47

48

49

50

51 **Acknowledgements:**

52 The “Région Bourgogne-Franche-Comté” is gratefully acknowledged for its support through
53 the ELICOP Project (Ref. 2015C-4944 and 2015-4948). The French “Ministère de
54 l'Enseignement supérieur, de la Recherche et de l'Innovation” is gratefully acknowledged for
55 the funding of Khadidja Bouziane’s PhD Thesis (Contrat doctoral Univ. Paris Sud n°2017-225).
56 In addition, the authors would like to gratefully acknowledge the Plastic Omnium Company for
57 the support given to this research project.

58

59

60 **List of Figures:**

61 Fig. 1: Graphic summarising the experimental procedure to estimate the electrical contact resistance
62 between the GDL and the BPP under cyclic mechanical compression. a) Experimental set-up, b)
63 Contact resistance (R_c) extraction. 12
64 Fig. 2: Applied mechanical load..... 13
65 Fig. 3: Real $R_t = f(d)$ and least square line for SGL 24 AA, first test. 17
66 Fig. 4: Stress-strain curves. 19
67 Fig. 5: a) Electrical contact resistance as a function of the applied stress for the third test. b) Electrical
68 contact resistance at 1.5 and 2.5 MPa..... 21
69 Fig. 6: The difference of Contact resistance between cycles as a function of compression pressure: the
70 relative difference $RC\rho_c$ at low pressure and b) at high pressure. The absolute difference $C\rho_c$ c) at low
71 pressure and d) at high pressure. 25
72 Fig. 7: Strain difference between cycles for 1, 3, 6 and 8 MPa..... 26
73 Fig. 8: Electrical contact resistance as a function of the applied stress for the three tests performed with
74 SGL 24 AA..... 28

75

76 **List of Tables:**

77 Table 1: GDL sample type. 11
78 Table 2: Distances between the two indenters. 14
79 Table 3: Uncertainty of the contact resistance (3rd test).....23
80 Table 4: The electrical contact resistance measured with different methods described in the literature
81 and in this study..... 32

82

83 **References:**

- 84 [1] W.R.W. Daud, R.E. Rosli, E.H. Majlan, S.A.A. Hamid, R. Mohamed, T. Husaini, PEM fuel cell
85 system control: A review, *Renewable Energy* 113 (2017) 620–638.
86 <https://doi.org/10.1016/j.renene.2017.06.027>.
- 87 [2] S. Mekhilef, R. Saidur, A. Safari, Comparative study of different fuel cell technologies,
88 *Renewable and Sustainable Energy Reviews* 16 (2012) 981–989.
89 <https://doi.org/10.1016/j.rser.2011.09.020>.
- 90 [3] A. Kazim, Introduction of PEM fuel-cell vehicles in the transportation sector of the United Arab
91 Emirates, *Applied Energy* 74 (2003) 125–133. [https://doi.org/10.1016/S0306-2619\(02\)00138-1](https://doi.org/10.1016/S0306-2619(02)00138-1).
- 92 [4] G. Giacoppo, S. Hovland, O. Barbera, 2 kW Modular PEM fuel cell stack for space applications:
93 Development and test for operation under relevant conditions, *Applied Energy* 242 (2019)
94 1683–1696. <https://doi.org/10.1016/j.apenergy.2019.03.188>.
- 95 [5] D. Hart, F. Lehner, R. Rose, J. Lewis, Klippenstein M., The fuel cell industry review 2017.
96 <http://www.fuelcellindustryreview.com/archive/TheFuelCellIndustryReview2017.pdf> (accessed
97 14 May 2019).
- 98 [6] R. Salim, M. Nabag, H. Noura, A. Fardoun, The parameter identification of the Nexa 1.2 kW
99 PEMFC's model using particle swarm optimization, *Renewable Energy* 82 (2015) 26–34.
100 <https://doi.org/10.1016/j.renene.2014.10.012>.
- 101 [7] J. Park, H. Oh, T. Ha, Y.I. Lee, K. Min, A review of the gas diffusion layer in proton exchange
102 membrane fuel cells: Durability and degradation, *Applied Energy* 155 (2015) 866–880.
103 <https://doi.org/10.1016/j.apenergy.2015.06.068>.
- 104 [8] P. Pei, H. Chen, Main factors affecting the lifetime of Proton Exchange Membrane fuel cells in
105 vehicle applications: A review, *Applied Energy* 125 (2014) 60–75.
106 <https://doi.org/10.1016/j.apenergy.2014.03.048>.
- 107 [9] H. Zhang, X. Li, X. Liu, J. Yan, Enhancing fuel cell durability for fuel cell plug-in hybrid electric
108 vehicles through strategic power management, *Applied Energy* 241 (2019) 483–490.
109 <https://doi.org/10.1016/j.apenergy.2019.02.040>.
- 110 [10] A.D. J. Larminie, *Fuel Cell Systems Explained*, John Wiley & Sons, 2013.
- 111 [11] A.M. B. Blunier, *Piles à combustible: Principes, modélisation, applications avec exercices et*
112 *problèmes corrigés*, 2007.
- 113 [12] E. Alizadeh, M.M. Barzegari, M. Momenifar, M. Ghadimi, S.H.M. Saadat, Investigation of contact
114 pressure distribution over the active area of PEM fuel cell stack, *International Journal of*
115 *Hydrogen Energy* 41 (2016) 3062–3071. <https://doi.org/10.1016/j.ijhydene.2015.12.057>.
- 116 [13] Y. Hou, X. Zhang, X. Lu, D. Hao, L. Ma, P. Li, AC impedance characteristics of a vehicle PEM fuel
117 cell stack under strengthened road vibrating conditions, *International Journal of Hydrogen*
118 *Energy* 39 (2014) 18362–18368. <https://doi.org/10.1016/j.ijhydene.2014.09.054>.
- 119 [14] C.J. Netwall, B.D. Gould, J.A. Rodgers, N.J. Nasello, K.E. Swider-Lyons, Decreasing contact
120 resistance in proton-exchange membrane fuel cells with metal bipolar plates, *Journal of Power*
121 *Sources* 227 (2013) 137–144. <https://doi.org/10.1016/j.jpowsour.2012.11.012>.

- 122 [15] D. Ye, E. Gauthier, J.B. Benziger, M. Pan, Bulk and contact resistances of gas diffusion layers in
123 proton exchange membrane fuel cells, *Journal of Power Sources* 256 (2014) 449–456.
124 <https://doi.org/10.1016/j.jpowsour.2014.01.082>.
- 125 [16] E. Alizadeh, M. Ghadimi, M.M. Barzegari, M. Momenifar, S.H.M. Saadat, Development of
126 contact pressure distribution of PEM fuel cell's MEA using novel clamping mechanism, *Energy*
127 131 (2017) 92–97. <https://doi.org/10.1016/j.energy.2017.05.036>.
- 128 [17] R. Banan, A. Bazylak, J. Zu, Combined effects of environmental vibrations and hygrothermal
129 fatigue on mechanical damage in PEM fuel cells, *International Journal of Hydrogen Energy* 40
130 (2015) 1911–1922. <https://doi.org/10.1016/j.ijhydene.2014.11.125>.
- 131 [18] A. Bates, S. Mukherjee, S. Hwang, S.C. Lee, O. Kwon, G.H. Choi, S. Park, Simulation and
132 experimental analysis of the clamping pressure distribution in a PEM fuel cell stack,
133 *International Journal of Hydrogen Energy* 38 (2013) 6481–6493.
134 <https://doi.org/10.1016/j.ijhydene.2013.03.049>.
- 135 [19] S. El Oualid, R. Lachat, D. Candusso, Y. Meyer, Characterization process to measure the electrical
136 contact resistance of Gas Diffusion Layers under mechanical static compressive loads,
137 *International Journal of Hydrogen Energy* 42 (2017) 23920–23931.
138 <https://doi.org/10.1016/j.ijhydene.2017.03.130>.
- 139 [20] P.A. Gigos, Y. Faydi, Y. Meyer, Mechanical characterization and analytical modeling of gas
140 diffusion layers under cyclic compression, *International Journal of Hydrogen Energy* 40 (2015)
141 5958–5965. <https://doi.org/10.1016/j.ijhydene.2015.02.136>.
- 142 [21] S.R. Dhanushkodi, F. Capitanio, T. Biggs, W. Mérida, Understanding flexural, mechanical and
143 physico-chemical properties of gas diffusion layers for polymer membrane fuel cell and
144 electrolyzer systems, *International Journal of Hydrogen Energy* 40 (2015) 16846–16859.
145 <https://doi.org/10.1016/j.ijhydene.2015.07.033>.
- 146 [22] S. Chevalier, N. Lavielle, B.D. Hatton, A. Bazylak, Novel electrospun gas diffusion layers for
147 polymer electrolyte membrane fuel cells: Part I. Fabrication, morphological characterization,
148 and in situ performance, *Journal of Power Sources* 352 (2017) 272–280.
149 <https://doi.org/10.1016/j.jpowsour.2017.03.098>.
- 150 [23] X. Xie, R. Wang, K. Jiao, G. Zhang, J. Zhou, Q. Du, Investigation of the effect of micro-porous
151 layer on PEM fuel cell cold start operation, *Renewable Energy* 117 (2018) 125–134.
152 <https://doi.org/10.1016/j.renene.2017.10.039>.
- 153 [24] A. Forner-Cuenca, J. Biesdorf, L. Gubler, P.M. Kristiansen, T.J. Schmidt, P. Boillat, Engineered
154 Water Highways in Fuel Cells: Radiation Grafting of Gas Diffusion Layers, *Adv. Mater. Weinheim.*
155 27 (2015) 6317–6322. <https://doi.org/10.1002/adma.201503557>.
- 156 [25] D. Gerteisen, C. Sadeler, Stability and performance improvement of a polymer electrolyte
157 membrane fuel cell stack by laser perforation of gas diffusion layers, *Journal of Power Sources*
158 195 (2010) 5252–5257. <https://doi.org/10.1016/j.jpowsour.2010.03.021>.
- 159 [26] D. Gerteisen, T. Heilmann, C. Ziegler, Enhancing liquid water transport by laser perforation of a
160 GDL in a PEM fuel cell, *Journal of Power Sources* 177 (2008) 348–354.
161 <https://doi.org/10.1016/j.jpowsour.2007.11.080>.

- 162 [27] J.H. Chun, D.H. Jo, S.G. Kim, S.H. Park, C.H. Lee, E.S. Lee, J.-Y. Jyoung, S.H. Kim, Development of a
163 porosity-graded micro porous layer using thermal expandable graphite for proton exchange
164 membrane fuel cells, *Renewable Energy* 58 (2013) 28–33.
165 <https://doi.org/10.1016/j.renene.2013.02.025>.
- 166 [28] M. Im Kong, J.W. Choi, S.I. Kim, E.S. Lee, M.S. Kim, Experimental study on the self-humidification
167 effect in proton exchange membrane fuel cells containing double gas diffusion backing layer,
168 *Applied Energy* 145 (2015) 345–353. <https://doi.org/10.1016/j.apenergy.2015.02.027>.
- 169 [29] M. Im Kong, A. Jung, M.S. Kim, Investigations on the double gas diffusion backing layer for
170 performance improvement of self-humidified proton exchange membrane fuel cells, *Applied*
171 *Energy* 176 (2016) 149–156. <https://doi.org/10.1016/j.apenergy.2016.05.057>.
- 172 [30] E.E. Kahveci, I. Taymaz, Experimental study on performance evaluation of PEM fuel cell by
173 coating bipolar plate with materials having different contact angle, *Fuel* 253 (2019) 1274–1281.
174 <https://doi.org/10.1016/j.fuel.2019.05.110>.
- 175 [31] O.S. Burheim, G.A. Crymble, R. Bock, N. Hussain, S. Pasupathi, A. Du Plessis, S. Le Roux, F.
176 Seland, H. Su, B.G. Pollet, Thermal conductivity in the three layered regions of micro porous
177 layer coated porous transport layers for the PEM fuel cell, *International Journal of Hydrogen*
178 *Energy* 40 (2015) 16775–16785. <https://doi.org/10.1016/j.ijhydene.2015.07.169>.
- 179 [32] Y. Faydi, R. Lachat, Y. Meyer, Thermomechanical characterisation of commercial Gas Diffusion
180 Layers of a Proton Exchange Membrane Fuel Cell for high compressive pre-loads under dynamic
181 excitation, *Fuel* 182 (2016) 124–130. <https://doi.org/10.1016/j.fuel.2016.05.074>.
- 182 [33] H. Sadeghifar, N. Djilali, M. Bahrami, Thermal conductivity of a graphite bipolar plate (BPP) and
183 its thermal contact resistance with fuel cell gas diffusion layers: Effect of compression, PTFE,
184 micro porous layer (MPL), BPP out-of-flatness and cyclic load, *Journal of Power Sources* 273
185 (2015) 96–104. <https://doi.org/10.1016/j.jpowsour.2014.09.062>.
- 186 [34] S. Prass, S. Hasanpour, P.K. Sow, A.B. Phillion, W. Mérida, Microscale X-ray tomographic
187 investigation of the interfacial morphology between the catalyst and micro porous layers in
188 proton exchange membrane fuel cells, *Journal of Power Sources* 319 (2016) 82–89.
189 <https://doi.org/10.1016/j.jpowsour.2016.04.031>.
- 190 [35] A.H. Mahmoudi, A. Ramiar, Q. Esmaili, Effect of inhomogeneous compression of gas diffusion
191 layer on the performance of PEMFC with interdigitated flow field, *Energy Conversion and*
192 *Management* 110 (2016) 78–89. <https://doi.org/10.1016/j.enconman.2015.12.012>.
- 193 [36] H. Ishikawa, T. Teramoto, Y. Ueyama, Y. Sugawara, Y. Sakiyama, M. Kusakabe, K. Miyatake, M.
194 Uchida, Use of a sub-gasket and soft gas diffusion layer to mitigate mechanical degradation of a
195 hydrocarbon membrane for polymer electrolyte fuel cells in wet-dry cycling, *Journal of Power*
196 *Sources* 325 (2016) 35–41. <https://doi.org/10.1016/j.jpowsour.2016.06.012>.
- 197 [37] G.M. Domínguez Almaraz, J.A. Ruiz Vilchez, A. Domínguez, Y. Meyer, Ultrasonic Fatigue
198 Endurance of Thin Carbon Fiber Sheets, *Metall and Mat Trans A* 47 (2016) 1654–1660.
199 <https://doi.org/10.1007/s11661-016-3350-9>.
- 200 [38] N. Ul Hassan, M. Kilic, E. Okumus, B. Tunaboylu, A.M. Soydan, Experimental determination of
201 optimal clamping torque for AB-PEM Fuel cell, *J. Electrochem. Sci. Eng.* 6 (2016) 9.
202 <https://doi.org/10.5599/jese.198>.

- 203 [39] D. Singdeo, T. Dey, P.C. Ghosh, Contact resistance between bipolar plate and gas diffusion layer
204 in high temperature polymer electrolyte fuel cells, *International Journal of Hydrogen Energy* 39
205 (2014) 987–995. <https://doi.org/10.1016/j.ijhydene.2013.10.147>.
- 206 [40] M.S. Ismail, D.B. Ingham, L. Ma, M. Pourkashanian, The contact resistance between gas diffusion
207 layers and bipolar plates as they are assembled in proton exchange membrane fuel cells,
208 *Renewable Energy* 52 (2013) 40–45. <https://doi.org/10.1016/j.renene.2012.10.025>.
- 209 [41] C.-H. Chien, Y.-L. Hu, T.-H. Su, H.-T. Liu, C.-T. Wang, P.-F. Yang, Y.-X. Lu, Effects of bolt pre-
210 loading variations on performance of GDL in a bolted PEMFC by 3-D FEM analysis, *Energy* 113
211 (2016) 1174–1187. <https://doi.org/10.1016/j.energy.2016.07.075>.
- 212 [42] K.D. Baik, S.I. Kim, B.K. Hong, K. Han, M.S. Kim, Effects of gas diffusion layer structure on the
213 open circuit voltage and hydrogen crossover of polymer electrolyte membrane fuel cells,
214 *International Journal of Hydrogen Energy* 36 (2011) 9916–9925.
215 <https://doi.org/10.1016/j.ijhydene.2011.05.088>.
- 216 [43] Ö. Aydin, M. Zedda, N. Zamel, U. Groos, C. Hebling, Comprehensive Understanding of Electrical
217 Conductivity Measurements of Gas Diffusion Media of PEM Fuel Cells, in: 20th World hydrogen
218 energy conference (WHEC 2014): Gwangju, South Korea, 15-20 June 2014, Committee of WHEC,
219 Gwangju, South Korea, 2014.
- 220 [44] Ö. Aydin, M. Zedda, N. Zamel, Challenges Associated with Measuring the Intrinsic Electrical
221 Conductivity of Carbon Paper Diffusion Media, *Fuel Cells* 15 (2015) 537–544.
222 <https://doi.org/10.1002/fuce.201400125>.
- 223 [45] M. Ahmad, R. Harrison, J. Meredith, A. Bindel, B. Todd, Validation of a fuel cell compression
224 spring equivalent model using polarisation data, *International Journal of Hydrogen Energy* 42
225 (2017) 8109–8118. <https://doi.org/10.1016/j.ijhydene.2017.01.216>.
- 226 [46] M. Hamour, J.C. Grandidier, A. Ouibrahim, S. Martemianov, Electrical conductivity of PEMFC
227 under loading, *Journal of Power Sources* 289 (2015) 160–167.
228 <https://doi.org/10.1016/j.jpowsour.2015.04.145>.
- 229 [47] T.J. Mason, J. Millichamp, P.R. Shearing, D.J.L. Brett, A study of the effect of compression on the
230 performance of polymer electrolyte fuel cells using electrochemical impedance spectroscopy
231 and dimensional change analysis, *International Journal of Hydrogen Energy* 38 (2013) 7414–
232 7422. <https://doi.org/10.1016/j.ijhydene.2013.04.021>.
- 233 [48] M. Zhiani, S. Kamali, S. Majidi, In-plane gas permeability and thought-plane resistivity of the gas
234 diffusion layer influenced by homogenization technique and its effect on the proton exchange
235 membrane fuel cell cathode performance, *International Journal of Hydrogen Energy* 41 (2016)
236 1112–1119. <https://doi.org/10.1016/j.ijhydene.2015.10.052>.
- 237 [49] E.M. Khetabi, K. Bouziane, N. Zamel, X. François, Y. Meyer, D. Candusso, Effects of mechanical
238 compression on the performance of polymer electrolyte fuel cells and analysis through in-situ
239 characterisation techniques - A review, *Journal of Power Sources* 424 (2019) 8–26.
240 <https://doi.org/10.1016/j.jpowsour.2019.03.071>.
- 241 [50] N. Zamel, X. Li, J. Shen, Numerical estimation of the effective electrical conductivity in carbon
242 paper diffusion media, *Applied Energy* 93 (2012) 39–44.
243 <https://doi.org/10.1016/j.apenergy.2011.08.037>.

- 244 [51] M.S. Ismail, K.J. Hughes, D.B. Ingham, L. Ma, M. Pourkashanian, Effects of anisotropic
245 permeability and electrical conductivity of gas diffusion layers on the performance of proton
246 exchange membrane fuel cells, *Applied Energy* 95 (2012) 50–63.
247 <https://doi.org/10.1016/j.apenergy.2012.02.003>.
- 248 [52] M.S. Ismail, T. Damjanovic, D.B. Ingham, M. Pourkashanian, A. Westwood, Effect of
249 polytetrafluoroethylene-treatment and microporous layer-coating on the electrical conductivity
250 of gas diffusion layers used in proton exchange membrane fuel cells, *Journal of Power Sources*
251 195 (2010) 2700–2708. <https://doi.org/10.1016/j.jpowsour.2009.11.069>.
- 252 [53] D. Todd, S. Bennett, W. Mérida, Anisotropic electrical resistance of proton exchange membrane
253 fuel cell transport layers as a function of cyclic strain, *International Journal of Hydrogen Energy*
254 41 (2016) 6029–6035. <https://doi.org/10.1016/j.ijhydene.2016.02.111>.
- 255 [54] D. Qiu, H. Janßen, L. Peng, P. Irmscher, X. Lai, W. Lehnert, Electrical resistance and
256 microstructure of typical gas diffusion layers for proton exchange membrane fuel cell under
257 compression, *Applied Energy* 231 (2018) 127–137.
258 <https://doi.org/10.1016/j.apenergy.2018.09.117>.
- 259 [55] T.J. Mason, J. Millichamp, T.P. Neville, A. El-kharouf, B.G. Pollet, D.J.L. Brett, Effect of clamping
260 pressure on ohmic resistance and compression of gas diffusion layers for polymer electrolyte
261 fuel cells, *Journal of Power Sources* 219 (2012) 52–59.
262 <https://doi.org/10.1016/j.jpowsour.2012.07.021>.
- 263 [56] A. Miyazawa, T. Himeno, A. Nishikata, Electrical properties of bipolar plate and gas diffusion
264 layer in PEFC, *Journal of Power Sources* 220 (2012) 199–204.
265 <https://doi.org/10.1016/j.jpowsour.2012.07.127>.
- 266 [57] A. El-kharouf, T.J. Mason, D.J.L. Brett, B.G. Pollet, Ex-situ characterisation of gas diffusion layers
267 for proton exchange membrane fuel cells, *Journal of Power Sources* 218 (2012) 393–404.
268 <https://doi.org/10.1016/j.jpowsour.2012.06.099>.
- 269 [58] X. Lai, D.'a. Liu, L. Peng, J. Ni, A mechanical–electrical finite element method model for
270 predicting contact resistance between bipolar plate and gas diffusion layer in PEM fuel cells,
271 *Journal of Power Sources* 182 (2008) 153–159. <https://doi.org/10.1016/j.jpowsour.2008.03.069>.
- 272 [59] L. Zhang, Y. Liu, H. Song, S. Wang, Y. Zhou, S.J. Hu, Estimation of contact resistance in proton
273 exchange membrane fuel cells, *Journal of Power Sources* 162 (2006) 1165–1171.
274 <https://doi.org/10.1016/j.jpowsour.2006.07.070>.
- 275 [60] P. Zhou, P. Lin, C.W. Wu, Z. Li, Effect of nonuniformity of the contact pressure distribution on
276 the electrical contact resistance in proton exchange membrane fuel cells, *International Journal*
277 *of Hydrogen Energy* 36 (2011) 6039–6044. <https://doi.org/10.1016/j.ijhydene.2011.01.080>.
- 278 [61] Fuel Cell store, Toray Carbon Fiber Paper “TGP-H”.
279 <https://www.fuelcellsetc.com/store/DS/Toray-Paper-TGP-H-Datasheet.pdf> (accessed 14 May
280 2019).
- 281 [62] Fuel Cell store, FREUDENBERG Gas Diffusion Layers for PEMFC and DMFC.
282 <http://www.fuelcellstore.com/spec-sheets/freudenberg-gdl-technical-data.pdf>.

- 283 [63] Tuttle. G, Contact resistance and TLM measurements.
284 http://tuttle.merc.iastate.edu/ee432/topics/metals/tlm_measurements.pdf (accessed 14 May
285 2019).
- 286 [64] W. Shockley, Research and investigation of inverse epitaxial UHF power transistors: A1-TOR-64-
287 20, Wright-Patterson Air Force Base, USA, 1964.
- 288 [65] D.K. Schroder, Semiconductor Material and Device Characterization, John Wiley & Sons, Inc,
289 Hoboken, NJ, USA, 2005.
- 290 [66] H. Murrmann, D. Widmann, Current crowding on metal contacts to planar devices, IEEE Trans.
291 Electron Devices 16 (1969) 1022–1024. <https://doi.org/10.1109/T-ED.1969.16904>.
- 292 [67] H. Murrmann, D. Widmann, Messung des Übergangswiderstandes zwischen Metall und
293 Diffusionsschicht. Si-Planarelementen, Solid-state Electronics 12 (1969) 879–886.
- 294 [68] H.H. Berger, Contact Resistance and Contact Resistivity, J. Electrochem. Soc. 119 (1972) 507.
295 <https://doi.org/10.1149/1.2404240>.
- 296 [69] Joint Committee for Guides in Metrology. Evaluation of measurement data — Guide to the
297 expression of uncertainty in measurement. September 2008.
298 https://www.bipm.org/utis/common/documents/jcgm/JCGM_100_2008_E.pdf (accessed 23
299 January 2020).
- 300 [70] A. El-kharouf, R. Steinberger-Wilckens, The Effect of Clamping Pressure on Gas Diffusion Layer
301 Performance in Polymer Electrolyte Fuel Cells, Fuel Cells 15 (2015) 802–812.
302 <https://doi.org/10.1002/fuce.201500088>.
- 303