



HAL
open science

WASCOP (Water Saving for Solar Concentrated Power): Water Management Guide

Christopher Sansom, Kumar Patchigolla

► **To cite this version:**

Christopher Sansom, Kumar Patchigolla. WASCOP (Water Saving for Solar Concentrated Power): Water Management Guide. [Technical Report] Cranfield University. 2020. hal-02482491

HAL Id: hal-02482491

<https://hal.science/hal-02482491>

Submitted on 18 Feb 2020

HAL is a multi-disciplinary open access archive for the deposit and dissemination of scientific research documents, whether they are published or not. The documents may come from teaching and research institutions in France or abroad, or from public or private research centers.

L'archive ouverte pluridisciplinaire **HAL**, est destinée au dépôt et à la diffusion de documents scientifiques de niveau recherche, publiés ou non, émanant des établissements d'enseignement et de recherche français ou étrangers, des laboratoires publics ou privés.



H2020-LCE-02-2015

Developing the next generation technologies of renewable electricity and heating/cooling

WASCOP

Water Saving for Solar Concentrated Power

Starting date of the project: 01/01/2016
Duration: 48 months

= Deliverable: D4.2 = Water Management Guide

Due date of deliverable: 30/04/2017
Actual submission date: 05/05/2017

Responsible WP: Samir RACHIDI, WP4, MASEN
Responsible TL: Chris SANSOM, Cranfield University
Revision: V1.3

Dissemination level		
PU	Public	X
PP	Restricted to other programme participants (including the Commission Services)	
RE	Restricted to a group specified by the consortium (including the Commission Services)	
CO	Confidential, only for members of the consortium (including the Commission Services)	

AUTHOR

Main Author	Institution	Contact (e-mail, phone)
Dr. C L Sansom	Cranfield University	c.l.sansom@cranfield.ac.uk
Dr. Kumar Patchigolla	Cranfield University	k.patchigolla@cranfield.ac.uk

DOCUMENT CONTROL

Document version	Date	Change
V1.1	30/04/2017	First version
V1.2	04/05/2017	Minor changes incorporated by coordinator
V1.3	05/05/2017	Minor changes incorporated by project manager

VALIDATION

Reviewers		Validation date
Work Package Leader	Samir RACHIDI	30/04/2017
Project Manager	Fabrizio PERROTTA	04/05/2017
Exploitation Manager	Bernard THONON	04/05/2017
Coordinator	Delphine BOURDON	04/05/2017

DOCUMENT DATA

Keywords	Water management, Guide
Point of Contact	Name: Dr. C L Sansom Partner: Cranfield University Address: Precision Engineering Institute, Building 90, Cranfield University MK43 0AL, UK Phone: +44 1234 752955 E-mail: c.l.sansom@cranfield.ac.uk
Delivery date	05/05/2017

DISTRIBUTION LIST

Date	Issue	Recipients
30/04/2017	V1.1	Coordinator and Exploitation Manager
05/05/2017	V1.3	All partners and PO

Executive Summary

This report forms WASCOP deliverable D4.2 entitled “Water Management Guide”. The Report arises from the work done in order to complete Task 4.1, and has been completed on schedule in M16 (April 2017). The Report (and deliverable D4.2) has “Public” dissemination level.

The work in Task 4.1 was led by Cranfield University, with significant contributions from CIEMAT-PSA, and additional contributions from MASEN.

The main aim of Task 4.1 was to establish and analyze the current CSP plant water consumption, and predict the reduction in water consumption that could occur if novel cooling and cleaning technologies were to be adopted. As a result, the task was aligned around two main sub-tasks, each with its own deliverable in Month 16 (April 2017):

- Publish a public document entitled “CSP Plant Water Management Guide”. This document (Deliverable D4.2) provides a description of the current water consumption in CSP plants and outlines the reductions that can be achieved with the adoption of a number of new technologies in cleaning and cooling.
- Publish a confidential report entitled “Analysis of water consumption in CSP plants”. This report (Deliverable D4.1) provides a detailed model of the water consumption in CSP plants, and provides a simple means of predicting the reductions in water consumption that can be achieved for a range of novel technological improvements in the cooling and cleaning systems (including those developed under WASCOP).

This current document includes Deliverable D4.2, The Water Management Guide. Deliverable 4.1 is published in a separate document.

The information contained in this document was assembled by the WASCOP partners, with additional input from the following sources:

- Joint WASCOP/MinWaterCSP workshop on “CSP plant water consumption” at CIEMAT-PSA on November 29th 2016, attended by 28 external delegates including plant owners, plant operators, plant maintenance and other service providers, and organized by the WASCOP WP4 participants.
- An on-line questionnaire, sent to a number of CSP plant stakeholders in March 2017.
- A Cranfield University MSc group project on “CSP plant water consumption”, School of Water, Energy, and Environment, Feb-Apr 2017.

Table of Contents

1. Introduction.....	6
2. System Description	6
2.1. Cooling.....	6
2.2. Cleaning	6
3. Current Practice	7
3.1. Cleaning	7
3.1.1. Technology.....	7
3.1.2. Environmental Aspects	9
3.1.3. Economic Aspects.....	9
3.1.4. Advantages/Disadvantages of Current Systems	10
3.1.5. Cleaning Machines	10
3.2. Cooling.....	14
3.2.1. Technology.....	14
3.2.2. Environmental Aspects	18
3.2.3. Economic Aspects.....	18
4. Technology being developed under WASCOP.....	20
4.1. Cleaning	20
4.1.1. Technology.....	20
4.1.2. Environmental Aspects	21
4.1.3. Economic Aspects.....	22
4.2. Cooling.....	22
4.2.1. Technology.....	22
4.2.2. Environmental Aspects	25
4.2.3. Economic Aspects.....	25
4.2.4. Advantages/Disadvantages of Innovative Cooling Systems.....	26
5. Future/Other Technologies	27
5.1. Cleaning	27
5.1.1. Technology.....	27
5.1.2. Economic Aspects.....	29
5.1.3. Advantages/Disadvantages of Novel Cleaning Systems	29
5.2. Cooling.....	30
5.2.1. Technology.....	30
5.2.2. Environmental Aspects	31
5.2.3. Economic Aspects.....	31
5.2.4. Advantages/Disadvantages of Novel Cooling Systems.....	31
6. Conclusion	32
7. Reference List.....	33

List of Figures/Tables

Figure 1 - The traditional high-pressure, low water volume system	8
Figure 2 - High-pressure, low water volume, with rotating head rig system.....	8
Figure 3 - The traditional deluge method in operation	8
Figure 4 - High pressure cleaner vehicle with cleaning brushes	9
Table 1 - Current Cleaning Systems Advantages/Disadvantages	10
Figure 5 - ECILIPM vehicle for solar mirror cleaning.....	11
Figure 6 - ALBATROS Cleaning Vehicle.....	11
Figure 7 - ELCOS Vehicle for pressurised water-cleaning of solar mirrors	12
Figure 8 - PARIS Cleaning Vehicle	13
Figure 9 - FERMUPE Cleaning Vehicle.....	13
Figure 10 - ABENGOA Cleaning Vehicle	14
Figure 11 - Schematic diagram of the once-through WCC system [7]	15
Figure 12 - Schematic diagram of the circulating evaporative WCC system [7].....	15
Figure 13 - Schematic diagram of direct ACC system [7]	16
Figure 14 - Schematic diagram of Heller ACC system [7]	17
Figure 15 - Schematic diagram of Hybrid system [7]	18
Table 2 - Typical water requirements of an operating CSP plant depending on its cooling system..	18
Table 3 - Comparison of efficiency reduction by cooling system for each type of CSP plant [7].....	19
Table 4 - Comparison of Capital cost increase by cooling system for each type of CSP plant [7]	19
Table 5 - Comparison of electricity unit cost increase by cooling system type of CSP plant [7]	19
Figure 16 - WASCOP Cleaning approach scheme	20
Table 6 - Water savings of WASCOP solution for cleaning [8]	22
Figure 17 - WASCOP scheme for CSP cooling power block.....	23
Figure 18 -Scheme of heat storage on the cooling loop [WASCOP REPORT]	24
Figure 19 - Hybridized cooling system [WASCOP Report]	24
Figure 20; Versatile Adiabatic Cooler	25
Table 7: Innovative coolers.....	26
Figure 21 - EDS Principle.....	28
Figure 22 - Eccopia cleaning machine for PV panels	28
Figure 23 - Cleaning railed robot for parabolic mirrors [16]	29

1. Introduction

Today more than ever technologies that produce green energy are playing a growing role in meeting the world's energy demands. CSP is most effective around the sun-belt where DNI levels are at their highest. The main challenge of building CSP plants in these areas are the scarcity of water which is used for cleaning and cooling. According to a survey of plant operators, the typical average water consumption of a 50 MW_e wet cooled parabolic trough plant is around 400,000-500,000 m³/year of which 10-20% is used for cleaning and 80-90% for cooling. Therefore, by efficiently managing the water usage the effectiveness of the plants increase. Under the WASCOP project, new technologies are being developed and tested to prevent losses in efficiency while reducing water consumption.

2. System Description

2.1. Cooling

A CSP plant utilizes a conventional steam turbine and differs from a conventional fossil fuel fired plant only in that the thermal input is provided by the solar field. In a steam turbine, water enters the system from the condenser then it is pumped to the boiler where water will be totally transformed into steam. After the expansion in the turbine, a portion of the steam return to water, and the rest is still in a steam stage. In other words, one has a steam with a quality less than 1. To be able to reuse this steam, or water source again, one needs to cool down the steam to return it to the subcooled region. This phenomenon take place in the condenser. Water is then pumped into the system for another cycle.

A steam turbine operates based on the Rankine cycle. The lower the temperature after cooling the higher the efficiency achieved by the turbine. It can therefore be concluded that the cooling system has a great impact on the plant.

There are three different methods for cooling: wet, dry and hybrid. The wet cooling has the highest efficiency among its peers. However, due to the likely location of a CSP plant in an arid site, water is scarce and thus one is required to transport water to the site either by trucks or by pipeline installation. At best, local wells or rivers can be used, but the depletion of these water courses can cause adverse environmental impacts on local communities and local agriculture. Moreover, the cost associated with providing water in this way is very high. A dry cooling system uses air as a medium of cooling. This system is the most efficient when it comes to water usage, however it has an adverse impact on the efficiency of the plant. A hybrid system may reduce water consumption by more than 70% compared to the wet cooling however it can have a significant negative impact on the capital cost of the system.

2.2. Cleaning

Large CSP plants require a substantial mirror area, typically in a desert or arid environment. Due to the high DNI in these areas they prove to be ideal locations to harness solar energy. The problem faced are that the mirrors are subjected to dust and sand deposition which reduce the reflectance of the mirrors resulting in a reduction of power output and efficiency. Therefore, the mirrors need to be cleaned frequently to ensure that optimal reflectance is restored. There are three different

methods of mirror cleaning, wet, dry and hybrid. Wet cleaning has been found to be the most effective method of cleaning, normally with the use of demineralised water and a brush. However, due to the climate, the ideal CSP plant locations often have a scarcity of water which incur further costs of sourcing the water. In addition, the high quality water required to clean the mirrors significantly increase the O&M costs of the plant. Therefore, much research is being done to quantify the effectiveness of dry and hybrid cleaning solutions to reduce the amount of water usage for cleaning. Other research to better understand the transportation of dust and other particles are also being conducted in an attempt to mitigate the overall deposition on the mirror surface.

3. Current Practice

3.1. Cleaning

This section describes the current cleaning technologies used in CSP plants. A description of the methods employed and their results will be discussed as well as the environmental and economic impact of these technologies.

3.1.1. Technology

Most CSP plants are located in semi desert areas where the environment is characterized by high temperature variation, soiling ambiences and periodic dust storms. These environmental conditions are very aggressive on the mirror surface as storms of wind and dust particles reach the surface of the mirror and reflectors, decreasing the reflectance of the mirrors and the overall performance of the CSP plant. Wet or hybrid cleaning has been shown to be a more efficient way of cleaning the mirror surface and receiver compared to dry cleaning. Therefore, large amounts of demineralized water are consumed for washing the mirror surface and reflectors. 2 - 20% of the water used in CSP plant is used for cleaning operations which significantly increases the cost of operation and maintenance of the CSP plant.

The amount of water used in cleaning the mirrors and receiver tubes varies with the technology used and the frequency of cleaning. A detailed comparison of four different cleaning methods used for reflector washing and receiver tubes has been is described below. The results show the following methods and the amount of water consumed per square meter of the mirror surface.

The traditional high-pressure rig/low-water-volume

The traditional high-pressure rig/low-water-volume method uses the rig to move down one row and returns to clean the adjacent row, see Figure 1, with water delivered at pressure of 3,000 psi (207 bar). The high-pressure/low volume method uses 0.72 litres of demineralized water per square meter of reflector surface.



Figure 1: The traditional high-pressure, low water volume system

High-pressure with rotating head rig/low water volume;

In high-pressure, with rotating head/low water volume rig, water is supplied to the mirror surface by a rotating rig at high pressure, as shown in Figure 2. The pump can supply up to 170.3 litres per minute at a pressure of 3,500 psi (241 bar). Water use is about the same as in the traditional high-pressure rig/low-water-volume of around 0.72 litres of demineralized water per square meter of reflector surface.



Figure 2: High-pressure, low water volume, with rotating head rig system

Traditional deluge method (low-pressure/high-water-volume)

This method employs nozzles which supply water to rows of reflectors simultaneously with a “deluge-type” stream of water to parallel rows of reflectors. This method uses 0.87 litres of demineralized water per square meter of reflector surface, and is shown in Figure 3.



Figure 3: The traditional deluge method in operation

High pressure cleaner vehicle with demineralized water and cleaning brush;

In this method, demineralized water is pressurized to the mirror surface at a pressure range between 30 and 200 bar, at an appropriate water flow rate. The cleaning vehicles have two arms in the case of parabolic-trough collectors to clean upper and lower surfaces of the mirror and additional washing accessories such as soft thin brushes used to enhance the cleaning process. For heliostat cleaning, typically only one arm is needed. This technology uses a low volume of water and has high cleaning efficiency. See Figure 4.



Figure 4: High pressure cleaner vehicle with cleaning brushes

3.1.2. Environmental Aspects

Accessing water is an important challenge to use in CSP plant in desert areas, as available water resources are highly valued by many stakeholders. Water is used for cleaning the mirrors and receiver tubes to maintain their optical properties. Although the water used for cleaning is substantially lower than that used for cooling, it is significantly higher in desert areas where cleaning of the mirrors is carried out more frequently. The frequency of mirror cleaning can take place between every 2-14 days, typically. This does not include exceptional events such as dust storms and heavy rainfall. It also depends on the type of technology used for cleaning the mirror, as more efficient cleaning methods will use lower volumes of water which will impact less on the other stakeholders that use water for different activities in the vicinity of the plant.

3.1.3. Economic Aspects

All current cleaning technologies use water and brushes (sometimes water alone) to retain the optical surface in a suitable cleanliness level at a minimum cost whilst periodically returning the mirrors to their original reflectance and the receiver tube envelopes to their original transmittance. Some abrasion of the mirror surface can occur in contact cleaning, but any degradation in these optical properties usually has causes other than mirror cleaning, namely mirror erosion and corrosion and receiver tube envelope anti-reflective coating erosion.

Further research on cleaning technologies which use less water (or no water) include Transparent Electrodynamic screen (EDS), dry cleaning using mechanical brushes to clean mirror surfaces, air-blowers, anti-soiling coatings, dust barriers, soiling detectors, ultrasonic cleaners, and gravity lip systems. These are discussed later. All involve additional cost, but reduce water consumption.

3.1.4. Advantages/Disadvantages of Current Systems

Technology	Advantage	Disadvantage
The traditional high-pressure rig/low-water-volume	Cleaning attains reflectance value of the mirror at 0.72 litres of demineralized water per square meter of reflector surface	Uses relatively high volume of water
High-pressure with rotating head rig/low water volume	Cleaning attains reflectance value of the mirror at less than 0.72 litres of demineralized water per square meter of reflector surface	Uses relatively high volume of water
Traditional deluge method (low-pressure/high-water-volume)	Cleaning attains reflectance value of the mirror at 0.87 litres of demineralized water per square meter of reflector surface	Uses relatively high volume of water
High pressure cleaner vehicle with demineralized water and cleaning brush	Cleaning attains reflectance value of the mirror of about 99.7% of its original reflectance. Uses relatively low volume of water	Brush could damage the mirror surface if not soft enough

Table 1: Current Cleaning Systems Advantages/Disadvantages

3.1.5. Cleaning Machines

ECILIMP

The company ECILIMP TERMOSOLAR specialises in cleaning Heliostats and parabolic-trough collectors, ensuring optimal cleaning factors for the solar thermal plants where it provides service. ECILIMP TERMOSOLAR machines use rotary brushes with high pressurized water to perform wet mechanical cleaning [1].



Figure 5: ECILIMP vehicle for solar mirror cleaning

Features of ECILIMP cleaning machine (Figure 5):

- ECILIMP vehicles use high pressure demineralised water and brush cleaning tools
- Cleaning speed control : 0 – 5 km/h
- Chassis: high strength steel, 50% lighter than conventional vehicles.
- Tank: 8000L PRFV tank, shipping container dimension, front cabinet with shutter lock.
- Maximum relative reflectance of about 99.6% obtained with very low water consumptions.

ALBATROS

The ALBATROS cleaning system ensures maximum cleaning efficiency with low water consumption and reduced operator costs. In 2008 a collaboration between Albatros and Abengoa developed a completely new and innovative product for high pressure cleaning vehicles designed for use in solar thermal power plants [2].



Figure 6: ALBATROS Cleaning Vehicle

Features of ALBATROS cleaning machine (Figure 6):

- The vehicle has two arms to enable cleaning of both upper and lower part of the collector simultaneously.
- The vehicle has special software which guarantees the safety of the mirror and the receiver.
- The vehicles requires only one operator and hence reduces operating cost.
- The vehicles use brushes for cleaning to obtain maximum result at a speed between 1 – 3 km/h.
- The vehicles are built with special nozzles to clean the receiver tubes.

- Maximum relative reflectance of about 99.6% is obtained with very low water consumptions.

VOITH

Voith Turbo GmbH in Germany have developed the ELCOS vehicle for cleaning the mirror surfaces of parabolic trough collectors with pressurized water [3].



Figure 7: ELCOS Vehicle for pressurised water-cleaning of solar mirrors

Features of the VOITH cleaning machine (Figure 7):

- Built originally for cleaning individual mirror facets.
- ELCOS is fitted with special ultrasonic sensors that allow the sickle-shaped arm of the vehicle to work on the 6.40 meter-high mirror facets as closely as possible without touching them.
- Creep speed of 6km/h.
- ELCOS moves twice through each of the rows of mirrors and showers them down with water pressurized to 200 bar.
- Equipped with relevant monitors and cameras to give the driver full overview of the process.

SENER – THE PARIS SYSTEM

PARIS is a cleaning system designed, patented, manufactured and commercialized by SENNER that performs autonomous and distributed cleaning of Parabolic-Trough collector (PTC) plants, optimizing the cleaning with a minimum of operation costs.

The PARIS vehicles are autonomous, performing an unmanaged cleaning schedule by virtue of its GNC software.

PARIS performs a wet mechanical cleaning process using rotary brushes able to significantly raise the reflectance factor of the mirrors in just one passing. This efficiency allows reduced cleaning frequency as well as minimizing the water and fuel consumption [4].



Figure 8: PARIS Cleaning Vehicle

Features of PARIS cleaning machine (Figure 8):

- No driver is required.
- The operator performs punctual non-specialized support tasks.
- Minimization of the damage caused by human errors.
- High availability, not limited by the shifts timetable.
- Minimize the risk of damage due to its stopped cleaning.
- Its low weight minimizes the roads' impact and fuel consumption.
- Its dimensions improve its maneuverability.
- High quality of mechanical cleaning with minimum water consumption.
- High cleaning capacity and autonomy.
- Easy scalable solution and robustness to single failure.
- PARIS is designed for night cleaning, not affecting the daily plant production.

FERMUPE

In the cleaning portfolio, Fermupe offers a comprehensive package for cleaning of solar fields.

Fermupe has developed their own range of equipment for cleaning mirrors of solar fields, as well as photovoltaic panels [5].



Figure 9: FERMUPE Cleaning Vehicle

Overview of FERMUPE cleaning machine (Figure 9):

Fermupe has designed and developed two models of machines for cleaning solar mirrors and solar panels.

- Central cylinders, Parabolic solar thermal cleaning, covering the entire range (contact and non-contact), with cleaning schedules integrated on a single computer (there are interchangeable elements), which cover all the needs of the plant, and leading to corresponding cost savings.
- Vehicles for cleaning of heliostats, PV and solar thermal power plants.

ABENGOA

Abengoa Solar, through its specialized partner, provides its own design of cleaning vehicles for heliostats and parabolic trough collectors, use of which result in higher levels of plant efficiencies. Abengoa cleaning trucks are available for tower heliostats and parabolic trough cleaning [6].



Figure 10: ABENGOA Cleaning Vehicle

Features of ABENGOA cleaning machine (Figure 10):

- Interchangeable cleaning tools: high pressure and brushing.
- Cleaning speed control: 0 – 5 km/h.
- Chassis: high strength steel, 50% lighter than conventional vehicles.
- Tank :9000 litres PRFV tank, shipping container dimension, front cabinet with shutter lock
- Crane: hydraulic canalization by rigid tubes.
- Oleo hydraulic circuit: pumps next to the PTO (Power tank off), detachable pump clutch.
- Electricity and electronics: standardized distribution panel, replenishable control box with joystick, extra sensors (temperature, pressure, flow, power night LEDs, ultrasonic sensors)

3.2. Cooling

In CSP plants, the main consumption of water occurs in the cooling system which accounts for 80-90% of the total water consumption. A description of the methods employed and their effectiveness will be discussed as well as the environmental and economic impact of these technologies [7].

3.2.1. Technology

Four main technologies have been identified as current practice suitable for Rankine cycle based CSP plants: two for a water-cooled condenser (WCC) system and two for an air-cooled condenser (ACC) system.

The first WCC system is the once-through WCC system described in Figure 11 [7].

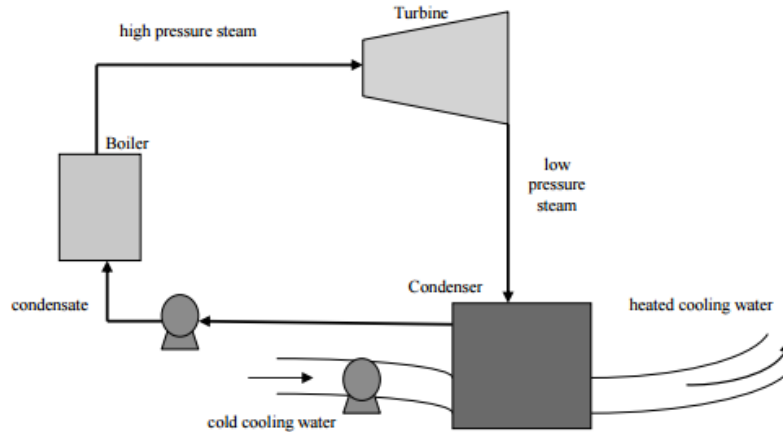

Figure 11: Schematic diagram of the once-through WCC system [7]

This condenser uses water to cool steam via indirect contact. Cold cooling water is directly extracted from the sea (or other reservoir) and all of heated cooling water is discharged into the source.

The second one, and the most common for plants near a river or lake, is the circulating evaporative WCC system described in the Figure 12 [7].

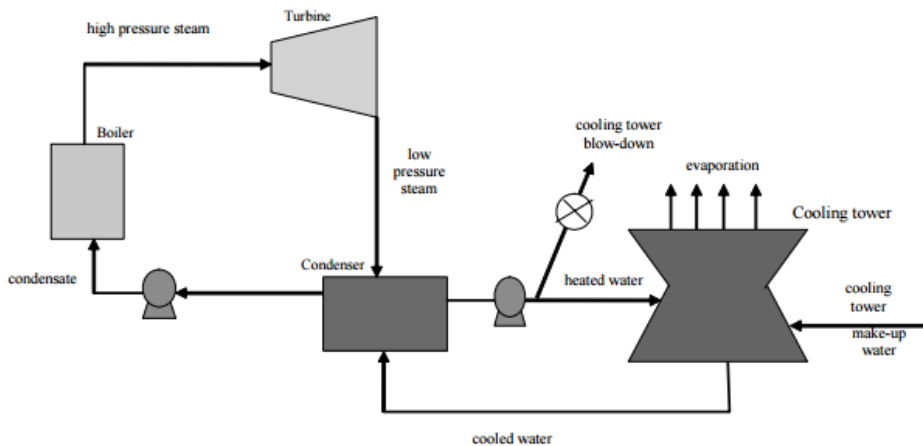

Figure 12: Schematic diagram of the circulating evaporative WCC system [7]

The system extracts the cooling water from a river or a lake, but instead of rejecting the heated water into the source, it is rejected in the air by evaporation in a cooling tower. The cooling tower needs a regular blowdown and consumes a considerable amount of water [7].

To meet the cooling needs of a CSP plant and the water scarcity of the area where these plants are usually located, two ACC systems have been developed [7].

The first one is the Direct ACC system described in the Figure 13.

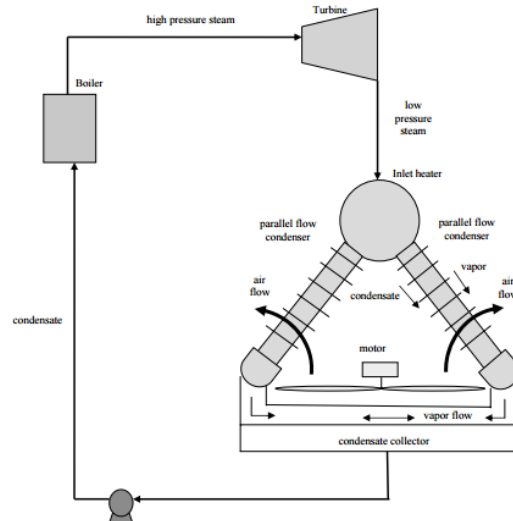

Figure 13: Schematic diagram of direct ACC system [7]

Steam from the steam turbine is carried to the A-framed condenser. The condenser is composed of finned tube bundles which are cooled by external ambient air. All the existing direct ACC systems use mechanical draft which is more reliable (less sensitive to backpressure fluctuation and high wind) and requires less operational intervention than a natural draft direct ACC. The steam circulates via the finned tube heat exchangers from the top to the bottom, where the fans are located, of the condenser. Then, the condensate steam is drained to be reinjected into the cycle.

It has been reported that direct ACC performs well at ambient temperatures up to 32°C. In fact, above 32°C CSP plants may experience efficiency losses due to the cooling system's underperformance. Moreover, significant efficiency losses (5% or more) become apparent above 37°C ambient temperature. Observed on a hot day, this underperformance reflects a reduction of the cycle efficiency due to high condensing temperatures which increases the turbine backpressure and the steam rejection temperature [7].

The second system is the indirect (or Heller) ACC system described in the Figure 14.

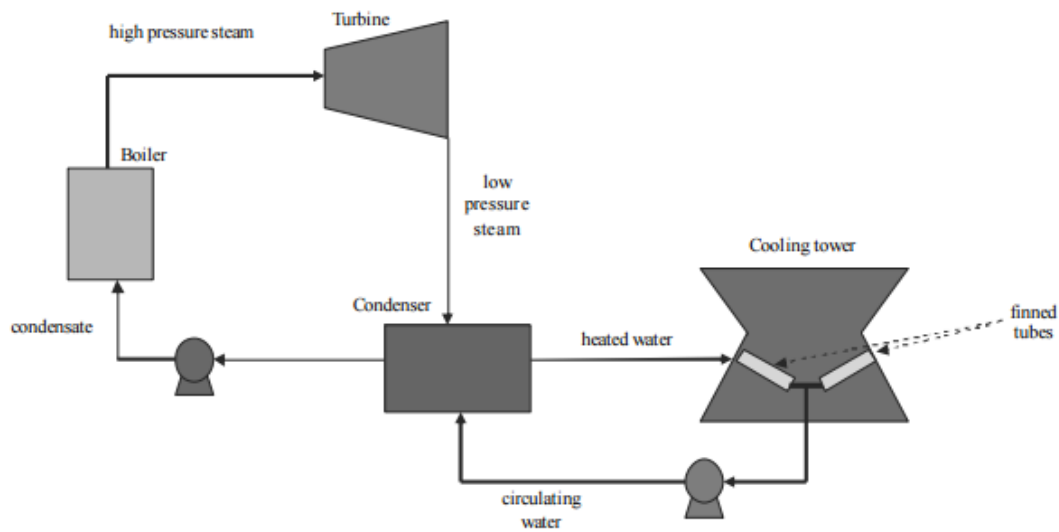

Figure 14: Schematic diagram of Heller ACC system [7]

In this system cooling water is sprayed directly into the exhaust flow of the steam turbine in a ratio of 50:1. The condensate water is either pumped to bundles of finned tubes arrayed in a cooling tower or pumped back to the boiler. Therefore, in the cooling tower the heated water is cooled by ambient air to be sprayed as cooling water in the condenser. For indirect ACC systems, either mechanical or natural draft can be used.

These two families can be combined into hybrid wet/dry cooling systems. Two categories of hybrid systems exist: those aimed at plume abatement and those aimed at reducing water consumption. The most interesting option for CSP plants is that aimed at reducing the water consumption compared to plants integrating WCC systems only. Moreover, during warm weather, the hybrid system allows one to enhance the performance compared to plants integrating only ACC systems. As described in Figure 15, hybrid systems are ACC/WCC parallel systems. The ACC system is the primary cooling system, but during warm weather the WCC reduces the load on the ACC and enhances the performance [7].

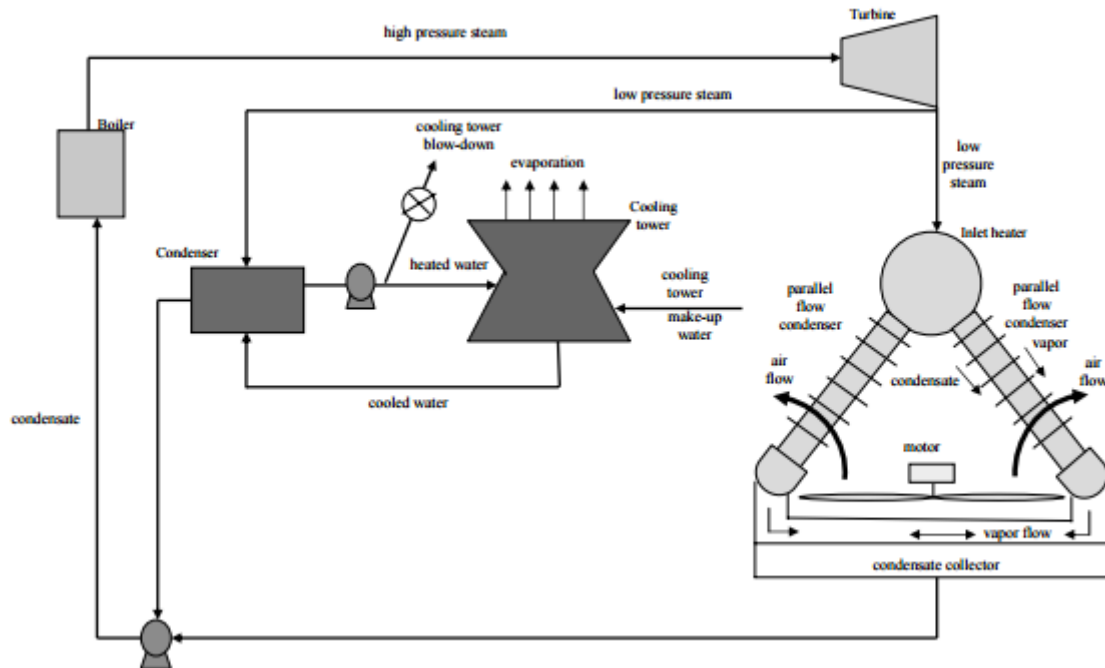

Figure 15: Schematic diagram of Hybrid system [7]

3.2.2. Environmental Aspects

The main environmental aspect that must be taking into consideration by a CSP designer, especially for those integrating a WCC system, is the water supply. As explained in the previous section, a WCC system uses a large amount of water, and the most sustainable solution is to implement the CSP beside a natural water source. If this option is possible, the second environmental impact will be the rejection of heated water into the original source which will increase its temperature in the CSP area (large river or sea). If a natural water source is not available, a reliable and sustainable water supply will have to be provided (pipelines, trucks or tanks).

CSP design should include the spatial occupation. In fact, by implementing large technologies such as cooling towers or water tanks the plants increase their occupancy area and visual impact [7].

3.2.3. Economic Aspects

As explained in the following table, water consumption of a circulating evaporative WCC system has been estimated for each CSP type from current plants depending on implemented technology. Those three main technologies use different heating systems, either heating steam directly or heating through a heat transfer fluid [7].

CSP plant	Parabolic trough	Solar tower	Fresnel technology
Water requirements (in l/MWh)	2,955 – 3,030	1,890 – 2,840	3,785
Steam temperature (in °F)	400	1,050	535
Heat transfer fluid	Oil at 425°F	Water	Water

Table 2: Typical water requirements of an operating CSP plant depending on its cooling system

By utilizing an ACC system rather than a WCC system the CSP plant water usage can be reduced by as much as 90%. The utilization of a hybrid WCC/ACC system can provide water consumption reductions from 50% to 90% depending on the type of the technology used (CSP type as well as cooling system) [7].

Technology	Efficiency reduction (%)		
	Direct dry cooling ACC system	Circulating evaporative WCC system	Hybrid ACC/WCC system
CSP parabolic trough plant	4.5-5	Base case	1-4
CSP solar tower plant	1-3	Base case	1-3
CSP Fresnel plant	n/a	Base case	n/a

Table 3: Comparison of efficiency reduction by cooling system for each type of CSP plant [7]

As explained in the previous section, implementation of ACC technologies, and especially direct ACC, can lead to plant efficiency reductions if the daily ambient temperature is not compatible with its requirement (ambient temperatures under 32°C). See Table 3. Evaporative WCC technology has the lowest capital cost amongst all cooling technologies for CSP plants. They are estimated to be about 2,800€/kW – 4,800€/kW (excluding storage) [7]. See Table 4.

Technology	Capital cost increase (%)		
	Direct dry cooling ACC system	Circulating evaporative WCC system	Hybrid ACC/WCC system
CSP parabolic trough plant	4-5	Base case*	2-3
CSP solar tower plant	4-5	Base case*	2-3
CSP Fresnel plant	n/a	Base case*	n/a

*Capital costs for WCC system include cooling equipment, boiler feed water pumps, and HTF pumps

Table 4: Comparison of Capital cost increase by cooling system for each type of CSP plant [7]

WCC alternative cooling technologies offer much lower operation and maintenance costs linked to water management (water treatment, water freezing issues and the discharge of waste water). However, from an economic feasibility point of view, the operating and maintenance costs are minimal compared to the capital costs.

CSP plants integrating circulating evaporative WCC systems produce electrical power for about 7.6€/kWh – 9.2€/kWh in south-western USA conditions [7]. See Table 5.

Technology	Electricity unit cost increase (%)		
	Direct dry cooling ACC system	Circulating evaporative WCC system	Hybrid ACC/WCC system
CSP parabolic trough plant	2-9	Base case	up to 8
CSP solar tower plant	2-5	Base case	up to 5
CSP Fresnel plant	n/a	Base case	n/a

Table 5: Comparison of electricity unit cost increase by cooling system type of CSP plant [7]

Any alternative cooling systems to circulating evaporative WCC systems leads to a net electricity unit cost increase for CSP plants.

4. Technology being developed under WASCOP

The technologies being developed to reduce water consumption in CSP plants as part of the WASCOP project are now described briefly, together with their potential impact on water consumption. The technologies associated with cleaning are outlined in section 4.1 and the technologies associated with cooling are described in section 4.2.

4.1. Cleaning

From a cleaning perspective, WASCOP is developing technologies to reduce soiling on the collector mirrors and receiver tubes and to produce more water-efficient cleaning processes when cleaning is necessary.

4.1.1. Technology

WASCOP defines three specific objectives to improve cleaning process for CSP plants:

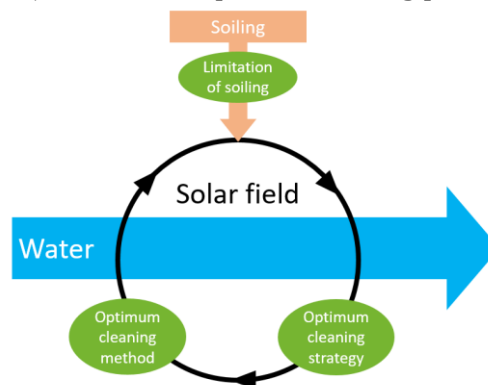

Figure 16: WASCOP Cleaning approach scheme

The first way to reduce water consumption for cleaning is to reduce the need to clean the optical surfaces, namely the glass reflectors and the receiver envelope glass. This includes implementing dust barriers around the CSP plant's perimeter to prevent a significant proportion of dust and sand particles from reaching the internal solar field.

Anti-soiling coatings are being developed for the glass receiver tube. These coatings will be characterized and tested and subjected to accelerated ageing in order to assess their durability.

Previous studies by the WASCOP partners on anti-soiling coatings for glass reflecting mirrors have indicated a 2% specular reflectance gain to 30-50% loss soiling compared to non-coated reflectors. Thus, the WASCOP project is focusing on the final selection of existing innovative coatings. Similar to receiver glass, the durability of the coating for reflectors will be validated applying accelerated ageing tests on coated samples.

To improve cleaning management, WASCOP is developing three different soiling sensors [8]:

- The first soiling sensor will deal with the determination of the nature of the optical performance losses. This will be specific for evaluating the level, the type, and the gravity of

soiling. Using a combination of the Abengoa Condor and D&S 15R-USB technologies, this equipment will distinguish between the loss in reflectance due to soiling, abrasion or chemical degradation [8].

- The second soiling sensor is designed to be low-cost to measure mirror soiling, measuring in real-time on the surface of the mirrors, or in close proximity [8].
- The third soiling sensor will provide a continuous measurement of the transmittance for the outer glass of the receiver tube [8].

The third and last way to reduce water consumption for cleaning is to optimize the cleaning operations. As an alternative to conventional wet cleaning, WASCOP will develop two different cleaning devices.

- A laboratory scale prototype of an ultrasonic cleaner will be developed. It will be a resonant sweeping wiper using agitation and cavitation, inside a very thin water layer on the optical surface to remove dust particles [8].
- Designed for central receiver plants, a gravity lip system at the rim of a heliostat will act as a wiper, using condensed water or rain to clean the optical surface [8].

4.1.2. Environmental Aspects

CSP plants are generally located in desert areas where high amounts of airborne particles are found as a result of the ground and local climate conditions. Each technology implemented for soiling mitigation should conserve soil cohesion within the plant area as well as in the proximity of the solar field. These can be complex issues. For example, dust barriers that enclose the solar field may prevent mirror soiling but their implementation generates new dust generation centres on the perimeter of the solar field unless regular removal occurs.

Moreover, ultrasonic cleaners could have an impact on flora and fauna (for example through insects), thus, WASCOP will provide management of this automatic cleaning system to reduce the impact of noise and vibration on the environment. In fact, one of the aims of WASCOP is to achieve a minimal impact on environmental flora and fauna by lower water consumption.

By reducing the cleaning frequency WASCOP will provide a small step towards reducing mirror abrasion from contact cleaning. By providing environmentally friendly solutions, not using additional cleaning fluids or surfactants, WASCOP will help CSP designers to control the environmental impact and wastewater [8].

4.1.3. Economic Aspects

All technologies previously presented will generate an extra cost in CAPEX. However, by providing a reduction of water consumption related to each technology (Table 6) and an improvement in reflectance through enhanced cleaning technologies, WASCOP will ensure absorption of the initial capital investment through the potential reduction of OPEX. In fact, the aim of the project is to provide solutions reducing the wet cleaning frequency and thus the operating intervention and water consumption.

Technology	Water Savings for cleaning	Stat-of-the-art KPI	WASCOP KPI
Anti-soiling coatings + dust barriers	50%	180m ³ /day	90m ³ /day
Soiling detectors	25%	180m ³ /day	135m ³ /day
Ultrasonic cleaner	98%	180m ³ /day	3.6m ³ /day
Gravity lip system	99%	180m ³ /day	1.8m ³ /day

KPI (Key Performance Indicator) for 50MWe CSP parabolic trough plant using the wet cooling system

Table 6: Water savings of WASCOP solution for cleaning [8]

4.2. Cooling

WASCOP aims to develop innovative solutions limiting water lost by evaporation. Therefore, by combining the cooling current practices described before and improving this combination with new technologies, WASCOP will provide economically and environmentally sustainable solutions saving water whilst maintaining the effectiveness of the CSP plant.

4.2.1. Technology

One of the major challenges confronting CSP plant operation is the consumption of large amounts of water, with studies showing that about 2000 to 3000 cubic meters per GWh water is used in overall CSP plant operation in areas where water is scarce and therefore costly. The cooling part of the power block producing electricity consumes about 80 – 90% of the total water consumed in the case of wet cooling and it may go even higher when the ambient temperature increases.

Water savings for CSP plant cooling being developed under WASCOP require flexible and adaptive technologies for reducing the amount of water consumed in cooling, and are based on three strategies [8].

- **Limitation of inconveniences**

By limiting/reducing the amount of heat removed from the power block through convectional water cooling, it is possible to reduce the amount of water to be consumed in CSP cooling block [8].

- **Optimization of the remedial strategies**

By developing and increasing flexibility for water management for cooling in the power block in relation with external environmental conditions through reviewing current CSP operating strategy it is possible to save the amount of water used in CSP cooling blocks [8].

- **Optimization of the remedial means**

By increasing the efficiency and sustainability of the cooling system and associated devices for better performance in relation to the reduction of water usage in the cooling block, reduced water consumption can be achieved [8]. See Figure 17.

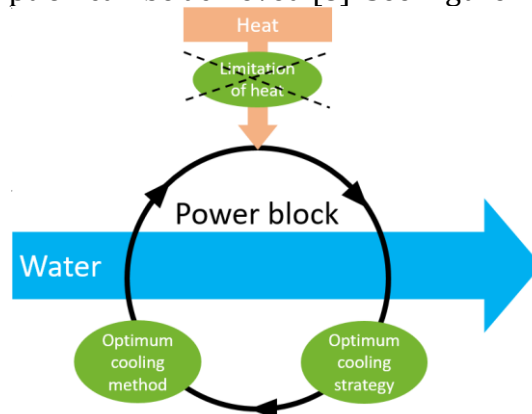

Figure 17: WASCOP scheme for CSP cooling power block

Three novel approaches being developed under WASCOP will reduce the amount of water consumption in the cooling block while maintaining the overall plant efficiency.

- **Development of heat storage reservoir**
A heat storage reservoir will be added after the turbine condenser heat exchanger, on the power block cooling loop, to optimize the cooling process. This approach will reduce dry cooling loss of efficiency down to 5% while increasing the amount of water savings in cooling the power block [8].
- **Development of hybridized cooler**
A cost effective dry or wet hybridized cooling system to use at peak ambient temperatures, will increase the overall plant efficiency by 5% and will also reduce the water consumed [8].
- **Development of versatile adiabatic cooler**
A redesign of the heat exchanger and air handling systems with adjustable amounts of added water. Water savings in this approach, compared to conventional wet cooling is estimated at 90% [8].

HEAT STORAGE SYSTEM:

WASCOP will optimize the dry cooling strategy for heat rejection in the power block by taking advantage of low ambient temperatures during night time to develop a cost effective heat storage system which will be used to release all or part of the waste heat from the steam turbine to atmosphere when the ambient temperatures are lowest [8]. See Figure 18.

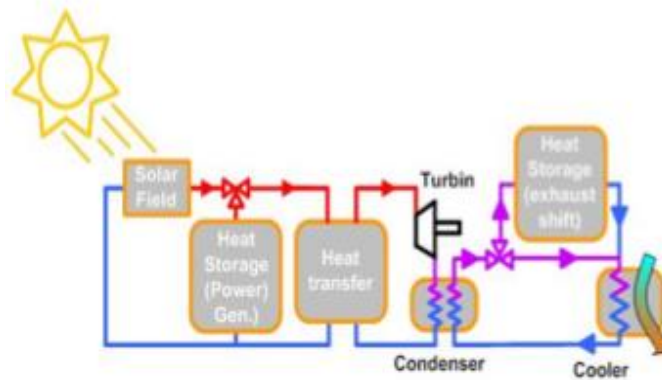

Figure 18: Scheme of heat storage on the cooling loop [WASCOP REPORT]

HYBRIDIZED COOLER:

WASCOP is developing a hybridized cooling system, taking advantage of seasonal temperature variations by employing dry cooling during lower ambient temperatures and wet cooling during the hottest periods of the year.

Steam flow exhaust from the turbine is channeled to the dry cooling system where the cooling process is achieved using high power fans during the coolest periods whilst during higher temperature periods of the year, exhaust steam from the turbine is cooled by the wet cooling system. See Figure 19 [8].

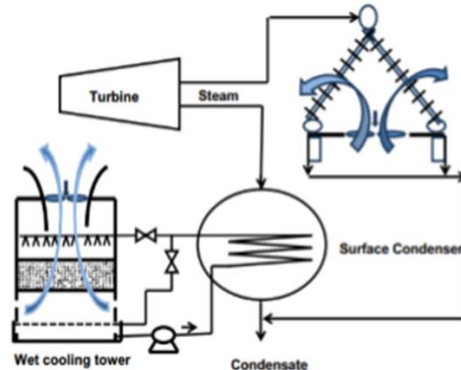

Figure 19: Hybridized cooling system [WASCOP Report]

VERSITILE ADIABATIC COOLER:

The WASCOP project is developing a novel versatile adiabatic cooler based on the principle of an indirect dry cooler supplemented with an adjustable water supply to cope with the external environment in order to balance heat exchange performance, and maintain global plant efficiency.

Adiabatic cooling systems are well known. The Versatile Adiabatic Cooler being developed during WASCOP is based on the principal of an indirect dry cooler supplemented by an external water supply to cope with external climate conditions.

The versatile adiabatic cooler will be composed of finned tube heat exchangers topped with fans, and sprayers for water supplement options. The design of the versatile cooler will be optimized to control the amount of water in response to the external conditions. See Figure 20 [8].

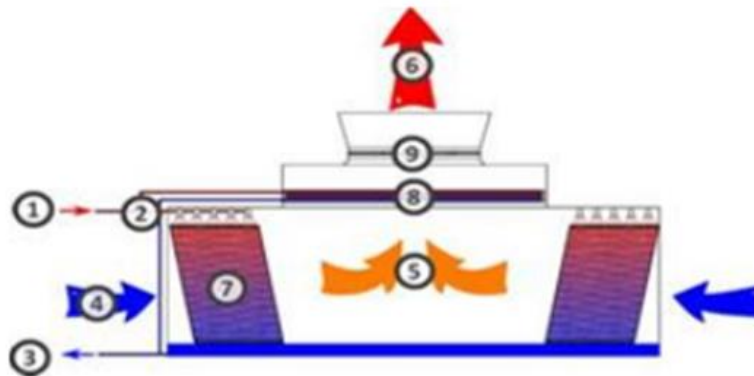

Figure 20: Versatile Adiabatic Cooler

Key to Figure 20:

- 1.Hot process water (inlet)
- 2.Regulation valve (0% to 100% dry)
- 3.Cold process water (outlet)
- 4.Ambient cool air (inlet)
- 5.Plenum
- 6.Warm air (outlet)
- 7.Evaporative cooling area (water sprayers/fill surface/Water basin)
- 8.Dry cooling area (tube heat exchanger)
- 9.Fan

4.2.2. Environmental Aspects

The impact of the versatile cooler system on the environment may include the following [8]:

- Change in ecosystem conditions due to increase in temperature (heat rejected by cooling system).
- Noise in the CSP plant environment from the cooling system and fan.
- Reduced water discharges.

4.2.3. Economic Aspects

The cooling technology being developed under WASCOP will reduce water consumption up to 90% compared to conventional wet cooling technologies, which will save money on the assumption that the efficiency of the plant can be maintained.

Table 7 below is based on the preliminary experiments performed by WASCOP project partners for validating the primary concept [8].

Innovative Cooling Technology	Water savings	Water usage on current technology for 50MWe CSP parabolic trough plant using wet cooling	Water usage on WASCOP technology for 50MWe CSP parabolic trough plant using wet cooling
Hybridized cooler	50 – 80% of water for cooling	4000 cubic metre per day	800 - 2000 cubic metre per day
Versatile cooler	90% of water for cooling	4000 cubic metre per day	400 cubic metre per day

Table 7: Innovative coolers

Savings in water achieved by WASCOP technology will also lead to the reduction of OPEX cost which is strongly connected to the water consumptions of CSP plant, therefore providing a reduction in the number of CSP maintenance programs and increasing plant efficiency [8].

4.2.4. Advantages/Disadvantages of Innovative Cooling Systems

Advantage of Heat storage system:

- Heat storage system will reduce the expected decrease in plant efficiency during dry cooling by 2 -5%.
- The system may be adapted to any kind of the turbine which may be cooled using ambient air.
- The system will reduce the cooler size for new plant and can be implemented in existing CSP plants.
- The system will significantly reduce the amount of water used in power block cooling since it makes dry cooling a more attractive option [8].

Disadvantage of Heat storage system:

- The heat storage system can be subjected to a thermal ratcheting phenomenon due to thermal stress accumulation during thermal cycles, which results in thermal stresses that may exceed the wall tank yield stress leading to plastic deformation [9].

Advantage of Hybridized cooling system:

- Hybrid cooling involves the use of different water volumes depending on the season. The system will save up to 80% of annual water consumption of the evaporative cooling tower.
- The efficiency can be improved in wet, cold and hot environments by 3% in comparison to the current dry systems [10].

Disadvantage of Hybridized cooling system:

- The hybridized system requires additional components and systems which increase the cost of investment and maintenance.
- The overall system cost will increase by 3-5% compared to wet evaporative systems such as cooling tower systems [10].

Advantage of versatile adiabatic cooler:

- The versatile adiabatic cooler will improve heat transfer performance, and eliminate the traditional trade-off between high heat transfer performance and low fouling sensitivity of the current adiabatic cooling systems.
- Parasitic loads will be minimized through improving air handling and distribution on the versatile adiabatic cooler, therefore increasing the efficiency of the cooling system.
- The innovative versatile cooler using the adjustable water technology will reduce water consumption in cooling of a CSP plant by up to 90% in comparison with wet cooling systems [8].

Disadvantage of versatile adiabatic cooler:

- The versatile cooling system will have high initial investment costs due to improved system design such as improved air handling and distribution of the cooler, fan drive unit, and improved heat transfer coefficient on the heat exchanger.
- Power consumption of the system is high compared to wet cooling, as a result of an indirect mechanical draft cooling system [8].

5. Future/Other Technologies

5.1. Cleaning

5.1.1. Technology

Cleaning water recovery

So far, CSP plants use few or no cleaning water recovery devices and the water is directly disposed of on the ground. During cleaning operations, the soiled water could be collected and reused, providing that a system was developed to separate the contaminants from the clean water.

A membrane filtration system could be used to purify the water onsite. The filter may not require any power supply, with the liquid is driven by gravity [11]. Then, the filtration operation could be done directly after water collection. Depending on the soiling composition and therefore the quality of the water collected, other type of water treatments could be required. Despite a few concerns about a water recovery system, a CSP supplier provides a solution based on a pneumatic enclosure, to facilitate the water collection [10].

In addition to recover the water from cleaning operation, this system can be used to collect water from rainfall or intense dew in the morning. Depending on the purity, the collected water could be used for others purposes, such as cooling [8].

Electrodynamic screen, self-cleaning CSP collectors

Electrodynamic Screening is a technology developed within Boston University [12], which uses the electric charge of the dust particle to repel the dust. With a dust removal efficiency greater than 90%

and a low electrical power consumption of the system, this solution has a strong potential and could be very efficient.

This cleaning method can be used as often as it is required to maintain an optimal mirror reflectance, and could be water free. It can be used in the event of a dust storm, to recover a sufficient reflectance, and allow the power plant to produce energy with minimal delay [8].

However, this technology will have shading effects and could prove costly to scale up from its current laboratory scale.

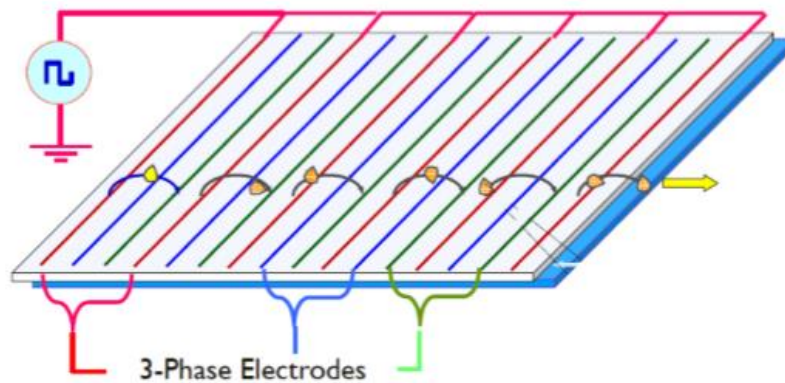

Figure 21: EDS Principle

Cleaning with brushes and without water

Cleaning systems in CSP plants still use water for its reflectance recovery efficiency (up to 99% of original value). Inspired by PV solar farms technology, a water free method can achieve the same performance [13] [14]. A micro-fibre brush could remove dust from the surface of the panel and generate an air stream to blow off the dirt [15]. The brush would need to be tested on mirror surfaces to study the adjustment to CSP plants. This technology may prove abrasive and be less efficient on reflecting mirrors than on PV panel covers.

In addition, the full cleaning machine exists only for a flat surface, such as that found in many heliostat fields, but is autonomous and operates on the panel frame itself.



Figure 22: Eccopia cleaning machine for PV panels

Guide rail and autonomous devices

Cleaning machines for CSP plants mainly use a truck which transports the systems needed to clean the mirrors. The truck is able to carry the demineralized water needed for the cleaning operation,

although it may need to replenish the water tanks during a cleaning shift. Clearly a driver is required to operate the vehicle and the electrical on-board systems that monitor the operation in order to have an efficient and safe cleaning for the mirrors. Despite taking considerable care, mirrors are occasionally broken during cleaning.

Some manufacturers provide an autonomous driven machine [4] , but nothing exists to clean the mirror directly from the mirror frame, as can be seen for some PV panel power plants. Such guide railed machines are very accurate, can cover the whole mirror surface and then use the exact amount of water needed.

In addition, each row of mirrors could have its own cleaning device. Associated to real-time reflectance measurements, the cleaning operation could be performed automatically, only where it is needed. Moreover, after a dust storm event for example, the whole plant will be able to quickly clean itself. Then, it will lower the period that mirrors are inactive.

The challenge is to supply the water to the moving system but also to design a safe, efficient and profitable frame for the cleaning machine. Figure 23 shows what such a device could look like[16].



Figure 23: Cleaning railed robot for parabolic mirrors [16]

5.1.2. Economic Aspects

It always takes time and money to introduce a new technology within already existing and successfully operating systems. Even if a water saving device has a strong potential, the comparatively low cost of water can still favour the use of water methods as a profitable way to clean the mirrors. In those cases, promising technologies might need to be supported by local or national government incentives or environmental regulations.

Most CSP plant operators prefer to use human labour to clean the mirrors. Truck drivers, the vehicle and the fuel needed can be seen as inexpensive. This method seems to be more profitable than autonomous devices, with their higher initial capital cost, and their unproven reliability record over an extended time period.

5.1.3. Advantages/Disadvantages of Novel Cleaning Systems

Possible novel cleaning technology	Advantages	Disadvantages
Water recovery	Save significant volumes of water without interfering with the cleaning efficiency or strategy	-Disposal of the filtrated particles -Adaptation of the system on the mirror structure - Investment cost
EDS	-Dust removal efficiency > 90% -Autonomous -Very fast (e.g. after a dust storm): 2 minutes -Without requiring any water or manual labour -Strong potential	-Shading effect -Technology needs scaling up - Investment cost
Brushes without water	-Does not use any water -Dust removal efficiency, up to 99% -Commercialised technology in PV solar farms	-Must be adapted from PV panel usage -Need to study the behaviour on mirror surface (durability question to be answered)
Guide railed devices	-Accurate -Available on each mirror row -No manual labour required	-Supply the demineralised water to the onsite system -Unproven in practice - Investment cost

5.2. Cooling

5.2.1. Technology

The process of blowdown occurs in the cooling towers by draining water with a high concentration of minerals to drain and replacing the lost volume of water with fresh water. This method prevents a substantial amount of minerals to build up in the water which would have a corrosive effect on the cooling tower materials and also create obstructions (blockages) in different components of the circuit.

The water used in this way indicates a significant opportunity for the case of water management. As this highly concentrated water is disposed of to drain the water is effectively wasted and in an area of water scarcity this is a very costly loss. However, by managing the concentration of minerals in this water more effectively (for example by adding a water treatment system) there is potential for huge savings. The saving can be made from reducing the annual usage of makeup water. Make up water is the fresh water added to the system and is the sum of the losses due to evaporation, drift and blowdown.

The addition of scale inhibitors in the cooling tower water could also increase the saturation point of the water allowing a higher concentration of minerals in the water before scaling effects would occur.

Many cooling tower systems operate between two and four cycles of concentration (COC). However, by increasing this from (say) three to six, the reduction in make-up water can be up to 20% and the cooling tower blowdown by 50%. [17]

A feasibility study of a hybrid cooling system in a thermal power plant has been conducted by Williams et al [18]. The aim of this was to investigate the reduction of water usage with a minimal impact of the plant performance. The study compares a hybrid system which is configured both in series and in parallel over a range of operating conditions. The results do show positive results as there is a significant reduction in water usage however due to the start-up cost of the system it has been found not to be economically viable as yet. If water and electricity costs were to significantly increase then this option would become more viable.

5.2.2. Environmental Aspects

The addition of chemicals to inhibit corrosion into the system may allow a reduction in water usage, however these chemicals can have an adverse effect on the environment. Therefore, post blowdown treatment must be done to remove or reduce these chemicals to allowable environmental limits.

5.2.3. Economic Aspects

The pre- and post- treatment system cost would incur additional initial expenditure. The overall financial gain however must be assessed by comparing the systems costs against the potential water savings.

5.2.4. Advantages/Disadvantages of Novel Cooling Systems

Possible technology	Advantage	Disadvantage
Water Treatment	Reduction in yearly blowdown frequency resulting in a reduction of water usage.	CAPEX & OPEX costs.

6. Conclusion

To conclude, it has been found that a wet cooling system can maintain the plant efficiency, however it will consume up to 90% more water than a hybrid or dry system. The dry cooling system does not consume water as its primary cooling method is carried out with the use of electrically powered mechanical fans. This system will run off the electricity produced by the plant which in effect will reduce plant efficiency by up to 10%. The hybrid cooling system on the other hand will save up to 90% more water than the wet cooling option with only an efficiency loss of up to 3%. However, as stated in the previous section, the capital cost required can make this solution economically unattractive.

For the cleaning aspect of water management, the optimal solution has been found to be the alternate use of wet and dry methods. Initially, dry cleaning methods can be performed until a threshold level of reflectance has been met. Once the reflectance falls below this threshold a wet cleaning solution can be implemented to restore full reflectance to the mirrors. However, the combination of water and a rotating brush head has been found to be the most common method of cleaning within existing plants.

7. Reference List

- [1] ECILIMP, “ECILIMP manufacturer website.” [Online]. Available: http://termosolar.ecilimp.com/index_eng.html. [Accessed: 21-Apr-2017].
- [2] Albatros Group, “Albatros group website.” [Online]. Available: <http://www.evwind.es/2011/11/27/albatros-broadens-its-services-for-om-of-concentrating-solar-thermal-power-plants/14879>. [Accessed: 21-Apr-2017].
- [3] Voith Turbo GmbH, “Voith Turbo Develops Special Vehicles for Application in Thermal Solar Power Plants,” 2009. [Online]. Available: <http://suppliersandequipment.mining.com/files/2009/03/elcos-showersdowsolarmirrors.pdf>.
- [4] P. Troughs and C. Parabolic, “PARIS-Autonomus cleaning system for Parabolic Troughs PARIS-Autonomus cleaning system for Parabolic Troughs,” 2012.
- [5] “Fermupe Cleaning Machine.” [Online]. Available: <http://www.fermupe.com/>. [Accessed: 17-Apr-2017].
- [6] “Abengoa Cleaning Machine.” [Online]. Available: http://www.abengoasolar.es/web/en/Productos_y_Servicios/Equipos_OM/Vehiculos_limpieza/. [Accessed: 17-Apr-2017].
- [7] I. H. and G. K. Andreas Poullikkas, “A comparative overview of wet and dry cooling systems for Rankine cycle based CSP plants,” 2013.
- [8] [654479] [WASCOP], “WASCOP proposal extract,” *Assoc. with Doc. Ref. Ares(2015)5179646 - 18/11/2015*, 2015.
- [9] N. Sassine, F.-V. Donzé, A. Bruch, and B. Harthong, “Rock-Bed Thermocline Storage: A Numerical Analysis of Granular Bed Behavior and Interaction with Storage Tank,” no. October, 2016.
- [10] A. Colmenar-Santos, D. Borge-Diez, C. P. Molina, and M. Castro-Gil, “Water consumption in solar parabolic trough plants: Review and analysis of the southern Spain case,” *Renew. Sustain. Energy Rev.*, vol. 34, pp. 565–577, 2014.
- [11] A. Raza, A. R. Higgo, A. Alobaidli, and T. Zhang, “Water recovery in a concentrated solar power plant,” *AIP Conf. Proc.*, vol. 1734, 2016.
- [12] J. Stark *et al.*, “Prototype Development for Self-Cleaning CSP Collectors,” 2013.
- [13] NOMADD Desert Solar Solutions, “Water free cleaning machine for PV panels.” [Online]. Available: <http://www.nomaddesertsolar.com/>. [Accessed: 21-Apr-2017].
- [14] Ecopia, “Water free brushes cleaning machine for PV panels.” [Online]. Available: <http://www.ecoppia.com/technology/#WATERFREE>. [Accessed: 21-Apr-2017].
- [15] “United States Patent Application Publication MELLER *et al.*,” 2013.
- [16] Tommaso Fenati, Julien Bertrand, Lina Fatheddine, Godfrey Ibe Uro, Atonye Nyingifa, “Autonomous cleaning machine for parabolic mirrors,” 2017, p. Private discussion.
- [17] Energy.gov, “Best-management-practice-10-cooling-tower-management.” [Online]. Available: <https://energy.gov/eere/femp/best-management-practice-10-cooling-tower-management>. [Accessed: 13-Mar-2017].

- [18] C. R. Williams and M. G. Rasul, "Feasibility of a Hybrid Cooling System in a Thermal Power Plant," pp. 124–129, 2008.