



**HAL**  
open science

## Experimental and numerical investigation of factors influencing thermal distribution and load-bearing capacity of bonded anchors under fire

Omar Al-Mansouri, Romain Mege, Nicolas Pinoteau, Sébastien Rémond,  
Mohamed Amine Lahouar, Thierry Guillet

### ► To cite this version:

Omar Al-Mansouri, Romain Mege, Nicolas Pinoteau, Sébastien Rémond, Mohamed Amine Lahouar, et al.. Experimental and numerical investigation of factors influencing thermal distribution and load-bearing capacity of bonded anchors under fire. The 3rd International Conference on Structural Safety Under Fire & Blast, Sep 2019, London, United Kingdom. hal-02479116

**HAL Id: hal-02479116**

**<https://hal.science/hal-02479116>**

Submitted on 14 Feb 2020

**HAL** is a multi-disciplinary open access archive for the deposit and dissemination of scientific research documents, whether they are published or not. The documents may come from teaching and research institutions in France or abroad, or from public or private research centers.

L'archive ouverte pluridisciplinaire **HAL**, est destinée au dépôt et à la diffusion de documents scientifiques de niveau recherche, publiés ou non, émanant des établissements d'enseignement et de recherche français ou étrangers, des laboratoires publics ou privés.

# **EXPERIMENTAL AND NUMERICAL INVESTIGATION OF FACTORS INFLUENCING THERMAL DISTRIBUTION AND LOAD-BEARING CAPACITY OF BONDED ANCHORS UNDER FIRE**

**O. Al-Mansouri**, *CSTB & IMT Lille Douai, France*

**R. Mège, N. Pinoteau, M. A. Lahouar & T. Guillet**, *CSTB, France*

**S. Rémond**, *IMT Lille Douai, France*

## **ABSTRACT**

Due to the absence of guidelines for evaluating bonded anchors exposed to fire, only the existing method for mechanical anchors (without resin) is applicable. This method only covers steel failure mode for bonded anchors. Pull-out failure mode occurs more often than other failure modes for bonded anchors at high temperatures. This paper presents a numerical study of different parameters linked to the existing evaluation method by means of 3D heat transfer analysis. First, the model is validated for experimental data in the literature. Then, other parameters are investigated to assess their influence on the precision of pull-out fire tests. Studied parameters are: embedded part of the anchor, extended length of the anchor and concrete element insulation. Results show that the embedded depth has a significant influence on temperature profiles along the bond. Moreover, the external length of the anchor influences temperature profiles, but not beyond lengths beyond 20 mm from the concrete surface.

## **INTRODUCTION**

Bonded techniques are increasingly used in the field of constructions thanks to their fast employment and different applications such as crack filling and bonding different structural elements to each other [1]. Bonded anchors ensure the connection between two structural elements thanks to a bonding material: steel of the anchor and concrete bearing element [2]. Bonding material can consist of mortar, cement grout, adhesive chemical resin...etc. Chemical resins used for bonding anchors in concrete can consist of polymer, vinylester and epoxy resins [3]. Studies showed that the mechanical behaviour of bonded anchors can be influenced by many factors such as: anchor geometry, material properties, installation procedure and environmental factors such as moisture and temperature [4-5]. The material properties of adhesive resins are particularly temperature dependent [6]. In accidental situations such as in case of fire, the structural member is exposed to sudden increase of temperature in a very short period of time. This induces thermal gradients in the structural member and leads to a new stress distribution along the bond. Temperature increase influences material properties of steel, concrete and resin and leads to their degradation [7-8]. This reduces the load-bearing capacity of the structure presenting risk on lives and goods inside the building. Therefore, it

should be taken into account when designing structures containing bonded anchors [9].

In general, the effect of temperature on polymeric materials can be quantified by the glass transition temperature ( $T_g$ ) of the polymer [10]. Adhesive materials show a rubbery behaviour when their temperature exceeds the glass transition temperature [11]. When the glass transition is exceeded, a change in physical state and viscosity occurs leading to a new stress distribution along the bond [12-13].

The evaluation of anchors under fire is defined in the technical report n° 20 of the European Organisation of Technical Assessment (EOTA) [14]. The guidelines provided in this document cover the evaluation of mechanical anchors for all failure modes and only steel failure mode for bonded anchors. Other failure modes are: concrete cone failure, steel failure, pull-out failure and combined cone pull-out failure [15]. Research studies showed that pull-out failure mode may occur more frequently under fire due to the rapid degradation of the resin's material properties. Many researchers have established that there is a need for an evaluation and design methods that complete the existing guidelines in EOTA TR 020 [14]. Al-Mansouri et al. [16] presented three possible configurations for a bonded anchor inside a building: anchors directly exposed to fire, anchors with metallic fixtures attached to them for load transfer and anchors with insulated fixtures

(covered with 50 mm of glass wool). The configuration with anchors directly exposed to fire presented the highest temperature profiles, whereas the existence of a metallic fixture only influences thermal distribution near the exposed part of the anchor (where the resin has very little resistance left) up to 90 min of fire exposure. However, the configuration with insulated fixtures gave significantly lower temperature profiles. Load-prediction using on the resistance integration based on temperature profiles measured during the tests method gave advantageous results for anchors with insulated fixtures.

Lakhani and Hofmann [17-18] proposed a 2D heat transfer model to determine the load-bearing capacity of bonded anchors at high temperatures based on Cartesian coordinates. This work used common assumptions of modelling the steel part of the anchor inside the concrete bearing element and not taking into account the extended part. It also assumed that the cylindrical anchor may be represented in 2D using Cartesian coordinates. This represents the anchor as a long plate in the 3<sup>rd</sup> dimension and might give unrepresentative results. This paper presents a numerical study based on 3D finite element heat transfer simulations for chemically bonded anchors under ISO 834 fire [19]. A heat transfer analysis is carried out to obtain the temporal and spatial distribution of temperature. The second step consists of coupling the output data of temperature profiles with the existing bond strength vs. temperature relationship of the adhesive resin. The load-bearing capacity of the anchor is then computed by numerically integrating the temperature dependent bond strength over the embedment depth of the anchor. The presented model is carried out using ANSYS program by 3D finite element analysis. The results of this model are compared to test results from pull-out fire tests on bonded anchors with different possible configurations (direct exposure to fire, existing of a metallic fixture with insulation).

After the validation of the model a parametric study is conducted to investigate the influence of other parameters on the precision of evaluation tests of bonded anchors under fire:

- Extended part of the anchor.
- Embedded part of the anchor.
- Concrete element insulation.

### 1. 3D MODEL USING ANSYS

This section describes the proposed model used for the determination of the load-bearing capacity under ISO 834 fire [17] for chemically bonded anchors in uncracked concrete. The thermal results of this model are coupled with a design method (the resistance integration method), for the determination of bond strength based on temperature profiles. The resistance integration method is based on the characterization of the chemical resin at high temperatures according to EAD 330087-00-0601 [20].

The numerical model presented in this paper is based on the following assumptions:

- The anchors are installed in uncracked concrete.
- Concrete spalling is ignored.
- The fire exposed surface of all elements is subjected to convective and radiative fluxes of ISO 834 fire temperatures [19] on all sides.
- The unexposed fire surface of concrete beams is subjected to convective and radiative fluxes of ambient air at 20°C.
- Slip of anchors is ignored and assumed to have a negligible effect on temperature distribution.

During a fire, heat transfer occurs between fire and exposed elements at the boundaries via convection and radiation. The heat propagates inside the members via conduction. ANSYS solves the governing differential equation for 3D transient heat conduction using implicit scheme and iterative solver (Eq. (1)).

$$\rho c \frac{\partial T}{\partial t} = k \left( \frac{\partial^2 T}{\partial x^2} + \frac{\partial^2 T}{\partial y^2} + \frac{\partial^2 T}{\partial z^2} \right) \dots Eq. (1)$$

The 3D model represents the anchor as a cylinder inside a concrete beam with modelling of the extended and embedded length of the steel anchor element (Fig. 1). Threads are ignored in the model.

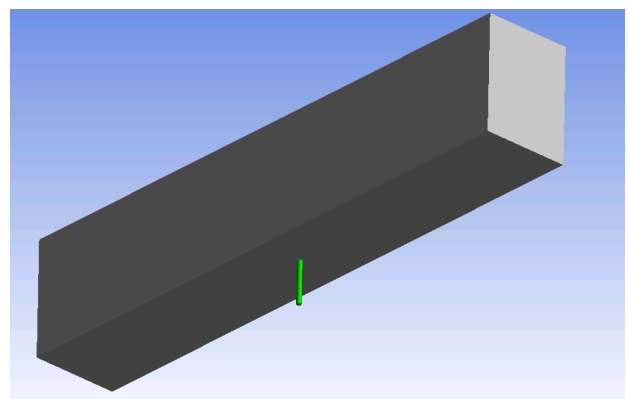

Fig. 1: Anchors directly exposed to fire using 3D modelling in ANSYS

Eq. (2) describes the Neumann boundary condition that needs to be satisfied at the fire-exposed surface:

$$-k \frac{\partial T}{\partial n} = h_{fire}(T_s - T_{fire}) + \varepsilon\sigma(T_s^4 - T_{fire}^4) \dots Eq. (2)$$

Eq. (3) describes the Neumann boundary condition that needs to be satisfied at insulated surfaces:

$$-k \frac{\partial T}{\partial n} = 0 \dots Eq. (3)$$

Eq. (4) describes the Neumann boundary condition that needs to be satisfied at the upper surface of the beam exposed to ambient air at 20°C:

$$\dot{q}_{total} = h_{air}(T_s - T_{air}) + \varepsilon\sigma(T_s^4 - T_{air}^4) \dots Eq. (4)$$

Where:

- $\dot{q}_{total}$  is the total heat flux applied to the surface,
- $k$  is the thermal conductivity (W/m.K),
- $\rho$  is the mass density (kg/m<sup>3</sup>),
- $c$  is the specific heat (J/kg.K),
- $h_{fire}$  is the convective heat transfer coefficient for the fire exposed surface (25 W/m<sup>2</sup>.K),
- $h_{air}$  is the convective heat transfer coefficient for the surface exposed to air at 20°C (4 W/m<sup>2</sup>.K),
- $\sigma$  is surface emissivity (0.7),
- $\varepsilon$  is the Boltzmann constant (5.667×10<sup>-8</sup> W/m<sup>2</sup>.K<sup>4</sup>),
- $T_s$  is the solid surface temperature (K),
- $T_{fire}$  is gas temperature inside the furnace as a function of time (K),
- $T_{air}$  is ambient air temperature (293 K),
- $t$  is time.

Boundary conditions are represented in a profile view of the 3D model in Fig. 2.

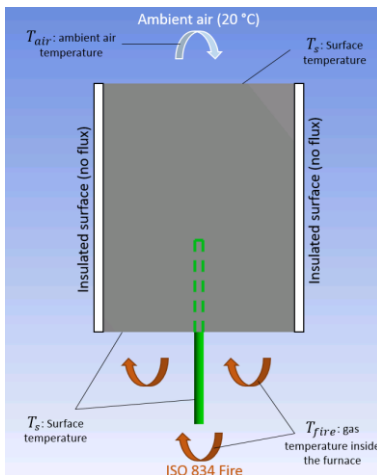

Fig. 2: Boundary conditions applied in the 3D heat transfer analysis for anchors directly exposed to fire.

Thermal properties of concrete and carbon steel (conductivity, specific heat and mass density) are a function of temperature. The properties according to the French National Annexe in Eurocode 2 [21] for both materials is adopted in this study. Mass density of steel is considered constant (7850 kg/m<sup>3</sup>) [22].

## 2. VALIDATION OF THE MODEL

### 2.1 ANCHORS DIRECTLY EXPOSED TO FIRE

To validate the proposed model for experiments according to Configuration 1 in Fig. 2, M12 anchors directly exposed to fire were modelled numerically with 110 mm embedment depth and 40 mm extended length above the concrete surface. The anchors were installed in 300 mm thick concrete beams. The numerical 3D model presented in Fig. 1 and Fig. 2 represent configuration 1 in Fig. 2.

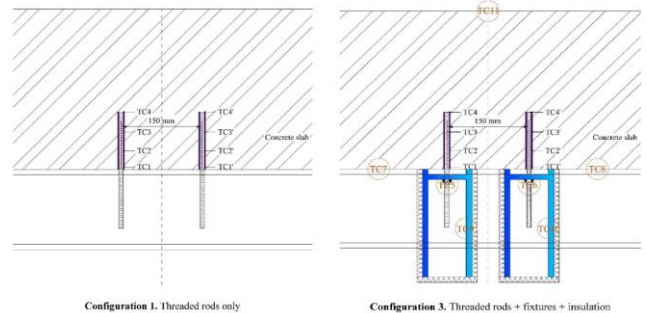

Fig. 2: Configurations of tested specimens in Al-Mansouri et al. [16]

Fig. 3 shows a comparison between numerical and experimental temperature profiles for anchors directly exposed to ISO 834 fire conditions [19]. Temperature profiles obtained numerically by 3D analysis are in good agreement with experimental results. Numerical results of the 3D model gave higher temperatures due to several facts: first, the numerical model accounts for Eurocode conservative fire conditions which are represented at a homogeneous close distance from the exposed surface. In case of a real fire test, temperature measurement at concrete surface gives lower values than the numerical 3D model (1<sup>st</sup> thermocouple in experimental values in Fig. 3).

The difference near the exposed surface of the anchor between numerical and experimental values is linked to the overestimation of temperature profiles in this area by the numerical model. In addition, this difference could be explained by the absence of resin in the model. The model does not account for the existence of the adhesive resin in the simulation and therefore excludes the effect of the bond on heat transfer. The absence of the resin in the model influences the parts near the exposed surface where the fire conditions are applied by radiation and convection. Temperature measured of the deeper parts of the anchor, where fire conditions applied on the exposed surface are far enough and heat transfer occurs via conduction only, seem to be in agreement with the 3D model.

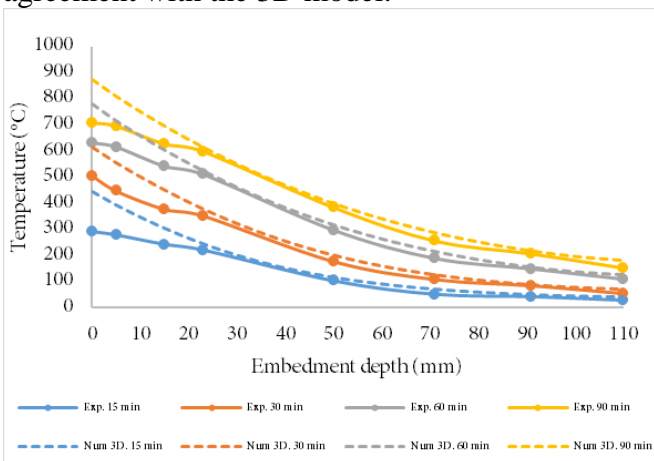

Fig. 3: Comparison between numerical and experimental temperature profiles for M12 anchors directly exposed to fire

Comparison between the load-bearing capacity vs. fire exposure time relationships obtained numerically and experimentally are plotted in Fig. 4. Four points were used to plot the bond strength vs. fire exposure time relationship using a power trend curve. The numerically obtained curve based on 3D analysis yielded safe results compared to the experimentally obtained curve. For example: for an applied load of 9 kN on M12 bonded anchor, previous experimental work by the current authors [16], reached pull-out failure under ISO 834 fire conditions [19] at 29 min. The Resistance Integration Method based on temperature profiles obtained experimentally predicted a failure time of 28 min for a load of 9 kN. Based on numerically obtained temperature profiles, resistance integration using 3D analysis predicted failure time of 25 min. Therefore, the model produced

conservative results compared to experimental results for anchors directly exposed to fire.

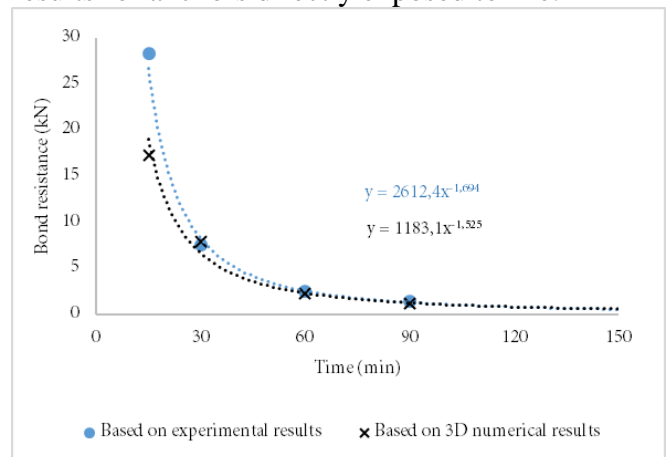

Fig. 4: Comparison between experimentally and numerically predicted bond strength vs. fire exposure time relationships for anchors directly exposed to fire

## 2.2 ANCHORS WITH INSULATED FIXTURES

In previous experimental work by the current authors [16], anchors with insulated fixtures were exposed to ISO 834 fire conditions [19]. The insulating material consisted of glass wool with a thickness of 50 mm. To validate the proposed model for the configuration of anchors insulated fixtures (Configuration 3 in Fig. 2), M12 anchor was modelled with an embedment depth of 110 mm and extended length of 40 mm. The anchors were installed in 300 mm thickness concrete beams.

Fig. 5 shows a comparison between numerical and experimental temperature profiles for anchors with insulated fixtures. The Resistance Integration Method was applied to calculate the predicted load-bearing capacity vs. fire exposure time relationships. Comparison between load-bearing capacity vs. fire exposure time relationships obtained numerically and experimentally are plotted in Fig. 6. The numerically obtained curve from 3D analysis is conservatively in agreement with the experimentally obtained curve. The small difference observed between numerical (3D modelling) and experimental temperature profiles is due to conservative Eurocode material properties as described earlier in this section.

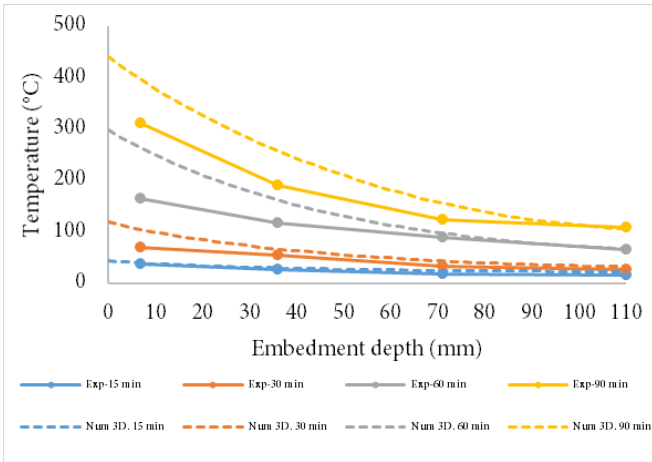

Fig. 5: Comparison between experimental and numerical temperature profiles for M12 anchor with insulated fixtures

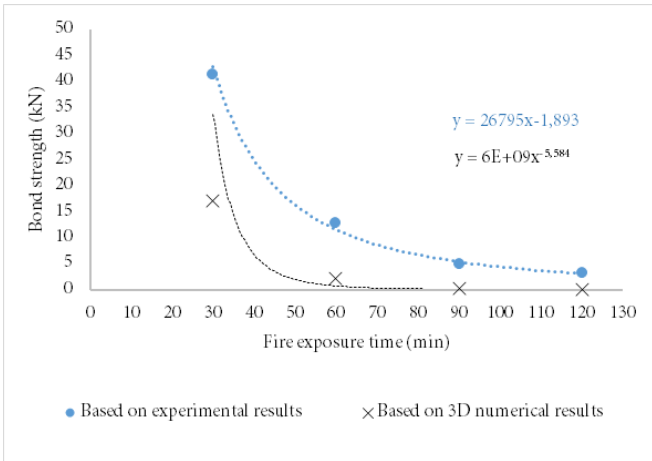

Fig. 6: Comparison between experimentally and numerically predicted bond strength vs. fire exposure time relationships for M12 anchor with insulated fixtures

### 3. PARAMETRIC STUDY

After validation of the proposed model, an expanded parametric study was conducted to investigate the effect of other parameters that may influence temperature profiles along the embedment depth of the anchor under ISO 834 fire [19] conditions. For the parametric study, material properties for concrete and steel were the same as used for the validation. For maximum influence of the boundary conditions of the ISO 834 fire, all studied parameters were conducted on anchors with configuration 1 in Fig. 2.

#### 3.1 EXTENDED PART OF THE ANCHOR

To assess the influence of the extended length of the anchor outside of the concrete on the precision

of the evaluation method of bonded anchors under ISO 834 fire conditions [19], the presented model was used to conduct simulations for multiple extended lengths per diameter (from no extended length to 15 diameters of extended length from concrete surface). The adopted dimensions for the concrete beam are the same as used for the validation: 1500 mm length, 230 mm width and 300 mm thickness. Studied diameters were M8 and M12.

First, a series of simulations was conducted on an embedment depth of  $h_{ef}=10*d$ . Radiative and convective fluxes were applied on all the surfaces of the extended length (varying from 0 mm to  $15*d$ ). Results are shown in Fig. 7 for M8 and M12 diameters. The extended length of the anchor has a significant influence on temperature profiles from 0 mm (no extended length modelled, i.e. the steel of the anchor is flush with the concrete surface) to 20 mm. The influence is negligible beyond 20 mm of extended length. When modelling the steel of the anchor flush with the concrete surface, a reduction in temperature profiles is obtained, most prominently near the exposed part of the anchor. This difference decreases towards the deeper parts of the anchor. This could be attributed to the fact that the deeper parts of the anchor are subjected to conduction with concrete in both cases with and without modelling of extended length, whereas anchor segments near the fire condition-exposed surface are influenced by the absence of the extended length and the applied radiation and convection of ISO 834 fire [19] on its lateral sides. Simulations conducted on a shorter embedment depth ( $4*d$ ) lead to the same conclusion.

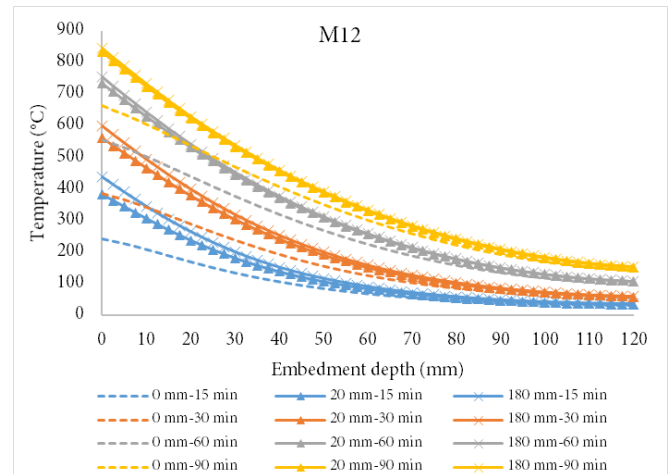

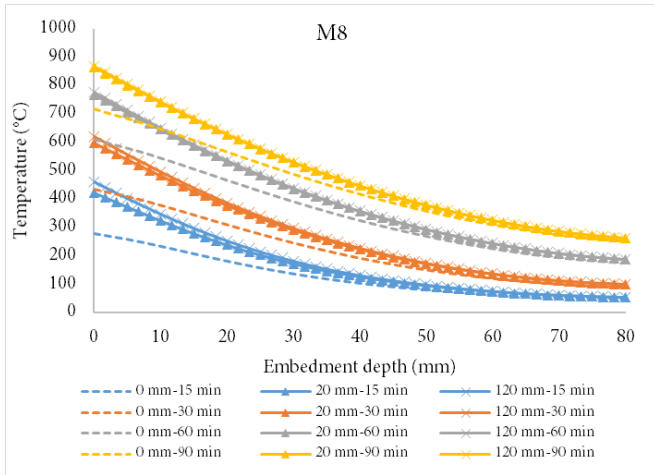

Fig. 7: Temperature profiles for M8 and M12 anchors with  $h_{ef}=10*d$  for different extended lengths

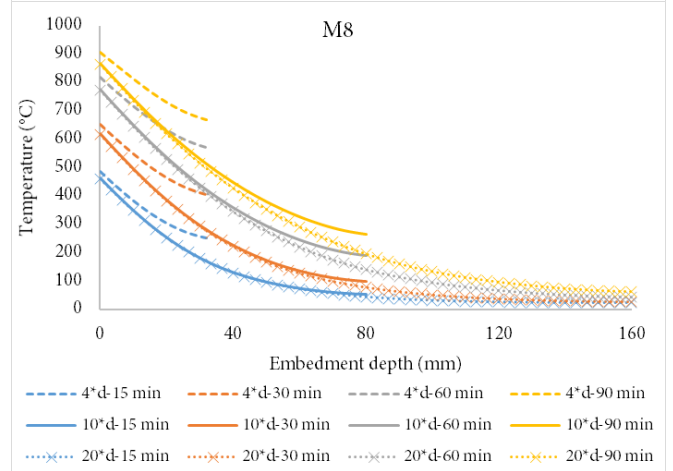
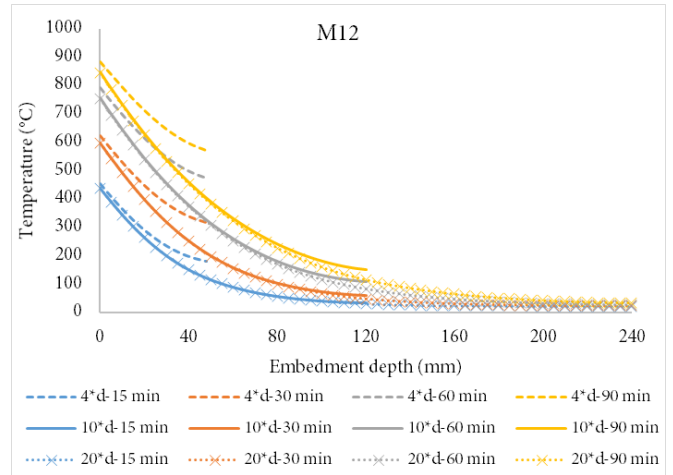

Fig. 8: Temperature profiles for M8 and M12 anchors with extended length of  $10*d$  for different embedment depths

### 3.2 EMBEDDED DEPTH OF ANCHORS

To assess the influence of the embedment depth on the temperature profiles, simulations on anchors with multiple embedment depths for different anchor diameters (M8 and M12) were conducted. An extended length of  $10*d$  was chosen. Dimensions for the concrete beam are the same as used for the validation. Simulation results show that for a fixed value of extended length and for the same point of observation, temperature profiles vary very little near the exposed surface of the anchor and significantly at the deepest part of the embedment depth. This variation takes place for a range of embedment depths between  $4*d$  and  $10*d$ . This variation is manifested by higher temperatures for shorter embedment depths. Because shorter anchors have less steel quantity inside the concrete element, shorter thermal bridges are created and heat transfer between steel and concrete is smaller for shorter embedment depths compared to long embedment depths. For embedment depths between  $10*d$  and  $20*d$ , for the same point of observation the difference in temperature is insignificant. In addition, for shorter anchors there is a smaller exchange surface between steel and concrete leading to less thermal interaction between both materials and therefore giving higher temperatures. Fig. 8 shows temperature profiles for M8 and M12 anchors for the studied embedment depths.

### 3.3 CONCRETE ELEMENT INSULATION

To assess the influence of insulating the surfaces of the concrete element that were not exposed to fire conditions on temperature profiles of bonded anchors during fire tests, simulations on beams exposed to ambient air ( $20^{\circ}\text{C}$ ) on lateral sides were conducted. Results were compared to anchors in beams insulated on the lateral sides. Studied anchors are M8 and M12 anchors with embedded and extended lengths of  $10*d$ . Beam dimensions were 1500 mm length by 300 mm thickness. The smallest beam width (90 mm = fixture width) was adopted for maximum influence. Fig. 8 shows that temperature profiles for insulated beams vs. exposed beams are relatively close and no significant influence is observed during fire exposure up to 30 min. At 60 min, a small difference is observed. However, this difference does not influence load-prediction because almost all the segments of the anchor have reached a temperature at which the chemical

resin has very minimal or no resistance left. It is reasonable to say that wider beams are less influenced by the existence/absence of insulation on the lateral sides of the beam.

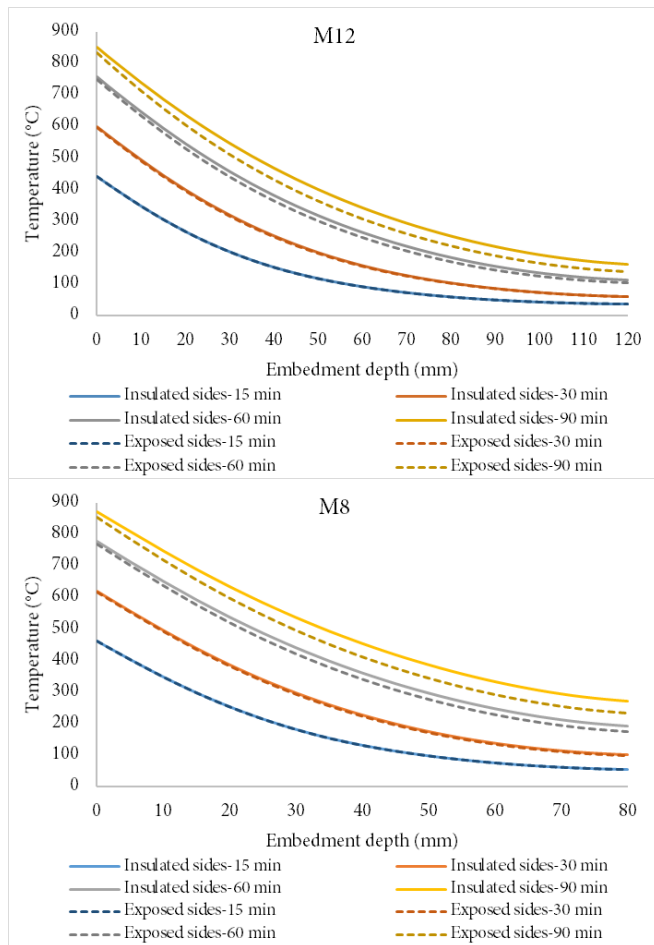

Fig. 8: Temperature profiles for M8 and M12 anchors in insulated beams and beams exposed to ambient air on all sides

#### 4. CONCLUSION

This paper presents a numerical model for calculating the load-bearing capacity of chemically bonded anchors in uncracked concrete under ISO 834 fire conditions [19]. The model solves transient heat transfer equations to obtain temperature profiles along the embedment depth of anchors without considering the properties of the bonding material. This output serves as input for the bond Resistance Integration Method. Bond strength contributions of segments along the embedment depth of anchors can then be computed during fire exposure. The model was benchmarked with experimental results obtained in a previous experimental study [16]. Good comparison and safe results were obtained for numerically obtained load-bearing capacity vs. fire

exposure time relationships based on 3D analysis compared to experimental results.

A parametric study was also presented after experimental validation of the model. This study investigated parameters that may influence thermal evaluation of bonded anchors under fire conditions. Temperature profiles of anchors for different configurations were compared, resulting in the following conclusions:

- Insulated fixtures produce unconservative estimations of the temperature profile of anchors exposed to fire conditions.
- The length of the anchor extended outside of the concrete surface has a significant influence on temperature profiles between no modelling of the extended length and 20 mm of extended length. Beyond 20 mm of extended length the influence is insignificant.
- The embedded length of the anchor has an influence on temperature profiles between  $h_{ef}=4*d$  and  $h_{ef}=10*d$ . Beyond  $h_{ef}=10*d$  of embedment depth the influence is insignificant.
- The insulation of the concrete bearing element's lateral sides has no significant influence on load prediction.

This parametric study establishes a basis for variables to be considered in guidelines for the evaluation of bonded anchors under fire conditions. More experiments are recommended for further validation of the obtained results.

#### ACKNOWLEDGEMENTS

The research presented in this paper was conducted at CSTB (Centre Scientifique et Technique du Bâtiment). The authors would like to acknowledge the funding provided by Hilti corporation. The authors would also like to acknowledge Eng. Paul Lardet, Dr. Yahia Msaad, Dr. Seddik Sakji, Dr. Mhd Amine Lahouar, Dr. El Mehdi Koutaiba and the staff of the fire resistance laboratory of Mr. Romuald Avenel and Mr. Stéphane Charuel at CSTB for their contribution to this work.

#### REFERENCES

1. Sato H, Fujikake K, Mindess S, 2004. Study on dynamic pullout strength of anchors based on



failure modes. In: *13th World conference on earthquake engineering, vol. 854, August 1–6. Vancouver, B.C., Canada.*

2. Bingöl AF, Gül R, 2009. Residual bond strength between steel bars and concrete after elevated temperatures. *Fire Saf J; 44:854–9.*

3. Cook R, 1993. Behavior of chemically bonded anchors. *J Struct Eng; 119(9):2744–62.*

4. Eligehausen R, Werner F, 2007. Recent developments and open problems in fastening technique. In: *2nd international symposium on connections between steel and concrete, Stuttgart, FIB, Germany.*

5. Muciaccia, G., Navarrete, D.D., Pinoteau, N., Mege, R, 2019. Effects of different test apparatus and heating procedures on the bond properties of post-installed rebar connections under elevated temperatures. *Mater Struct 52: 47.*

6. Reis J, 2012. Effect of temperature on the mechanical properties of polymer mortars. *Mater Res; 15(4):645–9.*

7. EN 1992-1-2. Eurocode 2: Design of concrete structures – Part 1-2: General rules – Structural fire design. July 2008.

8. EN 1993-1-2. Eurocode 3: Design of steel structures – Part 1-2: General rules – Structural fire design. November 2005.

9. Sorathia U, Lyon R, Gann R, Gritzo L, 1997. Materials and fire threat. *Fire Technol J; 33(3):260–75.*

10. Frigione M, Aiello M, Naddeo C, 2006. Water effects on the bond strength of concrete/concrete adhesive joints. *Constr Build Mater; 20:957–70.*

11. Pinoteau N, Pimienta P, Guillet T, Rivillon R, Remond S, 2012. Effect of heat on the adhesion between post-installed bars and concrete using polymeric mortars. In Cairns JW, Metelli G, Plizzari GA, editors. *Bond in Concrete 2012 - Bond in New Materials and under Severe Conditions; Brescia. Italy. p. 573-580.*

12. Lahouar MA, Caron J-F, Pinoteau N, Forêt G, Benzarti K, 2017. Mechanical behavior of adhesive anchors under high temperature exposure: experimental investigation. *Int J Adhes Adhes; 78:200–11.*

13. Adams R, Coppendale J, Mallick V, Al-hamdan H, 1992. The effect of temperature on the strength of adhesive joints. *Int J Adhes Adhes; 12(3):185–90.*

14. EOTA TR 020. Evaluation of anchorages in concrete concerning resistance to fire. European

Organization for Technical Approvals Technical report no. 20. May 2005.

15. Eligehausen R, Mallée R, Silva JF, 2006. *Anchorage in concrete construction. Ernst & Sohn.*

16. Al-Mansouri O, Mege R, Pinoteau N, Guillet T, Rémond S, 2019. Influence of testing conditions on thermal distribution and resulting load-bearing capacity of bonded anchors under fire. *Eng Struct J; 192:190-204.*

17. Lakhani H, Hofmann J, 2017. A numerical method to evaluate the pull-out strength of bonded anchors under fire. *Proceedings of the 3rd international symposium on Connections between Steel and Concrete. Stuttgart, Germany. p. 1179–90.*

18. Lakhani H, Hofmann J, 2018. On the pull-out capacity of post-installed bonded anchors and rebars during fire. *Proceedings of the 10<sup>th</sup> International Conference on Structures in Fire. Belfast, UK. p. 165-71.*

19. ISO 834-1 International Standard. Fire-resistance tests – Elements of building construction – Part 1: General requirements. First edition, 15 September 1999.

20. EOTA. EAD 330087-00-0601. Systems for post-installed rebar connections with mortar. no. EOTA14-33-0087-06.01. July 2015.