



HAL
open science

Numerical investigation of parameters influencing fire evaluation tests of chemically bonded anchors in uncracked concrete

Omar Al-Mansouri, Romain Mege, Nicolas Pinoteau, Thierry Guillet, Roberto Piccinin, Kenton Mcbride, Sébastien Rémond

► To cite this version:

Omar Al-Mansouri, Romain Mege, Nicolas Pinoteau, Thierry Guillet, Roberto Piccinin, et al.. Numerical investigation of parameters influencing fire evaluation tests of chemically bonded anchors in uncracked concrete. *Engineering Structures*, 2020, 209, pp.110297. 10.1016/j.engstruct.2020.110297. hal-02479089

HAL Id: hal-02479089

<https://hal.science/hal-02479089>

Submitted on 3 Mar 2020

HAL is a multi-disciplinary open access archive for the deposit and dissemination of scientific research documents, whether they are published or not. The documents may come from teaching and research institutions in France or abroad, or from public or private research centers.

L'archive ouverte pluridisciplinaire **HAL**, est destinée au dépôt et à la diffusion de documents scientifiques de niveau recherche, publiés ou non, émanant des établissements d'enseignement et de recherche français ou étrangers, des laboratoires publics ou privés.

NUMERICAL INVESTIGATION OF PARAMETERS INFLUENCING FIRE EVALUATION TESTS OF CHEMICALLY BONDED ANCHORS IN UNCRACKED CONCRETE

Omar Al-Mansouri^{a,b}, Romain Mège^a, Nicolas Pinoteau^a, Thierry Guillet^a, Roberto Piccinin^c, Kenton McBride^c, Sébastien Rémond^d

^a Université Paris-Est, Centre Scientifique et Technique du Bâtiment (CSTB), 84 avenue Jean Jaurès, Champs-sur-Marne, 77447 Marne-la-Vallée Cedex 2, France

^b IMT Lille-Douai, Univ. Lille, EA 4515 – LGCGE, Département Génie Civil & Environnemental, F-59000 Lille, France.

^c Hilti Corp., Schaan, Principality of Lichtenstein.

^d Univ Orléans, Univ Tours, INSA CVL, LaMé, EA 7494, France.

Corresponding author's e-mail : omar.almansouri@cstb.fr

Abstract

European guidelines for fire performance evaluation of post-installed anchoring systems are limited to mechanical (e.g., expansive, undercut) mechanisms of load transfer and the steel failure mode, whereas the adhesive bond mechanism remains unaccounted for in chemically bonded anchors. Furthermore, current evaluation methods do not account for the influence of practical testing conditions on temperature profiles along the bonded depth. This paper presents 3D finite element thermal simulations of chemically bonded anchors in uncracked concrete exposed to ISO 834 fire conditions with comparisons to experimental specimens. Five parameters representing application and testing conditions are investigated to assess their influence on temperature profiles along the embedment depth of bonded anchors. A numerical model is proposed based on the results of the numerical simulations to determine thermal data necessary for predicting the load-bearing capacities of bonded anchors using the Resistance Integration Method. The model adopts Eurocode material properties for concrete and steel, with 3D analysis yielding conservative capacity prediction compared to physical fire tests. 3D and 2D simulation results are compared, demonstrating that modelling using 2D heat transfer analysis yields inaccurate temperature profiles compared to 3D modelling. After experimental validation of the proposed model, additional parameters are explored in a numerical parametric study: embedded depth, external length of the anchor element, insulation of the anchor element, and insulation of the concrete element. Results show that the embedded depth has a significant influence on temperature profiles along the bond. Moreover, the external length of the anchor influences temperature profiles, but not beyond 20 mm from the concrete surface.

Keywords: adhesive resin, bonded anchor, fire tests, thermal distribution, numerical model, Resistance Integration Method.

1. Introduction:

Post-installed anchoring systems may be split into two categories: (1) mechanical and bonded anchors used to transfer the combination of tensile and shear loads from a steel fixture to a concrete substrate and (2) post-installed reinforcement (PIR) used to connect new reinforced concrete elements to existing concrete. Post-installed chemically bonded anchoring systems are used in new and existing reinforced concrete structures as an alternative to cast-in-place solutions and where an anchoring location is unplanned or requires remediation. The bonding material may consist of combinations of polymeric resin, cement, other admixtures, and filling materials. Resins used in post-installed bonded anchors include polyester, vinylester, and epoxy resins [1]. Load is transferred to concrete through adhesive bond and friction, producing bond stresses that are nearly uniformly distributed along the bonded embedment depth, in contrast to headed and post-installed mechanical anchors where load introduction into concrete is concentrated at the end of the anchorage [2]. Resins used in bonded anchors are viscoelastic and therefore demonstrate creep deformation under sustained loads [3].

Studies have demonstrated that the mechanical behavior of bonded anchors is influenced by many factors including geometry, material properties, installation procedure, and environmental factors such as moisture and temperature [4-7]. The mechanical properties of adhesive resins are particularly temperature dependent [8]. In fire conditions, structural members are exposed to rapid temperature increases, producing temperature gradients along the

embedment of the bonded anchors. Elevated temperatures degrade material properties of steel [9], concrete [10, 11], and resin [12], thus reducing the load-bearing capacity of the connection.

Different resin types exhibit varying sensitivities to increases in temperature. Investigations have shown, for example, that epoxy resins are more sensitive to temperature than polyester mortars [13]. In general, the effect of temperature on polymeric materials can be quantified by the glass transition temperature (T_g) [14], beyond which a reduction in stiffness and ultimate capacity are observed [15]. Studies on bonded PIR (post-installed reinforcement) showed that temperature increases to values below the glass transition temperature lead to an enhancement of the material properties of the resin. This is linked to the accelerated curing of the resin. When the glass transition temperature is exceeded in a loaded anchor, changes in physical state and viscosity occur, leading to a different stress distribution along the bonded embedment [16, 17]. Another investigation focused on the effect of heating rates [18], where it was found that high heating rates can lead to an initial thermal gradient along the steel member and therefore to a redistribution of bond stress.

Presently, the guidelines in EOTA TR 020 [19] address fire evaluation of mechanical anchors for all failure modes, but bonded anchors are only evaluated for the steel failure mode. Design failure modes for bonded anchors under tensile loading are concrete cone failure, steel failure, pull-out failure of the anchor, splitting failure of concrete and combined cone/pull-out failure [20]. Research studies [21, 22] showed that under fire conditions, pull-out may occur more frequently than other failure modes for common ranges of bonded anchor diameter and embedment. Researchers have established that there is a need for an accurate evaluation and design method for bonded anchors to complete the existing guidelines in EOTA TR 020 [19]. In these guidelines, it is permitted to insulate the steel fixture that transfers loads to anchors preventing the fixture from failing before the anchor. In a previous experimental work [24] the current authors presented three possible configurations of an anchor inside a building: direct exposure to fire, presence of a metallic fixture, and presence of insulation around the fixture. It was shown that, under ISO 834 fire conditions [23], the insulated configuration may produce an unconservative estimation of bond strength compared to the configuration where the anchor was directly exposed to fire.

Prediction of the load-bearing capacity of bonded anchors has been investigated in multiple research studies. Thiele and Reichert [21] investigated different configurations of bonded anchors under fire conditions, also concluding that the current guidelines in EOTA TR 020 should be extended [19]. Lakhani and Hofmann [22] used finite element simulations to study the behavior of bonded anchors at high temperatures with a 2D model. This study recommended the Resistance Integration Method, which demonstrated promising results in the experimental work of Pinoteau et al. [18] and Lahouar et al. [25, 26]. Lakhani and Hofmann [22] concluded that the thermal distribution depends on the fire scenario under consideration (e.g., the ISO 834 fire and a cooling phase vs Hydrocarbon fire).

Lakhani and Hofmann [22,27] proposed a model to determine the load-bearing capacity of bonded anchoring systems (bonded anchors and PIR) under fire conditions. Their numerical results were compared to the experimental work of Muciaccia et al. [28] and Lahouar et al. [29]. The proposed model by Lakhani and Hofmann is based on the resolution of transient heat transfer using an implicit finite element scheme and an iterative solver. Only the concrete bearing element and the steel of the anchor were modelled and the adhesive resin was ignored, although [21] demonstrated that when the resin acts as an insulating material (having higher insulating properties than the insulating properties of concrete), it results in conservative calculations when it is not modelled. Their work highlighted the influence of different configurations of bonded anchors on thermal diffusion (e.g., direct exposure to fire, presence of an insulated fixture) and showed that the common modelling assumption of ignoring the reinforcing steel during heat transfer analysis may not be realistic due to the difference of thermal properties between steel and concrete.

Lakhani and Hofmann [27] performed 2D analysis with Cartesian coordinates on the failure of a post-installed cantilever floor modeling the test conducted by Lahouar et al. [29]. The experimental test failed at 117 min, whereas the predicted failure time by [27] was 80 min. For this example, temperature profiles calculated using 2D analysis modelling both concrete and the steel of the PIR (model A) for early exposure periods (e.g., 15 min) produce lower temperatures than 2D analysis accounting only for concrete and neglecting the modelling of steel (model B). This could be attributed to the fact that 2D analysis implies an infinite length of steel in the unmodelled 3rd dimension, whereas 2D analysis accounting only for concrete assumes that PIR has the same temperature as concrete at the same distance from the fire exposed surface. Furthermore, the model A did not account for the extended part of the anchor outside the concrete (see §2.1.).

Given the absence of generalized data and methodologies for fire-resistive design of anchoring systems, practical studies have been oriented toward providing solutions. Tian et al. [30] conducted an experimental study to enhance understanding of the behavior of mechanical anchors loaded in shear close to an edge under fire conditions.

Bosnjak et al. [31] proposed a 3D model for the resistance of post-installed reinforcement in concrete after exposure to fire for one-sided and three-sided fire exposure. Halvička and Lublőy [32] proposed a design method for concrete cone failure of bonded anchors in thermally damaged concrete. Nevertheless, a general assessment and design concept for fire-resistance of bonded anchoring systems remains absent from guideline documents.

This paper presents a numerical study of the temperature profiles of bonded anchors exposed to ISO 834 fire conditions [23] for use in predicting the load-bearing capacity. A heat transfer analysis was conducted using ANSYS 3D finite element analysis to obtain the temporal and spatial distribution of temperature [Eq. (1)]. Using the output data of temperature profiles with the existing bond stress vs. temperature relationship of the adhesive resin, the load-bearing capacity of the anchor was computed by numerically integrating the temperature-dependent bond stress capacity along the embedment depth of the anchor. The results of this model were compared to test results from pull-out fire tests on bonded anchors with different configurations studied in [24]. After the validation of the model, a parametric study was conducted to investigate the influence of other parameters on the precision of evaluation tests of bonded anchors under fire conditions. The results of this 3D model were compared to a commonly used 2D Cartesian coordinate system without modelling the part of the anchor extending above the concrete surface.

Capacity prediction using the Resistance Integration Method depends on accurate knowledge of temperature profiles along the bonded embedment. Testing under ISO 834 fire conditions [23] is influenced by many parameters including fixture configuration and modelling assumptions. The 3D model was validated against empirical results for the following configurations:

- Direct exposure of the anchorage to fire.
- Insulation of fixtures.

The model was then used for the investigation of additional parameters that may influence temperature profiles along the embedment depth of the anchor under ISO 834 fire [23] exposure:

- Extended length of the anchor above the concrete surface.
- Embedded length of the anchor inside concrete.
- Concrete element insulation.

2. 3D model using ANSYS

This section describes the model used for the determination of the load-bearing capacity under ISO 834 fire conditions [23] for bonded anchors in uncracked concrete. Temperature profiles from this model are coupled with the Resistance Integration Method (see §2.2) for the determination of bond strength.

2.1. Description of the 3D model

The model consists of solving 3D transient heat transfer equations to obtain temperature distribution at any given time of fire exposure. Concrete and steel components are modeled, but the resin is conservatively ignored because the thermal properties are product dependent. Because polymer materials possess insulating properties, a model that takes only into account steel and concrete and ignores the resin yields higher temperature profiles. Material properties of concrete and steel are obtained from Eurocode 2 [10]. The fire exposed surface is subjected to both radiative and convective fluxes of the ISO 834 fire [23].

The numerical model presented in this paper observes the following characteristics

- The bonded anchor resin is not modeled.
- Steel threads are not modeled.
- The concrete remains uncracked.
- Concrete spalling is ignored.
- The fire exposed surface of all elements is subjected to convective and radiative fluxes of ISO 834 fire temperatures [23] on all sides.
- The unexposed fire surface of concrete beams is subjected to convective and radiative fluxes of ambient air at 20°C.
- Slip of anchors is ignored.

During a fire, heat transfer occurs between fire and exposed elements at the boundaries via convection and radiation. The heat propagates inside the members via conduction. ANSYS solves the governing differential equation for 3D transient heat conduction using implicit scheme and iterative solver (Eq. (1)).

$$\rho c \frac{\partial T}{\partial t} = k \left(\frac{\partial^2 T}{\partial x^2} + \frac{\partial^2 T}{\partial y^2} + \frac{\partial^2 T}{\partial z^2} \right) \dots \text{Eq. (1)}$$

The 3D model represents the anchor as a cylinder inside a concrete beam with modelling of the extended and embedded length of the steel anchor element (Fig. 1).

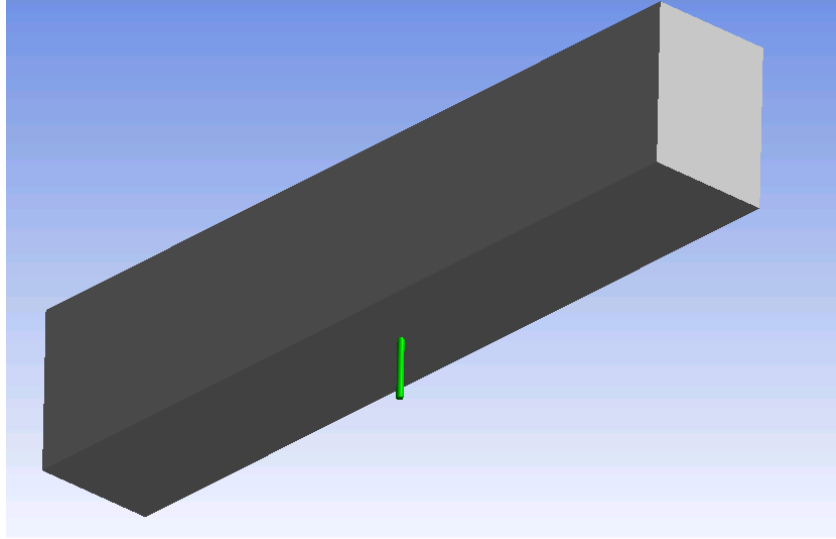

Fig. 1: Anchors directly exposed to fire using 3D modelling in ANSYS

Eq. (2) describes the Neumann boundary condition satisfied at the fire-exposed surface:

$$-k \frac{\partial T}{\partial n} = h_{fire}(T_s - T_{fire}) + \varepsilon \sigma (T_s^4 - T_{fire}^4) \dots \text{Eq. (2)}$$

Eq. (3) describes the Neumann boundary condition satisfied at insulated surfaces:

$$-k \frac{\partial T}{\partial n} = 0 \dots \text{Eq. (3)}$$

Eq. (4) describes the Neumann boundary condition satisfied at the upper surface of the beam exposed to ambient air at 20°C:

$$\dot{q}_{total} = h_{air}(T_s - T_{air}) + \varepsilon \sigma (T_s^4 - T_{air}^4) \dots \text{Eq. (4)}$$

Where:

- \dot{q}_{total} is the total heat flux applied to the surface,
- k is the thermal conductivity (W/m.K),
- ρ is the mass density (kg/m³),
- c is the specific heat (J/kg.K),
- h_{fire} is the convective heat transfer coefficient for the fire exposed surface (25 W/m².K),
- h_{air} is the convective heat transfer coefficient for the surface exposed to air at 20°C (4 W/m².K),
- σ is surface emissivity (0.7),
- ε is the Boltzmann constant (5.667×10⁻⁸ W/m².K⁴),
- T_s is the solid surface temperature (K),
- T_{fire} is gas temperature inside the furnace as a function of time (K),
- T_{air} is ambient air temperature (293 K).
- t is time

Boundary conditions are represented in a profile view of the 3D model in Fig. 2.

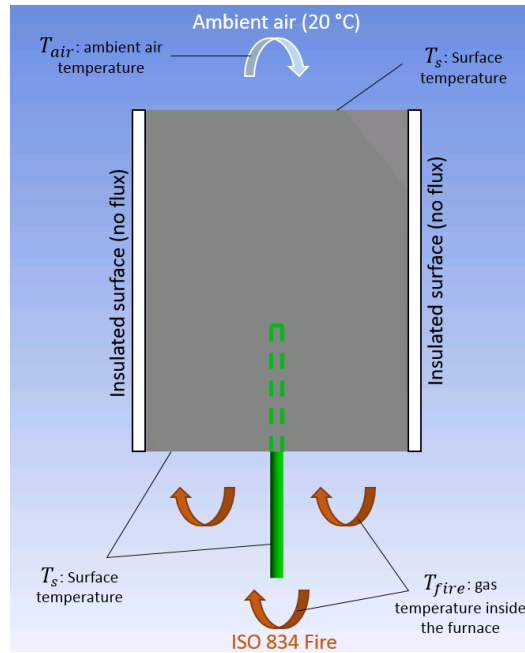

Fig. 2: Boundary conditions applied in the 3D heat transfer analysis for anchors directly exposed to fire.

Numerical studies of bonded anchors commonly model transient heat in 2D using Cartesian coordinates and neglect the portion of the anchor outside the concrete surface. Eq. (5) is the governing equation solved to obtain the spatial and temporal temperature distribution in 2D.

$$\rho c \frac{\partial T}{\partial t} = k \left(\frac{\partial^2 T}{\partial x^2} + \frac{\partial^2 T}{\partial y^2} \right) \dots Eq. (5)$$

The 2D model implies that the anchor is a long plate inside the concrete beam as illustrated in Fig. 3, which overrepresents the quantity of steel in the concrete member.

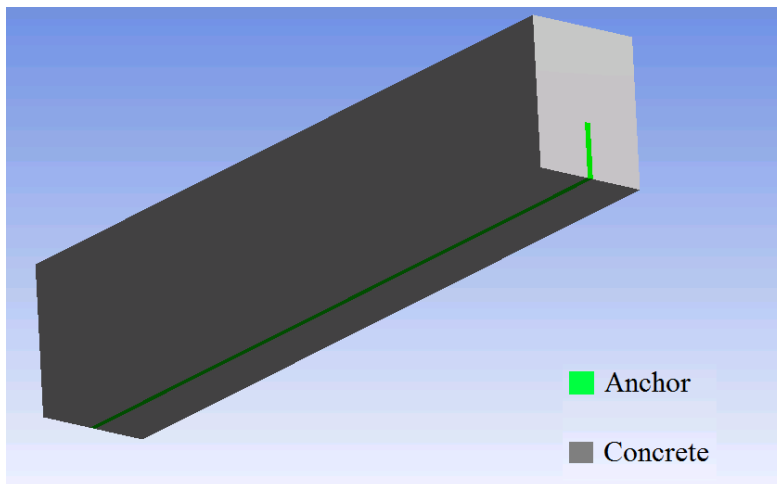

Fig. 3: Anchor directly exposed to fire using 2D modelling in ANSYS with Cartesian coordinates

Boundary conditions are represented in a profile view of the 3D model in Fig. 4.

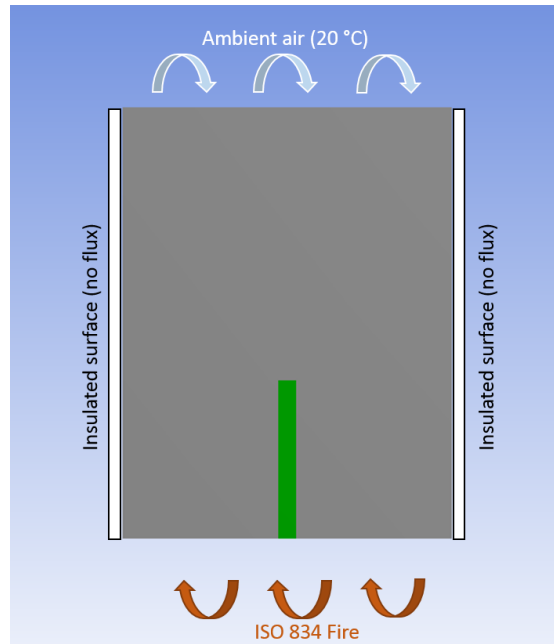
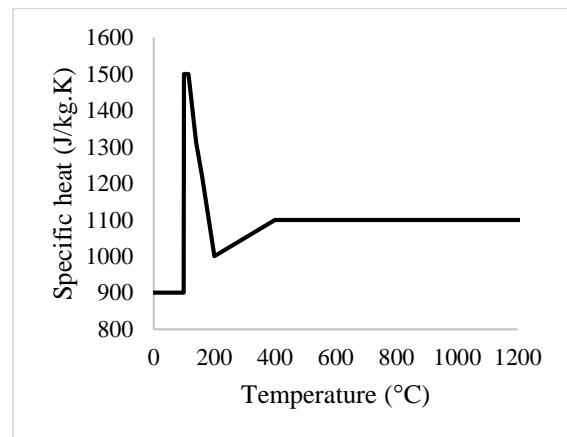
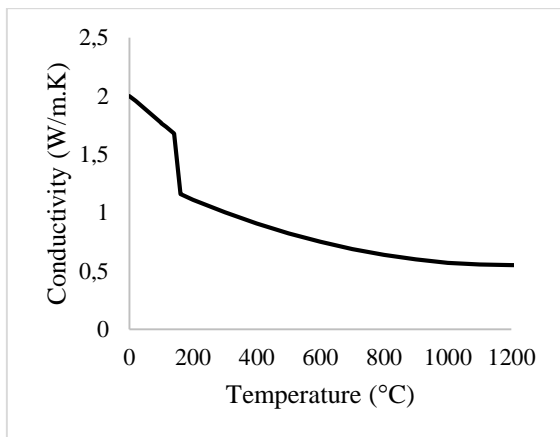
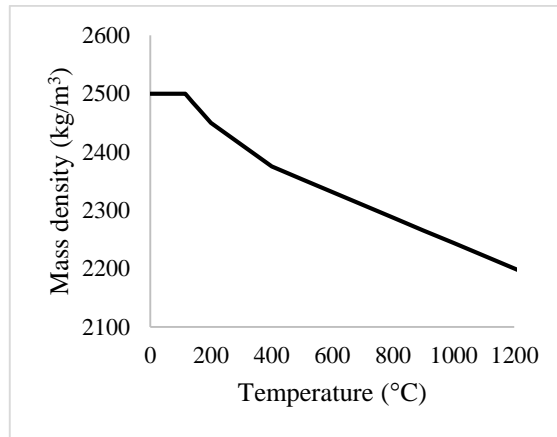

Fig. 4: Boundary conditions applied in the 2D heat transfer analysis for anchors directly exposed to fire.

Concrete and steel were modelled as solids in ANSYS. A bonded interface was chosen for the connection between steel and concrete. The bonded option in ANSYS allows no sliding or separation between faces or edges, resulting in perfect contact between the inner surface of the hole/concrete and the outer surface of the anchor/steel. No gaps are allowed with this option and the nodes of the mesh at the interface are superimposed from both concrete and steel surfaces. Thermal properties of concrete and carbon steel (conductivity, specific heat and mass density) are a function of temperature. The properties according to the French national annex in Eurocode 2 [10] for both materials were adopted in this study (Fig. 5). The mass density of the steel (7850 kg/m^3) [9] is considered constant with respect to temperature.





(a) Concrete

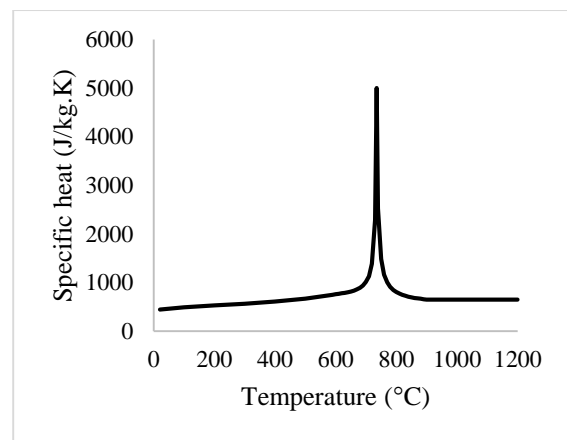
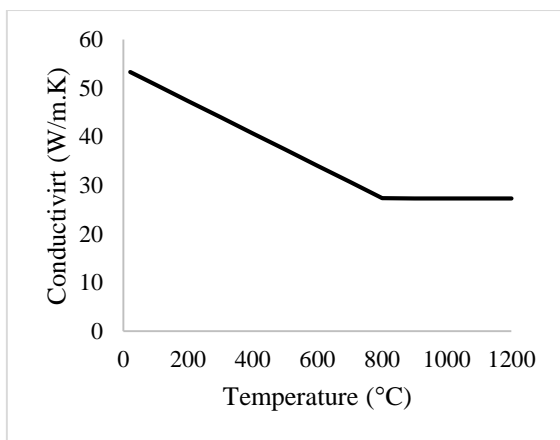

(b) Carbon steel

Fig. 5: Variation of thermal properties of concrete and steel according to NF EN 1992-1-2 [10]

2.2. Prediction of the load-bearing capacity using the Resistance Integration Method

The transient heat transfer analysis conducted in the previous step produces the temperature profiles used by the Resistance Integration Method. In both 2D and 3D models, threads are ignored and the nominal diameter is used. The bonded length is divided into 5-mm segments, where each segment is assigned a uniform temperature. The second input needed for the calculation of bond stress inside each segment of the anchor is the variation of bond stress capacity vs. temperature according to EAD 330087-00-0601 [33], for which bond stress capacities of the bonded anchor system are determined as a function of temperature. Each segment is therefore attributed an individual bond stress capacity based on the temperature associated with the segment. Numerical integration of the temperature-dependent bond stress capacity of all segments yields the predicted load-bearing capacity at any given moment of fire exposure.

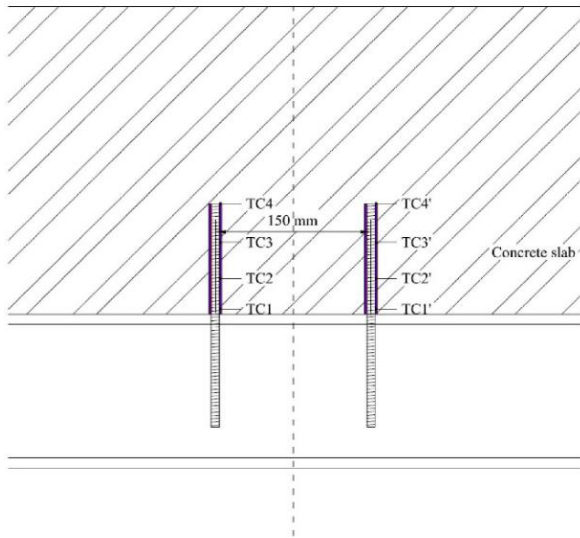

Configuration 1. Threaded rods only

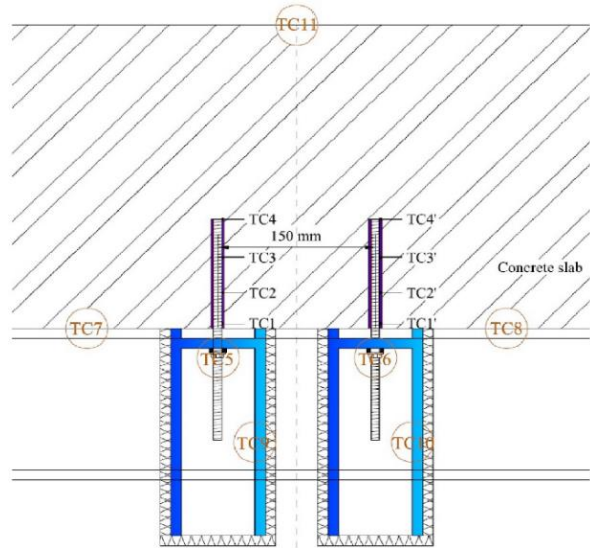

Configuration 3. Threaded rods + fixtures + insulation

Fig. 6: Configurations of tested specimens in Al-Mansouri et al. [24]

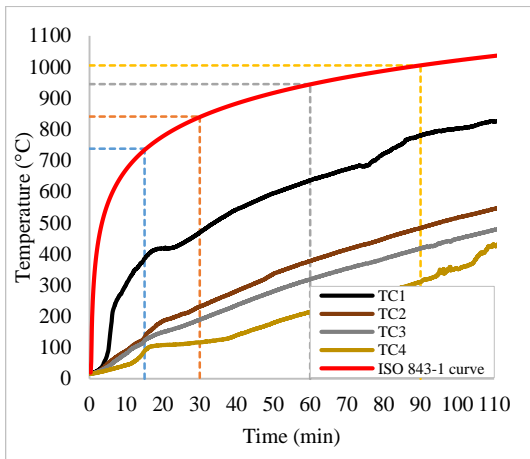

Furnace average Temperature vs. Exposure time

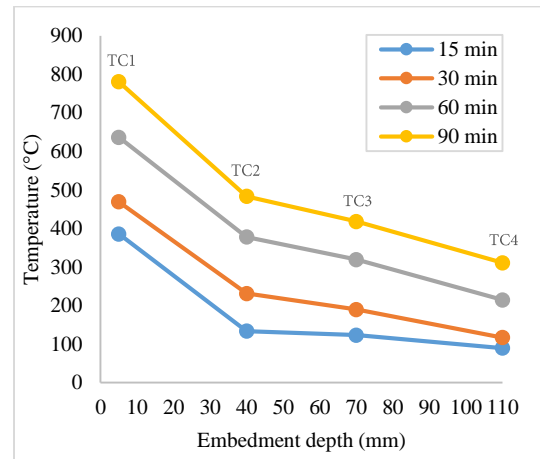

Experimental results – Resin Temperature vs. Embedment depth

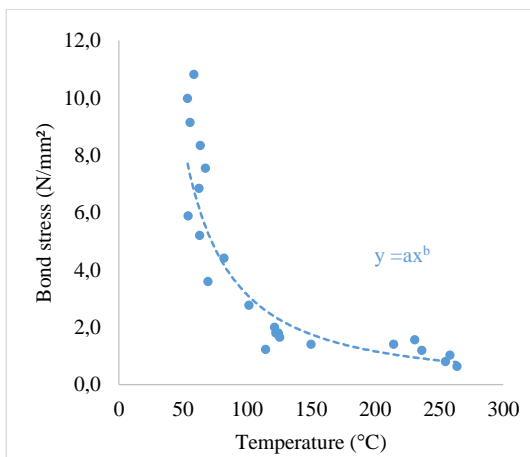

Fire test (acc. EAD) – Bond stress vs. Temperature

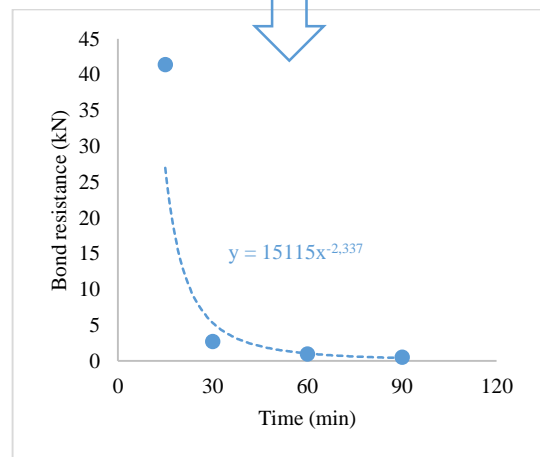

Bond strength vs. Time of exposure to ISO fire

Fig. 7: Steps of the Resistance Integration Method

The bond capacity of the anchor at any given time is calculated according to Eq. (6):

$$N_{Rd,fire} = \pi \cdot d \cdot \int_0^{h_{ef}} f_{bd,0} \cdot k(\theta(x)) \cdot dx \quad \dots Eq(6)$$

Where: $N_{Rd,fire}$ is the capacity under fire conditions (N),
 d is the diameter of the anchor (mm),
 $f_{bd,0}$ is the design bond resistance at ambient temperature (N/mm²),
 $k(\theta)$ is a reduction factor that depends on temperature,
 $\theta(x)$ is the temperature distribution along the embedment depth of the anchor,
 h_{ef} is the embedment depth of the anchor (mm).

3. Validation of the model

To validate the numerical model, experiments on loaded and unloaded specimens from [24] were selected. The experimental specimens consisted of post-installed bonded anchors with M12 threaded rods and a commercial resin in C20/25 uncracked concrete beams with 230 mm width, 1500 mm length and 300 mm beam depth. The experimental configurations were 1) anchors directly exposed to fire, 2) metallic fixtures attached to anchors, and 3) insulated fixtures (metallic fixtures filled and surrounded by 50 mm insulating material). Because fixtures without insulation demonstrated no significant influence on temperature profiles and the resulting predicted load-bearing capacity, only configurations 1) and 3) were used for the validation of the model.

For validating load-prediction using thermal results from 3D modelling, the Resistance Integration Method was applied on temperature profiles obtained from experimental pull-out tests under fire conditions in accordance with EOTA TR 020 [19]. Fig. 6 shows a side view of the studied configurations and Fig. 7 shows the steps of the bond Resistance Integration Method based on temperature profiles of the experimental tests adopted for validating the model. **Erreur ! Source du renvoi introuvable.** shows the bond stress capacity vs. temperature relationship for the epoxy chemical resin obtained for the bonded anchor product used in the experimental specimens.

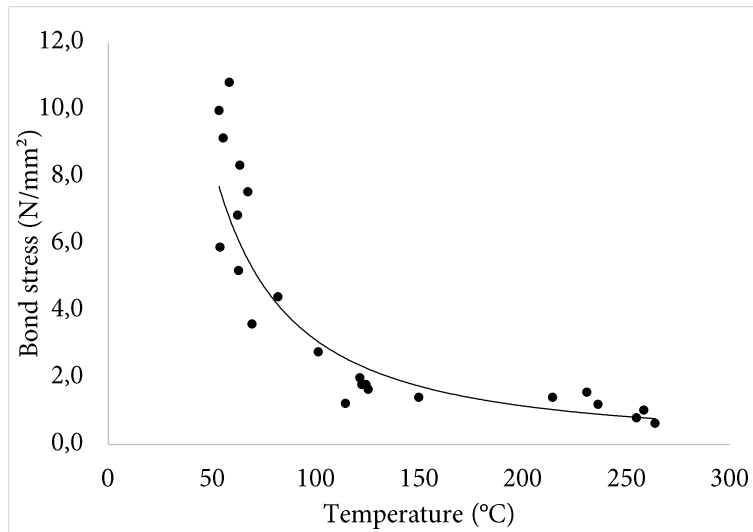

Fig. 8: Bond stress vs. temperature relationship for the bonded anchor product according to EAD 330087-00-0601 [33]

3.1. Anchors directly exposed to fire

For Configuration 1 in Fig. 6, M12 anchors directly exposed to fire were modelled with 110 mm embedment depth and 40 mm extended length outside the concrete surface. The numerical 3D model presented in Fig. 1 and Fig. 2 and the numerical 2D model presented in Fig. 3 and Fig. 4 represent configuration 1 in Fig. 6.

Fig. 9 shows a comparison between numerical (2D and 3D analysis) and experimental temperature profiles for anchors directly exposed to ISO 834 fire conditions [23]. Temperature profiles obtained numerically by 3D analysis are in agreement with experimental results. Numerical results of the 3D model produced higher

temperatures due to several factors. The numerical model accounts for Eurocode conservative fire conditions which are represented at a homogeneous close distance from the exposed surface. In case of a real fire test, temperature measurement at concrete surface gives lower values than the numerical 3D model (1st thermocouple in experimental values in Fig. 9). The difference near the exposed surface of the anchor between numerical and experimental values is linked to the overestimation of temperature profiles in this area by the numerical model. In addition, this difference could be explained by the absence of resin, which may serve as an insulator, in the model. Temperature measured at the deeper segments of the embedment, where fire conditions applied on the exposed surface and heat transfer occurs via conduction only, are in better agreement with the 3D model.

Simulation using 2D transient heat analysis yielded more homogeneous temperatures along the steel component compared to 3D analysis (Fig. 9). Compared to experimental results, this resulted in lower temperatures near the exposed surface and higher temperatures at the deeper parts of the anchor. The temperature inaccuracies are attributable to the inability of the geometry of 2D analysis to model the cylindrical anchor.

Comparison between the load-bearing capacity vs. fire exposure time relationships obtained numerically (both 2D and 3D analysis) and experimentally are plotted in Fig. 10. Four points were used to plot the bond strength vs. fire exposure time relationship, after which a power trend curve was fitted to the data. The numerically obtained curve based on 3D analysis yielded conservative results compared to the experimentally obtained curve. For example: for an applied load of 9 kN on M12 bonded anchor, the experimental result reached pull-out failure under ISO 834 fire conditions [23] at 29 min. The Resistance Integration Method predicted a failure time of 28 min using experimentally derived temperature profiles, 25 min using temperature profiles derived from 3D numerical analysis, and 19 min. using temperature profiles derived from 2D numerical analysis.

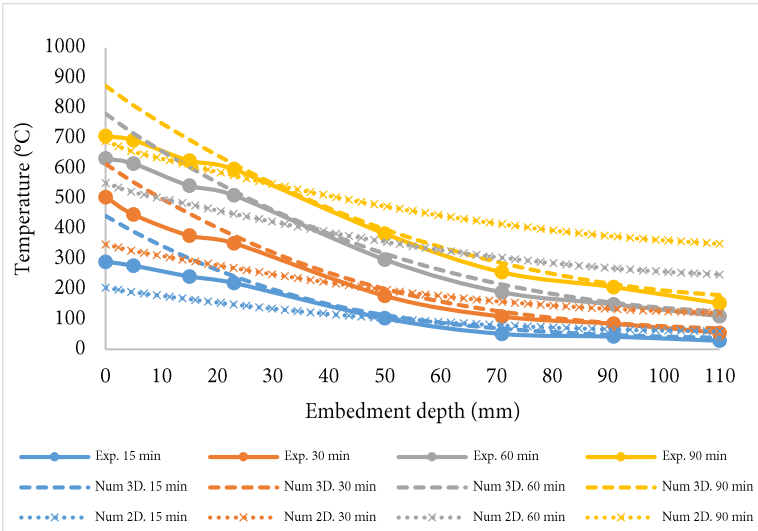

Fig. 9: Comparison between experimental and numerical (2D and 3D analysis) temperature profiles for M12 anchor directly exposed to fire

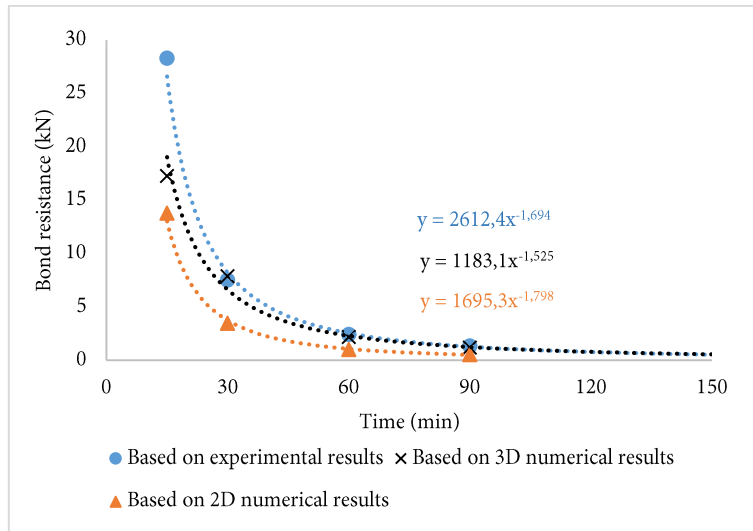

Fig. 10: Comparison between experimentally and numerically (2D and 3D analysis) predicted bond strength vs. fire exposure time relationships for anchors directly exposed to fire

3.2 Anchors with insulated fixtures

For Configuration 3 in Fig. 6 (anchors with insulated fixtures), the insulating material consisted of glass wool with a thickness of 50 mm. Thermal properties of the insulating material are plotted in Fig. 11. The M12 anchor was modelled with an embedment depth of 110 mm and extended length of 40 mm.

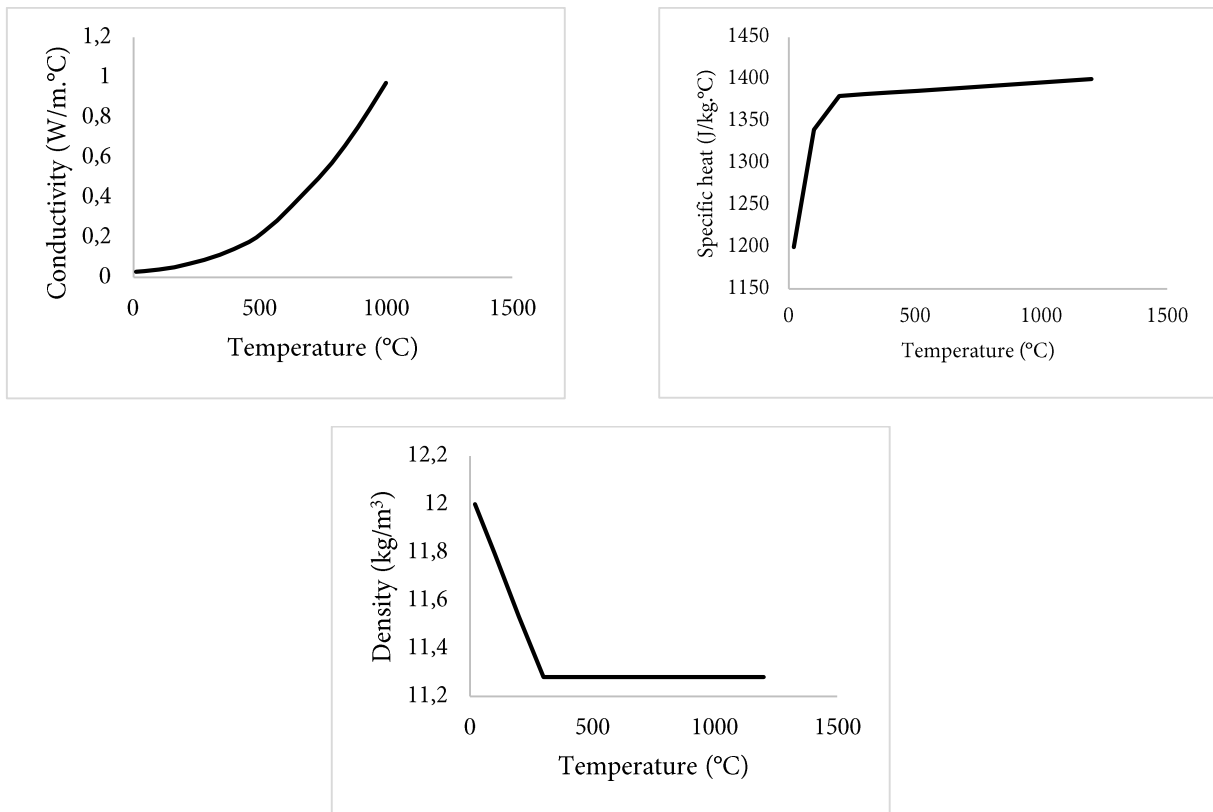

Fig. 11: Variation of thermal properties of the used insulating material

Fig. 12 shows a comparison between numerical and experimental temperature profiles for anchors with insulated fixtures. The Resistance Integration Method was applied to calculate the predicted load-bearing capacity vs. fire exposure time relationships. Comparison between load-bearing capacity vs. fire exposure time relationships obtained numerically (2D and 3D analysis) and experimentally are plotted in Fig. 12. The numerically obtained curve from 3D analysis is conservatively in agreement with the experimentally obtained curve. The small

difference observed between numerical (3D modelling) and experimental temperature profiles is due to conservative Eurocode material properties as described earlier in this section.

The presence of insulated fixtures is represented using 2D heat transfer analysis based on Cartesian coordinates by the same geometric configuration in Fig. 3. The difference between the two cases is that boundary conditions are only applied on the concrete surface beyond the insulated fixture and the fixture is not explicitly modelled. Therefore, Eq. (3) is applied on the surface where the insulated fixture is supposed to be. Fig. 13 represents boundary conditions applied in the 2D heat transfer analysis for anchors with insulated fixtures.

The presented model was used to study the case of anchors along with insulated fixtures based on the previous assumptions. Temperature profiles derived from 2D analysis produced lower temperatures than experimental results, which results in an unconservative prediction of the load-bearing capacity vs. fire exposure time using the Resistance Integration Method. The calculation of temperature profiles using 3D analysis modelling, both with fixture directly exposed to fire and with insulation, yields more accurate results (Fig. 14).

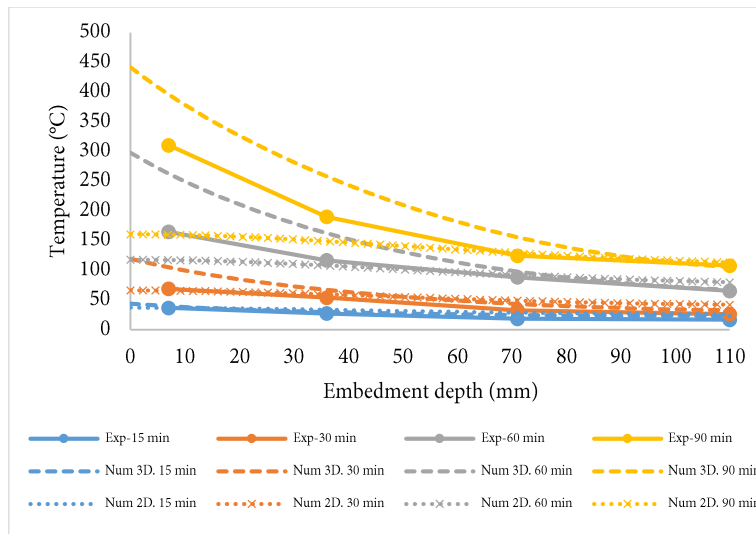

Fig. 12: Comparison between experimental and numerical (2D and 3D analysis) temperature profiles for M12 anchor with insulated fixtures

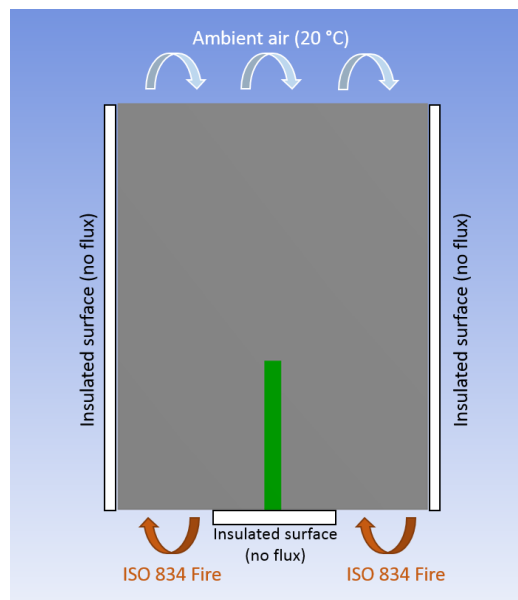

Fig. 13: Boundary conditions applied in the 2D heat transfer analysis for anchors with insulated fixtures

Comparisons between the load-bearing capacity vs. fire exposure time relationships obtained numerically (2D and 3D analyses) and experimentally are plotted in Fig. 14. The numerically obtained curve based on 3D analysis gave safe results compared to the experimentally obtained curve. This may be attributed to the fact that the numerical

model only takes into account steel and concrete, but in physical tests, the bonding material has an insulating effect on temperature profiles and reduces the thermal exchange between concrete and steel. Load prediction based on 2D analysis yielded unconservative results compared to experimental results.

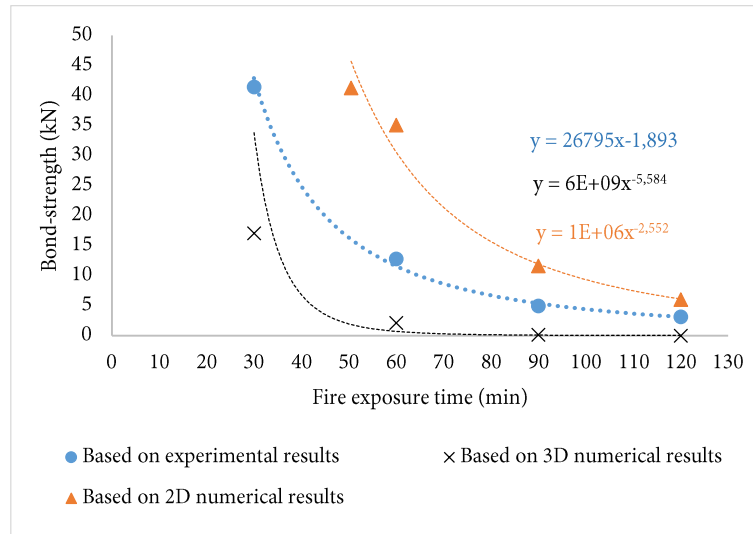

Fig. 14: Comparison between experimentally and numerically (2D and 3D analysis) predicted bond strength vs. fire exposure time relationships for M12 anchor with insulated fixtures

4. Parametric study

After validation of the proposed model, an expanded parametric study was conducted to investigate the effect of other parameters that may influence temperature profiles along the embedment depth of the anchor under ISO 834 fire [23] conditions. For the parametric study, material properties and specimen dimensions were identical to those used for the validation. For maximum influence of the boundary conditions of the ISO 834 fire, all studied parameters were conducted on anchors with configuration 1 in Fig. 6.

4.1 Extended part of the anchor

To assess the influence of the extended length of the anchor outside the concrete on the temperature distribution of bonded anchors under ISO 834 fire conditions [23], the proposed model was used to conduct simulations for multiple extended lengths (from no extended length to 15 diameters of extended length from concrete surface) for M8 and M12 diameters.

First, a series of simulations was conducted on an embedment depth of $h_{ef}=10*d$. Radiative and convective fluxes were applied on all the surfaces of the extended length. Results are shown in Fig. 15 for M8 and M12 diameters. The extended length of the anchor demonstrated a significant influence on temperature profiles from 0 mm (no extended length modelled, i.e. the steel of the anchor is flush with the concrete surface) to 20 mm for both diameters, then negligible influence beyond 20 mm. When modelling the steel of the anchor flush with the concrete surface, a reduction in temperature profiles was obtained, especially near the exposed part of the at the concrete surface. This could be attributed to the fact that the deeper embedded parts of the anchor are subjected to conduction with concrete, whereas embedded segments near the exposed surface are influenced by the absence of the extended length, which is subjected to radiation and convection from the ISO 834 fire [23].

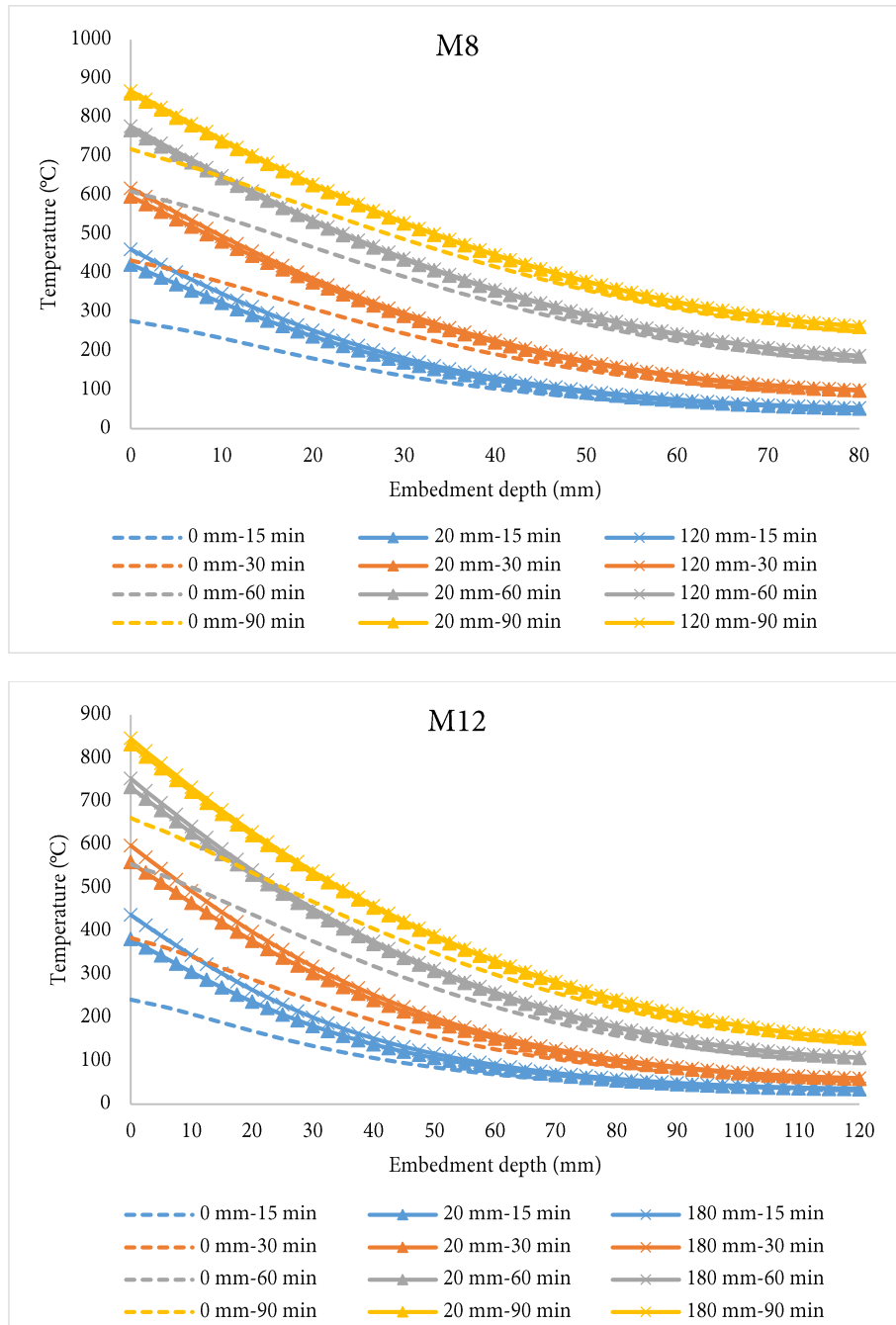

Fig. 15: Temperature profiles for M8 and M12 anchors with $h_{ef}=10*d$ for different extended lengths

4.2 Embedded depth of anchors (h_{ef})

To assess the influence of the embedment depth on the temperature profiles, simulations on anchors with embedment depths of $4*d$, $10*d$, and $20*d$ were conducted for M8 and M12 anchor diameters. An extended length outside the concrete of $10*d$ was chosen for both diameters. Dimensions for the concrete beam were the same as used for the validation. Fig. 16 shows temperature profiles for M8 and M12 anchors, respectively, for the studied embedment depths. At any given time of observation, temperatures near the exposed surface of the anchor were consistent between the three different embedment depths. However, significant temperature differences were observed between the $4*d$ specimen and deeper specimens at the same location inside the concrete, with the maximum difference at the end of the $4*d$ embedment. Higher temperatures were observed for shorter embedment depths within the concrete. For embedment depths between $10*d$ and $20*d$, difference in temperature were insignificant at the same measurement locations. The significant differences between $4*d$ and deeper embedments at the same location within concrete may be attributed to the lower quantity of steel, where smaller thermal bridges are created and heat transfer between steel and concrete is lower. In addition, for shorter anchors there is a smaller

exchange surface between steel and concrete, leading to less thermal interaction between both materials and, therefore, higher temperatures.

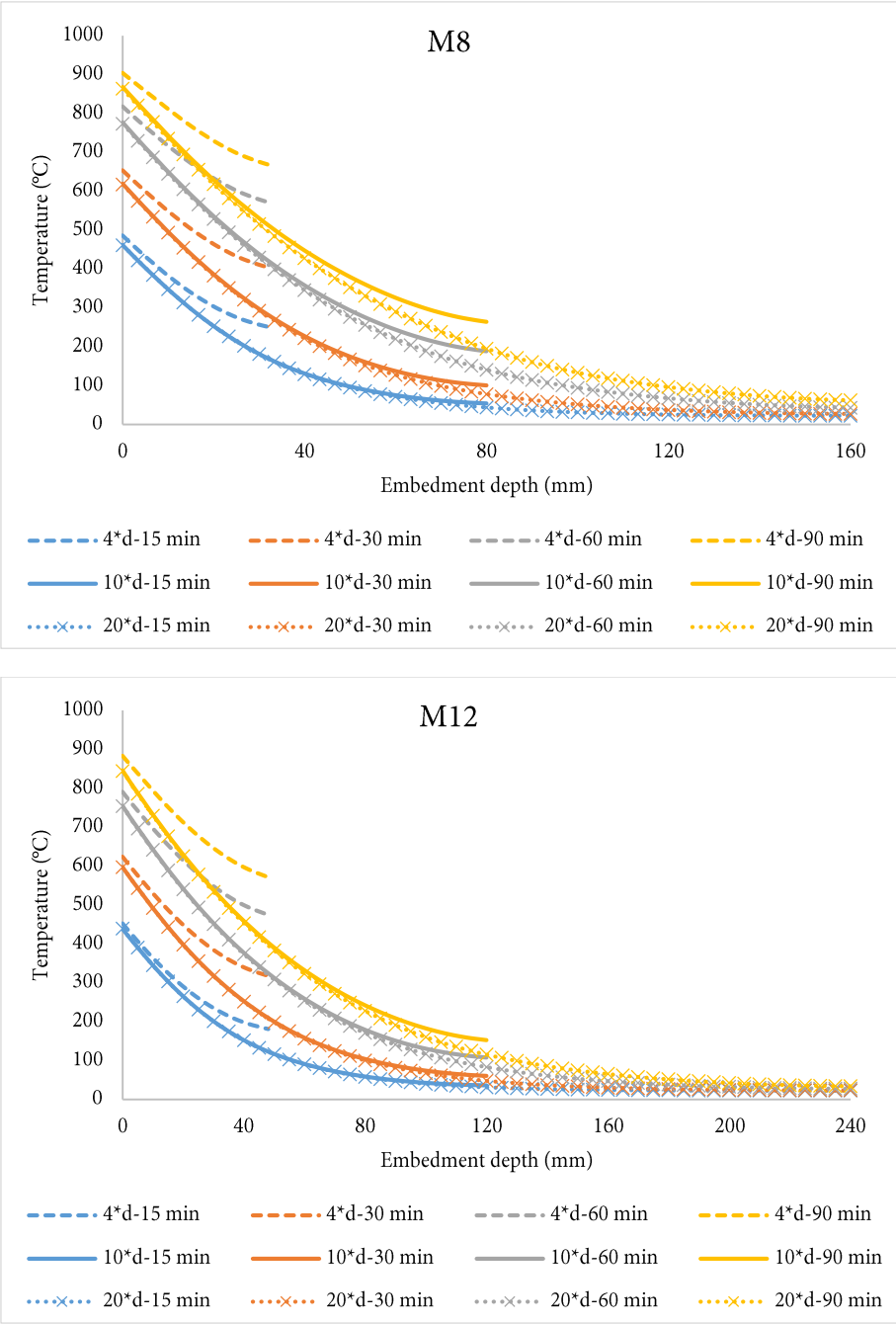

Fig. 16: Temperature profiles for M8 and M12 anchors with extended length of 10*d for different embedment depths

4.3 Concrete element insulation

To assess the influence of insulating the side surfaces of the concrete element, simulations on beams exposed to a radiative and convective flux of ambient air (20°C) on lateral sides were conducted. Results were compared to anchors in beams insulated on the lateral sides. Studied anchors are M8 and M12 anchors with embedded and extended lengths of 10*d. As with all other experiments, beam dimensions were 1500 mm length by 300 mm depth, but the width was reduced to 90 mm, resulting in approximately 40 mm cover on both sides for stronger influence. Fig. 17 shows that temperature profiles for insulated beams vs. exposed beams were nearly identical up to 30 min. Beyond 60 min, small differences were observed with the same initial conditions, wider beams will be less influenced by the existence/absence of insulation on the lateral sides of the beam.

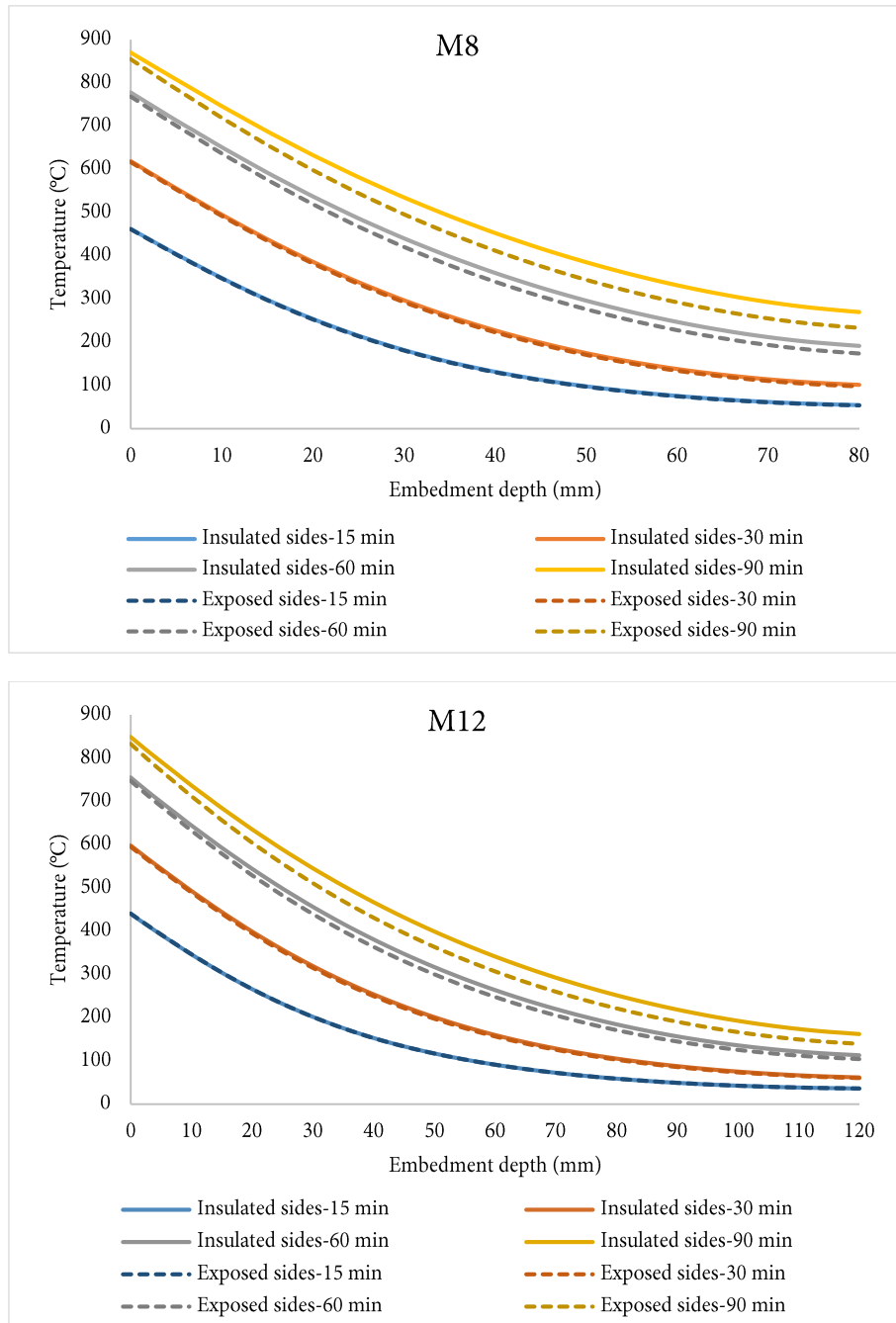

Fig. 17: Temperature profiles for M8 and M12 anchors in insulated beams and beams exposed to ambient air on all sides

5. Conclusions

This paper presents validation and parametric study of a numerical model for calculating the load-bearing capacity of bonded anchors in uncracked concrete under ISO 834 fire conditions [23]. The model employs 3D transient heat transfer equations to obtain temperature profiles along the embedment depth of anchors without considering the properties of the bonding material. The temperature profiles then serve as input for the bond Resistance Integration Method, in which bond strength contributions of discrete segments along the embedment depth of anchors is computed during fire exposure. In this study, the model was validated with experimental results obtained in a previous experimental study [24] resulting in conservative calculations of load-bearing capacities at various fire exposure times compared to experimental results.

Results of common assumptions for the modelling and design of bonded anchors with 2D transient heat transfer analysis based on Cartesian coordinates were compared with the proposed 3D model. 3D heat transfer analysis demonstrated better agreement with experimental results than 2D analysis results, resulting in the following conclusions:

-
- 2D analysis yields a rather a large margin of safety for the load-bearing capacity of anchors directly exposed to fire.
 - 2D analysis may yield unsafe predictions for anchors with insulated fixtures.
 - 2D analysis does not account for the extended part of the anchor in the modelling procedure (with applied radiation and convection on the extended part). This can lead to a significant reduction in temperature profiles near the fire exposed surface.

A parametric study was also presented after experimental validation of the model. This study investigated variables that may influence thermal evaluation of bonded anchors under fire conditions to produce temperature profiles, resulting in the following conclusions:

- Insulated fixtures significantly reduce the temperature profile of anchors exposed to fire conditions compared to uninsulated fixtures, which may lead to misrepresentations of product capacity assessed in accordance with TR 020.
- The length of the anchor extended outside the concrete surface has a significant influence on temperature profiles between no extended length and 20 mm of extended length. Beyond 20 mm, the influence is insignificant.
- The embedded depth of the anchor has an influence on temperature profiles up to $h_{ef}=10*d$. Beyond $h_{ef}=10*d$ of embedment depth the influence is insignificant.
- The insulation of the concrete bearing element's lateral sides has no significant influence on load prediction.

This parametric study establishes a basis for variables to be considered in guidelines for the evaluation of bonded anchors under fire conditions. Additional physical and analytical experimentation are recommended for further validation of the proposed method.

Acknowledgements

The research presented in this paper was conducted at CSTB (Centre Scientifique et Technique du Bâtiment). The authors would like to acknowledge the funding provided by Hilti corporation. The authors would also like to acknowledge Eng. Paul Lardet, Dr. Yahia Msaad, Dr. Seddik Sakji, Dr. Mhd Amine Lahouar, Dr. El Mehdi Koutaiba and the staff of the fire resistance laboratory of Mr. Romuald Avenel and Mr. Stéphane Charuel at CSTB for their contribution to this work.

References

- [1] Cook R. Behavior of chemically bonded anchors. *J Struct Eng.* 1993;119(9):2744–62.
- [2] Kumar S. Analysis of tabular adhesive joints with a functionally modulus graded bondline subjected to axial loads. *Int J Adhes Adhes* 2009;29:785–95.
- [3] ACI Committee 318, " Building Code Requirements for Structural Concrete (ACI 318-11) and Commentary, " American Concrete Institute, Farmington Hills, MI, 2011, 503 pp. 2.
- [4] Eligehausen R, Werner F. Recent developments and open problems in fastening technique. In: 2nd international symposium on connections between steel and concrete, Stuttgart, FIB, Germany; 2007.
- [5] Petit J, Nassiet V, Baziard YH-RB. Etude de la durabilité des assemblages collés. *Techniques de l'ingénieur;* 2005. p. COR160.
- [6] Zhang Y, Lou G, Chen K, Li G. Residual strength of organic anchorage adhesive for post-installed rebar at elevated temperatures and after heating. *Fire Technol J* 2016;52:877–95.
- [7] Muciaccia, G., Navarrete, D.D., Pinoteau, N., Mege, R. Effects of different test apparatus and heating procedures on the bond properties of post-installed rebar connections under elevated temperatures. *Mater Struct* (2019) 52: 47.
- [8] Reis J. Effect of temperature on the mechanical properties of polymer mortars. *Mater Res* 2012;15(4):645–9.
- [9] EN 1993-1-2. Eurocode 3: Design of steel structures – Part 1-2: General rules – Structural fire design. November 2005.
- [10] EN 1992-1-2. Eurocode 2: Design of concrete structures – Part 1-2: General rules – Structural fire design. July 2008.
- [11] ACI 318-14, "Building code requirements for reinforced concrete" Detroit, Michigan: American Concrete Institute, 2014.
- [12] Sorathia U, Lyon R, Gann R, Gritz L. Materials and fire threat. *Fire Technol J* 1997;33(3):260–75.
- [13] Ribeiro MCS, Nóvoa PJRO, Ferreira AJM, Marques AT. Flexural performance of polyester and epoxy polymer mortars under severe thermal conditions. *Cem Compos* 2004;26:803–9.
- [14] Frigione M, Aiello M, Naddeo C. Water effects on the bond strength of concrete/ concrete adhesive joints. *Constr Build Mater* 2006;20:957–70.
- [15] Pinoteau N, Pimienta P, Guillet T, Rivillon R, Remond S. Effect of heat on the adhesion between post-installed bars and concrete using polymeric mortars. In Cairns JW, Metelli G, Plizzari GA, editors. *Bond in Concrete 2012 - Bond in New Materials and under Severe Conditions*; 2012; Brescia. Italy. p. 573-580.
- [16] Lahouar MA, Caron J-F, Pinoteau N, Forêt G, Benzarti K. Mechanical behavior of adhesive anchors under high temperature exposure: experimental investigation. *Int J Adhes Adhes* 2017;78:200–11.
- [17] Adams R, Coppedale J, Mallick V, Al-hamdan H. The effect of temperature on the strength of adhesive joints. *Int J Adhes Adhes* 1992;12(3):185–90.
- [18] Pinoteau N, Heck J, Avenel R, Pimienta P, Guillet T, Remond S. Prediction of failure of a cantilever-wall connection using post-installed rebars under thermal loading. *Eng Struct* 2013;56:1607–19.
- [19] EOTA TR 020. Evaluation of anchorages in concrete concerning resistance to fire. European Organization for Technical Approvals Technical report no. 20. May 2005.
- [20] Eligehausen R, Mallée R, Silva JF. *Anchorage in concrete construction.* Ernst & Sohn; 2006.
- [21] Reichert M, Thiele C. Qualification of bonded anchors in case of fire. Proceedings of the 3rd international symposium on connections between steel and concrete. Stuttgart, Germany. September 2017. p. 1191–9.
- [22] Lakhani H, Hofmann J. A numerical method to evaluate the pull-out strength of bonded anchors under fire. Proceedings of the 3rd international symposium on Connections between Steel and Concrete. Stuttgart, Germany. September 2017. p. 1179–90.

-
- [23] ISO 834-1 International Standard. Fire-resistance tests – Elements of building construction – Part 1: General requirements. First edition, 15 September 1999.
- [24] Al-Mansouri O, Mege R, Pinoteau N, Guillet T, Rémond S. Influence of testing conditions on thermal distribution and resulting load-bearing capacity of bonded anchors under fire. *Eng Struct J* 2019;192:190-204.
- [25] Lahouar MA, Pinoteau N, Caron J-F, Forêt G, Mège R. A nonlinear shear-lag model applied to chemical anchors subjected to a temperature distribution. *Int J Adhe Adhes* 2018;84:438–50.
- [26] Lahouar MA, Pinoteau N, Caron J-F, Forêt, Rivillon Ph. Fire design of post-installed rebars: full-scale validation test on a $2.94 \times 2 \times 0.15$ m³ concrete slab subjected to ISO 834–1 fire. *Eng Struct J* 2018;174:81–94.
- [27] Lakhani H, Hofmann J. On the pull-out capacity of post-installed bonded anchors and rebars during fire. *Proceedings of the 10th International Conference on Structures in Fire*. Belfast, UK. June 2018. p. 165-71.
- [28] Muciaccia, G., Consiglio, A., & Rosati, G. (2016). Behavior and design of post installed rebar connections under temperature. *Key Engineering Materials*, 711, 783-790.
- [29] Lahouar MA, Pinoteau N, Caron J-F, Forêt G, Guillet T, Mège R. Chemically-bonded post-installed steel rebars in a full scale slab-wall connection subjected to the standard fire (ISO 834-1). *Proceedings of the 3rd international symposium on connections between steel and concrete*. Stuttgart, Germany. September 2017. p. 1119–30.
- [30] Tian K, Ožbolt J, Sharma A, Hofmann J. Experimental study on concrete edge failure of single headed stud anchors after fire exposure. *Fire Safety J* 2018;96:176-88.
- [31] Bosnjak J, Sharma A, Ožbolt J. Modelling bond between reinforcement and concrete after exposure to fire. In: *5th International Conference on Computational Modeling of Fracture and Failure of Materials and Structures*. Nantes, France.
- [32] Halvička V, Lublőy É. Concrete cone failure of bonded anchors in thermally damaged concrete. *Construction Build. Mater. J* 2018;171:588-97.
- [33] EOTA. EAD 330087-00-0601. Systems for post-installed rebar connections with mortar. no. EOTA14-33-0087-06.01. July 2015.