



HAL
open science

Energy Management Strategy Based on a New Adaptive Filtering Algorithm for Battery-Ultracapacitor Electric Vehicles

Bakou Traoré, Moustapha Doumiati, Cristina Morel, Jean-Christophe Olivier,
Ousmane Soumaoro

► **To cite this version:**

Bakou Traoré, Moustapha Doumiati, Cristina Morel, Jean-Christophe Olivier, Ousmane Soumaoro. Energy Management Strategy Based on a New Adaptive Filtering Algorithm for Battery-Ultracapacitor Electric Vehicles. 15th IEEE Conference on Industrial Electronics and Applications, Nov 2020, Kristiansand, Norway. pp.392-396, 10.1109/ICIEA48937.2020.9248112 . hal-02473858

HAL Id: hal-02473858

<https://hal.science/hal-02473858>

Submitted on 31 Jan 2024

HAL is a multi-disciplinary open access archive for the deposit and dissemination of scientific research documents, whether they are published or not. The documents may come from teaching and research institutions in France or abroad, or from public or private research centers.

L'archive ouverte pluridisciplinaire **HAL**, est destinée au dépôt et à la diffusion de documents scientifiques de niveau recherche, publiés ou non, émanant des établissements d'enseignement et de recherche français ou étrangers, des laboratoires publics ou privés.

Energy Management Strategy Based on a New Adaptive Filtering Algorithm for Battery-Ultracapacitor Electric Vehicles

Bakou Traoré
Université de Nantes
IREENA Lab EA4642
10 Bd Jean Jeanneteau, Angers, France
bakou.traore@etu-univ-nantes.fr

Moustapha Doumiati
ESEO High School of Engineering
IREENA Lab EA 4642
10 Bd Jean Jeanneteau, Angers, France
moustapha.doumiati@eseo.fr

Cristina Morel
ESEO High School of Engineering
10 Bd Jean Jeanneteau, Angers, France
cristina.morel@eseo.fr

Jean-Christophe Olivier
Université de Nantes, IREENA Lab EA 4642
37 Bd de l'Université, Saint Nazaire, France
jean-christophe.olivier@univ-nantes.fr

Ousmane Soumaoro
National School of Engineering (ENI-ABT)
410, Av. Vollenhoven, Bamako, Mali
samou_soumaoro@yahoo.com

Abstract—This paper presents an energy management algorithm based on a new adaptive filtering method for a multi-sources battery-ultracapacitor electric vehicle. Compared to literature where most of the filtering techniques are developed based on empirical knowledge of the system, the proposed adaptation method is performed online to optimize a cost function that considers the state of charge of the ultracapacitor. The developed approach allows a better power sharing between both electric sources while respecting their constraints and physical limitations. Simulations on Matlab/Simulink validate the performances of the proposed method.

Index Terms—Electric vehicle, Energy management strategy, Ultracapacitor, Battery, Adaptive filtering.

I. INTRODUCTION

The transport sector is witnessing the gradual integration of electric vehicles in recent years. Electric vehicles have the advantage of not emitting atmospheric pollutants in operation, but are however disadvantaged on the autonomy side, because of the batteries limitations [1].

To improve the autonomy of the vehicle, preserve the battery life time and reduce the system weight, sources like the UltraCapacitor (UC) or the fuel cell could be added [2]. However, a multi-sources system can only be effective if it is controlled by an Energy Management Strategy (EMS) that coordinates the power splitting between sources taking their characteristics and limitations into account. The main goal of EMS is essentially to coordinate the power flows between the sources and the load so as to improve the system global efficiency. The used power sources are usually of different natures and the EMS must implement strategies that aim not only to take advantage of each source but also to extend their lifetime as much as possible.

EMS using fixed frequency filtering represents simple method of spectral distribution of energy between energy sources to protect those with low internal dynamics such as the battery

or the Fuel Cell (FC). Unlike the methods using the optimal control and the dynamic programming which need to know in advance the entire load profile, the frequency approach has the advantage to achieve a real-time optimization; it has been applied for a Battery-UC system [3], a FC-Battery system [4], and FC-Battery-UC hybrid power systems [5], [6]. However, this technique has the disadvantage of not respecting the constraints on the State Of Charge (SOC) of the auxiliary storage system [3], [7]. Thus, to solve this problem, strategies using adaptive filtering have been developed. Unlike the fixed frequency method, the adaptive filtering approach adjusts the filter frequency depending on the UC state of charge.

In the literature, adaptive filtering techniques differ mainly by frequency update method. For example, a look-up table is used in [3] while a fuzzy controller is used in [7]. These techniques are mostly based on empirical knowledge of the system. Consequently, some arbitrary tunings are made and the resulted online frequency adjustment is not necessarily optimized.

This paper presents an EMS based on a new adaptive filtering method. In this method, the frequency adjustment is performed online in order to optimize a cost function related to the UC state of charge. It is supposed that the power sharing control system is organized hierarchically into two levels (see Fig.1) as in [8] [9]: the high level also called supervision layer and the low level. The EMS is implemented by the supervision layer that determines the reference powers for the different power sources, and imposes them to the system using a sub-layer (low level) based on power converter controllers. This paper mainly focuses on the development of the EMS supervision layer.

In what follows, first the description of the studied system is presented, then the developed EMS is introduced followed by the results of the simulations with some discussions and

conclusion.

II. DESCRIPTION OF THE ENERGY CHAIN

As shown in Fig.1, the studied system is a vehicle with electric motorization powered via the DC bus by two sources: a battery and a pack of UC. The battery is considered as the main source of energy and the UC as the auxiliary one. Each source is connected to the DC bus via a reversible controlled power converter.

A. Powertrain

Consisting essentially of the wheels, the speed reducer, the electric motor and its power converter, the powertrain must provide the required mechanical power for the movement of the vehicle according to the instructions imposed by the driver. In order to fulfill this role, it must be properly supplied with electrical energy by the energy sources. This necessarily involves an instantaneous estimation of the reference power taking into account the constituent elements of the vehicle and the driving environment. The required power to supply the powertrain of an electric vehicle of mass M , and of frontal surface S evolving at a speed v is given by (1):

$$P_{pt} = \frac{v}{\eta_{pt}} \left[\frac{1}{2} \rho_a S C_x v^2 + M g \mu \cos(\alpha) + M g \sin(\alpha) + M \frac{dv}{dt} \right] \quad (1)$$

where α , ρ_a , v_a , C_x , μ and η_{pt} are respectively, the slope of the road, the air density, the wind speed, the vehicle aerodynamic coefficient, the rolling coefficient, the gravitational acceleration, and the efficiency of the powertrain. The values of P_{pt} on a driving cycle constitute the power profile. In this work, the power profiles shown in Fig. 2 and 3 corresponding to the NEDC (New European Driving Cycle) and the IFSTTAR (Institut Français des Sciences et Technologies des Transports, de l'Aménagement et des Réseaux) are used. They represent urban driving cycles with regular braking and accelerations.

B. The battery

The battery is a complex electrochemical system. In the literature, different approaches are used to model its behavior according to the desired objective [10] and [11]. In this work, a simple electrical model of the lithium-ion battery is used. This model consists of the association of a voltage source V_{bat} in series with the internal resistance R_{bat} (see Fig.1).

C. Ultracapacitor

The UC uses the formation of an electrochemical double layers at the electrodes - electrolyte interfaces to store energy [12]. Because of its ability to provide/absorb important instantaneous powers, UC is used as auxiliary source to assist sources of low internal dynamic like battery. Among the existing models in literature to describe the UC dynamic behavior, there are in particular the distributed constant model, the localized constant model and the behavioral model with two branches [12], [13]. The model used in this work consists of the association of a capacitance C_{uc} in series with resistance

R_{uc} (see Fig.1). Its state of charge SOC_{uc} is determined at each time t by :

$$\begin{cases} SOC_{uc}(\%) = 100(E_{uc} - E_{ucmin}) / (E_{ucmax} - E_{ucmin}) \\ E_{uc} = E_{uc0} - \int_0^t P_{uc}(\tau) \cdot \eta_{uc}^{-p} \cdot d\tau \\ E_{uc0} = \frac{1}{2} \cdot C_{uc} \cdot V_{uc0}^2 \end{cases} \quad (2)$$

where: η_{uc} , P_{uc} are respectively the efficiency and the power supplied or absorbed by the UC, p is the P_{uc} sign, E_{uc0} is the UC initial energy, V_{uc0} is the UC initial open circuit voltage, E_{ucmin} and E_{ucmax} are respectively the UC minimum and maximum energy.

III. ENERGY MANAGEMENT STRATEGY

The EMS in a multi-sources system must ensure a good distribution of the power P_{pt} requested by the powertrain between the energy sources while respecting the constraints and limits of each source in terms of power, power dynamics and UC state of charge. The battery is considered as the main source, and thus, it is supposed to be adequately charged. In the studied system, at each sampling k of period T_s , the constraints can be summarized as follows:

$$\begin{cases} P_{pt}(k) = P_{bat}(k) + P_{uc}(k) \\ P_{batmin} \leq P_{bat}(k) \leq P_{batmax} \\ P_{ucmin} \leq P_{uc}(k) \leq P_{ucmax} \\ SOC_{ucmin} \leq SOC_{uc}(k) \leq SOC_{ucmax} \end{cases} \quad (3)$$

where P_{bat} and P_{uc} represent the power supplied by the battery and the UC, respectively.

As shown in Figure 4, the energy management method developed here is based on filtering. The filtering frequency is determined online in order to optimize a cost function. The cost to be optimized here is the SOC of the UC which must be maintained in a certain range. This is necessary to ensure that the UC will continue to assist the battery for peak power demands. To realize the algorithm that will perform the desired task for each sampling, the first order low-pass filter is discretized.

A. Discrete model of the low-pass filter

As it is shown in Fig. 4, a first order low-pass filter is used to smooth the battery power reference. The relation between the filter input P_{pt} and output P_{bat} in the frequency domain is given by :

$$P_{bat} = \frac{\omega_c}{s + \omega_c} \cdot P_{pt}, \quad (4)$$

where ω_c (rad/s) is the filter cutoff frequency. In the time domain, equation (4) becomes :

$$\dot{P}_{bat} + \omega_c P_{bat} = \omega_c P_{pt}. \quad (5)$$

Taking account of the initial conditions, the solution of the first-order differential equation (5) is given by :

$$P_{bat}(t) = e^{-\omega_c t} (P_{bat}(0) + \int_0^t \omega_c P_{pt}(\tau) e^{-\omega_c \tau} d\tau), \quad (6)$$

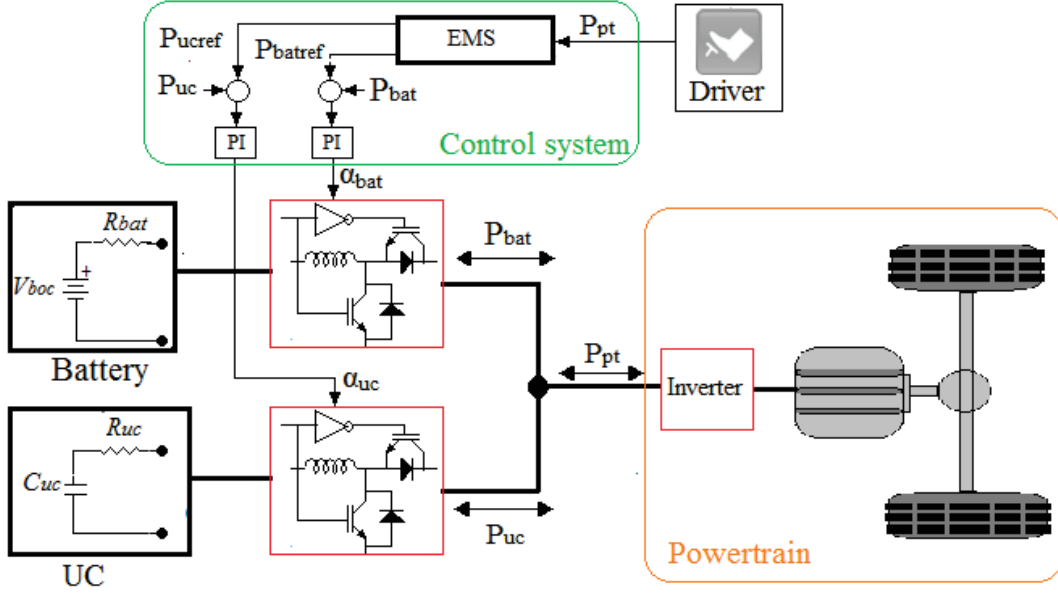

Fig. 1. System architecture.

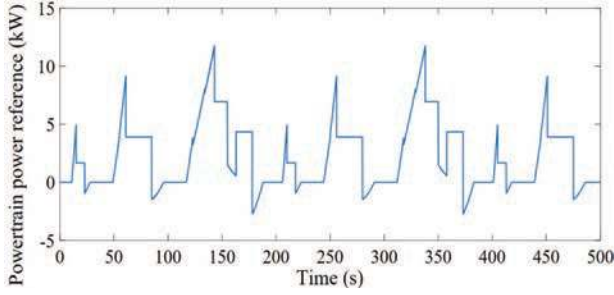

Fig. 2. NEDC power profile

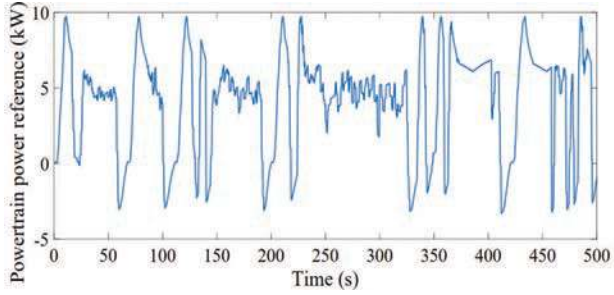

Fig. 3. IFSTTAR power profile

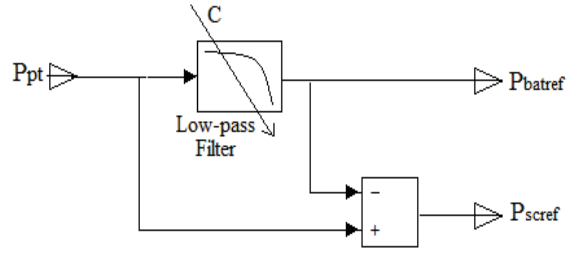

Fig. 4. Principle of the adaptive filtering

samplings $k - 1$ and k .

B. Energy management algorithm

At each instant k , the power requested by the powertrain is sent to the low-pass filter which determines the reference power of the battery P_{bat} for different values of $\omega_c \in [0, \omega_{cmax}]$ with a frequency step $\delta\omega_c$ using the filter discrete model (8):

$$P_{bat}(k, \omega_c) = P_{pt}(k) + (P_{bat}(k-1) - P_{pt}(k))e^{-\omega_c \cdot T_s}, \quad (8)$$

where ω_{cmax} represents the maximum value of ω_c . It can be determined objectively by $\omega_{cmax} = 2\pi f_s$ with f_s , the battery specific frequency defined as the ratio of its specific power to its specific energy [7].

Taking account the constraints defined in (3), the UC power reference is determined by (9):

$$P_{uc}(k, \omega_c) = P_{pt}(k) - P_{bat}(k, \omega_c). \quad (9)$$

where $P_{bat}(0)$ is P_{bat} initial value.

In discrete time, by a recurrent calculation, the relation (6) becomes:

$$P_{bat}(k) = P_{pt}(k) + (P_{bat}(k-1) - P_{pt}(k))e^{-\omega_c \cdot T_s}. \quad (7)$$

This last equation represents the first-order low-pass filter of cutoff frequency ω_c model and discretized between two

The optimal frequency ω_{cOpt} is determined in the interval $[0, \omega_{cmax}]$, at each sampling so as to minimize a cost function C which takes into account the state of charge of the UC:

$$C(k, \omega_c) = |SOC_{ucref} - SOC_{uc}(k, \omega_c)| \quad (10)$$

where SOC_{ucref} is the reference value of the UC state of charge.

The minimum cost C_{min} , the corresponding optimal frequency, and the sources power reference are thus determined by:

$$\begin{cases} C_{min}(k) = \min(C(k, \omega_c)), \omega_c \in [0, \omega_{cmax}] \\ \omega_{cOpt}(k) = \operatorname{argmin}_{\omega_c} C(k, \omega_c) \\ P_{batref}(k) = P_{bat}(k, \omega_{cOpt}) \\ P_{ucref}(k) = P_{uc}(k, \omega_{cOpt}) \end{cases} \quad (11)$$

P_{batref} and P_{ucref} correspond to the reference powers of the battery and the UC which minimize the cost C between two samplings ($k - 1$ and k). Note that the developed adaptive filtering algorithm requires low computing time, and thus, it is therefore suitable for real-time implementation.

IV. SIMULATION RESULTS

Matlab simulations of the developed algorithm were performed for NEDC and IFSTARR power profiles given in Section II. Recall that ω_{cmax} depends essentially on the characteristics of the battery and the objectives of the energy management strategy. Generally, it is chosen as low as possible for a better protection of the battery from strong power dynamics. The performance of the developed algorithm are tested with $\omega_{cmax} = 0.31 \text{ rad/s}$ obtained as explained in (III-B). The initial and the reference states of charge of the UC are set to 50%.

Fig. 5 and 6 show the battery and the UC power references determined by the developed adaptive filtering algorithm for the NEDC and IFSTARR driving cycles, respectively. For each case, it can be noticed that due to the filtering effect, the dynamic power is provided by the UC while battery supplies the mean power.

The corresponding evolutions of the UC state of charge are shown in Fig.7. It can be noticed that the SOC of the UC never reaches its extreme values and returns at the end of the cycle to approximately less than +10% from the reference SOC. Indeed, the final SOC of the UC are 59.5% and 55% for the NEDC and IFSTARR driving cycles, respectively. Fig. 8 and 9 show how the frequency ω_{cOpt} varies over the IFSTARR and NEDC driving cycles. As expected, it varies between 0 and ω_{cmax} according to the UC state of charge.

The developed energy management algorithm is compared to the classic passive filtering EMS with constant frequency. Fig. 10 shows the evolution of the UC's SOC for the classic filtering for the two driving cycles with $\omega_c = \omega_{cmax} = 0.31 \text{ rad/s}$. It can be noticed that the final SOC deviates much from the reference SOC and even reaches its lower limit for the IFSTARR driving cycle. From these simulations, it can be deduced that the developed adaptive algorithm gives better

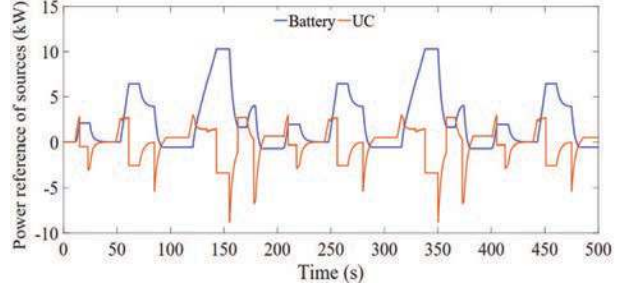

Fig. 5. Power reference of sources with adaptive filtering EMS for NEDC driving cycle.

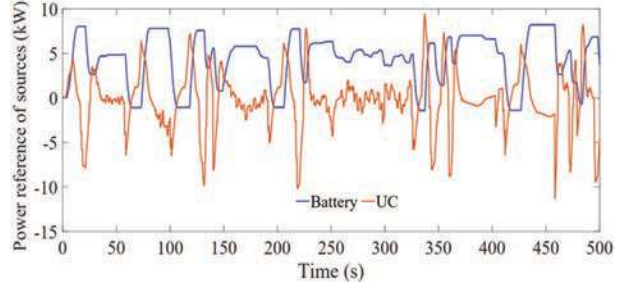

Fig. 6. Power reference of sources with adaptive filtering EMS for IFSTARR driving cycle.

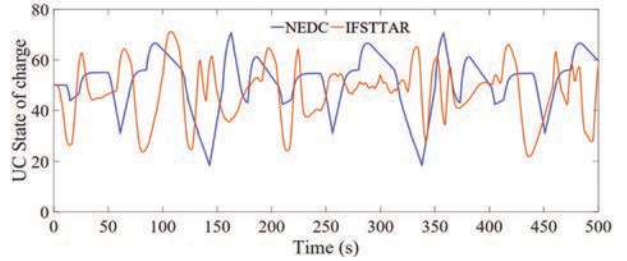

Fig. 7. UC State of charge with adaptive filtering EMS for NEDC and IFSTARR driving cycles.

results than the passive filtering while considering constraints on the UC's SOC.

The proposed adaptive EMS was also simulated with different initial UC state of charge values Soc_{uc0} to analyze its behavior regarding initial condition. Fig.11 and 12 show the evolution of UC state of charge for $Soc_{uc0} = 90\%$ and $Soc_{uc0} = 25\%$ for the two considered power profiles. It can be noticed that for each case, throughout the driving cycle, the algorithm tends to bring back the UC state of charge to its desired or reference value SOC_{ucref} which is set to 50%. Thus, the final UC state of charge values are very close to SOC_{ucref} . This behavior is very important as it ensures that, regardless of the driving cycle and of the initial UC state of charge, the UC will continue to assist the battery by providing the peak power with a good regulation of its state of charge.

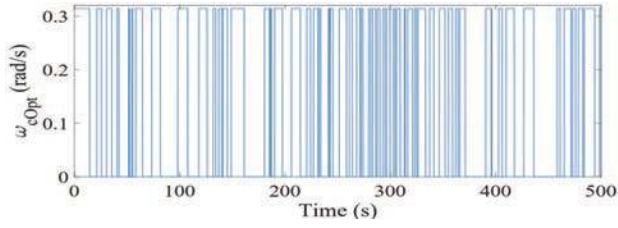

Fig. 8. The frequency ω_{cOpt} for IFSTTAR driving cycle.

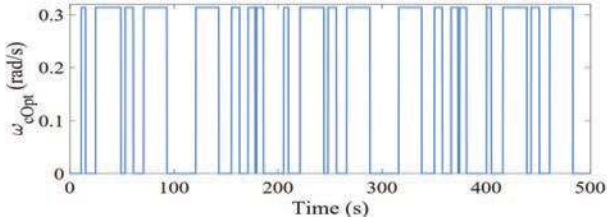

Fig. 9. The frequency ω_{cOpt} for NEDC driving cycle.

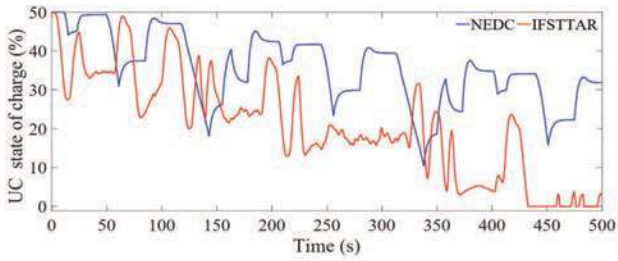

Fig. 10. UC State of charge with classic filtering EMS for NEDC and IFSTTAR driving cycles.

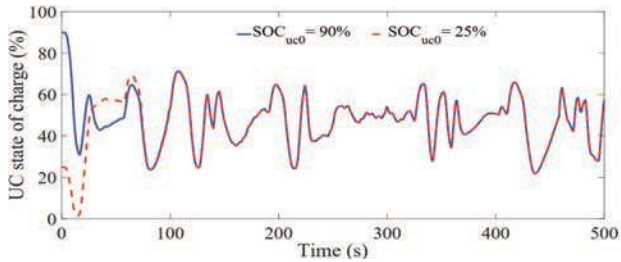

Fig. 11. UC State of charge evolution with the adaptive EMS for IFSTTAR power profile with different values of the initial UC state of charge SOC_{uc0}

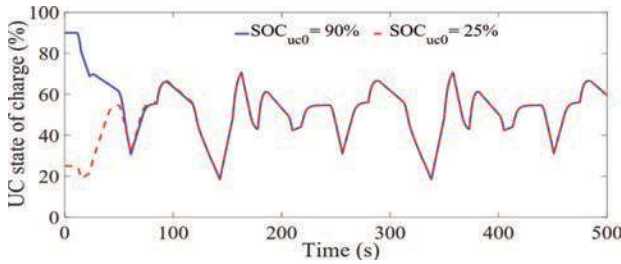

Fig. 12. UC State of charge evolution with the adaptive EMS for NEDC power profile with different values of the initial UC state of charge SOC_{uc0}

V. CONCLUSION

This paper presents a new adaptive filtering EMS for a battery-UC electric vehicle. Simulations with different power profiles and different state of charge scenarios, confirm that the developed EMS ensures UC's State of charge regulation while ensuring a pertinent frequency distribution of the power profile spectral between the battery and the UC. Indeed, in all cases, the low dynamic power demands are provided by the battery, while the peaks power are given by the UC.

The proposed adaptive filtering method is simple, low computational cost, and does not require empirical knowledge nor model-based controller development to adapt the filter frequency. Depending on the characteristics of the used battery, only the value of ω_{cmax} must be set to apply the proposed method to the multi-sources electric system.

For future works, the improvement of the developed EMS with consideration of the system global efficiency while minimizing electrical losses will be our main topics.

REFERENCES

- [1] M. A. Hannan, M. M. Hoque, A. Hussein, Y. Yusof, and P. J. Ker, "State-of-the-art and energy management system of lithium-ion batteries in electric vehicle applications: Issues and recommendations," *IEEE Access*, vol. 6, pp. 19362–19378, 2018.
- [2] B. Bendjedja, H. Alloui, N. Rizoug, F. Bouchafaa, and M. Benbouzid, "Sizing and energy management strategy for hybrid fc/battery electric vehicle," *Proceedings of the IECON 2016-42nd Annual Conference of the IEEE Industrial Electronics Society, Florence, Italy*, pp. 2111–2116, 2016.
- [3] A. Florescu, I. Munteanu, A. I. Bratcu, and S. Bacha, "Frequency-separation-based energy management control strategy of power flows within electric vehicles using ultracapacitors," *IECON2012-38th Annual Conference of the IEEE Industrial Electronics Society, Montréal, Canada*, pp. 2957–2964, 2012.
- [4] H. Alloui, K. Marouani, M. Becherif, M. N. Sid, and M. Ben, "A control strategy scheme for fuel cell-vehicle based on frequency separation," *IEEE ICGE, Tunisia*, pp. 170–175, 2014.
- [5] W. Nwesaty, A. I. Bratcu, and O. Senane, "Lpv control for power source coordination application to electric vehicles energy management systems," *ECC2014*, 2014.
- [6] B. Traoré, M. Doumiati, C. Morel, O. Soumaoro, and J. C. Olivier, "Energy management strategy design based on frequency separation, fuzzy logic and lyapunov control for multi-sources electric vehicles," *IECON 2019 - 45th Annual Conference of the IEEE Industrial Electronics Society, Lisbon, Portugal*, pp. 2676–2681.
- [7] J. Snoussi, S. B. Elghali, M. Benbouzid, and M. F. Mimouni, "Auto-adaptive filtering-based energy management strategy for fuel cell hybrid electric vehicles," *Energy*, 2018.
- [8] Z. Song, J. Hou, H. Hofmann, J. Ly, and M. Ouyang, "Sliding-mode and lyapunov function-based control for battery/ supercapacitor hybrid energy storage system used in electric vehicles," *Energy*, pp. 601–612, 2017.
- [9] S. B. Siad, "Dc microgrids control for renewable energy integration sabah," *PhD Thesis, Université d'Évry-Val d'Essonne, France*, 2019.
- [10] S. M. M. G. and N. Nikdel, "Various battery models for various simulation studies and applications," *Renewable and Sustainable Energy Reviews*, pp. 477–485, 2014.
- [11] M. Urbain, M. Hinaje, S. Rael, and al, "Energetical modeling of lithium ion batteries including electrode porosity effects," *IEEE Trans. on Energy Conversion, IEEE Trans. On Energy Conversion*, vol. 25, 2010.
- [12] F. Belhachemi, S. Rael, and B. Davat, "A physical based model of power electric double-layer supercapacitors," *IEEE-IAS2000, Rome*, 2000.
- [13] W. Lajnef, J. M. Vinassa, S. Azzopardi, O. Briat, E. Woigard, C. Zardini, and J. L. Accouturier, "Ultracapacitors modeling improvement using an experimental characterization based on step and frequency responses," *IEEE Power Electronics Specialist Conference PESC04, Aachen, Germany*, 2004.