



HAL
open science

Datations OSL, U/Th et¹⁴C croisées de séquences sédimentaires du Pléistocène supérieur et leurs implications morphodynamiques (Oued Noun, sud-ouest de l'Anti-Atlas, 29° N, Maroc)

André Weisrock, Luc Wengler, Julien Mathieu, Abderrahmane Ouammou, Michel Fontugne, Norbert Mercier, Jean-Louis Reyss, Hélène Valladas, Pascale Guery

► To cite this version:

André Weisrock, Luc Wengler, Julien Mathieu, Abderrahmane Ouammou, Michel Fontugne, et al.. Datations OSL, U/Th et¹⁴C croisées de séquences sédimentaires du Pléistocène supérieur et leurs implications morphodynamiques (Oued Noun, sud-ouest de l'Anti-Atlas, 29° N, Maroc). *Quaternaire*, 2006, 17 (1), pp.45-59. 10.4000/quaternaire.645 . hal-02470559

HAL Id: hal-02470559

<https://hal.science/hal-02470559>

Submitted on 26 Oct 2020

HAL is a multi-disciplinary open access archive for the deposit and dissemination of scientific research documents, whether they are published or not. The documents may come from teaching and research institutions in France or abroad, or from public or private research centers.

L'archive ouverte pluridisciplinaire **HAL**, est destinée au dépôt et à la diffusion de documents scientifiques de niveau recherche, publiés ou non, émanant des établissements d'enseignement et de recherche français ou étrangers, des laboratoires publics ou privés.

UPPER PLEISTOCENE COMPARATIVE OSL, U/Th AND ¹⁴C DATINGS OF SEDIMENTARY SEQUENCES AND CORRELATIVE MORPHODYNAMICAL IMPLICATIONS IN THE SOUTH-WESTERN ANTI-ATLAS (OUED NOUN, 29° N, MOROCCO)

■

André WEISROCK¹, Luc WENGLER², Julien MATHIEU¹,
Abderrahmane OUAMMOU³, Michel FONTUGNE⁴, Norbert MERCIER⁴,
Jean-Louis REYSS⁴, Hélène VALLADAS⁴ et Pascale GUERY⁵

ABSTRACT

The lower Oued Noun valley, in the arid region of the Atlantic SW Anti-Atlas, contains an extensive Soltanian (= Upper Pleistocene *pro-parte*) terrace. The paper presents dates for these deposits and an interpretation of their fluvial dynamic and morpho-climatic geneses in this distal part of the valley.

The Soltanian terrace, about 30 m thick at Fort Oued Noun, consists of 3 units: a basal deposit of coarse gravel buried by slope deposits and travertine (Unit 1); a main unit, more than 20 m thick (Unit 2) that consists of at least 7 repeated sequences each comprising basal fine gravels and sands, associated with detrital travertine, overlain by stromatolithic tufa and finally by a thick accumulation of sandy silts. These silts were deposited by suspension and decantation in shallow non-turbulent water bodies. The gravels, sands and travertines are more prominent at the bottom and in the upper parts of Unit 2 whilst silts dominate the mid members. Middle Paleolithic artefacts and bones of large mammals are found throughout this Unit.

Unit 3, at the top of the formation, comprises red silts that differ from those of Unit 2, containing more aeolian grains and more palygorskyte and being spatially associated with adjacent tributaries fans.

Radiometric dates were obtained on travertine (U/Th), on quartz grains extracted from sediments (OSL) and on *Melanopsis* and Charcoal (¹⁴C). U/Th results show three travertine constructions at ca 90, 55-50 and 25-20 ka B.P. The 90 ka dates, however, are not in correct stratigraphic position. The OSL dates suggest that the period of silt aggradation of Unit 2 occurred between ca. 50 and 25 ka B.P., the main part of them being deposited between 40 and 30 ka B.P. ¹⁴C dates from the upper part of Unit 2 and the base of Unit 3, range between ca 28 and 18 ka B.P.

These dates, together with geomorphological and sedimentological analyses, indicate that the valley floor had been lowered to its present depth before ca. 90 ka B.P. However, the slope deposits, older travertines and the basal gravel (Unit 1), classic fluvial and colluvial deposits, are not yet securely dated but they possibly correspond with wetter episodes in O.I.S. stages 5b, 5a and 4, or even later. The silts that form the bulk of Unit 2 were deposited into shallow swamps during biostatic episodes of O.I.S. 3 and were associated with high groundwater levels. Then, large mammals found grass and water along the valley and were hunted by Middle Paleolithic people. The water table remained high after 30 ka B.P. and the gravel-bed channels of the local tributaries were active during the 30-20 ka B.P. period. After ca. 20 ka, sediments suggest more varied conditions in this part of the valley, vegetation disappeared and soils were reworked into local colluvial fans, with concomitant aeolian deposits (Unit 3, O.I.S. 2). Finally, deep linear incision occurred, dissecting the Soltanian aggraded valley floor during the early Holocene.

Key-words: Arid zone, sediment dating, U/Th, OSL, ¹⁴C, carbonates, silts, fluvial, aeolian and lacustrine sedimentation, Upper Pleistocene, Morocco.

RÉSUMÉ

DATATIONS OSL, U/Th ET ¹⁴C CROISÉES DE SÉQUENCES SÉDIMENTAIRES DU PLÉISTOCÈNE SUPÉRIEUR ET LEURS IMPLICATIONS MORPHODYNAMIQUES (OUED NOUN, SUD-OUEST DE L'ANTI-ATLAS, 29° N, MAROC)

La basse vallée de l'oued Noun, aujourd'hui située dans le domaine aride du versant sud de l'Anti-Atlas, montre une terrasse soltanienne (Pléistocène supérieur *pro-parte*) bien développée. Les objectifs de cet article sont de déterminer avec précision les âges des sédiments et de comprendre les changements de la dynamique fluviale, avec ses phases successives d'aggradation et d'érosion, à la fin du Pléistocène supérieur.

La formation soltanienne, épaisse de 30 m à Fort Oued Noun, se compose de 3 unités : un dépôt conglomératique de base surmonté par des dépôts de pente et des travertins (Unité 1) ; un dépôt principal de plus de 20 m (Unité 2), qui consiste en au moins 7 séquences répétitives montrant chacune à la base des petits galets et des sables associés à des travertins détritiques, surmontés de travertins stromatolithiques construits finalement recouverts d'accumulations épaisses de limons. Ces limons ont été déposés par suspension et décantation dans des eaux calmes et peu profondes. Les galets, sables et travertins sont surtout fréquents à la base et au sommet de l'Unité 2, tandis que les limons dominent dans sa partie

¹ Université Nancy2, Département de Géographie, C.E.R.P.A, B.P. 33-97, 54015 Nancy cedex, France. weisrock@univ-nancy2.fr

² Université de Perpignan, UMR 5590 CNRS, Préhistoire et paléoenvironnements quaternaires du Bassin méditerranéen, 52 avenue de Villeneuve, 66860 Perpignan cedex, France

³ Université Ibn Zohr, Faculté des Lettres, Département de Géographie, B.P. 29 S, Agadir, Maroc

⁴ Laboratoire des Sciences du Climat et de l'Environnement, CNRS-CEA, Avenue de la Terrasse, 91198 Gif/Yvette, France

⁵ IAURIF, 15 rue Falguière, 75740 Paris cedex 15, France

moyenne. Dans toute l'Unité 2, on trouve des ossements de grands mammifères et des outillages lithiques du Paléolithique moyen. Au sommet de la formation, des limons rouges supérieurs (Unité 3) diffèrent des précédents et appartiennent à des cônes déposés par les affluents locaux, avec davantage de grains éoliens et de palygorskyte.

Les datations radiométriques ont été obtenues pour des travertins (U/Th), des grains de quartz extraits des sédiments (OSL), des charbons et *Melanopsis* (^{14}C). Les datations U/Th montrent trois périodes de construction de travertins autour de 90, 55-50 et 25-20 ka B.P. Les résultats à 90 ka ne sont toutefois pas en bon accord avec la stratigraphie. D'après les résultats OSL, la période d'aggradation des silts de l'Unité 2 se situe entre environ 50 et 25 ka B.P., la majeure partie de ces silts se déposant entre 40 et 30 ka B.P. Les datations ^{14}C se rangent entre 28 et 18 ka B.P. Elles concernent la partie supérieure de l'Unité 2 et la partie basale de l'Unité 3.

Ces résultats, associés aux observations géomorphologiques et sédimentologiques, montrent que la vallée était déjà creusée autour de 90 ka B.P. Les dépôts de pente, les plus anciens travertins et le dépôt basal graveleux, ayant tous une signature de dépôts colluviaux ou alluviaux classiques, ne sont pas datés avec sûreté ; ils peuvent correspondre à des épisodes humides des stages isotopiques 5b, 5a et 4, mais peuvent aussi être plus récents. Les silts qui forment la masse de l'Unité 2 ne peuvent être reliés uniquement à une activité fluviale et ont été déposés dans des étendues d'eaux calmes liées à une élévation concomitante du niveau des nappes phréatiques durant des épisodes biostasiques du stage isotopique 3. De grands mammifères ont alors pu trouver de l'eau et de l'herbe dans la vallée et être chassés par les hommes du Paléolithique moyen. La nappe phréatique s'est maintenue à un niveau élevé après 30 ka B.P et les chenaux à graviers des affluents locaux sont restés actifs durant la période 30-20 ka B.P. Après cette date, l'instabilité s'est accrue ; dans cette partie de la vallée, la végétation s'est raréfiée, les sols ont été remaniés, édifiant des cônes locaux où s'observent aussi des influences éoliennes (Unité 3, stage isotopique 2). Enfin, une forte incision linéaire s'est produite à l'Holocène inférieur, disséquant l'accumulation soltanienne.

Mots-clefs : Zone aride, datation de sédiments, U/Th, OSL, ^{14}C , carbonates, limons, sédimentation fluviale, éolienne et lacustre, Pléistocène supérieur, Maroc.

1 - INTRODUCTION

Earlier studies of Upper Pleistocene sediments along the northern edge of the Sahara desert focused on the interior eastern valleys (Alimen *et al.*, 1966; Conrad, 1969; Williams, 1970; Littmann & Schmitt, 1989) or on dune coastal areas (Rognon & Coudé-Gaussen, 1987, 1996; Petit-Maire *et al.*, 1987). These studies did not focus exclusively on fluvial morphodynamics, generally did not consider alluvial deposits older than the limit of the ^{14}C method, and came to varying conclusions. For some authors, the 40 - 20 ka period there was more humid than the present, with large flood events, whilst for others, it was on the contrary almost a dry period. More recent studies, in eastern of Morocco (Wengler *et al.*, 1992; Wengler, 1993) or in the Anti-Atlas (Ouammou, 1994; Weisrock *et al.*, 1994; Thorp *et al.*, 2002) suggest whilst conditions during this period may have been generally arid or semi-arid, some phases were more humid before 40 ka, at ca. 30 and perhaps ca. 20 ka B.P. In the coastal areas of southern Morocco and the western Anti-Atlas, these more humid phases were not characterised by erosive catastrophic floods, but by floods of very low energy into shallow valley marshes or lakes dammed by silts and/or by travertine accumulation. However, many published dates are not secure: for example, the ^{14}C dates from *Helix* and *Melanopsis* shells in the Oued Tamdroust (Ouammou, 1994), could not be correlated with the Middle Paleolithic tools found in the sedimentary sequences.

The main foci of this paper are:

1) to securely determine the ages of the large sedimentary accumulations that form a very prominent and extensive "Soltanian" (= Upper Pleistocene *pro-parte*) terrace in the lower part of the Oued Noun valley (= Oued Assaka, Wengler *et al.*, 2002), in the south western Anti-Atlas. This is done for a ca. 30 m thick section near Fort Oued Noun (29°05'46''N; 10°20'24''W). For this, comparisons are made between the results of three dating techniques applied to samples

from the same section: OSL on quartz grains, U/Th on travertine deposits and ^{14}C on charcoal and molluscs.

2) to establish the sequence of fluvial and other morphodynamic processes that are responsible for these unusual thicknesses of deposits in the Soltanian Moroccan terraces, and

3) to compare this fluvial history with other documented fluvial sequences in the Mediterranean basin (Macklin *et al.*, 2002) and with global climatic change records which are available for the surrounding areas of: north-west Africa and the Sahara (Rognon, 1987, 1996), and the North Atlantic Ocean (Bond *et al.*, 1993; Cortijo, 1998).

2 - THE LOWER OUED NOUN VALLEY AND THE PRESENT FLUVIAL SYSTEM (fig. 1)

The Oued Noun drains part of the southwestern Anti-Atlas mountains - the massifs of Kerdous and Ifni, and the western Jebel Bani. Its tributaries focus in the Guelmim basin, join those Oued Seyad and it then passes through the southern end of the Ifni Massif in a narrow incised bedrock gorge of ca. 21 km before exiting into the Atlantic Ocean at Foug Assaka. Whereas the Guelmim Basin above Tiliouine varies from 7 to 21 km in width, the Noun - Assaka gorge is only 360 - 480 m wide although there are several reaches where less resistant bedrock and lateral tributary confluences permit local widening, as at Assaka village and Fort Oued Noun. Numerous short bedrock tributaries enter the gorge reach, but only four drain larger areas of the Ifni hills and mountains to the north and south. Rainfall is less than 150 mm/year over the Guelmim lowlands, but increases to 300 mm/yr in the northern mountain rim and generates only episodic river flows. High magnitude flows throughout the length of the catchment today are very rare and only exceptionally reach this lower part of the valley, when high intensity rainfalls cause floods with large amounts of suspended silty sediments. Such floods occur only when cyclonic

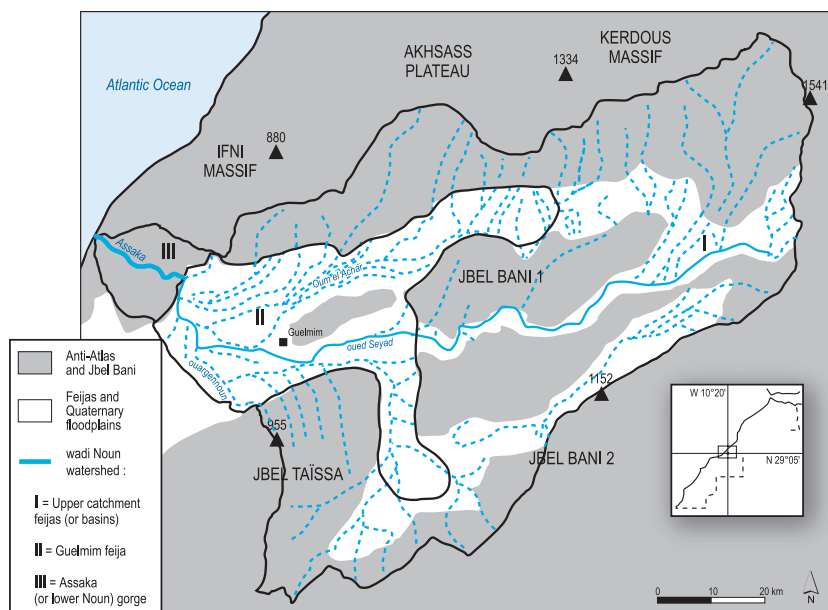

1a : The catchment of wadi Noun/Assaka.

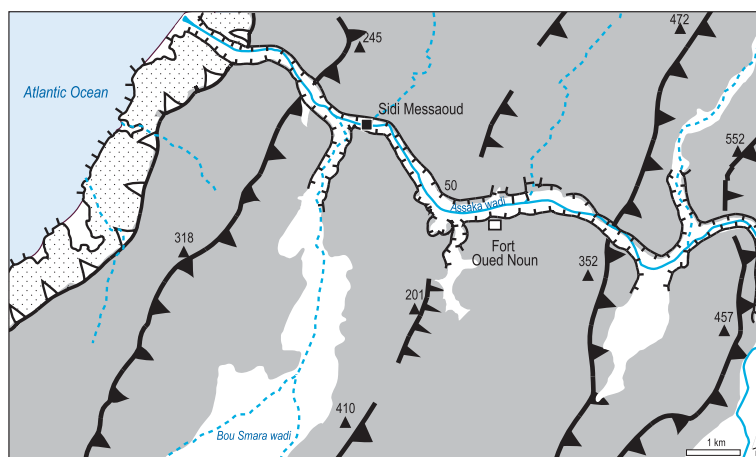

1b : The wadi Noun, or Assaka, stricto sensu, distal part of the fluvial system (after P. Oliva, 1975).

- | | |
|---|--|
| <p>Lithology :</p> <ul style="list-style-type: none"> ■ Cambrian (schists, quartzites, sandstones and limestones) ▨ Moghrebien (calcarenites) □ Quaternary (alluvial and colluvial deposits) | <p>Landforms :</p> <ul style="list-style-type: none"> ▲ Main hogback ⌋ Gorge ⌋ Cliff ⌋ Moghrebien dead cliff |
|---|--|

Fig. 1: Locations.

1a : The catchment of wadi Noun/Assaka.

Legend: 1 : Anti-Atlas and Jbel Bani ; 2 : Feijas and Quaternary floodplains ; 3 : wadi Noun watershed: I = Upper catchment feijas (or basins); II = Guelmim feija; III = Assaka (or lower Noun) gorge.

1b : The wadi Noun, or Assaka, stricto sensu, distal part of the fluvial system (after P. Oliva, 1975).

Legend: Lithology : 1 : Cambrien (schistes, quartzites, grès et calcaires) ; 2 : Moghrébien (calcarénites) ; 3 : Quaternaire (dépôts alluviaux et colluviaux).

Landforms: 4 : Principaux crêts ; 5 : Gorge ; 6 : Falaise ; 7 : Falaise morte moghrébienne.

Fig. 1 : Localisations.

1a : Le bassin versant de l'oued Noun/Assaka.

Légende : 1 : Anti-Atlas et Jbel Bani ; 2 : Feijas et plaines d'inondation quaternaires ; 3 : bassin versant de l'oued Noun : I = Feijas ou bassins supérieurs ; II = Feija de Guelmim ; III = Gorge d'Assaka (ou du bas oued Noun).

1b : L'oued Noun, ou Assaka au sens strict, partie distale du système fluvial (d'après P. Oliva, 1975).

Légende : Lithologie : 1 : Cambrien (schistes, quartzites, grès et calcaires) ; 2 : Moghrébien (calcarénites) ; 3 : Quaternaire (dépôts alluviaux et colluviaux).

Formes de relief : 4 : Principaux crêts ; 5 : Gorge ; 6 : Falaise ; 7 : Falaise morte moghrébienne.

depressions reach this southern area, like those in March 2002. Generally, anticyclonic arid conditions persist throughout the year and following occasional high flows, the lower Oued Noun reduces to a succession of “gueltas”, small shallow ponds of clear water coming from the groundwater and from karstic springs that depend on the groundwater level. In addition, coastal fogs retain early morning humidity in this low part of the valley that supports a steppe vegetation of *Euphorbia*, with some relict *Argania spinosa*.

The Gorge today comprises steep flanking dissected slopes carrying thin stony soils and regolith and a floor comprising the Soltanian silts. Today these latter are intricately dissected into gullies, ravines and canyons with piping a common process of erosion and gully head extension. The Soltanian terrace is deeply incised almost to the level of the original floor and silty terraces of Holocene age, also gullied, flank the modern wadi bed. The terrace inner margins at the foot of the valley slopes merge with a gravel-covered low-level pediment surface now moderately dissected by rills; in some places, this gravel sheet extends over the top of the silts.

Sedimentation in the present channel floor shows seasonal variations and has different morphogenetic meanings: coarse gravel channel clasts are of only local origin, issuing from slope-wash of weathered material on adjacent hill slopes and local tributaries which build ephemeral fans at their confluences; silts and fine sands, which constitute the main bulk of contemporary channel sediments, are also related with the occasional flood events both those generated locally and also those coming from the whole basin; other fine silts are deposited in the gueltas by prevailing NNW winds. Small dunes sourced from the local silts and fine sands, are built against well-exposed slopes of the valley. Under the present climatic conditions in the Oued Noun valley, we observe at the edge of some gueltas only very small concretions and no cascading travertine formations, nor stromatolithic and oncolithic deposits, unlike those of the Atlantic Atlas, further north (Weisrock, 1980), which require current regular fresh water flows and extensive active karstic dissolution throughout the catchment there.

3 - THE “SOLTANIAN” TERRACE AT FORT OUED NOUN

The Upper Pleistocene terrace, called Soltanian in Morocco (Beaudet, 1971; Biberson, 1971), is very well developed in the lowland reaches of the oued Noun, where it forms a continuous valley floor filling up to 30 m thick. It constitutes a significant aggradation that occurred during low marine levels (Weisrock & Rognon, 1977). At the present mouth of the oued Noun, the isobath of – 50 m lies at more than 20 km from the present shoreline (Oliva, 1977). The Soltanian terrace at Fort Oud Noun was built at about 65 km from the past shoreline, but the sediments probably feathered

out within 5 km of the present shoreline. Clearly, the Soltanian aggradation was upstream, catchment controlled.

3.1 - MAIN UNITS

Sections were examined at Fort Oued Noun: lower units being accessibly exposed in high river cliffs on the right bank, the upper units in adjacent gullies and rills (fig. 2). On the basis of major morpho-sedimentary discontinuities, 3 main, very unequal units were distinguished.

Unit 1 (figs 2 and 4: layer 1, ca. 2 m thick) is a basal fluvial unit reposing on the valley floor, that here is the bedrock. It consists of a conglomerate with ca. 8 cm mean b axis, well-rounded pebbles in a silty carbonated hard-cemented matrix. This unit is the remnant of fluvial bed-load deposits on a valley-floor that was as deep as today, but with a wider channel. Laterally, this conglomerate is buried by calcreted slope deposits from adjacent hill slopes, (on the left bank of the wadi), and associated well-laminated travertines. At the present mouth of Oued Noun (Foum Assaka), the valley floor shows fossilised marine terrace deposits from the Ouljian (= I.O.S. 5e) high marine level (Oliva, 1977; Weisrock *et al.*, 1999) which are also overlain by laminated calcrusts and travertines. Thus, Unit 1 may be a deposit of possible Ouljian or immediate post-Ouljian age, as seen further north of Agadir (Sabelberg, 1978; Weisrock, 1980).

Unit 2 (layers 2 to 35), more than 20 m thick, is the main unit of the Soltanian terrace.

It consists of at least 7 multibedded, repeated cyclothemic sequences. Each sequence comprises shallow channels of different sizes, their infills and overlying deposits. The channels are discontinuous, rarely more than 4 m deep and up to 15 m wide. They are filled first by bed-load deposits of rounded small pebbles and gravels, and secondly by sandy and silty sedimentary bodies. The upper parts of the infilling show travertine development, first of clastic fine grained detritic facies, with oncoliths and carbonated reed and roots remnants, secondly of built laminated facies, with Charophytes and Stromatolithic layers, containing numerous *Melanopsis*. These travertines are not so hard as those of Unit 1, and can extend over several tens of meter in length and are more than one meter thick. The detritic facies is always channel width limited; the built laminated facies can be often related to small steep-sloped tributaries, probably flowing over the guelta shore. The channels, their infillings and the travertines are finally overlain by more or less thick accumulation of silts and fine sands that display many laterally transitionnal facies, from the main channel sediments to distal, overbank facies. These silts are mostly grey-coloured (7.5 YR 4,5 to 6 Munsell).

In Unit 2, three parts can be distinguished (fig. 2): at the bottom, (layers 2 to 8), channel bar facies and relatively hard-cemented travertines are prominent; the

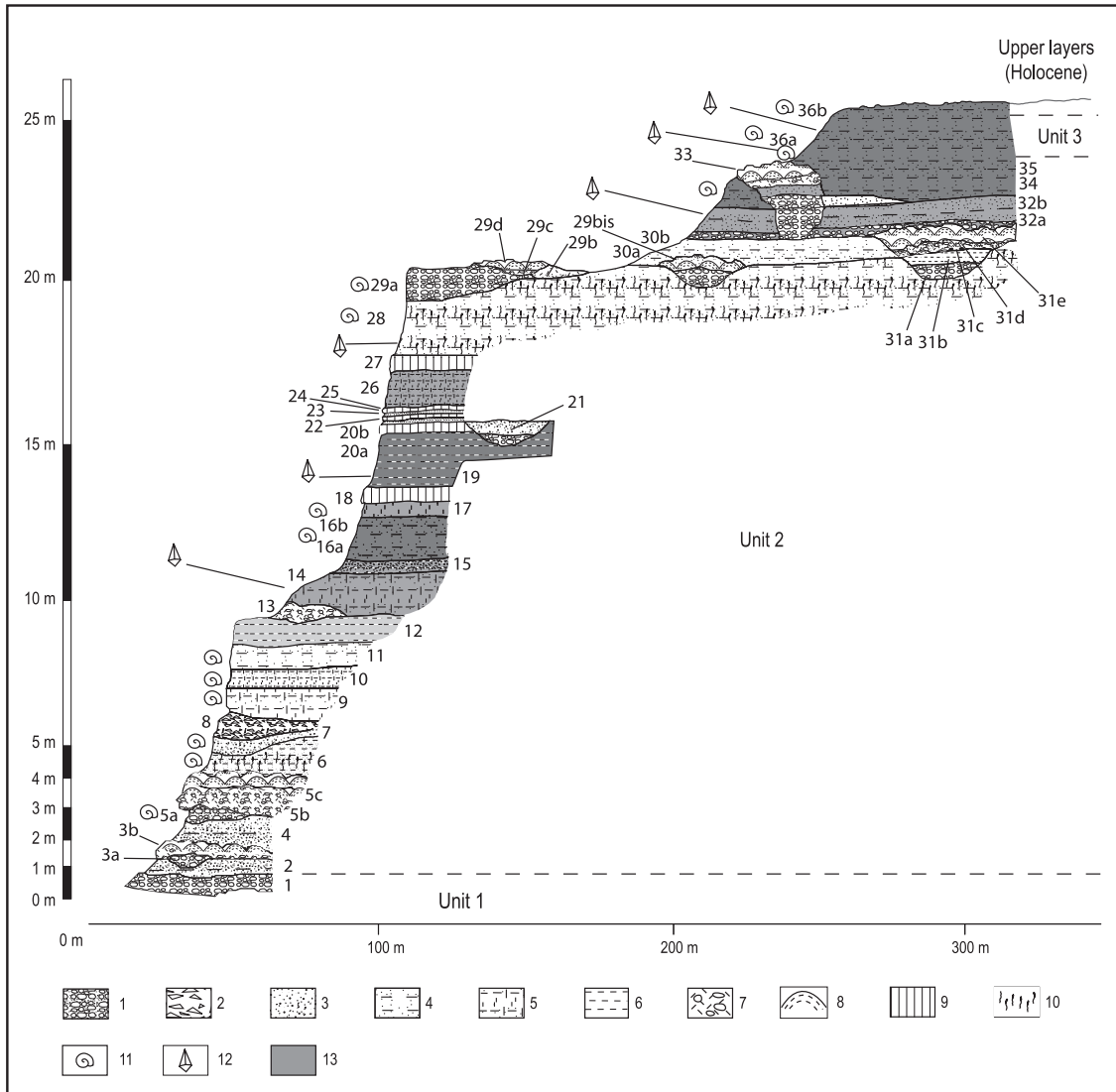

Fig. 2: The “Soltanian terrace” at Fort Oued Noun: 3 main Units (after L.Wengler *et al.*, 2002; J. Mathieu, to be published).

Key: 1 = Conglomerate; 2 = Angular schist gravel; 3 = Sand; 4 = Sandy silt; 5 = Carbonated sandy silt; 6 = Silt; 7 = Detrital travertine; 8 = Built stromatolitic travertine; 9 = Calcrust; 10 = Carbonated root remnants; 11 = Gastropod shells; 12 = Middle Paleolithic artefacts; 13 = Reddish coloration.

*Fig. 2 : La terrasse “soltanienne” à Fort Oued Noun : 3 Unités principales (d’après L. Wengler *et al.*, 2002 ; J. Mathieu, à paraître).*

Légende : 1 = Conglomérat ; 2 = Gravier de schiste anguleux ; 3 = Sable ; 4 = Sable limoneux ; 5 = Sable limoneux carbonaté ; 6 = Limon ; 7 = Travertin détritique ; 8 = Travertin stromatolithique construit ; 9 = Croûte calcaire ; 10 = Encroûtements racinaires ; 11 = Coquilles de Gastéropodes ; 12 = Artéfacts du Paléolithique moyen ; 13 = Coloration rougeâtre.

middle part (layers 9 to 28) are dominated by silty deposits; the upper part (layers 29 to 35) shows again more gravely and sandy bar facies deposits, overlain by travertines.

Unit 3 (layer 36a, from 1 to 5 m thick) is a silty and sandy unit at the top of the formation, especially well developed at the mouths of the tributaries. These silts are different from those of Unit 2, with a red and or pink coloration (5 YR 4/6), and with more aeolian quartz grains and palygorskyte (Mathieu, 2001). They were brought onto the main Soltanian sediments as lateral fans whose thickness is directly related to the tributary catchments. This morphostratigraphical relationship is analogous to the widespread Late Soltanian

“glacis d’accumulation” elsewhere in South-Western Morocco described by Weisrock (1980) and Weisrock *et al.* (2002).

The upper part of the section (layer 36b, less than 1 m thick) consists of sands, silts and clays, and has an ochre-red coloration (5YR 5.5/6). Containing locally derived angular schist gravels and Neolithic tools, it is a colluvial deposit and is not part of the Soltanian formation.

If Unit 1 and Unit 3 can be related respectively to classical semi-arid and sub-arid fluvial processes, this is not the case for Unit 2. Sedimentological analyses were done to understand this abnormal accumulation of fine material.

3.2 - CM DIAGRAM OF THE UNIT 2 AND MORPHO-DYNAMIC IMPLICATIONS (fig. 3)

To obtain an understanding of the transport processes associated with the deposition of the sandy and silty members, particularly those in Unit 2, grain size properties of samples from the main silty and sandy beds were analysed on a Passega CM diagram (Passega, 1957, 1964, 1977; Passega & Byramjee, 1969). Following particle size analysis, the C (coarsest 1

percentile in microns) and the M (median size in microns) values were plotted on a log: log graph. The plots suggest three groups in a general continuum of values (fig. 3).

Group 1, the coarsest samples 31-2a, 31-2f, 31-2g and 33e, show an M range of 45-120 microns and a Cu range of 1-4 mm. These sediments would be classified as a type III "graded" (grains maintained in the flow by turbulence) suspension with bed rolled grains by a moderately turbulent flow, and 33e with higher

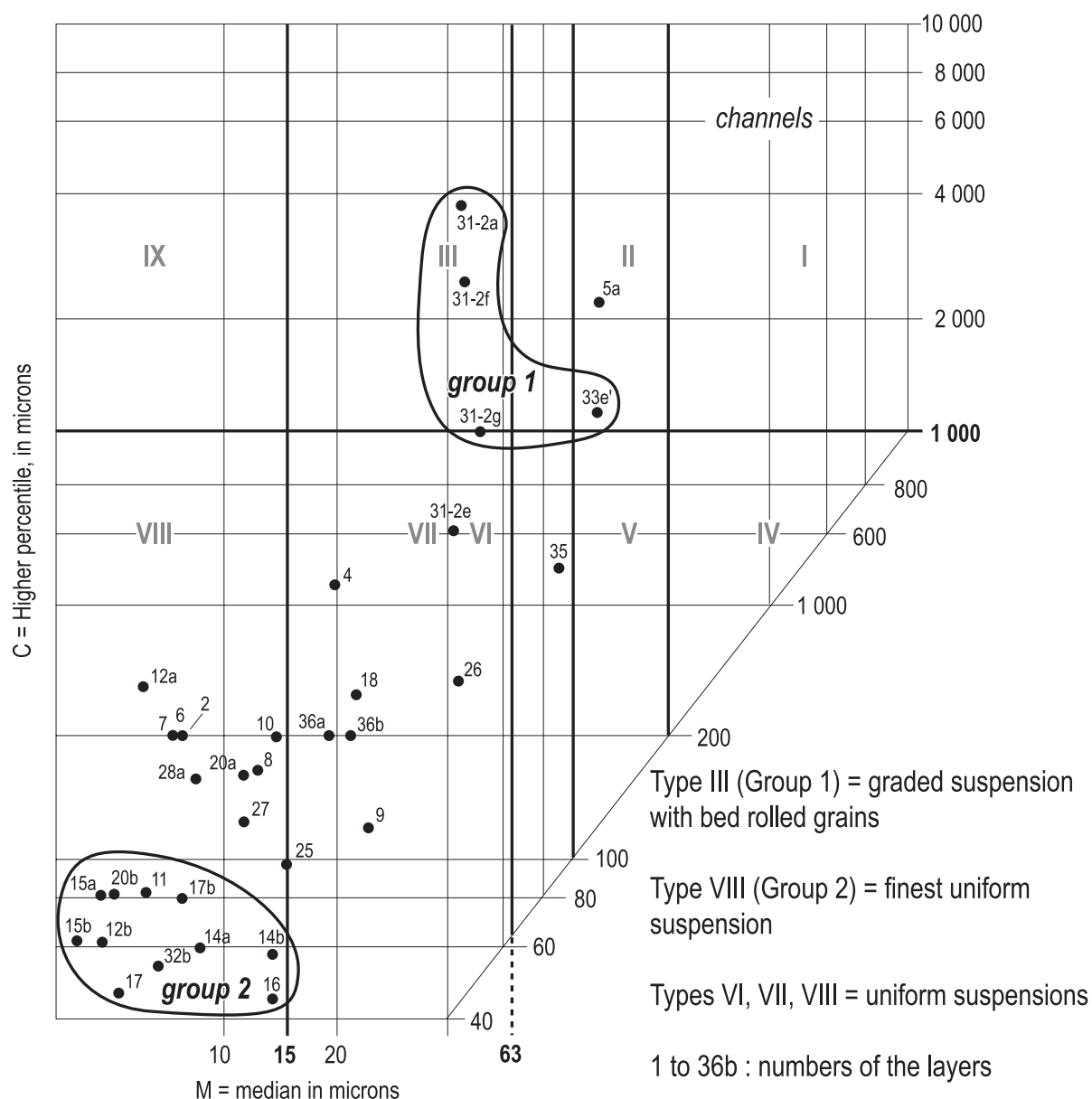

Fig. 3: Oued Noun at Fort Oued Noun: Passega CM diagram of Unit 2 (after R. Passega & R. Byramjee, 1969; P. Guery, 2000; J. Mathieu, to be published).

Type III (Group 1): graded suspension with bed rolled grains

Type VIII (Group 2): finest uniform suspension

Types VI, VII, VIII: uniform suspensions

1 to 36b: numbers of the layers.

Fig. 3 : Oued Noun à Fort Oued Noun : diagramme de Passega de l'Unité 2 (d'après R. Passega & R. Byramjee, 1969 ; P. Guery, 2000 ; J. Mathieu, à paraître).

Type III (Groupe 1) : suspension graduée avec grains roulés

Type VIII (Groupe 2) : suspension uniforme la plus fine

Types VI, VII, VIII : suspensions uniformes

1 à 36b : numérotation des couches

turbulence. These could be interpreted as deposition less distal in relation to the flood flow than the other samples, and from a flow that had higher turbulence than the others. The samples come from two within channel sedimentary bodies (31 and 33) in the upper part of Unit 2.

Group 2, fine sandy silts, the finest samples, possesses an M range of 2-14 microns and a Cu range of 45-82 microns. These would be classed as type VIII, finest “uniform” (sediment distributed through the whole depth of flow) suspension from a non-turbulent, perhaps non flowing body of water such as a shallow lake. Such a lake might form in a pre existing guelta or lie at the distal end of a waning flood, perhaps dammed behind a dune or a downstream sill of calcrete and travertine. Morphomicroscopy of some of the grains may have been Aeolian derived from reworking of earlier or adjacent fine silts and sands. All these samples came from layers that belong to the middle, dominantly silty fine sand part of Unit 2, except n° 32b which came from the upper part.

The remaining samples fall into Passega’s classes VI, VII and VIII of “uniform” suspensions. Type VII samples towards the upper right in this group, 31-2g and 35, would be classed as a low turbulence “uniform” suspension either within a channel towards the end in time of a flood, or laterally on the adjacent flood plain; 35 would indicate moderate turbulence. They contain some medium sized sands that might have been part of a far travelled or local tributary derived load. The remainder in this group, those mid to bottom right with Cus above 100 microns – are mainly type VIII – fine “uniform” suspension in flows with little turbulence, probably deposited from slowly moving water onto floodplains, marshes and swamps or in secondary abandoned channels.

These Group 2 samples came from the fine-grained silty fine sandy, clayey deposits making up the bulk of the main middle portion of Unit 2. There are numerous Middle Palaeolithic tools and bones through these sediments suggesting habited, moist, vegetated environments. This group also includes layer 36 from the non-Soltanian top layers.

The genesis of Unit 2.

- 1) The lower part of Unit 2 (layers 2 – 8) contains high-energy deposits, beds of suspension load sediments and several interbedded travertines and calcretes (n°3, 5 and 3-5 on the left bank of the wadi). A conspicuous feature is an irregular layer of angular schist gravels in a reddish-yellow silty matrix (layer n°8) derived from local hill slopes, that marks a specific but short lived input during this longer period of aggradation.
- 2) In its middle part (layers 9 – 28), Unit 2 begins with an “uniform” suspended load deposit possibly containing aeolian transported fines (n°9). As aggradation proceeded, the floodplain became wider.

During this phase, large floods carrying suspended silt loads reached this part of the valley:

- a) bed n°s 10, 18 and 26 are shallow channel infills with massive structure and sometimes small gravels (n°26) indicating sediment transport by traction with an “uniform” suspended load under upper regime flow. They are interpreted as flood deposits in active channels.
 - b) bed n°s 12a, 20a, 28a are thicker (2,50, 1 and 2,30 m respectively) and the CM plots suggest deposition from uniform suspended load during periods of maximum overbank inundation. However, in the case of 12a it is likely that the coarser fraction may have a wind blown source. In the narrower sections of the valley gorge, dams from earlier sediments or temporary dunes may have occurred with subsequent extension of marshes and gueltas.
 - c) bed n°s 12b to 17a, 20b, 32b are thin, show lamellar structure and often contain clay. They were probably laid down in abandoned channels and gueltas from the settling out of suspension load under slack water conditions.
- In this middle part of Unit 2, the successive shallow channel-, overbank- and floodplain-deposits represent three repeated aggradation sequences. Flows were generally valley floor wide and had differing discharges, velocities, turbulences and sediment sourcing. Some may have been near the end of the downvalley flow extent; other may have proceeded further down gorge. The flows were generally very turbid despite sedimentation that must have occurred in the Guelmim basin upstream of the gorge. We may suppose that during at least three periods, the valley floor saw a succession of shallow palaeo-gueltas.
- 3) In its upper part (layers 29 – 35), Unit 2 shows an increase of gravelly and sandy deposits (n°31, 33 and even 35) oversealed by travertines. We suggest these indicate a new sedimentary style associated with shifting gravel-bed channels towards the end and on the top of the main phase of the silty aggradation and especially near the flanking valley slopes. Groundwater levels, however, remained high and some very fine slack water suspension load beds were laid down (e.g. n°32). In some places the fine gravels may have been locally reworked as discontinuous “shorelines” around palaeo-gueltas.

Other morphological and chemical evidence for high groundwater table levels are CaCO₃ indurations of the steep faces of beds 12 and 28, gypsum and salt crystallisations in numerous beds and hydromorphic features; calified bioliths of root channels indicate vegetation in moist soils. We may suppose that Unit 2 is a record of i) flood events at the end of the flow extent, probably widely separated in time, and ii) almost continuous sedimentation in the gueltas, albeit with a very low rate, between the flood events.

4 - CHRONOLOGY MEASUREMENT RESULTS

Three dating methods were used, giving 19 age results at the Fort Oued Noun section: ^{14}C method on 8 samples of charcoal and *Melanopsis*; Optically Stimulated Luminescence (OSL) on quartz grains from 6 sediment samples, and Uranium/Thorium (U/Th) method on 5 samples of travertines (tab. 1, 2, 3 and fig. 4).

4.1 - ^{14}C DATES (tab. 1 and fig. 4)

The samples were collected from layers 21 to 35 in the upper part of Unit 2. All but 3 came from channel

sandy facies within the Unit. Three samples came from the top layer 35 (massive sandy silts).

Radiocarbon analysis was performed by β -counting (using conventional method employing CO_2 gas proportional counters) at the L.S.C.E. of Gif-sur-Yvette. Results are presented as conventional ^{14}C ages. All samples were prepared following the standard procedure (Délibras, 1985). The shells were mechanically cleaned of adhering contaminants. Leaching with dilute HCl was used to remove the portions of the shell matrix suspected to have been affected by exchange reactions (Vita-Finzi & Roberts, 1984). However, *Melanopsis* shells are very thin and

N°Gif	Layer	Reference	Material	Conventional Age Y. B.P.	Delta ^{13}C	Minimum ^{14}C Y.B.P. age(1)
11487	35	ON99/11-3	<i>Melanopsis</i>	18 970+/-230	-6,13	$\geq 18 510$
11486	33	ON99/11-2	<i>Melanopsis</i>	21 130+/-350	-5,33	$\geq 20 430$
11488	35	ON99/11-4	<i>Melanopsis</i>	21 400+/-230	-6,23	$\geq 20 940$
11758	35	ON8/3/02	<i>Melanopsis</i>	22 100+/-370		$\geq 24 000$
11485	29 b	ON99/11-1	<i>Melanopsis</i>	24 100+/-630	-7,29	$\geq 24 000$
11212	21	OA98/11-9	<i>Melanopsis</i>	>24 000	-7,82	$\geq 24 000$
11648	31	ON11/22a	Charcoal	27 820+/-580	-24,85	27 820+/-580
11650	31	ON22/2aval	Charcoal	28030+/-530	-26,06	28 030+/-530

Tab. 1: ^{14}C Dates of Fort Oued Noun section.
(1): Minimum ^{14}C Y.B.P. age, except for charcoal samples

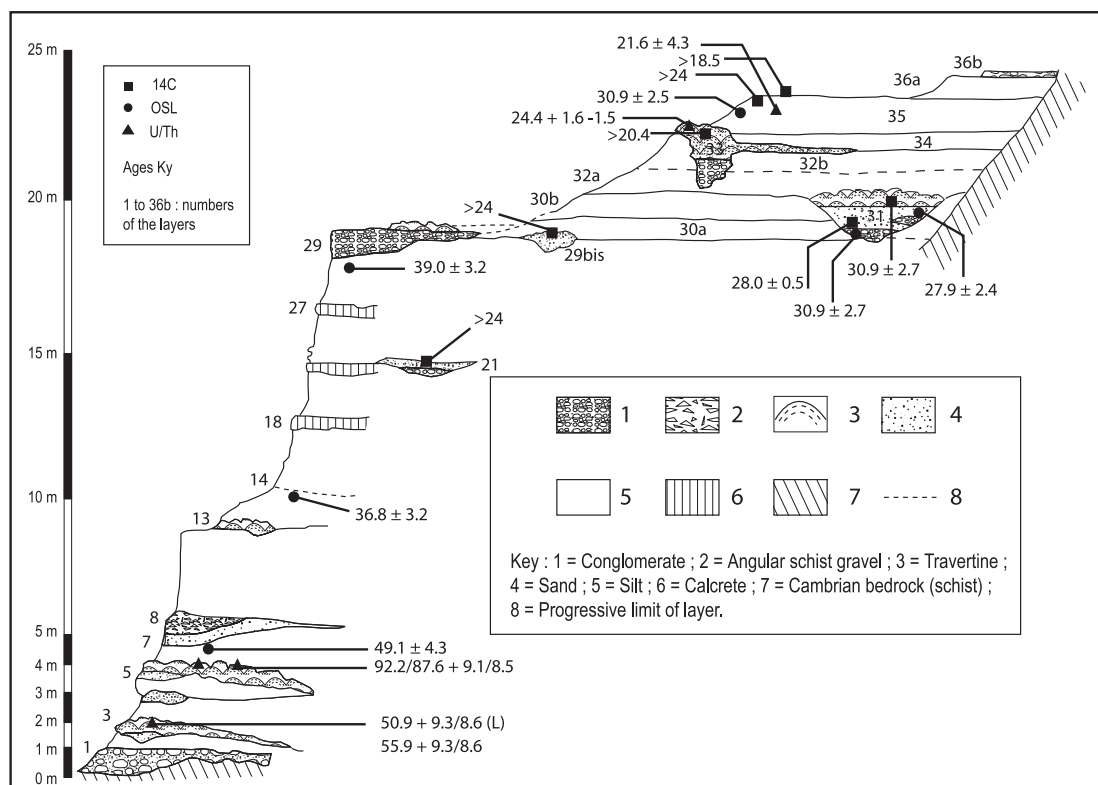

Fig. 4: Fort Oued Noun: Stratigraphic location of dated samples.

1 = Conglomerate; 2 = Angular schist gravel; 3 = Travertine; 4 = Sand; 5 = Silt; 6 = Calcrete; 7 = Cambrian bedrock (schist); 8 = Progressive limit of layer.

Fig. 4 : Fort Oued Noun : position stratigraphique des échantillons datés.

1 = Conglomérat ; 2 = Gravier de schiste anguleux ; 3 = Travertin ; 4 = Sable ; 5 = Limon ; 6 = Croûte calcaire ; 7 = Substratum cambrien schisteux ; 8 = Limite de couche progressive.

fragile, secondary recrystallisation processes are probable and could make the ages too young. As we cannot be completely sure that acid leaching removes all the possible recrystallisation, we prefer to express the results as minimum ages, except of course for charcoal samples.

4.2 - OSL DATES (tab. 2 and fig. 4)

The optical dating method (Aitken, 1998) was applied to 6 sediment samples from Unit 2. Their precise stratigraphic positions are indicated on figure 4, and they span the full sedimentary sequence, from near the base (layer 6) to the top layer 35. All samples are fine silts, except those of layer 31 which are sands.

For each sample, middle-sized quartz grains (40-50 μm) were extracted and isolated, according to the procedure described in Mercier *et al.*, (2003). To determine the mean equivalent dose (ED), a single-aliquot regenerative dose (SAR) protocol (Murray & Wintle, 2000) was applied to several sub-samples (at least 24 aliquots per sample). All luminescence analyses were done with a Risoe TL/OSL DA-15 reader equipped with blue light emitting diodes for optical stimulation,

and artificial doses were given by a calibrated Sr/Y-90 beta radioactive source fitted to the reader.

Radioisotopic contents of bulk sediment samples were measured with a high-purity Ge detector; no disequilibrium in the U-series and Th-series was detected. Alpha and beta dose-rates were deduced from these values using the conversion factors given by Adamiec and Aitken (1998) and from attenuation factors relevant to the 40-50 μm granulometric fraction (Mejdahl, 1979; Brennan *et al.*, 1991). Quartz grains were assumed free of radioelements. α -sensitivity of 5 $\mu\text{Gy/a}/10^3 \sigma$ was used for all samples.

Gamma and cosmic dose-rates were deduced from field measurements done with a portable gamma spectrometer. Annual dose-rates were computed by assuming a mean past water content of 10% ($\pm 3\%$) by weight.

For each sample, at least 24 aliquots, each composed of hundred of grains, were analysed in order to evaluate the distribution of the individual equivalent doses. Depending on the sample, the distributions indicated a more or less important scatter of the individual values around the arithmetic mean, probably due to incomplete bleaching of the grains or because of the presence

Sample	Layer	U (ppm)	Th (ppm)	K (%)	Alpha	Beta	Gamma	Cosmic	Annual	+ -	Equi. Dose (Gy)	+ -	Age (ka)	+ -
OSL 19	35	2,96	8,32	2,32	130	2132	1162	200	3624	43	112	1,5	30,9	2,5
OSL 1	31	2,68	6,43	2,42	110	2767	1238	144	4259	130	119	1,2	27,9	2,4
OSL 2	31	2,76	6,03	2,28	75	2608	1183	148	4014	127	124	2	30,9	2,7
OSL 18	28	2,95	7,35	2,02	123	1904	1054	200	3281	42	128	2	39	3,2
OSL 3	14	3,83	7,44	1,77	144	2314	1031	124	3613	113	133	3	36,8	3,2
OSL 17	6	2,45	7,56	2,28	113	2025	1069	110	3317	42	163	5	49,1	4,3

Tab. 2: OSL dates of Fort Oued Noun section.

Travertines Layers	²³⁸ U ppm	^{234/238} U mes	^{230/234} U	Age ka	^{234/238} U	²³² Th ppm	^{230/232} Th	Age ka, corrected*	+/-
35	0,854 +/- 0,020	4,931 +/- 0,096	0,250 +/- 0,003	30 +2,3 -2,2	5,275 +/- 0,104	0,924 +/- 0,019	3,47	21,6	+4,3
33	3,07 +/- 0,053	3,73 +/- 0,042	0,313 +/- 0,003	38,9+1,6 -1,6	4,041 +/- 0,05	4,284 +/- 0,06	2,55	24,4	+1,6 -1,5
3	1,81 +/- 0,088	3,79 +/- 0,14	0,528 +/- 0,009	73,6 +7,9 -7,3	4,421 +/- 0,172	3,178 +/- 0,04	3,46	55,9	+9,3 -8,6
3, leaching	1,48 +/- 0,098	4,64 +/- 0,245	0,445 +/- 0,011	59,0 +10 -9,1	5,291 +/- 0,289	1,52 +/- 0,06	6,1	50,9	+10,8 -9,8
3-5	2,11 +/- 0,034	3,39 +/- 0,061	0,677 +/- 0,009	105 +8,7 -8,1	4,20 +/- 0,98	3,12 +/- 0,07	4,73	87,6	+9,1 -8,5
5	1,39 +/- 0,03	3,90 +/- 0,08	0,643 +/- 0,01	96,3 +11 -10	4,80 +/- 0,11	1,79 +/- 0,06	5,92	Isochron age Sample 5	
5	1,81 +/- 0,041	4,25 +/- 0,088	0,618 +/- 0,007	90,7 +8,3 -7,7	5,19 +/- 0,11	1,053 +/- 0,04	13,8	92,2	
5	1,72 +/- 0,063	3,64 +/- 0,133	0,723 +/- 0,025	115 + 33 - 25	4,64 +/- 0,18	2,691 +/- 0,22	5,13		
Waters Hotel Oued Noun	²³⁸ U ppb 2,83 +/- 0,10 5,82 +/- 0,20				5,12 +/- 0,12 5,07 +/- 0,10				

Tab. 3: U/Th dates of Fort Oued Noun section.
Errors quoted are one sigma counting statistics.

•: corrected ages = corrected for detrital contamination with $^{230}\text{Th}/^{232}\text{Th} = 1$, measured in the sedimentary detrital fraction.

of poorly bleached quartz grains. This last value was chosen as the mean equivalent dose (tab. 2). However, because of the observed scatter, it cannot be totally excluded that this value is over or under-estimated. In Table 2 are summarized the dosimetric data relevant to the sediment samples. All errors are given at 1 σ level; age uncertainties include statistical and systematic errors.

4.3 - URANIUM/THORIUM DATES (tab. 3 and fig. 4)

Three travertine samples (n°3, 5 and 35) belong to the Fort Oued Noun main section, and two (a calcrust, n°3-5, and 33) came from the left bank of the wadi, in equivalent stratigraphic succession. The collected samples thus come from the base (n°3, 3-5, 5) and from the top (n°33, 35) of Unit 2. All samples, except n°3-5, are true travertines, of hard cemented laminated facies.

All samples were analyzed after total dissolution and addition of a $^{232}\text{U}/^{228}\text{Th}$ tracer solution using a method similar to that described by Ku (1976). Alpha counting was carried out with solid-state detectors and errors are expressed as one standard deviation based on counting statistics.

Impure carbonates are generally considered as unreliable species for Th/U dating (Ku & Liang 1984; Bischoff & Fitzpatrick, 1991; Kaufmann, 1993) for two main reasons: (i) presence of detrital ^{230}Th in dirty samples will increase the $^{230}\text{Th}/^{234}\text{U}$ ratio and make the sample look older; and (ii) post deposition addition of Uranium from groundwaters gives rejuvenated ages. Most samples in Table 3 were corrected for a detrital contribution using a $^{230}\text{Th}/^{232}\text{Th}$ ratio of 1, measured in sediments sampled in the studied area. For sample n°5, an isochron technique was attempted, using total sample dissolution (Bischoff & Fitzpatrick, 1991). The isochron age of 92.2 ka compares well with the corrected age of 87,6 ka of n°3-5, in the same stratigraphic situation. Sample n°3 was dated on the bulk sample and on a leached (HNO_3 , 1N) aliquot, both giving concordant ages.

5 - DISCUSSION (fig. 4)

5.1 - UNIT 2, UPPER PART (Layers 29 - 35)

The ^{14}C dates, from charcoal, show a securely dated channel deposit (n° 31) with an age of about 28 ka B.P, but more imprecise results for the other channels (sampled beds 29, 33 and 35) using *Melanopsis* shells, whose ages lie between ≥ 28 ka B.P. – and $\geq 18,5$ ka B.P. The two OSL dates of channel 31 are concordant with ^{14}C results, but the date of 30,9 \pm 2,5 ka obtained for layer 35 overlying channel deposit 33 is too old when compared to ^{14}C (≥ 24 ka) and U/Th (21,6 \pm 4,3 ka and 24,4 \pm 1,6 – 1,5 ka). The spread of dates from the three techniques might arise through an overestimation of the OSL age; because of insufficient

bleaching as noted previously, and from the fact that the carbonated secondary mineral dated by U/Th had developed within that sediment after its deposition (Nanson *et al.*, 1991).

Despite these problems, the radiometric dates clearly indicate that the upper part of Unit 2 (layer numbers 30 to 35) was deposited between ca 30 and 21 ka B.P., and perhaps even up to 18,5 ka B.P. These ages fit well with those obtained for the overlying Unit 3 dated by OSL at 17 ka B.P. at a neighbouring site (Mathieu, to be published).

5.2 - UNIT 2, MIDDLE PART (Layers 9 – 28)

OSL results indicate that the most important part of the silty sedimentation (more than 10 m thick between layer numbers 14 and 28) occurred between 39,0 \pm 3,2 and 36,8 \pm 3,2 ka B.P. The error margins don't allow us to choose between two hypotheses of duration: long (between 42 and 33 ka) or short (between 39 and 36 ka).

5.3 - UNIT 2, BOTTOM PART (Layers 2 – 8)

OSL and U/Th dates of this basal portion of Unit 2 give two groups of results. U/Th ages for layer n°3 (laminated travertine) and an OSL age for layer n°6 silts suggest an age range of 55,9 \pm 9,3 – 8,6 ka to 49,1 \pm 4,3 ka B.P. However, the U/Th ages for calcrete/travertine in layer n° 5, of 92,2 ka, and in layer n°3-5, of 87,6 \pm 9,1 – 8,5 ka B.P., are not concordant with the other dates (fig. 5). Sample layer n°3-5 came from the opposite side of the valley and was not in the same stratigraphic succession as the other samples. Therefore, either this date is correct and the stratigraphic interpretation of layer n°3-5 is wrong, or the date is unsound. The U/Th isochron age of 92.2 ka for sample n° 5 remains inexplicable, although it is known that the ages of indurated secondary carbonated deposits may not necessarily fall in strict chronostratigraphic order (Nanson *et al.*, 1991). So, presently, we prefer to consider the dates from layer numbers 3 (U/Th) and 6 (OSL), which are stratigraphically coherent, as representing the time between carbonate closure in the travertine (defined by U/Th dating) and overlying silt sedimentation (defined by OSL dating). Therefore, the age span of this lower part of Unit 2 lies possibly before 55 ka and after 49 ka. This possibly means that the O.I.S. period 4 was characterised by a higher frequency of channel forming sediment events than O.I.S.3.

In spite of their uncertainty, the two results about 90 ka could not be abandoned: we have recorded similar dates on calcrete/travertine deposits in apparently similar stratigraphic positions in neighbouring sites, as has M. Thorp further East (*in litteris*). These deposits are possibly preserved remnants of older formations at the base of the Soltanians, and may imply a beginning of the infilling of the valley at O.I.S. 5b-5a, as previously suggested with regard to the relation

between Unit 1 and the Ouljian fossil beach (*Supra*, 3-1, Unit 1).

6 - CHRONOLOGY AND DURATION OF THE MAIN MORPHODYNAMICAL EVENTS

On the basis of these results, we suggest the following sequence of morphodynamic events in the Oued Noun valley (fig. 5 and 6):

6.1 - OXYGEN ISOTOPE STAGE 5 (128-75kbp)

The first alluviation phase is a high-energy fluvial deposit, (Unit 1) for which the U/Th datings remain uncertain.

One hypothesis is that this conglomerate dates to stage 5, as suggested above. This was a coarse sedimentation into a deep valley, with the same valley floor almost as to day. The size of the boulders and gravels indicates high stream power and large floods, with deposits of both proximal and distal origin. The classic interglacial stage 5 is known to have been a period of valley-floor incision in South Morocco (Weisrock & Rognon, 1977), as in the whole Mediterranean area (Macklin *et al.*, 2002). Evidence for a major humid phase during the last Interglacial in the Sahara has also been evoked (Petit-Maire *et al.*, 1994).

Alternatively, the whole of Unit 1, and the base of Unit 2 can be considered as more recent (ca. 55 - 50 ka).

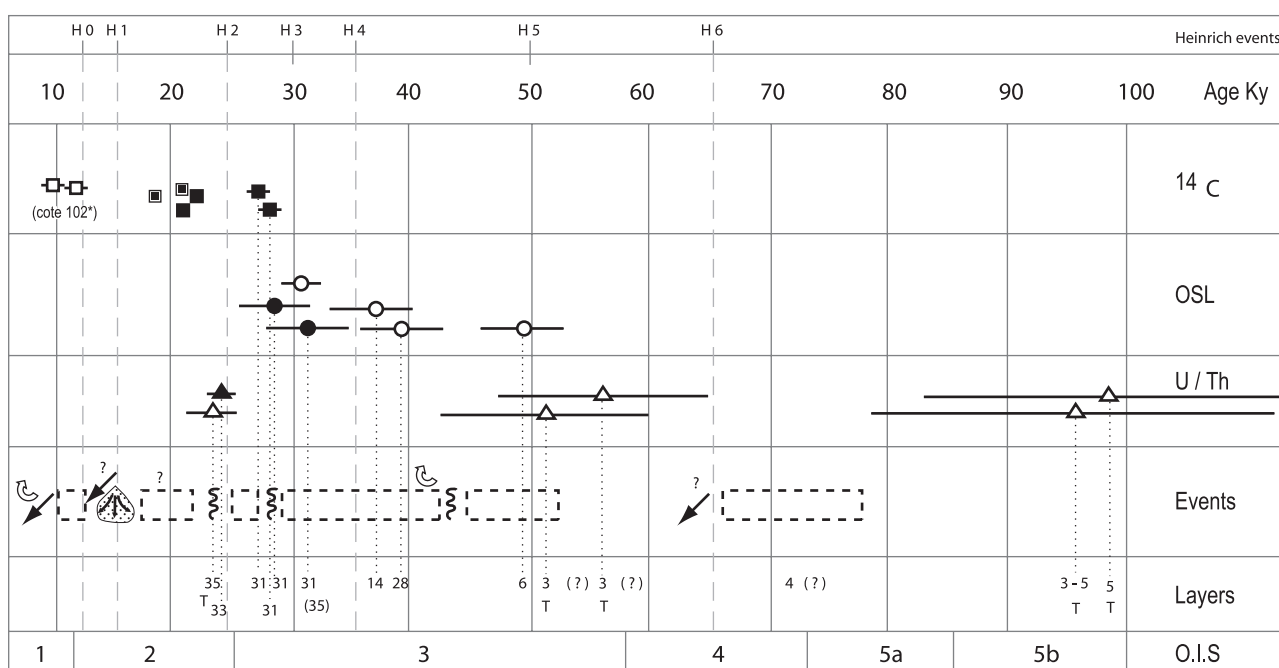

Dating control :

- 1 = OSL, on shallow channel sandy deposit
- 2 = OSL, on floodplain fine silt deposit
- ▲ 3 = U/Th, on built stromatolithic travertine (T)
- ▲ 4 = U/Th, on built travertine at the top of a channel deposit
- 5 = 14C, on charcoal in shallow channel deposit
- 6 = 14 C, on shell (*Melanopsis*) or on Ostrich egg, in carbonated silt
- 7 = 14C, on shell (*Melanopsis*) in silt over travertine

Morphological environment :

- 8 = Tributary fan
- 9 = Aeolian supply
- 10 = Incision
- 11 = Shallow channel form
- 12 = Alluviation

*Cote 102 is a similar outcrop in the same wadi, 6 km upstream of Fort Oued Noun.

Fig. 5: Dated alluvial Units of wadi Noun at Fort Oued Noun and correlative morphological events.

Dating control:

1 = OSL, on shallow channel sandy deposit; 2 = OSL, on floodplain fine silt deposit; 3 = U/Th, on built stromatolithic travertine (T); 4 = U/Th, on built travertine at the top of a channel deposit; 5 = 14C, on charcoal in shallow channel deposit; 6 = 14C, on shell (*Melanopsis*) or on Ostrich egg, in carbonated silt; 7 = 14C, on shell (*Melanopsis*) in silt over travertine.

Morphological environment:

8 = Tributary fan; 9 = Aeolian supply; 10 = Incision; 11 = Shallow channel form; 12 = Alluviation.

Cote 102 is a similar outcrop in the same wadi, 6 km upstream of Fort Oued Noun.

Fig. 5 : Unités alluviales datées de l'oued Noun à Fort Oued Noun et événements morphologiques correspondants.

Datations :

1 = OSL, sur dépôt sableux de chenal peu profond ; 2 = OSL, sur dépôt limoneux fin de plaine d'inondation ; 3 = U/Th, sur travertin stromatolithique construit (T) ; 4 = U/Th, sur travertin construit au sommet d'un dépôt de chenal ; 5 = 14C, sur charbon dans dépôt de chenal peu profond ; 6 = 14C, sur coquille de *Melanopsis*, ou sur coquille d'oeuf d'Autruche, dans limon carbonaté ; 7 = 14C, sur coquille de *Melanopsis*, dans limons sur travertins.

Environnement morphologique :

8 = Cône affluent ; 9 = Apport éolien ; 10 = Incision ; 11 = Creusement de chenal peu profond ; 12 = Alluvionnement.

Cote 102 est une coupe similaire sur le même oued, située 6 km à l'amont de Fort Oued Noun.

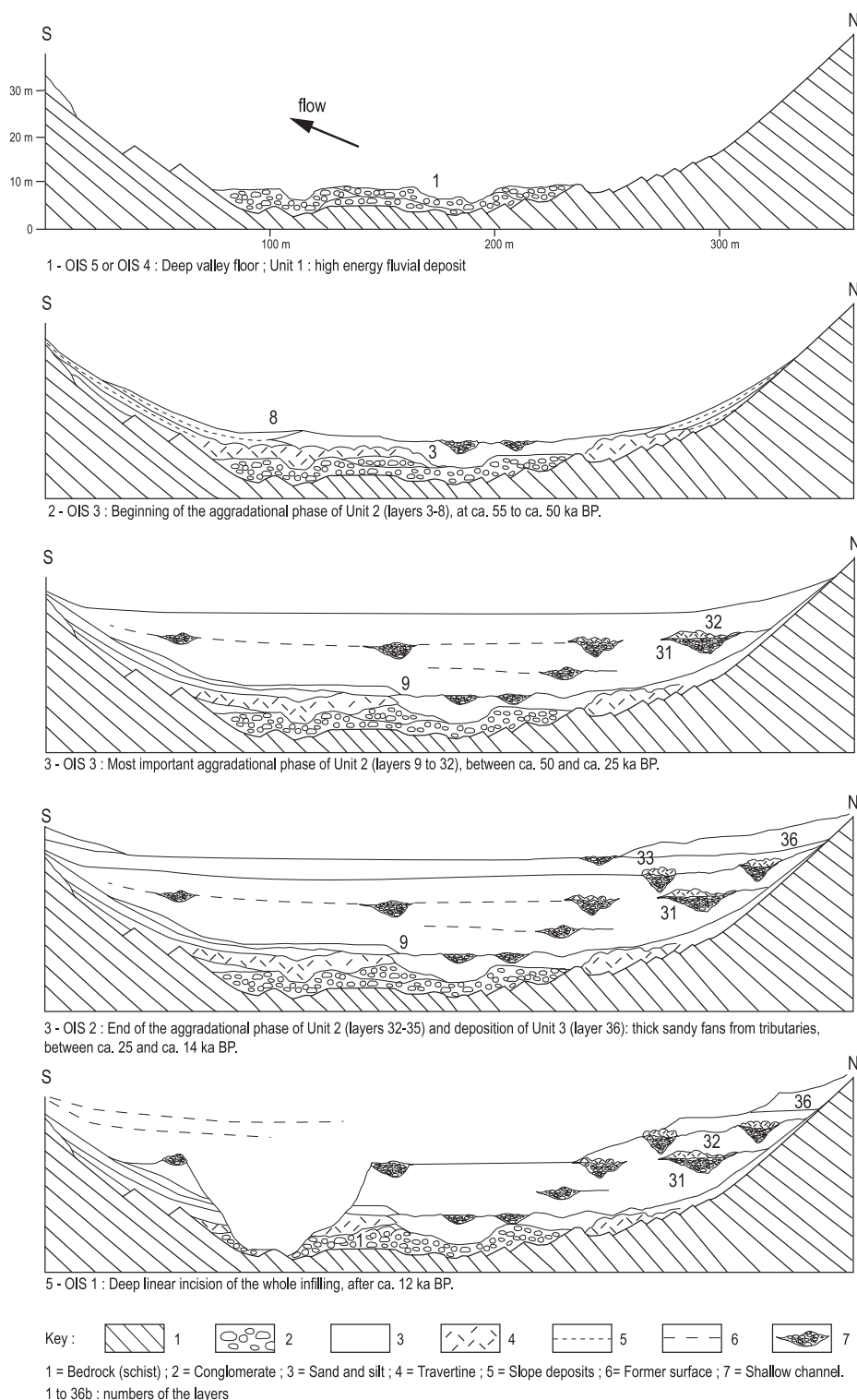

Fig. 6: Morphostratigraphical reconstruction of the Soltanian infilling history of wadi Noun at Fort Oued Noun.

1 - OIS 5 or OIS 4 : Deep valley floor ; Unit 1 : high energy fluvial deposit

2 - OIS 3 : Beginning of the aggradational phase of Unit 2 (layers 3-8), at ca. 55 to ca. 50 ka BP.

3 - OIS 3 : Most important aggradational phase of Unit 2 (layers 9 to 32), between ca. 50 and ca. 25 ka BP.

4 - OIS 2 : End of the aggradational phase of Unit 2 (layers 32–35) and deposition of Unit 3 (layer 36): thick sandy fans from tributaries, between ca. 25 and ca. 14 ka BP.

5 - OIS 1 : Deep linear incision of the whole infilling, after ca. 12 ka BP.

Key: 1 = Bedrock (schist) ; 2 = Conglomerate ; 3 = Sand and silt ; 4 = Travertine ; 5 = Slope deposits ; 6 = Former surface ; 7 = Shallow channel.

Fig 6 : Reconstitution morphostratigraphique de l'histoire du remplissage soltanien de l'oued Noun à Fort Oued Noun.

1 - OIS 5 ou OIS 4 : Profonde vallée ; dépôt de haute énergie de l'Unité 1.

2 - OIS 3 : Début de la phase d'aggradation de l'Unité 2 (couches 3-8) à environ 55 - 50 ka BP.

3 - OIS 3 : Phase d'aggradation maximale de l'Unité 2 (couches 9 à 32), entre environ 50 et environ 25 ka BP.

4 - OIS 2 : Fin de la phase d'aggradation de l'Unité 2 (couches 32-35) et dépôt de l'Unité 3 (couche 36) : épais cônes sableux affluents, entre environ 25 et 14 ka BP.

5 - OIS 1 : Profonde incision linéaire de l'ensemble du remplissage, après environ 12 ka BP.

Clé : 1 = Substratum schisteux ; 2 = Conglomérat ; 3 = Sable et limon ; 4 = Travertin ; 5 = Dépôts de pente ; 6 = Ancienne surface ; 7 = Chenal peu profond.

6.2 - OXYGEN ISOTOPE STAGE 4 (75-64 kabp)

No member of Unit 2 was directly dated to OIS 4. If Unit 1 (undated) belongs to OIS 5 and the base of Unit 2 to 55 ka B.P., there are no dated sediments belonging to OIS 4. Alternatively, Unit 1 may be OIS 4, a climatic period known to be cool and dry in the Mediterranean and the Atlantic (Heinrich 6), (Bond *et al.*, 1993).

6.3 - OXYGEN ISOTOPE STAGE 3 (64-32 kabp)

The main aggradational phase, Unit 2, consisting of repeated cyclothem sequences only slightly disturbed by minor erosional phases, occurred during this Stage.

This aggradational phase begins at ca. 55 ka with travertine deposits on gravels (layer 3), and the main silty sand layers commence after ca. 49 ka B.P. (layer n°6), with a uniform suspended load of tractive flow. Minor erosional phases, characterised by shallow small channel or gully features, occur in this lower part of Unit 2. They include colluvium and laterally derived slope debris (layer n°8) suggesting that glacial processes were active on the lower valley side slopes, transferring sediments to the valley floor. Such sheet-flood processes may have been associated with a drier environment, but the duration of this episode remains still unknown.

Above layer n°8 occurs the most important aggradational sequence, 12,50 m thick, with dates from about 45 to 30 ka (layers 9 to 28). This phase saw an increase of fine sediment supply, mostly between ca. 37 and 33 ka. Sedimentological records and faunistic remnants (mostly of *Bovini*) indicate a local open biostatic environment, like a steppic prairie or a dry-forest (Wengler *et al.*, 2002). This is probably one of the most important palaeoclimatic inferences from this site, indicating a more frequent occurrence of subtropical rains in the desert margin (Rognon, 1996). An important alluviation phase with this age is widely reported from the Mediterranean basin (Besançon *et al.*, 1997; Macklin *et al.*, 2002), but with an opposite, rhexistasic, process significance.

The upper part of Unit 2 shows several small meandering channel fills containing small pebbles, calcreted root remnants and oncoliths, starting with layer n°29. Channel fill layer n°31 gives dates of ca. 30,9 - 27,8 ka B.P., dates comparable with those for channel gravels in the Soltanian silts in the Anti-Atlas valleys further east (Thorp *et al.*, 2002). It may coincide with Heinrich event 3. The upper part of the sequence, layer numbers 29 - 32, therefore shows more variability in sedimentation but not of such a degree as to suggest any major climate change: tree charcoal, bones of *Bovini* and Middle Paleolithic tools are still present as they are in the layers below. Recurrent travertine constructions and silt deposits initiated by small shallow wandering gravel bedded channels continue at a high aggraded valley level during the 30 – ca. 24 ka period, suggesting little significant change.

6.4 - OXYGEN ISOTOPE STAGE 2 (32-13 kabp)

This stage begins with a small channel (layer n°33 eroded into layer n°32). It is similar to layer n°31 but dates to ca. 24 - 20 ka and possibly coincides with Heinrich event 2. Further silt alluviation layers, numbers 34 and 35, overly these channels in the floodplain, and pebbly bars of reworked coarse material appeared close to the valley slopes. The top of this sedimentary aggradation was here reached at ca. 20 ka B.P., as in other parts of South Morocco (Boudad *et al.*, 2003), but not in the same catchment further east where it continues till ca 11 ka B.P. (Andres, 1977; Thorp, *in litteris*).

The last phase of OIS 2 sedimentation, Unit 3, layer n°36, consists of both active erosion and deposition and indicates the end of the main cyclothem aggradational phase. Thick sandy and silty fans, sourced from the glacial slopes of the tributary catchments, and also containing aeolian quartz grains and palygorskyte, were deposited at their confluences with the main valley after 20 ka B.P. These latest sediments repose on the surface of layer n°35 with a date of ca. 18,5 ka B.P. 2 km upstream, the base of this colluvial fan aggradation is dated at 17 ka B.P. (OSL date communicated by N. Mercier), and at ca. 14 ka further north in the Anti-Atlas, (Weisrock *et al.*, 1994). At this time it is possible that an increase in aridity and a reduction in vegetation cover led to increase soil erosion by sheet-floods over the catchment slopes. On the valley floor in Oued Noun, the gueltas became shallower, more restricted and finally dried out, probably by 12 or 10 ka B.P.

At the end of OIS 2 and the beginning of OIS 1, ca 10 ka B.P., deep linear incision of the whole infilling commenced (Mathieu *et al.*, 2004).

7 - CONCLUSIONS

7.1. Despite two radiometric ages that are not in chronostratigraphical order, comparative dating methods tested on the same section and even on the same layers give generally consistent results. All but 2 of the 20 dates lie in the range 55,9 – 18,5 ka B.P., that is OIS stages 3 and 2. Apart from the two out of sequence dates of 92,2 and 87,6 ka B.P., there are either no sediments or no dates for OIS stages 4 and 5. The basal sedimentary Unit 1 consists of a coarse cobble fluvial gravel but remains undated.

7.2. The main unit (Unit 2) of the Oued Noun Soltanian formation was deposited between ca. 55 and 25 ka B.P. The most important part of this silty aggradation (more than 12,5 m thick) occurred during OIS.3, between ca. 40 and 30 ka B.P. It comprises repeated sequences of shallow channels, their small gravel and sands infills, their travertine caps and overlying silts. Some of the silts contain aeolian grains, some were deposited in former gueltas, and most were fluvial overbank sediments. This period was, in this area at the northern boundary of the Sahara, a biostatic phase, with a more regular water

supply than today and ground water levels may have risen whilst the valley floor aggraded.

7.3. Aridity and flow variability increased after ca. 20 ka., when climate changed significantly from a biostatic state, with probably more frequent subtropical rains than today, to an arid state similar to a mediterranean seasonal-type climate. After ca. 18,5 ka B.P., Unit 3 – shallow silty sandy fans with aeolian inputs and sourced from the local tributaries – was deposited over Unit 2. This period of reduced vegetation, enhanced aridity and accelerated soil erosion continued until ca 12 ka B.P. after which, in OIS.1, the aggradation fills were deeply incised to their present depths.

ACKNOWLEDGMENTS

This work was supported by the French CNRS programme “ECLIPSE” and the French-moroccan cooperation agreement AI 87/03. The authors are greatly indebted to Martin Thorp (University of Dublin, Ireland) for his helpful criticism and comments, and his entire rewriting of the english manuscript. Thanks are due also to another anonymous rewriter and to Hassan Benhalima (University of Agadir), who has always facilitated our studies in Morocco.

REFERENCES

- AITKEN M. J., 1998 - *An Introduction to Optical Dating*. Oxford University Press.
- ADAMIEC G., & AITKEN M. J., 1998 - Dose-rate conversion factors: update. *Ancient TL*, **16**, 37-49.
- ALIMEN H., BEUCHER F., & CONRAD G., 1966 - Chronologie du dernier cycle Pluvial-Aride au Sahara nord-occidental. *Compte-rendu à l'Académie des Sciences*, Paris, **263**, 5-8.
- ANDRES W., 1977 - *Studien zur jungquartären Reliefentwicklung des südwestlichen Anti-Atlas und seines saharischen Vorlandes*. Mainzer Geogr. Stud. 9, 148 p.
- BEAUDET G., 1971 - Le Quaternaire marocain, état des études. *Revue de Géographie du Maroc*, Rabat, **20**, 3-57.
- BESANCON J., DELGIOVINE A., FONTUGNE M., LALOU C., SANLAVILLE P., & VAUDOUR J., 1997 - Mise en évidence et datation de phases humides du Pléistocène supérieur dans la région de Palmyre, Syrie. *Paléorient*, **23**, 1, 5-23.
- BIBERSON P., 1971 - Index-cards on the Marine and Continental cycles of the Moroccan Quaternary. *Quaternaria*, Roma, **XIII**, 1-76.
- BISCHOFF J.L., & FITZPATRICK X., 1991 - U-series dating of impure carbonates: an isochron technique using total-sample dissolution. *Geochimic Cosmochimic Acta*, **55**, 543-554.
- BOND G.C., BROECKER W., JOHNSEN S., MCMANUS J., LABEYRIE L., JOUZEL J., & BONANI G., 1993 - Correlations between climate records from North-Atlantic sediments and Greenland ice. *Nature*, **365**, 143-147.
- BOUDAD L., KABIRI L., WEISROCK A., WENGLER L., FONTUGNE M., EL MAATAOUI M., MAKAYSSI A., & VERNET J.-L., 2003 - Sédimentation fluviatile au Pléistocène supérieur et à l'Holocène dans la “Plaine” de Tazoughmit (Oued Rheris, piémont sud-atlasique de Goulmima, Maroc). *Quaternaire*, **14**, (3), 139-154.
- BRENNAN B.J., LYONS R.G., & PHILLIPS S.W., 1991 - Attenuation of alpha particle track dose for spherical grains. *Nuclear Tracks and Radiation Measurements* **18**, 249-253.
- CONRAD G., 1969 - *L'évolution continentale post-hercynienne du Sahara algérien (Saoura, Erg Chech, Tanezrouft, Ahnet, Mouydir)*. Publ. Centre de Rech. sur les Zones Arides, CNRS, Paris, série géologie, **10**, 527 p.
- CORTIJO E., 1998 - Les variations rapides du climat dans l'Océan Atlantique Nord au cours des 60 000 dernières années. *La Météorologie* **21**, 13-29.
- DELIBRIAS G., 1985 - Le Carbone 14, In Roth, E., Poty, B., Eds: *Méthodes de datation par les phénomènes nucléaires naturels: applications*, Collection CEA, Masson, Paris.
- GUERY P., 2000 - *Paléoenvironnements du Pléistocène supérieur dans l'Oued Noun, Sud marocain (la coupe de Fort Bou-Jerif)*. Univ. Nancy2, unpubl. mem., 85 p.
- KAUFMAN A., 1993 - An evaluation of several methods for determining ²³⁰Th/U ages in impure carbonates. *Geochim. Cosmochim. Acta* **57**, 2303-2317.
- KU T.L., 1976 - The uranium series method of age determination. *Ann. Review of Earth Planet Science* **4**, 347-379.
- KU T.L., LIANG Z.C., 1984 - The dating of impure carbonates with decay-series isotopes. *Nucl. Instr. Meth. in Phys. Res.*, **A 223**, 563-571.
- LITTMANN T., & SCHMITT K.-H., 1989 - The response of different relief units to climatic change in an arid environment (Southern Morocco). *Catena*, **16**, 343-355.
- MACKLIN M.G., FULLER I.C., LEWIN J., MAAS G.S., PASSMORE D.G., ROSE J., WOODWARD J.C., BLACK S., HAMLIN R.H.B., & ROWAN J.S., 2002 - Correlation of fluvial sequences in the Mediterranean basin over the last 200 ka and their relationship to climate change. *Quaternary Science Review*, **21**, 1633-1641.
- MATHIEU J., 2001 - *L'Oued Assaka, Sud marocain: géodynamique fluviale et cadre paléoenvironnemental (la coupe de la cote 65)*. Univ. Nancy2, unpubl. D.E.A., 144 p.
- MATHIEU J., to be published - *Morphodynamique fluviale et paléoenvironnements de l'Oued Noun, Maroc*. Thesis, Univ. Nancy 2.
- MATHIEU J., WEISROCK A., WENGLER L., BROCHIER J.-E., EVEN G., FONTUGNE M., MERCIER N., OUAMMOU A., SENEGAS F., VALLADAS H., VERNET J.-L., & WAHL L., 2004 - Holocene deposits in the lower section of the Assaka wadi, South Morocco: preliminary results. *Quaternaire*, **15**, (1-2), 207-218.
- MEJDAHL V., 1979 - Thermoluminescence dating: Beta dose-rate attenuation in quartz grains. *Archaeometry*, **21**, 61-72.
- MERCIER N., VALLADAS H., FROGET L., JORON J.-L., REYSS J.-L., BALESCU S., ESCUTENAIRE C., KOZLOWSKI J., SITLIVY V., SOBCZYK K., & ZIEBA A., 2003 - Luminescence dates for the palaeolithic site of Piekary Ila (Poland): comparison between TL of burnt flints and OSL of a loess-like deposit. *Quaternary Geochronology* **22**, 1245-1249.
- MURRAY A.S., & WINTLE A.G., 2000 - Luminescence dating of quartz using an improved single-aliquot regenerative-dose protocol. *Radiation Measurements*, **32**, 57-73.
- NANSON G.C., PRICE D.M., SHORT S.A., YOUNG R.W., & JONES B.G., 1991 - Comparative Uranium-Thorium and Thermoluminescence dating of weathered Quaternary alluvium in the Tropics of Northern Australia. *Quaternary Research*, **35**, 347-366.
- OLIVA P., 1975 - *Carte géomorphologique des plaines de l'Anti-Atlas occidental au 1/100 000ème. Plaine de Goulmine, feijas occidentales et massifs de bordure*. Royaume du Maroc, Ministère des Travaux Publics et Communications, Direction de l'Hydraulique, Rabat.
- OLIVA P., 1977 - La plate-forme moghrébienne: néotectonique et eustatisme sur le littoral de l'Anti-Atlas. *Méditerranée*, **2**, 73-91.
- OUAMMOU A., 1994 - *Le Bas-plateau de Tiznit*. Presses Univ. de Nancy, 149 p.
- PASSEGA R., 1964 - Grain-size representation by CM patterns as a geological tool. *J. Sedi. Petrol.*, **34**, 830-847.
- PASSEGA R., 1977 - Significance of CM diagrams of sediments deposited by suspensions. *Sedimentology*, **24**, 723-733.
- PASSEGA R., & BYRAMJEE R., 1969 - Grain-size image of clastic deposits. *Sedimentology*, **13**, 233-252.
- PETIT-MAIRE N., REYSS J.-L., & FABRE J., 1994 - Un paléolac du dernier interglaciaire dans une zone hyperaride du Sahara Malien (23°N). *Comptes Rendus à l'Académie des Sciences*, Paris, **319**, II, 805-809.

- PETIT-MAIRE N., ROSSO J.-C., DELIBRIAS G., MECO J., & POMEL S., 1987** - Paléoclimats de l'île de Fuerteventura (archipel canarien). *Palaeoecology of Africa*, **18**, 351-356.
- ROGNON P., 1987** - Late Quaternary climatic reconstruction for the Maghreb (North Africa). *Palaeogeography, Palaeoclimatology, Palaeoecology*, **58**, 11-34.
- ROGNON P., 1996** - Climatic change in the African deserts between 130 000 and 10 000 y BP. *Comptes-rendus à l'Académie des Sciences*, Paris, **323**, IIa, 549-561.
- ROGNON P., & COUDE-GAUSSEN G., 1987** - Reconstitution paléoclimatique à partir des sédiments du Pléistocène supérieur et de l'Holocène du nord de Fuerteventura (Canaries). *Zeitschrift für Geomorphologie*, **31**, 1, 1-19.
- ROGNON P., & COUDE-GAUSSEN G., 1996** - Changements dans les circulations atmosphérique et océanique à la latitude des Canaries et du Maroc entre les stades isotopiques 2 et 1. *Quaternaire*, **7**, 4, 197-206.
- SABELBERG U., 1978** - *Geomorphodynamik und Pedogenese im JungQuartär Südwestmarokkos. Geomorphologisch-stratigraphische Untersuchungen im Küstenbereich von Cap Rhir. Landschaftsgenese u. -Ökologie*, 1, Braunschweig, 172 p.
- THORP M., GLANVILLE P., STOKES S., & BAILEY R., 2002** - Preliminary optical and radiocarbon age determination for Upper Pleistocene alluvial sediments in the southern Anti Atlas Mountains, Morocco. *Comptes-rendus Géoscience*, **334**, 12, 903-908.
- VITA-FINZI C., & ROBERTS N., 1984** - Selective leaching of shells for ¹⁴C dating. *Radiocarbon*, **26**, 54-58.
- WEISROCK A., 1980** - *Géomorphologie et Paléoenvironnements de l'Atlas atlantique, Maroc*. Thesis, Univ. Paris 1, and *Notes et Mémoires du Service géologique du Maroc*, Rabat, **332**, 1993, 487 p.
- WEISROCK A., ADELE B., CHARIF A., & TANNOUCH-BENNANI S., 2002** - Dunes littorales et dunes continentales au Maroc atlantique semi-aride (29-30°N), du Pléistocène supérieur à l'Actuel. *Revista Cuaternario y Geomorfología*, Madrid, **16**, 1-4, 43-56.
- WEISROCK A., FONTUGNE M., & OUAMMOU A., 1994** - Le Soltanien supérieur de l'Oued Tamdroust (Province de Tiznit, Maroc). *Revue de Géographie du Maroc*, Rabat, **16**, 1-2, 351-372.
- WEISROCK A., & ROGNON P., 1977** - Evolution morphologique des basses vallées de l'Atlas atlantique marocain. *Géologie Méditerranéenne*, **IV**, 4, 313-334.
- WEISROCK A., OCCHIETTI S., HOANG C.-T., LAURIAT-RAGE A., BREBION P., & PICHET P., 1999** - Les séquences littorales pléistocènes de l'Atlas atlantique entre Cap Rhir et Agadir, Maroc. *Quaternaire*, **10**, 2-3, 227-244.
- WENGLER L., 1993** - *Cultures préhistoriques et formations quaternaires du Maroc oriental. Relations entre comportements et paléoenvironnements au Paléolithique moyen*. Thesis, Univ. Bordeaux III, 1433 p.
- WENGLER L., VERNET J.-L., BALLOUCHE A., DAMBLON F., & MICHEL P., 1992** - Signification des paléomilieus et évolution du climat au Maghreb. Le Maroc oriental au Pléistocène récent. In: J.-L. Vernet, *Les charbons de bois, les anciens écosystèmes et le rôle de l'homme*, coll. intern. Montpellier 1991, *Bull. Soc. Bot. France*, **139**, 507-529.
- WENGLER L., WEISROCK A., BROCHIER J.-E., BRUGAL J.-P., FONTUGNE M., MAGNIN F., MATHIEU J., MERCIER N., OUAMMOU A., REYSS J.-L., SENEGAS F., VALLADAS H., & WAHL L., 2002** - Enregistrement fluvial et paléoenvironnements au Pléistocène supérieur sur la bordure sud-ouest de l'Anti-Atlas. *Quaternaire*, **13**, (3-4), 179-192.
- WILLIAMS G.E., 1970** - Piedmont sedimentation and late Quaternary chronology in the Biskra region of the northern Sahara. *Zeitschrift für Geomorphologie*, Sup. band **10**, 40-63.

